

Catalog
LV 10

Edition
10/2023

SETRON • SIVACON • ALPHA

Low-Voltage Power Distribution and Electrical Installation Technology

Protection, Switching, Measuring and Monitoring
Devices, Switchboards and Distribution Systems

[siemens.com/lowvoltage](https://www.siemens.com/lowvoltage)

Innovative solutions for industrial controls and power distribution

Reliable components and systems are essential in ensuring smooth power distribution in buildings and industrial plants.

With SIRIUS, SENTRON, SIVACON and ALPHA, we offer an innovative portfolio for standard-compliant and demand-oriented applications.

Efficient engineering tools and innovative cloud-based solutions can be flexibly tailored to individual requirements.

We are there when you need us

Your personal contact can be found at
www.siemens.com/lowvoltage/contact

Catalog LV 10 · 10/2023

You will find the latest edition and all future editions in SiePortal at www.siemens.com/lowvoltage/catalogs

You can find the current prices in SiePortal at www.siemens.com/lowvoltage/product-catalog



The products and systems described in this catalog are manufactured/distributed under application of a certified quality management system in accordance with EN ISO 9001 (for the Certified Registration Nos., see www.siemens.com/system-certificates/ep). The certificate is recognized by all IQNet countries.

Technical specifications

The technical specifications are for general information purposes only. Always heed the operating instructions and notices on individual products during assembly, operation and maintenance.

All illustrations are not binding.

Low-Voltage Power Distribution and Electrical Installation Technology

	Introduction	I/2	I
Protecting	Air Circuit Breakers	1/1	1
	Molded Case Circuit Breakers	2/1	2
	Miniature Circuit Breakers	3/1	3
	Residual Current Protective Devices/Arc Fault Detection Devices (AFDDs)	4/1	4
	Switching Devices	5/1	5
	Overvoltage Protection Devices	6/1	6
	Fuse Systems	7/1	7
Protecting, Switching and Isolating	Switch Disconnectors	8/1	8
Switching and Isolating	Transfer Switching Equipment and Load Transfer Switches	9/1	9
Measuring and Monitoring	Measuring Devices, Power Monitoring and Digitalization Solutions	10/1	10
	Monitoring Devices	11/1	11
Distribution	Transformers, Power Supply Units and Socket Outlets	12/1	12
	Busbar Systems	13/1	13
	Terminal Blocks	14/1	14
	Switchboards, Distribution boards and Small distribution boards	15/1	15
	Busbar Trunking Systems	16/1	16
	System Cubicles, System Lighting and System Air-Conditioning	17/1	17
	Appendix	A/1	A

Sustainability@Siemens

Transforming the everyday to create a better tomorrow.



Decarbonization
Ethics
Governance
Resource Efficiency
Equity
Employability

Siemens as a company takes an all-round view of environmental, social and governance criteria (ESG) with its DEGREE rulebook (decarbonization, ethics, governance, resource efficiency, equity and employability). Not only are we committed to reducing the carbon footprint in our own plants to net zero by 2030, but also to helping our customers achieve their decarbonization and sustainability objectives.

Mission & strategy

As a focused technology company, Siemens is committed to tackling the world's most profound challenges by leveraging the synergies of digitalization and sustainability.

Technology with a purpose

We develop technologies that interconnect the real world and the digital world and enable our customers to make positive changes to their industries, which form the backbone of our economy: industry, infrastructure, transportation and healthcare.

Our contribution

Siemens makes a difference every single day by providing innovative solutions for challenges in environmental protection, decarbonization, health and safety. Innovative solutions that have a clear purpose: to make the world more sustainable, more integrative and a better place to live.

Facts about sustainability

For almost 175 years, Siemens has been driven by the desire to improve the lives of people around the world with our technologies.

Further information at:

www.siemens.com/sustainability

New products

SENTRON 3NP1 fuse switch disconnectors – New version of size NH000 in narrow design



- Significant space savings in the control cabinet due to reduced mounting width
- Cut-out in masking frame compatible with size NH00 (2 × NH000 in narrow design fit into the cut-out of an NH00)
- Versions for
 - Mounting on busbar systems with busbar spacing 60 mm
 - Floor mounting
 - Mounting on a DIN rail (with optional DIN rail assembly kit)

See chapter 8
Page 8/96

SENTRON PAC4220 – High-precision power monitoring device with color display



- New high-performance precision monitoring device
 - With high-resolution color display for clear operation and intuitive color-based display options
 - Acquisition and display of all electrical measured quantities with high precision
 - Color LED provided on the front for status display
 - 2 Ethernet ports for convenient daisy-chain wiring
- Tested according to IEC and UL
- Numerous communication options and functions possible through modular expansion
- Integrated web server with numerous display options
- Cybersecurity measures implemented as standard, including a crypto chip in preparation for future requirements

See chapter 10
Page 10/4

ALPHA 3200 Eco power distribution boards



- All modules of the power distribution board can be ordered directly via SiePortal
- First implementation of mechanical components in catalog LV 10
- 3D output from SIMARIS now also available as step file
- Further processing of the data in all common CAX programs possible

See chapter 15
Page 15/20

Miniature Circuit Breakers | Devices for all applications

System overview | Miniature Circuit Breakers

Devices for all applications

Miniature circuit breakers for basic applications



Ideal for standard applications
The S5L miniature circuit breakers are the new standard with B and C tripping characteristics for applications up to 63 A. They can be used as main control switches to disconnect or isolate equipment.

The S5L devices are mainly installed in meter panels and small distribution boards to protect circuits for lamps, cookers and warm machines, for example, in residential or commercial buildings.

Miniature circuit breakers for advanced applications



Ideal for industrial applications
For circuits with motors or large lamps, semiconductor or strong pulse-generating equipment such as transformer and solenoid valves – the S5Y and S5P devices are optimized for industrial applications and are proven in use.

The S5Y devices offer you top quality and functionality for installation in complex buildings and industry. With a rated breaking capacity of up to 25 kA, they are able to handle the most challenging requirements at a rated current of 0.5 to 80 A.

- Special features**
- Dual-chamber terminals
 - Simple to detach without tools using sliding catches
 - Separate switching position indicator
 - A wide range of accessories
 - S5L60 available as communication-capable miniature circuit breaker

Circuit breakers for equipment for advanced applications



Ideal for devices in industry
Circuit breakers for equipment from Siemens offer optimum protection for all applications in AC and DC control circuits in industrial applications and plant engineering.

Thermomagnetic S5Y17 circuit breakers for equipment are used to protect solenoid valves, sensor motors, signal lamps or even PLC inputs. Everywhere where loads have to be precisely protected from overloads and short-circuits.

Electronic S5K9 circuit breakers for equipment are optimally suited to protecting, for example, relay, programmable controllers, motors, sensors, actuators and valves. A current analysis in conjunction with fast tripping in the event of a fault avoid the danger of overloading the switched mode power supply.

S5L6 COM miniature circuit breakers and S5T3 COM auxiliary switches/fault signal contacts with communication and measuring functions

The new communication-capable protective device and auxiliary components record measured values and status information and transmit this data wirelessly to higher level systems.



- Recording of energy and active power, current, voltage, line frequency and temperature
- Measurement of residual currents in various frequency ranges
- Integrated status acquisition, operating hours counter and trip counter
- Higher system availability through early response to warning messages
- Convenient integration into new and existing systems thanks to compact mounting widths of 18 mm
- Fast parameterization and programming with the SENTRON Powercenter 1000
- Wireless transmission of measurement data from up to 25 communication-capable devices to the SENTRON Powercenter 1000 data transceiver

Siemens LV 10 - 10/2023

System overview

Basic units and accessories

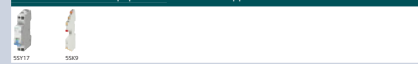
Miniature circuit breakers for basic applications



Miniature circuit breakers for advanced applications



Circuit breakers for equipment for advanced applications



Electrical accessories



Mechanical accessories



Busbars and accessories



Note: You will find a detailed range of accessories with the basic units and in the Accessories section.

Siemens LV 10 - 10/2023

System overview

An overview of the basic units and accessories can be found in the system overview at the beginning of the chapters or sections. The color helps you recognize the accessory at a glance.

Miniature Circuit Breakers | Quick selection guide

Quick selection guide | Miniature Circuit Breakers

Miniature circuit breakers

For advanced applications for buildings and infrastructure and for industry and mechanical engineering



	S5L6 COM	S5Y6	S5Y4	S5P4	S5P5	S5Y5	S5Y7	S5Y8	S5J4..HG..	
Standards	IECEN 60898-1 IECEN 60898-2 IECEN 60898-1 IECEN 60898-2 IECEN 60898-1 IECEN 60898-2 IECEN 60898-1 IECEN 60898-2 IECEN 60898-1 IECEN 60898-2									
Basic data	For AC (230/400 V) acc. to IECEN 60898-1 For AC (230/400 V) acc. to IECEN 60898-2 For AC (230/400 V) acc. to IECEN 60898-1 For AC (230/400 V) acc. to IECEN 60898-2 For AC (230/400 V) acc. to IECEN 60898-1 For AC (230/400 V) acc. to IECEN 60898-2 For AC (230/400 V) acc. to IECEN 60898-1 For AC (230/400 V) acc. to IECEN 60898-2 For AC (230/400 V) acc. to IECEN 60898-1 For AC (230/400 V) acc. to IECEN 60898-2									
Rated breaking capacity I_n	6 6 10 10 10 15 20 25 25	6 6 10 10 10 15 20 25 25	6 6 10 10 10 15 20 25 25	6 6 10 10 10 15 20 25 25	6 6 10 10 10 15 20 25 25	6 6 10 10 10 15 20 25 25	6 6 10 10 10 15 20 25 25	6 6 10 10 10 15 20 25 25	6 6 10 10 10 15 20 25 25	
Rated current I_n	0.5 - 2 A 0.5 - 2 A 0.5 - 2 A 0.5 - 2 A 0.5 - 2 A 0.5 - 2 A 0.5 - 2 A 0.5 - 2 A 0.5 - 2 A	0.5 - 2 A 0.5 - 2 A 0.5 - 2 A 0.5 - 2 A 0.5 - 2 A 0.5 - 2 A 0.5 - 2 A 0.5 - 2 A 0.5 - 2 A	0.5 - 2 A 0.5 - 2 A 0.5 - 2 A 0.5 - 2 A 0.5 - 2 A 0.5 - 2 A 0.5 - 2 A 0.5 - 2 A 0.5 - 2 A	0.5 - 2 A 0.5 - 2 A 0.5 - 2 A 0.5 - 2 A 0.5 - 2 A 0.5 - 2 A 0.5 - 2 A 0.5 - 2 A 0.5 - 2 A	0.5 - 2 A 0.5 - 2 A 0.5 - 2 A 0.5 - 2 A 0.5 - 2 A 0.5 - 2 A 0.5 - 2 A 0.5 - 2 A 0.5 - 2 A	0.5 - 2 A 0.5 - 2 A 0.5 - 2 A 0.5 - 2 A 0.5 - 2 A 0.5 - 2 A 0.5 - 2 A 0.5 - 2 A 0.5 - 2 A	0.5 - 2 A 0.5 - 2 A 0.5 - 2 A 0.5 - 2 A 0.5 - 2 A 0.5 - 2 A 0.5 - 2 A 0.5 - 2 A 0.5 - 2 A	0.5 - 2 A 0.5 - 2 A 0.5 - 2 A 0.5 - 2 A 0.5 - 2 A 0.5 - 2 A 0.5 - 2 A 0.5 - 2 A 0.5 - 2 A	0.5 - 2 A 0.5 - 2 A 0.5 - 2 A 0.5 - 2 A 0.5 - 2 A 0.5 - 2 A 0.5 - 2 A 0.5 - 2 A 0.5 - 2 A	0.5 - 2 A 0.5 - 2 A 0.5 - 2 A 0.5 - 2 A 0.5 - 2 A 0.5 - 2 A 0.5 - 2 A 0.5 - 2 A 0.5 - 2 A
Rated current I_n	2 - 32 2 - 32 2 - 32 2 - 32 2 - 32 2 - 32 2 - 32 2 - 32 2 - 32	2 - 32 2 - 32 2 - 32 2 - 32 2 - 32 2 - 32 2 - 32 2 - 32 2 - 32	2 - 32 2 - 32 2 - 32 2 - 32 2 - 32 2 - 32 2 - 32 2 - 32	2 - 32 2 - 32 2 - 32 2 - 32 2 - 32 2 - 32 2 - 32 2 - 32	2 - 32 2 - 32 2 - 32 2 - 32 2 - 32 2 - 32 2 - 32 2 - 32	2 - 32 2 - 32 2 - 32 2 - 32 2 - 32 2 - 32 2 - 32 2 - 32	2 - 32 2 - 32 2 - 32 2 - 32 2 - 32 2 - 32 2 - 32 2 - 32	2 - 32 2 - 32 2 - 32 2 - 32 2 - 32 2 - 32 2 - 32 2 - 32	2 - 32 2 - 32 2 - 32 2 - 32 2 - 32 2 - 32 2 - 32 2 - 32	2 - 32 2 - 32 2 - 32 2 - 32 2 - 32 2 - 32 2 - 32 2 - 32
Number of poles	1 1 1 1 1 1 1 1 1 1	1 1 1 1 1 1 1 1 1 1	1 1 1 1 1 1 1 1 1 1	1 1 1 1 1 1 1 1 1 1	1 1 1 1 1 1 1 1 1 1	1 1 1 1 1 1 1 1 1 1	1 1 1 1 1 1 1 1 1 1	1 1 1 1 1 1 1 1 1 1	1 1 1 1 1 1 1 1 1 1	
Tripping characteristic	B C SC SC SC SC SC SC SC SC	B C SC SC SC SC SC SC SC SC	B C SC SC SC SC SC SC SC SC	B C SC SC SC SC SC SC SC SC	B C SC SC SC SC SC SC SC SC	B C SC SC SC SC SC SC SC SC	B C SC SC SC SC SC SC SC SC	B C SC SC SC SC SC SC SC SC	B C SC SC SC SC SC SC SC SC	
Approach	1 1 1 1 1 1 1 1 1 1	1 1 1 1 1 1 1 1 1 1	1 1 1 1 1 1 1 1 1 1	1 1 1 1 1 1 1 1 1 1	1 1 1 1 1 1 1 1 1 1	1 1 1 1 1 1 1 1 1 1	1 1 1 1 1 1 1 1 1 1	1 1 1 1 1 1 1 1 1 1	1 1 1 1 1 1 1 1 1 1	
Mounting	1 1 1 1 1 1 1 1 1 1	1 1 1 1 1 1 1 1 1 1	1 1 1 1 1 1 1 1 1 1	1 1 1 1 1 1 1 1 1 1	1 1 1 1 1 1 1 1 1 1	1 1 1 1 1 1 1 1 1 1	1 1 1 1 1 1 1 1 1 1	1 1 1 1 1 1 1 1 1 1	1 1 1 1 1 1 1 1 1 1	
Voltage/temperature	230/400 230/400 230/400 230/400 230/400 230/400 230/400 230/400 230/400 230/400	230/400 230/400 230/400 230/400 230/400 230/400 230/400 230/400 230/400 230/400	230/400 230/400 230/400 230/400 230/400 230/400 230/400 230/400 230/400 230/400	230/400 230/400 230/400 230/400 230/400 230/400 230/400 230/400 230/400 230/400	230/400 230/400 230/400 230/400 230/400 230/400 230/400 230/400 230/400 230/400	230/400 230/400 230/400 230/400 230/400 230/400 230/400 230/400 230/400 230/400	230/400 230/400 230/400 230/400 230/400 230/400 230/400 230/400 230/400 230/400	230/400 230/400 230/400 230/400 230/400 230/400 230/400 230/400 230/400 230/400	230/400 230/400 230/400 230/400 230/400 230/400 230/400 230/400 230/400 230/400	
Rated voltage AC	230 230 230 230 230 230 230 230 230 230	230 230 230 230 230 230 230 230 230 230	230 230 230 230 230 230 230 230 230 230	230 230 230 230 230 230 230 230 230 230	230 230 230 230 230 230 230 230 230 230	230 230 230 230 230 230 230 230 230 230	230 230 230 230 230 230 230 230 230 230	230 230 230 230 230 230 230 230 230 230	230 230 230 230 230 230 230 230 230 230	
Max. operational voltage AC	230 230 230 230 230 230 230 230 230 230	230 230 230 230 230 230 230 230 230 230	230 230 230 230 230 230 230 230 230 230	230 230 230 230 230 230 230 230 230 230	230 230 230 230 230 230 230 230 230 230	230 230 230 230 230 230 230 230 230 230	230 230 230 230 230 230 230 230 230 230	230 230 230 230 230 230 230 230 230 230	230 230 230 230 230 230 230 230 230 230	
Rated voltage DC per phase pole	60 60 60 60 60 60 60 60 60 60	60 60 60 60 60 60 60 60 60 60	60 60 60 60 60 60 60 60 60 60	60 60 60 60 60 60 60 60 60 60	60 60 60 60 60 60 60 60 60 60	60 60 60 60 60 60 60 60 60 60	60 60 60 60 60 60 60 60 60 60	60 60 60 60 60 60 60 60 60 60	60 60 60 60 60 60 60 60 60 60	
Rated breaker voltage DC	60 60 60 60 60 60 60 60 60 60	60 60 60 60 60 60 60 60 60 60	60 60 60 60 60 60 60 60 60 60	60 60 60 60 60 60 60 60 60 60	60 60 60 60 60 60 60 60 60 60	60 60 60 60 60 60 60 60 60 60	60 60 60 60 60 60 60 60 60 60	60 60 60 60 60 60 60 60 60 60	60 60 60 60 60 60 60 60 60 60	
Dimensions	50x50 50x50 50x50 50x50 50x50 50x50 50x50 50x50 50x50 50x50	50x50 50x50 50x50 50x50 50x50 50x50 50x50 50x50 50x50 50x50	50x50 50x50 50x50 50x50 50x50 50x50 50x50 50x50 50x50 50x50	50x50 50x50 50x50 50x50 50x50 50x50 50x50 50x50 50x50 50x50	50x50 50x50 50x50 50x50 50x50 50x50 50x50 50x50 50x50 50x50	50x50 50x50 50x50 50x50 50x50 50x50 50x50 50x50 50x50 50x50	50x50 50x50 50x50 50x50 50x50 50x50 50x50 50x50 50x50 50x50	50x50 50x50 50x50 50x50 50x50 50x50 50x50 50x50 50x50 50x50	50x50 50x50 50x50 50x50 50x50 50x50 50x50 50x50 50x50 50x50	
Connection	1 1 1 1 1 1 1 1 1 1	1 1 1 1 1 1 1 1 1 1	1 1 1 1 1 1 1 1 1 1	1 1 1 1 1 1 1 1 1 1	1 1 1 1 1 1 1 1 1 1	1 1 1 1 1 1 1 1 1 1	1 1 1 1 1 1 1 1 1 1	1 1 1 1 1 1 1 1 1 1	1 1 1 1 1 1 1 1 1 1	
Construction features	1 1 1 1 1 1 1 1 1 1	1 1 1 1 1 1 1 1 1 1	1 1 1 1 1 1 1 1 1 1	1 1 1 1 1 1 1 1 1 1	1 1 1 1 1 1 1 1 1 1	1 1 1 1 1 1 1 1 1 1	1 1 1 1 1 1 1 1 1 1	1 1 1 1 1 1 1 1 1 1	1 1 1 1 1 1 1 1 1 1	
1 wire	1 1 1 1 1 1 1 1 1 1	1 1 1 1 1 1 1 1 1 1	1 1 1 1 1 1 1 1 1 1	1 1 1 1 1 1 1 1 1 1	1 1 1 1 1 1 1 1 1 1	1 1 1 1 1 1 1 1 1 1	1 1 1 1 1 1 1 1 1 1	1 1 1 1 1 1 1 1 1 1	1 1 1 1 1 1 1 1 1 1	
Fixed standard with and loose	1 1 1 1 1 1 1 1 1 1	1 1 1 1 1 1 1 1 1 1	1 1 1 1 1 1 1 1 1 1	1 1 1 1 1 1 1 1 1 1	1 1 1 1 1 1 1 1 1 1	1 1 1 1 1 1 1 1 1 1	1 1 1 1 1 1 1 1 1 1	1 1 1 1 1 1 1 1 1 1	1 1 1 1 1 1 1 1 1 1	
Terminal opening force	1 1 1 1 1 1 1 1 1 1	1 1 1 1 1 1 1 1 1 1	1 1 1 1 1 1 1 1 1 1	1 1 1 1 1 1 1 1 1 1	1 1 1 1 1 1 1 1 1 1	1 1 1 1 1 1 1 1 1 1	1 1 1 1 1 1 1 1 1 1	1 1 1 1 1 1 1 1 1 1	1 1 1 1 1 1 1 1 1 1	
Ambient conditions	1 1 1 1 1 1 1 1 1 1	1 1 1 1 1 1 1 1 1 1	1 1 1 1 1 1 1 1 1 1	1 1 1 1 1 1 1 1 1 1	1 1 1 1 1 1 1 1 1 1	1 1 1 1 1 1 1 1 1 1	1 1 1 1 1 1 1 1 1 1	1 1 1 1 1 1 1 1 1 1	1 1 1 1 1 1 1 1 1 1	
Storage temperature	1 1 1 1 1 1 1 1 1 1	1 1 1 1 1 1 1 1 1 1	1 1 1 1 1 1 1 1 1 1	1 1 1 1 1 1 1 1 1 1	1 1 1 1 1 1 1 1 1 1	1 1 1 1 1 1 1 1 1 1	1 1 1 1 1 1 1 1 1 1	1 1 1 1 1 1 1 1 1 1	1 1 1 1 1 1 1 1 1 1	
Storage humidity	1 1 1 1 1 1 1 1 1 1	1 1 1 1 1 1 1 1 1 1	1 1 1 1 1 1 1 1 1 1	1 1 1 1 1 1 1 1 1 1	1 1 1 1 1 1 1 1 1 1	1 1 1 1 1 1 1 1 1 1	1 1 1 1 1 1 1 1 1 1	1 1 1 1 1 1 1 1 1 1	1 1 1 1 1 1 1 1 1 1	
Storage time	1 1 1 1 1 1 1 1 1 1	1 1 1 1 1 1 1 1 1 1	1 1 1 1 1 1 1 1 1 1	1 1 1 1 1 1 1 1 1 1	1 1 1 1 1 1 1 1 1 1	1 1 1 1 1 1 1 1 1 1	1 1 1 1 1 1 1 1 1 1	1 1 1 1 1 1 1 1 1 1	1 1 1 1 1 1 1 1 1 1	
Resistance to vibration acc. to IEC 60068-2-6	1 1 1 1 1 1 1 1 1 1	1 1 1 1 1 1 1 1 1 1	1 1 1 1 1 1 1 1 1 1	1 1 1 1 1 1 1 1 1 1	1 1 1 1 1 1 1 1 1 1	1 1 1 1 1 1 1 1 1 1	1 1 1 1 1 1 1 1 1 1	1 1 1 1 1 1 1 1 1 1	1 1 1 1 1 1 1 1 1 1	
Resistance to shock and vibration acc. to IEC 60068-2-6	1 1 1 1 1 1 1 1 1 1	1 1 1 1 1 1 1 1 1 1	1 1 1 1 1 1 1 1 1 1	1 1 1 1 1 1 1 1 1 1	1 1 1 1 1 1 1 1 1 1	1 1 1 1 1 1 1 1 1 1	1 1 1 1 1 1 1 1 1 1	1 1 1 1 1 1 1 1 1 1	1 1 1 1 1 1 1 1 1 1	
Resistance to shock and vibration acc. to IEC 60068-2-6	1 1 1 1 1 1 1 1 1 1	1 1 1 1 1 1 1 1 1 1	1 1 1 1 1 1 1 1 1 1	1 1 1 1 1 1 1 1 1 1	1 1 1 1 1 1 1 1 1 1	1 1 1 1 1 1 1 1 1 1	1 1 1 1 1 1 1 1 1 1	1 1 1 1 1 1 1 1 1 1	1 1 1 1 1 1 1 1 1 1	
Resistance to shock and vibration acc. to IEC 60068-2-6	1 1 1 1 1 1 1 1 1 1	1 1 1 1 1 1 1 1 1 1	1 1 1 1 1 1 1 1 1 1	1 1 1 1 1 1 1 1 1 1	1 1 1 1 1 1 1 1 1 1	1 1 1 1 1 1 1 1 1 1	1 1 1 1 1 1 1 1 1 1	1 1 1 1 1 1 1 1 1 1	1 1 1 1 1 1 1 1 1 1	
Resistance to shock and vibration acc. to IEC 60068-2-6	1 1 1 1 1 1 1 1 1 1	1 1 1 1 1 1 1 1 1 1	1 1 1 1 1 1 1 1 1 1	1 1 1 1 1 1 1 1 1 1	1 1 1 1 1 1 1 1 1 1	1 1 1 1 1 1 1 1 1 1	1 1 1 1 1 1 1 1 1 1	1 1 1 1 1 1 1 1 1 1	1 1 1 1 1 1 1 1 1 1	
Resistance to shock and vibration acc. to IEC 60068-2-6	1 1 1 1 1 1 1 1 1 1	1 1 1 1 1 1 1 1 1 1	1 1 1 1 1 1 1 1 1 1							

Clickable article numbers

Direct forwarding to the individual products in SiePortal (Product Catalog) by clicking on the article number in the catalog

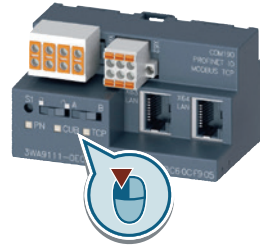
3VA9157-0EK11



or by entering this web address incl. article number
www.siemens.com/product_catalog_SIEP?Article.No.

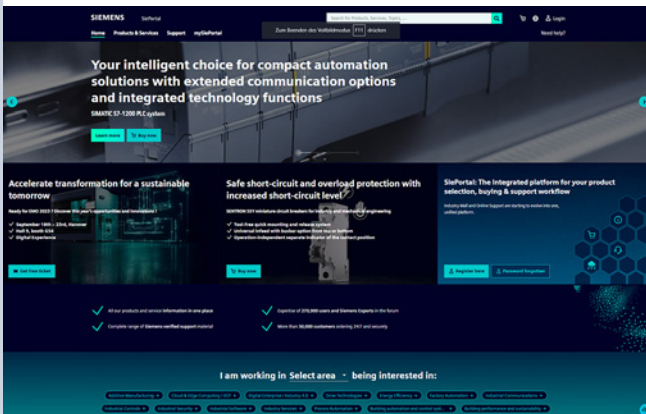
Clickable images

Direct forwarding to the individual motif types in the Industry image database by clicking on the images in the catalog



Industry image database:
www.siemens.com/lowvoltage/picturedb

SiePortal – The integrated platform for product selection, ordering and support



SiePortal:
www.siemens.com/sieportal

SiePortal – Knowledge base for low-voltage products

SiePortal > Support > Knowledge base

- Catalog/Brochure
- Manual
- Characteristic curves
- Certificates
- FAQ etc.

www.siemens.com/lowvoltage/product-support

SiePortal – Product catalog (Internet ordering platform) for low-voltage products

SiePortal > Products & Services

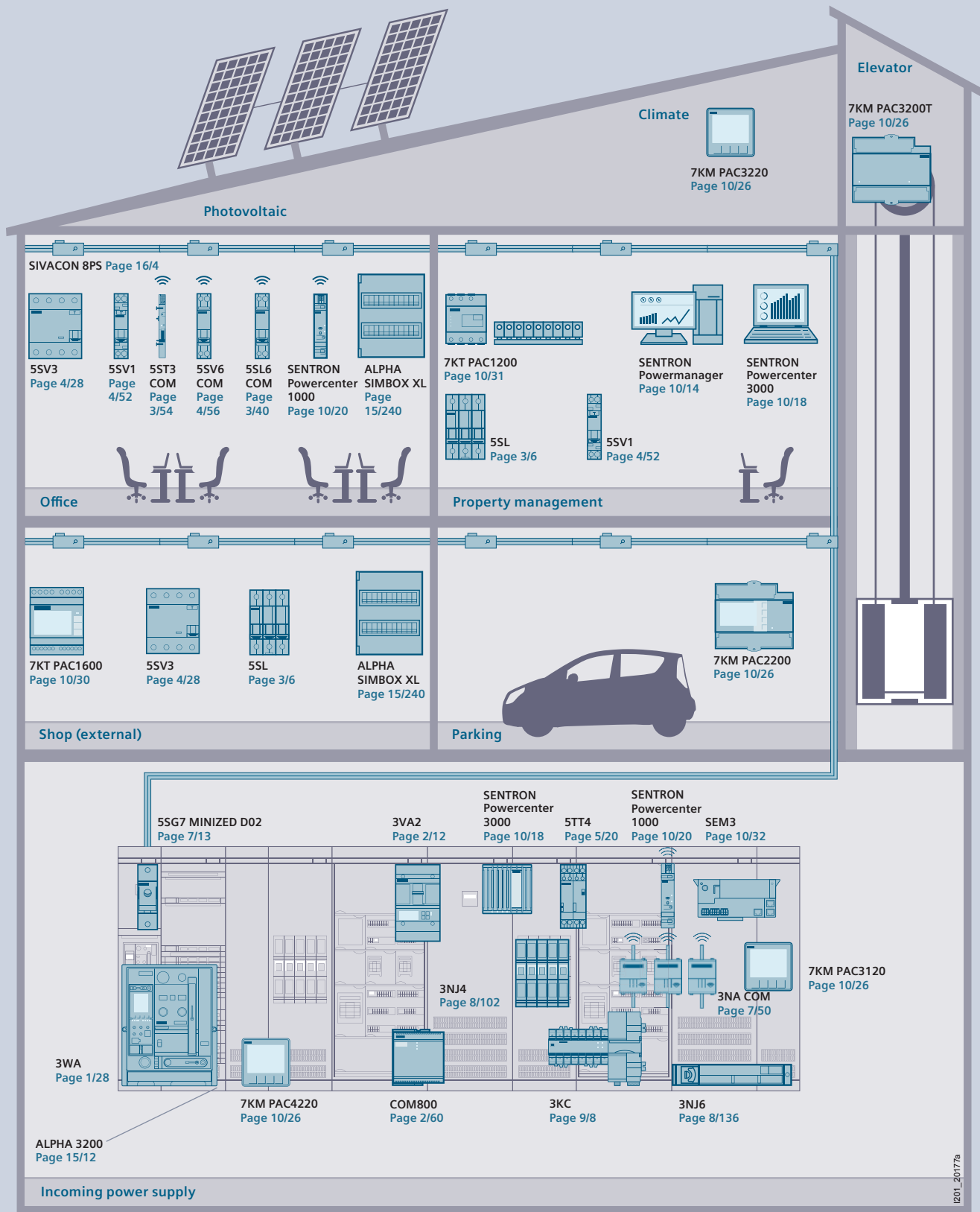
www.siemens.com/lowvoltage/product-catalog

new Search function

Search for new products by entering "new" in the text field of the search function

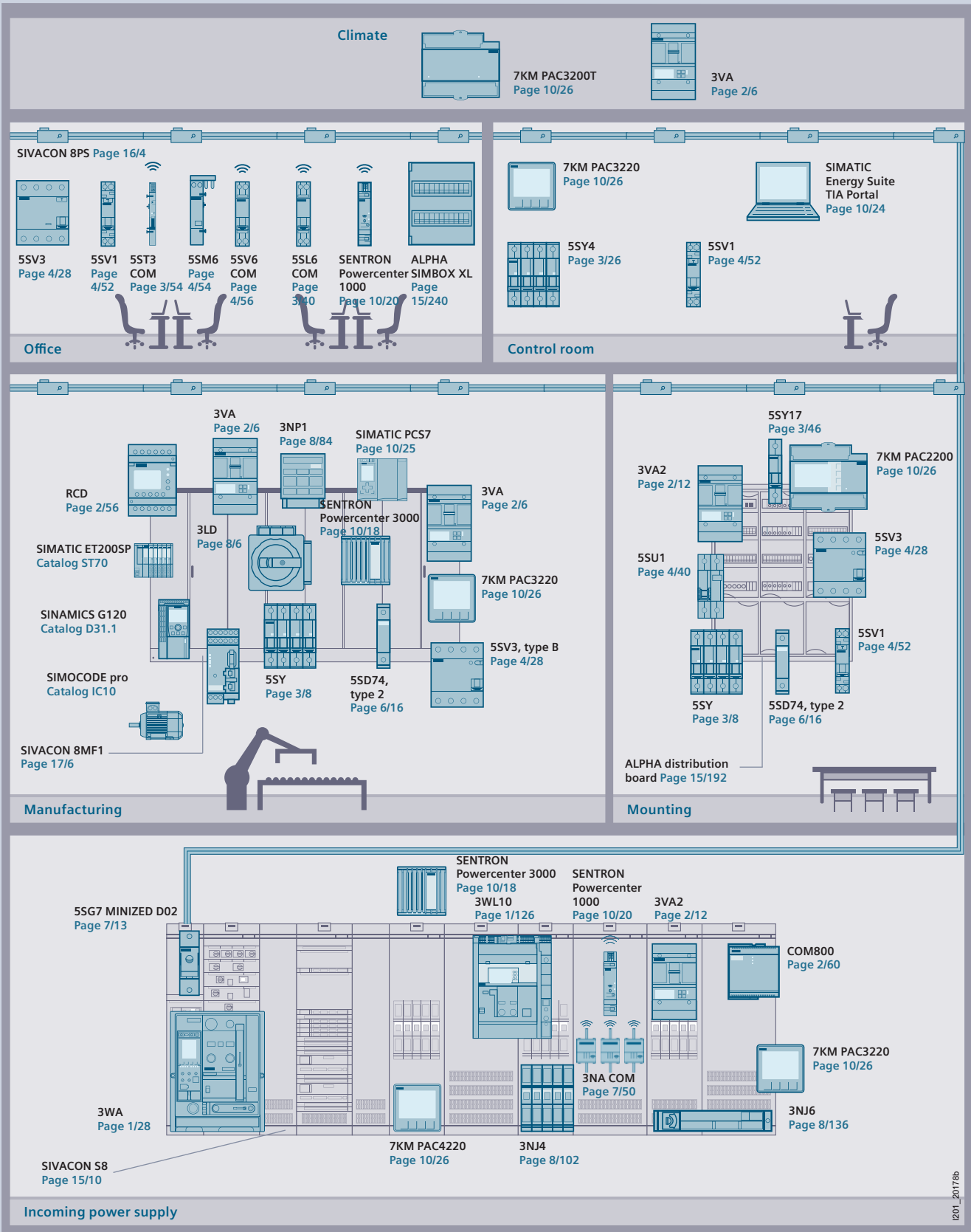


Products and their applications in infrastructure



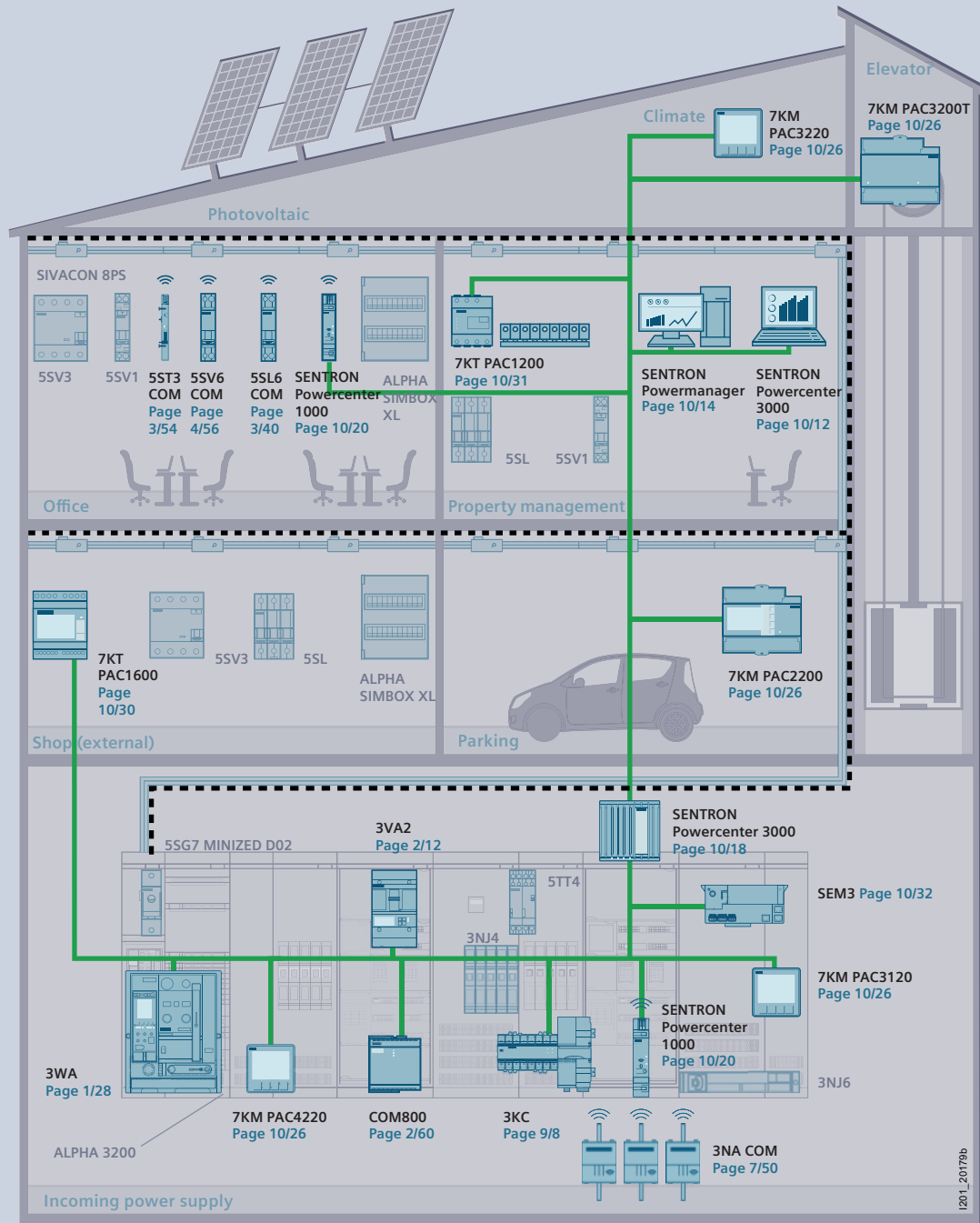
1201_20177a

Products and their applications in industry



1201_2017/8b

Examples of digitalization in infrastructure



Cloud-based analysis



Condition monitoring



Predictive maintenance



Power monitoring



On premises



Measuring, evaluating and controlling with SENTRON Powermanager / Desigo CC power monitoring software



Stand-alone

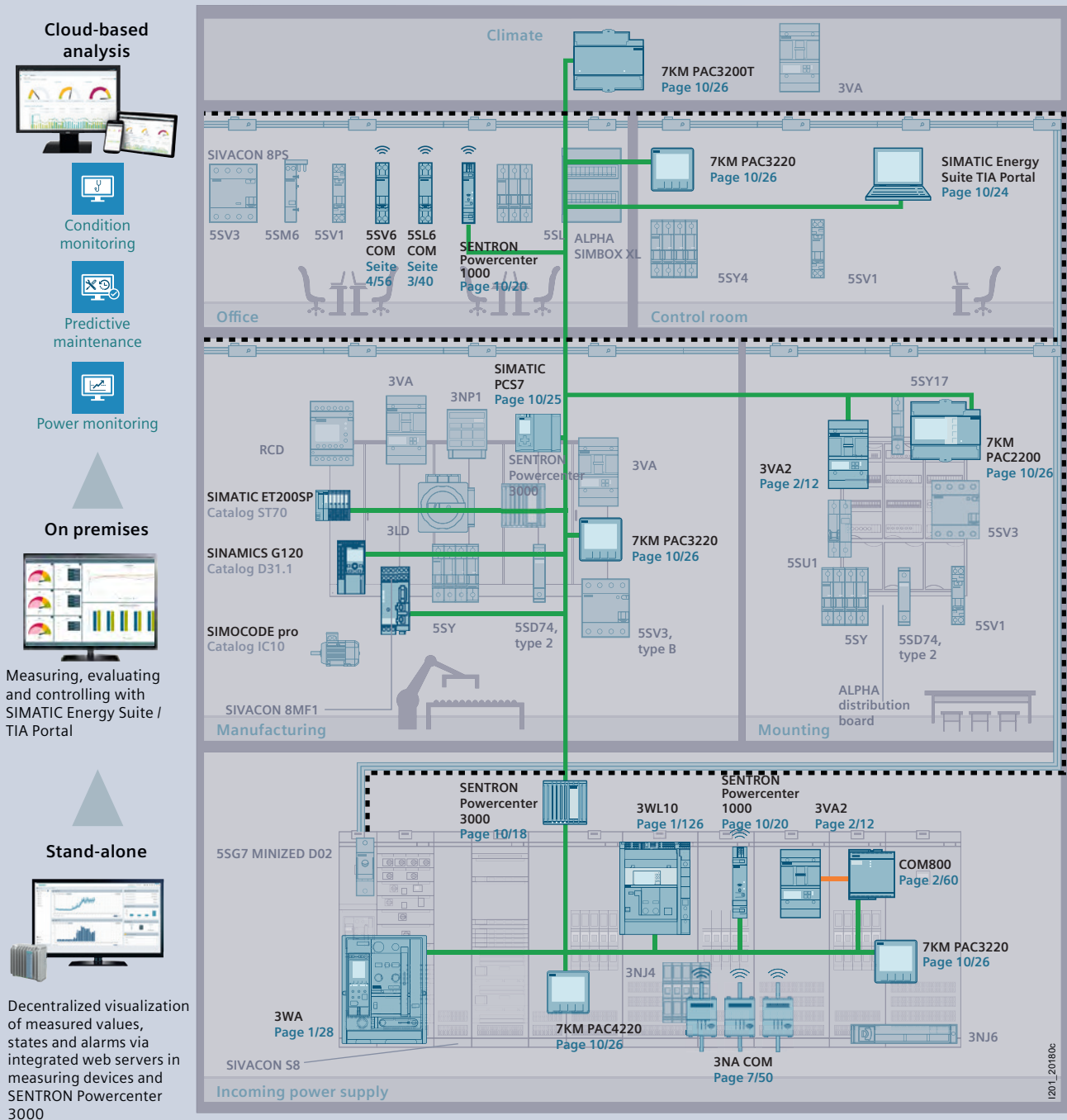


Decentralized visualization of measured values, states and alarms via integrated web servers in measuring devices and SENTRON Powercenter 3000

1201_201795b

— Industrial Ethernet
- - - powerline

Examples of digitalization in industry



Introduction to the topic of digitalization and Industry 4.0

In industrial automation, the demand for communication capability, data transparency and flexibility is growing constantly. To enable industrial switchgear technology to meet this demand, the use of bus systems and intelligent switching devices is unavoidable.

Digitalization

Protection, switching and measuring devices in power distribution systems can display important information on local visualization via integrated communication, e.g. in Powercenter, or transmit it to energy data management systems (EDMS), e.g. SENTRON Powermanager, as well as to cloud systems and applications.

- Diagnostics management
- Fault management – Email alarm
- Maintenance management – predictive maintenance
- Cost center management

1. Visualization and plant transparency



- Greater operational reliability thanks to remote access to the plant.
- Plant visualization for central and simple access to all device information.

2. Digital documentation



- Uniform access to digital data and documentation.
- Provision of extensive CAx data for systems and components during planning and operation.
- Support in planning and process creation using SIMARIS planning tools, product and system configurators.

3. Power monitoring



- Fulfilling the ISO 50001 by detecting and transparently presenting the energy flows within energy distribution.

4. Optimization and retrofit



- Retrofitting solutions such as SEM3 offer a simple option for integrating energy monitoring into existing systems.
- Energy monitoring and plant transparency help you efficiently plan plant expansion.

5. Maintenance management



- Maintenance support, even remotely, by transparently presenting the status of a switchgear and controlgear assembly.

6. Emergency management

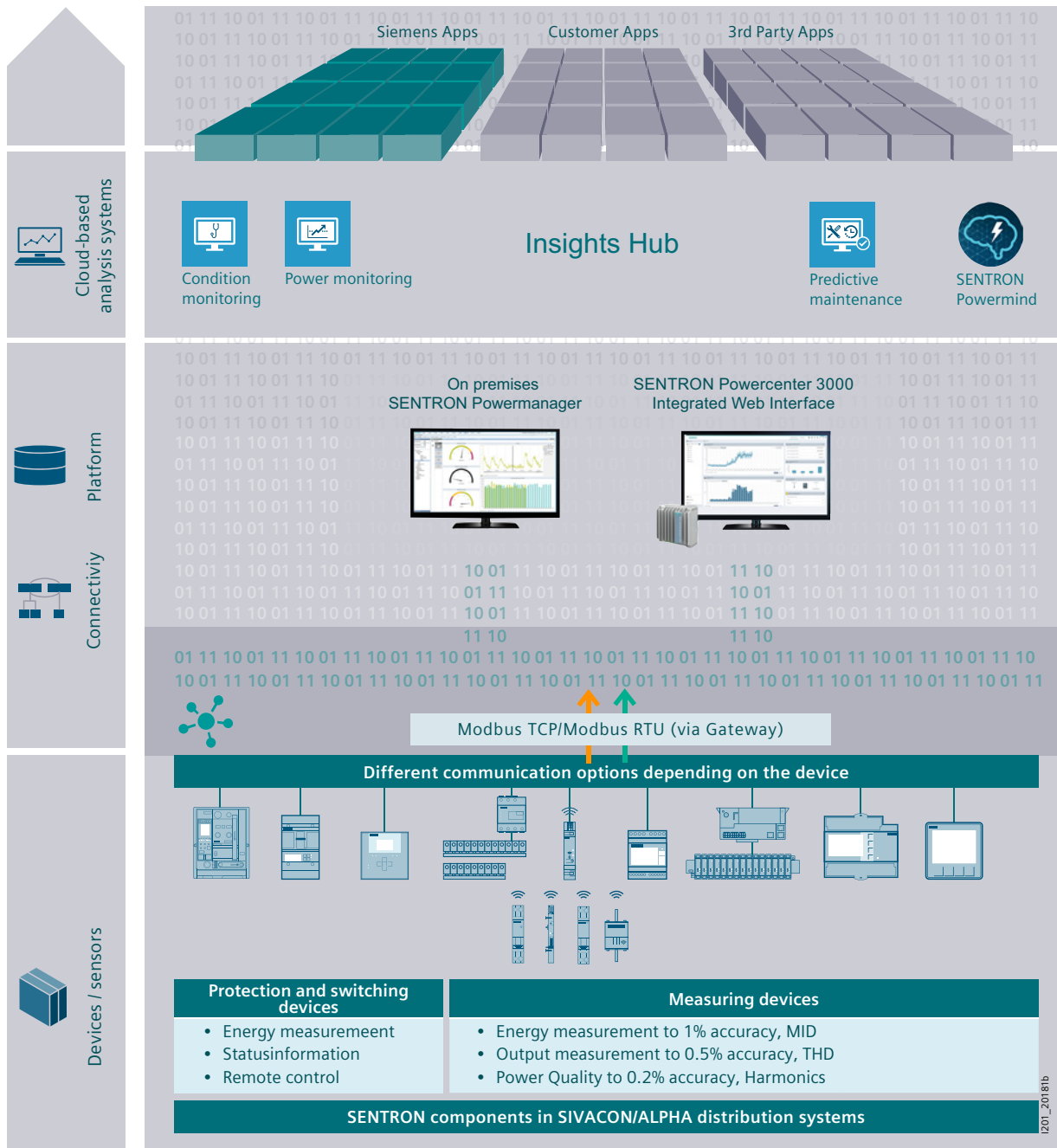


- Quick error localization which therefore leads to a minimization of outage times.

7. Cybersecurity



- Protection from unauthorized access and manipulation to switchgear and controlgear assemblies and devices ensures integrity, availability and confidentiality.



Overview of protection, switching, measuring and monitoring tasks

The functions presented here are available in combination or individually. Details can be found in the respective chapter.

				Line protection	Motor protection	Generator protection	Starter protection	Isolating function
Device class	Type	Rated current	Page					
Air circuit breakers	3WA/ 3WL	630 ... 6300 A	1/1	■	■	■		■
Molded case circuit breakers	3VA	16 ... 1600 A	2/6	■	■	■	■	■
Miniature circuit breakers (automatic circuit breakers)	5SY/ 5SL	0 ... 80 A	3/6					■
RCCB	5SV3/ 5SM3	16 ... 125 A	4/6	■				■
RCBOs	5SU1/ 5SV1	0 ... 40 A	4/10	■				■
AFD units	5SM6	0 ... 40 A	4/12					
AFDD/MCBs	5SV6	0 ... 40 A	4/12	■				■
On/Off switches	5TL1	32 ... 125 A	5/14					
Overvoltage protection devices	5SD7	–	6/1					■
Fuses NEOZED, DIAZED, Cylindrical fuses	5SE, 5SA, 5SB, 3NW6, 3NW8	–	7/30	■	■ ¹⁾		■	
Photovoltaic fuses	–	–	7/84	■				
LV HRC fuses	3NA/ 3ND	–	7/36	■	■		■	
SITOR semiconductor fuses	–	–	7/54	■		■	■	
Switch disconnectors	3LD	16 ... 250 A	8/12					■
	3KD	16 ... 1600 A	8/66					■
Fuse switch disconnectors	3NP	0 ... 630 A	8/84	With suitable fuse links			With suitable fuse links	■
Switch disconnector with fuse	3NJ	0 ... 630 A	8/102					■
	3KF	0 ... 630 A	8/120					■
Transfer switching equipment	3KC	16 ... 3200 A	9/4					■
PAC measuring devices	7KM/ 7KT	Any	10/26					
Motor starter protectors	3RV	–	Catalog IC 10		■			■
Contactors	3RT	–	Catalog IC 10					■

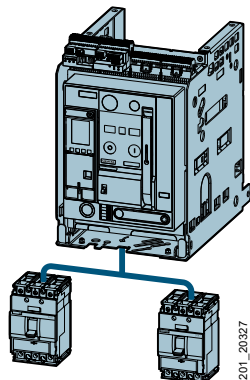
¹⁾ Only applies to 3NW8

²⁾ Only applies to the communication-capable COM products

Overload protection LT	Current limitation (Short-circuit)	Short-circuit protection, delayed ST	Short-circuit protection, instantaneous INST	Ground-fault protection GF	Measurement function	Personnel safety/fault current protection	Overvoltage protection	Preventive fire protection	Switching function
■		■	■	■	■			■	
■	■	■	■	■	■	■/■		■	
■	■		■		■ ²⁾				
						■/■			
■	■		■			■/■			
■	■		■		■ ²⁾			■	
							■		
■	■		■						
■	■		■		■ ²⁾				
■	■		■						
With suitable fuse links	With suitable fuse links		With suitable fuse links						
									■
					■				
■	■		■						

Overview of protection, switching, measuring and monitoring tasks

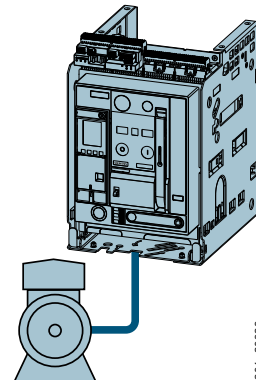
Line protection



The trip units for line protection are designed to provide overload and short-circuit protection for:

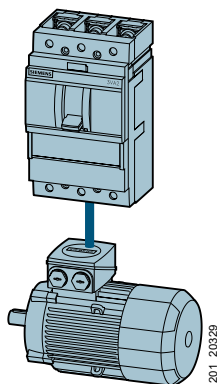
- Cables
- Leads
- Non-motor loads

Generator protection



The setting values of the trip units are matched to protecting generators.

Motor protection

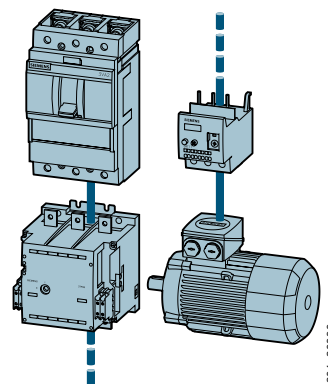


The overload and short-circuit releases are designed for optimal protection and direct starting of three-phase AC squirrel-cage motors.

The molded case circuit breakers for motor protection have phase-failure sensitivity and a thermal image that protects the motor against overheating.

The adjustable time lag class enables users to adjust the overload release to the startup conditions of the motor to be protected.

Starter protection



Starter combinations consist of:

Molded case circuit breaker + contactor + overload relay.

The molded case circuit breaker handles short-circuit protection and the isolating function. The task of the contactor is the operational switching of the feeder. The overload relay handles overload protection that can be specially matched to the motor.

The molded case circuit breaker for the starter combination is therefore equipped with an adjustable and instantaneous short-circuit release.

Isolating function

Switching devices are described that meet the requirements defined for the isolating function when in the open position.

- Load switches, disconnectors, switch disconnectors according to IEC 60947-3

Switching operational currents up to the maximum rated current of the switching devices is part of the tasks performed by these devices (See chapter 8).



- Non-automatic circuit breakers according to IEC 60947-2 Annex L

Non-automatic circuit breakers can disconnect operational currents up to the maximum rated current, including fault currents up to the specified I_{cc} value.



Current limitation (Short-circuit)

Current limitation means that the peak value of the prospective peak short-circuit current is limited to a smaller let-through current.

- Current-limiting devices include molded case circuit breakers (MCCBs), motor starter protectors (MSPs), miniature circuit breakers (MCBs) and fuses



- Air circuit breakers (ACBs) are non-current-limiting devices



Measurement function

There are two possibilities for selecting the measurement function in low-voltage power distribution (See chapter 10):

- Measuring devices (stand-alone) combined with protection and switching devices



- Protection and switching devices with integrated measurement function (all-in-one), measurement function equivalent to a measuring device



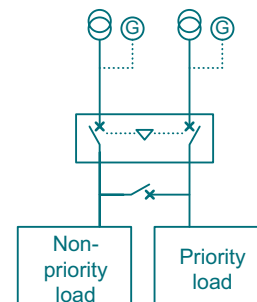
Transfer switching function

In the selection of transfer switch equipment, the following functions are distinguished (See chapter 9):

- Transfer control
- Load transfer

The following possibilities for transfer switching are available:

- MTSE = manual transfer switch equipment
- RTSE = remote transfer switch equipment
- ATSE = automatic transfer switch equipment



Tripping characteristics

The protective function of protection and switching devices in low-voltage power distribution systems is determined by the correct selection of the respective tripping characteristic (fuses, miniature circuit breakers) or TMTU/ETU trip units (air circuit breakers, molded case circuit breakers).

All current-limiting protection devices, such as MCCBs, MSPs, MCBs and fuses, can be described in terms of three characteristic curves:

- Tripping curve (time/current)
- Let-through current curve
- Let-through energy curve

In the following, the functions of the tripping curve are presented as an example.

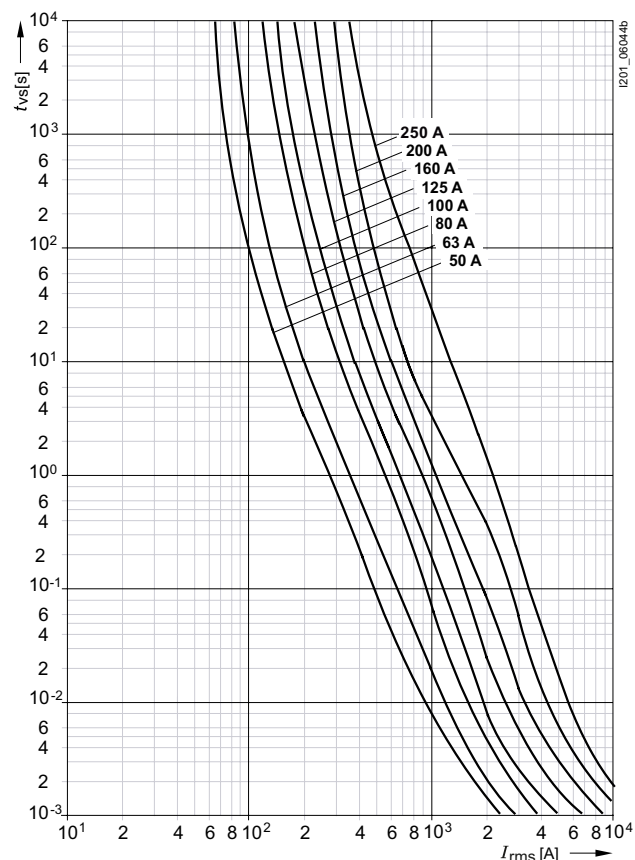
Fuses

The time-current characteristic curve of fuses denotes the melting time as a function of the overload or short-circuit current.

Different characteristics must be considered in dimensioning depending on the protection requirement and operational class (e.g. gG, gR, aR, etc.).

See Configuration Manual – Fuse systems

www.siemens.com/lowvoltage/manuals (45314810)

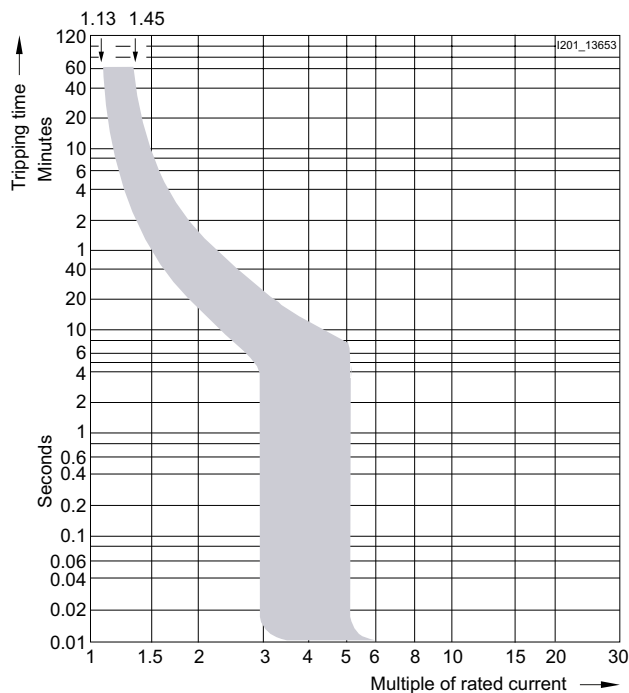


Miniature circuit breakers (MCBs)

The characteristic curve is chosen based on the application and is classified, for example, as tripping characteristic A, B, C or D.

Tripping curve = tripping characteristics according to IEC/EN 60898-1

See Configuration Manual – Miniature circuit breakers
www.siemens.com/lowvoltage/manuals (45302792)



Molded case circuit breakers (MCCBs)

The choice of electronic trip unit is based on the protective function required in power distribution.

The trip units are classified as:

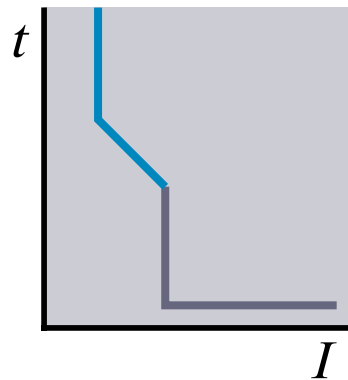
- thermal-magnetic trip units (TMTU; previously known as electromechanical trip units)
- electronic trip units (ETU).

Depending on the application and requirements, TMTUs are available with different protection setting options for both overload and short-circuit.

See Equipment Manual – 3VA molded case circuit breakers with IEC certificate

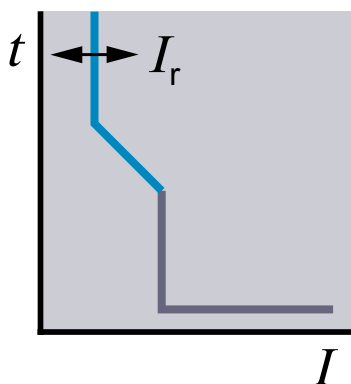
www.siemens.com/lowvoltage/manuals (90318775)

FTFM (Fixed Thermal Fixed Magnetic)



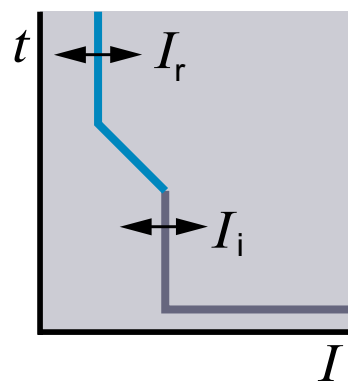
Permanently set thermal overload trip unit, permanently set magnetic trip unit with short-circuit protection

ATFM (Adjustable Thermal Fixed Magnetic)



Adjustable thermal overload trip unit, permanently set magnetic trip unit with short-circuit protection

ATAM (Adjustable Thermal Adjustable Magnetic)



Adjustable thermal overload trip unit, adjustable magnetic trip unit with short-circuit protection

Tripping characteristics

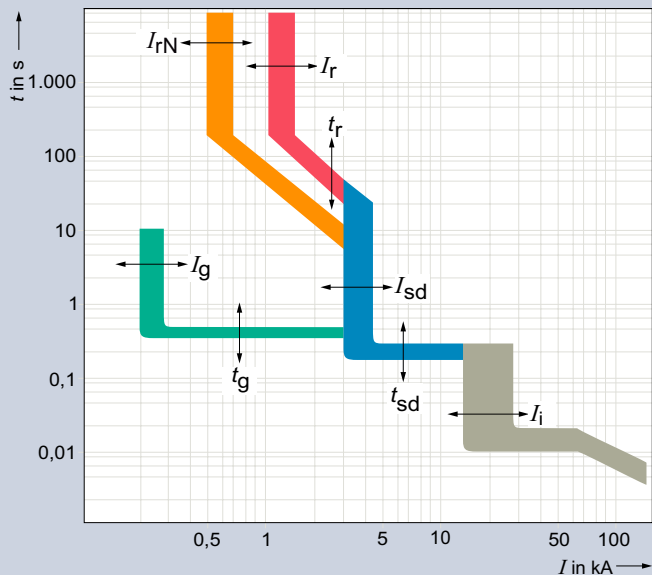
Molded case circuit breakers (MCCBs)/air circuit breakers (ACBs) with ETU

Selection of the electronic trip unit determines the protective function in power distribution.

Electronic trip units offer the most extensive and variable protection settings of all protection and switching devices for low-voltage power distribution.

- See Equipment Manual – 3VA molded case circuit breakers with IEC certificate www.siemens.com/lowvoltage/manuals (90318775)
- See Equipment Manual – 3WA1 air circuit breakers www.siemens.com/lowvoltage/manuals (109763061)

The graphs below show an overview of the time-current characteristic curve.



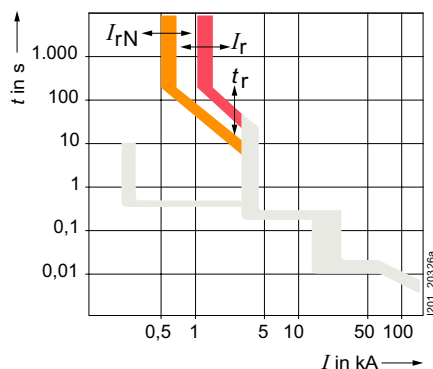
- LT** Overload protection LT
- N** Neutral conductor overload protection N
- ST** Short-circuit protection, delayed ST
- INST** Short-circuit protection, instantaneous INST
- GF** Ground-fault protection GF

Overload protection LT

The ID letter for overload protection is LT (stands for "Long-time delay"). The trip unit is inverse-time delayed and exhibits the following characteristics depending on the trip unit type:

- Bimetal characteristic with thermal-magnetic trip units
- I^2t characteristics for molded case circuit breakers MCCBs and I^2t and I^4t characteristics for ACBs
- Depending on the electronic trip units, only I^2t characteristic or I^2t and I^4t characteristic

The letters I_r refer to the current setting value; the associated tripping time is identical to t_r .



Neutral conductor overload protection N

The ID letter for neutral conductor protection is N. The letters I_N refer to the current setting value for the overload protection; the associated tripping time is identical to t_r .

The short-circuit protection of the circuit breaker also protects the neutral conductor.

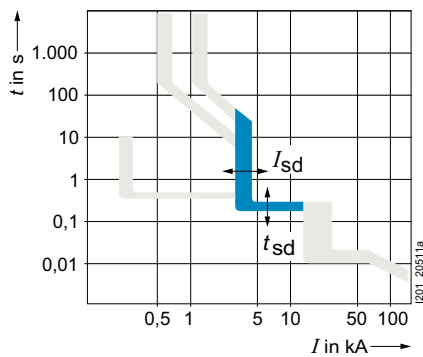
Possible reasons for implementing overload protection in the neutral conductor include:

- The neutral conductor has a smaller cross-section than the phase conductors.
- Higher harmonic components in the system can be expected.
- A large number of loads, or predominantly 1-phase loads, are connected.

Short-circuit protection, delayed ST

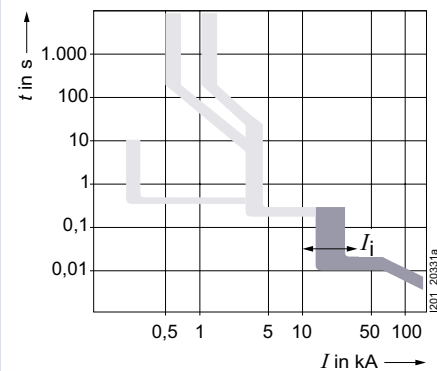
The ID letter for short-time delayed short-circuit protection is ST (stands for "Short-time"). The ST function of the electronic trip unit can be used to implement time-selective short-circuit tripping in low-voltage networks in which multiple circuit breakers are installed in series.

The short-time delayed short-circuit protection function protects phases L1 to L3 and the neutral conductor. The protective function responds if the current in at least one phase exceeds the set tripping current I_{sd} for the set delay period t_{sd} .



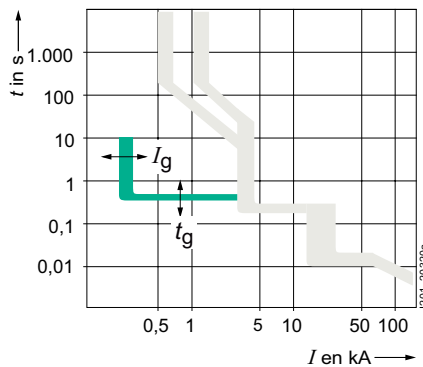
Short-circuit protection, instantaneous INST

The ID letter for instantaneous short-circuit protection is INST (stands for "Instantaneous"). This short-circuit protection function protects phases L1 to L3. The instantaneous short-circuit protection function responds if the instantaneous value equal to the rms of the current in at least one phase exceeds the instantaneous tripping current I_i .



Ground-fault protection GF

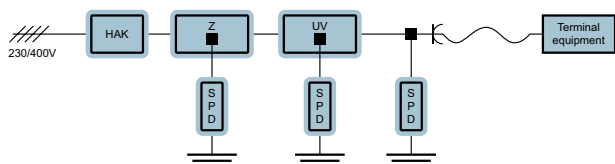
The ID letter for ground-fault protection is GF (ground fault). The G release measures fault currents between phases and grounded, electrically conductive parts. Ground-fault protection protects against the flow of current to ground in the rated current range. As ground-fault currents can produce arcing, ground-fault protection consequently offers extended fire protection.



Overview of protection, switching, measuring and monitoring tasks

Overvoltage protection

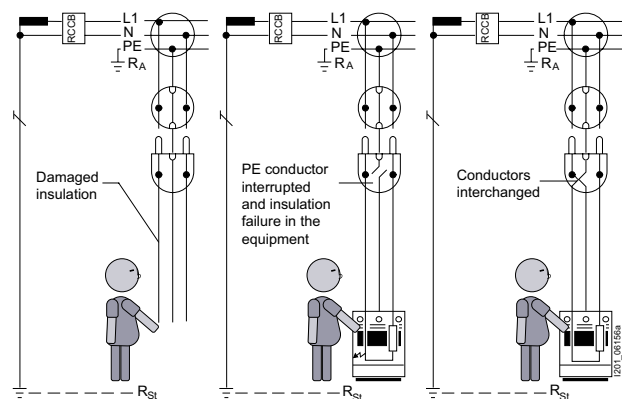
Overvoltage protection refers to the protection of electrical and electronic devices against excessively high electrical voltages. Overvoltage can be caused by switching operations or electrostatic discharging (ESD).



Personnel safety/fault current protection

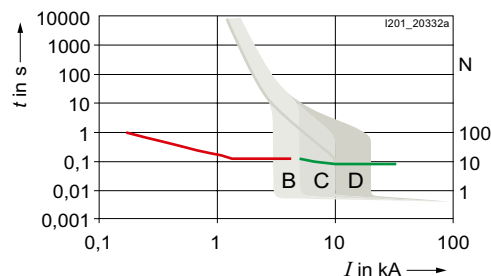
Protection in the event of direct contact:
Additional protection contact refers to direct contact with a part that is live under operating conditions.

Protection against indirect contact:
Fault protection refers to contact with an electrically conductive part which is not live under operating conditions.



Preventive fire protection

Arc fault detection devices evaluate occurring faults in the current and voltage wave using an electronic switch and shutting off the current when it recognizes a contact fault. This prevents overheating at poor contact points which can prevent fires.

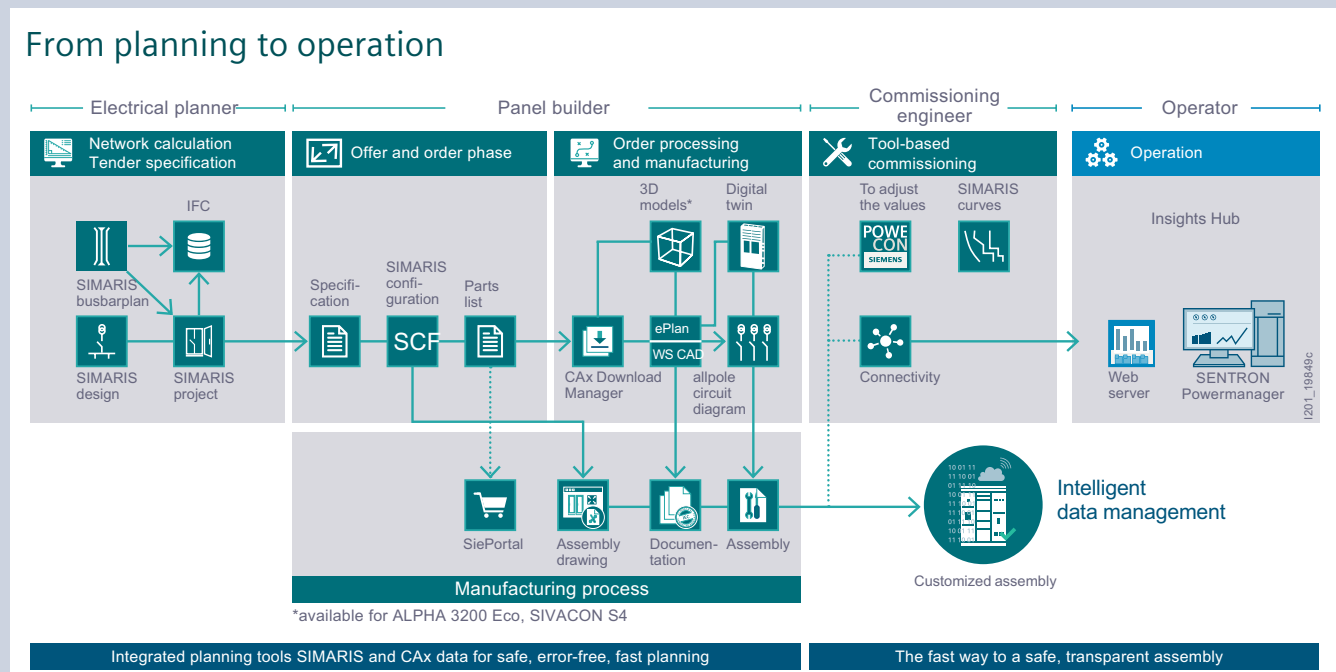


Potential failure causes

- Damaged cable insulation, e.g. by nails, screws or brackets
- The risk of a cable break exists for cables with a too-tight bending radius
- Cables which are laid through open doors and windows can be crushed when doors or windows are closed resulting in damaged insulation and arcing faults
- Environmental influences such as UV rays, temperature, humidity, gases can damage or age the insulation
- Damage caused by rodents
- Loose contact, e.g. caused by too low torque
- Conductor damaged by claw fixing

SIMARIS planning tools

For planning and visualizing the power distribution system



Highlights

- Thorough support of the engineering process with interlinked software tools
- Provision of extensive CAX data for systems and components
- Reduction of cost and time aspects during planning

Distribution systems

For industrial plants or in infrastructure

SIVACON S8 power distribution boards and motor control centers

- Reliable, economical, flexible and communication-capable
- For all applications in infrastructure and process industry



Overview, see page 15/6

SIVACON 8PS busbar trunking systems

- For economic and reliable power supply
- Space-saving and simple to install
- Low fire load, good electromagnetic compatibility



Overview, see page 16/4

ALPHA 3200 power distribution boards (DIN technology)

- Safe investment, enhances productivity and performance
- Optimized for applications in modern building infrastructures
- Integrated system for all SENTRON components



Overview, see page 15/6

ALPHA 3200 Eco power distribution boards (DIN technology)

- **Saves resources:** lower use of copper with centrally positioned busbar
- **Practical:** optimized performance – from the transformer connection via the busbar to the outgoing feeders
- **Modular:** a high packing density in a compact space due to flexible use of ALPHA assembly kits
- **Innovative:** 3D processor generates a digital twin of the configured system at the press of a button



Overview, see page 15/6

ALPHA distribution boards (DIN technology)

- Comprehensive portfolio with wall-mounted and floor-mounted distribution boards for currents between 160 A to 1250 A



Overview, see page 15/7

SIVACON S4 power distribution boards (NF technology)

- Consistent portfolio for applications from 800 A to 6300 A
- High flexibility in system planning thanks to a modular platform structure
- Simple reproduction of type-tested solutions using software-assisted configuration in SIMARIS configuration and SIMARIS project
- Increased planning reliability due to the provision of 3D data
- Safe to use thanks to independent VDE approval



Overview, see page 15/4

ALPHA UNIVERSAL distribution boards (NF technology)

- Comprehensive portfolio with wall-mounted and floor-mounted distribution boards for currents between 125 A to 800 A
- Simple planning thanks to the modular platform structure



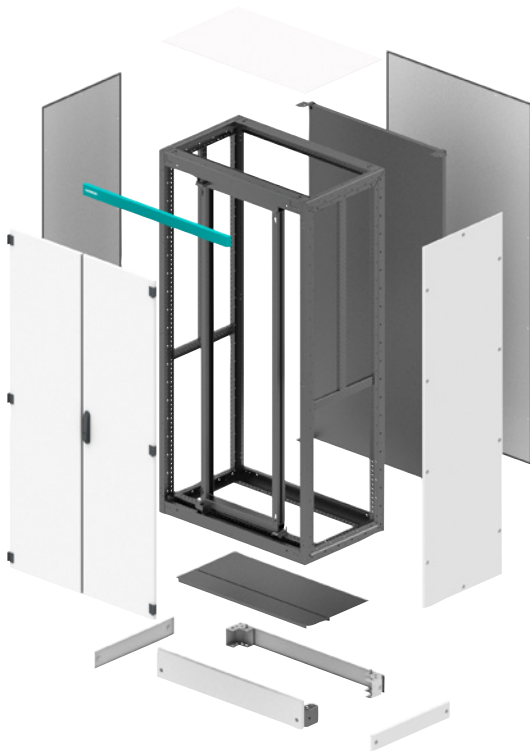
Overview, see page 15/4

Control cabinets/System cubicles

For plant engineering, process control, network technology,
secondary systems/energy automation

SIVACON 8MF1 system cubicles

- Modular system
- Fully assembled, adapted according to your specifications, or entirely customized



Overview, see page 17/6

SIVACON 8MF/8MR system lighting – LED lights

The LED lights offer optimum lighting conditions for installation and maintenance. The LED technology is energy-efficient and maintenance-free.



Overview, see page 17/32

SIVACON 8MF/8MR system lighting – Slimline lights

The Slimline lights are an alternative with energy-saving lamps and are available as a version with an integrated socket.



Overview, see page 17/33

SIVACON 8MR system air-conditioning

Ensures fault-free operation of the electrical and electronic built-in units installed in the cubicle, even under the harshest ambient conditions.



Overview, see page 17/38



Made for makers. Simply reliable.

All power distribution systems rely on a secure infeed of electrical energy. The 3WA air circuit breaker combines all of the functions which are required of power distribution equipment in the digital companies of today: from reliably protecting people and equipment from electrical accidents and damage, to flexible application and retrofit options, a long service life and low maintenance, to innovative features for integrated e-engineering, reliable energy data recording and seamless integration into digital environments. As the central component of the electrical power distribution, the 3WA air circuit breaker provides the basis for a holistic energy system in the digital age. The 3WA air circuit breaker is also part of the Siemens Xcelerator portfolio and therefore provides support with achieving digital and sustainable transformation – faster, simpler, and scalable.



Reliable, versatile and perfectly integrated

The 3WL air circuit breakers reliably protect electrical equipment from damage or fire resulting from short circuit, ground fault or overload failures.

Air Circuit Breakers



All the information you need	1/2
3WA1 quick selection guide	1/4
3WA1 circuit breakers and non-automatic circuit breakers for AC and DC	1/4
3WA1 circuit breakers and non-automatic circuit breakers for AC	1/8
3WA1 non-automatic circuit breakers for DC	1/14
Electronic trip unit	1/18
ETU300 electronic trip unit	1/19
ETU600 electronic trip unit	1/20
Connection	1/26
Communication	1/27
3WA11 – 3WA13	1/28
System overview	1/28
Online configurator highlights	1/30
Structure of the article numbers	1/32
Accessory options	1/46
Summary of power consumption data	1/55
Guide frames for AC	1/56
Guide frames for DC	1/58
Accessories and spare parts	1/60
3WL1 quick selection guide	1/74
3WL1 circuit breakers and non-automatic circuit breakers for AC and DC	1/74
3WL1 circuit breakers and non-automatic circuit breakers for AC	1/76
3WL1 non-automatic circuit breakers for DC	1/80
ETU electronic trip units	1/84
Connection	1/88
Operating mechanism, auxiliary release, auxiliary switch	1/89
3WL11 – 3WL13	1/90
Online configurator highlights	1/90
Structure of the article numbers	1/92
Accessory options	1/96
Guide frames for AC	1/108
Guide frames for DC	1/109
Accessories and spare parts	1/110
3WL10	1/126
Online configurator highlights	1/126
Structure of the article numbers	1/128
Accessory options	1/130
Guide frames	1/132
ETU electronic trip units and accessories	1/133
Accessories and spare parts	1/136

A multitude of additional information ...

Information + ordering

All the important things at a glance

For information about air circuit breakers, please visit our website www.siemens.com/3WA

Your product in detail

The SiePortal platform (knowledge base) provides comprehensive information
www.siemens.com/lowvoltage/product-support

- Quick Selection Guide
 - 3WA air circuit breakers (109781967)
 - 3WL air circuit breakers (109751638)
- Brochure
 - 3WA air circuit breakers (109800077)

The relevant tender specifications can be found at www.siemens.com/tenderspecifications

Use our conversion tool for quick and easy conversion to Siemens products www.siemens.com/conversion-tool

Siemens YouTube channel

- 3WA air circuit breaker – Teaserfilm sie.ag/2Myvit
- 3WA air circuit breaker – Highlightfilm sie.ag/3dy65A

Everything you need for your order

Refer to SiePortal to find an overview of your products (product catalog)

- Air circuit breakers sie.ag/2IXiZjB

Direct forwarding to the individual products in SiePortal by clicking on the article number in the catalog or entering this web address incl. article number
www.siemens.com/product_catalog_SIEP?Article.No.

Order supports can be found in SiePortal at www.siemens.com/lowvoltage/product-support

- Order Support
 - 3WA air circuit breakers – Made for makers. Simply reliable. (109800074)

Configurators

The configurator reduces the time and effort required in the planning and ordering process, and allows for individual adaptations. Configure your air circuit breaker at www.siemens.com/lowvoltage/3wa-configurator
www.siemens.com/lowvoltage/3wl-configurator
www.siemens.com/lowvoltage/3wl10-configurator

The following are additionally available for your configured air circuit breaker:

- 3D views
- CAD data
- Unit wiring diagrams
- Dimension drawings

The fast track to the experts

Contact persons in your region

We offer a comprehensive portfolio of services. You can find your local contacts at www.siemens.com/lowvoltage/components/contact

You will find further information on services at www.siemens.com/service-offers

Competent expert advice on technical questions with a wide range of demand-optimized services for all our products and systems.

Assistance with technical queries is provided at www.siemens.com/support-request

... can be found in our online services

Commissioning + operation

SENTRON Powerconfig

The combined commissioning and service tool SENTRON Powerconfig for communication-capable measuring devices, circuit protection devices and circuit breakers.

Free download SENTRON Powerconfig
www.siemens.com/powerconfig

Free download SENTRON Powerconfig mobile via [App Store](#) and [Play Store](#)

Your product in detail

The SiePortal platform (knowledge base) provides detailed technical information
www.siemens.com/lowvoltage/product-support

- Operating instructions
- Characteristic curves
- Certificates

Online Support app available for download from the [App Store](#) and [Play Store](#)

You will find further information at
www.siemens.com/support-app

Provision of 3D data (step and u3d data formats)

- SiePortal (product catalog)
www.siemens.com/lowvoltage/product-catalog
- Image database
www.siemens.com/lowvoltage/picturedb

Engineering data for CAD or CAE systems are available in the Cax Download Manager at
www.siemens.com/cax

Manuals

Manuals can be found in SiePortal at
www.siemens.com/lowvoltage/manuals

- Equipment Manual
 - 3WA1 air circuit breakers (**109763061**)
 - 3VA27 molded case circuit breakers & 3WL10 air circuit breakers (**109753821**)
- System Manual
 - 3WA air circuit breaker communication (**109792368**)
 - 3WL/3VL circuit breakers with communications capability – Modbus (**39850157**)
 - 3WL/3VL PROFIBUS circuit breakers with communications capability – PROFIBUS (**12560390**)
- Configuration Manual
 - 3WL1 air circuit breakers (**35681108**)
 - Low-voltage protection devices selectivity tables (**109748621**)
- Communication Manual
 - 3WL air circuit breakers via COM35 – PROFINET IO, Modbus TCP (**109757987**)
 - 3WL10 air circuit breakers & 3VA27 molded case circuit breakers (**109760220**)

Face-to-face or online training

Our training courses can be found at
www.siemens.com/sitrain-lowvoltage

- 3WA air circuit breakers (WT-LV3WA)
- 3WL10 air circuit breaker, size 0 (WT-LVA3WLO)
- 3WL air circuit breakers, sizes 1-3 (WT-LVA3WL)
- Protection systems in low-voltage power distribution (WT-LVAPS)
- Maintenance and operation of 3WA circuit breakers (LV-3WAMAIN)
- Maintenance and operation of 3WL circuit breakers (LV-3WLMMAIN)
- Certification: Maintenance and operation of 3WL and 3WA circuit breakers (LV-CBCERT)
- 3WL and 3WA air circuit breakers protection technology and communication (LV-COPR)

Video tutorial on the 3WL air circuit breaker
www.lowvoltage.siemens.com/wcms/3wl-tutorial

Technical overview – Air circuit breakers



The fast way to get you to our online services

This page provides you with comprehensive information and links on air circuit breakers
www.siemens.com/lowvoltage/product-support (**109781188**)

3WA1 circuit breakers and non-automatic circuit breakers for AC and DC

IEC 60947-2

1

AC



3WA11

3WA12

Basic data

Rated operational voltage U_e	V	≤ 1000		≤ 1150	
Rated current I_n	A	630 ... 2500		2000 ... 4000	
Size		1		2	
Type of mounting		Withdrawable	Fixed-mounted	Withdrawable	Fixed-mounted
Number of poles		3/4-pole	3/4-pole	3/4-pole	3/4-pole

Dimensions

Width (3-pole 4-pole)	mm	320 410	320 410	460 590	460 590
Height (for breaking capacity N, S, M, H and D C and E)	mm	466 516	437 462	466 516	437 462
Depth	mm	471	357	471	357

Approvals

General product approvals	VDE, EAC, CCC, CE, C-Tick	VDE, EAC, CCC, CE, C-Tick
Marine/shipbuilding	ABS, DNV, GL, LRS, BV, PRS, CCS, RMRS	ABS, DNV, GL, LRS, BV, PRS, CCS, RMRS

Breaking capacity

		N	S	M	E	S	M	H	C	E
Rated short-circuit breaking capacity										
$I_{cu} I_{cs}$ at U_e up to 415/440 V AC	kA	55 55	66 66	85 85	- -	66 66	85 85	100 100	130 130	- -
$I_{cu} I_{cs}$ at U_e up to 500 V AC	kA	55 55	66 66	85 85	- -	66 66	85 85	100 100	130 130	- -
$I_{cu} I_{cs}$ at U_e up to 690 V AC	kA	42 42	50 50	66 66	85 85	50 50	66 66	85 85	100 100	85 85
$I_{cu} I_{cs}$ at U_e up to 1000 V AC	kA	- -	- -	- -	50 50	- -	- -	- -	- -	85 85
$I_{cu} I_{cs}$ at U_e up to 1150 V AC	kA	- -	- -	- -	- -	- -	- -	- -	- -	50 50

Rated short-circuit making capacity I_{cm}

I_{cm} at U_e up to 415 V AC	kA	121	145	187	-	145	187	220	286	-
I_{cm} at U_e up to 500 V AC	kA	121	145	187	-	145	187	220	286	-
I_{cm} at U_e up to 690 V AC	kA	88	105	145	187	105	145	187	220	187
I_{cm} at U_e up to 1000 V AC	kA	-	-	-	105	-	-	-	-	187
I_{cm} at U_e up to 1150 V AC	kA	-	-	-	-	-	-	-	-	105

AC



3WA13

DC



3WA12

1

3WA13			3WA12		
≤ 1150			≤ 1000 (≤ 1500 for 4-pole, Breaking capacity E)		
4000 ... 6300			1000 ... 4000		
3			2		
Withdrawable		Fixed-mounted	Withdrawable		Fixed-mounted
3/4-pole		3/4-pole	3/4-pole		3/4-pole
704 914		704 914	460 590		460 590
466 516		437 462	466 516		437 462
471		357	471		357
VDE, EAC, CCC, CE, C-Tick ABS, DNV, GL, LRS, BV, PRS, CCS, RMRS			VDE, EAC, CCC, CE, C-Tick ABS, DNV, GL, LRS, BV, PRS, CCS, RMRS		
H	C	E	D	E	
- -	- -	- -	- -	- -	- -
100 100	150 150 (3-pole); 130 130 (4-pole)	- -	- -	- -	- -
85 85	150 150 (3-pole); 130 130 (4-pole)	150 150 (3-pole); 130 130 (4-pole)	- -	- -	- -
- -	- -	125 125	- -	- -	- -
- -	- -	70 70	- -	- -	- -
220	330 (3-pole); 286 (4-pole)	-	-	-	-
220	330 (3-pole); 286 (4-pole)	-	-	-	-
187	330 (3-pole); 286 (4-pole)	330 (3-pole); 286 (4-pole)	-	-	-
-	-	275	-	-	-
-	-	154	-	-	-

3WA1 circuit breakers and non-automatic circuit breakers for AC and DC

IEC 60947-2 (continued)

AC



3WA11

3WA12

Breaking capacity			N	S	M	E	S	M	H	C	E
Rated short-time withstand current $I_{cw}^{1)}$											
I_{cw} at U_e up to 500 V AC	0.5 s	kA	55	66	85	–	66	85	100	100	–
	1 s	kA	50	66	85	–	66	85	85	100	–
	2 s	kA	35 ^{2)/45³⁾}	45	70	–	66	66 ^{4)/85⁵⁾}	66 ^{4)/85⁵⁾}	85	–
	3 s	kA	30 ^{2)/35³⁾}	35	60	–	55 ^{4)/66⁵⁾}	55 ^{4)/75⁵⁾}	55 ^{4)/75⁵⁾}	75	–
I_{cw} at U_e up to 690 V AC	0.5 s	kA	42	50	66	85	50	66	85	100	85
	1 s	kA	42	50	66	85	50	66	85	100	85
	2 s	kA	35 ^{2)/42³⁾}	45	66	70	50	66	66 ^{4)/85⁵⁾}	85	66 ^{4)/85⁵⁾}
	3 s	kA	30 ^{2)/35³⁾}	35	60	60	50	55 ^{4)/66⁵⁾}	55 ^{4)/75⁵⁾}	75	55 ^{4)/75⁵⁾}
I_{cw} at U_e up to 1000 V AC	0.5 s	kA	–	–	–	50	–	–	–	–	85
	1 s	kA	–	–	–	50	–	–	–	–	85
	2 s	kA	–	–	–	50	–	–	–	–	66 ^{4)/85⁵⁾}
	3 s	kA	–	–	–	50	–	–	–	–	55 ^{4)/75⁵⁾}
I_{cw} at U_e up to 1150 V AC	0.5 s	kA	–	–	–	–	–	–	–	–	50
	1 s	kA	–	–	–	–	–	–	–	–	50
	2 s	kA	–	–	–	–	–	–	–	–	50
	3 s	kA	–	–	–	–	–	–	–	–	50
I_{cw} at U_e up to 220 V DC	1 s	kA	–	–	–	–	–	–	–	–	–
I_{cw} at U_e up to 300 V DC	1 s	kA	–	–	–	–	–	–	–	–	–
I_{cw} at U_e up to 600 V DC	1 s	kA	–	–	–	–	–	–	–	–	–
I_{cw} at U_e up to 1000 V DC	1 s	kA	–	–	–	–	–	–	–	–	–
I_{cw} at U_e up to 1500 V DC	1 s	kA	–	–	–	–	–	–	–	–	–
Rated conditional short-circuit current I_{cc} of the non-automatic air circuit breakers											
Up to 500 V AC		kA	55	66	85	–	66	85	100	100	–
Up to 690 V AC		kA	42	50	66	85	50	66	85	100	85
Up to 1000 V AC		kA	–	–	–	50	–	–	–	–	85
Up to 1150 V AC		kA	–	–	–	–	–	–	–	–	50
Up to 220 V DC		kA	–	–	–	–	–	–	–	–	–
Up to 300 V DC		kA	–	–	–	–	–	–	–	–	–
Up to 600 V DC		kA	–	–	–	–	–	–	–	–	–
Up to 1000 V DC		kA	–	–	–	–	–	–	–	–	–
Up to 1500 V DC		kA	–	–	–	–	–	–	–	–	–
IT network capability											
1-pole short-circuit breaking capacity I_{IT}											
acc. to IEC 60947-2 Annex H											
≤ 500 V	kA	50	50	50	–	50	50	50	50	–	–
≤ 690 V	kA	–	–	–	50	–	–	–	–	–	50
1000 V	kA	–	–	–	–	–	–	–	–	–	–
Footnotes											
1) At rated operational voltage $U_e \geq 690$ V, the I_{cw} value of the circuit breaker corresponds to the I_{cu} or I_{cs} value											
2) Size 1 with $I_{n\max} \leq 1250$ A											
3) Size 1 with $I_{n\max} \geq 1600$ A											
4) $I_{n\max} \leq 2500$ A											
5) $I_{n\max} \geq 3200$ A											

AC



DC



3WA13

3WA12

H	C	E	D	E
100	130 (3-pole); 120 (4-pole)	–	–	–
100	130 (3-pole); 120 (4-pole)	–	–	–
100	130 (3-pole); 120 (4-pole)	–	–	–
100	130 (3-pole); 120 (4-pole)	–	–	–
85	130 (3-pole); 120 (4-pole)	130 (3-pole); 120 (4-pole)	–	–
85	130 (3-pole); 120 (4-pole)	130 (3-pole); 120 (4-pole)	–	–
85	130 (3-pole); 120 (4-pole)	130 (3-pole); 120 (4-pole)	–	–
85	130 (3-pole); 120 (4-pole)	130 (3-pole); 120 (4-pole)	–	–
–	–	125 (3-pole); 120 (4-pole)	–	–
–	–	125 (3-pole); 120 (4-pole)	–	–
–	–	125 (3-pole); 120 (4-pole)	–	–
–	–	70	–	–
–	–	70	–	–
–	–	70	–	–
–	–	70	–	–
–	–	–	35	–
–	–	–	30	–
–	–	–	25	–
–	–	–	–	20
–	–	–	–	– (3-pole); 20 (4-pole)
100	130 (3-pole); 120 (4-pole)	–	–	–
85	130 (3-pole); 120 (4-pole)	130 (3-pole); 120 (4-pole)	–	–
–	–	125 (3-pole); 120 (4-pole)	–	–
–	–	70	–	–
–	–	–	35	–
–	–	–	30	–
–	–	–	25	–
–	–	–	–	20
–	–	–	–	– (3-pole); 20 (4-pole)
50	50	–	–	–
–	–	50	–	–
–	–	–	–	–

1

3WA1 circuit breakers and non-automatic circuit breakers for AC

IEC 60947-2

3WA11



Rated current I_n			630 A	800 A	1000 A	1250 A	1600 A	2000 A	2500 A
General data									
Isolating function acc. to EN 60947-2			Yes						
Utilization category			B						
Permissible ambient temperature	Operation	°C	-40 ... +70						
	Storage	°C	-40 ... +80						
Mounting position									
Degree of protection			IP20 without control cabinet door, IP41 with door sealing frame, IP55 with cover						
Voltage									
Rated operational voltage U_e at 50/60 Hz	1000 V version	V AC	≤ 1000						
Rated insulation voltage U_i		V AC	1000						
Rated impulse withstand voltage U_{imp}	Main conducting paths	kV	12						
	Auxiliary circuits	kV	4						
	Control circuits	kV	2.5						
Permissible load									
Permissible load for withdrawable versions									
For all connection types (except rear vertical main connections)	Up to 55 °C (Cu bare)	A	630	800	1000	1250	1600	2000	–
	Up to 60 °C (Cu bare)	A	630	800	1000	1250	1600	1930	–
	Up to 70 °C (Cu bare)	A	630	800	1000	1210	1490	1780	–
With rear vertical connections	Up to 55 °C (Cu bare)	A	630	800	1000	1250	1600	2000	2500
	Up to 60 °C (Cu bare)	A	630	800	1000	1250	1600	2000	2370
	Up to 70 °C (Cu bare)	A	630	800	1000	1250	1545	1855	2060
Permissible load for fixed-mounted versions									
For all connection types (except rear vertical main connections)	Up to 55 °C (Cu bare)	A	630	800	1000	1250	1600	2000	–
	Up to 60 °C (Cu bare)	A	630	800	1000	1250	1600	2000	–
	Up to 70 °C (Cu bare)	A	630	800	1000	1250	1600	2000	–
With rear vertical connections	Up to 55 °C (Cu bare)	A	630	800	1000	1250	1600	2000	2500
	Up to 60 °C (Cu bare)	A	630	800	1000	1250	1600	2000	2500
	Up to 70 °C (Cu bare)	A	630	800	1000	1250	1600	2000	2500
Power loss at I_n									
With 3-phase symmetrical load with maximum rated current, complete device (3/4p)	Fixed-mounted	W	30	45	70	105	135	240	360
	Withdrawable versions	W	55	85	130	205	310	440	600

3WA12



3WA13



3WA12				3WA13		
2000 A	2500 A	3200 A	4000 A	4000 A	5000 A	6300 A
Yes				Yes		
B				B		
-40 ... +70				-40 ... +70		
-40 ... +80				-40 ... +80		
<p>IP20 without control cabinet door, IP41 with door sealing frame, IP55 with cover</p>				<p>IP20 without control cabinet door, IP41 with door sealing frame, IP55 with cover</p>		
≤ 1150				≤ 1150		
≤ 1150				≤ 1150		
12				12		
4				4		
2.5				2.5		
2000	2500	3200	–	4000	5000	–
2000	2500	3020	–	4000	5000	–
2000	2280	2870	–	4000	5000	–
2000	2500	3200	4000	4000	5000	5920
2000	2500	3200	3910	4000	5000	5810
2000	2390	2945	3645	4000	5000	5500
2000	2500	3200	–	4000	5000	–
2000	2500	3200	–	4000	5000	–
2000	2500	3200	–	4000	5000	–
2000	2500	3200	4000	4000	5000	6300
2000	2500	3200	4000	4000	5000	6300
2000	2500	3200	4000	4000	5000	5920
180	270	410	750	520	630	900
320	520	710	1040	810	1050	1600

3WA1 circuit breakers and non-automatic circuit breakers for AC

IEC 60947-2 (continued)

3WA11



Rated current I_n			630 A	800 A	1000 A	1250 A	1600 A	2000 A	2500 A
Switching times									
Make time	ms					35			
Opening time	ms					38			
Electrical make time (through closing coil) ¹⁾	ms					80			
Electrical opening time (through shunt trip)	ms					73			
Electrical opening time (instantaneous undervoltage release)	ms					≤ 80			
Opening time due to ETU, instantaneous short-circuit release	ms					50			
Service life/endurance									
Breaking capacity N, 3/4-pole									
Mechanical	Without maintenance	Operating cycles				15000			
	With maintenance ²⁾	Operating cycles				30000			
Electrical	Without maintenance 690 V	Operating cycles			10000		7500	5000	
	With maintenance ²⁾	Operating cycles				30000			
Breaking capacity S, 3/4-pole									
Mechanical	Without maintenance	Operating cycles				15000			
	With maintenance ²⁾	Operating cycles				30000			
Electrical	Without maintenance 690 V	Operating cycles			10000		7500	5000	
	With maintenance ²⁾	Operating cycles				30000			
Breaking capacity M, 3/4-pole									
Mechanical	Without maintenance	Operating cycles				10000			
	With maintenance ²⁾	Operating cycles				15000			
Electrical	Without maintenance 690 V	Operating cycles			10000		7500	5000	
	With maintenance ²⁾	Operating cycles				15000			
Breaking capacity E, 3/4-pole									
Mechanical	Without maintenance	Operating cycles				10000			
	With maintenance ²⁾	Operating cycles				15000			
Electrical	Without maintenance 690 V	Operating cycles			10000		7500	5000	
	Without maintenance 1000 V	Operating cycles				1000			
	Without maintenance 1150 V	Operating cycles				–			
	With maintenance ²⁾	Operating cycles				15000			
Breaking capacity H, 3/4-pole									
Mechanical	Without maintenance	Operating cycles				–			
	With maintenance ²⁾	Operating cycles				–			
Electrical	Without maintenance 690 V	Operating cycles				–			
	With maintenance ²⁾	Operating cycles				–			
Breaking capacity C, 3/4-pole									
Mechanical	Without maintenance	Operating cycles				–			
	With maintenance ²⁾	Operating cycles				–			
Electrical	Without maintenance 690 V	Operating cycles				–			
	With maintenance 690 V ²⁾	Operating cycles				–			
Switching frequency									
Breaking capacity N and S									
Electrical	3-pole	1/h				45			
	4-pole	1/h				45			
Breaking capacity M, H and C									
Electrical	3- and 4-pole	1/h				60 ≤ 690 V			
Breaking capacity E									
Electrical	3- and 4-pole	1/h				20 at 1000 V, 60 ≤ 690 V			

¹⁾ Make time through closing coil for momentary duty for synchronization purposes 5% OP = 50 ms

²⁾ Maintenance means: Replacing main contact elements and arc chutes (see operating instructions: www.siemens.com/lowvoltage/manuals).

3WA12



3WA13



2000 A		2500 A		3200 A		4000 A		4000 A		5000 A		6300 A	
			35								35		
			34								34		
			100								100		
			73								73		
			≤ 80								≤ 80		
			50								50		
			-								-		
			-								-		
			-								-		
			-								-		
			10000								-		
			20000								-		
7500		7500		4000		2000					-		
			20000								-		
			10000								-		
			20000								-		
7500		7500		4000		2000					-		
			20000								-		
			10000								5000		
			20000								10000		
7500		7500		4000		2000					1000		
			1000								1000		
			500								500		
			20000								10000		
			10000								7500		
			20000								15000		
7500		7500		4000		2000					15000		
20000		20000		20000		20000					15000		
			5000								5000		
			10000								10000		
5000		5000		4000		1000					1000		
10000		10000		10000		10000					10000		
			45								-		
			60								-		
			60 ≤ 690 V								60 ≤ 690 V		
			20 at 1000/1150 V, 60 ≤ 690 V								20 at 1000/1150 V, 60 ≤ 690 V		

3WA1 circuit breakers and non-automatic circuit breakers for AC

IEC 60947-2 (continued)

3WA11



Rated current I_n		630 A	800 A	1000 A	1250 A	1600 A	2000 A	2500 A	
Connection									
Minimum main conductor cross-sections									
Copper bars, bare	Unit, mm ²	1 × 40 × 10	1 × 50 × 10	1 × 60 × 10	2 × 40 × 10	2 × 50 × 10	3 × 50 × 10	4 × 50 × 10	
Copper bars, painted black	Unit, mm ²	1 × 40 × 10	1 × 50 × 10	1 × 60 × 10	2 × 40 × 10	2 × 50 × 10	3 × 50 × 10	4 × 50 × 10	
Auxiliary conductor (Cu) max. number of auxiliary conductors × cross-section (solid/stranded)									
Standard connection = push-in	Without end sleeve	2 × 0.5 ... 2.5 mm ² (AWG 20 ... 14)							
	With end sleeve acc. to DIN 46228 Part 2	2 × 0.5 ... 2.5 mm ² (AWG 20 ... 14)							
	With twin end sleeve	2 × 0.5 ... 1.5 mm ² (AWG 20 ... 16)							
	Stripped length	10 ... 12 mm (0.39 ... 0.47 inch)							
Optional connection with screw connection	Without end sleeve	2 × 0.5 ... 2.5 mm ² (AWG 20 ... 14)							
	With end sleeve acc. to DIN 46228 Part 2	1 × 0.5 ... 1.5 mm ² (AWG 20 ... 16)							
	With twin end sleeve	1 × 0.5 ... 1.5 mm ² (AWG 20 ... 16)							
	Stripped length	7 ... 8 mm (0.28 ... 0.31 inch)							
Position signaling switch									
Spring-loaded terminals for standard signaling contacts	Without end sleeve	0.08 ... 2.5 mm ² (AWG 20 ... 12)							
	With end sleeve acc. to DIN 46228 Part 2	0.25 ... 1.5 mm ²							
	Stripped length	5 ... 6 mm (0.2 ... 0.24 inch)							
Push-in connection for communication signaling contacts	Without end sleeve	0.14 ... 1.5 mm ² (AWG 20 ... 16)							
	With end sleeve acc. to DIN 46228 Part 2	0.25 ... 1.5 mm ² (AWG 20 ... 16)							
	Stripped length	9 mm (0.35 inch)							
Weights ¹⁾									
3-pole	Fixed-mounted circuit breaker	kg	38.5	38.5	38.5	42.5	42.5	43.5	43.5
	Withdrawable circuit breaker without guide frame	kg	39	39	39	40	40	41	41
	Guide frames	kg	26	26	26	27	27	29	29
4-pole	Fixed-mounted circuit breaker	kg	47	47	47	52	52	53	53
	Withdrawable circuit breaker without guide frame	kg	45	45	45	46	46	47	47
	Guide frames	kg	30	30	30	32	32	34	34

¹⁾ Weights refer to:

- Breakers with the lowest breaking capacity in each case (size 1: breaking capacity N, size 2: breaking capacity S, size 3: breaking capacity H)
- Breakers with ETU600 (LSI)
- Fixed-mounted circuit breakers/guide frames with vertical connections
- Guide frame with position signaling switch
- Without any other accessories

3WA12



3WA13



1

2000 A	2500 A	3200 A	4000 A	4000 A	5000 A	6300 A
3 × 50 × 10	2 × 100 × 10	3 × 100 × 10	4 × 120 × 10	4 × 100 × 10	6 × 100 × 10	6 × 120 × 10
3 × 50 × 10	2 × 100 × 10	3 × 100 × 10	4 × 120 × 10	4 × 100 × 10	6 × 100 × 10	6 × 120 × 10
	2 × 0.5 ... 2.5 mm ² (AWG 20 ... 14)				2 × 0.5 ... 2.5 mm ² (AWG 20 ... 14)	
	2 × 0.5 ... 2.5 mm ² (AWG 20 ... 14)				2 × 0.5 ... 2.5 mm ² (AWG 20 ... 14)	
	2 × 0.5 ... 1.5 mm ² (AWG 20 ... 16)				2 × 0.5 ... 1.5 mm ² (AWG 20 ... 16)	
	10 ... 12 mm (0.39 ... 0.47 inch)				10 ... 12 mm (0.39 ... 0.47 inch)	
	2 × 0.5 ... 2.5 mm ² (AWG 20 ... 14)				2 × 0.5 ... 2.5 mm ² (AWG 20 ... 14)	
	1 × 0.5 ... 1.5 mm ² (AWG 20 ... 16)				1 × 0.5 ... 1.5 mm ² (AWG 20 ... 16)	
	1 × 0.5 ... 1.5 mm ² (AWG 20 ... 16)				1 × 0.5 ... 1.5 mm ² (AWG 20 ... 16)	
	7 ... 8 mm (0.28 ... 0.31 inch)				7 ... 8 mm (0.28 ... 0.31 inch)	
	0.08 ... 2.5 mm ² (AWG 20 ... 12)				0.08 ... 2.5 mm ² (AWG 20 ... 12)	
	0.25 ... 1.5 mm ²				0.25 ... 1.5 mm ²	
	5 ... 6 mm (0.2 ... 0.24 inch)				5 ... 6 mm (0.2 ... 0.24 inch)	
	0.14 ... 1.5 mm ² (AWG 20 ... 16)				0.14 ... 1.5 mm ² (AWG 20 ... 16)	
	0.25 ... 1.5 mm ² (AWG 20 ... 16)				0.25 ... 1.5 mm ² (AWG 20 ... 16)	
	9 mm (0.35 inch)				9 mm (0.35 inch)	
55	57	69	77	113	115	115
52	54	59	59	91	92	92
33.5	35.5	36.5	40	85.5	87	87
68.5	71.5	86.5	97.5	147.5	149.5	149.5
63.5	66	73	73	115.5	116.5	116.5
40	42.5	51.5	53	103.5	105.5	105.5

3WA1 non-automatic circuit breakers for DC

IEC 60947-2

3WA12



Rated current I_n			1000 A	2000 A	4000 A
General data					
Isolating function acc. to EN 60947-2			Yes		
Utilization category			B		
Permissible ambient temperature	During operation (in operation with LCD max. 55 °C)	°C	-40 ... +70		
	Storage	°C	-40 ... +80		
Mounting position					
Degree of protection			IP20 without control cabinet door, IP41 with door sealing frame, IP55 with cover		
Voltage					
Rated operational voltage U_e	Breaking capacity D E	V DC	600 1000 (3-pole); 1500 (4-pole)		
Rated insulation voltage U_i	Breaking capacity D E	V DC	600 1000 (3-pole); 1500 (4-pole)		
Rated impulse withstand voltage U_{imp}	Main conducting paths	kV	12		
	Auxiliary circuits	kV	4		
	Control circuits	kV	2.5		
Permissible load					
Permissible load for withdrawable versions					
For all connection types (except rear vertical main connections)	Up to 40 °C (Cu bare)	A	1000	2000	4000
	Up to 55 °C (Cu bare)	A	1000	2000	3640
	Up to 60 °C (Cu bare)	A	1000	2000	3500
	Up to 70 °C (Cu bare)	A	1000	1950	3250
With rear vertical connections	Up to 40 °C (Cu bare)	A	1000	2000	4000
	Up to 55 °C (Cu bare)	A	1000	2000	4000
	Up to 60 °C (Cu bare)	A	1000	2000	3640
	Up to 70 °C (Cu bare)	A	1000	2000	3400
Permissible load for fixed-mounted versions					
For all connection types (except rear vertical main connections)	Up to 40 °C (Cu bare)	A	1000	2000	4000
	Up to 55 °C (Cu bare)	A	1000	2000	4000
	Up to 60 °C (Cu bare)	A	1000	2000	4000
	Up to 70 °C (Cu bare)	A	1000	2000	3900
With rear vertical connections	Up to 40 °C (Cu bare)	A	1000	2000	4000
	Up to 55 °C (Cu bare)	A	1000	2000	4000
	Up to 60 °C (Cu bare)	A	1000	2000	4000
	Up to 70 °C (Cu bare)	A	1000	2000	4000
Power loss at I_n					
With 3-phase symmetrical load, complete device (3/4p)	Withdrawable versions	W	280	770	1640
	Fixed-mounted	W	140	390	820
Switching times					
Make time		ms	35	35	35
Opening time		ms	34	34	34
Electrical make time (through closing coil)		ms	100	100	100
Electrical opening time (through shunt trip)		ms	73	73	73
Electrical opening time (instantaneous undervoltage release)		ms	≤ 80	≤ 80	≤ 80
Service life/endurance					
Breaking capacity D, 3/4-pole					
Mechanical	Without maintenance	Operating cycles	10000	10000	10000
	With maintenance ¹⁾	Operating cycles	20000	20000	20000
Electrical	Without maintenance 600 V	Operating cycles	6000	6000	4000
	With maintenance ¹⁾	Operating cycles	20000	20000	20000

3WA12



1

Rated current I_n			1000 A	2000 A	4000 A
Service life/endurance					
Breaking capacity E, 3/4-pole					
Mechanical	Without maintenance	Operating cycles	10000	10000	10000
	With maintenance ¹⁾	Operating cycles	20000	20000	20000
Electrical	Without maintenance 1000 V	Operating cycles	1000	1000	1000
	With maintenance ¹⁾	Operating cycles	20000	20000	20000
Breaking capacity E, 4-pole					
Electrical	Without maintenance 1500 V ²⁾	Operating cycles	1000	1000	1000
	With maintenance ¹⁾	Operating cycles	20000	20000	20000
Switching frequency					
Breaking capacity D					
Electrical	3- and 4-pole	1/h	60	60	60
Breaking capacity E					
Electrical	3- and 4-pole	1/h	20	20	20
Connection					
Minimum main conductor cross-sections					
Copper bars, bare		Unit, mm ²	1 × 50 × 10	2 × 50 × 10	3 × 100 × 10 on the infeed and outgoing side; 6 × 250 × 500 × 5 for jumpers
Copper bars, painted black		Unit, mm ²	1 × 50 × 10	2 × 50 × 10	3 × 100 × 10 on the infeed and outgoing side; 6 × 250 × 500 × 5 for jumpers
Auxiliary conductor (Cu) max. number of auxiliary conductors × cross-section (solid/stranded)					
Standard connection = push-in	Without end sleeve		2 × 0.5 ... 2.5 mm ² (AWG 20 ... 14)		
	With end sleeve acc. to DIN 46228 Part 2		2 × 0.5 ... 2.5 mm ² (AWG 20 ... 14)		
	With twin end sleeve		2 × 0.5 ... 1.5 mm ² (AWG 20 ... 16)		
	Stripped length		10 ... 12 mm (0.39 ... 0.47 inch)		
Optional connection with screw connection	Without end sleeve		2 × 0.5 ... 2.5 mm ² (AWG 20 ... 14)		
	With end sleeve acc. to DIN 46228 Part 2		1 × 0.5 ... 1.5 mm ² (AWG 20 ... 16)		
	With twin end sleeve		1 × 0.5 ... 1.5 mm ² (AWG 20 ... 16)		
	Stripped length		7 ... 8 mm (0.28 ... 0.31 inch)		
Position signaling switch					
Spring-loaded terminals for standard signaling contacts	Without end sleeve		0.08 ... 2.5 mm ² (AWG 20 ... 12)		
	With end sleeve acc. to DIN 46228 Part 2		0.25 ... 1.5 mm ²		
	Stripped length		5 ... 6 mm (0.2 ... 0.24 inch)		
Push-in connection for communication signaling contacts	Without end sleeve		0.14 ... 1.5 mm ² (AWG 20 ... 16)		
	With end sleeve acc. to DIN 46228 Part 2		0.25 ... 1.5 mm ² (AWG 20 ... 16)		
	Stripped length		9 mm (0.35 inch)		
Weights ³⁾					
3-pole	Fixed-mounted circuit breaker	kg	55	55	68
	Withdrawable circuit breaker without guide frame	kg	52	52	59
	Guide frames	kg	34	34	50
4-pole	Fixed-mounted circuit breaker	kg	68.5	68.5	86.5
	Withdrawable circuit breaker without guide frame	kg	63.5	63.5	74
	Guide frames	kg	40.5	40.5	61.5

¹⁾ Maintenance means: Replacing main contact elements and arc chutes (see operating instructions: www.siemens.com/lowvoltage/manuals).

²⁾ 1500 V DC applications only possible with 4-pole circuit breakers and breaking capacity E.


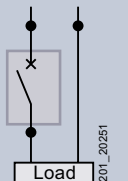
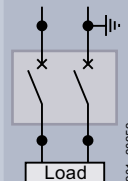
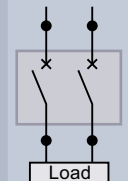

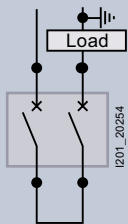
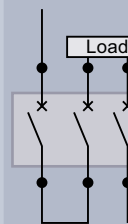
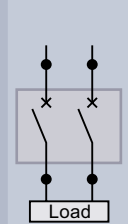

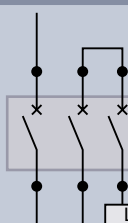
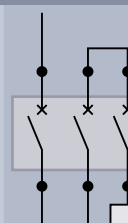
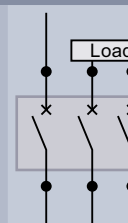

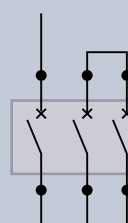
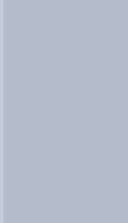
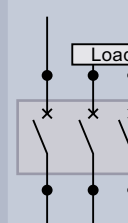
³⁾ Weights refer to:

- Breakers with breaking capacity E
- Fixed-mounted circuit breakers/guide frames with vertical connections
- Guide frame with position signaling switch
- Without any other accessories

3WA1 non-automatic circuit breakers for DC

Application examples

The connection to the non-automatic circuit breakers is not dependent on direction and polarity; the circuit diagrams can be adapted accordingly. If the parallel or series connections are made directly to the connection bars, for thermal reasons the continuous load on the non-automatic circuit breakers must only be 80% of the permissible operational current. If the parallel or series connection is made at a distance of 1 m from the connection bars, the non-automatic circuit breaker can be used at full operational current load.

Minimum required contact gaps at rated voltage	DC 1-pole disconnection Grounded system	DC 2-pole (all-pole) disconnection Grounded system	DC 2-pole (all-pole) disconnection Non-grounded system
Rated operational voltage up to 300 V 			
Rated operational voltage up to 600 V 			
Rated operational voltage up to 1000 V 			
Rated operational voltage up to 1500 V 			

Note:

DC 2-pole (all-pole) disconnection; grounded system

The grounded conductor must always be assigned to the individual switching pole of the non-automatic air circuit breaker, so that in the event of a ground fault there are always 2 conducting paths in series in a circuit with 3-pole circuit breakers, and 3 conducting paths in series in a circuit with 4-pole circuit breakers. The jumpers between the switching poles must be short-circuit and ground-fault proof.

Electronic trip unit

Differentiation

1



ETU300 electronic trip unit

ETU600 electronic trip unit

Function	ETU300 electronic trip unit	ETU600 electronic trip unit
Protective function LSI	■	■
Protective function LSIG	■	■
Protective function LSIG Hi-Z	–	■
Neutral conductor protection (N)	■	■
Metering function	–	■
Enhanced Protective functions	–	■
CubicleBUS ²	–	■
Display	–	■
DAS+ input/output	■	■
LED display of reason for tripping	■	■
Bluetooth and USB	–	■
FW Updates	–	■
Internal self-test with and without tripping	■	■
Extended test option (tripping characteristic)	–	■
Activation of the ETU via powerbank	–	■
Activation of the ETU for self-test via TD400	■	–

Note:

By replacing the electronic trip unit, it is possible to upgrade from ETU300 to ETU600.

ETU300 electronic trip unit

Protective functions

ETU300 LSI, ETU300 LSIG

Protective function	Setting range and invariable parameters	Values
L: Overload protection LT		
Tripping	Switched on	
Current setting I_r	0.4 ... $1.0 \times I_n$	0.4/0.5/0.6/0.7/0.75/0.8/0.85/0.9/0.95/1.0 $\times I_n$
Tripping time t_r at $6 \times I_r$	0.75 ... 25 s	0.75/1/2/5/8/10/14/17/21/25 s
Characteristic LT curve	I^2t	
Thermal memory	Switched on	
Cooling time constant	$18 \times t_r$	
Phase failure detection	Switched on	
L: Overload protection LT, neutral conductor		
Tripping	Switched on	
Current setting I_N	$1.0 \times I_n$	
S: Short-time-delayed short-circuit protection ST		
Tripping	Can be switched on/off	
Current setting I_{sd}	1.5 ... $10 \times I_n$ max. $0.8 \times I_{cw}^{(2)}$	OFF/1.5/2/2.5/3/4/5/6/8/10 $\times I_r$ max. $0.8 \times I_{cw}^{(1)}$
Tripping time t_{sd}	0.08 ... 0.4 s	0.08/0.15/0.22/0.3/0.4 s
Characteristic ST curve	I^2t and I^2t	
Reference point I_{STref}	$8 \times I_r$	
I: Instantaneous short-circuit protection INST		
Tripping	Switched on	
Current setting I_i	1.5 ... $15 \times I_n$ max. $0.8 \times I_{cs}^{(2)}$	1.5/2/3/4/5/6/8/10/12/15 $\times I_n$ max. $0.8 \times I_{cs}^{(1)}$
Maintenance mode DAS+		
Current setting I_{DAS+}	$1.5 \times I_n$	Activation via ETU input

ETU300 LSIG

Protective function	Setting range	
G: Ground-fault protection GF		
Tripping	Switched on	
Method of ground fault detection	Residual	Detection of ground-fault current via summation current formation in all phases and the N conductor
Characteristic GF curve		I^2t
Current setting I_g		$0.2 \times I_n$ (min. 100 A, max. 1200 A)
Tripping time t_g	0.2 s	

¹⁾ The setting value is limited as a function of the breaking capacity at rated operational voltage U_e .

ETU600 electronic trip unit

Protective functions

ETU600 LSI, ETU600 LSIG, ETU600 LSIG Hi-Z			Current metering	ready4COM	PMF-I Energy efficiency	PMF-II Basic Power Monitoring	PMF-III Advanced Power Monitoring
Protective function	Variable setting range	Setting values with rotary switch					
L: Overload protection LT							
Tripping	Can be switched on/off		■	■	■	■	■
Current setting I_r	0.4 ... $1.0 \times I_n$	0.5/0.6/0.7/0.75/0.8/0.85/0.9/0.95/1.0 $\times I_n$	■	■	■	■	■
Tripping time t_r at $6 \times I_r$	At I^2t : 0.5 ... 30 s and at I^4t : 0.5 ... 5 s	1/2/5/8/10/14/17/21/25 s	■	■	■	■	■
Characteristic LT curve	I^2t and I^4t		■	■	■	■	■
Thermal memory	Can be switched on/off		■	■	■	■	■
Cooling time constant	10 and $18 \times t_r$		■	■	■	■	■
Phase failure detection	Can be switched on/off		■	■	■	■	■
Overload pre-alarm PAL	Can be switched on/off		■	■	■	■	■
Current setting $I_{r,PAL}$	0.7 ... $1.0 \times I_r$		■	■	■	■	■
Delay time $t_{r,PAL}$	0.5 ... $1.0 \times t_r$		■	■	■	■	■
L: Overload protection LT, neutral conductor							
Tripping	Can be switched on/off		■	■	■	■	■
Current setting I_{rN}	0.2 ... $2.0 \times I_n$ for 4-pole circuit breakers max. $I_{n,max}$		■	■	■	■	■
Current setting $I_{rN,PAL}$	0.7 ... $1.0 \times I_{rN}$		■	■	■	■	■
S: Short-time-delayed short-circuit protection ST							
Tripping	Can be switched on/off		■	■	■	■	■
Current setting I_{sd}	$0.6 \times I_n$... $0.8 \times I_{cw}$ max. $0.8 \times I_{cw}^{(1)}$	1.5/2/2.5/3/4/5/6/8/10 $\times I_r$ max. $0.8 \times I_{cw}^{(1)}$	■	■	■	■	■
Tripping time t_{sd}	0.02 ... 0.4 s	At Fix: 0.08/0.15/0.22/0.3/0.4 s At I^2t : 0.1/0.2/0.3/0.4 s	■	■	■	■	■
Characteristic ST curve	I^0t and I^2t		■	■	■	■	■
Reference point $I_{ST,ref}$	$6-12 \times I_r$		■	■	■	■	■
Intermittent detection	Can be switched on/off		■	■	■	■	■
S: Directional short-time-delayed short-circuit protection dST							
Tripping	Can be switched on/off		□	□	□	■	■
Direction setting	Forward: ↓ or ↑		□	□	□	■	■
Current setting $I_{sd,FW}$	$0.6 \times I_n$... $0.8 \times I_{cw}$		□	□	□	■	■
Current setting $I_{sd,REV}$	$0.6 \times I_n$... $0.8 \times I_{cw}$		□	□	□	■	■
Tripping time $t_{sd,FW}$	0.05 ... 0.4 s		□	□	□	■	■
Tripping time $t_{sd,REV}$	0.05 ... 0.4 s		□	□	□	■	■
I: Instantaneous short-circuit protection INST							
Tripping	Can be switched on/off		■	■	■	■	■
Current setting I_i	$1.5 \times I_n$... $0.8 \times I_{cs}$ max. $0.8 \times I_{cs}^{(1)}$	1.5/2/3/4/6/8/10/12/15 $\times I_n$ max. $0.8 \times I_{cs}^{(1)}$	■	■	■	■	■

- Available, feature of the application package
- Can be retrofitted

¹⁾ The setting value is limited as a function of the breaking capacity at the set rated voltage.

ETU600 LSI, ETU600 LSIG, ETU600 LSIG Hi-Z			Current metering	ready4COM	PMF-I Energy efficiency	PMF-II Basic Power Monitoring	PMF-III Advanced Power Monitoring
Protective function	Variable setting range	Setting values with rotary switch					
Reverse power protection RP							
Tripping	Can be switched on/off		<input type="checkbox"/>	<input type="checkbox"/>	<input type="checkbox"/>	<input checked="" type="checkbox"/>	<input checked="" type="checkbox"/>
Setting value P_{RP}	0.05 ... $0.5 \times P_n$		<input type="checkbox"/>	<input type="checkbox"/>	<input type="checkbox"/>	<input checked="" type="checkbox"/>	<input checked="" type="checkbox"/>
Tripping time t_{RP}	0.01 ... 25 s		<input type="checkbox"/>	<input type="checkbox"/>	<input type="checkbox"/>	<input checked="" type="checkbox"/>	<input checked="" type="checkbox"/>
Enhanced Protective functions EPF							
Phase unbalance current and phase unbalance voltage			<input type="checkbox"/>	<input type="checkbox"/>	<input type="checkbox"/>	<input checked="" type="checkbox"/>	<input checked="" type="checkbox"/>
Undervoltage and overvoltage			<input type="checkbox"/>	<input type="checkbox"/>	<input type="checkbox"/>	<input checked="" type="checkbox"/>	<input checked="" type="checkbox"/>
Active power import and active power export			<input type="checkbox"/>	<input type="checkbox"/>	<input type="checkbox"/>	<input checked="" type="checkbox"/>	<input checked="" type="checkbox"/>
Underfrequency and overfrequency			<input type="checkbox"/>	<input type="checkbox"/>	<input type="checkbox"/>	<input checked="" type="checkbox"/>	<input checked="" type="checkbox"/>
Total harmonic distortion for current and voltage			<input type="checkbox"/>	<input type="checkbox"/>	<input type="checkbox"/>	<input checked="" type="checkbox"/>	<input checked="" type="checkbox"/>
Phase sequence detection			<input type="checkbox"/>	<input type="checkbox"/>	<input type="checkbox"/>	<input checked="" type="checkbox"/>	<input checked="" type="checkbox"/>
Maintenance mode DAS+							
Current setting $I_{1\text{DAS}+}$	1.5 ... $10 \times I_n$		<input checked="" type="checkbox"/>	<input checked="" type="checkbox"/>	<input checked="" type="checkbox"/>	<input checked="" type="checkbox"/>	<input checked="" type="checkbox"/>
Current setting $I_{g\text{DAS}+}$	With LSIG GFx option plug Residual: - Sizes 1 and 2: 100 ... 2000 A and - Size 3: 400 ... 2000 A Direct: 15 ... 2000 A		<input checked="" type="checkbox"/>	<input checked="" type="checkbox"/>	<input checked="" type="checkbox"/>	<input checked="" type="checkbox"/>	<input checked="" type="checkbox"/>
Tripping time $t_{g\text{DAS}+}$	0 ... 5 s		<input checked="" type="checkbox"/>	<input checked="" type="checkbox"/>	<input checked="" type="checkbox"/>	<input checked="" type="checkbox"/>	<input checked="" type="checkbox"/>
Options							
Parameter set changeover	Switchable between parameter set A and B		<input type="checkbox"/>	<input type="checkbox"/>	<input type="checkbox"/>	<input checked="" type="checkbox"/>	<input checked="" type="checkbox"/>
Limit values	Undershooting, overshooting		<input checked="" type="checkbox"/>	<input checked="" type="checkbox"/>	<input checked="" type="checkbox"/>	<input checked="" type="checkbox"/>	<input checked="" type="checkbox"/>
Waveform memory			<input type="checkbox"/>	<input type="checkbox"/>	<input type="checkbox"/>	<input type="checkbox"/>	<input checked="" type="checkbox"/>

- Available, feature of the application package
- Can be retrofitted

ETU600 electronic trip unit

Protective functions

1

			Current metering	ready4COM	PMF-I Energy efficiency	PMF-II Basic Power Monitoring	PMF-III Advanced Power Monitoring
ETU600 LSI							
Protective function	Variable setting range						
G: Ground fault GF alarm							
Alarm	Can be switched on/off		<input type="checkbox"/>	<input type="checkbox"/>	<input type="checkbox"/>	<input checked="" type="checkbox"/>	<input checked="" type="checkbox"/>
Current setting $I_{g \text{ alarm}}$ with LSI GFx option plug	Detection method Residual	Sizes 1 and 2: 100 ... 5000 A Size 3: 400 ... 5000 A	<input type="checkbox"/>	<input type="checkbox"/>	<input type="checkbox"/>	<input checked="" type="checkbox"/>	<input checked="" type="checkbox"/>
	Detection method Direct	15 ... 5000 A	<input type="checkbox"/>	<input type="checkbox"/>	<input type="checkbox"/>	<input checked="" type="checkbox"/>	<input checked="" type="checkbox"/>
Alarm time $t_{g \text{ alarm}}$	0 ... 0.5 s		<input type="checkbox"/>	<input type="checkbox"/>	<input type="checkbox"/>	<input checked="" type="checkbox"/>	<input checked="" type="checkbox"/>
<ul style="list-style-type: none"> <input checked="" type="checkbox"/> Available, feature of the application package <input type="checkbox"/> Can be retrofitted 							

			Current metering	ready4COM	PMF-I Energy efficiency	PMF-II Basic Power Monitoring	PMF-III Advanced Power Monitoring
ETU600 LSI G							
Protective function	Variable setting range						
G: Ground fault GF							
Tripping	Can be switched on/off		<input checked="" type="checkbox"/>	<input checked="" type="checkbox"/>	<input checked="" type="checkbox"/>	<input checked="" type="checkbox"/>	<input checked="" type="checkbox"/>
Method of ground fault detection	Residual	Detection of ground-fault current via summation current formation in all phases and the N conductor	<input checked="" type="checkbox"/>	<input checked="" type="checkbox"/>	<input checked="" type="checkbox"/>	<input checked="" type="checkbox"/>	<input checked="" type="checkbox"/>
	Direct	Direct metering of the ground-fault current with a current transformer	<input checked="" type="checkbox"/>	<input checked="" type="checkbox"/>	<input checked="" type="checkbox"/>	<input checked="" type="checkbox"/>	<input checked="" type="checkbox"/>
	Dual	Protection zone UREF: Detection of the ground-fault current by means of summation current formation, Protection zone REF: Measurement of the ground-fault current with an external current transformer	<input checked="" type="checkbox"/>	<input checked="" type="checkbox"/>	<input checked="" type="checkbox"/>	<input checked="" type="checkbox"/>	<input checked="" type="checkbox"/>
Characteristic GF curve	With LSI GFx option plug	For Fix $(I^0t) / I^2t / I^4t / I^6t$	<input checked="" type="checkbox"/>	<input checked="" type="checkbox"/>	<input checked="" type="checkbox"/>	<input checked="" type="checkbox"/>	<input checked="" type="checkbox"/>
Current setting I_g with LSI GFx option plug	Detection method Residual	Sizes 1 and 2: 100 ... 2000 A Size 3: 400 ... 2000 A	<input checked="" type="checkbox"/>	<input checked="" type="checkbox"/>	<input checked="" type="checkbox"/>	<input checked="" type="checkbox"/>	<input checked="" type="checkbox"/>
	Detection method Direct	15 ... 2000 A	<input checked="" type="checkbox"/>	<input checked="" type="checkbox"/>	<input checked="" type="checkbox"/>	<input checked="" type="checkbox"/>	<input checked="" type="checkbox"/>
Tripping time t_g	For Fix (I^0t)	0 ... 5 s	<input checked="" type="checkbox"/>	<input checked="" type="checkbox"/>	<input checked="" type="checkbox"/>	<input checked="" type="checkbox"/>	<input checked="" type="checkbox"/>
	For I^0t at $3 \times I_g$	0 ... 30 s	<input checked="" type="checkbox"/>	<input checked="" type="checkbox"/>	<input checked="" type="checkbox"/>	<input checked="" type="checkbox"/>	<input checked="" type="checkbox"/>
	$t_{g \text{ def}}$ at I^0t	0.05 ... 0.5 s	<input checked="" type="checkbox"/>	<input checked="" type="checkbox"/>	<input checked="" type="checkbox"/>	<input checked="" type="checkbox"/>	<input checked="" type="checkbox"/>
Intermittent detection	Can be switched on/off		<input checked="" type="checkbox"/>	<input checked="" type="checkbox"/>	<input checked="" type="checkbox"/>	<input checked="" type="checkbox"/>	<input checked="" type="checkbox"/>
G: Ground fault GF alarm							
Alarm	Can be switched on/off		<input checked="" type="checkbox"/>	<input checked="" type="checkbox"/>	<input checked="" type="checkbox"/>	<input checked="" type="checkbox"/>	<input checked="" type="checkbox"/>
Current setting $I_{g \text{ alarm}}$ with LSI GFx option plug	Detection method Residual	Sizes 1 and 2: 100 ... 5000 A Size 3: 400 ... 5000 A	<input checked="" type="checkbox"/>	<input checked="" type="checkbox"/>	<input checked="" type="checkbox"/>	<input checked="" type="checkbox"/>	<input checked="" type="checkbox"/>
	Detection method Direct	15 ... 5000 A	<input checked="" type="checkbox"/>	<input checked="" type="checkbox"/>	<input checked="" type="checkbox"/>	<input checked="" type="checkbox"/>	<input checked="" type="checkbox"/>
Alarm time $t_{g \text{ alarm}}$	0 ... 0.5 s		<input checked="" type="checkbox"/>	<input checked="" type="checkbox"/>	<input checked="" type="checkbox"/>	<input checked="" type="checkbox"/>	<input checked="" type="checkbox"/>
<ul style="list-style-type: none"> <input checked="" type="checkbox"/> Available, feature of the application package 							

			Current metering	ready4COM	PMF-I Energy efficiency	PMF-II Basic Power Monitoring	PMF-III Advanced Power Monitoring
ETU600 LSIG Hi-Z							
Protective function	Variable setting range						
G: Ground fault GF Hi-Z							
Tripping	Can be switched on/off		■	■	■	■	■
Method of ground fault detection	Residual	Detection of ground-fault current via summation current formation in all phases and the N conductor	■	■	■	■	■
	Dual Hi-Z, for high-impedance connection of the external current transformers	Protection zone UREF: Detection of the ground-fault current by means of summation current formation Protection zone REF: Measurement of the ground-fault current with an external current transformer combination	■	■	■	■	■
Characteristic GF curve	With LSIG GFx option plug	For Fix (I^0t)// I^2t // I^4t // I^6t	■	■	■	■	■
Current setting I_g with LSIG GFx option plug	Protection zone UREF	Size 2: 100 ... 2000 A and Size 3: 400 ... 2000 A	■	■	■	■	■
	Protection zone REF	15 ... 2000 A	■	■	■	■	■
Tripping time t_g	For Fix (I^0t)	0 ... 5 s	■	■	■	■	■
	For $I^0t \geq 3 \times I_g$ in protection zone UREF	0 ... 30 s	■	■	■	■	■
	$t_{g, def}$ at I^0t	0.05 ... 0.5 s	■	■	■	■	■
Intermittent detection	Can be switched on/off		■	■	■	■	■
G: Ground fault GF alarm							
Alarm	Can be switched on/off		■	■	■	■	■
Current setting $I_{g, alarm}$ with LSIG GFx option plug	Protection zone UREF	Size 2: 100 ... 5000 A and Size 3: 400 ... 5000 A	■	■	■	■	■
Alarm time $t_{g, alarm}$			■	■	■	■	■

■ Available, feature of the application package

ETU600 electronic trip unit

Operation, interfaces and metering function

ETU600		Current metering	ready4COM	PMF-I Energy efficiency	PMF-II Basic Power Monitoring	PMF-III Advanced Power Monitoring	Non-automatic air circuit breakers
Operation and interfaces							
Rotary switch		■	■	■	■	■	–
Display and operating keys		■	■	■	■	■	–
SETRON Powerconfig configuration software		■	■	■	■	■	–
Fieldbus communication		■	■	■	■	■	–
Color display		■	■	■	■	■	–
Bluetooth ¹⁾ and USB interface		■	■	■	■	■	–
Communication							
Prepared for connection of a communications module (ready4COM feature)	Status messages of the circuit breaker	□	■	■	■	■	□
	Status messages of the ETU600 electronic trip unit	□	■	■	■	■	–
	Remote operation, requires a communications module, closing coil, shunt trip	□	■	■	■	■	□
Communications module		□	□	□	□	□	□
Digital input and output on the ETU600 electronic trip unit							
Parameterizable input	For activating Maintenance mode DAS+ or can be used for parameter set changeover	■	■	■	■	■	–
Parameterizable output	Usable as "life contact", early trip contact, and for displaying "Parameter set B active" or "Maintenance mode DAS+ active"	■	■	■	■	■	–

¹⁾ A country-specific radio license is required to operate the Bluetooth interface. Before activating the Bluetooth function, ensure that the license is available: www.siemens.com/lowvoltage/certificates

- Not available
- Available, feature of the application package
- Can be retrofitted

		Current metering	ready4COM	PMF-I Energy efficiency	PMF-II Basic Power Monitoring	PMF-III Advanced Power Monitoring
ETU600						
Metering function						
Integrated voltage tap at top/bottom		–	–	■	■	■
Voltage tap module VTM		–	–	■	■	■
Type acc. to IEC 61557-12	PMF-I	–	–	■	■	■
	PMF-II	–	–	–	■	■
	PMF-III	–	–	–	–	■
Metering values						
Temperature		–	■	■	■	■
Accuracy according to IEC 61557-12						
Phase current I_{L1}, I_{L2}, I_{L3}	Class 1	■	■	■	■	■
Neutral conductor current I_N	Class 1	■	■	■	■	■
Voltage U_{LN}	Class 0.5	–	–	■	■	■
Voltage U_{LL}	Class 0.5	–	–	■	■	■
Active energy E_a	Class 2	–	–	■	■	■
Active power P	Class 2	–	–	–	■	■
Accuracy according to manufacturer's specifications						
Ground-fault current I_g with ETU600 LSI	2%	–	–	–	■	■
Ground-fault current I_g with ETU600 LSIG, ETU600 LSIG Hi-Z	2%	■	■	■	■	■
Reactive energy E_r	2%	–	–	–	■	■
Apparent energy E_{ap}	2%	–	–	–	■	■
Reactive power Q	2%	–	–	–	■	■
Apparent power S	2%	–	–	–	■	■
Power factor PF	6%	–	–	–	■	■
$\cos \varphi$	6%	–	–	–	■	■
Frequency f	0.5%	–	–	–	■	■
Current unbalance	2.5%	–	–	–	■	■
Voltage unbalance	1.5%	–	–	–	■	■
Total harmonic distortion $THD-I^{1)}$	2%	–	–	–	–	■
Total harmonic distortion $THD-U^{1)}$	2%	–	–	–	–	■
Harmonic $I, U^{1)}$	2%	–	–	–	–	■

¹⁾ For 2nd to 15th harmonic $\pm 2\%$ and for 16th to 31st harmonic $\pm 5\%$

- Available, feature of the application package
- Not available

1

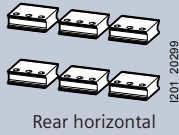
Connection

Main circuit connection

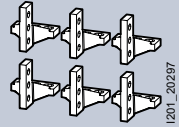
3WA11 – 3WA13

Fixed-mounted

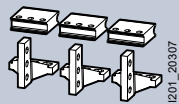
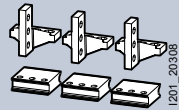
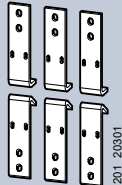
Withdrawable



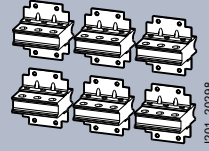
Rear horizontal



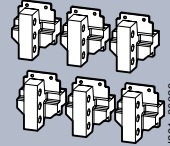
Rear vertical

Horizontal on top,
vertical at the bottomVertical on top,
horizontal at the bottom

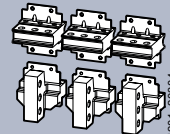
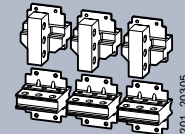
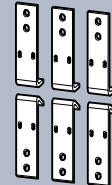
Front connection with double hole



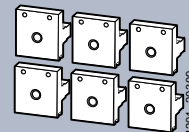
Rear horizontal



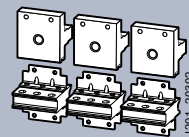
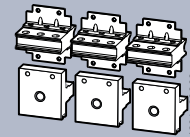
Rear vertical

Horizontal on top,
vertical at the bottomVertical on top,
horizontal at the bottom

Front connection with double hole



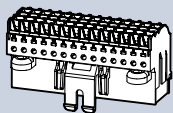
Flange

Flange on top and
horizontal at bottomFlange on bottom and
horizontal at top

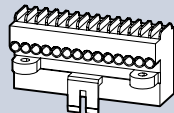
Secondary disconnect terminal

The auxiliary and control cables are connected at the manual connectors using the push-in technology of the auxiliary conductor connections of the circuit breaker.

Coding pins on the manual connectors prevent them being inserted in the wrong slots.



Screwless connection (push in)



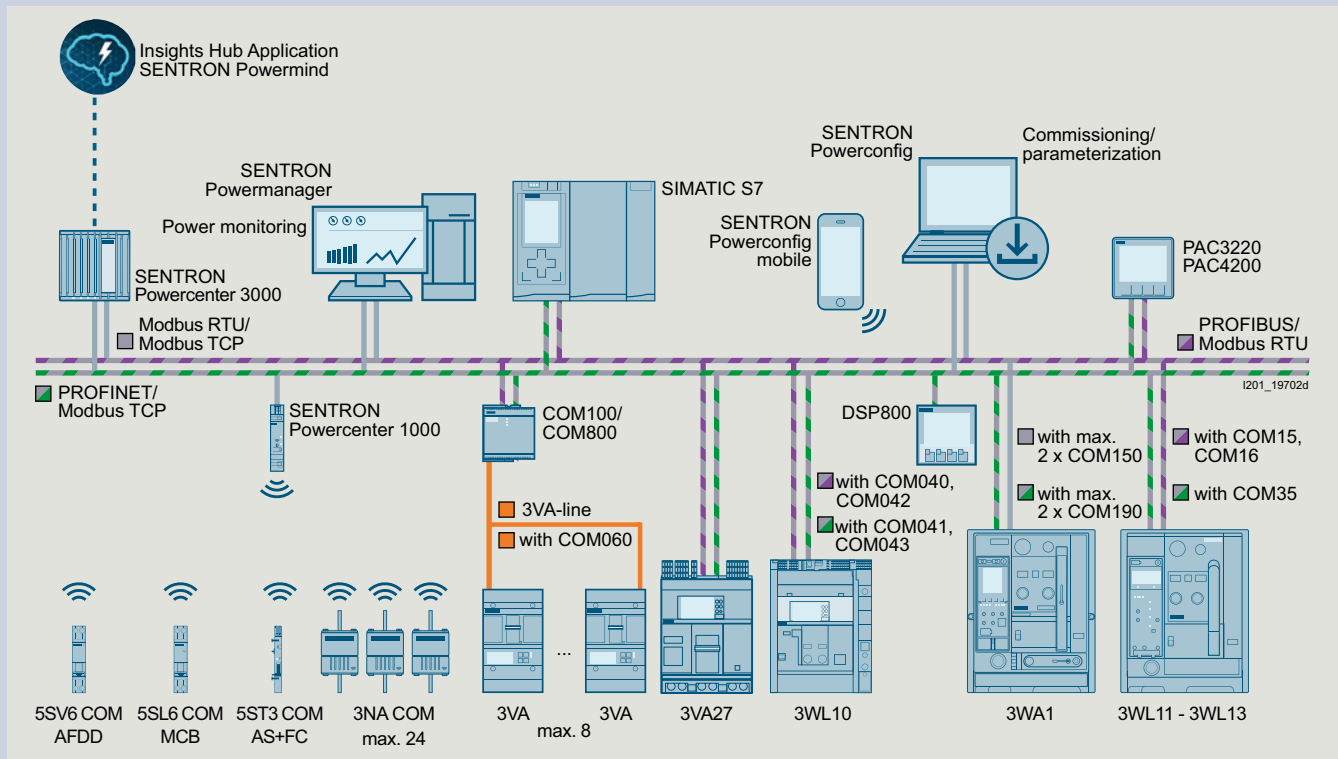
Screw connection (optional)

For size 1, up to 4 secondary disconnect terminal blocks are possible; for sizes 2 and 3, up to 5 secondary disconnect terminal blocks are possible

- Circuit breakers and non-automatic circuit breakers with secondary disconnect terminal blocks are supplied from the factory:
 - Non-automatic circuit breakers with 3 blocks
 - Non-automatic circuit breakers with ready4COM feature with 4 blocks
 - Circuit breakers with ETU600 LSI or LSIG with 4 blocks
 - Circuit breakers with ETU600 LSIG-HiZ with 5 blocks
 - Circuit breakers with ETU300 LSI/LSIG with 4 blocks

For dimension drawings, see Equipment Manual – 3WA1 air circuit breakers www.siemens.com/lowvoltage/manuals (109763061)

Communication



The 3WA can be equipped with up to two PROFINET IO/Modbus TCP COM190 communications modules or Modbus RTU COM150 and up to five IOM230 digital input/output modules.

For the optional communications interface with the COM190 or COM150 communications module, a circuit breaker with the "ready4COM" feature must be selected as the circuit breaker/non-automatic air circuit breaker. The first COM190 or COM150 communications module must be selected via a Z option. If you want to use a further COM190 or COM150 communications module, this must be ordered separately as an accessory. Both COM190 or COM150 communications modules can be run in parallel.

The first IOM230 digital input/output module can be selected via a Z option.

The up to four further digital input/output modules must be ordered separately as accessories.

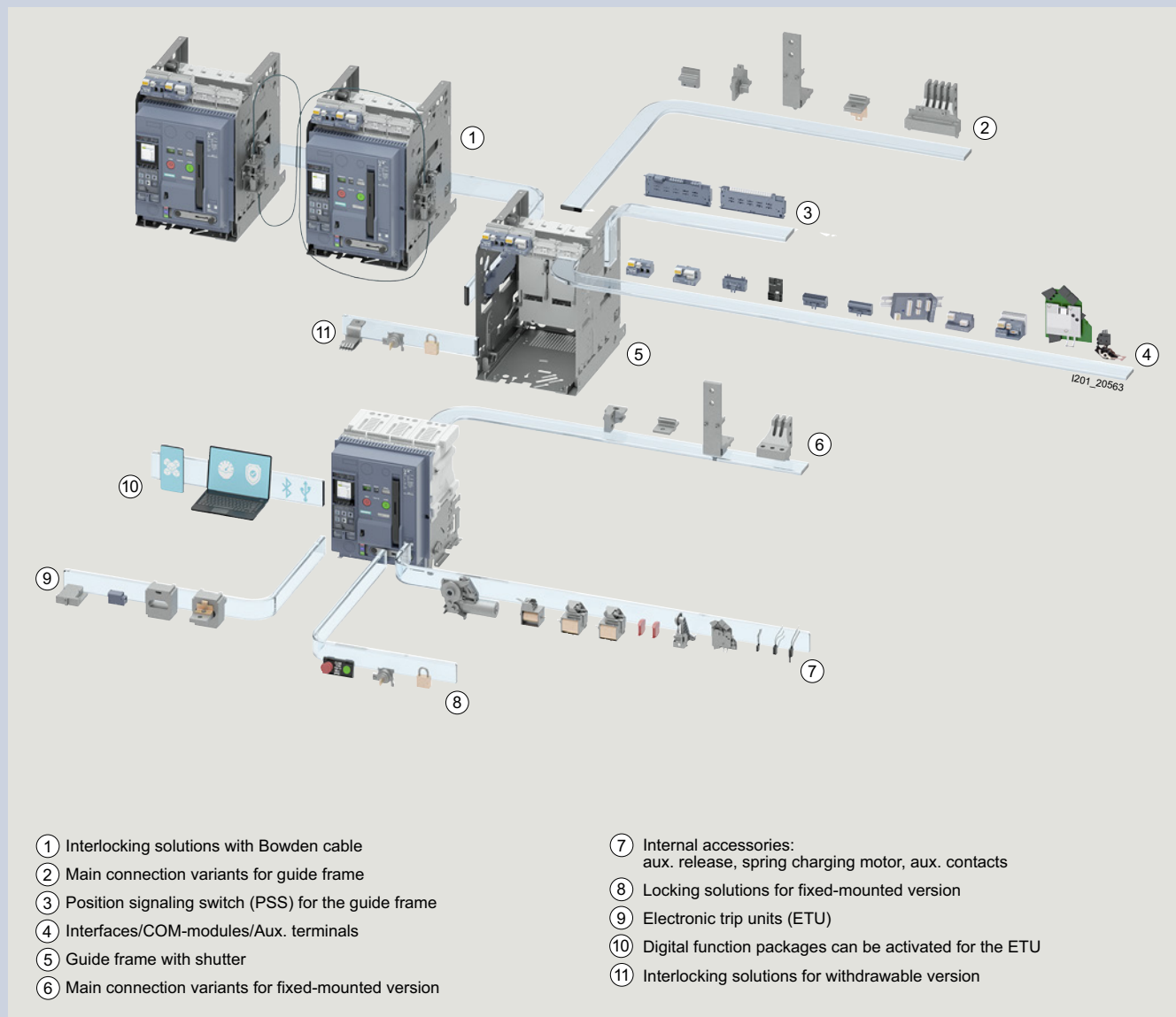
You will find further information on the COM190 in the Equipment Manual – 3WA1 air circuit breakers www.siemens.com/lowvoltage/manuals (109763061)

3WA11 – 3WA13 system overview

Circuit breakers and non-automatic circuit breakers for AC and DC

For a complete and valid configuration of your air circuit breaker, please use our online configurator at www.siemens.com/lowvoltage/3wa-configurator

1



- ① Interlocking solutions with Bowden cable
- ② Main connection variants for guide frame
- ③ Position signaling switch (PSS) for the guide frame
- ④ Interfaces/COM-modules/Aux. terminals
- ⑤ Guide frame with shutter
- ⑥ Main connection variants for fixed-mounted version

- ⑦ Internal accessories:
aux. release, spring charging motor, aux. contacts
- ⑧ Locking solutions for fixed-mounted version
- ⑨ Electronic trip units (ETU)
- ⑩ Digital function packages can be activated for the ETU
- ⑪ Interlocking solutions for withdrawable version

Online configurator highlights

www.siemens.com/lowvoltage/3wa-configurator

Graphical display

- Integration of the legend as a color system
 - Orange: still to be selected
 - Petrol: already selected
 - Gray: preselected (default)
- Graphical highlighting of the individual configuration steps: "What you see is what you get"

SIEMENS Log In Support Language X

3WA Configurator FW1...AC...AA02R01

Configuration is not yet complete

Please insert 3WA Ordernumber

3WA Configurator

- Monitoring the spring mechanism
 - with motorized operating mechanism
- Supply voltage of the motor drive
 - 110-127 VAC / 110-125 VDC
 - 200-240 VAC / 230-250 VDC
 - 24-30 VDC
- Number of auxiliary switches ON / OFF
 - 2 NC + 2 NO
- Closing coil and remote trip alarm reset coil
 - Design of switch-on solenoid CC
 - without
 - Supply voltage of the closing coil
 - without
 - Remote reset magnet for trip signaling
 - No
- 1st Auxiliary switch
 - Type of the 1st voltage release ST
 - without
 - Supply voltage of the 1st voltage release
 - without

Legend:

- Basic configuration
- Main connection
- Electronic trip unit and measurement function
- Switch mechanism and auxiliary switch
 - Closing coil and remote trip alarm reset coil
 - 1st Auxiliary switch
 - 2nd Auxiliary switch
 - Electronic accessories
 - Auxiliary current accessories
 - Locking accessories
 - Miscellaneous accessories
 - Not assigned

CAD-AREA

Price On request

Splitting function (Frame and circuit breaker can be ordered separately)

Configuration result

Configuration result

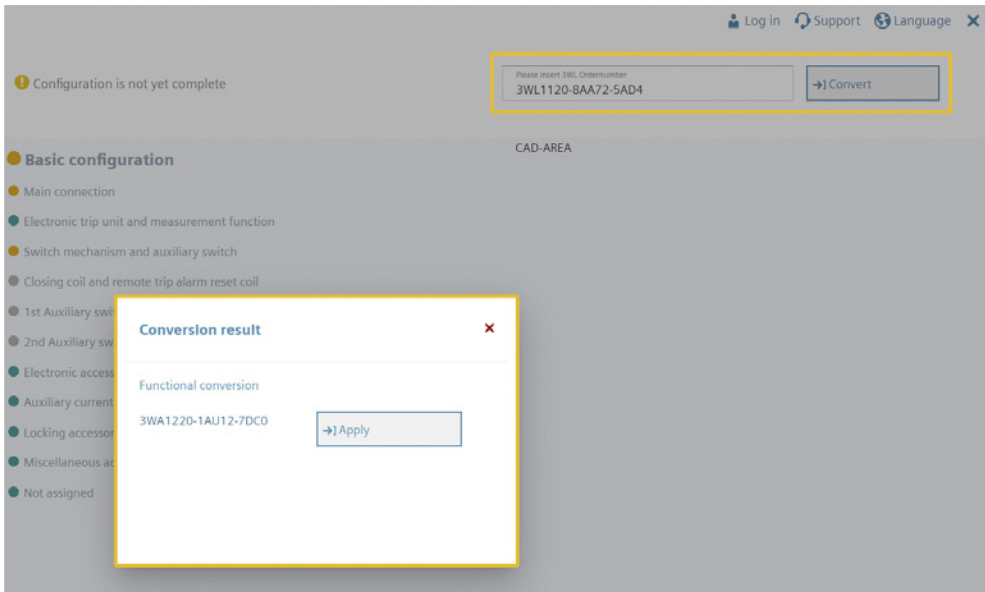
Split the configuration

3WA Circuit breaker
3WA1225-5AE60-0AA0

3WA frame
3WA8225-5AA32-1BC1

- Closing coil and remote trip alarm reset coil
- 1st Auxiliary switch
- 2nd Auxiliary switch
- Electronic accessories
- Auxiliary current accessories
- Locking accessories
- Miscellaneous accessories
- Not assigned
- Configuration result**

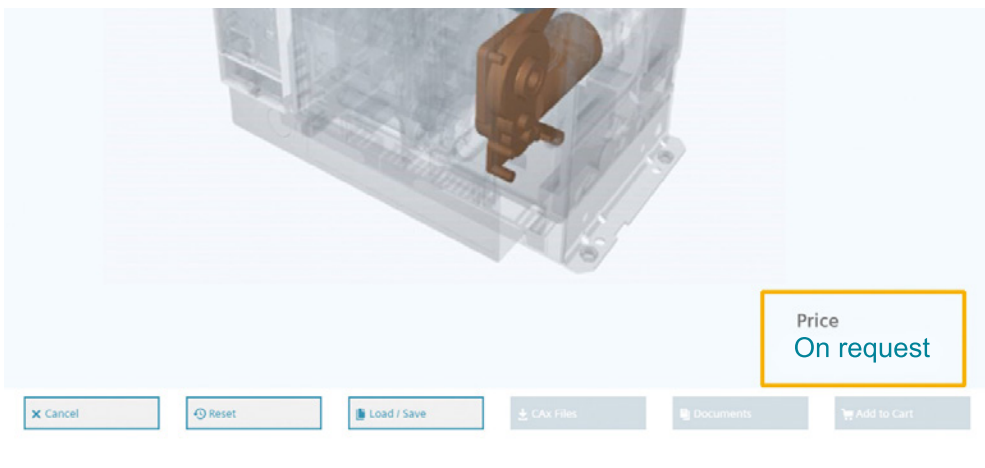
Direct conversion of a 3WL article number to a 3WA article number in the configurator



Responsive design (adapted to the differing requirements of the displaying devices)



Dynamic customer price during configuration



Structure of the article numbers

Basic configuration for AC circuit breakers and AC non-automatic circuit breakers up to 690 V

The structure shown below is intended as an overview of each position and its meaning. For a complete and valid configuration of your air circuit breaker, please use our online configurator at www.siemens.com/lowvoltage/3wa-configurator

				5	6	7	8	9	10	11	12	13	14	15	16
3WA1							-					-			
Circuit breakers and non-automatic circuit breakers															
Size (SZ)	1			1											
	2			2											
	3			3											
		SZ 1	SZ 2	SZ 3											
Max. rated current	630 A	■	-	-		0	6								
$I_{n\ max}$	800 A	■	-	-		0	8								
	1000 A	■	-	-		1	0								
	1250 A	■	-	-		1	2								
	1600 A	■	-	-		1	6								
	2000 A	■	■	-		2	0								
	2500 A	■	■	-		2	5								
	3200 A	-	■	-		3	2								
	4000 A	-	■ ¹⁾	■		4	0								
	5000 A	-	-	■		5	0								
	6300 A	-	-	■		6	3								
Short-circuit breaking capacity	N	■	-	-	55/42 kA		2								
I_{cu} at 500/690 V	S	■	■	-	66/50 kA		3								
	M	■	■	-	85/66 kA		4								
	H	-	■	■	100/85 kA		5								
	C	-	■	-	130/100 kA		6								
		-	-	■	3-pole: 150/150 kA 4-pole: 130/130 kA		6								
Non-automatic circuit breakers										A	A				
Non-automatic circuit breakers, ready4COM feature										C	A				
Application packages with protective and metering functions for circuit breakers	ETU300 electronic trip unit	Protective function	LSI			A	B								
			LSIG			A	C								
	ETU600 electronic trip unit	Current metering				A									
		Current metering, ready4COM feature				C									
	ETU600 electronic trip unit with metering function, internal voltage tap in the circuit breaker, power supply of the ETU600 via the VTM680 voltage tap module and ready4COM	PMF-I	Voltage tap on top			L									
		Energy efficiency	Voltage tap on bottom			E									
		PMF-II Basic Power Monitoring	Voltage tap on top			M									
			Voltage tap on bottom			F									
		PMF-III Advanced Power Monitoring	Voltage tap on top			N									
			Voltage tap on bottom			G									
	Protective functions	■	■	■	LSI		E								
		■	■	■	LSIG		F								
		-	■	■	LSIG Hi-Z		G								
Number of poles	Fixed-mounted				3-pole		0								
					4-pole, Neutral left		1								
	Withdrawable					3-pole		3							
						4-pole, Neutral left		4							
						3-pole		6							
						4-pole, Neutral left		7							

¹⁾ Not available for breaking capacity C

²⁾ Position signaling switch for circuit breakers/non-automatic circuit breakers without ready4COM: 3 × connected position, 2 × test position, 1 × disconnected position; Position signaling switch for circuit breakers/non-automatic circuit breakers with ready4COM: 1 × connected position, 1 × test position, 1 × disconnected position + message through communications interface for disconnected position and for "not available"

		3WA1																			
		5	6	7	8	9	10	11	12	13	14	15	16								
Connection		SZ 1	SZ 2	SZ 3																	
Type of mounting	Fixed-mounted	■	■ ¹⁾	■	Vertical													1			
		■	■ ³⁾	■ ⁴⁾	Horizontal													2			
		■ ²⁾	■ ⁵⁾	■ ⁶⁾	Front													3			
		■	■ ³⁾	■ ⁴⁾	Vertical on top/horizontal at the bottom													5			
		■	■ ³⁾	■ ⁴⁾	Horizontal on top/vertical at the bottom													6			
	Withdrawable	■	■	■	Without guide frame													0			
		■	■ ¹⁾	■	Vertical													1			
		■ ²⁾	■ ³⁾	■ ⁴⁾	Horizontal													2			
		■ ²⁾	■ ⁵⁾	■ ⁶⁾	Front													3			
		■ ²⁾	■ ⁵⁾	■ ⁶⁾	Flange													4			
		■ ²⁾	■ ³⁾	■ ⁴⁾	Vertical on top/horizontal at the bottom													5			
		■ ²⁾	■ ³⁾	■ ⁴⁾	Horizontal on top/vertical at the bottom													6			
		■ ²⁾	■ ⁵⁾	■ ⁶⁾	Flange on top/horizontal at the bottom													7			
		■ ²⁾	■ ⁵⁾	■ ⁶⁾	Horizontal on top/flange at the bottom													8			

¹⁾ The 4000 A vertical connections for the 3WA1 have different dimensions from the 3WL1. Dimensionally compatible connections can be ordered with the additional Z option D01.

²⁾ Not available for 2500 A

³⁾ Not available for 4000 A

⁴⁾ Not available for 6300 A

⁵⁾ Not available for 4000 A and for breaking capacity C

⁶⁾ Not available for 5000 A and 6300 A and for breaking capacity C

Structure of the article numbers

Basic configuration for AC circuit breakers and AC non-automatic circuit breakers up to 690 V

The structure shown below is intended as an overview of each position and its meaning.
For a complete and valid configuration of your air circuit breaker, please use our online configurator at www.siemens.com/lowvoltage/3wa-configurator

1

3WA1 5 6 7 8 – 9 10 11 12 – 13 14 15 16

Operating mechanisms, auxiliary switches and auxiliary releases

Operating mechanism and auxiliary switch	Manual recharging of the stored energy mechanism	Without spring charging motor	2 NO, 2 NC	0	
			4 NO, 4 NC	1	
	Recharging of the stored energy mechanism by spring charging motor (M)	24 ... 30 V DC		2 NO, 2 NC	2
				4 NO, 4 NC	5
		48 ... 60 V DC		4 NO, 4 NC	6
				2 NO, 2 NC	3
		110 ... 127 V AC/ 110 ... 125 V DC		4 NO, 4 NC	7
		208 ... 240 V AC/ 220 ... 250 V DC		2 NO, 2 NC	4
		4 NO, 4 NC	8		
Closing coil and remote trip alarm reset coil ¹⁾²⁾	Without closing coil	Without remote trip alarm reset coil		A	
				B	
	With closing coil (CC/CC-COM) ³⁾ for uninterrupted duty, 100% OP	Without remote trip alarm reset coil	24 ... 30 V DC	C	
			48 ... 60 V DC	D	
			110 ... 127 V AC/110 ... 125 V DC 208 ... 240 V AC/220 ... 250 V DC	E	
		With remote trip alarm reset coil (RR) for momentary duty 1% OP	24 ... 30 V DC	F	
			48 ... 60 V DC	G	
			110 ... 127 V AC/110 ... 125 V DC 208 ... 240 V AC/220 ... 250 V DC	H	
	With closing coil (CC) for momentary duty, 5% OP	Without remote trip alarm reset coil	24 ... 30 V DC	J	
			48 ... 60 V DC	K	
			110 ... 127 V AC/110 ... 125 V DC 208 ... 240 V AC/220 ... 250 V DC	L	
		With remote trip alarm reset coil (RR) for momentary duty 1% OP	24 ... 30 V DC	M	
48 ... 60 V DC			N		
110 ... 127 V AC/110 ... 125 V DC 208 ... 240 V AC/220 ... 250 V DC			P		
2nd auxiliary release	Without 2nd auxiliary release		Q		
			R		
	With shunt trip (ST), uninterrupted duty 100% OP	24 ... 30 V DC	S		
		48 ... 60 V DC	T		
		110 ... 127 V AC/110 ... 125 V DC 208 ... 240 V AC/220 ... 250 V DC	U		
			V		
	With shunt trip (ST), momentary duty 5% OP	24 ... 30 V DC	W		
		48 ... 60 V DC			
		110 ... 127 V AC/110 ... 125 V DC 208 ... 240 V AC/220 ... 250 V DC			
	With undervoltage release (UVR) ⁴⁾ , instantaneous (≤ 0.08 s) and short-time delayed (≤ 0.2 s)	24 ... 30 V DC			
		48 ... 60 V DC			
110 ... 127 V AC/110 ... 125 V DC 208 ... 240 V AC/220 ... 250 V DC					
380 ... 415 V AC					
With undervoltage release (UVR-t), adjustable delay 0.2 ... 3.2 s	48 V DC				
	60 V DC				
	110 ... 127 V AC/110 ... 125 V DC 208 ... 240 V AC/220 ... 250 V DC				
	380 ... 415 V AC				

¹⁾ Remote trip alarm reset coil is not available for non-automatic circuit breakers

²⁾ When using the remote trip alarm reset coil, the reclosing lockout is generally deactivated. The circuit breaker can be closed again immediately if the conditions for closing are fulfilled.

³⁾ If the ready4COM feature is provided, the communication-capable closing coils (CC-COM) and/or shunt trips (ST-COM) are installed at the factory.

⁴⁾ UVR instantaneous for 30 V DC and 60 V DC can only be supplied separately. Please order: for 30 V DC 3WL9111-0AE02-0AA0; for 60 V DC 3WL9111-0AE07-0AA0.

3WA1

5	6	7	8	–	9	10	11	12	–	13	14	15	16
---	---	---	---	---	---	----	----	----	---	----	----	----	----

Auxiliary releases

1st auxiliary release	Without 1st auxiliary release		0
	With shunt trip (ST/ST-COM) ¹⁾ , uninterrupted duty 100% OP	24 ... 30 V DC	1
		48 ... 60 V DC	2
		110 ... 127 V AC/110 ... 125 V DC	3
		208 ... 240 V AC/220 ... 250 V DC	4
	With shunt trip (ST), momentary duty 5% OP	24 ... 30 V DC	5
		48 ... 60 V DC	6
		110 ... 127 V AC/110 ... 125 V DC	7
208 ... 240 V AC/220 ... 250 V DC		8	

¹⁾ If the ready4COM feature is provided, the communication-capable closing coils (CC-COM) and/or shunt trips (ST-COM) are installed at the factory.

Structure of the article numbers

Basic configuration for AC circuit breakers and AC non-automatic circuit breakers in a 690 V IT system and for 1000 V

The structure shown below is intended as an overview of each position and its meaning.

For a complete and valid configuration of your air circuit breaker, please use our online configurator at www.siemens.com/lowvoltage/3wa-configurator

		5	6	7	8	9	10	11	12	13	14	15	16
3WA1		■	■	■	–	■	■	■	■	–	■	■	■
Circuit breakers and non-automatic circuit breakers													
Size (SZ)	1	1											
	2	2											
	3	3											
		SZ 1	SZ 2	SZ 3									
Max. rated current $I_{n \max}$	630 A	■	–	–	0	6							
	800 A	■	–	–	0	8							
	1000 A	■	–	–	1	0							
	1250 A	■	–	–	1	2							
	1600 A	■	–	–	1	6							
	2000 A	■	■	–	2	0							
	2500 A	■	■	–	2	5							
	3200 A	–	■	–	3	2							
	4000 A	–	■	■	4	0							
	5000 A	–	–	■	5	0							
	6300 A	–	–	■	6	3							
Short-circuit breaking capacity I_{cu} at 690 V/1000 V	E	■	–	–	85/50 kA/–	8							
		–	■	–	85/85/50 kA	8							
		–	–	■	3-pole: 150/125/70 kA 4-pole: 130/125/70 kA	8							
Non-automatic circuit breakers								A	A				
Non-automatic circuit breakers, ready4COM feature								C	A				
Application packages with protective and metering functions for circuit breakers	ETU300 electronic trip unit ¹⁾	Protective function	LSI			A	B						
			LSIG			A	C						
	ETU600 electronic trip unit	Current metering				A							
		Current metering, ready4COM feature				C							
	ETU600 electronic trip unit with metering function, internal voltage tap in the circuit breaker, VTM640 voltage tap module and ready4COM	PMF-I	Voltage tap on top			U							
		Energy efficiency	Voltage tap on bottom			Q							
		PMF-II Basic Power Monitoring	Voltage tap on top			V							
		Monitoring	Voltage tap on bottom			R							
		PMF-III Advanced Power Monitoring	Voltage tap on top			W							
			Voltage tap on bottom			S							
Protective functions	■	■	■	LSI			E						
	■	■	■	LSIG			F						
	–	■	■	LSIG Hi-Z			G						
Number of poles	Fixed-mounted				3-pole		0						
					4-pole, Neutral left		1						
	Withdrawable				3-pole		3						
		Without position signaling switch			4-pole, Neutral left		4						
		With position signaling switch ¹⁾			3-pole		6						
					4-pole, Neutral left		7						

¹⁾ Position signaling switch for circuit breakers/non-automatic circuit breakers without ready4COM:

3 × connected position, 2 × test position, 1 × disconnected position;

Position signaling switch for circuit breakers/non-automatic circuit breakers with ready4COM:

1 × connected position, 1 × test position, 1 × disconnected position + message through communications interface for disconnected position and for "not available".

3WA1



Connection

		SZ 1	SZ 2	SZ 3		
Type of mounting	Fixed-mounted	<input type="checkbox"/>	<input type="checkbox"/>	<input type="checkbox"/>	Vertical	1
		<input type="checkbox"/>	<input type="checkbox"/>	<input type="checkbox"/>	Horizontal	2
		<input type="checkbox"/>	<input type="checkbox"/>	<input type="checkbox"/>	Front double hole	3
		<input type="checkbox"/>	<input type="checkbox"/>	<input type="checkbox"/>	Vertical on top/horizontal at the bottom	5
		<input type="checkbox"/>	<input type="checkbox"/>	<input type="checkbox"/>	Horizontal on top/vertical at the bottom	6
		<input type="checkbox"/>	<input type="checkbox"/>	<input type="checkbox"/>	Without guide frame	0
	Withdrawable	<input type="checkbox"/>	<input type="checkbox"/>	<input type="checkbox"/>	Vertical	1
		<input type="checkbox"/>	<input type="checkbox"/>	<input type="checkbox"/>	Horizontal	2
		<input type="checkbox"/>	<input type="checkbox"/>	<input type="checkbox"/>	Front double hole	3
		<input type="checkbox"/>	<input type="checkbox"/>	<input type="checkbox"/>	Flange	4
		<input type="checkbox"/>	<input type="checkbox"/>	<input type="checkbox"/>	Vertical on top/horizontal at the bottom	5
		<input type="checkbox"/>	<input type="checkbox"/>	<input type="checkbox"/>	Horizontal on top/vertical at the bottom	6
		<input type="checkbox"/>	<input type="checkbox"/>	<input type="checkbox"/>	Flange on top/horizontal at the bottom	7
		<input type="checkbox"/>	<input type="checkbox"/>	<input type="checkbox"/>	Horizontal on top/flange at the bottom	8

¹⁾ Only ≤ 2000 A is available for size 1

²⁾ Only ≤ 3200 A is available for size 2

³⁾ Vertical connection for 3WA size 2 for 4000 A has different dimensions than for the 3WL.

With Z option D01, vertical connection can be changed to the connection compatible with 3WL.

⁴⁾ Only ≤ 5000 A is available for size 3

⁵⁾ For size 3, only 4000 A applicable at a short-circuit current of up to 100 kA

Structure of the article numbers

Basic configuration for AC circuit breakers and AC non-automatic circuit breakers in a 690 V IT system and for 1000 V

The structure shown below is intended as an overview of each position and its meaning. For a complete and valid configuration of your air circuit breaker, please use our online configurator at www.siemens.com/lowvoltage/3wa-configurator

1

3WA1



Operating mechanisms, auxiliary switches and auxiliary releases

Operating mechanism and auxiliary switch	Manual recharging of the stored energy mechanism	Without spring charging motor	2 NO, 2 NC	0	
			4 NO, 4 NC	1	
	Recharging of the stored energy mechanism by spring charging motor (M)	24 ... 30 V DC		2 NO, 2 NC	2
				4 NO, 4 NC	5
		48 ... 60 V DC		4 NO, 4 NC	6
				2 NO, 2 NC	3
		110 ... 127 V AC/ 110 ... 125 V DC		4 NO, 4 NC	7
				2 NO, 2 NC	4
208 ... 240 V AC/ 220 ... 250 V DC		4 NO, 4 NC	8		
Closing coil and remote trip alarm reset coil¹⁾	Without closing coil	Without remote trip alarm reset coil		A	
	With closing coil (CC/CC-COM) ²⁾ for uninterrupted duty, 100% OP	Without remote trip alarm reset coil	24 ... 30 V DC	B	
			48 ... 60 V DC	C	
			110 ... 127 V AC/110 ... 125 V DC	D	
			208 ... 240 V AC/220 ... 250 V DC	E	
		With remote trip alarm reset coil (RR) for momentary duty 1% OP	24 ... 30 V DC	F	
			48 ... 60 V DC	G	
			110 ... 127 V AC/110 ... 125 V DC	H	
			208 ... 240 V AC/220 ... 250 V DC	J	
			24 ... 30 V DC	K	
			48 ... 60 V DC	L	
	With closing coil (CC) for momentary duty, 5% OP	Without remote trip alarm reset coil	110 ... 127 V AC/110 ... 125 V DC	M	
			208 ... 240 V AC/220 ... 250 V DC	N	
			24 ... 30 V DC	P	
			48 ... 60 V DC	Q	
With remote trip alarm reset coil (RR) for momentary duty 1% OP		110 ... 127 V AC/110 ... 125 V DC	R		
		208 ... 240 V AC/220 ... 250 V DC	S		
2nd auxiliary release	Without 2nd auxiliary release		A		
		With shunt trip (ST), uninterrupted duty 100% OP	24 ... 30 V DC	B	
			48 ... 60 V DC	C	
			110 ... 127 V AC/110 ... 125 V DC	D	
	208 ... 240 V AC/220 ... 250 V DC		E		
	With shunt trip (ST), momentary duty 5% OP	24 ... 30 V DC	F		
		48 ... 60 V DC	G		
		110 ... 127 V AC/110 ... 125 V DC	H		
		208 ... 240 V AC/220 ... 250 V DC	J		
	With undervoltage release (UVR) ³⁾ , instantaneous (≤ 0.08 s) and short-time delayed (≤ 0.2 s)	24 ... 30 V DC	L		
		48 ... 60 V DC	N		
		110 ... 127 V AC/110 ... 125 V DC	P		
		208 ... 240 V AC/220 ... 250 V DC	Q		
		380 ... 415 V AC	R		
	With undervoltage release (UVR-t), adjustable delay 0.2 ... 3.2 s	48 V DC	S		
		60 V DC	T		
		110 ... 127 V AC/110 ... 125 V DC	U		
		208 ... 240 V AC/220 ... 250 V DC	V		
		380 ... 415 V AC	W		

¹⁾ Remote trip alarm reset coil is not available for non-automatic circuit breakers

²⁾ If the ready4COM feature is provided, the communication-capable closing coils (CC-COM) and/or shunt trips (ST-COM) are installed at the factory.

³⁾ UVR instantaneous for 30 V DC and 60 V DC can only be supplied separately. Please order: for 30 V DC 3WL9111-0AE02-0AA0; for 60 V DC 3WL9111-0AE07-0AA0.

3WA1

5	6	7	8	9	10	11	12	13	14	15	16	
■	■	■	■	–	■	■	■	–	■	■	■	■

Auxiliary releases

1st auxiliary release	Without 1st auxiliary release		0
	With shunt trip (ST/ST-COM) ¹⁾ , uninterrupted duty 100% OP	24 ... 30 V DC	1
		48 ... 60 V DC	2
		110 ... 127 V AC/110 ... 125 V DC	3
		208 ... 240 V AC/220 ... 250 V DC	4
	With shunt trip (ST), momentary duty 5% OP	24 ... 30 V DC	5
		48 ... 60 V DC	6
		110 ... 127 V AC/110 ... 125 V DC	7
	208 ... 240 V AC/220 ... 250 V DC	8	

¹⁾ If the ready4COM feature is provided, the communication-capable closing coils (CC-COM) and/or shunt trips (ST-COM) are installed at the factory.

3WA1



Connection

		SZ 2	SZ 3		
Type of mounting	Fixed-mounted	■ ²⁾ ■	■	Vertical	1
		■ ¹⁾ ■ ³⁾	■	Horizontal	2
		■ ¹⁾ ■ ⁴⁾	■	Front double hole	3
		■ ¹⁾ ■ ³⁾	■	Vertical on top/horizontal at the bottom	5
		■ ¹⁾ ■ ³⁾	■	Horizontal on top/vertical at the bottom	6
		■	■	Without guide frame	0
	Withdrawable	■ ²⁾ ■	■	Vertical	1
		■ ¹⁾ ■ ³⁾	■	Horizontal	2
		■ ¹⁾ ■ ⁴⁾	■	Front double hole	3
		■ ¹⁾ ■ ⁴⁾	■	Flange	4
		■ ¹⁾ ■ ³⁾	■	Vertical on top/horizontal at the bottom	5
		■ ¹⁾ ■ ³⁾	■	Horizontal on top/vertical at the bottom	6
		■ ¹⁾ ■ ⁴⁾	■	Flange on top/horizontal at the bottom	7
		■ ¹⁾ ■ ⁴⁾	■	Horizontal on top/flange at the bottom	8

¹⁾ Only ≤ 3200 A is available for size 2

²⁾ Vertical connection for 3WA size 2 for 4000 A has different dimensions than for the 3WL.

With Z option D01, vertical connection can be changed to the connection compatible with 3WL.

³⁾ Only ≤ 5000 A is available for size 3

⁴⁾ For size 3, only 4000 A applicable at a short-circuit current of up to 100 kA

Structure of the article numbers

Basic configuration for AC circuit breakers and AC non-automatic circuit breakers for 1150V

The structure shown below is intended as an overview of each position and its meaning.
For a complete and valid configuration of your air circuit breaker, please use our online configurator at www.siemens.com/lowvoltage/3wa-configurator

1

3WA1

5 6 7 8 – 9 10 11 12 – 13 14 15 16

Operating mechanisms, auxiliary switches and auxiliary releases

Operating mechanism and auxiliary switch	Manual recharging of the stored energy mechanism	Without spring charging motor	2 NO, 2 NC	0	
			4 NO, 4 NC	1	
	Recharging of the stored energy mechanism by spring charging motor (M)	24 ... 30 V DC		2 NO, 2 NC	2
				4 NO, 4 NC	5
		48 ... 60 V DC		4 NO, 4 NC	6
				2 NO, 2 NC	3
		110 ... 127 V AC/ 110 ... 125 V DC		4 NO, 4 NC	7
				2 NO, 2 NC	4
		208 ... 240 V AC/ 220 ... 250 V DC		4 NO, 4 NC	8
Closing coil and remote trip alarm reset coil¹⁾	Without closing coil	Without remote trip alarm reset coil		A	
				B	
	With closing coil (CC/CC-COM) ²⁾ for uninterrupted duty, 100% OP	Without remote trip alarm reset coil	24 ... 30 V DC	C	
			48 ... 60 V DC	D	
			110 ... 127 V AC/110 ... 125 V DC	E	
			208 ... 240 V AC/220 ... 250 V DC	F	
		With remote trip alarm reset coil (RR) for momentary duty 1% OP	24 ... 30 V DC	G	
			48 ... 60 V DC	H	
			110 ... 127 V AC/110 ... 125 V DC	J	
			208 ... 240 V AC/220 ... 250 V DC	K	
	With closing coil (CC) for momentary duty, 5% OP	Without remote trip alarm reset coil	24 ... 30 V DC	L	
			48 ... 60 V DC	M	
			110 ... 127 V AC/110 ... 125 V DC	N	
		With remote trip alarm reset coil (RR) for momentary duty 1% OP	208 ... 240 V AC/220 ... 250 V DC	P	
			24 ... 30 V DC	Q	
48 ... 60 V DC			R		
110 ... 127 V AC/110 ... 125 V DC			S		
2nd auxiliary release	Without 2nd auxiliary release		A		
			B		
	With shunt trip (ST), uninterrupted duty 100% OP	24 ... 30 V DC	48 ... 60 V DC	C	
			110 ... 127 V AC/110 ... 125 V DC	D	
			208 ... 240 V AC/220 ... 250 V DC	E	
		24 ... 30 V DC	48 ... 60 V DC	F	
			110 ... 127 V AC/110 ... 125 V DC	G	
			208 ... 240 V AC/220 ... 250 V DC	H	
	With shunt trip (ST), momentary duty 5% OP	24 ... 30 V DC	48 ... 60 V DC	J	
			110 ... 127 V AC/110 ... 125 V DC	L	
			208 ... 240 V AC/220 ... 250 V DC	N	
		24 ... 30 V DC	48 ... 60 V DC	P	
			110 ... 127 V AC/110 ... 125 V DC	Q	
			208 ... 240 V AC/220 ... 250 V DC	R	
	With undervoltage release (UVR) ³⁾ , instantaneous (≤ 0.08 s) and short-time delayed (≤ 0.2 s)	24 ... 30 V DC	48 ... 60 V DC	S	
			110 ... 127 V AC/110 ... 125 V DC	T	
			208 ... 240 V AC/220 ... 250 V DC	U	
		380 ... 415 V AC	48 V DC	V	
60 V DC			W		
110 ... 127 V AC/110 ... 125 V DC					
With undervoltage release (UVR-t), adjustable delay 0.2 ... 3.2 s	208 ... 240 V AC/220 ... 250 V DC	380 ... 415 V AC			
	48 V DC	60 V DC			
		110 ... 127 V AC/110 ... 125 V DC			

¹⁾ Remote trip alarm reset coil is not available for non-automatic circuit breakers

²⁾ If the ready4COM feature is provided, the communication-capable closing coils (CC-COM) and/or shunt trips (ST-COM) are installed at the factory.

³⁾ UVR instantaneous for 30 V DC and 60 V DC can only be supplied separately. Please order: for 30 V DC 3WL9111-0AE02-0AA0; for 60 V DC 3WL9111-0AE07-0AA0.

3WA1 5 6 7 8 – 9 10 11 12 – 13 14 15 16

Auxiliary releases

1st auxiliary release			
	Without 1st auxiliary release		0
	With shunt trip	24 ... 30 V DC	1
	(ST/ST-COM) ¹⁾ ,	48 ... 60 V DC	2
	uninterrupted duty 100% OP	110 ... 127 V AC/110 ... 125 V DC	3
		208 ... 240 V AC/220 ... 250 V DC	4
	With shunt trip (ST),	24 ... 30 V DC	5
	momentary duty 5% OP	48 ... 60 V DC	6
		110 ... 127 V AC/110 ... 125 V DC	7
		208 ... 240 V AC/220 ... 250 V DC	8

¹⁾ If the ready4COM feature is provided, the communication-capable closing coils (CC-COM) and/or shunt trips (ST-COM) are installed at the factory.

Structure of the article numbers

Basic configuration for DC non-automatic circuit breakers

The structure shown below is intended as an overview of each position and its meaning. For a complete and valid configuration of your air circuit breaker, please use our online configurator at www.siemens.com/lowvoltage/3wa-configurator

1

		5	6	7	8	9	10	11	12	13	14	15	16
3WA1					-								
Non-automatic circuit breakers													
Size (SZ)	2	2											
		SZ 2											
Max. rated current $I_{n \max}$	1000 A	■		1	0								
	2000 A	■		2	0								
	4000 A	■		4	0								
Short-circuit breaking capacity I_{cc}	D	■	25 kA, 600 V DC		1								
	E	■	20 kA, 1000 V DC		8								
			20 kA, 1500 V DC ²⁾										
Non-automatic circuit breakers						A	U						
Non-automatic circuit breakers, ready4COM feature						C	U						
Number of poles ¹⁾	Fixed-mounted				3-pole			0					
					4-pole			1					
	Withdrawable	Without position signaling switch				3-pole			3				
						4-pole			4				
		With position signaling switch ¹⁾				3-pole			6				
						4-pole			7				
Connection		SZ 2											
Type of mounting	Fixed-mounted	■	Vertical					1					
		■	Horizontal					2					
		■	Front double hole					3					
		■	Vertical on top/horizontal at the bottom					5					
		■	Horizontal on top/vertical at the bottom					6					
		■	Without guide frame					0					
	Withdrawable	Vertical	■	Vertical					1				
			■	Horizontal					2				
		Front double hole	■	Front double hole					3				
			■	Flange					4				
		Vertical on top/horizontal at the bottom	■	Vertical on top/horizontal at the bottom					5				
			■	Horizontal on top/vertical at the bottom					6				
			■	Flange on top/horizontal at the bottom					7				
			■	Horizontal on top/flange at the bottom					8				

¹⁾ Position signaling switch for circuit breakers/non-automatic circuit breakers without ready4COM:
 3 × connected position, 2 × test position, 1 × disconnected position;
 Position signaling switch for circuit breakers/non-automatic circuit breakers with ready4COM:
 1 × connected position, 1 × test position, 1 × disconnected position + message through communications interface for disconnected position and for "not available".
²⁾ 1500 V DC applications only possible with 4-pole circuit breakers and breaking capacity E.

3WA1

5	6	7	8	9	10	11	12	13	14	15	16
---	---	---	---	---	----	----	----	----	----	----	----

Operating mechanisms, auxiliary switches and auxiliary releases

Operating mechanism and auxiliary switch	Manual recharging of the stored energy mechanism	Without spring charging motor	2 NO, 2 NC	0	
			4 NO, 4 NC	1	
	Recharging of the stored energy mechanism by spring charging motor (M)	24 ... 30 V DC		2 NO, 2 NC	2
				4 NO, 4 NC	5
		48 ... 60 V DC		4 NO, 4 NC	6
				2 NO, 2 NC	3
		110 ... 127 V AC/ 110 ... 125 V DC		4 NO, 4 NC	7
				2 NO, 2 NC	4
208 ... 240 V AC/ 220 ... 250 V DC		4 NO, 4 NC	8		
Closing coil	Without closing coil			A	
	With closing coil (CC/CC-COM) ¹⁾ for uninterrupted duty, 100% OP	24 ... 30 V DC		B	
		48 ... 60 V DC		C	
		110 ... 127 V AC/110 ... 125 V DC		D	
		208 ... 240 V AC/220 ... 250 V DC		E	
	With closing coil (CC) for momentary duty, 5% OP	24 ... 30 V DC		K	
		48 ... 60 V DC		L	
		110 ... 127 V AC/110 ... 125 V DC		M	
		208 ... 240 V AC/220 ... 250 V DC		N	
2nd auxiliary release	Without 2nd auxiliary release			A	
	With shunt trip (ST), uninterrupted duty 100% OP ¹⁾	24 ... 30 V DC		B	
		48 ... 60 V DC		C	
		110 ... 127 V AC/110 ... 125 V DC		D	
		208 ... 240 V AC/220 ... 250 V DC		E	
	With shunt trip (ST), momentary duty 5% OP	24 ... 30 V DC		F	
		48 ... 60 V DC		G	
		110 ... 127 V AC/110 ... 125 V DC		H	
		208 ... 240 V AC/220 ... 250 V DC		J	
	With undervoltage release (UVR), instantaneous (≤ 0.08 s) and short-time delayed (≤ 0.2 s)	24 ... 30 V DC		L	
		48 ... 60 V DC		N	
		110 ... 127 V AC/110 ... 125 V DC		P	
		208 ... 240 V AC/220 ... 250 V DC		Q	
		380 ... 415 V AC		R	
	With undervoltage release (UVR-t), adjustable delay 0.2 ... 3.2 s	48 V DC		S	
		60 V DC		T	
		110 ... 127 V AC/110 ... 125 V DC		U	
		208 ... 240 V AC/220 ... 250 V DC		V	
380 ... 415 V AC			W		
1st auxiliary release	Without 1st auxiliary release			0	
	With shunt trip (ST/ST-COM) ¹⁾ , uninterrupted duty 100% OP	24 ... 30 V DC		1	
		48 ... 60 V DC		2	
		110 ... 127 V AC/110 ... 125 V DC		3	
		208 ... 240 V AC/220 ... 250 V DC		4	
	With shunt trip (ST), momentary duty 5% OP	24 ... 30 V DC		5	
		48 ... 60 V DC		6	
		110 ... 127 V AC/110 ... 125 V DC		7	
		208 ... 240 V AC/220 ... 250 V DC		8	

¹⁾ If the ready4COM feature is provided, the communication-capable closing coils (CC-COM) and/or shunt trips (ST-COM) are installed at the factory.

Accessory options

For a complete and valid configuration of your air circuit breaker, please use our online configurator at www.siemens.com/lowvoltage/3wa-configurator

To specify the options, add "-Z" to the complete article number and indicate the appropriate order code(s).

3WA....-.....-.... -Z

Order code

Option plug for electronic trip unit

- To reduce the rated current of the circuit breaker
- Only one module is possible per circuit breaker. As standard, the electronic trip unit is equipped with an option plug which is equal to the maximum rated breaker current ($I_{n\max}$). The rated current of the selected option plug must be less than $I_{n\max}$.

Option plug	Rated current I_n	SZ 1	SZ 2	SZ 3	Order code
	250 A	■	■	-	B02
	315 A	■	■	-	B03
	400 A	■	■	-	B04
	500 A	■	■	-	B05
	630 A	■	■	-	B06
	800 A	■	■	■	B08
	1000 A	■	■	■	B10
	1250 A	■	■	■	B12
	1600 A	■	■	■	B16
	2000 A	■	■	■	B20
	2500 A	-	■	■	B25
	3200 A	-	■	■	B32
	4000 A	-	-	■	B40
	5000 A	-	-	■	B50

IOM230 digital input/output module ¹⁾

Module with 2 inputs and 3 outputs	A module including adapter for mounting on the secondary disconnect terminal system of the circuit breaker, connecting cables and CubicleBUS ² terminating resistor; five modules can be operated at the same time. Further modules must be ordered separately as 3WA9111-0EC11, which includes the adapter for mounting on the secondary disconnect terminal system of the circuit breaker and the adapter for external mounting on a DIN rail.	F23
---	--	-----

ZSI200 Zone-selective interlocking module ¹⁾

Zone-selective interlocking with ETU600	A module, circuit breaker internal. A module including adapter for mounting on the secondary disconnect terminal system of the circuit breaker, connecting cables and CubicleBUS ² terminating resistor	F20
--	---	-----

COM190 communications module ^{1) 2)}

- The precondition for connection is a circuit breaker or non-automatic circuit breaker with the "ready4COM" feature

PROFINET IO/Modbus TCP ²⁾	A module including 2 Switched Ethernet ports, circuit breaker internal. A module including adapter for mounting on the secondary disconnect terminal system of the circuit breaker, connecting cables and CubicleBUS ² terminating resistor; two communications modules can be run at the same time. The second communications module must be ordered separately as 3WA9111-0EC13.	F19
---	--	-----

COM150 communications module ¹⁾

- The precondition for connection is a circuit breaker or non-automatic circuit breaker with the "ready4COM" feature

Modbus RTU	A module with terminal connection and optional internal terminating resistor, circuit breaker internal. A module including adapter for mounting on the secondary disconnect terminal system of the circuit breaker, connecting cables and CubicleBUS ² terminating resistor; two communications modules can be run at the same time. The second communications module must be ordered separately as 3WA9111-0EC15.	F15
-------------------	--	-----

Automatic reset

- Only possible for circuit breakers with an electronic trip unit

Automatic reset	Automatic reset of the reclosing lockout after ETU tripping; this option is not required when ordering a circuit breaker with a remote trip alarm reset coil RR.	K01
------------------------	--	-----

¹⁾ When ordering this option for a circuit breaker or a non-automatic air circuit breaker of the installation type "withdrawable version without guide frame", this must be used as the order option for the guide frame.

²⁾ For connecting the Ethernet cable, connectors angled 90° to the right are recommended, e.g. PROFINET connector 6GK1901-1BB20-2AA0.

To specify the options, add "-Z" to the complete article number and indicate the appropriate order code(s).

3WA....-.....-.... -Z

Order code

Special approval according to UL 489b in addition to IEC 60947

DC non-automatic circuit breakers up to 1500 V

Sizes 2, 4-pole, 2000 A with $I_{cc} = 20$ kA

Available for:

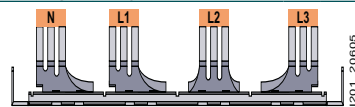
3WA1220-8AU12-_____
 3WA1220-8AU42-_____
 3WA1220-8AU72-_____
 3WA1220-8CU12-_____
 3WA1220-8CU42-_____
 3WA1220-8CU72-_____

U09

Rear vertical main connections (top and bottom) with equal pole spacing of the phases ¹⁾

AC circuit breakers/AC non-automatic circuit breakers and AC guide frames

Sizes 2, 4-pole, 4000 A breaking capacity S/M/H/E

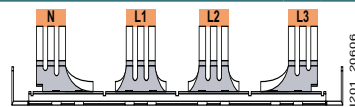


Option

L1 – N 130 mm

L1 – L2 160 mm

L2 – L3 160 mm



Standard

L1 – N 160 mm

L1 – L2 130 mm

L1 – L3 160 mm

D04

¹⁾ Available from 02/2024

Accessory options

For a complete and valid configuration of your air circuit breaker, please use our online configurator at www.siemens.com/lowvoltage/3wa-configurator

To specify the options, add "-Z" to the complete article number and indicate the appropriate order code(s).

3WA....-.....-.... -Z

Order code

Tinned version of the main circuit connections on the guide frame

- Only for withdrawable circuit breakers with horizontal connection or flange connection
- Cannot be ordered for circuit breakers without a guide frame
- The normal delivery time increases to 15 work days

Tinned connections	Sizes 1, 2, 3	D08
--------------------	---------------	-----

Broadened vertical main circuit connection

- Only possible on complete order for a withdrawable circuit breaker or when ordering the guide frame separately

Main circuit connection	For 3WA1, 4000 A, size 2	Compatible with 3WL1240 for retrofit	D01
-------------------------	--------------------------	--------------------------------------	-----

Circuit breakers without Bluetooth function

Circuit breakers without Bluetooth function	In this version of the circuit breaker, Bluetooth is not provided. Neither can Bluetooth be retrofitted by replacing the electronic trip unit.	D80
---	--	-----

Secondary disconnect terminal system

- Can be ordered for circuit breakers with guide frames and for guide frames

Manual connector with screw terminal	With screw connection instead of push-in connection (standard)	N03
--------------------------------------	--	-----

Manual connector for ring lugs	With screw connection for ring lugs instead of push-in connection (standard)	N05
--------------------------------	--	-----

Mechanical operating cycles counters

Mechanical operating cycles counter, 5-digit	Can be used with all circuit breakers and non-automatic circuit breakers including those without a spring charging motor	C01
--	--	-----

Signaling switches

Trip alarm switch	2nd trip alarm switch (S25) 1st trip alarm switch included as standard for circuit breakers. Can only be used with circuit breakers with an electronic trip unit without ready4COM.	1 NO	K06
-------------------	---	------	-----

Pushbuttons/disconnect switches/closing lockouts/special packaging/arc chute cover

Emergency OPEN button	Mushroom pushbutton instead of the mechanical OFF pushbutton	C25
-----------------------	--	-----

Local electric close on operator panel (S10)	This prevents unauthorized electrical closing from the operator panel. Mechanical closing and remote closing remain possible. Only possible in combination with a closing coil (CC)	With sealing cap	C11
		With CES lock	C12

Motor disconnect switch on operator panel (S12)	This prevents automatic charging of the stored energy mechanism by the spring charging motor	C24
---	--	-----

Cardboard packaging with water-repellent coating on corrugated cardboard (moisture protection)		P61
--	--	-----

Arc chute cover mounted on the guide frame	Not available for: <ul style="list-style-type: none"> – Fixed-mounted – Breaking capacity C, E and D – 4000 A size 2 	R10
--	---	-----

Cover for electronic trip unit	Top cover with safety lock (The lower sealable cover of the rotary coding switch is included in the scope of supply of the circuit breaker)	F40
--------------------------------	--	-----

Internal current sensors without energy core for applications with frequency converters

- Used in converter applications with high harmonic components; can only be used for circuit breakers with an ETU600 electronic trip unit
 - External 24 V DC supply required
 - Undervoltage release required
 - Additionally contains a relay for monitoring the 24 V DC and warning labels
 - If option Z = K60 is provided, an optional metering function PMF-I to PMF-III according to IEC 61557-12 is not technically feasible.

Internal current sensors	Sizes 1 new , 2, 3	K60
--------------------------	---------------------------	-----

To specify the options, add "-Z" to the complete article number and indicate the appropriate order code(s).

3WA....-.....-.... -Z

Order code

Mechanical interlocks

- Interlocking module with Bowden cable 2 m

Mechanical interlocks	For fixed-mounted breakers		S55
	For withdrawable circuit breakers with guide frame		R55
	For guide frames (ordered separately)		R56
	For withdrawable circuit breakers (ordered separately)		R57

Locking provisions (for fixed-mounted and withdrawable circuit breakers)

Locking provisions	Against unauthorized closing from the operator panel of the circuit breaker. The disconnecter unit fulfills the requirements for main circuit breakers according to EN 60204-1	Made by CES	S01
		Made by IKON	S03
		Assembly kit FORTRESS or CASTELL ¹⁾	S05
		Assembly kit for padlocks ²⁾	S07
		Made by RONIS	S08
		Made by PROFALUX	S09
Locking provisions	For charging handle with padlock ²⁾		S33

Locking provisions (for withdrawable circuit breaker)

Locking provision to prevent movement of the withdrawable circuit breaker	Safety lock for mounting onto the circuit breaker	Made by CES	S71
		Made by PROFALUX	S75
		Made by RONIS	S76

Locking provisions against unauthorized closing, for withdrawable circuit breakers

- The disconnecter unit fulfills the requirements for main circuit breakers acc. to EN 60204-1, consisting of a lock in the guide frame, active in the connected position, function is retained when circuit breaker is replaced.
- Not possible in combination with order code "R81", "R82", "R85" or "R86".
- Only possible on complete order for a withdrawable circuit breaker or when ordering the guide frame separately

Made by CES	R61
Made by RONIS	R68
Made by PROFALUX	R60

Locking mechanisms

- R30 and R50 not possible in combination with order code "R81", "R82", "R85" or "R86".
- R30 and R50 only possible on complete order for a circuit breaker with a guide frame or when ordering the guide frame separately
- R40 can only be ordered with the circuit breaker

For fixed-mounted circuit breakers	To prevent opening of the control cabinet door in ON position	S30
For withdrawable circuit breakers	To prevent opening of the control cabinet door in connected position	R30
	To prevent activation when the control cabinet door is open ³⁾	R40
	To prevent movement when the control cabinet door is open ⁴⁾	R50

Locking provisions to prevent movement of the withdrawable circuit breaker in disconnected position

- Consisting of Bowden cable and lock in the control cabinet door
- Not possible in combination with order code "R30", "R50", "R61", "R68" or "R60"
- Only possible for a complete order for a circuit breaker with a guide frame or when ordering the guide frame separately

Made by CES	R81
Made by IKON	R82
Made by PROFALUX	R85
Made by RONIS	R86

Increased degree of protection for installation in a control cabinet

Door sealing frame for degree of protection IP41	T40
---	-----

¹⁾ Locks must be ordered from the manufacturer.

²⁾ Padlock not included in the scope of supply.

³⁾ Not available in combination with R50

⁴⁾ Not available in combination with R40

Accessory options

Further technical specifications

Manual operating mechanism

3WA11 – 3WA13

Switching on/charging energy store

Maximum force required to operate the hand lever	≤ 230 N
Required number of strokes on the hand lever	9

Closing coils (CC/CC-COM)

3WA11 – 3WA13

Rated operational voltage

Rated control supply voltage U_s	24 ... 30 V DC
	48 ... 60 V DC
	110 ... 127 V AC/110 ... 125 V DC
	208 ... 240 V AC/220 ... 250 V DC

Primary operating range

Primary operating range (acc. to IEC 60947-2)	85 ... 110% U_s
Extended operating range for battery operation	85 ... 126% U_s
Integrated freewheeling diode	Yes

Operation

Version	100% OP	5% OP	
Closing power	AC/DC	40 VA/40 W	≤ 60 V: 200 VA/200 W ≥ 110 V: 250 VA/250 W
Continuous power	AC/DC	8 VA/8 W	–
Minimum command time at 100% U_s		60 ms	60 ms
Maximum command time at 100% U_s		–	2000 ms
Make time of the circuit breaker at 100% U_s		80 ms	50 ms

Fuse protection of the control circuit at U_s for closing coil

Fuse gG	24 ... 30 V DC, 48 ... 60 V DC	2 A	10 A
	110 ... 127 V AC/110 ... 125 V DC	1 A	4 A
	208 ... 240 V AC/220 ... 250 V DC	1 A	2 A
Automatic circuit breaker with C characteristic	24 ... 30 V DC, 48 ... 60 V DC	2 A	10 A
	110 ... 127 V AC/110 ... 125 V DC	1 A	4 A
	208 ... 240 V AC/220 ... 250 V DC	1 A	2 A

Fuse protection of the control circuit at U_s for spring charging motor + closing coil ¹⁾

Fuse gG	24 ... 30 V DC, 48 ... 60 V DC	6 A	10 A
	110 ... 127 V AC/110 ... 125 V DC	2 A	4 A
	208 ... 240 V AC/220 ... 250 V DC	2 A	2 A
Automatic circuit breaker with C characteristic	24 ... 30 V DC, 48 ... 60 V DC	6 A	10 A
	110 ... 127 V AC/110 ... 125 V DC	2 A	4 A
	208 ... 240 V AC/220 ... 250 V DC	2 A	2 A

¹⁾ With the same control circuit for the closing coil and spring charging motor

Spring charging motor

3WA11 – 3WA13

Rated operational voltage

Rated control supply voltage U_s	24 V DC
	30 V DC
	48 V DC
	60 V DC
	110 ... 125 V DC/110 ... 127 V AC
	220 ... 250 V DC/208 ... 240 V AC

Primary operating range

Primary operating range (acc. to IEC 60947-2)	85 ... 110% U_s
Extended operating range for battery operation	85 ... 126% U_s

Operation

Closing power	AC/DC	135 VA/135 W
Continuous power	AC/DC	135 VA/135 W
Charging time at 100% U_s		≤ 10 s

Fuse protection of the control circuit at U_s for spring charging motor

Fuse gG	24 ... 30 V DC, 48 ... 60 V DC	6 A
	110 ... 125 V DC/110 ... 127 V AC, 220 ... 250 V DC/208 ... 240 V AC	2 A
	Automatic circuit breaker with C characteristic	6 A
	24 ... 30 V DC, 48 ... 60 V DC	2 A
	110 ... 125 V DC/110 ... 127 V AC, 220 ... 250 V DC/208 ... 240 V AC	2 A

Undervoltage releases UVR and UVR-t

3WA11 – 3WA13

Rated operational voltage		
Rated control supply voltage U_s		
		24 ... 30 V DC (UVR)
		48 ... 60 V DC (UVR)
		48 V DC (UVR-t)
		60 V DC (UVR-t)
		110 ... 127 V AC/110 ... 125 V DC
		208 ... 240 V AC/220 ... 250 V DC
		380 ... 415 V AC
Operating range		
Response values	Pickup	$\geq 0.85 \times U_s$ (circuit breaker can be closed)
	Dropout	$0.35 \dots 0.7 \times U_s$ (circuit breaker is opened)
Operating range		$0.85 \dots 1.1 \times U_s$
Extended operating range for battery operation		At 24 V DC, 30 V DC, 48 V DC, 110 V DC, 220 V DC $0.85 \dots 1.26 \times U_s$
Integrated freewheeling diode		Yes
Operation		
Closing power	AC/DC	50 VA/50 W
Continuous power	AC/DC	5 VA/5 W
Break time		
$U_s = 0$ with UVR instantaneous		≤ 80 ms
$U_s = 0$ with UVR short-time delayed		≤ 200 ms
$U_s = 0$ with UVR-t delayed		0.2 ... 3.2 s
With UVR-t by disconnection at terminals X5.13 and X5.14 (EMERGENCY-STOP circuit)		≤ 100 ms
Fuse protection of the control circuit		
Fuse gG	24 ... 30 V DC (UVR)	2 A
	48 ... 60 V DC (UVR)	2 A
	48 V DC (UVR-t)	2 A
	60 V DC (UVR-t)	2 A
	110 ... 127 V AC/110 ... 125 V DC	2 A
	208 ... 240 V AC/220 ... 250 V DC	2 A
	380 ... 415 V AC	2 A
Automatic circuit breaker with C characteristic	24 ... 30 V DC (UVR)	4 A
	48 ... 60 V DC (UVR)	4 A
	48 V DC (UVR-t)	4 A
	60 V DC (UVR-t)	4 A
	110 ... 127 V AC/110 ... 125 V DC	4 A
	208 ... 240 V AC/220 ... 250 V DC	6 A
	380 ... 415 V AC	6 A
Automatic circuit breaker with D characteristic	24 ... 30 V DC (UVR)	2 A
	48 ... 60 V DC (UVR)	2 A
	48 V DC (UVR-t)	2 A
	60 V DC (UVR-t)	2 A
	110 ... 127 V AC/110 ... 125 V DC	2 A
	208 ... 240 V AC/220 ... 250 V DC	4 A
	380 ... 415 V AC	4 A

Shunt trip (ST/ST-COM/ST2)

3WA11 – 3WA13

Rated operational voltage		
Rated control supply voltage U_s		
		24 ... 30 V DC
		48 ... 60 V DC
		110 ... 127 V AC/110 ... 125 V DC
		208 ... 240 V AC/220 ... 250 V DC
Primary operating range		
Primary operating range (acc. to IEC 60947-2)		85 ... 110% U_s
Extended operating range for battery operation		85 ... 126% U_s
Integrated freewheeling diode		Yes

Accessory options

Further technical specifications

Shunt trip (ST/ST-COM/ST2)

3WA11 – 3WA13

Operation

Version		100% OP	5% OP
Closing power	AC/DC	40 VA/40 W	≤ 60 V: 200 VA/200 W ≥ 110 V: 250 VA/250 W
Continuous power	AC/DC	8 VA/8 W	–
Minimum command time at 100% U_s		60 ms	60 ms
Maximum command time at 100% U_s		–	2000 ms
Make time of the circuit breaker at 100% U_s		80 ms	50 ms

Fuse protection of the control circuit

Fuse gG	24 ... 30 V DC, 48 ... 60 V DC	2 A	10 A
	110 ... 127 V AC/110 ... 125 V DC	1 A	4 A
	208 ... 240 V AC/220 ... 250 V DC	1 A	2 A
Automatic circuit breaker with C characteristic	24 ... 30 V DC, 48 ... 60 V DC	2 A	10 A
	110 ... 127 V AC/110 ... 125 V DC	1 A	4 A
	208 ... 240 V AC/220 ... 250 V DC	1 A	2 A

Remote trip alarm reset coil for mechanical tripped indicator (F7)

3WA11 – 3WA13

Rated operational voltage

Rated control supply voltage U_s	24 ... 30 V DC	
	48 ... 60 V DC	
	110 ... 125 V DC/110 ... 127 V AC	
	220 ... 250 V DC/208 ... 240 V AC	

Primary operating range

Primary operating range (acc. to IEC 60947-2)	85 ... 110% U_s
Extended operating range for battery operation	70 ... 126% U_s
Integrated freewheeling diode	Yes

Operation

Power consumption	AC/DC	60 VA/60 W
Minimum command time at 1 × U_s		60 ms

Fuse protection of the control circuit

Fuse gG	24 ... 60 V DC	2 A
	100 V AC/> 100 V DC	1 A
Automatic circuit breaker with C characteristic	24 ... 60 V DC	2 A
	100 V AC/> 100 V DC	1 A

Contact position-driven auxiliary switches (S1 bis S8)

3WA11 – 3WA13

Type	NO or NC
Contact reliability	From 1 mA at 5 V DC
Rated insulation voltage U_i	500 V DC/500 V AC 50/60 Hz
Rated impulse withstand voltage U_{imp}	4 kV

Breaking capacity

Rated operational current I_e	DC12	24 V	10 A
		30 V	4 A
		48 V	2.5 A
		60 V	1 A
		110 V	0.4 A
		220/240 V	0.2 A
	DC13	24 V	3 A
		30 V	2.5 A
		48 V	1 A
		60 V	0.4 A
		110 V	0.2 A
		220/240 V	0.1 A
	AC12	≤ 440 V	10 A
	AC13	< 220 V	8 A
		220 ... 240 V	4 A
		320 ... 440 V	3 A

Ready-to-close signaling switches (S20) (acc. to DIN VDE 0630)

3WA11 – 3WA13

		3WA11 – 3WA13	
Type		NO contact	
Contact reliability		From 1 mA at 5 V DC ¹⁾	
Rated insulation voltage U_i		250 V DC/250 V AC	
Breaking capacity			
Rated operational current I_e	DC12	24 V	5 A
		30 V	2.5 A
		48 V	2.5 A
		60 V	0.4 A
		110/127 V	0.4 A
		220/240 V	0.2 A
	DC13	24 V	2.5 A
		30 V	1 A
		48 V	1 A
		60 V	0.22 A
		110/127 V	0.22 A
		220/240 V	0.1 A
	AC12	≤ 240 V	6 A
	AC13	110 ... 127 V	5 A
		220 ... 240 V	4 A

Trip alarm switches (S24, S25)

3WA11 – 3WA12

		3WA11 – 3WA12	
1st trip alarm switch S24		Changeover contact	
2nd trip alarm switch S25		NO contact	
Contact reliability		From 1 mA at 5 V DC ¹⁾	
Rated insulation voltage U_i		250 V DC/250 V AC 50/60 Hz	
Breaking capacity			
Rated operational current I_e	DC12	24 V	5 A
		30 V	2.5 A
		48 V	2.5 A
		60 V	0.4 A
		110/127 V	0.4 A
		220/240 V	0.2 A
	DC13	24 V	2.5 A
		30 V	1 A
		48 V	1 A
		60 V	0.2 A
		110/127 V	0.2 A
		220/240 V	0.1 A
	AC12	≤ 240 V	6 A
	AC13	110 ... 127 V	5 A
		220 ... 240 V	4 A

¹⁾ To ensure contact reliability at 1 mA, the contacts are gold-plated. If 1 mA is exceeded, the gold-plating is eroded. As a consequence, contact reliability at 1 mA can no longer be ensured.

Accessory options

Further technical specifications

Position signaling switches on guide frame

3WA11 – 3WA13

Type	Changeover contact (not COM)
Contact reliability	From 1 mA at 5 V DC ¹⁾
Rated insulation voltage U_i	250 V DC/250 V AC 50/60 Hz
Rated impulse withstand voltage U_{imp}	4 kV
Connection type	Spring-type terminals
Conductor cross-section that can be connected by customer	1 × 0.5 mm ² (AWG 20) ... 1 × 2.5 mm ² (AWG 14)

Breaking capacity

Rated operational current I_e			
DC12		24 V	5 A
		30 V	2.5 A
		48 V	2.5 A
		60 V	0.4 A
		110/127 V	0.4 A
		220/240 V	0.2 A
		DC13	
		30 V	1 A
		48 V	1 A
		60 V	0.22 A
		125 V	0.22 A
		250 V	0.1 A
R300 DC		24 V	3 A
		30 V	2.5 A
		48 V	1 A
		60 V	0.4 A
		110 V	0.22 A
		220/240 V	0.11 A
AC12		≤ 440 V	6 A
AC13		< 220 V	5 A
		220 ... 240 V	4 A
		320 ... 440 V	3 A
A300 AC		120 V	6 A
		240 V	3 A

The COM (X89) contacts may only be connected to the communications module.

¹⁾ To ensure contact reliability at 1 mA, the contacts are gold-plated. If 1 mA is exceeded, the gold-plating is eroded. As a consequence, contact reliability at 1 mA can no longer be ensured.

ETU600

3WA11 – 3WA13

Power supply

Method of power supply	Power supply unit DC
DC power supply unit	IEC 61558 SELV/PELV
Rated control supply voltage U_s	DC
Primary operating range	24 V
Power consumption	$U_s \pm 20\%$
Max. current consumption	2.9 W
Max. starting current	0.12 A
Overvoltage category	0.35 A
Integrated short-circuit protection	CAT I
Protected against polarity reversal	Yes
	Yes

Summary of power consumption data

Composants	Voltage	Power consumption
ETU600	24 V DC	2.9W
Closing coil CC/CC-COM 100% OP	24 ... 30 V DC	40 W
	48 ... 60 V DC	40 W
	110 ... 127 V AC/110 ... 125 V DC	40 VA/W
	208 ... 240 V AC/220 ... 250 V DC	40 VA/W
Closing coil CC/CC-COM 5% OP	24 ... 30 V DC	200 W
	48 ... 60 V DC	200 W
	110 ... 127 V AC/110 ... 125 V DC	250 VA/W
	208 ... 240 V AC/220 ... 250 V DC	250 VA/W
Shunt trip ST/ST-COM 100% OP	24 ... 30 V DC	40 W
	48 ... 60 V DC	40 W
	110 ... 127 V AC/110 ... 125 V DC	40 VA/W
	208 ... 240 V AC/220 ... 250 V DC	40 VA/W
Shunt trip ST/ST-COM 5% OP	24 ... 30 V DC	200 W
	48 ... 60 V DC	200 W
	110 ... 127 V AC/110 ... 125 V DC	250 VA/W
	208 ... 240 V AC/220 ... 250 V DC	250 VA/W
Spring charging motors	24 ... 30 V DC	135 W
	48 ... 60 V DC	135 W
	110 ... 127 V AC/110 ... 125 V DC	135 VA/W
	208 ... 240 V AC/220 ... 250 V DC	135 VA/W
Remote trip alarm reset coils	24 ... 30 V DC	60 W
	48 ... 60 V DC	60 W
	110 ... 127 V AC/110 ... 125 V DC	60 VA/W
	208 ... 240 V AC/220 ... 250 V DC	60 VA/W
Undervoltage releases (UVR/UVR-t)	24 V DC	50 W
	30 V DC	50 W
	48 V DC	50 W
	60 V DC	50 W
	110 ... 127 V AC/110 ... 125 V DC	50 VA/W
	208 ... 240 V AC/220 ... 250 V DC	50 VA/W
380 ... 415 V AC	50 VA	
IOM230	24 V DC	1 W
COM190/COM150	24 V DC	1 W

		5	6	7	8	9	10	11	12	13	14	15	16
3WA8						–				1			1
Push-in connection ¹⁾	SZ 1, SZ 2, SZ 3	X7, X6, X5		Non-automatic circuit breakers without ready4COM feature		A							
		X8, X7, X6, X5		Circuit breakers/non-automatic circuit breakers with ready4COM feature		B							
	SZ 2, SZ 3	X9, X8, X7, X6, X5		Including external trip controller ETC600 for circuit breakers with ETU600 LSIG Hi-Z		K							
Position signaling switch	Without position signaling switch											A	
	Position signaling switch PSS (3 × connected position, 2 × test position, 1 × disconnected position)											C	
	Position signaling switch PSS-COM (1 × connected position, 1 × test position, 1 × disconnected position) plus connection to a communications module											G	

¹⁾ Conversion to screw connection is possible with Z option N03.

Guide frames for DC

The structure shown below is intended as an overview of each position and its meaning. For a complete and valid configuration of your guide frame, please use our online configurator at www.siemens.com/lowvoltage/3wa-configurator

		5	6	7	8	9	10	11	12	13	14	15	16
3WA8					-	A	U			-	1		1
Guide frames													
Size (SZ)	2	2											
Max. rated current $I_{n \max}$	2000 A		2	0									
	4000 A		4	0									
Short-circuit breaking capacity	D	≤ 600 V DC	25 kA at 600 V DC		1								
	E	≤ 1000 V DC	20 kA at 1000 V DC		8								
		≤ 1500 V DC	20 kA at 1500 V DC ¹⁾		8								
Number of poles	3-pole							3					
	4-pole							4					
Connection	Withdrawable	Vertical							1				
		Horizontal							2				
		Front double hole								3			
		Flange								4			
		Vertical on top/horizontal at the bottom								5			
		Horizontal on top/vertical at the bottom								6			
		Flange on top/horizontal at the bottom								7			
		Horizontal on top/flange at the bottom								8			
Secondary disconnect terminal	Push-in connection	X7, X6, X5										A	
		X8, X7, X6, X5											B
Position signaling switch	Without position signaling switch											A	
	Position signaling switch PSS (3 × connected position, 2 × test position, 1 × disconnected position)											C	
	Position signaling switch PSS-COM (1 × connected position, 1 × test position, 1 × disconnected position) plus connection to a communications module											G	

¹⁾ 1500 V DC applications only possible with 4-pole circuit breakers and breaking capacity E.

Accessories and spare parts

Accessories for electronic trip unit

Electronic trip unit



- Note: The electronic trip unit is supplied without an option plug. The option plug must be ordered separately. The range of functions of the ETU600 corresponds to the "Current metering" application package.

Basic protective functions	Article No.
ETU300 LSI/LSIG	3WA9111-0EE32
ETU600 LSI/LSIG	3WA9111-0EE62
ETU600 LSI Hi-Z	3WA9111-0EE63

Spare part battery for ETU600



Article No.
3WA9111-0EE81

Option plug



Basic configuration	Rated current I_n	SZ 1	SZ 2	SZ 3	Article No.
Protective function LSI: LT, ST, INST					3WA9111-0EB ..
Protective function LSIG: LT, ST, INST, GF (ground-fault protection GFx with extended setting range)					3WA9111-0EX ..
	250 A	■	■	–	02
	315 A	■	■	–	03
	400 A	■	■	–	04
	500 A	■	■	–	05
	630 A	■	■	–	06
	800 A	■	■	■	08
	1000 A	■	■	■	10
	1250 A	■	■	■	12
	1600 A	■	■	■	16
	2000 A	■	■	■	20
	2500 A	■	■	■	25
	3200 A	–	■	■	32
	4000 A	–	■	■	40
	5000 A	–	–	■	50
	6300 A	–	–	■	63

Function packages for ETU600



Protective and alarm functions	Article No.
Ground fault alarm (GF alarm)	3WA9111-0ES01
Directional short-time-delayed short-circuit protection (dST) and reverse power protection (RP) (requires an optional voltage tap module)	3WA9111-0ES05
Enhanced protective functions (EPF)	Article No.
Full package with unbalance, voltage, active power, frequency, THD and phase sequence detection	3WA9111-0ES11
Phase unbalance current and phase unbalance voltage	3WA9111-0ES12
Undervoltage and overvoltage	3WA9111-0ES13
Active power import and active power export	3WA9111-0ES14
Underfrequency and overfrequency	3WA9111-0ES15
Total harmonic distortion for current and voltage	3WA9111-0ES16
Phase sequence detection	3WA9111-0ES17
Functional expansions	Article No.
Second protection parameter set	3WA9111-0ES21
Waveform memory	3WA9111-0ES24
Extended metering function	Article No.
Upgrade to metering function PMF-II Basic Power Monitoring (metering values, see catalog page 1/25)	3WA9111-0ES52
Upgrade to metering function PMF-III Advanced Power Monitoring (metering values, see catalog page 1/25)	3WA9111-0ES53

Standard license to activate test function in SENTRON Powerconfig software

Version	Article No.
For testing the protective functions of SENTRON circuit breakers	7KN2720-0CE00-1YC1

Accessories for electronic trip unit

Upgrading to "ready4COM" feature through BSS200 breaker status sensor for ETU600



Version	Article No.
<ul style="list-style-type: none"> Gathers information about the statuses of the circuit breaker via signaling switches and transmits it to the CubicleBUS² Controls the communication-capable CC-COM closing coil and the ST-COM shunt trip in a circuit breaker with the ready4COM feature The BSS200 breaker status sensor is fitted in every circuit breaker with ETU600 of the ready4COM application package and with the PMF-I to PMF-III metering function 	3WA9111-0EC40

External current sensors for the N conductor



Version	Size	Article No.
For mounting on busbar	1	3WA9111-0AA21
	2	3WA9111-0AA22
	3	3WA9111-0AA23
For busbar connection DIN connection	1	3WA9111-0AA31
	2	3WA9111-0AA32
	3	3WA9111-0AA33

Sealable and lockable covers

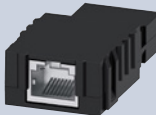


- The scope of supply includes both the top cover with safety lock and the sealable bottom cover of the rotary coding switches.



Accessory for	Article No.
ETU300	3WA9111-0EM21
ETU600	3WA9111-0EM22

Adapter for connecting the ETU300 to the TD400



Version	Article No.
Via the adapter, the ETU300 can be connected to the TD400 to supply it with an external voltage. There is no parameterization or documentation option via SENTRON Powerconfig	3VW9011-0AT46

Automatic reset of the reclosing lockout



Version	Article No.
Spare part for option K01 or for retrofitting	3WA9111-0EM31

Remote trip alarm reset coils



- For mechanical tripped indicator
- Including automatic reset of the reclosing lockout 3WA9111-0EM31

Voltage	Article No.
24 ... 30 V DC	3WA9111-0EM42
48 ... 60 V DC	3WA9111-0EM44
110 ... 127 V AC/110 ... 125 V DC	3WA9111-0EM45
208 ... 240 V AC/220 ... 250 V DC	3WA9111-0EM46

Second tripping solenoid (F6) with reclosing lockout



Version	Article No.
For external control via the external trip controller ETC600, including the necessary parts for the secondary disconnect terminal	3WA9111-0EM61

External trip controller ETC600

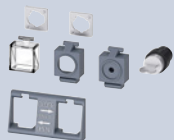


Version	Article No.
Including adapter for mounting on the secondary disconnect terminal system of the circuit breaker, adapter for mounting on DIN rail	3WA9111-0EM62

Accessories and spare parts

Locking provisions and interlocks

Interlocking sets for mechanical Open/Close



- Consisting of two transparent covers each for sealing or for attaching padlocks (padlocks not included in scope of supply)
- Cover with 6.35 mm hole (for tool actuation)
- Lock mount for safety lock for key operation

Version	Article No.
Without safety lock	3WA9111-0BA21
Made by CES	3WA9111-0BA22
Made by IKON	3WA9111-0BA23

Locking provision against unauthorized closing from the operator panel



- The disconnecter unit fulfills the requirements for main circuit breakers acc. to EN 60204-1
- Spare part for options S01 to S09

Type	Scope of supply	Article No.
Assembly kit FORTRESS or CASTELL ¹⁾	Without locks, cylinders or keys	3WA9111-0BA31
Made by RONIS	Locks, cylinders and keys included	3WA9111-0BA32
Made by KIRK-Key ¹⁾	Without locks, cylinders or keys	3WA9111-0BA33
Made by PROFALUX	Locks, cylinders and keys included	3WA9111-0BA34
Made by CES	Locks, cylinders and keys included	3WA9111-0BA35
Made by IKON	Locks, cylinders and keys included	3WA9111-0BA36
Assembly kit for padlocks	Without padlock	3WA9111-0BA37

Locking provision against unauthorized closing of the withdrawable circuit breaker



- The disconnecter unit fulfills the requirements for main circuit breakers acc. to EN 60204-1
- Consisting of lock in the guide frame, active in connected position, function is retained when circuit breaker is replaced
- Spare part for option R60, R61, R68

Type	Scope of supply	Article No.
Made by CES	Locks, cylinders and keys included	3WA9111-0BA51
Made by IKON	Locks, cylinders and keys included	3WA9111-0BA53
Made by KIRK-Key ¹⁾	Without locks, cylinders or keys	3WA9111-0BA57
Made by RONIS	Locks, cylinders and keys included	3WA9111-0BA58
Made by PROFALUX	Locks, cylinders and keys included	3WA9111-0BA50

Locking provisions for charging handle with padlock



Version	Scope of supply	Article No.
Spare part for S33	Without padlock	3WA9111-0BA71

Locking provision to prevent movement of the withdrawable circuit breaker



- Safety lock for mounting onto the circuit breaker
- Spare part for option S71, S75, S76

Type	Scope of supply	Article No.
Made by CES	Locks, cylinders and keys included	3WA9111-0BA73
Made by IKON	Locks, cylinders and keys included	3WA9111-0BA75
Made by PROFALUX	Locks, cylinders and keys included	3WA9111-0BA76
Made by RONIS	Locks, cylinders and keys included	3WA9111-0BA77
Made by KIRK-Key ¹⁾	Without locks, cylinders or keys	3WA9111-0BA80

¹⁾ Locks, cylinders and keys must be ordered from the manufacturer.

Suitable cylinder lock KIRK Key C 900-301.

Suitable lock FORTRESS CLIS X005.

Suitable lock CASTELL FS2.

Locking provisions and interlocks

Interlocking systems

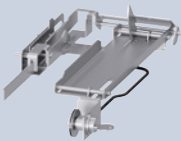


- 2 of the same keys for 3 circuit breakers
- Locking provision in OFF position
- Lock in the operator panel
- A maximum of 2 circuit breakers can be switched on

Type	Article No.
Made by CES	3WA9111-0BA43

Locking mechanisms to prevent movement of the withdrawable circuit breakers in the disconnected position

- Consisting of Bowden cable and the breaker mechanism in the control cabinet door
- Spare part for option R81, R82, R85, R86
- **Note:** Not possible in combination with "Locking mechanism to prevent opening of the control cabinet door" (order code "R30") or "Locking mechanism to prevent movement with the control cabinet door open" (order code "R50")



Type	Article No.
Made by CES	3WA9111-0BA81
Made by IKON	3WA9111-0BA82
Made by PROFALUX	3WA9111-0BA83
Made by RONIS	3WA9111-0BA84

Locking mechanisms to prevent opening of the control cabinet door when the circuit breaker is closed

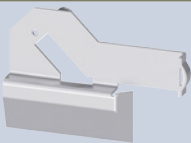
- Defeatable
- **Note:** Not possible in combination with "Locking mechanisms to prevent movement of the withdrawable circuit breakers in the disconnected position" (order codes "R81", "R82", "R85" or "R86").



Version	Article No.
Spare part for option S30 Fixed-mounted circuit breaker	3WA9111-0BB12
Spare part for option R30 Guide frames	3WA9111-0BB13

Locking mechanisms to prevent movement when the control cabinet door is open

- Mounted on guide frame
- **Note:** Not possible in combination with "Locking mechanisms to prevent movement of the withdrawable circuit breakers in the disconnected position" (order codes "R81", "R82", "R85" or "R86").



Version	Article No.
Spare part for option R50	3WA9111-0BB15

Mechanical interlocks

- With Bowden cable 2000 mm (one required for each circuit breaker)



Type	Circuit breaker and guide frame when ordered separately	Spare part for	Article No.
Fixed-mounted circuit breaker	–	Option S55	3WA9111-0BB21
Module for withdrawable circuit breakers with guide frame	–	Option R55	3WA9111-0BB22
Module for guide frame	✓	Option R56	3WA9111-0BB23
Module for withdrawable circuit breaker	✓	Option R57	3WA9111-0BB24
Adapter for size 3 withdrawable circuit breaker	✓	–	3WA9111-0BB25

Coupling on the circuit breaker for mutual interlocking with Bowden cable

- Can be used in all circuit breakers



Article No.
3WA9111-0BB31

Bowden cable for mutual mechanical interlocking



Length	Article No.
2000 mm	3WA9111-0BB41
3000 mm	3WA9111-0BB42
4500 mm	3WA9111-0BB43

¹⁾ Locks, cylinders and keys must be ordered from the manufacturer.

Accessories and spare parts

Indicators and control elements

Ready-to-close signaling switches (S20)



Version	Article No.
Spare part for signaling switch installed as standard	3WA9111-0AH01

1st trip alarm switch (S24)



Version	Article No.
Spare part for signaling switch installed as standard	3WA9111-0AH02

2nd trip alarm switch (S25)



- Can only be used with a circuit breaker with an electronic trip unit without ready4COM
- The 1st trip alarm switch (1 changeover contact) is installed in every circuit breaker with a trip unit as standard

Version	Contacts	Article No.
Spare part for option K06	1 NO	3WA9111-0AH03

Mechanical operating cycles counter (5-digit)



Version	For circuit breakers/non-automatic circuit breakers	Article No.
Spare part for option C01	With manual operating mechanism	3WA9111-0AH04
	With spring charging motor	3WA9111-0AH05

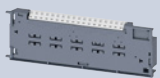
Spring charge signaling switch (S21)



- Standard when a spring charging motor is installed to charge the stored energy mechanism
- When a spring charging motor is retrofitted, the spring charge signaling switch can also be retrofitted

Contacts	Article No.
1 NO	3WA9111-0AH06

Position signaling switch for withdrawable circuit breakers



- All conventional contacts are implemented as changeover contacts.

Contacts	Version	Article No.
PSS321	3 × connected position, 2 × test position, 1 × disconnected position	3WA9111-0AH11
PSS111-COM	1 × connected position, 1 × test position, 1 × disconnected position and option for connection to a communications module COM (Signal: "disconnected position" and "absent")	3WA9111-0AH12
PSS400-COM	4 × connected position and option for connection to a communications module COM (Signal: "disconnected position" and "absent")	3WA9111-0AH13
PSS600	6 × connected position	3WA9111-0AH14

Local electric close (S10) for operator panel



- Scope of supply: Button + wiring
- Not possible with motor disconnect switch
- **Note:** Possible only for circuit breakers with closing coil



Version	Article No.
With sealing cap, spare part for option C11	3WA9111-0AH21
With CES assembly kit, spare part for option C12	3WA9111-0AH22
With IKON assembly kit	3WA9111-0AH23

Motor disconnect switch (S12)



- Mounting onto operator panel
- Only in combination with the spring charging motor for charging the stored energy mechanism
- Not available in combination with local electric close

Version	Article No.
Spare part for option C24	3WA9111-0AH24

Emergency OPEN button



- Mushroom pushbutton instead of local mechanical open

Version	Article No.
Spare part for option C25	3WA9111-0AH25

Secondary disconnect terminals for circuit breakers and guide frames

- For size 1, up to 4 secondary disconnect terminal blocks are possible; for sizes 2 and 3, up to 5 secondary disconnect terminal blocks are possible
- Circuit breakers and non-automatic circuit breakers with secondary disconnect terminal blocks are supplied from the factory:
 - Non-automatic circuit breakers with 3 blocks
 - Non-automatic circuit breakers with ready4COM feature with 4 blocks
 - Circuit breakers with ETU600 LSI or LSIG with 4 blocks
 - Circuit breakers with ETU600 LSIG-HiZ with 5 blocks

Secondary disconnect terminal		
Version	Type	Article No.
Base part ①		3WA9111-0AB01
1000 V extension ¹⁾		3WA9111-0AB02
Manual connector ②	Screw connection	3WA9111-0AB03
	Push-in connection	3WA9111-0AB04
	Ring lug connection	3WA9111-0AB05
Coding kits ③	For secondary disconnect terminal blocks X5 to X9 for fixed-mounted circuit breakers	3WA9111-0AB07
Sliding contact module ④	For guide frames	3WA9111-0AB08
Blanking block		3WA9111-0AB12

For a complete secondary disconnect terminal block, you must order:

Fixed-mounted version: ① + ② + ③

Withdrawable version: ① + ④ + ②

¹⁾ Secondary disconnect terminal for circuit breakers with breaking capacity C and E must be ordered separately

Auxiliary releases

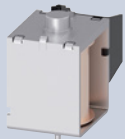
Closing coil (CC)/shunt trip (ST)



- Suitable for uninterrupted duty

Version	Voltage	Article No.
100% OP	24 ... 30 V DC	3WA9111-0AD02
Switching time ≤ 80 ms	48 ... 60 V DC	3WA9111-0AD04
	110 ... 125 V DC/110 ... 127 V AC	3WA9111-0AD05
	220 ... 250 V DC/208 ... 240 V AC	3WA9111-0AD06

Closing coil (CC-COM)/shunt trip (ST-COM)



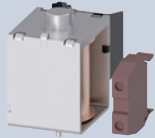
- Suitable for uninterrupted duty

Version	Voltage	Article No.
For circuit breakers and non-automatic circuit breakers with the "ready4com" feature	24 ... 30 V DC	3WA9111-0AD32
100% OP	48 ... 60 V DC	3WA9111-0AD34
Switching time ≤ 80 ms	110 ... 125 V DC/110 ... 127 V AC	3WA9111-0AD35
Switching time via COM ≤ 120 ms	220 ... 250 V DC/208 ... 240 V AC	3WA9111-0AD36

Accessories and spare parts

Auxiliary release

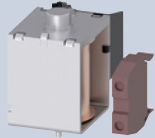
Closing coils (CC)



- For momentary duty, with cut-off switch S15 (NC)

Version	Voltage	Article No.
5% OP	24 ... 30 V DC	3WA9111-0AD12
Switching time 50 ms	48 ... 60 V DC	3WA9111-0AD14
	110 ... 125 V DC/110 ... 127 V AC	3WA9111-0AD15
	220 ... 250 V DC/208 ... 240 V AC	3WA9111-0AD16

Shunt trips (ST)



- For momentary duty, with cut-off switch S14 (NO)

Version	Voltage	Article No.
5% OP	24 ... 30 V DC	3WA9111-0AD22
Switching time 50 ms	48 ... 60 V DC	3WA9111-0AD24
	110 ... 125 V DC/110 ... 127 V AC	3WA9111-0AD25
	220 ... 250 V DC/208 ... 240 V AC	3WA9111-0AD26

Capacitor trip device



- For shunt trips
- Storage time 5 min
- Also suitable for 3VL, 3VA, 3WL and 3WN circuit breakers
- Note:** Rated control supply voltage must match the rated control supply voltage of the shunt trips.

Rated control supply voltage/rated operational voltage	Article No.
50/60 Hz AC	DC
220 ... 240 V	220 ... 250 V
	3WA9111-0AD81

Undervoltage release (UVR)



Version	Voltage	Article No.
Instantaneous ≤ 0.08 s (UVR) and short-time delayed ≤ 0.2 s	24 ... 30 V DC	3WA9111-0AE02
	48 ... 60 V DC	3WL9111-0AE04
	110 ... 125 V DC/110 ... 127 V AC	3WA9111-0AE05
	220 ... 250 V DC/208 ... 240 V AC	3WA9111-0AE06
	380 ... 415 V AC	3WA9111-0AE07
Delayed (UVR-t) ¹⁾ adjustable delay 0.2 ... 3.2 s	48 V DC	3WA9111-0AE13
	60 V DC	3WA9111-0AE14
	110 ... 125 V DC/110 ... 127 V AC	3WA9111-0AE15
	220 ... 250 V DC/208 ... 240 V AC	3WA9111-0AE16
	380 ... 415 V AC	3WA9111-0AE17

¹⁾ The maximum allowable cable length to the EMERGENCY-OFF actuator (quick shutdown) is currently < 50 m (maximum allowable cable length between the terminals < 100 m).

Operating mechanism

Spring charging motor to charge the stored energy mechanism



Voltage	Article No.
24 ... 30 V DC	3WA9111-0AF02
48 ... 60 V DC	3WA9111-0AF04
110 ... 125 V DC/110 ... 127 V AC	3WA9111-0AF05
220 ... 250 V DC/208 ... 240 V AC	3WA9111-0AF06





Auxiliary contacts

Auxiliary switches (AUX)




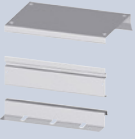
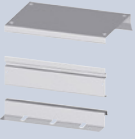
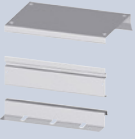
Contacts	Article No.
2 NO + 2 NC	3WA9111-0AG01
2 NO	3WA9111-0AG02
1 NO + 1 NC	3WA9111-0AG03

Door sealing frame, protective cover


Door sealing frame								
	<table border="1"> <thead> <tr> <th>Version</th> <th>Article No.</th> </tr> </thead> <tbody> <tr> <td>Spare part for option T40</td> <td>3WA9111-0AP01</td> </tr> </tbody> </table>	Version	Article No.	Spare part for option T40	3WA9111-0AP01			
	Version	Article No.						
Spare part for option T40	3WA9111-0AP01							
<table border="1"> <thead> <tr> <th colspan="2">Protective covers IP55</th> </tr> </thead> <tbody> <tr> <td rowspan="2">  </td> <td> <ul style="list-style-type: none"> Cannot be used in conjunction with door sealing frames Hood removable and can be opened on both sides </td> </tr> <tr> <td> <table border="1"> <thead> <tr> <th>Article No.</th> </tr> </thead> <tbody> <tr> <td>3WA9111-0AP03</td> </tr> </tbody> </table> </td> </tr> </tbody> </table>		Protective covers IP55			<ul style="list-style-type: none"> Cannot be used in conjunction with door sealing frames Hood removable and can be opened on both sides 	<table border="1"> <thead> <tr> <th>Article No.</th> </tr> </thead> <tbody> <tr> <td>3WA9111-0AP03</td> </tr> </tbody> </table>	Article No.	3WA9111-0AP03
Protective covers IP55								
	<ul style="list-style-type: none"> Cannot be used in conjunction with door sealing frames Hood removable and can be opened on both sides 							
	<table border="1"> <thead> <tr> <th>Article No.</th> </tr> </thead> <tbody> <tr> <td>3WA9111-0AP03</td> </tr> </tbody> </table>	Article No.	3WA9111-0AP03					
Article No.								
3WA9111-0AP03								

1

Arc chute, arc chute cover

Arc chute																										
	Voltage	Size	Breaking capacity	Article No.																						
	690 V AC	1	N, S	3WA9111-0AS01																						
			M	3WA9111-0AS02																						
		2	S, M, H	3WA9111-0AS10																						
			C	3WA9111-0AS11																						
		3	H	3WA9111-0AS17																						
			C	3WA9111-0AS18																						
	1000 V AC	1	E	For fixed-mounted breakers	3WA9111-0AS04																					
				For withdrawable circuit breakers	3WA9111-0AS05																					
		2	E		3WA9111-0AS12																					
					3WA9111-0AS18																					
		3	E		3WA9111-0AS13																					
				3WA9111-0AS14																						
600 V DC	2	D		3WA9111-0AS13																						
1000 V DC	2	E		3WA9111-0AS14																						
<table border="1"> <thead> <tr> <th colspan="2">Arc chute cover</th> </tr> </thead> <tbody> <tr> <td rowspan="2">  </td> <td> <ul style="list-style-type: none"> Parts kit for guide frame Spare part for option R10 Not available for: <ul style="list-style-type: none"> Breaking capacity C, D and E 4000 A size 2 </td> </tr> <tr> <td> <table border="1"> <thead> <tr> <th>Number of poles</th> <th>Size</th> <th>Article No.</th> </tr> </thead> <tbody> <tr> <td rowspan="3">3-pole</td> <td>1</td> <td>3WA9111-0AS31</td> </tr> <tr> <td>2</td> <td>3WA9111-0AS32</td> </tr> <tr> <td>3</td> <td>3WA9111-0AS33</td> </tr> <tr> <td rowspan="3">4-pole</td> <td>1</td> <td>3WA9111-0AS41</td> </tr> <tr> <td>2</td> <td>3WA9111-0AS42</td> </tr> <tr> <td>3</td> <td>3WA9111-0AS43</td> </tr> </tbody> </table> </td> </tr> </tbody> </table>					Arc chute cover			<ul style="list-style-type: none"> Parts kit for guide frame Spare part for option R10 Not available for: <ul style="list-style-type: none"> Breaking capacity C, D and E 4000 A size 2 	<table border="1"> <thead> <tr> <th>Number of poles</th> <th>Size</th> <th>Article No.</th> </tr> </thead> <tbody> <tr> <td rowspan="3">3-pole</td> <td>1</td> <td>3WA9111-0AS31</td> </tr> <tr> <td>2</td> <td>3WA9111-0AS32</td> </tr> <tr> <td>3</td> <td>3WA9111-0AS33</td> </tr> <tr> <td rowspan="3">4-pole</td> <td>1</td> <td>3WA9111-0AS41</td> </tr> <tr> <td>2</td> <td>3WA9111-0AS42</td> </tr> <tr> <td>3</td> <td>3WA9111-0AS43</td> </tr> </tbody> </table>	Number of poles	Size	Article No.	3-pole	1	3WA9111-0AS31	2	3WA9111-0AS32	3	3WA9111-0AS33	4-pole	1	3WA9111-0AS41	2	3WA9111-0AS42	3	3WA9111-0AS43
Arc chute cover																										
	<ul style="list-style-type: none"> Parts kit for guide frame Spare part for option R10 Not available for: <ul style="list-style-type: none"> Breaking capacity C, D and E 4000 A size 2 																									
	<table border="1"> <thead> <tr> <th>Number of poles</th> <th>Size</th> <th>Article No.</th> </tr> </thead> <tbody> <tr> <td rowspan="3">3-pole</td> <td>1</td> <td>3WA9111-0AS31</td> </tr> <tr> <td>2</td> <td>3WA9111-0AS32</td> </tr> <tr> <td>3</td> <td>3WA9111-0AS33</td> </tr> <tr> <td rowspan="3">4-pole</td> <td>1</td> <td>3WA9111-0AS41</td> </tr> <tr> <td>2</td> <td>3WA9111-0AS42</td> </tr> <tr> <td>3</td> <td>3WA9111-0AS43</td> </tr> </tbody> </table>	Number of poles	Size	Article No.	3-pole	1	3WA9111-0AS31	2	3WA9111-0AS32	3	3WA9111-0AS33	4-pole	1	3WA9111-0AS41	2	3WA9111-0AS42	3	3WA9111-0AS43								
Number of poles	Size	Article No.																								
3-pole	1	3WA9111-0AS31																								
	2	3WA9111-0AS32																								
	3	3WA9111-0AS33																								
4-pole	1	3WA9111-0AS41																								
	2	3WA9111-0AS42																								
	3	3WA9111-0AS43																								

Coding for withdrawable version

Coding for withdrawable version							
	<ul style="list-style-type: none"> Variant coding by the customer with 36 coding options 						
	<table border="1"> <thead> <tr> <th>Size</th> <th>Article No.</th> </tr> </thead> <tbody> <tr> <td>1, 2</td> <td>3WA9111-0AR11</td> </tr> <tr> <td>3</td> <td>3WA9111-0AR12</td> </tr> </tbody> </table>	Size	Article No.	1, 2	3WA9111-0AR11	3	3WA9111-0AR12
	Size	Article No.					
1, 2	3WA9111-0AR11						
3	3WA9111-0AR12						

Accessories and spare parts

Grounding connection

Grounding connection between the guide frame and the circuit breaker



- Up to 30 kA or 60 kA ground-fault current
- 2 modules must be used for up to 60 kA ground-fault current

Contact module	Size	Number of poles	Article No.
For guide frames	1, 2 ¹⁾		3WA9111-0BG01
	3		3WA9111-0BG02
For withdrawable circuit breakers	1	3-pole	3WA9111-0BG11
		4-pole	3WA9111-0BG21
	2	3-pole ¹⁾	3WA9111-0BG12
		4-pole ¹⁾	3WA9111-0BG22
	3	3-pole ²⁾	3WA9111-0BG13
		4-pole ²⁾	3WA9111-0BG23

¹⁾ Cannot be used for size 2 with breaking capacity C and size 2, 4000 A.

²⁾ Not for breaking capacity E

Support bracket

Support bracket



- For mounting fixed-mounted circuit breakers on vertical plane
- Only for sizes 1 and 2 (1 set = 2 units)

Article No.
3WA9111-0BB50

Modules of the CubicleBUS

COM190 PROFINET IO/Modbus TCP communications module ¹⁾



Version

Including adapter for mounting on the secondary disconnect terminal system of the circuit breaker, adapter for mounting on DIN rail, connecting cables and **CubicleBUS** terminating resistor

Article No.
3WA9111-0EC13

COM150 communications module Modbus RTU



Version

Including adapter for mounting on the secondary disconnect terminal system of the circuit breaker, adapter for mounting on DIN rail, connecting cables and **CubicleBUS** terminating resistor

Article No.
3WA9111-0EC15

IOM230 digital input/output module (2 inputs and 3 outputs)



Version

Including adapter for mounting on the secondary disconnect terminal system of the circuit breaker, adapter for mounting on DIN rail, connecting cables and terminating resistor for **CubicleBUS**

- Type of output contact: NO
- Maximum uninterrupted current of an output at 110 ... 230 V AC: 0.2 A

Article No.
3WA9111-0EC11

IOM350 digital input/output module (3 inputs and 5 outputs)



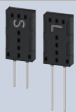
Version

For mounting on DIN rail, including connecting cables and terminating resistor for **CubicleBUS**

- Type of output contact: CO
- Maximum uninterrupted current of an output at 110 ... 230 V AC: 10 A

Article No.
3WA9111-0EC12

Terminating resistor for CubicleBUS



Version

For **CubicleBUS** on the last module

Article No.
3WA9111-0EC50

Adapters



Version

For mounting the modules of the **CubicleBUS** on the secondary disconnect terminal system of the circuit breaker

For mounting the modules of the **CubicleBUS** on DIN rail

Article No.
3WA9111-0EC60
3WA9111-0EC61

ZSI200 Zone-selective interlocking module



Version

Including adapter for mounting on the secondary disconnect terminal system of the circuit breaker, adapter for mounting on DIN rail, connecting cables and terminating resistor for **CubicleBUS**

Article No.
3WA9111-0EC10

¹⁾ For connecting the Ethernet cable, connectors angled 90° to the right are recommended, e.g. PROFINET connector 6GK1901-1BB20-2AA0.

Internal voltage tap

Set of components for conversion of an existing internal voltage tap on the main conducting paths				
Conversion	Circuit breaker	Size	Article No.	
From bottom to top	3-pole	1	3WA9111-0EK11	
		2	3WA9111-0EK12	
		3	3WA9111-0EK13	
	4-pole	1	3WA9111-0EK21	
		2	3WA9111-0EK22	
		3	3WA9111-0EK23	
From top to bottom	3-pole	1	3WA9111-0EK31	
		2	3WA9111-0EK32	
		3	3WA9111-0EK33	
	4-pole	1	3WA9111-0EK41	
		2	3WA9111-0EK42	
		3	3WA9111-0EK43	

Retrofit of the internal voltage tap on the lower main conducting paths				
For breaking capacity	Set for circuit breaker	Size	Article No.	
N, S, M, H, C with VTM680 voltage tap module, with power supply of ETU600	3-pole	1	3WA9111-0EK51	
		2	3WA9111-0EK52	
		3	3WA9111-0EK53	
	4-pole	1	3WA9111-0EK61	
		2	3WA9111-0EK62	
		3	3WA9111-0EK63	
E with VTM640 voltage tap module	3-pole	1	3WA9111-0EK55	
		2	3WA9111-0EK56	
		3	3WA9111-0EK57	
	4-pole	1	3WA9111-0EK65	
		2	3WA9111-0EK66	
		3	3WA9111-0EK67	

Retrofit kit to connect an external voltage transformer		
Size	Article No.	
2, 3 including VTM640 voltage tap module and the necessary connection components	3WA9111-0EK81	

Voltage tap module			
Version	For breaking capacity	Article No.	
VTM680, with power supply of ETU600 ¹⁾	N, S, M, H, C	3WA9111-0EM12	
VTM640	E	3WA9111-0EM11	

Main conductor connections, fixed-mounted versions

Front-accessible main connections according to DIN 43673, double hole for main connection at top			
Size	Breaking capacity Rated current I_n		Article No.
1	N, S ≤ 1000 A AC		3WA9111-0AL11
	N, S 1250 ... 2000 A AC; M, E ≤ 2000 A AC		3WA9111-0AL12
2	S, M, H, E 2000 A AC; D, E ≤ 2000 A DC		3WA9111-0AL21
	S, M, H, E 2500 A AC		3WA9111-0AL22
	S, M, H, E 3200 A AC; D, E 4000 A DC		3WA9111-0AL23
3	4000 A AC (up to a max. short-circuit current of 100 kA)		3WA9111-0AL31

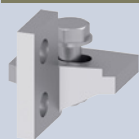
Front-accessible main connections according to DIN 43673, double hole for main connection at bottom			
Size	Breaking capacity Rated current I_n		Article No.
1	N, S ≤ 1000 A AC		3WA9111-0AL13
	N, S 1250 ... 2000 A AC; M, E ≤ 2000 A AC		3WA9111-0AL14
2	S, M, H, E 2000 A AC; D, E ≤ 2000 A DC		3WA9111-0AL24
	S, M, H, E 2500 A AC		3WA9111-0AL25
	S, M, H, E 3200 A AC; D, E 4000 A DC		3WA9111-0AL26
3	4000 A AC (up to a max. short-circuit current of 100 kA)		3WA9111-0AL32

¹⁾ When replacing the VTM680 voltage tap module in an 3WA air circuit breaker with an ID number lower than ID No. OE/230101500000, the internal cable harness of the voltage tap must also be replaced. In this case, the accessory "Retrofit of the internal voltage tap on the lower main conducting paths" is required.

Accessories and spare parts

Main conductor connections, fixed-mounted versions

Rear vertical main connections



Size	Breaking capacity Rated current I_n	Article No.
1	N, S, M, E ≤ 2000 A AC ¹⁾	3WA9111-0AM11
	N, S, M, E 2500 A AC	3WA9111-0AM12
2	S, M, H, C, E ≤ 3200 A AC ²⁾	3WA9111-0AM21
3	H, C, E ≤ 6300 A AC	3WA9111-0AM33

¹⁾ In the case of vertical connection size 1 with breaking capacity N and S, up to 1000 A one 3WA9111-0AM11 vertical connection is required for each connection, from 1250 A to 2000 A or with breaking capacity M or E two 3WA9111-0AM11 vertical connections are required for each connection.

²⁾ In the case of vertical connection size 2, up to 2500 A one 3WA9111-0AM21 vertical connection is required for each connection for breaking capacity S, M, H, E, D, for 3200 A and always for breaking capacity C, two 3WA9111-0AM21 vertical connections are required for each connection

Main conductor connections for withdrawable units

Front-accessible main connections according to DIN 43673, double hole at top or at bottom¹⁾



Size	Breaking capacity Rated current I_n	Article No.
1	N, S ≤ 1000 A AC	3WA9111-0AN11
	N, S 1250 ... 2000 A AC; M, E ≤ 2000 A AC A	3WA9111-0AN12
2	N, S 1250 ... 2000 A AC; M, E ≤ 2000 A AC	3WA9111-0AN21
	S, M, H, E 2500 A AC	3WA9111-0AN22
	S, M, H, E 3200 A AC; D, E 4000 A DC	3WA9111-0AN23
3	H 4000 A AC	3WA9111-0AN31

Supports for front-accessible main connections according to DIN 43673



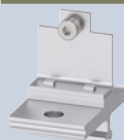
Number of poles	Size	Article No.
3-pole, set for 3 bars, top or bottom	1	3WA9111-0AN81
	2	3WA9111-0AN82
	3	3WA9111-0AN83
4-pole, set for 4 bars, top or bottom	1	3WA9111-0AN84
	2	3WA9111-0AN85
	3	3WA9111-0AN86

Rear vertical main connections



Size	Breaking capacity Rated current I_n	Article No.
1	N, S ≤ 1000 A AC	3WA9111-0AV11
	N, S 1250 ... 2000 A AC; M, E ≤ 2000 A AC	3WA9111-0AV12
2	S, M, H, E 2000 A AC; D, E ≤ 2000 A DC ²⁾	3WA9111-0AV21
	S, M, H, E 2500 A AC ²⁾	3WA9111-0AV22
	S, M, H, E 3200 A AC; D, E 4000 A DC ²⁾	3WA9111-0AV23
	C 2000 ... 3200 A AC	3WA9111-0AV24
3	H, C, E ≤ 5000 A AC	3WA9111-0AV31

Rear horizontal main connections



Size	Breaking capacity Rated current I_n	Article No.
1	N, S ≤ 1000 A AC	3WA9111-0AX11
	N, S 1250 ... 2000 A AC; M, E ≤ 2000 A AC	3WA9111-0AX12
2	S, M, H, E 2000 A AC; D, E ≤ 2000 A DC ²⁾	3WA9111-0AX21
	S, M, H, E 2500 A AC ²⁾	3WA9111-0AX22
	S, M, H, E 3200 A AC; D, E 4000 A DC ²⁾	3WA9111-0AX23
	C 2000 ... 3200 A AC	3WA9111-0AX24
3	H, C, E ≤ 5000 A AC	3WA9111-0AX31

Connecting flange



Size	Breaking capacity Rated current I_n	Article No.
1	N, S ≤ 1000 A AC	3WA9111-0AW11
	N, S 1250 ... 2000 A AC; M, E ≤ 2000 A AC	3WA9111-0AW12
2	S, M, H, E 2000 A AC; D, E ≤ 2000 A DC	3WA9111-0AW21
	S, M, H, E 2500 A AC	3WA9111-0AW22
	S, M, H, E 3200 A AC; D, E 4000 A DC	3WA9111-0AW23
3	H 4000 A AC	3WA9111-0AW31

¹⁾ When using front-accessible main connections (withdrawable circuit breakers) supports are required

²⁾ Not for circuit breakers with very high breaking capacity C

Conversion kit

Conversion kit for converting fixed-mounted circuit breakers into withdrawable circuit breakers



- Guide frames and sliding contact modules must be ordered separately
- Conversion from fixed-mounted to withdrawable circuit breakers is not possible for 3WA circuit breakers with breaking capacity C and breaking capacity E

Number of poles	Size	Article No.
3-pole	1	3WA9111-0BC11
	2	3WA9111-0BC12
	3	3WA9111-0BC13
4-pole	1	3WA9111-0BC14
	2	3WA9111-0BC15
	3	3WA9111-0BC16

Main contact elements

Main contact elements for AC circuit breakers



- **Notes:**
 - To be ordered only once for each circuit breaker
 - On the following circuit breakers, the main contact elements can only be replaced in the factory:
3WA1 size 1 breaking capacity M and E
3WA1 size 2 breaking capacity C
3WA1 size 3 breaking capacity C and E

Number of poles	Size	Breaking capacity	Rated current I_n	Article No.	
3	1	N	≤ 1000 A	3WA9111-0AQ01	
			1250 A	3WA9111-0AQ02	
		1600 A	3WA9111-0AQ04		
		S	≤ 1000 A	3WA9111-0AQ03	
			1250 ... 1600 A	3WA9111-0AQ04	
	2	S, M, H, E	2000 A	3WA9111-0AQ08	
			2500 A	3WA9111-0AQ11	
			3200 A	3WA9111-0AQ13	
			4000 A	3WA9111-0AQ15	
			4000 A	3WA9111-0AQ20	
5000 ... 6300 A			3WA9111-0AQ22		
4	1	N	≤ 1000 A	3WA9111-0AQ51	
			1250 A	3WA9111-0AQ52	
			1600 A	3WA9111-0AQ54	
		S	≤ 1000 A	3WA9111-0AQ53	
			1250 ... 1600 A	3WA9111-0AQ54	
		2	S	2000 A	3WA9111-0AQ58
				2500 A	3WA9111-0AQ61
	3200 A			3WA9111-0AQ63	
	4000 A			3WA9111-0AQ65	
	3	H	4000 A	3WA9111-0AQ70	
			4000 A	3WA9111-0AQ72	
			5000 ... 6300 A	3WA9111-0AQ72	

Main contact elements for DC non-automatic circuit breakers



- **Note:** To be ordered only once for each circuit breaker

Number of poles	Size	Breaking capacity	Rated current I_n	Article No.
3	2	D, E	1000/2000 A	3WA9111-0AQ17
			4000 A	3WA9111-0AQ18
4	2	D, E	1000/2000 A	3WA9111-0AQ67
			4000 A	3WA9111-0AQ68

Accessories and spare parts

Interfaces

Interface to the IEC 61850

- The SICAM A8000 smart data concentrator connects the circuit breakers from the SENTRON portfolio via the Modbus TCP/IP protocol and transmits data via communication protocols (e.g.: IEC 61850, IEC 60870-5-104, IEC 60870-5-101, Modbus and DNP) to higher-level systems.



Type	Operational voltage	Article No.
SICAM CP-8021 ¹⁾	–	6MF2802-1AA00
SICAM CP-8031 ²⁾	–	6MF2803-1AA00
SICAM CP-8050 ²⁾	–	6MF2805-0AA00
SICAM PS-8620	24 ... 60 V DC (12 W)	6MF2862-0AA00
SICAM PS-8622	110 ... 220 V DC (12 W)	6MF2862-2AA00

¹⁾ Dimensioned for device quantities of max. 1 × 3WA and 1 × 3VA

²⁾ Dimensioned for device quantities of max. 1 × 3WA and 8 × 3VA

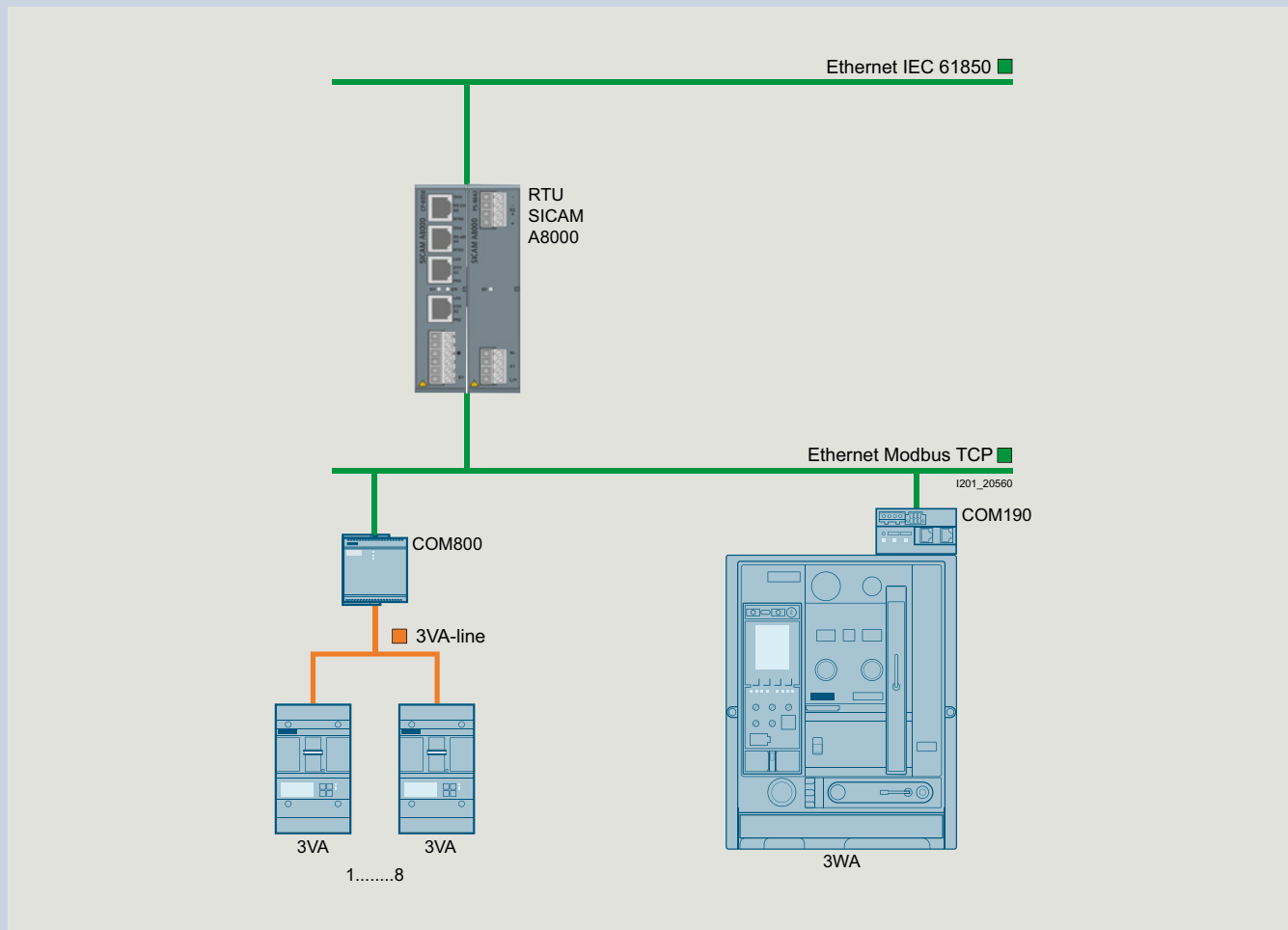
³⁾ Dimensioned for device quantities of max. 3 × 3WA and 8 × 3VA or 2 × 3WA and 8 × 3VA and 1 × PAC4200

You will find further information at:

www.siemens.com/sicam-a8000

For the SICAM CP-8021 and SICAM CP-8050, predefined modules were created to reduce commissioning work to a minimum.

The modules can be obtained free of charge via SiePortal www.siemens.com/lowvoltage/product-support (109816057)



3WL1 circuit breakers and non-automatic circuit breakers for AC and DC

IEC 60947-2

AC



3WL10

3WL11

Basic data		3WL10		3WL11				
Rated operational voltage U_e	V	≤ 690		≤ 1000				
Rated current I_n	A	630 ... 1250		630 ... 2000				
Size		0		1				
Type of mounting		Withdrawable	Fixed-mounted	Withdrawable	Fixed-mounted			
Number of poles		3/4-pole	3/4-pole	3/4-pole	3/4-pole			
Dimensions								
Width (3-pole 4-pole)	mm	278 348	210 280	320 410	320 410			
Height (standard A05, A15, A16, DC greater than 600 V)	mm	363.5	296	468 518	462			
Depth	mm	271	183	471	357			
Approvals								
General product approvals		VDE, EAC, CCC, CE, C-Tick		VDE, EAC, CCC, CE, C-Tick				
Marine/shipbuilding		RMRS		ABS, DNV, LR, BV, GL, PRS, RMRS				
Breaking capacity								
		B	N	S	N	S	H	
Rated short-circuit breaking capacity								
Rated operational voltage U_e up to 415 V AC $I_{cu} I_{cs}$	kA	42 42	55 50	66 50	55 55	66 66	85 85	
Rated operational voltage U_e up to 500 V AC $I_{cu} I_{cs}$	kA	42 42	50 50	50 50	55 55	66 66	85 85	
Rated operational voltage U_e up to 690 V AC $I_{cu} I_{cs}$	kA	– –	42 42	50 50	42 42	50 50	66 66 ⁶⁾	
Rated operational voltage U_e up to 690 V AC +20% ⁶⁾ , with Z option: A16 $I_{cu} I_{cs}$	kA	– –	– –	– –	– –	– –	50 50	
Rated operational voltage U_e up to 1000 V AC, with Z option: A05 $I_{cu} I_{cs}$	kA	– –	– –	– –	– –	– –	50 50	
Rated operational voltage U_e up to 1150 V AC, with Z option: A15 $I_{cu} I_{cs}$	kA	– –	– –	– –	– –	– –	– –	
Rated short-time withstand current I_{cw} ⁵⁾								
Rated short-time withstand current I_{cw} at U_e up to 500 V AC	0.5 s	kA	–	–	–	55	66	85
	1 s	kA	42	42	50	50	66	85
	2 s	kA	–	–	–	35 ^{1)/45²⁾}	45	70
	3 s	kA	24	24	36	35 ^{1)/45²⁾}	35	60
Rated short-time withstand current I_{cw} at U_e up to 690 V AC	0.5 s	kA	–	–	–	42	50	66 ⁷⁾
	1 s	kA	42	42	50	42	50	66 ⁷⁾
	2 s	kA	–	–	–	35 ^{1)/42²⁾}	45	66 ⁸⁾
	3 s	kA	24	24	36	30 ^{1)/45²⁾}	35	60
Rated short-time withstand current I_{cw} at DC	1 s	kA	–	–	–	–	–	–
Rated conditional short-circuit current I_{cc} of the non-automatic air circuit breakers								
Up to 500 V AC	kA	–	42	50	55	66	85	
Up to 690 V AC	kA	–	42	50	42	50	66	
Up to 1000 V/1150 V AC, with Z option: A05, A16	kA	–	–	–	–	–	50	
Up to 1000 V/1150 V AC, with Z option: A15	kA	–	–	–	–	–	–	
Up to 220 V DC	kA	–	–	–	–	–	–	
Up to 300 V DC	kA	–	–	–	–	–	–	
Up to 600 V DC	kA	–	–	–	–	–	–	
Up to 1000 V DC	kA	–	–	–	–	–	–	
Rated short-circuit making capacity I_{cm}								
I_{cm} at 415 V AC	kA	88	121	145	121	145	187	
I_{cm} at 500 V AC	kA	88	105	105	121	145	187	
I_{cm} at 690 V AC	kA	–	88	105	88	105	145	
I_{cm} at 1000 V AC	kA	–	–	–	–	–	105	
I_{cm} at 1150 V AC	kA	–	–	–	–	–	–	

¹⁾ Size 1 with $I_{n,max} \leq 1250$ A
²⁾ Size 1 with $I_{n,max} \geq 1600$ A

³⁾ Size 2 with $I_{n,max} \leq 2500$ A
⁴⁾ Size 2 with $I_{n,max} \geq 3200$ A

⁵⁾ At rated operational voltage $U_e > 690$ V, the I_{cw} value of the circuit breaker corresponds to the I_{cu} or I_{cs} value

⁶⁾ For breakers with Z options A05 and A16 $I_{cu} = I_{cs} = 85$ kA

⁷⁾ For breakers with Z options A05 and A16 $I_{cw} = 85$ kA

⁸⁾ For breakers with Z options A05 and A16 $I_{cw} = 70$ kA

AC

DC



3WL12

3WL13

3WL11

3WL12

≤ 1150				≤ 1150			1000 DC		≤ 600/1000 DC					
800 ... 4000				4000 ... 6300			2000		1000 ... 4000					
2				3			1		2					
Withdrawable 3/4-pole		Fixed-mounted 3/4-pole		Withdrawable 3/4-pole		Fixed-mounted 3/4-pole		Fixed-mounted 4-pole		Withdrawable 3/4-pole		Fixed-mounted 3/4-pole		
460 590		460 590		704 914		704 914		410		460 590		460 590		
468 518		462		468 518		462		462		468 518		462		
471		357		471		357		357		471		357		
VDE, EAC, CCC, CE, C-Tick ABS, DNV, LR, BV, GL, PRS, RMRS				VDE, EAC, CCC, VDE, CE, C-Tick ABS, DNV, LR, BV, GL, PRS, RMRS			VDE, EAC, CCC, CE, C-Tick ABS, DNV, LR, BV, GL, PRS, RMRS		VDE, EAC, CCC, CE, C-Tick ABS, DNV, LR, BV, GL, PRS, RMRS					
N	S	H	C ⁹⁾	H	C 3p	C 4p	DC		DC					
66 66	85 85	100 100	130 130	100 100	150 150	130 130	-		-					
66 66	85 85	100 100	130 130	100 100	150 150	130 130	-		-					
50 50	75 75	85 85	100 100	85 85	150 150	130 130	-		-					
- -	- -	- -	- -	- -	- -	- -	-		-					
- -	- -	85 85	- -	85 85	125 125	125 125	-		-					
- -	- -	50 50	- -	70 70	- -	- -	-		-					
66	85	100	100	100	130	120	-		-					
66	85	85	100	100	130	120	-		-					
66	66 ³⁾ /85 ⁴⁾	66 ³⁾ /85 ⁴⁾	85	100	130	120	-		-					
55 ³⁾ /66 ⁴⁾	55 ³⁾ /75 ⁴⁾	55 ³⁾ /75 ⁴⁾	75	100	130	120	-		-					
50	75	85	100	85	130	120	-		-					
50	75	85	100	85	130	120	-		-					
50	66 ³⁾ /75 ⁴⁾	66 ³⁾ /85 ⁴⁾	85	85	130	120	-		-					
50	55 ³⁾ /75 ⁴⁾	55 ³⁾ /75 ⁴⁾	75	85	130	120	-		-					
-	-	-	-	-	-	-	20		35 ¹⁰⁾ /30 ¹¹⁾ /25 ¹²⁾ /20 ¹³⁾					
66	85	100	130	100	130	120	-		-					
50	75	85	100	85	130	120	-		-					
-	-	85/85	-	85/85	-	-	-		-					
-	-	-/50	-	70/70	-	-	-		-					
-	-	-	-	-	-	-	20		35					
-	-	-	-	-	-	-	20		30					
-	-	-	-	-	-	-	20		25					
-	-	-	-	-	-	-	20		20					
145	187	220	286	220	330	286	-		-					
145	187	220	286	220	330	286	-		-					
105	165	187	220	187	330	286	-		-					
-	-	105	-	187	267	267	-		-					
-	-	105	-	147	-	-	-		-					

⁹⁾ Up to 3200 A¹⁰⁾ At $U_e = 220$ V DC¹¹⁾ At $U_e = 300$ V DC¹²⁾ At $U_e = 600$ V DC¹³⁾ At $U_e = 1000$ V DC

3WL1 circuit breakers and non-automatic circuit breakers for AC

IEC 60947-2

1

3WL10



3WL11



Rated current I_n				630 A	800 A	1000 A	1250 A	1000 A	1250 A
General data									
Isolating function acc. to IEC 60947-2				Yes				Yes	
Utilization category				B				B	
Permissible ambient temperature	During operation	°C	-25 ... +70				-40 ... +70		
	(in operation with LCD max. 55 °C) ¹⁾								
Mounting position	Storage	°C	-40 ... +70				-40 ... +80		
Degree of protection				IP20 without cabinet door, IP30 with door sealing frame, IP54 with cover				IP20 without cabinet door, IP41 with door sealing frame, IP55 with cover	
Voltage									
Rated operational voltage U_e at 50/60 Hz	1000 V version	V AC	≤ 690				690/1000		
Rated insulation voltage U_i		V AC	1000				1000		
Rated impulse withstand voltage U_{imp}	Main conducting paths	kV	12				12		
	Auxiliary circuits	kV	4				4		
	Control circuits ³⁾	kV	2.5				2.5		
Rated rotor operational voltage U_{er}		V					2000		
Permissible load for withdrawable versions^{2) 4) 10)}									
At rear horizontal main connections	Up to 55 °C (Cu bare)	A	630	800	1000	1250	1000	1250	
	Up to 60 °C (Cu bare)	A	630	800	1000	1250	1000	1250	
	Up to 70 °C	A	630	800	1000	1250	1000 ⁸⁾	1210 ⁸⁾	
Power loss at I_n									
With 3-phase symmetrical load, complete device (3/4p)	Fixed-mounted circuit breaker	W	31	50	78	122	100	105	
	Withdrawable circuit breaker	W	62	100	156	244	195	205	
Switching times									
Make time		ms	< 20	< 20	< 20	< 20	35		
Opening time		ms	< 20	< 20	< 20	< 20	38		
Electrical make time (through closing coil) ⁵⁾		ms	< 50	< 50	< 50	< 50	80		
Electrical opening time (through shunt trip)		ms	< 35	< 35	< 35	< 35	73		
Electrical opening time (instantaneous undervoltage release)		ms	< 50	< 50	< 50	< 50	≤ 80		
Opening time due to ETU, instantaneous short-circuit release		ms	25	25	25	25	50		
Service life/endurance									
Breaking capacity N and S, 3/4-pole									
Mechanical	Without maintenance	Operating cycles	20000 ³⁾	20000 ³⁾	20000 ³⁾	20000 ³⁾	15000	15000	
	With maintenance ⁶⁾	Operating cycles	–	–	–	–	25000	25000	
Electrical	Without maintenance 440 V	Operating cycles	8000 ^{3) 7)}	8000 ^{3) 7)}	8000 ^{3) 7)}	8000 ^{3) 7)}	–	–	
	Without maintenance 690 V	Operating cycles	8000 ^{3) 7)}	8000 ^{3) 7)}	8000 ^{3) 7)}	6500 ^{3) 7)}	10000	10000	
	With maintenance ⁶⁾	Operating cycles	–	–	–	–	25000	25000	
Breaking capacity H, 3-pole									
Mechanical	Without maintenance	Operating cycles	–	–	–	–	10000	10000	
	With maintenance ⁶⁾	Operating cycles	–	–	–	–	15000	15000	
Electrical	Without maintenance 690 V	Operating cycles	–	–	–	–	7500	7500	
	Without maintenance 1000 V, with Z option: A05	Operating cycles	–	–	–	–	1000	1000	
	Without maintenance 1150 V, with Z option: A15	Operating cycles	–	–	–	–	–	–	
	With maintenance ⁶⁾	Operating cycles	–	–	–	–	15000	15000	

¹⁾ The LCD on the 3WL10 is always active.

²⁾ 4000 A, size 2 in fixed-mounted version, 3-pole

³⁾ 2000 in conjunction with mechanical interlock

⁴⁾ ETU76B with graphics display can be used up to max. 55 °C.

⁵⁾ Make time through closing coil for synchronization purposes (short-time excited) 50 ms.

⁶⁾ Maintenance means: Replacing main contact elements and arches (see operating instructions). Greasing the breaker mechanism on the 3WL10, no spare part of components.

3WL11

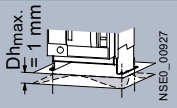
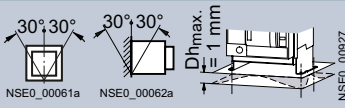
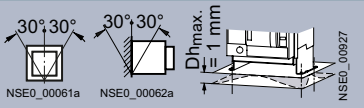


3WL12



3WL13



3WL11					3WL12					3WL13		
1600 A	2000 A	800 A	1000 A	1250 A	1600 A	2000 A	2500 A	3200 A	4000 A	4000 A	5000 A	6300 A
Yes					Yes					Yes		
B					B					B		
-40 ... +70					-40 ... +70					-40 ... +70		
-40 ... +80					-40 ... +80					-40 ... +80		
												
IP20 without cabinet door, IP41 with door sealing frame, IP55 with cover					IP20 without cabinet door, IP41 with door sealing frame, IP55 with cover					IP20 without cabinet door, IP41 with door sealing frame, IP55 with cover		
690/1000					690/1000/1150					690/1000/1150		
1000					≤ 1150					≤ 1150		
12					12					12		
4					4					4		
2.5					2.5					2.5		
2000					2000					2000		
1600	2000	800	1000	1250	1600	2000	2500	3200	3950	4000	5000	5920
1600	1930	800	1000	1250	1600	2000	2500	3020	3810	4000	5000	5810
1490 ⁸⁾	1780 ⁸⁾	800 ⁸⁾	1000 ⁸⁾	1250 ⁸⁾	1600 ⁸⁾	2000 ⁸⁾	2280 ⁸⁾	2870 ⁸⁾	3600 ⁸⁾	4000 ⁸⁾	5000 ⁸⁾	5500 ⁸⁾
150	240	40	45	80	85	180	270	410	750	520	630	900
350	440	85	95	165	175	320	520	710	925	810	1050	1600
35					35					35		
38					34					34		
80					100					100		
73					73					73		
≤ 80					≤ 80					≤ 80		
50					50					50		
15000	15000	10000	10000	10000	10000	10000	10000	10000	10000	-	-	-
25000	25000	17500	17500	17500	17500	17500	17500	17500	17500	-	-	-
-	-	-	-	-	-	-	-	-	-	-	-	-
10000	7500	7500	7500	7500	7500	7500	7500	4000	2000 ³⁾	-	-	-
25000	25000	17500	17500	17500	17500	17500	17500	17500	17500	-	-	-
10000	10000	10000	10000	10000	10000	10000	10000	10000	10000	5000	5000	5000
15000	15000	15000	15000	15000	15000	15000	15000	15000	15000	10000	10000	10000
7500	7500	7500	7500	7500	7500	7500	7500	4000	2000	2000	2000	2000
1000	1000	1000	1000	1000	1000	1000	1000	1000	1000	1000	1000	1000
-	-	500	500	500	500	500	500	500	500	500	500	500
15000	15000	15000	15000	15000	15000	15000	15000	15000	15000	10000	10000	10000

⁷⁾ Periodic greasing of breaker mechanism on the 3WL10 (see Manual), no spare part of components

⁹⁾ Motorized operating mechanisms $U_{imp} = 1.2$ kV

¹⁰⁾ For 3WL size 2 4000 A and size 3 6300 A with rear vertical main connections.

⁸⁾ Cu painted black

3WL1 circuit breakers and non-automatic circuit breakers for AC

IEC 60947-2 (continued)

3WL10



3WL11



Rated current I_n			630 A	800 A	1000 A	1250 A	1000 A	1250 A
Service life/endurance								
Breaking capacity H, 4-pole								
Mechanical	Without maintenance	Operating cycles	–	–	–	–	10000	10000
	With maintenance ¹⁾	Operating cycles	–	–	–	–	15000	15000
Electrical	Without maintenance 690 V	Operating cycles	–	–	–	–	7500	7500
	Without maintenance 1000 V	Operating cycles	–	–	–	–	1000	1000
	Without maintenance 1150 V ²⁾	Operating cycles	–	–	–	–	–	–
	With maintenance ¹⁾	Operating cycles	–	–	–	–	10000	10000
Breaking capacity C								
Mechanical	Without maintenance	Operating cycles	–	–	–	–	–	–
	With maintenance ¹⁾	Operating cycles	–	–	–	–	–	–
Electrical	Without maintenance 690 V	Operating cycles	–	–	–	–	–	–
	With maintenance 690 V ¹⁾	Operating cycles	–	–	–	–	–	–
Switching frequency ⁸⁾								
Mechanical/electrical	690 V version	1/h	60/30	60/30	60/30	60/30	–	–
	1000 V/1150 V version	1/h	–	–	–	–	–	–
Connection								
Minimum main conductor cross-sections								
Copper bars, bare	Unit, mm ²		2 × 40 × 5	2 × 50 × 5	2 × 50 × 10 ⁵⁾ 2 × 50 × 8 ⁶⁾	2 × 50 × 10 ⁵⁾ 2 × 50 × 8 ⁵⁾	1 × 60 × 102 × 40 × 10	
Copper bars, painted black	Unit, mm ²		–	–	–	–	1 × 60 × 102 × 40 × 10	
Auxiliary conductor (Cu) max. number of auxiliary conductors × cross-section (solid/stranded)								
Standard connection = screw	Without end sleeve				–		2 × 0.5 ... 2 × 1.5 mm ² (AWG 20 ... 16); 1 × 2.5 mm ² (AWG 14)	
	With end sleeve acc. to DIN 46228 Part 2				–		1 × 0.5 ... 1 × 1.5 mm ² (AWG 20 ... 16)	
	With twin end sleeve				–		2 × 0.5 ... 2 × 1.5 mm ² (AWG 20 ... 16)	
Screwless connection technology	Without end sleeve			0.5 ... 2.5 mm ² (AWG 20 ... 14)			2 × 0.5 ... 2 × 2.5 mm ² (AWG 20 ... 14)	
	With end sleeve acc. to DIN 46228 Part 2			0.5 ... 1.5 mm ² (AWG 20 ... 16)			2 × 0.5 ... 2 × 1.5 mm ² (AWG 20 ... 16)	
Position signaling switch								
Screwless connection technology					1 × 0.5 ... 1 × 2.5 mm ² (AWG 20 ... 14)		1 × 0.5 ... 1 × 2.5 mm ² (AWG 20 ... 14)	
Weights								
3-pole	Fixed-mounted circuit breaker	kg			14		43	43
	Withdrawable circuit breaker (without guide frames)	kg			17.3		45	45
	Guide frames	kg			21		25	25
4-pole	Fixed-mounted circuit breaker	kg			16		50	50
	Withdrawable circuit breaker (without guide frames)	kg			19.3		54	54
	Guide frames	kg			25		30	30

¹⁾ Maintenance means: Replacing main contact elements and arc chutes (see operating instructions).

²⁾ Size 2 with order code "A15" and size 3. Data for very high breaking capacity.
³⁾ Operating cycles per hour

⁴⁾ 3-pole breakers with breaking capacity N and S: 45/h.

⁵⁾ Horizontal

⁶⁾ Vertical

3WL1 non-automatic circuit breakers for DC

IEC 60947-2

1



Rated current I_n			2000 A	1000 A	2000 A	4000 A
General data						
Size			1		2	
Isolating function acc. to IEC 60947-2			Yes		Yes	
Utilization category			B		B	
Permissible ambient temperature	Operation	°C	-40 ... +70		-40 ... +70	
	Storage	°C	-40 ... +80		-40 ... +80	
Mounting position						
Degree of protection			IP20 without cabinet door, IP41 with door sealing frame, IP55 with cover		IP20 without cabinet door, IP41 with door sealing frame, IP55 with cover	
Voltage						
Rated operational voltage U_e at 50/60 Hz	1000 V version	V DC	1000		600/1000	
Rated insulation voltage U_i		V DC	1000		1000	
Rated impulse withstand voltage U_{imp}	Main conducting paths	kV	12		12	
	Auxiliary circuits	kV	4		4	
	Control circuits	kV	2.5		2.5	
Permissible load						
At rear horizontal main connections	Up to 40 °C (Cu black painted)	A	2000	1000	2000	4000
	Up to 55 °C (Cu black painted)	A	1910	1000	2000	3640
	Up to 60 °C (Cu black painted)	A	1850	1000	2000	3500
	Up to 70 °C (Cu black painted)	A	1710	1000	1950	3250
Power loss at I_n						
With symmetrical load	Withdrawable circuit breaker	W	150	280	770	1640
Switching times						
Make time		ms	35		35	
Opening time		ms	38		34	
Electrical make time (through activation solenoid) ¹⁾		ms	100		100	
Electrical opening time (through shunt trip)		ms	73		73	
Electrical opening time (instantaneous undervoltage release)		ms	≤ 80		≤ 80	
Service life/endurance³⁾						
Mechanical	Without maintenance	Operating cycles	10000	10000	10000	10000
	With maintenance ²⁾	Operating cycles	15000	17500	17500	17500
Electrical	Without maintenance	Operating cycles	1000	6000	6000	4000
	Without maintenance 1000 V	Operating cycles	1000	1000	1000	1000
	With maintenance ²⁾	Operating cycles	2000	17500	17500	17500

¹⁾ Make time through activation solenoid for synchronization purposes (short-time excited) 50 ms.

²⁾ Maintenance means: Replace main contact elements and arc chutes (see operating instructions).

³⁾ Further technical specifications on request.

⁴⁾ At $U_e = 220$ V DC

⁵⁾ At $U_e = 300$ V DC

⁶⁾ At $U_e = 600$ V DC

⁷⁾ At $U_e = 1000$ V DC




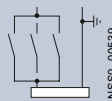
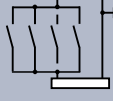
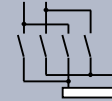

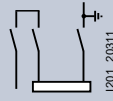
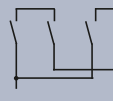


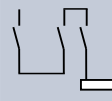

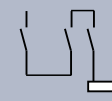
Rated current I_n			2000 A	1000 A	2000 A	4000 A
Short-circuit breaking capacity I_{cc}						
Up to 220 V DC	kA		20		35	
Up to 300 V DC	kA		20		30	
Up to 600 V DC	kA		20		25	
Up to 1000 V DC	kA		20		20	
Rated short-time withstand current I_{cw}						
0.5 s	kA		–		–	
1 s	kA		20		35 ⁴⁾ /30 ⁵⁾ /25 ⁶⁾ /20 ⁷⁾	
2 s	kA		–		–	
3 s	kA		–		–	
Switching frequency						
690 V version	1/h		–	60	60	60
1000 V version	1/h		20	20	20	20
Connection						
Auxiliary conductor (Cu) max. number of auxiliary conductors × cross-section (solid/stranded)						
Standard connection = strain-relief clamp	Without end sleeve		2 × 0.5 ... 2 × 1.5 mm ² (AWG 20 ... 16); 1 × 2.5 mm ² (AWG 14)		2 × 0.5 ... 2 × 1.5 mm ² (AWG 20 ... 16); 1 × 2.5 mm ² (AWG 14)	
	With end sleeve acc. to DIN 46228 Part 2		1 × 0.5 ... 1 × 1.5 mm ² (AWG 20 ... 16)		1 × 0.5 ... 1 × 1.5 mm ² (AWG 20 ... 16)	
	With twin end sleeve		2 × 0.5 ... 2 × 1.5 mm ² (AWG 20 ... 16)		2 × 0.5 ... 2 × 1.5 mm ² (AWG 20 ... 16)	
Optional connection = tension spring	Without end sleeve		2 × 0.5 ... 2 × 2.5 mm ² (AWG 20 ... 14)		2 × 0.5 ... 2 × 2.5 mm ² (AWG 20 ... 14)	
	With end sleeve acc. to DIN 46228 Part 2		2 × 0.5 ... 2 × 1.5 mm ² (AWG 20 ... 16)		2 × 0.5 ... 2 × 1.5 mm ² (AWG 20 ... 16)	
Weights						
3-pole	Fixed-mounted circuit breaker	kg	43	56	56	64
	Withdrawable circuit breaker	kg	–	60	60	68
	Guide frames	kg	–	31	31	45
4-pole	Fixed-mounted circuit breaker	kg	50	67	67	77
	Withdrawable circuit breaker	kg	–	72	72	82
	Guide frames	kg	–	37	37	54

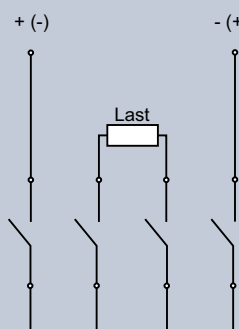
3WL1 non-automatic circuit breakers for DC

Application examples

The connection to the non-automatic circuit breakers is not dependent on direction and polarity; the circuit diagrams can be adapted accordingly. If the parallel or series connections are made directly to the connection bars, for thermal reasons the continuous load on the non-automatic circuit breakers must only be 80% of the permissible operational current. If the parallel or series connection is made at a distance of 1 m from the connection bars, the non-automatic circuit breaker can be used at full operational current load.

1

Required contact gaps at rated voltage ¹⁾	Size 2 For 3-pole non-automatic circuit breakers		Size 1 and Size 2 For 4-pole non-automatic circuit breakers	
	1-pole	2-pole	1-pole	2-pole
Rated operational voltage up to 300 V				
		Grounded system ²⁾	Grounded system ³⁾	
Rated operational voltage up to 600 V				
		Grounded system	Grounded system ²⁾	
Rated operational voltage up to 1000 V ⁴⁾				
		Grounded system	Grounded system	Grounded system

Required contact gaps at rated voltage ¹⁾	Size 1 For 4-pole non-automatic circuit breakers
	2-pole
Rated operational voltage up to 1000 V ⁴⁾	

¹⁾ Contact gaps connected in series

²⁾ 2 conducting paths in parallel

³⁾ 3 conducting paths in parallel

⁴⁾ Version for 1000 V required, order with "-Z" and order code A05

⏏ Grounded system

□ Load

ETU electronic trip units

With watchdog monitoring

3WL10



		ETU320 (LI)	ETU350 (LSI)	ETU360 (LSIG)
Basic protective functions				
L Overload protection (L tripping)	Setting range of operating value $I_r = I_n \times \dots$	0.4 0.5 0.6 0.7 0.75 0.8 0.85 0.9 0.95 1 Default 0.4	0.4 0.5 0.6 0.7 0.75 0.8 0.85 0.9 0.95 1 Default 0.4	0.4 0.5 0.6 0.7 0.75 0.8 0.85 0.9 0.95 1 Default 0.4
	Switchable overload protection (from I^2t - to I^4t -dependent function)	–	–	–
	Setting range of the delay t_r at I^2t (Reference point $6 \times I_n$)	0.75 1 2 5 8 10 14 17 21 25 s Default 0.75 s	0.75 1 2 5 8 10 14 17 21 25 s Default 0.75 s	0.75 1 2 5 8 10 14 17 21 25 s Default 0.75 s
	Setting range of the delay t_r at I^4t (Reference point $6 \times I_n$)	–	–	–
	Thermal memory can be switched on/off	Permanently switched on	Permanently switched on	Permanently switched on
	Phase failure sensitivity/asymmetry	–	–	–
S Short-time-delayed short-circuit protection (ST tripping)	Setting range of operating value $I_{sd} = I_n \times \dots$	–	1 1.5 2 2.5 3 4 6 8 10 Default OFF	1 1.5 2 2.5 3 4 6 8 10 Default OFF
	Setting range of the delay time t_{sd} at I^2t	–	0.1 0.2 0.3 0.4 0.5 (Ref. $10 \times I_n$)	0.1 0.2 0.3 0.4 0.5 (Ref. $10 \times I_n$)
	Setting range of the delay time t_{sd} ($t = \text{const.}$)	–	0.08 0.15 0.22 0.3 0.4 s	0.08 0.15 0.22 0.3 0.4 s
	ZSI function	–	–	–
I Instantaneous short-circuit protection (INST tripping)	Setting range $I_1 = I_n \times \dots$	OFF 1.5 2 3 4 6 8 10 12 15	OFF 1.5 2 3 4 6 8 10 12 15	OFF 1.5 2 3 4 6 8 10 12 15
N Neutral conductor protection	N conductor setting range $I_N = I_n \times \dots$	OFF 50% 100% 200%	OFF 50% 100% 200%	OFF 50% 100% 200%
G Ground-fault tripping (GF tripping) Detection of ground-fault current through summation current formation with internal or external neutral conductor transformer	Tripping function can be switched on/off	–	–	■
	Alarm function can be switched on/off	–	–	Permanently switched on
	Detection of ground-fault current through external current transformer	–	–	–
	Setting range of the operating current $I_g = I_n \times \dots$	–	–	0.1 0.2 0.3 0.4 0.5 0.6 0.7 0.8 1
	Setting range of the operating current I_g for alarm	–	–	–
	Setting range of the delay time t_g	–	–	0.1 0.2 0.4 0.6 0.8 s (fixed delay)
	Switchable ground-fault protection characteristic (I^2t -dependent function)	–	–	$t = \text{const.}/I^2t$ Default I^2t
	Setting range of the delay time t_g at I^2t	–	–	0.1 0.2 0.4 0.6 0.8 s (Ref. $2 \times I_n$) (I^2t dependent) Default 0.1 (I^2t)
	ZSI-G function	–	–	–

¹⁾ Sizes 1 and 2/size 3

■ Available

– Not available/not present

3WL10



3WL11 – 3WL13



1

ETU650 (LSI)	ETU660 (LSIG)	ETU15B (LI)	ETU25B (LSI)	ETU27B (LSIG)	ETU45B (LSIG)	ETU76B (LSIG)
0.4 ... 1 Default 1 (in steps of 0.001)	0.4 ... 1 Default 1 (in steps of 0.001)	0.5 0.55 0.6 0.65 0.7 0.75 0.8 0.85 0.9 1	0.4 0.45 0.5 0.55 0.6 0.65 0.7 0.8 0.9 1	0.4 0.45 0.5 0.55 0.6 0.65 0.7 0.8 0.9 1	0.4 0.45 0.5 0.55 0.6 0.65 0.7 0.8 0.9 1	0.4 ... 1
■	■	–	–	–	■	■
0.75 ... 36 s (in steps of 0.25 s) Default 36 s	0.75 ... 36 s (in steps of 0.25 s) Default 36 s	10 s fixed	10 s fixed	10 s fixed	2 3.5 5.5 8 10 14 17 21 25 30 s	2 ... 30 s
0.75 ... 5 s (in steps of 0.25 s) Default 5 s	0.75 ... 5 s (in steps of 0.25 s) Default 5 s	–	–	–	1 2 3 4 5 s	1 ... 5 s
■	■	–	–	–	■	■
2% ... 90% (default 50%)	2% ... 90% (default 50%)	–	At $t_{sd} = 20$ ms (M)	At $t_{sd} = 20$ ms (M)	At $t_{sd} = 20$ ms (M)	■ (on/off)
0.6 ... 10 OFF (in steps of 0.1)	0.6 ... 10 OFF (in steps of 0.1)	–	1.25 1.5 2 2.5 3 4 6 8 10 12	1.25 1.5 2 2.5 3 4 6 8 10 12	1.25 1.5 2 2.5 3 4 6 8 10 12 OFF	$1.25 \times I_n \dots 0.8 \times I_{cw}$ OFF
0.05 ... 0.5 s (Ref. $10 \times I_n$)	0.05 ... 0.5 s (Ref. $10 \times I_n$)	–	–	–	100 200 300 400 ms	100 ... 400 ms
0.05 ... 0.4 s	0.05 ... 0.4 s	–	M (0.02 ms) 100 200 300 400 ms	M (0.02 ms) 100 200 300 400 ms	M (0.02 ms) 100 200 300 400 ms	M (0.02 ms) 80 ... 4000 ms
–	–	–	–	–	Via module of the CubicleBUS	Via module of the CubicleBUS
OFF 1.5 ... 15 (in steps of 0.1)	OFF 1.5 ... 15 (in steps of 0.1)	2 3 4 5 6 7 8	Fixed at $I_t \geq 20 \times I_{nr}$ max. 50 kA	Fixed at $I_t \geq 20 \times I_{nr}$ max. 50 kA	OFF 1.5 2.2 3 4 6 8 10 12 $0.8 \times I_{cs}$	OFF $1.5 \times I_n \dots 0.8 \times I_{cs}$
OFF 50% 100% 150% 200%	OFF 50% 100% 200%	–	–	100%	OFF 50% 100%	OFF 20% ... 200%
–	■	–	–	■	■	■
–	■	–	–	–	–	■
–	Alternative Rc or G-ret ground-fault monitoring	–	–	–	■	■
–	0.1 ... 1 (in steps of 0.001) $I_g = I_n \times \dots$	–	–	A ¹⁾ (100/400 A) B ¹⁾ (300/600 A); C ¹⁾ (600/800 A) D ¹⁾ (900/1000 A); E ¹⁾ (1200/1200 A)	A ¹⁾ (100/400 A) B ¹⁾ (300/600 A); C ¹⁾ (600/800 A) D ¹⁾ (900/1000 A); E ¹⁾ (1200/1200 A)	SZ 1, 2: 100 ... 1200 A SZ 3: 400 ... 1200 A
–	50% ... 90% $\times I_r$ (in steps of 1%) PreAlarm	–	–	–	A ¹⁾ (100/400 A); B ¹⁾ (300/600 A); C ¹⁾ (600/800 A); D ¹⁾ (900/1000 A); E ¹⁾ (1200/1200 A)	SZ 1, 2: 100 ... 1200 A SZ 3: 400 ... 1200 A
–	0.1 ... 1 s Default 0.1 s (in steps of 0.05 s)	–	–	100 200 300 400 500 ms	100 200 300 400 500 ms	100 ... 500 ms
–	$t = \text{const.} / I^2 t$ Default const.	–	–	–	■	■
–	0.1 ... 1 s (in steps of 0.05 s) (Ref. $2 \times I_n$)	–	–	–	100 200 300 400 500 ms	100 ... 500 ms
–	–	–	–	–	Via module of the CubicleBUS	Via module of the CubicleBUS

ETU electronic trip units

With watchdog monitoring (continued)

3WL10



		ETU320 (LI)	ETU350 (LSI)	ETU360 (LSIG)
Parameter set changeover	Switchable between parameter set A and B	–	–	–
LCD		–	–	–
Voltage tap on top/bottom		–	–	–
Metering function		–	–	–
Tripping as a result of enhanced protective function: (including: phase asymmetry current/voltage, harmonic distortion current/voltage, under/overvoltage, phase rotation direction, active power in/opposite to normal direction, under/over-frequency, protective functions dependent on direction of power flow)				
Mode of communication				
Communication PROFIBUS PROFINET Modbus RTU Modbus TCP				
Output modules				
Signals via relay: Overload warning, load shedding/load carrying, leading signal, overload tripping 200 ms, temperature alarm, phase asymmetry, instantaneous short-circuit release, short-time-delayed short-circuit release, overload trip, neutral conductor trip, auxiliary relay, ETU faults, ground-fault protection tripping and ground-fault alarm (only with ground-fault protection module)		IOM300	IOM300	IOM300
		■ Available	– Not available/not present	

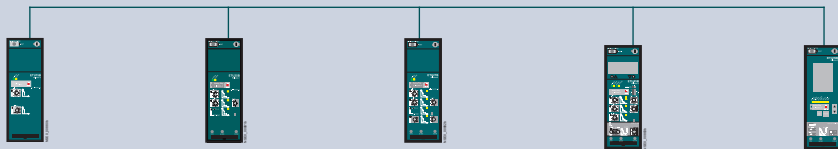
Increment size when settings are made for the ETU76B using the menu

From ... to	Increment size
0 ... 1	0.1
1 ... 100	1
100 ... 500	5
500 ... 1000	10
1000 ... 1600	50
1600 ... 10000	100
10000 ... max.	1000

3WL10



3WL11 – 3WL13



1

ETU650 (LSI)	ETU660 (LSIG)	ETU15B (LI)	ETU25B (LSI)	ETU27B (LSIG)	ETU45B (LSIG)	ETU76B (LSIG)
■	■	–	–	–	–	■
Integrated	Integrated	–	–	–	Optional	Integrated
Optional	Optional	–	–	–	Optional	Optional
Basic/Advanced	Basic/Advanced	–	–	–	Metering function Plus	Metering function Plus
■	■	–	–	–	■	■
■	■	–	–	–	■	■
IOM040/IOM300	IOM040/IOM300	–	–	–	■	■

Connection

Main circuit connection

3WL10

3WL11 – 3WL13

Connection	Fixed-mounted	Withdrawable	Fixed-mounted	Withdrawable
Front-mounted	Direct 	Extended 	1-hole 	2-hole
	Extended 		1-hole 	2-hole
	Broadened 			
Rear-mounted	Vertical 	Vertical 	Vertical 	Vertical
	Horizontal 	Horizontal 	Horizontal 	Horizontal
		Broadened 		
Cable	Cable terminals 	Cable lug 		

Auxiliary circuit connections

3WL10: Withdrawable/fixed-mounted version

- Direct engagement of the auxiliary conductor vertically onto the circuit breaker or horizontally in the guide frame



Screwless connection technology (push in)

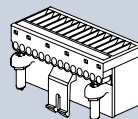
3WL11 – 3WL13: Withdrawable version

- Connection of the internal auxiliary switches to the male connector on the switch side
- When fully inserted, connection with the sliding contact module in the guide frame

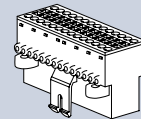
3WL11 – 3WL13: Fixed-mounted version

- Engagement of the auxiliary supply connectors directly onto the circuit breaker

Coding pins on the connectors prevent them being inserted in the wrong slots



Screw connection (standard)



Screwless connection (tension spring) (optional)

Operating mechanism, auxiliary release, auxiliary switch

Operating mechanism

The circuit breakers are available with various optional operating mechanisms:

- Manual operating mechanism with mechanical closing (standard design)
- Manual operating mechanism with mechanical and electrical closing
- Motorized operating mechanism with mechanical and electrical closing

The operating mechanisms with electrical closing are suitable for synchronization tasks.

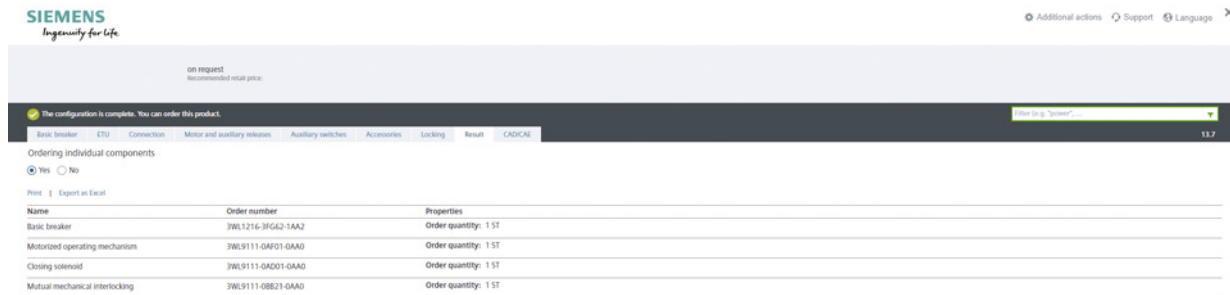
	Available for air circuit breakers	
	3WL10	3WL11 – 3WL13
Closing coils (CC)	■	■
Undervoltage releases (UVR)/ shunt trips (ST)	■	■
Shunt trips (ST)	■	■
Remote trip alarm reset coils (RR)	■	■
Spring charging motors/ Motorized operating mechanisms (MO)	■	■
Mechanical operating cycles counters	■	■

Online configurator highlights

www.siemens.com/lowvoltage/3wl-configurator

Ungroup into individual components:
Divides the finished complete article number into single article numbers

1



on request
Recommended retail price:

The configuration is complete. You can order this product.

Basic breaker | ETU | Connection | Motor and auxiliary releases | Auxiliary switches | Accessories | Locking | Result | CAD/CAE

Ordering individual components

Yes No

Print | Export as Excel

Name	Order number	Properties
Basic breaker	3WL1216-3FGA2-1AA2	Order quantity: 1 ST
Motorized operating mechanism	3WL9111-0AF01-0AA0	Order quantity: 1 ST
Closing solenoid	3WL9111-0AD01-0AA0	Order quantity: 1 ST
Mutual mechanical interlocking	3WL9111-0BB21-0AA0	Order quantity: 1 ST

Automatic generation of the 3D model, 2D dimension drawing and the internal circuit diagram according to IEC



Die Konfiguration ist vollständig, das Bestellen ist jetzt möglich.

Grundkonfiguration | ETU | Anschluss | Antrieb und Hilfsauslöser | Hilfsstromschalter | Weiteres Zubehör | Verriegelung | Ergebnis | CAD/CAE | 12.5

Vorschau
Maßblatt | Flächenansicht | 3D Ansicht | Geräteschaltplan IEC | Drahtgitteransicht

Download – Quick-Links
Grundscharter
Click2CAD

Download – alle CAD-Formate
Ansicht: Flächenansicht
Ansichtsoption: Isometrisch
Dateityp: Joint Photography Experts Group (*.jpg)
Generierung starten

Download – alle Dokumente
Dokumenten Dialog Öffnen

Direct entry of an already known article number or parts of an article number

3WL Air Circuit Breakers

Product Information | **Configurators**

Select a Configurator: 3WL Upgrade Air Circuit Breakers

3WL Upgrade Air Circuit Breakers



Selection - Tool for air circuit breakers (ACB) SENTRON 3WL from 630 A to 1250 A

- for selective line protection
- for motor protection
- non-automatic circuit breaker

Using this configurator, you can precisely select the optimum circuit breaker configuration for your application. Comprehensive CAx-data support of the device is provided after successful configuration.

To start the configurator with a preallocation use the direct input e.g. 3WL1116-3EB66-4FG4-Z K07+S07+C01+T40

MLFB direct input (complete): 3WL

Start

Start

Structure of the article numbers

Basic configuration for AC circuit breakers

The structure shown below is intended as an overview of each position and its meaning. For a complete and valid configuration of your air circuit breaker, please use our online configurator at www.siemens.com/lowvoltage/3wl-configurator

1

		3WL1			5	6	7	8	9	10	11	12	13	14	15	16
Circuit breakers, non-automatic circuit breakers and ETU																
Size (SZ)		1			1											
		2			2											
		3			3											
			SZ 1	SZ 2	SZ 3											
Max. rated current		630 A	■	-	-		0	6								
$I_{n\max}$		800 A	■	■ ⁶⁾	-		0	8								
		1000 A	■	■ ⁶⁾	-		1	0								
		1250 A	■	■ ⁶⁾	-		1	2								
		1600 A	■	■	-		1	6								
		2000 A	■	■	-		2	0								
		2500 A	-	■	-		2	5								
		3200 A	-	■	-		3	2								
		4000 A	-	■ ⁶⁾	■		4	0								
		5000 A	-	-	■		5	0								
		6300 A	-	-	■		6	3								
Short-circuit breaking capacity		N ECO	■	-	-	55 kA		2								
I_{cu} at 500 V			-	■	-	66 kA		2								
		S Standard	■	-	-	66 kA		3								
			-	■	-	85 kA		3								
		H High	■	-	-	85 kA		4								
			-	■	-	100 kA		4								
		C Very high	-	■	■ ⁸⁾	130 kA		5								
			-	-	■ ⁹⁾	150 kA		5								
Trip units		Without trip unit							A	A						
		With trip unit, without ground-fault tripping	ETU15B ⁷⁾			LI			B	B						
			ETU25B			LSI			C	B						
			ETU45B (without display)			LSIN			E	B						
			ETU45B (with display)			LSIN			F	B						
			ETU76B			LSIN			N	B						
		With trip unit, with ground-fault tripping	ETU27B (without display)			LSING			D	G						
			ETU45B (without display)			LSING			E	G						
			ETU45B (with display)			LSING			F	G						
			ETU76B			LSING			N	G						
Number of poles		3-pole (3WL upgrade)										6				
		4-pole (3WL upgrade)										7				
Connection			SZ 1	SZ 2	SZ 3											
Type of mounting	Fixed-mounted	■	■	■	Vertical											1
		■	■ ²⁾	■ ³⁾	Horizontal											2
		■ ⁴⁾	■ ¹⁾	■ ⁵⁾	Front single hole											3
		■	■ ¹⁾	■ ⁵⁾	Front double hole											4
	Withdrawable	■	■	■	Without guide frame											5
		■	■ ²⁾	■ ³⁾	Horizontal											6
		■	■	■	Vertical											7
		■	■ ¹⁾	■ ⁵⁾	Flanges											8

¹⁾ Not available for 4000 A and for breaking capacity C
²⁾ Not available for 4000 A
³⁾ Not available for 6300 A

⁴⁾ Not available for 2000 A and for breaking capacity H
⁵⁾ Not available for 5000 A, 6300 A and for breaking capacity C
⁶⁾ Not available for breaking capacity C

⁷⁾ Not available for size 3
⁸⁾ Not available for 3-pole
⁹⁾ Not available for 4-pole

3WL1

5	6	7	8	9	10	11	12	13	14	15	16
---	---	---	---	---	----	----	----	----	----	----	----

Operating mechanisms and auxiliary releases

Stored energy mechanism	Manual recharging of the stored energy mechanism	With mechanical operation		1
		With mechanical and electrical operation, closing coil (CC) suitable for uninterrupted duty, 100% OP	110 V AC 50/60 Hz/110 V DC	2
			230 V AC 50/60 Hz/220 V DC	3
	Motorized recharging	With mechanical and electrical operation, closing coil (CC) suitable for uninterrupted duty, 100% OP	208 ... 240 V AC 50/60 Hz/220 ... 250 V DC	4
			110 ... 127 V AC 50/60 Hz/110 ... 125 V DC	5
			24 V DC	6
1st auxiliary release	Without 1st auxiliary release			A
	With shunt trip (ST) 100% OP	24 V DC		B
		30 V DC		C
		48 V DC		D
		60 V DC		E
		110 ... 127 V AC 50/60 Hz/110 ... 125 V DC		F
		208 ... 240 V AC 50/60 Hz/220 ... 250 V DC		G
2nd auxiliary release	Without 2nd auxiliary release			A
	With shunt trip (ST) 100% OP	24 V DC		B
		30 V DC		C
		48 V DC		D
		60 V DC		E
		110 ... 127 V AC 50/60 Hz/110 ... 125 V DC		F
		208 ... 240 V AC 50/60 Hz/220 ... 250 V DC		G
	With undervoltage release (UVR), instantaneous	24 V DC		J
		30 V DC		K
		48 V DC		L
		60 V DC		U
		110 ... 127 V AC 50/60 Hz/110 ... 125 V DC		M
		208 ... 240 V AC 50/60 Hz/220 ... 250 V DC		N
		380 ... 415 V AC 50/60 Hz		P
		With undervoltage release (UVR-t), delay 0.2 ... 3.2 s	48 V DC	
110 ... 127 V AC 50/60 Hz/110 ... 125 V DC				R
208 ... 240 V AC 50/60 Hz/220 ... 250 V DC			S	
380 ... 415 V AC 50/60 Hz			T	

Auxiliary switches

1st auxiliary switch block	2 NO + 2 NC	2
1st + 2nd auxiliary switch block	4 NO + 4 NC	4
	6 NO + 2 NC	7
	5 NO + 3 NC	8

3WL1

5	6	7	8	9	10	11	12	13	14	15	16
---	---	---	---	---	----	----	----	----	----	----	----

Operating mechanisms and auxiliary releases

Stored energy mechanism	Manual recharging of the stored energy mechanism	With mechanical operation		1
		With mechanical and electrical operation, closing coil (CC) suitable for uninterrupted duty, 100% OP	110 V AC 50/60 Hz/110 V DC	2
			230 V AC 50/60 Hz/220 V DC	3
	Motorized recharging	With mechanical and electrical operation, closing coil (CC) suitable for uninterrupted duty, 100% OP	208 ... 240 V AC 50/60 Hz/220 ... 250 V DC	4
			110 ... 127 V AC 50/60 Hz/110 ... 125 V DC	5
			24 V DC	6
1st auxiliary release	Without 1st auxiliary release			A
	With shunt trip (ST) 100% OP	24 V DC		B
		30 V DC		C
		48 V DC		D
		60 V DC		E
		110 ... 127 V AC 50/60 Hz/110 ... 125 V DC		F
		208 ... 240 V AC 50/60 Hz/220 ... 250 V DC		G
2nd auxiliary release	Without 2nd auxiliary release			A
	With shunt trip (ST) 100% OP	24 V DC		B
		30 V DC		C
		48 V DC		D
		60 V DC		E
		110 ... 127 V AC 50/60 Hz/110 ... 125 V DC		F
		208 ... 240 V AC 50/60 Hz/220 ... 250 V DC		G
	With undervoltage release (UVR), instantaneous	24 V DC		J
		30 V DC		K
		48 V DC		L
		60 V DC		U
		110 ... 127 V AC 50/60 Hz/110 ... 125 V DC		M
		208 ... 240 V AC 50/60 Hz/220 ... 250 V DC		N
		380 ... 415 V AC 50/60 Hz		P
		With undervoltage release (UVR-t), delay 0.2 ... 3.2 s	48 V DC	
110 ... 127 V AC 50/60 Hz/110 ... 125 V DC				R
208 ... 240 V AC 50/60 Hz/220 ... 250 V DC			S	
	380 ... 415 V AC 50/60 Hz		T	

Auxiliary switches

1st auxiliary switch block	2 NO + 2 NC	2
1st + 2nd auxiliary switch block	4 NO + 4 NC	4
	6 NO + 2 NC	7
	5 NO + 3 NC	8

Accessory options

For a complete and valid configuration of your air circuit breaker, please use our online configurator at www.siemens.com/lowvoltage/3wl-configurator

1

To specify the options, add "-Z" to the complete article number and indicate the appropriate order code(s).

3WL....-.....-.... -Z

Order code

Accessories for basic configuration

Rated operational voltage 1000 V AC and 690 V IT networks ⁴⁾

- Only for circuit breakers of size 1 - 3 with high breaking capacity H and of size 3 breaking capacity C.
- Cannot be combined with rated operational voltage 1150 V AC, order code "A15".

Size 1 ¹⁾	≤ 2000 A	A05
Size 2 ^{1) 2)}	≤ 4000 A	A05
Size 3 ¹⁾	≤ 6300 A	A05

Rated operational voltage 1150 V AC

- Only for circuit breakers with high breaking capacity H (8th digit of the article number is a "4").
- Cannot be combined with rated operational voltage 1000 V AC, order code "A05".

Size 2 ^{1) 2)}	≤ 4000 A	A15
Size 3 ^{1) 3)}	≤ 6300 A	A15

Rated operational voltage 690 V AC (+ 20%) ⁴⁾

- Only for 3WL11 circuit breakers, size 1 ⁴⁾, with high breaking capacity H (8th digit of the article number is a "4").

Size 1	≤ 2000 A	A16
--------	----------	-----

¹⁾ When ordering withdrawable circuit breaker and guide frame separately, specify order code "A05" only for withdrawable circuit breaker and guide frame.

²⁾ Not possible for circuit breakers with very high breaking capacity C.

³⁾ Front connections are tinned as standard.

⁴⁾ When using withdrawable circuit breakers in conjunction with old guide frames (3WL92...-A...-..... or 3WL92...-B...-.....), additional Z option A41 must be ordered.

To specify the options, add "-Z" to the complete article number and indicate the appropriate order code(s).

3WL.....-.....-..... -Z

Order code

Accessories for ETU electronic trip units

Rating plugs

- Only one module is possible per circuit breaker (not in conjunction with ETU15B electronic trip unit).
- As standard, the electronic trip units are equipped with a rating plug which is equal to the maximum rated circuit breaker current ($I_{n \max}$).
The rated current of the selected rating plug must be less than $I_{n \max}$.

Module	Sizes 1, 2		
		250 A	B02
		315 A	B03
		400 A	B04
		500 A	B05
		630 A	B06
		800 A	B08
		1000 A	B10
	Sizes 1, 2, 3	1250 A	B12
		1600 A	B16
		2000 A	B20
	Sizes 2, 3	2500 A	B25
		3200 A	B32
		4000 A	B40
	Size 3	5000 A	B50
		6300 A	B63

Communication ¹⁾

Breaker status sensor (BSS)	For determining the statuses ON/OFF/Tripped	F01
PROFIBUS DP communication port ²⁾	Including COM15 and breaker status sensor (BSS)	F02
Modbus RTU communication port ²⁾	Including COM16 and breaker status sensor (BSS)	F12
PROFINET IO/Modbus TCP communication port ²⁾	Including COM35 and breaker status sensor (BSS)	F35

Metering function (communications modules not included) ¹⁾

Metering function Plus	With internal voltage tap on the lower main conducting paths ³⁾	F36
	With internal voltage tap on the upper main conducting paths ³⁾	F37
	For combination with external voltage transformer	F38

EMC filter

- Common-mode interference suppressor filters (e.g. in converter applications)
- Insertion loss (asymmetric) in the range 40 kHz to 10 MHz > 40 dB.

EMC filter		F31
------------	--	-----

Overload and short-circuit protection for neutral conductors

- Only possible with 4-pole circuit breaker with ETU27B to ETU76B

Internal current transformer for N conductor	Size 1	F23
	Size 2	F23
	Size 3	F23

¹⁾ The precondition is an ETU45B or ETU76B

²⁾ When ordering withdrawable circuit breaker and guide frame separately, specify order code "F02", "F12" or "F35" only for withdrawable circuit breaker.

³⁾ Can only be used for rated operational voltages up to 690 V AC.

Accessory options

For a complete and valid configuration of your air circuit breaker, please use our online configurator at www.siemens.com/lowvoltage/3wl-configurator

To specify the options, add "-Z" to the complete article number and indicate the appropriate order code(s).

3WL....-.....-.... -Z

Order code

Accessories for ETU electronic trip units

Remote resetting

Automatic reset of the reclosing lockout

- Remote reset for displays and reset buttons including automatic reset of the reclosing lockout
- Includes automatic reset of the reclosing lockout

K01

Remote trip alarm reset coils

24 V DC

K10

48 V DC

K11

110 ... 127 V AC 50/60 Hz/110 ... 125 V DC

K12

208 ... 240 V AC 50/60 Hz/220 ... 250 V DC

K13

Connection

Tinned version of the customer's connections on the guide frame

- Only for withdrawable circuit breakers with horizontal connection or flange connection
- The normal delivery time increases to 15 work days

Customer's connections ^{1) 2)}

Size 1

A08

Size 2

A08

Size 3

A08

Connection technology for main connections (fixed-mounted versions)

Top:³⁾ horizontal

Size 1

≤ 1600 A

N11

Bottom: accessible from front, single hole

Size 2

≤ 3200 A

N11

Size 3⁴⁾

≤ 4000 A

N11

Top: vertical

Size 1

≤ 2000 A

N20

Bottom: horizontal

Size 2

≤ 3200 A

N20

Size 3

≤ 5000 A

N20

Top: horizontal

Size 1

≤ 2000 A

N24

Bottom: vertical

Size 2

≤ 3200 A

N24

Size 3

≤ 5000 A

N24

Connection technology for main connections (withdrawable versions)

Top and bottom:^{5) 6)}

accessible from front, single hole

Size 1

≤ 1600 A

P00

Size 2

≤ 3200 A

P00

Size 3

≤ 4000 A

P00

Top and bottom:⁵⁾

accessible from front, double hole

Size 1

≤ 1600 A

P01

Size 2

≤ 3200 A

P01

Size 3

≤ 4000 A

P01

Top:^{5) 6)} horizontal

Size 1

≤ 1600 A

P07

Bottom: accessible from front, single hole

Size 2

≤ 3200 A

P07

Size 3

≤ 4000 A

P07

¹⁾ Front connections are tinned as standard.

²⁾ The permissible temperature rise limits according to IEC 60947-2 are 5 K lower for a tin surface than for a silver surface.

³⁾ Not for 3WL1 size 1 with high breaking capacity H and circuit breakers with very high breaking capacity C.

⁴⁾ Not for size 3 with very high breaking capacity C.

⁵⁾ Not for size 2, 3 circuit breakers with very high breaking capacity C.

⁶⁾ Not for 3WL1 size 1 with high breaking capacity H

To specify the options, add "-Z" to the complete article number and indicate the appropriate order code(s).

3WL.....-.....-..... -Z

Order code

Connection

Connection technology for main connections (withdrawable versions)

Top: vertical Bottom: horizontal	Size 1	≤ 2000 A	P18
	Size 2	≤ 3200 A	P18
	Size 3	≤ 5000 A	P18
Top: ¹⁾ connecting flange Bottom: horizontal	Size 1	≤ 2000 A	P19
	Size 2	≤ 3200 A	P19
	Size 3	≤ 4000 A	P19
Top: horizontal Bottom: vertical	Size 1	≤ 2000 A	P23
	Size 2	≤ 3200 A	P23
	Size 3	≤ 5000 A	P23
Top: ¹⁾ horizontal Bottom: connecting flange	Size 1	≤ 2000 A	P28
	Size 2	≤ 3200 A	P28
	Size 3	≤ 4000 A	P28

Connection technology for auxiliary conductors (for fixed-mounted and withdrawable versions)

Connection technology for screwless terminals (tension spring)	Fixed-mounted	N61
	Withdrawable	P61

Operating mechanisms and auxiliary releases

Motorized operating mechanisms	Only possible if the 13th digit of the article number = "1"	24 ... 30 V DC	M01
		48 ... 60 V DC	M03
		110 ... 127 V AC 50/60 Hz/110 ... 125 V DC	M05
		208 ... 240 V AC 50/60 Hz/220 ... 250 V DC	M06
Mechanical operating cycles counter, 5-digit ²⁾			C01
Closing coils	• Suitable for uninterrupted duty, 100% OP • Only possible if the 13th digit of the article number = "1"	24 V DC	M21
		30 V DC	M22
		48 V DC	M23
		60 V DC	M24
	• Not suitable for uninterrupted duty, 5% OP, synchronizable ³⁾ • Only possible if the 13th digit of the article number = "1"	110 ... 127 V AC 50/60 Hz/110 ... 125 V DC	M25
		208 ... 240 V AC 50/60 Hz/220 ... 250 V DC	M26
		24 V DC	M31
		48 V DC	M33
Opening coils (shunt trips) ³⁾⁴⁾	Not suitable for uninterrupted duty, 5% OP, synchronizable	110 ... 127 V AC 50/60 Hz/110 ... 125 V DC	M35
		208 ... 240 V AC 50/60 Hz/220 ... 250 V DC	M36
		24 V DC	M41
		48 V DC	M43
		110 ... 127 V AC 50/60 Hz/110 ... 125 V DC	M45
		208 ... 240 V AC 50/60 Hz/220 ... 250 V DC	M46

¹⁾ Not for size 2, 3 circuit breakers with very high breaking capacity C.

²⁾ Only possible with motorized operating mechanism.

³⁾ Overexcited, i.e. switching time 50 ms (standard > 80 ms).

⁴⁾ Only possible if the 14th digit of the article number for the circuit breaker is "A", i.e. "without 1st auxiliary release".

Accessory options

For a complete and valid configuration of your air circuit breaker, please use our online configurator at www.siemens.com/lowvoltage/3wl-configurator

To specify the options, add "-Z" to the complete article number and indicate the appropriate order code(s).

3WL.....-.....-..... -Z

Order code

Auxiliary switches and signaling switches

Position signaling switches for guide frames	1 CO 1 CO 1 CO (connected test disconnected position)	R15	
	3 CO 2 CO 1 CO (connected test disconnected position)	R16	
Signaling switches	Ready-to-close signaling switch (S20)	1 NO	C22
	Spring charge signaling switch ¹⁾ (S21)	1 NO	C20
	For the first auxiliary release ¹⁾ (S22)	1 CO	C26
	For the second auxiliary release ¹⁾ (S23)	1 CO	C27
	1st tripped signaling switch ¹⁾²⁾ (S24)	1 CO	K07
	2nd tripped signaling switch ¹⁾²⁾³⁾ (S25)	1 NO	K06

Further accessories

Pushbuttons/disconnect switches/closing lockouts

EMERGENCY-OFF pushbuttons	Mushroom pushbutton instead of the mechanical OFF pushbutton	S24	
Local electric close on operator panel ¹⁾ (S10)	This prevents unauthorized electrical closing from the operator panel. Mechanical closing and remote closing remain possible. Possible only for circuit breakers with closing coil (CC)	With sealing cap	C11
		With CES lock	C12
Motor disconnect switch on operator panel ⁴⁾ (S12)	This prevents automatic charging of the stored energy mechanism by motorized operating mechanism	S25	

Special packaging for increased transport requirements (moisture protection)

Cardboard packaging with water-repellent coating on corrugated cardboard (moisture protection)	A61
--	-----

Arc chute covers

- Not available for:
 - 1000 V version (order code "A05"),
 - DC version
 - 4000 A size 2
 - 1150 V version (order code "A15")
 - 130 kA version, size 2
 - 150 kA version, size 3

Arc chute covers	3-pole/4-pole	R10
------------------	---------------	-----

Shutters

Shutter: 2-part, lockable, with padlocks ⁵⁾	3-pole/4-pole	R21
--	---------------	-----

¹⁾ Not possible with "communications interface" option, order code "F02", "F12" or "F35".

²⁾ Not available for non-automatic air circuit breakers.

³⁾ Only possible with option "K07".

⁴⁾ Only for breakers with motorized operating mechanism, not possible with order codes "C11", "C12".

⁵⁾ Padlock not included in the scope of supply.

To specify the options, add "-Z" to the complete article number and indicate the appropriate order code(s).

3WL....-.....-.... -Z

Order code

Further accessories

Instrument transformers (without energy transformers), for powering the ETU

- Used in converter applications with high harmonic components; can only be used with ETU45B or ETU76B
 - External 24 V DC supply required
 - Undervoltage release required
- Comprises:
 - 3 (3-pole) or 4 (4-pole) transformers
 - 24 V DC relay
 - Warning signs
 - Manual

Transformer	3-pole/4-pole	Sizes 2, 3	K60
-------------	---------------	------------	-----

Operating instructions in printed form

- As of June 1, 2023, 3WL circuit breakers and non-automatic circuit breakers are no longer supplied with operating instructions as standard. However, they can be supplied together with the circuit breaker for an additional charge.

Article numbers for separate ordering of operating instructions can be found in chapter "Accessories and spare parts"

3WL operating instructions German/English	A80
3WL operating instructions Italian/French	A81
3WL operating instructions Spanish/Portuguese	A82

Accessory options

For a complete and valid configuration of your air circuit breaker, please use our online configurator at www.siemens.com/lowvoltage/3wl-configurator

To specify the options, add "-Z" to the complete article number and indicate the appropriate order code(s).

3WL....-.....-..... -Z

Order code

Interlocking

Mechanical interlocking mechanism

- Interlocking module with Bowden cable 2 m

Mechanical interlocks

For fixed-mounted breakers	S55
For withdrawable circuit breakers with guide frame	R55
For guide frames (ordered separately)	R56
For withdrawable circuit breakers (ordered separately)	R57

Locking provisions (for fixed-mounted and withdrawable versions)

- The disconnecter unit fulfills the requirements for main circuit breakers according to EN 60204-1

Locking provisions

Against unauthorized closing from the operator panel

Made by CES	S01
Made by IKON	S03
Assembly kit FORTRESS or CASTELL ¹⁾	S05
Assembly kit for padlocks ²⁾	S07
Made by RONIS	S08
Made by PROFALUX	S09

Locking provisions (for fixed-mounted and withdrawable versions)

Locking provisions

For charging handle with padlock ²⁾

S33

¹⁾ Locks must be ordered from the manufacturer.

²⁾ Padlock not included in the scope of supply.

To specify the options, add "-Z" to the complete article number and indicate the appropriate order code(s).

3WL.....-.....-..... -Z

Order code

Interlocking

Locking provisions (for withdrawable version)

- The disconnecter unit fulfills the requirements for main circuit breakers acc. to EN 60204-1, consisting of a lock in the guide frame, active in the connected position, function is retained when circuit breaker is replaced.
- Not possible in combination with order code "R81", "R85" or "R86".

Locking provisions	Against unauthorized closing from the operator panel	Made by CES	R61
		Made by RONIS	R68
		Made by PROFALUX	R60

Locking provisions (for withdrawable version)

- Safety lock for mounting onto the circuit breaker

Locking provisions	To prevent movement of the withdrawable circuit breaker	Made by CES	S71
		Made by PROFALUX	S75
		Made by RONIS	S76

Locking mechanisms

- Not possible in combination with order code "R81", "R85" or "R86".

For fixed-mounted circuit breakers	To prevent opening of the cabinet door in ON position	S30
For withdrawable circuit breakers	To prevent opening of the cabinet door in connected position	R30
	To prevent activation when the cabinet door is open ^{1) 3)}	R40
	To prevent movement when the cabinet door is open ²⁾	R50

Locking mechanisms to prevent movement of the withdrawable circuit breakers in disconnected position

- Consisting of Bowden cable and lock in the control cabinet door
- Not possible in combination with order code "R30", "R50", "R61", "R68" or "R60"

Made by CES	R81
Made by PROFALUX	R85
Made by RONIS	R86

Seals

Door sealing frame for degree of protection IP41	T40
--	-----

Accessories from current catalog

Use of the withdrawable circuit breaker in combination with an older guide frame

Reduction of the technical specifications for withdrawable circuit breakers 3WL1 for use in combination with older guide frames supplied

- Possible article numbers of the existing "older" guide frames
 - 3WL92...-A...-.....
 - 3WL92...-B...-.....
 - 3WL92...-D...-.....
 - 3WL92...-E...-.....
- Article numbers of circuit breakers with reduced technical specifications
 - 3WL1...-...3...-..... - Z
 - 3WL1...-...4...-..... - Z

For sizes 1, 2, 3.

Use of the circuit breaker in older guide frames, including the appropriate guide frame coding	A41
--	-----

¹⁾ Not available in combination with R50

²⁾ Not available in combination with R40

³⁾ Combination with R81, R85 and R86 on request

Accessory options

Further technical specifications

Manual operating mechanism

3WL11 – 3WL13

Switching on/charging energy store

Maximum force required to operate the hand lever	≤ 230 N
Required number of strokes on the hand lever	9

Closing coils

3WL11 – 3WL13

Primary operating range

Version		For continuous command (100% OP)	5% OP
Primary operating range		$0.85 \dots 1.1 \times U_s$	$0.85 \dots 1.1 \times U_s$
Extended operating range for battery operation	At 24 ... 30 V DC, 48 ... 60 V DC 110 ... 125 V DC 220 ... 250 V DC	$0.85 \dots 1.26 \times U_s$	$0.85 \dots 1.26 \times U_s$

Rated operational voltage

Rated control supply voltage U_s	50/60 Hz AC	110 ... 127 V, 208 ... 240 V
	DC	24 ... 30 V, 48 ... 60 V, 110 ... 125 V, 220 ... 250 V

Operation

Closing power	DC/AC	40 W/40 VA	≤ 60 V: 200 W ≥ 110 V: 250 W
Continuous power	DC/AC	8 W/8 VA	-
Minimum command duration at 100% U_s		60 ms	60 ms
Maximum command duration at 100% U_s		-	2000 ms
Make time of the circuit breaker at 100% U_s		100 ms	50 ms

Fuse protection of the control circuit at U_s for closing coil

Fuse gG	24 ... 30 V DC	2 A	10 A
	48 ... 60 V DC	2 A	10 A
	110 ... 125 V DC/110 ... 127 V AC	1 A	4 A
	220 ... 250 V DC/208 ... 240 V AC	1 A	2 A
Miniature circuit breaker with C characteristic	24 ... 30 V DC	2 A	10 A
	48 ... 60 V DC	2 A	10 A
	110 ... 125 V DC/110 ... 127 V AC	1 A	4 A
	220 ... 250 V DC/208 ... 240 V AC	1 A	2 A

Fuse protection of the control circuit at U_s for spring charging motor + closing coil

Fuse gG	24 ... 30 V DC	6 A	10 A
	48 ... 60 V DC	6 A	10 A
	110 ... 125 V DC/110 ... 127 V AC	2 A	4 A
	220 ... 250 V DC/208 ... 240 V AC	2 A	2 A
Miniature circuit breaker with C characteristic	24 ... 30 V DC	6 A	10 A
	48 ... 60 V DC	6 A	10 A
	110 ... 125 V DC/110 ... 127 V AC	2 A	4 A
	220 ... 250 V DC/208 ... 240 V AC	2 A	2 A

Motor

3WL11 – 3WL13

Primary operating range

Primary operating range		$0.85 \dots 1.1 \times U_s$
Extended operating range for battery operation	At 24 V DC, 48 V DC 60 V DC, 110 V DC 220 V DC	$0.85 \dots 1.26 \times U_s$

Operation

Power consumption of motor	AC/DC	135 VA/135 W
Time required to charge the stored energy mechanism at $1 \times U_s$		≤ 10 s

Fuse protection of the control circuit at U_s for spring charging motor

Fuse gG	24 ... 30 V DC, 48 ... 60 V DC	6 A
	110 ... 125 V DC/110 ... 127 V AC, 220 ... 250 V DC/208 ... 240 V AC	2 A
	Miniature circuit breaker with C characteristic	6 A
	24 ... 30 V DC, 48 ... 60 V DC	2 A
	110 ... 125 V DC/110 ... 127 V AC, 220 ... 250 V DC/208 ... 240 V AC	2 A

Signals of the electronic trip unit

3WL11 – 3WL13

Signals of the electronic trip unit			
Measuring accuracy of the electronic trip unit		Protective functions acc. to EN 60947; current indication $\leq 10\%$; metering function for base quantities $\leq 1\%$; metering function for derived quantities $\leq 4\%$	

Undervoltage releases UVR (F3) and UVR- t_d (F4)

3WL11 – 3WL13

Primary operating range		
Response values	Pickup	$\geq 0.85 \times U_s$ (circuit breaker can be closed)
	Dropout	$0.35 \dots 0.7 \times U_s$ (circuit breaker is opened)
Primary operating range		$0.85 \dots 1.1 \times U_s$
Extended operating range for battery operation		At 24 V DC, 30 V DC, 48 V DC, 110 V DC, 220 V DC $0.85 \dots 1.26 \times U_s$
Rated operational voltage		
Rated control supply voltage U_s	Instantaneous 50/60 Hz AC	110 ... 127 V, 208 ... 240 V, 380 ... 415 V
	Instantaneous DC	24 V, 30 V, 48 V, 60 V, 110 ... 125 V, 220 ... 250 V ¹⁾
	Delayed 50/60 Hz AC	110 ... 127 V, 208 ... 240 V, 380 ... 415 V
	Delayed DC	48 V, 110 ... 125 V, 220 ... 250 V
Operation		
Closing power	AC/DC	50 VA/50 W
Continuous power	AC/DC	5 VA/5 W
Opening time of the circuit breaker		
Version UVR (F3)	Instantaneous	≤ 80 ms
	With delay	200 ms
Version UVR- t_d (F8)	With delay, $t_d = 0.2 \dots 3.2$ s	$0.2 \dots 3.2$ s
	Reset through additional NC contact – direct tripping	≤ 100 ms
Fuse protection of the control circuit		
Fuse gG	24 ... 30 V DC (UVR)	2 A
	48 ... 60 V DC (UVR)	2 A
	48 V DC (UVR-t)	2 A
	60 V DC (UVR-t)	2 A
	110 ... 127 V AC/110 ... 125 V DC	2 A
	208 ... 240 V AC/220 ... 250 V DC	2 A
	380 ... 415 V AC	2 A
Miniature circuit breaker with C characteristic	24 ... 30 V DC (UVR)	4 A
	48 ... 60 V DC (UVR)	4 A
	48 V DC (UVR-t)	4 A
	60 V DC (UVR-t)	4 A
	110 ... 127 V AC/110 ... 125 V DC	4 A
	208 ... 240 V AC/220 ... 250 V DC	6 A
	380 ... 415 V AC	6 A
Miniature circuit breaker with D characteristic	24 ... 30 V DC (UVR)	2 A
	48 ... 60 V DC (UVR)	2 A
	48 V DC (UVR-t)	2 A
	60 V DC (UVR-t)	2 A
	110 ... 127 V AC/110 ... 125 V DC	2 A
	208 ... 240 V AC/220 ... 250 V DC	4 A
	380 ... 415 V AC	4 A

Shunt trip (ST) (F1, F2)

3WL11 – 3WL13

Primary operating range			
Version	For continuous command (100% OP), locks out on momentary-contact commands	5% OP	With spring energy store consisting of shunt trip and capacitor trip device
Primary operating range		$0.85 \dots 1.1 \times U_s$	$0.85 \dots 1.1 \times U_s$
Extended operating range for battery operation		$0.85 \dots 1.26 \times U_s$	–
Response values	Pickup	$> 0.7 \times U_s$ (circuit breaker is tripped)	–
		$> 0.7 \times U_s$ (circuit breaker is tripped)	–

Accessory options

Further technical specifications

Shunt trip (ST) (F1, F2)

3WL11 – 3WL13

Rated operational voltage				
Rated control supply voltage U_s	50/60 Hz AC	110 ... 127 V, 208 ... 240 V	230 V	
	DC	24 ... 30 V, 48 ... 60 V, 110 ... 125 V, 220 ... 250 V	220 V	
Operation				
Closing power DC	DC/AC	40 W/40 VA	≤ 60 V: 200 W ≥ 110 V: 250 W	1 VA/1 W
Continuous power	DC/AC	8 W/8 VA	–	–
Minimum command duration at 100% U_s		60 ms	60 ms	–
Maximum command duration at 100% U_s		–	2000 ms	–
Opening time of the circuit breaker at 100% U_s		80 ms	50 ms	80 ms
Storage time at U_s /Recharging time at U_s		–	–	max. 5 min/min. 5 s
Fuse protection of the control circuit at U_s for shunt trip				
Fuse gG	24 ... 30 V DC	2 A	10 A	–
	48 ... 60 V DC	2 A	10 A	–
	110 ... 125 V DC/110 ... 127 V AC	1 A	4 A	–
	220 ... 250 V DC/208 ... 240 V AC	1 A	2 A	–
Miniature circuit breaker with C characteristic	24 ... 30 V DC	2 A	10 A	–
	48 ... 60 V DC	2 A	10 A	–
	110 ... 125 V DC/110 ... 127 V AC	1 A	4 A	–
	220 ... 250 V DC/208 ... 240 V AC	1 A	2 A	–

¹⁾ 24 V and 30 V only with undervoltage release UVR (F3)

Remote trip alarm reset coil for mechanical tripped indicator (F7)

3WL11 – 3WL13

Primary operating range		
Primary operating range		0.85 ... 1.1 × U_s
Extended operating range for battery operation	At 24 ... 30 V DC, 48 ... 60 V DC, 110 ... 125 V DC, 220 ... 250 V DC	0.7 ... 1.26 × U_s
Operation		
Power consumption	AC/DC	60 VA/60 W
Min. command duration at U_s for the remote trip alarm reset coil		60 ms
Fuse protection of the control circuit		
Fuse gG	24 ... 60 V DC	2 A
	100 V AC/> 100 V DC	1 A
Miniature circuit breaker with C characteristic	24 ... 60 V DC	2 A
	100 V AC/> 100 V DC	1 A

Contact position-driven auxiliary switches (S1, S2, S3, S4, S7, S8)

3WL11 – 3WL13

Rated operational voltage					
Rated insulation voltage U_i	AC/DC	500 V			
Rated operational voltage U_e	AC/DC	500 V			
Rated impulse withstand voltage U_{imp}		4 kV			
Contact reliability		From 1 mA at 5 V DC			
Breaking capacity					
Alternating current 50/60 Hz	Rated operational voltage U_e	24 ... 230 V	380 V, 400 V		
	Rated operational current I_e /AC-12	10 A	10 A		
	Rated operational current I_e /AC-15	4 A	3 A		
Direct current	Rated operational voltage U_e	24 V	48 V	110 V	220 V
	Rated operational current I_e /DC-12	10 A	8 A	3.5 A	1 A
	Rated operational current I_e /DC-13	8 A	4 A	1.2 A	0.4 A

Ready-to-close signaling switches (S20) (acc. to DIN VDE 0630)

3WL11 – 3WL13

Breaking capacity				
Alternating current 50/60 Hz	Rated operational voltage U_e	250 V		
	Rated operational current I_e	8 A		
Direct current	Rated operational voltage U_e	125 V	250 V	
	Rated operational current I_e	0.4 A	0.2 A	
Contact reliability		From 1 mA at 5 V DC		

Tripped signaling switches (S24) and signaling switches for auxiliary releases (S22, S23) (acc. to DIN VDE 0630)

3WL11 – 3WL12

Breaking capacity				
Alternating current 50/60 Hz	Rated operational voltage U_e	250 V		
	Rated operational current $I_e/AC-12$	8 A		
Direct current	Rated operational voltage U_e	24 V	125 V	250 V
	Rated operational current $I_e/DC-12$	6 A	0.4 A	0.2 A
	Contact reliability	From 1 mA at 5 V DC		
Tripped signaling switches				
Signal duration after tripping	Until manual or electrical remote reset (option)			

Position signaling switch on guide frame

3WL11 – 3WL13

Type of contacts				
Message	"Circuit breaker in connected position"	3 W	or	1 W
	"Circuit breaker in test position"	2 W	or	1 W
	"Circuit breaker in disconnected position"	1 W	or	1 W
Contact reliability	From 1 mA at 5 V DC			
Rated operational voltage				
Rated insulation voltage U_i	50/60 Hz AC	440 V		
	DC	250 V		
Rated operational voltage U_e	250 V			
Rated impulse withstand voltage U_{imp}	4 kV			
Breaking capacity				
Rated operational current I_e	$I_e/AC-12$	24 V 10 A, 110/127 V 10 A, 220/240 V 10 A, 320/440 V 10 A		
	$I_e/AC-15$	220/240 V 4 A, 320/440 V 3 A		
	$I_e/DC-12$	24 V 10 A, 48 V 2.5 A, 220/240 V 0.2 A		
	$I_e/DC-13$	24 V 3.0 A, 220/240 V 0.1 A		
	A 300 (AC)	120 V 6 A, 240 V 3 A		
	R 300 (DC)	125 V 0.22 A, 250 V 0.11 A		

1

Guide frames for AC

The structure shown below is intended as an overview of each position and its meaning. For a complete and valid configuration of your guide frame, please use our online configurator at www.siemens.com/lowvoltage/3wl-configurator

		5	6	7	8	9	10	11	12	13	14	15	16
3WL9		2	1		–					–			1
Size (SZ)	1			1									
	2			2									
	3			3									
		SZ 1	SZ 2	SZ 3									
Max. rated current $I_{n \max}$ (guide frames)	1000 A ^{5) 6)}	■	–	–	1								
	1600 A ^{5) 6)}	■	–	–	2								
	2000 A ⁶⁾	■	■	–	3								
	2500 A ⁶⁾	–	■	–	4								
	3200 A ⁷⁾	–	■	–	5								
	4000 A ⁶⁾	–	■	■	6								
	5000 A	–	–	■	7								
	6300 A	–	–	■	8								
Number of poles	3-pole												F
	4-pole												G
Main connection	Front, single hole	■ ¹⁾	■ ^{2) 6)}	■ ³⁾									A
	Front, double hole	■	■ ^{2) 6)}	■ ³⁾									B
	Horizontal	■	■ ²⁾	■ ⁴⁾									C
	Vertical	■	■	■									D
	Connecting flange	■	■ ^{2) 6)}	■ ³⁾									E
Short-circuit breaking capacity I_{cu} at 500 V	N 55 kA	■	–	–									N
	S 66 kA	■	–	–									S
	H 85 kA	■ ⁵⁾	–	–									H
	N, S and H ≤ 100 kA	–	■	■									H
	C 130 kA	–	■	–									C
	C 150 kA	–	–	■									C

¹⁾ Not available for rated circuit breaker current 2000 A and breaking capacity H

²⁾ Not available for rated circuit breaker current 4000 A

³⁾ Not available for rated circuit breaker current 5000 A + 6300 A + breaking capacity C

⁴⁾ Not available for rated circuit breaker current 6300 A

⁵⁾ For size 1 with breaking capacity H, please select the max. rated current I_n 2000 A of the guide frame

⁶⁾ Not available for breaking capacity C

⁷⁾ For all rated circuit breaker currents up to 3200 A with breaking capacity C

Options

		5	6	7	8	9	10	11	12	13	14	15	16
3WL9		2	1		–					–			1
Number of auxiliary supply connectors	Without								0				
	1 connector								1				
	2 connectors								2				
	3 connectors								3				
	4 connectors								4				
Type of auxiliary circuit connections	Without ⁸⁾								0				
	With screw terminals (SIGUT, standard)								1				
	With screwless terminals (tension spring)								2				
Position signaling switch	Without												0
	1 CO 1 CO 1 CO (connected test disconnected position)												1
	3 CO 2 CO 1 CO (connected test disconnected position)												2
Shutters	Without												A
	With shutter, 2-part, lockable												B

⁸⁾ Can only be selected if the number of auxiliary supply connectors is zero.

Guide frames for DC

The structure shown below is intended as an overview of each position and its meaning.
For a complete and valid configuration of your guide frame, please use our online configurator at
www.siemens.com/lowvoltage/3wl-configurator

		5	6	7	8	9	10	11	12	13	14	15	16
3WL9		2	1	2	–					–		0	1
Max. rated current $I_{n \max}$	2000 A				3								
	4000 A				6								
Number of poles	3-pole					H							
	4-pole					J							
Main connection	Front, single hole ¹⁾						A						
	Front, double hole ¹⁾						B						
	Horizontal						C						
	Vertical						D						
	Connecting flange						E						

¹⁾ Not available for rated circuit breaker current 4000 A

Options

		5	6	7	8	9	10	11	12	13	14	15	16
3WL9		2	1	2	–					–		0	1
Number of auxiliary supply connectors	Without						0						
	1 connector						1						
	2 connectors						2						
	3 connectors						3						
	4 connectors						4						
Type of auxiliary circuit connections	Without ²⁾						0						
	With screw terminals (SIGUT, standard)						1						
	With screwless terminals (tension spring)						2						
Position signaling switch	Without									0			
	1 CO 1 CO 1 CO (connected test disconnected position)									1			
	3 CO 2 CO 1 CO (connected test disconnected position)									2			
Shutters	Without										A		
	With shutter, 2-part, lockable										B		

²⁾ Can only be selected if the number of auxiliary supply connectors is zero.

Accessories and spare parts

Accessories for ETU electronic trip units

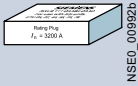
Electronic trip units and optional metering function



- For replacement in existing circuit breakers, please specify the circuit breaker ID No. when ordering.
- The electronic trip unit is supplied without a rating plug
- The rating plug must be ordered separately

Type	With protective function	Metering function	Article No.
ETU15B	LI	Without	3WL9311-5AA00-0AA2
ETU25B	LSI	Without	3WL9312-5AA00-0AA2
ETU27B	LSING	Without	3WL9312-7AA00-0AA2
ETU45B (without display)	LSIN(G)	Without	3WL9314-5AA00-0AA2
		With metering function Plus	3WL9314-5AA30-0AA2
ETU76B	LSIN(G)	Without	3WL9317-6AA00-0AA2
		With metering function Plus	3WL9317-6AA30-0AA2

Rating plugs



- With the rating plug selected, the maximum rated current $I_{n \max}$ of the circuit breaker must not be exceeded. The following applies: $I_n \leq I_{n \max}$

Size	Rated current I_n	Article No.
1, 2	250 A	3WL9111-0AA51-0AA0
	315 A	3WL9111-0AA52-0AA0
	400 A	3WL9111-0AA53-0AA0
	500 A	3WL9111-0AA54-0AA0
	630 A	3WL9111-0AA55-0AA0
	800 A	3WL9111-0AA56-0AA0
	1000 A	3WL9111-0AA57-0AA0
1, 2, 3	1250 A	3WL9111-0AA58-0AA0
	1600 A	3WL9111-0AA61-0AA0
	2000 A	3WL9111-0AA62-0AA0
2, 3	2500 A	3WL9111-0AA63-0AA0
	3200 A	3WL9111-0AA64-0AA0
	4000 A	3WL9111-0AA65-0AA0
3	5000 A	3WL9111-0AA66-0AA0
	6300 A	3WL9111-0AA67-0AA0

Ground-fault modules



- Alarm and tripping
- For direct metering of the ground-fault current, e.g. in the neutral point of the transformer, a 1200 A/1 A current transformer, class 1, is required. The internal load of the 3WL circuit breaker is 0.11 Ω . If the ground-fault current is to be determined using the vectorial sum of the phases, a transformer must be installed in the neutral conductor.

Type	Accessory for	Article No.
GFM AT 45B	ETU45B	3WL9111-0AT53-0AA0
GFM AT 55B – 76B	ETU76B	3WL9111-0AT56-0AA0

Display



Accessory for	Version	Article No.
ETU45B	4-line	3WL9111-0AT81-0AA0

Internal current transformers, for N conductor including wiring kit


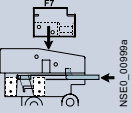
ETU Release 2	Size	Article No.
–	1	3WL9111-0AA11-0AA0
	2	3WL9111-0AA12-0AA0
	3	3WL9111-0AA13-0AA0
✓	1	3WL9111-0AA14-0AA0
	2	3WL9111-0AA15-0AA0
	3	3WL9111-0AA16-0AA0

External current transformers for N conductor

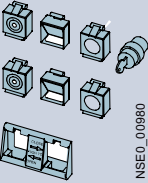
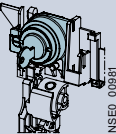
Copper connection pieces	Size	Article No.
–	1	3WL9111-0AA21-0AA0
	2	3WL9111-0AA22-0AA0
	3	3WL9111-0AA23-0AA0
✓	1	3WL9111-0AA31-0AA0
	2	3WL9111-0AA32-0AA0
	3	3WL9111-0AA33-0AA0



Accessories for ETU electronic trip units

EMC filter			
<ul style="list-style-type: none"> Common-mode interference suppressor filters (e.g. in IT networks, caused by frequency converters) Insertion loss (asymmetric) in the range 40 kHz to 10 MHz > 40 dB. 			
Types		Article No.	
Only for ETU Release 2		3WL9111-0AK34-0AA0	
Sealable and lockable covers			
	Accessory for		Article No.
	ETU15B to ETU45B		3WL9111-0AT45-0AA0
	ETU76		3WL9111-0AT46-0AA0
Automatic reset of the reclosing lockout			
Version		Article No.	
Spare part for option K01		3WL9111-0AK21-0AA0	
Remote trip alarm reset coils			
	<ul style="list-style-type: none"> For mechanical tripped indicator Spare part for options K10 to K13 Note: Automatic reset of the reclosing lockout 3WL9111-0AK21-0AA0 is also required 		
	Voltage		Article No.
	24 ... 30 V DC		3WA9111-0EM42
	48 ... 60 V DC		3WA9111-0EM44
	120 V AC/125 V DC		3WA9111-0EM45
208 ... 250 V AC/208 ... 250 V DC		3WA9111-0EM46	
Retrofittable internal wiring			
Use	Male connector	Accessory for	Article No.
Internal wiring of CubicleBUS for connection to terminal X8	Without male connector	ETU45B and ETU76B	3WL9111-0AK30-0AA0
For connection of the external N and G transformers to terminal X8	Without male connector	Not for ETU Release 2 ETU Release 2	3WL9111-0AK31-0AA0 3WL9111-0AK33-0AA0

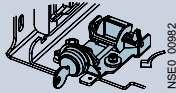
Locking provisions and interlocks

Interlocking sets for mechanical Open/Close			
<ul style="list-style-type: none"> Consisting of two transparent covers each for sealing or for attaching padlocks (padlocks not included in scope of supply) Cover with 6.35 mm hole (for tool actuation) Lock mount for safety lock for key operation 			
	Version		Article No.
	Without safety lock		3WL9111-0BA21-0AA0
	Made by CES		3WL9111-0BA22-0AA0
Made by IKON		3WL9111-0BA24-0AA0	
Locking provision against unauthorized closing from the operator panel			
<ul style="list-style-type: none"> The disconnector unit fulfills the requirements for main circuit breakers acc. to EN 60204-1 Spare part for options S01 to S09 			
	Type	Scope of supply	Article No.
	Assembly kit FORTRESS or CASTELL	Without locks, cylinders or keys	3WL9111-0BA31-0AA0
	Made by RONIS	Locks, cylinders and keys included	3WL9111-0BA33-0AA0
	Made by KIRK-Key	Without locks, cylinders or keys	3WL9111-0BA34-0AA0
	Made by PROFALUX	Locks, cylinders and keys included	3WL9111-0BA35-0AA0
	Made by CES	Locks, cylinders and keys included	3WL9111-0BA36-0AA0
	Made by IKON	Locks, cylinders and keys included	3WL9111-0BA38-0AA0
	Assembly kit for padlocks	Without padlock	3WL9111-0BA41-0AA0

Accessories and spare parts

Locking provisions and interlocks

Locking provision against unauthorized closing, for withdrawable circuit breakers

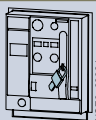


NSE0_00982

- The disconnecter unit fulfills the requirements for main circuit breakers acc. to EN 60204-1
- Consisting of lock in the guide frame, active in connected position, function is retained when circuit breaker is replaced
- Spare part for option R60, R61, R68

Type	Scope of supply	Article No.
Made by CES	Locks, cylinders and keys included	3WL9111-0BA51-0AA0
Made by IKON	Locks, cylinders and keys included	3WL9111-0BA53-0AA0
Made by KIRK-Key ¹⁾	Without locks, cylinders or keys	3WL9111-0BA57-0AA0
Made by RONIS	Locks, cylinders and keys included	3WL9111-0BA58-0AA0
Made by PROFALUX	Locks, cylinders and keys included	3WL9111-0BA50-0AA0

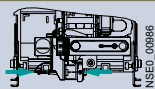
Locking provisions for charging handle with padlock



NSE0_00984

Version	Scope of supply	Article No.
Spare part for option S33	Without padlock	3WL9111-0BA71-0AA0

Locking provision to prevent movement of the withdrawable circuit breaker



NSE0_00986

- Safety lock for mounting onto the circuit breaker
- Spare part for option S71, S75, S76

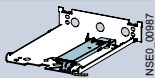
Type	Scope of supply	Article No.
Made by CES	Locks, cylinders and keys included	3WL9111-0BA73-0AA0
Made by IKON	Locks, cylinders and keys included	3WL9111-0BA75-0AA0
Made by PROFALUX	Locks, cylinders and keys included	3WL9111-0BA76-0AA0
Made by RONIS	Locks, cylinders and keys included	3WL9111-0BA77-0AA0
Made by KIRK-Key ¹⁾	Without locks, cylinders or keys	3WL9111-0BA80-0AA0

Interlocking systems

- 2 of the same keys for 3 circuit breakers
- Locking provision in OFF position
- Lock in the operator panel
- A maximum of 2 circuit breakers can be switched on

Type	Article No.
Made by CES	3WL9111-0BA43-0AA0

Locking mechanisms to prevent movement of the withdrawable circuit breakers in disconnected position



NSE0_00987

- Consisting of Bowden cable and lock in the cabinet door on the circuit breaker
- Spare part for option R81, R85, R86
- **Note:** Not possible in combination with "Locking mechanism to prevent opening of the cabinet door" (order code "R30") or "Locking mechanism to prevent movement with the cabinet door open" (order code "R50")

Type	Article No.
Made by CES	3WL9111-0BA81-0AA0
Made by IKON	3WL9111-0BA83-0AA0
Made by PROFALUX	3WL9111-0BA85-0AA0
Made by RONIS	3WL9111-0BA86-0AA0

Locking mechanisms to prevent opening of the cabinet door in ON position



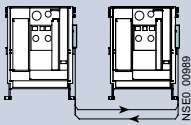


NSE0_00988

- Fixed-mounted
- Defeatable
- **Note:** Not possible in combination with "Locking mechanism to prevent movement of the withdrawable circuit breakers in disconnected position" (order codes "R81", "R85" or "R86").

Version	Article No.
Spare part for option S30	3WL9111-0BB12-0AA0

¹⁾ Locks, cylinders and keys must be ordered from the manufacturer.

Locking provisions and interlocks

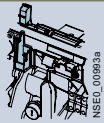
Locking mechanisms to prevent opening of the cabinet door				
<ul style="list-style-type: none"> Guide frames Defeatable Note: Not possible in combination with "Locking mechanism to prevent movement of the withdrawable circuit breakers in disconnected position" (order codes "R81", "R85" or "R86"). 				
Version				Article No.
Spare part for option R30				3WL9111-0BB13-0AA0
Locking mechanisms to prevent movement with the cabinet door open				
<ul style="list-style-type: none"> Guide frames Note: Not possible in combination with "Locking mechanism to prevent movement of the withdrawable circuit breakers in disconnected position" (order codes "R81", "R85" or "R86"). 				
Version				Article No.
Spare part for option R50				3WL9111-0BB15-0AA0
Mechanical interlocks				
<ul style="list-style-type: none"> With Bowden cable 2000 mm (one required for each circuit breaker) 				
Type	When ordered separately	Spare part for	Article No.	
Fixed-mounted circuit breaker	–	Option S55	3WL9111-0BB21-0AA0	
Module for withdrawable circuit breakers with guide frame	–	Option R55	3WL9111-0BB24-0AA0	
Module for guide frame	✓	Option R56	3WL9111-0BB22-0AA0	
Module for withdrawable circuit breaker	✓	Option R57	3WL9111-0BB23-0AA0	
Adapter for size 3 withdrawable circuit breaker	✓	–	3WL9111-0BB30-0AA0	
				
Couplings on the circuit breaker (with ring) for mutual interlocking				
<ul style="list-style-type: none"> Can be used in all circuit breakers 				
				Article No.
				3WL9112-8AH47-0AA0
				
Bowden cable				
Length				Article No.
2000 mm				3WL9111-0BB45-0AA0
3000 mm				3WL9111-0BB46-0AA0
4500 mm				3WL9111-0BB47-0AA0
Test devices				
Manual tester, Release 2 for ETU15B to ETU76B electronic trip units				
<ul style="list-style-type: none"> For testing the electronic trip unit functions of all 3WL ETUs (Release 1 and Release 2) 				
				Article No.
				3WL9111-0AT32-0AA0
				
Function test unit				
<ul style="list-style-type: none"> For testing the tripping characteristics for ETU15B to ETU76B electronic trip units (Release 1 and Release 2) 				
				Article No.
				3WL9111-0AT44-0AA0
TD400 Kit IEC ¹⁾				
<ul style="list-style-type: none"> Commissioning/Service Tool for IEC 3WL (ETU Release 2) and 3VA With adapter, cable and case Not suitable for 3WL10 and 3VA27 				
				Article No.
				3VW9011-0AT40
TD400 adapter (spare part)				
Version				Article No.
For 3VA				3VW9011-0AT43
Only for 3WL ETU Release 1				3VW9011-0AT44
Only for 3WL ETU Release 2				3VW9011-0AT45

¹⁾ A country-specific radio license is required to operate the Bluetooth interface. Before activating the Bluetooth function, ensure that the license is available: www.siemens.com/lowvoltage/certificates

Accessories and spare parts

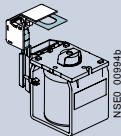
Indicators and control elements

Ready-to-close signaling switches (S20)



Version	Contacts	Article No.
Spare part for option C22	1 NO	3WL9111-0AH01-0AA0

Signaling switch (S22 or S23)



- Not possible with communication port, order code "F02", "F12" or "F35".
- Auxiliary supply connector X7 required for circuit breakers or guide frames. If this is not already available, please order additionally

Version	Contacts	Article No.
Spare part for options C26 and C27	1st or 2nd auxiliary release	3WL9111-0AH02-0AA0

1st tripped signaling switch (S24)

- Not possible with communication port, order code "F02", "F12" or "F35".
- Auxiliary supply connector X7 required for circuit breakers or guide frames. If this is not already available, please order additionally

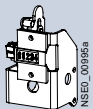
Version	Contacts	Article No.
Spare part for option K07	1 CO	3WL9111-0AH14-0AA0

2nd tripped signaling switch (S25)

- Not possible with communication port, order code "F02", "F12" or "F35".
- Auxiliary supply connector X7 required for circuit breakers or guide frames. If this is not already available, please order additionally
- Can only be used in combination with 1st tripped signaling switch

Version	Contacts	Article No.
Spare part for option K06	1 NO	3WL9111-0AH17-0AA0

Operating cycles counters



- Only in conjunction with motorized operating mechanism

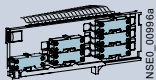
Version	Version	Article No.
Spare part for option C01	Mechanical	3WL9111-0AH07-0AA0

Spring charge signaling switch

- Not possible with communication port, order code "F02", "F12" or "F35".
- Auxiliary supply connector X7 required for circuit breakers or guide frames. If this is not already available, please order additionally

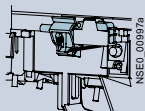
Version	Contacts	Article No.
Spare part for option C20	1 NO	3WL9111-0AH08-0AA0

Position signaling switches for guide frames



Version	Contacts	Article No.
Spare part for options R15 and R16	1st block (3 CO)	3WL9111-0AH11-0AA0
	2nd block (6 CO)	3WL9111-0AH12-0AA0

Local electric close (S10) for operator panel

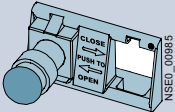


- Not possible with communication port, order code "F02", "F12" or "F35".
- Not possible with motor disconnect switch
- Button + wiring (Auxiliary supply connector X7 required for circuit breakers or guide frames. If this is not already available, please order additionally)
- **Note:** Possible only for circuit breakers with closing coil.


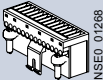
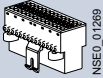

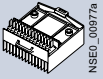
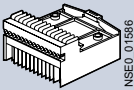
Version	Type	Article No.
Spare part for options C11 and C12	With sealing cap C11	3WL9111-0AJ02-0AA0
	With CES assembly kit C12	3WL9111-0AJ03-0AA0
	With IKON assembly kit	3WL9111-0AJ05-0AA0

Indicators and control elements

Motor disconnect switch (S12)	
<ul style="list-style-type: none"> Mounting onto operator panel Not possible with local electric close 	
Version	Article No.
Spare part for option S25	3WL9111-0AJ06-0AA0
EMERGENCY-OFF pushbuttons	
<ul style="list-style-type: none"> Mushroom pushbutton instead of the mechanical OFF pushbutton 	
Type	Article No.
Spare part for option S24	3WL9111-0BA72-0AA0



Auxiliary conductor connections

Male connectors for circuit breakers ①	
	Article No. 3WA9111-0AB01
Extension for male connector	
<ul style="list-style-type: none"> Male connector must be ordered separately 	
Version	Article No.
1000 V	3WA9111-0AB02
Auxiliary supply connector for circuit breakers or guide frames ②	
Version	Article No.
Screw connection (SIGUT)	3WA9111-0AB03
	
Screwless connection (tension spring)	3WL9111-0AB04-0AA0
	
Coding kits ③	
Version	Article No.
For fixed-mounted X5 to X8	3WA9111-0AB07
	
Sliding contact modules for guide frames ④	
Version	Article No.
	3WA9111-0AB08
	
One-part sliding contact modules for guide frames ⑤	
Version	Article No.
Screw connection (SIGUT)	3WL9111-0AB18-0AA0
	
Blanking blocks for circuit breakers	
	Article No.
	3WA9111-0AB12

For a complete auxiliary circuit connection you must order:

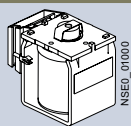
Fixed-mounted version: ① + ② + ③

Withdrawable version: ① + ④ + ② or ① + ⑤

Accessories and spare parts

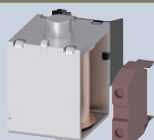
Auxiliary release

Closing coils/shunt trips



Version	Voltage	Article No.
100% OP	24 ... 30 V DC	3WA9111-0AD02
	48 ... 60 V DC	3WA9111-0AD04
	110 ... 125 V DC/110 ... 127 V AC	3WA9111-0AD05
	220 ... 250 V DC/208 ... 240 V AC	3WA9111-0AD06

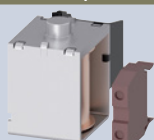
Closing coils (CC)



- For momentary duty, with cut-off switch S15

Version	Voltage	Article No.
5% OP Switching time 50 ms	24 ... 30 V DC	3WA9111-0AD12
	48 ... 60 V DC	3WA9111-0AD14
	110 ... 125 V DC/110 ... 127 V AC	3WA9111-0AD15
	220 ... 250 V DC/208 ... 240 V AC	3WA9111-0AD16

Shunt trips (ST)



- For momentary duty, with cut-off switch S14

Version	Voltage	Article No.
5% OP Switching time 50 ms	24 ... 30 V DC	3WA9111-0AD22
	48 ... 60 V DC	3WA9111-0AD24
	110 ... 125 V DC/110 ... 127 V AC	3WA9111-0AD25
	220 ... 250 V DC/208 ... 240 V AC	3WA9111-0AD26

Undervoltage release



Version	Voltage	Article No.
Instantaneous (UVR)	24 ... 30 V DC	3WA9111-0AE02
	48 ... 60 V DC	3WL9111-0AE04
	110 ... 125 V DC/110 ... 127 V AC	3WA9111-0AE05
	220 ... 250 V DC/208 ... 240 V AC	3WA9111-0AE06
	380 ... 415 V AC	3WA9111-0AE07

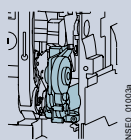


Delayed (UVR-t) ¹⁾	48 V DC	3WA9111-0AE13
	60 V DC	3WA9111-0AE14
	110 ... 125 V DC/110 ... 127 V AC	3WA9111-0AE15
	220 ... 250 V DC/208 ... 240 V AC	3WA9111-0AE16
	380 ... 415 V AC	3WA9111-0AE17

¹⁾ The maximum allowable cable length to the EMERGENCY-OFF actuator (quick shutdown) is currently < 50 m (maximum allowable cable length between the terminals < 100 m).

Operating mechanism

Motorized operating mechanisms

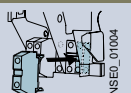


- Auxiliary supply connector X5 required for circuit breakers or guide frames. If this is not already available, please order additionally

Voltage	Article No.
24 ... 30 V DC	3WA9111-0AF02
48 ... 60 V DC	3WA9111-0AF04
110 ... 125 V DC/110 ... 127 V AC	3WA9111-0AF05
220 ... 250 V DC/208 ... 240 V AC	3WA9111-0AF06

Auxiliary contacts

Auxiliary switch blocks



Contacts	Article No.
2 NO + 2 NC	3WL9111-0AG01-0AA0
2 NO	3WL9111-0AG02-0AA0
1 NO + 1 NC	3WL9111-0AG03-0AA0

Door sealing frames, hoods, shutters

Door sealing frames



Version	Article No.
Spare part for option T40	3WL9111-0AP01-0AA0

Protective covers IP55



- Cannot be used in conjunction with door sealing frames
- Hood removable and can be opened on both sides

Article No.
3WL9111-0AP02-0AA0

Shutters

Version	Number of poles	Size	Breaking capacity	Article No.	
Spare part for option R21	3-pole	1	N, S, H	3WL9111-0AP04-0AA0	
		2	N, S, H	3WL9111-0AP06-0AA0	
		3	H, C	3WL9111-0AP07-0AA0	
	4-pole	1	N, S, H	3WL9111-0AP08-0AA0	
		2	N, S, H	3WL9111-0AP11-0AA0	
		3	H, C	3WL9111-0AP12-0AA0	
				C	3WL9111-0AP43-0AA0

Arc chute

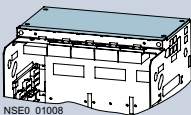
Arc chute



Voltage	Size	Breaking capacity	Article No.
690 V	1	N, S, H	3WL9111-0AS01-0AA0
	2	N, S, H	3WL9111-0AS02-0AA0
	3	H, C	3WL9111-0AS03-0AA0
		C	3WL9111-0AS10-0AA0
1000 V/1150 V	2	H, C	3WL9111-0AS05-0AA0
	3	H, C	3WL9111-0AS06-0AA0

Arc chute covers

- Parts kit for guide frame
- Spare part for option R10
- Not available for:
 - 1000 V version (order code "A05"),
 - 1150 V version (order code "A15")
 - DC version
 - 4000 A size 2
 - Circuit breakers with very high breaking capacity C.

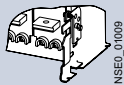


Number of poles	Size	Article No.
3-pole	1	3WL9111-0AS32-0AA0
	2	3WL9111-0AS36-0AA0
	3	3WL9111-0AS38-0AA0
4-pole	1	3WL9111-0AS42-0AA0
	2	3WL9111-0AS44-0AA0
	3	3WL9111-0AS46-0AA0

Accessories and spare parts

Coding for withdrawable version

Coding for withdrawable version



- By customer, for 36 coding variants

Size	Article No.
1, 2	3WL9111-0AR12-0AA0
3	3WL9111-0AR13-0AA0

Grounding connections

Grounding connection between the guide frame and the withdrawable circuit breaker



- Up to 30 kA or 60 kA ground-fault current
- 2 modules must be used for up to 60 kA ground-fault current

Contact module	Size	Number of poles	Article No.
For guide frames	1, 2 ¹⁾		3WL9111-0BA01-0AA0
	3		3WL9111-0BA02-0AA0
	For withdrawable circuit breakers	1	3-pole
4-pole			3WL9111-0BA08-0AA0
2		3-pole ¹⁾	3WL9111-0BA06-0AA0
		4-pole ¹⁾	3WL9111-0BA04-0AA0
3		3-pole	3WL9111-0BA07-0AA0
		4-pole	3WL9111-0BA10-0AA0

¹⁾ Cannot be used for size 2 with very high breaking capacity C and size 2, 4000 A.

Support bracket

Support bracket



- For mounting fixed-mounted circuit breakers on vertical plane
- Only for sizes 1 and 2 (1 set = 2 units)

Article No.
3WL9111-0BB50-0AA0

CubicleBUS modules

- Each **CubicleBUS** module is supplied with a 0.2 m pre-assembled cable to connect the modules with each other. A longer pre-assembled cable is required for connection to the circuit breaker.
- All communication components, **CubicleBUS** modules and metering functions are available for the ETU45B and ETU76B electronic trip units.

Modules of the CubicleBUS modules



Type	Article No.
Digital output module with rotary coding switch, relay outputs	3WL9111-0AT26-0AA0
Digital output module, configurable, relay outputs	3WL9111-0AT20-0AA0
Digital input module	3WL9111-0AT27-0AA0
Analog output module	3WL9111-0AT23-0AA0
ZSI module	3WL9111-0AT21-0AA0

Preassembled cables for the CubicleBUS

For connection to 3WL	Length	Article No.
With COM15/COM16/COM35	0.2 m	3WL9111-0BC04-0AA0
	1 m	3WL9111-0BC02-0AA0
	2 m	3WL9111-0BC03-0AA0
Without COM15/COM16/COM35	2 m	3WL9111-0BC05-0AA0




Voltage transformers

- Required for 3WL circuit breakers with metering function Plus, if no direct voltage tap is available.
- 380 ... 690 V/100 V, class 0.5

Number of poles	Metering function	Article No.
3-pole	With metering function Plus	3WL9111-0BB68-0AA0

Retrofitting and spare parts

- For retrofitting the COM15, COM16 or COM35 communications modules in withdrawable 3WL circuit breakers with Z options A05 (1000 V AC), A15 (1150 V AC) or A16 (690 V + 20%), the following additional assembly kits are required: 3WL9111-0AT62-0AA0 for circuit breakers size 1 or 3WL9111-0AT63-0AA0 for circuit breakers size 2/3

COM35 PROFINET IO/Modbus TCP modules		
	Version	Article No.
	For ETU45B and ETU76B electronic trip units	3WL9111-0AT65-0AA0
PROFINET IO/Modbus TCP retrofit kits		
	<ul style="list-style-type: none"> Retrofit kit for the PROFINET IO/Modbus TCP communication including COM35, BSS and set of cables for all 3WL air circuit breakers with ETU45B and ETU76B electronic trip units 	Article No.
		3WL9111-0AT66-0AA0
PROFIBUS retrofit kits		
	<ul style="list-style-type: none"> Retrofit kit for the PROFIBUS communication including COM15, BSS and set of cables for all 3WL air circuit breakers with ETU45B and ETU76B electronic trip units 	Article No.
		3WL9111-0AT12-0AA0
COM15 PROFIBUS modules		
	Version	Article No.
	For ETU45B and ETU76B electronic trip units	3WL9111-0AT15-0AA0
COM16 Modbus RTU modules		
	Version	Article No.
	For ETU45B and ETU76B electronic trip units	3WL9111-0AT17-0AA0
Modbus RTU retrofit kits IEC		
	<ul style="list-style-type: none"> Retrofit kit for the Modbus communication including COM16, BSS and set of cables for all 3WL air circuit breakers with ETU45B and ETU76B electronic trip units 	Article No.
		3WL9111-0AT18-0AA0
Additional parts for retrofitting the COM15/COM16/COM35 communications modules		
	<ul style="list-style-type: none"> In withdrawable 3WL circuit breakers with Z options: <ul style="list-style-type: none"> A05 (1000 V AC) or A15 (1150 V AC) or A16 (690 V + 20%) 	
	Size	Article No.
	1	3WL9111-0AT62-0AA0
	2,3	3WL9111-0AT63-0AA0
Breaker status sensors (BSS)		
	Version	Article No.
	<ul style="list-style-type: none"> For acquisition via communication of the circuit breaker states ON/OFF/tripped For ETU45B and ETU76B electronic trip units 	3WL9111-0AT16-0AA0
Operating instructions in printed form		
	Description	Article No.
	3WL operating instructions – Upgrade DE/EN	3ZW1012-0WL11-0AB1
	3WL operating instructions – DE/EN	3ZX1812-0WL00-0AN4
	3WL operating instructions – Upgrade IT/FR	3ZW1012-0WL11-0AD1
	3WL operating instructions – IT/FR	3ZX1812-0WL00-0AJ3
	3WL operating instructions – Upgrade ES/PT	3ZW1012-0WL11-0AE1
	3WL operating instructions – ES/PT	3ZX1812-0WL00-0AL3
	Article number assignment for 3WL or 3WL upgrade	Article No.
	3WL breakers	3WL1 - - 3 - - -
		3WL1 - - 4 - - -
	3WL breakers upgrade	3WL1 - - 6 - - -
		3WL1 - - 7 - - -
	3WL guide frames	3WL921 - A - - - -
		3WL921 - B - - - -
		3WL921 - D - - - -
		3WL921 - E - - - -
	3WL guide frames upgrade	3WL921 - F - - - -
		3WL921 - G - - - -
		3WL921 - H - - - -
		3WL921 - I - - - -

Accessories and spare parts

Interfaces

Interface to the IEC 61850

- The SICAM A8000 smart data concentrator connects the circuit breakers from the SENTRON portfolio via the Modbus TCP/IP protocol and transmits data via communication protocols (e.g.: IEC 61850, IEC 60870-5-104, IEC 60870-5-101, Modbus and DNP) to higher-level systems.

Type	Operational voltage	Article No.
SICAM CP-8021 ¹⁾	–	6MF2802-1AA00
SICAM CP-8050 ²⁾	–	6MF2805-0AA00
SICAM PS-8620	24 ... 60 V DC (12 W)	6MF2862-0AA00
SICAM PS-8622	110 ... 220 V DC (12 W)	6MF2862-2AA00



¹⁾ Dimensioned for device quantities of max. 1 × 3WL and 1 × 3VA

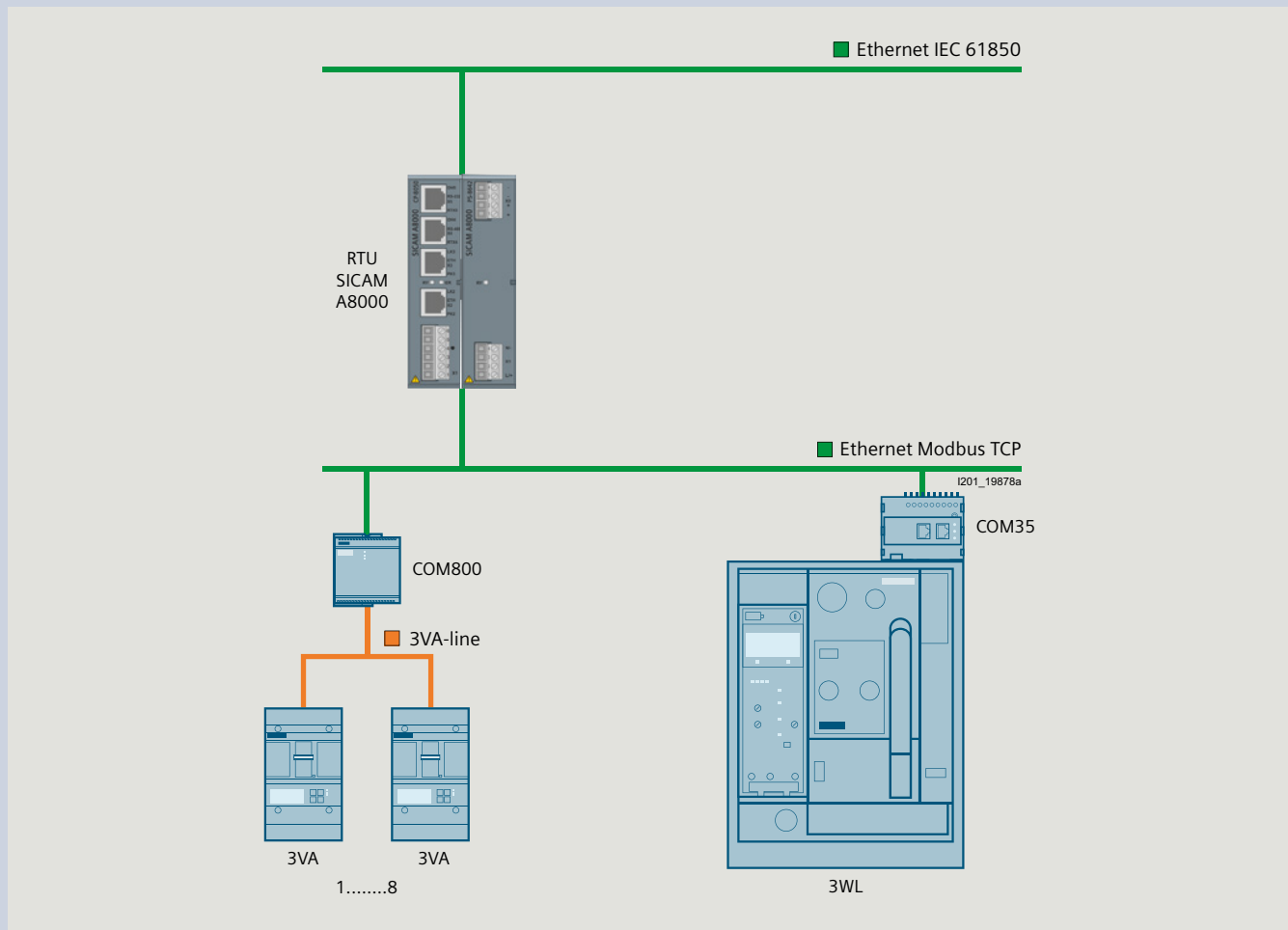
²⁾ Dimensioned for device quantities of 3 × 3WL and 8 × 3VA

You will find further information at:

www.siemens.com/sicam-a8000

For the SICAM CP-8021 and SICAM CP-8050, predefined modules were created to reduce commissioning work to a minimum.

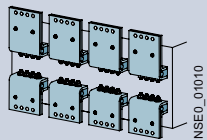
The modules can be obtained free of charge via SiePortal www.siemens.com/lowvoltage/product-support (109816057)



Accessories and spare parts

Main conductor connections, fixed-mounted versions (essential accessory)

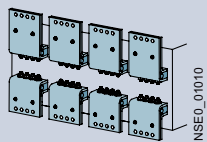
Front-accessible main connections, single hole at top



- Not for 3WL1 size 1 with high breaking capacity H

Size	Rated current I_n	Article No.
1	≤ 1000 A	3WL9111-0AL01-0AA0
	1250 ... 1600 A	3WL9111-0AL02-0AA0
2 ⁴⁾	≤ 2000 A	3WL9111-0AL03-0AA0
	≤ 2500 A	3WL9111-0AL04-0AA0
	≤ 3200 A	3WL9111-0AL05-0AA0
3	≤ 4000 A	3WL9111-0AL06-0AA0

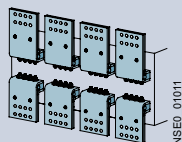
Front-accessible main connections, single hole at bottom



- Not for 3WL1 size 1 with high breaking capacity H

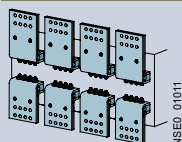
Size	Rated current I_n	Article No.
1	≤ 1000 A	3WL9111-0AL51-0AA0
	1250 ... 1600 A	3WL9111-0AL52-0AA0
2 ⁴⁾	≤ 2000 A	3WL9111-0AL53-0AA0
	≤ 2500 A	3WL9111-0AL54-0AA0
	≤ 3200 A	3WL9111-0AL55-0AA0
3	≤ 4000 A	3WL9111-0AL56-0AA0

Front-accessible main connections according to DIN 43673, double hole at top



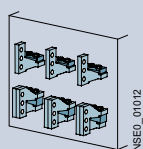
Size	Rated current I_n	Article No.
1	≤ 1000 A ¹⁾	3WL9111-0AL07-0AA0
	1250 ... 2000 A ⁵⁾	3WL9111-0AL08-0AA0
2 ⁴⁾	≤ 2000 A	3WL9111-0AL11-0AA0
	≤ 2500 A	3WL9111-0AL12-0AA0
	≤ 3200 A	3WL9111-0AL13-0AA0
3	≤ 4000 A	3WL9111-0AL14-0AA0

Front-accessible main connections according to DIN 43673, double hole at bottom



Size	Rated current I_n	Article No.
1	≤ 1000 A ¹⁾	3WL9111-0AL57-0AA0
	1250 ... 2000 A ⁵⁾	3WL9111-0AL58-0AA0
2 ⁴⁾	≤ 2000 A	3WL9111-0AL61-0AA0
	≤ 2500 A	3WL9111-0AL62-0AA0
	≤ 3200 A	3WL9111-0AL63-0AA0
3	≤ 4000 A	3WL9111-0AL64-0AA0

Rear vertical main connections



Size	Rated current I_n	Article No.
1 ²⁾	≤ 2000 A	3WL9111-0AM01-0AA0
2 ³⁾	≤ 3200 A	3WL9111-0AM02-0AA0
3	≤ 6300 A	3WL9111-0AM03-0AA0

¹⁾ Not for 3WL1 size 1 with high breaking capacity H

²⁾ In the case of vertical connection size 1 with breaking capacity N and S, up to 1000 A one 3WL9111-0AM01-0AA0 vertical connection is required, up to 2000 A or with breaking capacity H two 3WL9111-0AM01-0AA0 vertical connections are required.

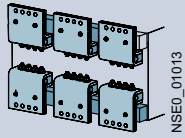
³⁾ In the case of vertical connection size 2, up to 2500 A one 3WL9111-0AM02-0AA0 vertical connection is required, up to 3200 A two 3WL9111-0AM02-0AA0 vertical connections are required.

⁴⁾ Not for circuit breakers with very high breaking capacity C.

⁵⁾ Can be used for size 1 with H breaking capacity of 630 ... 2000 A.

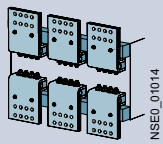
Main conductor connections, withdrawable versions (essential accessory)

Front-accessible main connections, single hole at top or at bottom ¹⁾²⁾



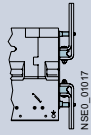
Size	Rated current I_n	Article No.
1	≤ 1000 A	3WL9111-0AN01-0AA0
	1250 ... 1600 A	3WL9111-0AN02-0AA0
2 ³⁾	≤ 2000 A	3WL9111-0AN03-0AA0
	≤ 2500 A	3WL9111-0AN04-0AA0
	≤ 3200 A	3WL9111-0AN05-0AA0
	≤ 4000 A	3WL9111-0AN06-0AA0

Front-accessible main connections according to DIN 43673, double hole at top or at bottom ¹⁾



Size	Rated current I_n	Article No.
1	≤ 1000 A ²⁾	3WL9111-0AN07-0AA0
	1250 ... 2000 A ⁵⁾	3WL9111-0AN08-0AA0
2 ³⁾	≤ 2000 A	3WL9111-0AN11-0AA0
	≤ 2500 A	3WL9111-0AN12-0AA0
	≤ 3200 A	3WL9111-0AN13-0AA0
	≤ 4000 A	3WL9111-0AN14-0AA0

Supports for front and DIN connection bars



Number of poles	Size	Article No.
3-pole for 3 bars	1	3WL9111-0AN41-0AA0
	2	3WL9111-0AN42-0AA0
	3	3WL9111-0AN43-0AA0
4-pole for 4 bars	1	3WL9111-0AN44-0AA0
	2	3WL9111-0AN45-0AA0
	3	3WL9111-0AN46-0AA0

Rear vertical main connections

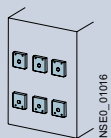


Size	Rated current I_n	Connection pieces	Article No.
1	≤ 1000 A ²⁾		3WL9111-0AN15-0AA0
	1250 ... 2000 A ⁵⁾		3WL9111-0AN16-0AA0
2	≤ 2000 A ³⁾		3WL9111-0AN17-0AA0
	≤ 2500 A ³⁾		3WL9111-0AN18-0AA0
	≤ 3200 A ³⁾		3WL9111-0AN21-0AA0
	1600 ... 3200 A ⁴⁾		3WL9111-0AN38-0AA0
3	≤ 5000 A		3WL9111-0AN22-0AA0
	≤ 6300 A	3 pieces for 3-pole switches	3WL9111-0AN23-0AA0
	≤ 6300 A, top	4 pieces for 4-pole switches	3WL9111-0AN20-0AA0
	≤ 6300 A, bottom	4 pieces for 4-pole switches	3WL9111-0AN10-0AA0

Rear horizontal main connections

Size	Rated current I_n	Article No.
1	≤ 1000 A ²⁾	3WL9111-0AN32-0AA0
	1250 ... 2000 A ⁵⁾	3WL9111-0AN33-0AA0
2	≤ 2000 A ³⁾	3WL9111-0AN34-0AA0
	≤ 2500 A ³⁾	3WL9111-0AN35-0AA0
	≤ 3200 A and 4000 A DC ³⁾	3WL9111-0AN36-0AA0
	1600 ... 3200 A ⁴⁾	3WL9111-0AN47-0AA0
3	≤ 5000 A	3WL9111-0AN37-0AA0

Connecting flange



Size	Rated current I_n	Article No.
1	≤ 1000 A ²⁾	3WL9111-0AN24-0AA0
	1250 ... 2000 A ⁵⁾	3WL9111-0AN25-0AA0
2 ³⁾	≤ 2000 A	3WL9111-0AN26-0AA0
	≤ 2500 A	3WL9111-0AN27-0AA0
	≤ 3200 A	3WL9111-0AN28-0AA0
	≤ 4000 A	3WL9111-0AN31-0AA0

¹⁾ When using front-accessible main connections (withdrawable circuit breakers) supports are required.

²⁾ Not for 3WL1 size 1 with high breaking capacity H

³⁾ Not for circuit breakers with very high breaking capacity C.

⁴⁾ Only for circuit breakers with very high breaking capacity C.

⁵⁾ Can be used for size 1 with H breaking capacity of 630 ... 2000 A.

Accessories and spare parts

Conversion kit

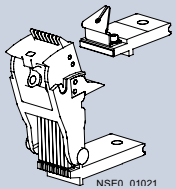
Conversion kit for converting fixed-mounted circuit breakers into withdrawable circuit breakers

- Guide frames and sliding contact modules must be ordered separately
- Conversion from fixed-mounted to withdrawable circuit breakers is not possible for 3WL1 circuit breakers with very high breaking capacity C and for circuit breakers with Z options A05, A15 or A16

Number of poles	Size	Article No.
3-pole	1	3WL9111-0BC11-0AA0
	2	3WL9111-0BC12-0AA0
	3	3WL9111-0BC13-0AA0
4-pole	1	3WL9111-0BC14-0AA0
	2	3WL9111-0BC15-0AA0
	3	3WL9111-0BC16-0AA0

Main contact elements

Main contact elements ^{1) 2)}



- **Notes:**
 - The circuit breaker ID number must be specified when ordering ³⁾
 - Specified for each connection (depending on the number of poles on the circuit breaker, order 3 or 4 units)
 - Article number is automatically adapted to the circuit breaker ID No.

Size	Rated current I_n	Article No.
1	$\leq 1600 \text{ A}^{4)}$	3WL9111-0AM90 L1Y
	$\leq 2500 \text{ A}$	3WL9111-0AM91 L1Y
2	$\leq 4000 \text{ A}$	3WL9111-0AM92 L1Y
	$\leq 6300 \text{ A}$	3WL9111-0AM93 L1Y

¹⁾ Not for circuit breakers with very high breaking capacity C.

²⁾ Replacement of the main contact elements for 3WL1 circuit breakers with very high breaking capacity C is only possible at the factory.

³⁾ Please specify the circuit breaker ID No. in plain text when ordering.

⁴⁾ Not for size 1 circuit breakers with breaking capacity H and circuit breakers with $I_n = 2000 \text{ A}$. The main contact elements can only be replaced in the factory.

Online configurator highlights

www.siemens.com/lowvoltage/configurators

Search function with global direct input

Searches for specific terms and jumps to MLFB based on input to the correct configurator

1

Product list stores multiple configurations and can transfer them collectively to the shopping cart

List of products

Projectdata

Load product list

No.	Article	Quantity	Unit price:	Documents
1	3WL1106-2EB62-1AA2 Fixed-mounted circuit breaker 3-pole, Size 1, IEC In=630 A to 690 V, 50/60 Hz AC Icu=55 kA at 500 V Rear horizontal connection Overcurrent release ETU 45 LSIN protection adjustable 0.4-1 in with cubicle bus Opt...	1	on request	> all documents for position
+ 2	3VA2450-6KP32-0AA0 3VA molded case circuit breaker circuit breaker 3VA2 IEC frame 630 breaking capacity class H Icu=85kA @ 415V 3-pole, line protection ETU850, LSI, In=500A overload protection Ir=200A...500A short-circuit protection Isd=0.6..10x In,...	1	on request	> all documents for position

Recall of completed configurations for modification or additional configuration

List of products

Projectdata

Load product list

No.	Article	Quantity	Unit price:	Documents
1	3WL1106-2EB62-1AA2 Fixed-mounted circuit breaker 3-pole, Size 1, IEC In=630 A to 690 V, 50/60 Hz AC Icu=55 kA at 500 V Rear horizontal connection Overcurrent release ETU 45 LSIN protection adjustable 0.4-1 in with cubicle bus Opt...	1	on request	> all documents for position
+ 2	3VA2450-6KP32-0AA0 3VA molded case circuit breaker circuit breaker 3VA2 IEC frame 630 breaking capacity class H Icu=85kA @ 415V 3-pole, line protection ETU850, LSI, In=500A overload protection Ir=200A...500A short-circuit protection Isd=0.6..10x In,...	1	on request	> all documents for position

Responsive Design

SIEMENS

Log in Additional actions Support Language

Configurators for Low-voltage

Search for (e.g. 3WL1110-4EB36-GEQ8-Z A05+80...)

1 Select Type of Prod... 2 Select Category

MCCB - molded case circuit breaker

ACB - air circuit breaker

Additional products

www.siemens.com/lowvoltage/3wl10-configurator

Download an ePlan selector for 3WL10

The configuration is complete. You can order this product.

Basic configuration | Trip units | Main connection | Motor | Auxiliary release / Closing coil | Result | CAD/CAE

3WL1010-2CE41-0AA0

Preview
Area Model View | Wire frame view | 3D view | Unit Wiring Diagram IEC
Fluorescence drawings

Documentation and reporting

Choose languages for the data sheet: deutsch

Project data for the datasheet

Download selection of document types

Datashheets (PDF)

Selection of download format

All in a ZIP file

Start generation

Component documentation

3WL1010-2CE41-0AA0

Datashheet (PDF)

EPLAN Macro (EDZ)

© Siemens AG | Application information

Download – quick links
3WL1010-2CE41-0AA0
Click2CAD

Download – all CAD formats

View: Area Model View

View option: Isometric

File type: Joint Photography Experts Group (*.jpg)

Start generation

Download – all documents
open documents dialog

Mouseover display of characteristic curves to show the protective function

The configuration is not complete, please set all orange values.

Basic configuration | Trip units | Main connection | Motor | Auxiliary release / Closing coil

Choose value...

Trip units	Protective function	Communication capability	Metering capability	Display
Non-automatic breaker	-	-	-	-
ETU120	LI	-	-	-
ETU350	LI	-	-	-
ETU360	-	-	-	-
ETU650	-	yes	yes	yes
ETU660	-	yes	yes	yes

Graph showing characteristic curves (I, t) for the selected trip unit.

Direct entry of an already known article number or parts of an article number

3WL Air Circuit Breakers

Product Information | Configurators

Select a Configurator: 3WL10 Air Circuit-Breakers, F50

3WL10 Air Circuit-Breakers, F50

Selection - Tool for air circuit breakers (ACB) SENTRON 3WL10 from 630 A to 1250 A

- for selective line protection
- for motor protection
- non-automatic circuit breaker

Using this configurator, you can precisely select the optimum circuit breaker configuration for your application. Comprehensive CAX-data support of the device is provided after successful configuration.

Start

MLFB direct input (complete): 3WL1010-2CE41-0AA0

Start

Structure of the article numbers

Basic configuration

The structure shown below is intended as an overview of each position and its meaning. For a complete and valid configuration of your air circuit breaker, please use our online configurator at www.siemens.com/lowvoltage/3wl10-configurator

		6	7	8	9	10	11	12	13	14	15	16
3WL10				-					-			
Circuit breakers, non-automatic circuit breakers and ETU												
Max. rated current $I_{n \max}$	630 A	0	6									
	800 A	0	8									
	1000 A	1	0									
	1250 A	1	2									
Short-circuit breaking capacity I_{cu} at 415 V	B Basic (42 kA)			1								
	N ECO (55 kA)			2								
	S Standard (66 kA)			3								
Non-automatic circuit breaker ¹⁾	Without metering function, without communications interface				A	A						
Circuit breakers, ETU 3-series	Without metering function, without communications interface			ETU320 LI (N) ²⁾	A	B						
				ETU350 LSI (N) ²⁾	A	C						
				ETU360 LSI (N) ²⁾	A	D						
Circuit breakers, ETU 6-series				ETU650 LSI (N) ²⁾		E						
				ETU660 LSI (N) ²⁾		F						
	Without communications interface				A							
	With communications interface				B							
				Metering function Voltage tap on bottom Basic	C							
				Voltage tap on top	D							
				Metering function Voltage tap on bottom Advanced	E							
				Voltage tap on top	F							
Number of poles	Fixed-mounted versions	3-pole						0				
		4-pole	Neutral left					1				
			Neutral right					2				
	Withdrawable	3-pole						3				
		4-pole	Neutral left					4				
			Neutral right					5				

¹⁾ Only possible with N = ECO (55 kA) and S = Standard (66 kA)

²⁾ Neutral conductor protection for 3-pole breakers with an external neutral conductor transformer or for 4-pole breakers

Connection ³⁾

Type of mounting	Withdrawable	Without frame	0
		Rear vertical connection	1
		Rear horizontal connection	2
		Adapter for cable lug connection (rear)	4
		Front-accessible, extended main connection	5
	Fixed-mounted versions	Rear vertical connection	1
		Rear horizontal connection	2
		Front main connection	3
		Circular conductor terminals (front)	4
		Front-accessible, extended main connection	5

³⁾ Broadened connections available as accessories.

3WL10

6	7	8	9	10	11	12	13	14	15	16
---	---	---	---	----	----	----	----	----	----	----

Motor

Operating mechanisms	Manual operating mechanism		0
	Spring charging motor	24 ... 30 V AC/DC	1
		48 ... 60 V AC/DC	2
		110 V AC/DC	3
		230 V AC/DC	4

Auxiliary releases, closing coils

Closing coil (CC), remote reset magnet (RR)	Without closing coil, without remote reset magnet		A
	Closing coils (CC)	24 V AC/DC	B
		30 V AC/DC	C
		48 V AC/DC	D
		60 V AC/DC	E
		110 ... 120 V AC/DC	F
		120 ... 127 V AC/DC	G
		220 ... 240 V AC/DC	H
	240 ... 250 V AC/DC	J	
	Closing coil (CC) and additional remote reset magnet (RR)	24 V AC/DC	K
		110 V AC/DC	L
		220 V AC/DC	M

2nd auxiliary release	Without 2nd auxiliary release		A
	With undervoltage release (UVR)	24 V AC/DC	B
		30 V AC/DC	C
		48 V AC/DC	D
		60 V AC/DC	E
		110 ... 120 V AC/DC	F
		120 ... 127 V AC/DC	G
		220 ... 240 V AC/DC	H
		240 ... 250 V AC/DC	J
		380 ... 400 V AC/DC	K
		415 ... 440 V AC/DC	L
	With undervoltage release (UVR), delayable with external time-delay device Scope of supply: UVR + time-delay device	24 ... 30 V AC/DC	M
		110 ... 127 V AC/DC	N
		220 ... 250 V AC/DC	P
	With 2nd shunt trip (ST2)	24 V AC/DC	Q
		30 V AC/DC	R
		48 V AC/DC	S
		60 V AC/DC	T
		110 ... 120 V AC/DC	U
120 ... 127 V AC/DC		V	
220 ... 240 V AC/DC		W	
240 ... 250 V AC/DC		X	

1st auxiliary release	Without 1st Auxiliary release		0
	Shunt trips (ST)	24 V AC/DC	1
		30 V AC/DC	2
		48 V AC/DC	3
		60 V AC/DC	4
		110 ... 120 V AC/DC	5
		120 ... 127 V AC/DC	6
		220 ... 240 V AC/DC	7
240 ... 250 V AC/DC	8		

Accessory options

For a complete and valid configuration of your air circuit breaker, please use our online configurator at www.siemens.com/lowvoltage/3wl10-configurator

To specify the options, add "-Z" to the complete article number and indicate the appropriate order code(s).

3WL....-.....-.... -Z

Order code

Accessories for basic configuration

Mounting options for fixed-mounted versions

- In the basic configuration, the fixed-mounted circuit breaker is mounted onto the rear panel. Floor mounting is possible as an option. The device must additionally be modified if it is to be extended to include functionalities such as external auxiliary switches or mechanical interlocking mechanism.¹⁾

Mounting options for fixed-mounted versions ¹⁾			Order code
Mounting options for fixed-mounted versions ¹⁾	Floor mounting	Mounting support standard	A07
		Mounting support extended ²⁾	S56
	Rear panel mounting onto mounting plate	Side wall extended ²⁾	S57

Accessories for ETU electronic trip units

Rating plugs

- As standard, the electronic trip units are equipped with a rating plug for setting the rated current I_n , which is equal to the maximum rated circuit breaker current ($< I_{n \max}$). The rated current of the selected rating plug must be less than or equal to $I_{n \max}$.
- To downrate the circuit breaker, a rated current smaller than $I_{n \max}$ is selected for the rating plug via a Z option.
- Other functions can also be activated using rating plugs (L = OFF or Rc protection).

Rating plug				Order code
Rating plug	For setting the rated current I_n	For all ETUs	400 A	B04
			630 A	B06
			800 A	B08
			1000 A	B10
	For setting the rated current I_n , with overload protection L = OFF	For 6-series ETUs	400 A	L04
			630 A	L06
			800 A	L08
			1000 A	L10
			1250 A	L12
	For setting the rated current I_n , for enabling of the residual current protective function. The residual current function is only possible with the MF Advanced metering function.	For ETU660 only	400 A	G04
630 A			G06	
800 A			G08	
1250 A			G12	

Communications modules

- No more than two different communications modules can be used at the same time.
- When using an IOM040 digital I/O module (Z option K56), only 1 communications module can be used.

Communications modules			Order code
COM040	PROFIBUS		F02
COM041	PROFINET		F03
COM043	Modbus TCP		F11
COM042	Modbus RTU		F12

Breaker Connect modules

- When a circuit breaker with a communications interface is ordered, a Breaker Connect module for external 24 V DC power supply of the electronic components is also supplied ready installed.
- By means of this Z option, the Breaker Connect module for 24 V DC is replaced by a Breaker Connect module for 110 ... 240 V AC/DC.

Breaker Connect modules	110 ... 240 V AC/DC	Order code
		F26

I/O modules internal

I/O modules internal	Digital I/O module IOM040	2 inputs, 2 outputs	Order code
			K56

¹⁾ These functionalities can be applied directly to the frame of the withdrawable circuit breaker, without any modification of the side wall.

²⁾ Not possible in connection with or as an alternative to the mounting support, standard (A07).

To specify the options, add "-Z" to the complete article number and indicate the appropriate order code(s).

3WL.....-.....-..... -Z

Order code

Accessories for the motor

Mechanical operating cycles counter, 5-digit

C01

Auxiliary switches and signaling switches

- Auxiliary and signaling switches for currents > 100 mA and up to 400 V AC are installed as standard.
- For currents < 100 mA for PLC connections, these auxiliary and signaling switches can be replaced.
- The auxiliary/signaling switches for 24 V DC digital signals are designed for
 - a minimum load above 1 mA at 5 V DC, and
 - a maximum breaking capacity of 100 mA at 24 V DC.

Position signaling switches for guide frames ¹⁾ 2 CO | 2 CO | 2 CO (connected | test | disconnected position) K55

Signaling switches Ready-to-close signaling switches 1 CO digital, 24 V DC K50

Tripped signaling switches (S24) 1 CO digital, 24 V DC K53

Spring charge signaling switch (S21) 1 CO digital, 24 V DC K54

Auxiliary switches ON/OFF AUX 4 CO digital, 24 V DC K51

2 CO 400 V AC + 2 CO digital 24 V DC K52

Locking, blocking and interlocking

Locking provisions ¹⁾ To prevent movement of the withdrawable circuit breaker Cylinder lock Made by RONIS R78

For no more than 3 padlocks, 8 mm R65

Locking mechanisms To prevent movement to disconnected position R79

Locking provisions Against unauthorized closing in the operator panel (safe OFF) Cylinder lock, made by RONIS S08

For no more than 3 padlocks, plastic 4 mm S22

For no more than 1 padlock, metal 7 mm S23

For no more than 2 padlocks, metal 8 mm S07

Interlocking sets For mechanical Open and/or Close on the operator panel For no more than 3 padlocks, plastic 4 mm S42

For no more than 1 padlock, metal 7 mm S43

For no more than 2 padlocks, metal 8 mm S44

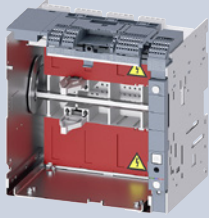
Protective covers For mechanical Open/Close, not lockable S41

Door sealing frames IP30 IP3x T30

¹⁾ Can be used both for individual orders of the guide frame and complete orders (circuit breaker + guide frame).

Guide frames

Guide frames for ordering separately without circuit breakers



- Guide frames without breakers up to 1250 A
- **Note:** All CB bus modules for communication COM04x/IOM300/Breaker Connect module, as well as COMPSS signaling switches are configured without frames in the withdrawable circuit breaker and defined there by means of Z options, and are included with the circuit breaker. PSS Standard is always included in the frame and can be changed to an electronics-capable signal by means of a Z option.

Number of poles	Connection type	Article No.
3-pole	Rear vertical	3VW8112-0AA01
	Rear horizontal	3VW8112-0AB01
	4 × 240 mm ² Cu/Al cable connection, for cable lug connections	3VW8112-0AD01
	Front connection bars, extended	3VW8112-0AE01
4-pole	Rear vertical	3VW8112-0BA01
	Rear horizontal	3VW8112-0BB01
	4 × 240 mm ² Cu/Al cable connection, for cable lug connections	3VW8112-0BD01
	Front connection bars, extended	3VW8112-0BE01

To specify the options, add "-Z" to the complete article number and indicate the appropriate order code(s).

3VW8....-.....-.... -Z

Order code

Locking, blocking and interlocking

Locking provisions	To prevent movement of the withdrawable circuit breaker	Cylinder lock, made by RONIS	R78
		For no more than 3 padlocks, 8 mm	R65
Locking mechanisms	To prevent movement to disconnected position (only in combination with R78 or R65)		R79

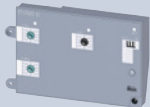



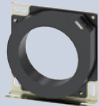
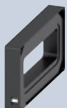


Auxiliary/signaling switches

Position signaling switch PSS for guide frame	For 24 V DC digital signals, for minimum currents	2 CO 2 CO 2 CO (connected test disconnected position)	K55
--	---	---	-----

Auxiliary and signaling switches for currents > 100 mA and up to 400 V AC are installed as standard. For currents < 100 mA for PLC connections, these auxiliary and signaling switches can be modified. The auxiliary/signaling switches for 24 V DC digital signals are designed for

- a minimum load above 1 mA at 5 V DC, and
- a maximum breaking capacity of 100 mA at 24 V DC.

ETU electronic trip units and accessories

Electronic trip units (ETU)					
	Version	With communications/metering function/enhanced protective functions	Type	Protective function	Article No.
	With rotary coding switches	No	ETU320	LIN	3VW9011-5AA00
			ETU350	LSIN	3VW9012-5AA00
			ETU360	LSING	3VW9012-7AA00
	With display	Yes	ETU650	LSIN	3VW9017-5AA00
			ETU660	LSING	3VW9017-7AA00
Metering functions for ETU650 or ETU660					
	Description	Protective function/version	Arrangement	Article No.	
	Metering function	MF Basic	–	3VW9011-0AT01	
		MF Advanced	–	3VW9011-0AT04	
	Set of cables for voltage tap for MF	For 4-pole circuit breakers with neutral right	Top or bottom	3VW9011-0AT08	
		For 4-pole circuit breakers with neutral left	Top	3VW9011-0AT75	
			Bottom	3VW9011-0AT76	
For 3-pole circuit breakers		Top	3VW9011-0AT72		
		Bottom	3VW9011-0AT73		
External current transformers for N conductor					
	Accessory for	Use	Article No.		
	ETU320, ETU350, ETU360, ETU650, ETU660	For 3-pole circuit breakers only	3VW9011-0AA30		
External current transformers for transformer neutral point					
	Accessory for	G_{ret} (Ground return)	Article No.		
	ETU660	100 A	3VW9011-0GF30		
		250 A	3VW9011-0GF31		
Summation current transformers external Rc-CT for residual current measurement					
	<ul style="list-style-type: none"> Only with MF Advanced metering function and Rc rating plug 				
	Accessory for	Use	Article No.		
	ETU660	For external residual current measurement	3VW9011-0RC30		
Remote reset magnets RR for the circuit breakers including tripped signaling					
	<ul style="list-style-type: none"> Remote reset magnet (RR) for resetting the circuit breaker after tripping as a result of overcurrent conditions 				
	Accessory for	Voltage	Article No.		
	ETU320, ETU350, ETU360, ETU650, ETU660	24 V DC	3VW9011-0AK03		
		110 V AC/DC	3VW9011-0AK05		
		250 V AC/DC	3VW9011-0AK06		
Spare part batteries for ETU electronic trip unit					
	Accessory for	Article No.			
	ETU320, ETU350, ETU360, ETU650, ETU660	3VW9011-0AT38			

1

ETU electronic trip units and accessories

Rating plugs



- Only one module is possible per circuit breaker.

Accessory for	Version	Rated current I_n	Article No.
ETU320, ETU350, ETU360, ETU650, ETU660	Rating plugs for setting ($< I_{n \max}$) the rated current I_n	400 A	3VW9011-0AA53
		630 A	3VW9011-0AA55
		800 A	3VW9011-0AA56
		1000 A	3VW9011-0AA57
		1250 A	3VW9011-0AA58
ETU 6-series	Rating plug without overload protection (L = OFF) and for setting ($< I_{n \max}$) the rated current I_n	400 A	3VW9011-0LF53
		630 A	3VW9011-0LF55
		800 A	3VW9011-0LF56
		1000 A	3VW9011-0LF57
		1250 A	3VW9011-0LF58
ETU660	Rating plug Rc for ETU660, for enabling the residual current protective function and setting ($< I_{n \max}$) the rated current I_n . The residual current function is only possible with the MF Advanced metering function.	400 A	3VW9011-0RC53
		630 A	3VW9011-0RC55
		800 A	3VW9011-0RC56
		1250 A	3VW9011-0RC58

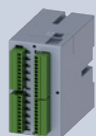
CB bus modules – communications modules



- Contains the communications module
- No more than two different communications modules can be used at the same time
- When using a digital I/O module IOM040 (Z option K56), only 1 communications module can be used
- Can only be used with ETU of the 6-series and require a Breaker Connect module for connection to the circuit breaker. This can also be configured directly on the device by means of a Z option if the communications interface to the ETU 6-series is selected.

Communications module	Protocol	Article No.
COM040	PROFIBUS	3VW9011-0AT15
COM041	PROFINET	3VW9011-0AT14
COM043	Modbus TCP	3VW9011-0AT16
COM042	Modbus RTU	3VW9011-0AT17

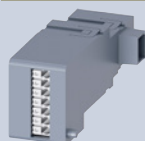
CB bus modules – I/O modules external IOM300



- For snapping onto DIN rail

Accessory for	Maximum switching current per contact	Inputs	Outputs	Article No.
ETU 6-series	<ul style="list-style-type: none"> • 2 A at ≤ 30 V DC • 0.8 A at 50 V DC • 0.2 A at 150 V DC • 4 A at 250 V AC 	11	10	3VW9011-0AT20

CB bus modules – I/O modules internal IOM040



- When using a digital I/O module IOM040, only 1 communications module can be used

Accessory for	Maximum switching current per contact	Inputs	Outputs	Article No.
ETU 6-series	<ul style="list-style-type: none"> • 2 A at ≤ 30 V DC • 0.8 A at 50 V DC • 0.2 A at 150 V DC • 4 A at 250 V AC 	2	2	3VW9011-0AT30

Actuator module COM ACT



- For switching the circuit breaker on/off remotely via communication
- Actuation of the closing coil (CC) and the 1st shunt trip (ST)
- Can only be used in combination with a communications module, spring charging motor, closing coil and 1st shunt trip
- Automatically included if the communications interface of the ETU 6-series is selected in the basic circuit breaker configuration

Accessory for	Article No.
ETU 6-series	3VW9011-0AT10

Breaker Connect modules



- For external power supply for the electronics components

Voltage	Article No.
110 ... 240 V AC/DC	3VW9011-0AT06
24 ... 48 V DC	3VW9011-0AT07

Auxiliary contact signaling switch for communications interface



- Auxiliary contacts for signaling the readiness to close or for position signaling switches of the withdrawable positions.
- Can only be used in combination with communications module.
- Can be combined with standard position signaling switches or ready-to-close signaling contacts.
- **Note:** Both signaling switches are automatically included in the basic circuit breaker (COM PSS only with withdrawable versions) if the communications interface of the ETU 6-series is selected.

Function	Article No.
Ready-to-close signaling switch for communication COM RTC	3VW9011-0AT11
Position signaling switch COM PSS (for withdrawable breaker only)	3VW9011-0AT12

Test devices and Breaker Data Adapters



- Can be used for all ETU 3-series and 6-series

Function	Type	Article No.
Test device <ul style="list-style-type: none"> • For the trip test via ETU and tripping solenoid including release • Activation of the ETU and the tripping solenoid by means of a battery built into the test device • On activation in the ETU 6-series, the parameters can be configured on the display 	TD310	3VW9011-0AT32
Breaker Data Adapter <ul style="list-style-type: none"> • As gateway for parameterization of the ETU with SENTRON Powerconfig • For generation of a report of the set parameters with powerservice 	TD410	3VW9011-0AT34
Test devices and Breaker Data Adapters <ul style="list-style-type: none"> • As gateway for parameterization of the ETU with SENTRON Powerconfig <ul style="list-style-type: none"> – Testing a tripping operation using SENTRON Powerconfig • For use with the powerservice software <ul style="list-style-type: none"> – Testing of the basic protective functions LSING – Testing of the enhanced protective functions – Test data storage – Readout of ETU buffer – Generation of a report of the set parameters 	TD420	3VW9011-0AT33

1

Accessories and spare parts

Accessories for connection

Front main connections acc. to IEC 60947-2

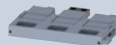
- To be ordered separately for top and bottom



Mounting	Version	Mounting onto	Number of poles/ quantity	Article No.
Fixed-mounted	Front main connections	Front main connections	3-pole/3 units	3VW9011-0AL01
			4-pole/4 units	3VW9011-0AL02
	Extended main connections, including insulation plate and phase barriers, standard	Front main connections	3-pole/3 units	3VW9011-0AL77
			4-pole/4 units	3VW9011-0AL78
	Broadened main connections, including insulation plate and extended phase barriers	Front main connections, top	3-pole/3 units	3VW9011-0AL73
			Front main connections, bottom	3-pole/3 units
Front main connections, top, bottom			4-pole/4 units	3VW9011-0AL74
Withdrawable	Front-accessible main connections	Flange of the guide frame	3-pole/3 units	3VW9011-0AN01
			4-pole/4 units	3VW9011-0AN02
	Broadened main connections	Front-accessible main connections	3-pole/3 units	3VW9011-0AN73
			4-pole/4 units	3VW9011-0AN74

Rear main connections acc. to IEC 60947-2

- To be ordered separately for top and bottom



Mounting	Version	Mounting onto	Number of poles/ quantity	Article No.
Fixed-mounted	Rear main connections, rotatable for horizontal/vertical connection, including terminal cover	Front main connections	3-pole/3 units	3VW9011-0AL32
			4-pole/4 units	3VW9011-0AL33
Withdrawable	Rear main connections, rotatable for horizontal/vertical connection, including terminal cover	Front main connections	3-pole/3 units	3VW9011-0AN32
			4-pole/4 units	3VW9011-0AN33
	Broadened main connections	Rear horizontal main connections	3-pole/3 units	3VW9011-0AN75
			4-pole/4 units	3VW9011-0AN76

Cu/Al cable connections

- To be ordered separately for top and bottom



Mounting	Version	Mounting onto	Number of poles/ quantity	Article No.
Fixed-mounted	Circular conductor terminals $4 \times 240 \text{ mm}^2$ for front cable connection ¹⁾ , including insulation plate and high, extended terminal cover	Front main connections	3-pole/3 units	3VW9011-0AL71
			4-pole/4 units	3VW9011-0AL72
Withdrawable	Set of circular conductor connection pieces $4 \times 240 \text{ mm}^2$ for cable lugs for rear cable connection	Rear vertical main connections	3-pole/3 units	3VW9011-0AN71
			4-pole/4 units	3VW9011-0AN72

Auxiliary supply connectors in push-in version



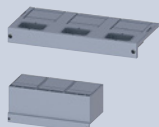
- Control wire tap in push-in version for upgrading fixed-mounted circuit breakers and guide frames.
- The device is always fitted at the factory with the exact number of control wire taps required.

Version	Article No.
Push-in	3VW9011-0AB11

¹⁾ For connecting Al cables up to 1000 A

Accessories for connection

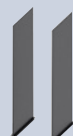
Terminal covers for fixed-mounted circuit breakers



- Finger-proof for front main connection for fixed-mounted versions
- Necessary isolation measures are always supplied with the corresponding connection technology and do not need to be ordered separately.

Version	Number of poles/quantity	Article No.
Standard	3-pole/2 units	3VW9723-0WD30
	4-pole/2 units	3VW9724-0WD40
Extended	3-pole/2 units	3VW9723-0WF30
	4-pole/2 units	3VW9724-0WF40

Phase barriers for fixed-mounted circuit breakers



- Necessary isolation measures are always supplied with the corresponding connection technology and do not need to be ordered separately.
- For operational voltages > 440 V AC the use of phase barriers is mandatory; up to 440 V AC their use is optional.

Height	Number of poles/quantity	Article No.
100 mm (standard)	3-pole/4 units	3VW9723-0WA00
	4-pole/6 units	3VW9724-0WA10
200 mm (extended)	3-pole/4 units	3VW9723-0WA01
	4-pole/6 units	3VW9724-0WA11

Support for floor mounting of fixed-mounted circuit breakers

- For fixed-mounted versions



Version	Use	Article No.
Mounting support standard (circuit breaker feet) (= Z option A07)		3VW9011-0BB51
Mounting support extended (circuit breaker feet), including mechanical transmission of switch position on circuit breaker side panel (= Z option S56)	<ul style="list-style-type: none"> • Fixation for external auxiliary switches AUX 15 CO (3VW9011-0AG15) • Locking mechanism for control cabinet door, direct (for 3VW9011-0BB10) • Locking mechanism for control cabinet door, Bowden cable (for 3VW9011-0BB16) • Mechanical interlock for 3WL/3VA (for 3VW9011-0BB21) 	3VW9011-0BB52

Extension kits for modification of the side wall of the fixed-mounted circuit breaker



- For fixed-mounted versions
- Rear wall fixing on mounting plate
- For modification for mechanical transmission of switch position on circuit breaker side panel (= Z option S57)

Version	Use	Article No.
Extension kit for side wall	<ul style="list-style-type: none"> • Fixation for external auxiliary switches AUX 15 CO (3VW9011-0AG15) • Locking mechanism for control cabinet door, direct (for 3VW9011-0BB10) • Locking mechanism for control cabinet door, Bowden cable (for 3VW9011-0BB16) • Mechanical interlock for 3WL/3VA (for 3VW9011-0BB21) 	3VW9011-0BB53

Accessories and spare parts

Motor

Spring charging motor (MO)



Description	Voltage	Article No.
For automatic charging of the stored energy mechanism	24 ... 30 V AC/DC	3VW9011-0AF01
	48 ... 60 V AC/DC	3VW9011-0AF02
	100 ... 130 V AC/DC	3VW9011-0AF03
	220 ... 250 V AC/DC	3VW9011-0AF04

Mechanical operating cycles counters MOC



Description	Version	Article No.
In combination with a spring charging motor	5 digits	3VW9011-0AH07

Auxiliary releases, closing coils

Closing coils CC/shunt trips ST



Voltage	Article No.
24 V AC/DC	3VW9011-0AD01
30 V AC/DC	3VW9011-0AD02
48 V AC/DC	3VW9011-0AD03
60 V AC/DC	3VW9011-0AD04
110 ... 120 V AC/DC	3VW9011-0AD05
120 ... 127 V AC/DC	3VW9011-0AD06
220 ... 240 V AC/DC	3VW9011-0AD07
240 ... 250 V AC/DC	3VW9011-0AD08
380 ... 400 V AC	3VW9011-0AD17
415 ... 440 V AC	3VW9011-0AD18

TD320 function test units for closing coils/shunt trips



- The TD320 test unit allows the operational availability and functions of the closing coils and shunt trips with a rated operational voltage between 24 V and 250 V (AC and DC) to be tested.
- The operational availability test is performed cyclically at intervals of 30 seconds.
- The unit has visual indicators in the form of LEDs on the front in order to display the following states:
 - LED POWER ON LIT: Correct function of the YO/YC test device
 - LED DEACTIVATION LIT: Power supply failure, wire break
 - LED SHORT-CIRCUIT LIT: Winding short-circuit
 - LED DEACTIVATION and SHORT-CIRCUIT FLASHING: Incorrect power supply
 - LED DEACTIVATION and SHORT-CIRCUIT OFF: Closing coil/shunt trips OK

Version	Article No.
For all closing coils/shunt trips	3VW9011-0AT31

Auxiliary releases, closing coils

Auxiliary/signaling switches



- The auxiliary/signaling switches for 24 V DC digital signals are designed for
 - a minimum load above 1 mA at 5 V DC, and
 - a maximum breaking capacity of 100 mA at 24 V DC.
- For external auxiliary switches ON/OFF AUX 15 CO, a 3VW9011-0AG1x fixation must be ordered in addition, and for fixed-mounted circuit breakers a 3VW9011-0BB5x side wall modification

Type	Contacts	Article No.
Ready-to-close signal RTC	1 CO standard	3VW9011-0AH01
	1 CO digital	3VW9011-0AH02
Auxiliary switch ON/OFF AUX	4 CO standard	3VW9011-0AG01
	4 CO digital	3VW9011-0AG02
	2 CO standard + 2 CO digital	3VW9011-0AG03
External auxiliary switch ON/OFF AUX	15 CO standard	3VW9011-0AG05
	15 CO digital	3VW9011-0AG06
Tripped signaling switch S24	1 CO standard	3VW9011-0AH14
	1 CO digital	3VW9011-0AH15
Spring charge signaling switch S21	1 CO standard	3VW9011-0AH10
	1 CO digital	3VW9011-0AH08
Position signaling switch PSS (for withdrawable devices)	2 CO 2 CO 2 CO (connected test disconnected position) standard	3VW9011-0AH11
	2 CO 2 CO 2 CO (connected test disconnected position) digital	3VW9011-0AH12

Fixing for external auxiliary switches AUX 15 CO



- External auxiliary switches ON/OFF AUX 15 CO must be ordered separately.

Version	Article No.
For fixed-mounted circuit breakers with rear panel or floor mounting (in combination with Z option S56 or S57)	3VW9011-0AG15
For guide frames	3VW9011-0AG17

Undervoltage releases UVR



Voltage	Article No.
24 V AC/DC	3VW9011-0AE01
30 V AC/DC	3VW9011-0AE02
48 V AC/DC	3VW9011-0AE03
60 V AC/DC	3VW9011-0AE04
110 ... 120 V AC/DC	3VW9011-0AE05
120 ... 127 V AC/DC	3VW9011-0AE06
220 ... 240 V AC/DC	3VW9011-0AE07
240 ... 250 V AC/DC	3VW9011-0AE08
380 ... 400 V AC	3VW9011-0AE17
415 ... 440 V AC	3VW9011-0AE18

External time-delay devices for undervoltage release

- With adjustable delay time from 0.5 to 3 s.
- Suitable for mounting onto DIN rail.



Voltage	Article No.
24 ... 30 V AC/DC	3VW9011-0AE10
48 V AC/DC	3VW9011-0AE11
60 V AC/DC	3VW9011-0AE15
110 ... 127 V AC/DC	3VW9011-0AE12
220 ... 250 V AC/DC	3VW9011-0AE13

Accessories and spare parts

Interlocking

Locking provision to prevent movement of the withdrawable circuit breaker



Version	Article No.
RONIS cylinder lock (spare part for R78)	3VW9011-0BA80
Padlock 8 mm (spare part for R65), for no more than 3 padlocks	3VW9011-0BA87

Locking mechanisms to prevent movement of the withdrawable circuit breakers in disconnected position



- Only possible as a supplement in conjunction with R78 (3VW9011-0BA80) and/or R65 (3VW9011-0BA87)

Description	Article No.
Locking mechanism (spare part for R79)	3VW9011-0BA84

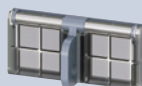
Locking provisions in OFF position



- For fixed-mounted and withdrawable versions
- Against unauthorized closing in the operator panel (safe OFF)
- The disconnecter unit fulfills the requirements for main circuit breakers according to EN 60204-1

Description	Article No.
Cylinder lock, made by RONIS (spare part for S08)	3VW9011-0BA33

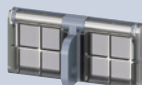
Locking provisions in OFF position



- For fixed-mounted and withdrawable versions
- Against unauthorized closing in the operator panel (safe OFF)
- The disconnecter unit fulfills the requirements for main circuit breakers according to EN 60204-1

Description	Version	Article No.
Padlock 4 mm (spare part for S22)	Plastic for no more than 3 locks	3VW9011-0BA41
Padlock 7 mm (spare part for S23)	Metal for no more than 1 lock	3VW9011-0BA42
Padlock 8 mm (spare part for S07)	Metal for no more than 2 locks	3VW9011-0BA44

Interlocking sets for mechanical Open and/or Close on the operator panel



Description	Version	Article No.
Padlock 4 mm (spare part for S42)	Plastic for no more than 3 locks	3VW9011-0BA22
Padlock 7 mm (spare part for S43)	Metal for no more than 1 lock	3VW9011-0BA23
Padlock 8 mm (spare part for S44)	Metal for no more than 2 locks	3VW9011-0BA24

Protective covers for mechanical Open/Close



- Mechanical Open/Close to protect against unintentional actuation on the operator panel.
- Not lockable

Description	Article No.
Not lockable (spare part for S41)	3VW9011-0BA21

Mechanical interlocks



- Mechanical interlock for 3WL10/3VA27 with Bowden cable 2 m
- For fixed-mounted versions, an additional support 3VW9011-0BB52 (option S56) or extension kit 3VW9011-0BB53 (option S57) must be ordered

Mounting	Mounting	Article No.
Fixed-mounted	Rear panel or floor mounting	3VW9011-0BB21
Withdrawable	Mounting onto guide frame	3VW9011-0BB22

Bowden cable, separate

- One required for each circuit breaker

Type	Article No.
1000 mm	3VW9011-0BB23
2000 mm	3WL9111-0BB45-0AA0
3000 mm	3WL9111-0BB46-0AA0

Interlocking

Locking mechanisms for control cabinet door



- To prevent opening of the control cabinet door in ON position
- It additionally prevents the circuit breaker from being closed when the control cabinet door is open.

Mounting	Version	Article No.
Fixed-mounted onto side panel or floor	Direct fixed interlocking	3VW9011-0BB10
	Locking with Bowden cable	3VW9011-0BB16
Withdrawable	Direct fixed interlocking	3VW9011-0BB14
	Locking with Bowden cable	3VW9011-0BB18

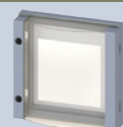
Door sealing frame IP30



- For IP4x and higher, you must order the protective cover IP54 3VW9011-0AP03 or 3VW9011-0AP13.

Description	Mounting	Version	Article No.
Spare part for Z option T30.	Fixed-mounted	IP3x	3VW9011-0AP01
	Withdrawable	IP3x	3VW9011-0AP02

Protective covers IP54



- Protective cover/hood IP54 lockable for fixed-mounted breakers and withdrawable breakers
- For implementing degrees of protection IP4x and IP54 when installing in switchboard door.
- Cannot be combined with IP30 door sealing frame and door mounted rotary operator

Description	Version	Article No.
Lock with unique key	IP54	3VW9011-0AP03
Lock with standard key	IP54	3VW9011-0AP13



One system. For all applications.

Requirements for cost- and energy-efficient operation of electrical power distribution are on the increase. Whether in industrial plants, in infrastructure or in buildings: As a modular, highly adaptable system, the 3VA series of molded case circuit breakers ensures fully reliable protection of personnel and plant, and supports every process phase – from planning to operation of electrical power distribution.

Comprehensively certified. Deployable worldwide.

3VA molded case circuit breakers are available in various ranges with IEC approval; other ranges are available that comply with standard IEC 60947 and standard UL 489. The system is therefore ideally suited for mechanical engineering companies and switchgear manufacturers. The full range of functionalities of molded case circuit breakers can be used for plant and equipment operating in Europe and North America, with absolute standards compliance assured.

Molded Case Circuit Breakers

All the information you need	2/2
Molded case circuit breakers and switch disconnectors for all applications	2/4
Quick selection guide	2/6
Molded case circuit breakers, switch disconnectors and accessories	2/6
3VA1 molded case circuit breakers, switch disconnectors up to 1000 A	2/8
3VA2 molded case circuit breakers up to 1600 A	2/12
Trip units	2/16
Online configurator highlights	2/18
3VA10 – 3VA26	2/20
System overview	2/20
Structure of the article numbers	2/24
Internal accessories	2/28
Manual operators	2/30
Motor operators	2/36
Connection technology	2/38
Plug-in and withdrawable technology	2/52
Residual current devices RCD	2/56
Communication	2/58
Locking, blocking and interlocking	2/64
Cover frame and mounting	2/66
3VA27	2/68
System overview	2/68
Structure of the article numbers	2/72
Accessory options	2/76
Guide frame	2/78
Electronic trip unit ETU and accessories	2/79
Accessories for connection and insulation	2/82
Motor operators and manual operators	2/84
Auxiliary release, closing coil	2/85
Locking provisions and interlocks	2/87
3VL	2/89
3VL up to 1600 A, IEC	2/89

A multitude of additional information ...

Information + ordering

All the important things at a glance

For information about molded case circuit breakers, please visit our website www.siemens.com/3VA

Your product in detail

The SiePortal platform (knowledge base) provides comprehensive information

www.siemens.com/lowvoltage/product-support

- Quick Selection Guide
 - 3VA molded case circuit breaker (**109757591**)

The relevant tender specifications can be found at www.siemens.com/tenderspecifications

Use our conversion tool for quick and easy conversion to Siemens products www.siemens.com/conversion-tool

Siemens YouTube channel

- 3VA molded case circuit breakers (general) sie.ag/2gSX4K

Everything you need for your order

Refer to SiePortal to find an overview of your products (product catalog)

- Molded case circuit breakers sie.ag/2mmLcAk

Direct forwarding to the individual products in SiePortal by clicking on the article number in the catalog or entering this web address incl. article number www.siemens.com/product_catalog_SIEP?Article No.

You will find order support in SiePortal under www.siemens.com/lowvoltage/product-support

- Order Support
 - 3VA molded case circuit breakers – One system. Global use (**109765994**)

Configurators

The configurator reduces the time and effort required in the planning and ordering process, and allows for individual adaptations. Configure your 3VA molded case circuit breaker at

www.siemens.com/lowvoltage/3va-configurator
www.siemens.com/lowvoltage/3va27-configurator

The following are additionally available for your 3VA molded case circuit breaker:

- 3D views
- CAD data
- Unit wiring diagrams
- Dimension drawings

The fast track to the experts

Contact persons in your region

We offer a comprehensive portfolio of services.

You can find your local contacts at

www.siemens.com/lowvoltage/components/contact

You will find further information on services at

www.siemens.com/service-offers

Competent expert advice on technical questions with a wide range of demand-optimized services for all our products and systems.

Assistance with technical queries is provided at

www.siemens.com/support-request

... can be found in our online services

Commissioning + operation

SENTRON Powerconfig

The combined commissioning and service tool SENTRON Powerconfig for communication-capable measuring devices, circuit protection devices and circuit breakers.

Free download SENTRON Powerconfig
www.siemens.com/powerconfig

Free download SENTRON Powerconfig mobile via
[App Store](#) and [Play Store](#)

Your product in detail

The SiePortal platform (knowledge base) provides detailed technical information
www.siemens.com/lowvoltage/product-support

- Operating instructions
- Characteristic curves
- Certificates

Online Support app available for download from the
[App Store](#) and [Play Store](#)

You will find further information at
www.siemens.com/support-app

Provision of 3D data (step and u3d data formats)

- SiePortal (product catalog)
www.siemens.com/lowvoltage/product-catalog
- Image database
www.siemens.com/lowvoltage/picturedb

Engineering data for CAD or CAE systems are available in the CAx Download Manager at
www.siemens.com/cax

Manuals

Manuals can be found in SiePortal at
www.siemens.com/lowvoltage/manuals

- Configuration Manual
 - 3VA selectivity ([109743975](#))
- Communication Manual
 - 3VA molded case circuit breakers with IEC and UL certification ([98746267](#))
 - 3WL10 air circuit breakers & 3VA27 molded case circuit breakers ([109760220](#))
- Equipment Manual
 - 3VA molded case circuit breakers with IEC certificate ([90318775](#))
 - 3VA27 molded case circuit breakers & 3WL10 air circuit breakers ([109753821](#))

Face-to-face or online training

Our training courses can be found at
www.siemens.com/sitrain-lowvoltage

- 3VA molded case circuit breaker (WT-LVA3VA)
- Protection systems in low-voltage power distribution (WT-LVAPS)

Technical overview – Molded case circuit breakers



The fast way to get you to our online services

This page provides you with comprehensive information and links on molded case circuit breakers
www.siemens.com/lowvoltage/product-support ([109767421](#))

Molded case circuit breakers and switch disconnectors for all applications

2



3VA10 ... 3VA15 molded case circuit breakers

Setting standards for standard applications

The 3VA1 molded case circuit breaker is ideally suited for your standard applications in infrastructure and industrial facilities. It is equipped with a thermal-magnetic trip unit, and offers reliable protection for plants and generators.

With its compact dimensions and depth of just 70 mm, the 3VA1 molded case circuit breaker can even fit into locations where space is limited. Thanks to its cover size of 45 mm, it is also ideally suited for use in distribution boards up to 250 A.

Special features

- Compact design
- AC/DC applications
- No derating up to +50 °C
- Optimized for distribution boards (45 mm cover size)
- Universal platform of accessories
- 1, 2, 3 or 4-pole versions
- Rated current range of 1 ... 1000 A



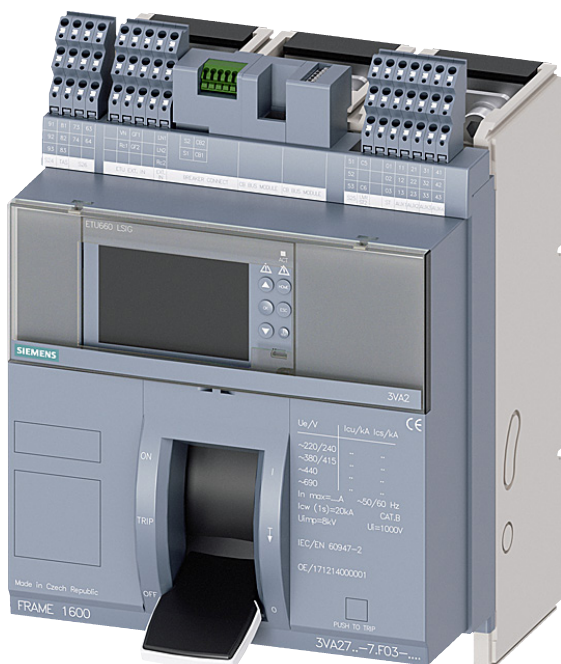
3VA20 ... 3VA26 molded case circuit breakers

The power to deliver in demanding applications

If you are looking for a solution that lets you handle your most technically demanding projects in industrial and infrastructure applications with ease, the 3VA2 molded case circuit breaker has the special capabilities you need. It combines high breaking capacity, a range of electronic trip units (ETUs), very good selectivity properties, and various additional functionalities.

Special features

- Very good selective protection response
- AC applications
- No derating up to +50 °C
- Integrated metering function
- Connection to a communications system
- Rated current range of 25 ... 1250 A



3VA27 molded case circuit breaker

Depending on the application, the 3VA27 molded case circuit breaker handles line/motor and starter protection for low-voltage electrical power distribution, and supplements the existing IEC portfolio with a rated current of 1600 A.

Special features

- Choice between two ranges of electronic trip units with a number of equipment versions
- Variable and versatile connections
- Connection to a communications system
- Can be used as a platform circuit breaker with the 3WL10 ACB, with an extensive range of common accessories
- Rated current range of 800 ... 1600 A

Molded case circuit breakers, switch disconnectors and accessories

2



Protective functions	3VA10	3VA11	3VA12	3VA13	3VA14	3VA15
Size	100 A	160 A	250 A	400 A	630 A	1000 A
Switch disconnectors						
No protection	–	■	■	■	■	–
Thermal-magnetic						
Line protection	■	■	■	■	■	■
Starter protection	–	■	■	■	■	■
Electronic						
Line protection	–	–	–	–	–	–
Line and generator protection	–	–	–	–	–	–
Line and generator protection, with display	–	–	–	–	–	–
Line and generator protection, with display, with metering function	–	–	–	–	–	–
Motor protection	–	–	–	–	–	–
Motor protection, with display	–	–	–	–	–	–
Motor protection, with display, with metering function	–	–	–	–	–	–
Starter protection	–	–	–	–	–	–

Accessories

Size	100 A	160 A	250 A	400 A	630 A	1000 A
Accessories						
Auxiliary switches and signaling switches	■	■	■	■	■	■
Auxiliary releases	■	■	■	■	■	■
Connection technology	■	■	■	■	■	■
Plug-in version	–	■	■	■	■	■
Withdrawable version	–	–	■	■	■	–
Front mounted rotary operator	■	■	■	■	■	■
Door mounted rotary operator	■	■	■	■	■	■
Side wall mounted rotary operator	■	■	■	■	■	–
MO310 motor operator (mounted onto the side)	–	■	–	–	–	–
MO320 motor operator (mounted onto the front)	–	■	■	■	■	–
Motor operator with SEO520 stored energy mechanism	–	–	–	■	■	–
Motor operator (MO), integrable	–	–	–	–	–	–
Locking, blocking and interlocking	■	■	■	■	■	■
Residual current device (mounted onto the side)	–	■	■	–	–	–
Residual current device (mounted underneath)	–	■	■	–	–	–
Communications interface	–	–	–	–	–	–
EFB300	–	–	–	–	–	–
Testing and commissioning devices	–	–	–	–	–	–
Cover frame	■	■	■	■	■	■
DIN-rail adapter	■	■	–	–	–	–
Busbar adapter	■	■	■	■	■	–

■ Available

– Not available/not present



3VA20	3VA21	3VA22	3VA23	3VA24	3VA25	3VA26	3VA27
100 A	160 A	250 A	400 A	630 A	1000 A	1250 A	1600 A
-	-	-	-	-	-	-	■
-	-	-	-	-	-	-	-
-	-	-	-	-	-	-	-
■	■	■	■	■	■	■	■
■	■	■	■	■	■	■	■
■	■	■	■	■	■	■	■
■	■	■	■	■	■	■	■
-	■	■	■	■	■	-	■
-	■	■	■	■	■	-	■
-	■	■	■	■	■	-	■
-	■	■	■	■	■	-	■

100 A	160 A	250 A	400 A	630 A	1000 A	1250 A	1600 A
■	■	■	■	■	■	■	■
■	■	■	■	■	■	■	■
■	■	■	■	■	■	■	■
■	■	■	■	■	■	■	-
■	■	■	■	■	■	■	■
■	■	■	■	■	■	■	■
■	■	■	■	■	■	■	■
■	■	■	■	■	■	■	■
-	-	-	-	-	-	-	-
■	■	■	■	■	■	■	■
-	-	-	-	-	-	-	-
■	■	■	■	■	■	■	■
-	-	-	-	-	-	-	-
■	■	■	■	■	■	■	■
■	■	■	■	■	■	■	■
■	■	■	■	■	■	■	■
-	-	-	-	-	-	-	-
■	■	■	■	■	■	■	■

3VA1 molded case circuit breakers, switch disconnectors up to 1000 A

Technical specifications

2



3VA10

3VA11

3VA11

Electrical characteristics according to IEC 60947-2

		3VA10	3VA11	3VA11
Number of poles		3/4-pole	1-pole	2-pole
Size	A	100	160	160
Rated current I_n at 50 °C ambient temperature	A	16 ... 100	16 ... 160	16 ... 160
Rated operational voltage U_e 50/60 Hz AC	V	690	415	415
Rated insulation voltage U_i	V	800	500	500
Rated impulse withstand voltage U_{imp}	kV	8	8	8
Use in IT networks (breaking capacity acc. to IEC 60947-2, annex H)	V	■	■	■
Frequency	Hz	0 ... 400	0 ... 400	0 ... 400

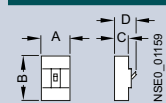
Breaking capacity (line protection)

		B		N		S		M			
Rated ultimate short-circuit breaking capacity I_{cu}											
50/60 Hz AC	220 ... 240 V	kA	25	36	55	25	36	55	36	55	85
	380 ... 415 V	kA	16	25	36	5	6	6	25	36	55
	440 V	kA	8	16	25	–	–	–	–	–	–
	500 V	kA	5	5	7	–	–	–	–	–	–
	690 V	kA	5	5	7	–	–	–	–	–	–
DC ¹⁾	125 V	kA	16	25	30	16	25	30	16	25	30
	250 V	kA	25	36	55	–	–	–	36	55	85
	500 V	kA	25	36	55	–	–	–	–	–	–
	600 V	kA	8	16	25	–	–	–	–	–	–
	750 V	kA	–	–	–	–	–	–	–	–	–
1000 V ²⁾	kA	–	–	–	–	–	–	–	–	–	

Rated service short-circuit breaking capacity I_{cs}

50/60 Hz AC	220 ... 240 V	kA	25	36	55	25	35	55	36	55	85
	380 ... 415 V	kA	16	25	36	5	6	6	25	36	55
	440 V	kA	8	16	25	–	–	–	–	–	–
	500 V	kA	5	5	5	–	–	–	–	–	–
	690 V	kA	5	5	5	–	–	–	–	–	–
DC	125 V	kA	16	25	30	16	25	30	16	25	30
	250 V	kA	25	36	55	–	–	–	36	55	85
	500 V	kA	25	36	55	–	–	–	–	–	–
	600 V	kA	8	16	25	–	–	–	–	–	–
	750 V	kA	–	–	–	–	–	–	–	–	–
1000 V ²⁾	kA	–	–	–	–	–	–	–	–	–	

Dimensions



A	mm	76.2 (3P) 101.6 (4P)	25.4	50.8
B	mm	130	130	130
C	mm	70	70	70
D	mm	88	88	88

¹⁾ For detailed data on DC breaking capacity, number of switching poles and circuit diagrams, see FAQ www.siemens.com/lowvoltage/product-support (109779932)

²⁾ For $I_n = 630$ A/800 A

³⁾ I_n 125 A, 160 A: $I_{cu}/I_{cs} = 36$ kA/36 kA

■ Available – Not available/not present



2

3VA11**3VA12****3VA13****3VA14****3VA15**

3/4-pole

3/4-pole

3/4-pole

3/4-pole

3/4-pole

160

250

400

630

1000

16 ... 160

160 ... 250

320 ... 400

500 ... 630

630 ... 1000

690

690

690

690

690

800

800

800

800

800

8

8

8

8

8

■

■

■

■

≤ 500

0 ... 400

0 ... 400

0 ... 400

0 ... 400

0 ... 400

N	S	M	H	S	M	H	S	M	H	C	S	M	H	C	M	H	C		
36	55	85	100	55	85	100	55	85	100	200	55	85	100	200	85	110	200		
25	36	55	70	36	55	70	36	55	70	110	36	55	70	110	55	70	110		
16	25	36	55 ³⁾	25	36	36	36	55	70	110	36	55	70	110	55	70	110		
7	7	10	10	10	15	15	25	36	55	70	25	36	55	70	36	55	70		
7	7	10	10	7	10	10	7	7	10	10	7	7	10	10	25	35	35		
16	25	30	30	55	85	100	8	16	25	25	8	16	25	25	–	–	–		
36	55	85	100	55	85	100	8	16	25	25	8	16	25	25	35	50	100		
36	55	85	100	55	85	100	8	16	25	25	8	16	25	25	35	50	100		
16	25	36	55	25	36	55	8	16	25	25	8	16	25	25	–	–	–		
–	–	–	–	–	–	–	–	–	–	–	–	–	–	–	35	50	100		
–	–	–	–	–	–	–	–	–	–	–	–	–	–	–	25	35	50		
36	55	85	100	55	85	100	55	85	100	200	55	85	100	200	85	100	150		
25	36	55	70	36	55	70	36	55	70	110	36	55	70	110	55	70	85		
16	25	36	40 ³⁾	25	36	36	36	55	70	110	36	55	70	110	55	70	70		
5	5	5	5	10	10	10	25	36	55	70	25	36	55	70	36	55	65		
5	5	5	5	5	5	5	5	5	6	6	5	5	6	6	19	19	19		
16	25	30	30	55	85	100	8	16	25	25	8	16	25	25	–	–	–		
36	55	85	100	55	85	100	8	16	25	25	8	16	25	25	35	50	100		
36	55	85	100	55	85	100	8	16	25	25	8	16	25	25	35	50	100		
16	25	36	55	25	36	55	8	16	25	25	8	16	25	25	–	–	–		
–	–	–	–	–	–	–	–	–	–	–	–	–	–	–	35	50	100		
–	–	–	–	–	–	–	–	–	–	–	–	–	–	–	25	35	50		
76.2 (3P) 101.6 (4P)				105 (3P) 140 (4P)				138 (3P) 184 (4P)				138 (3P) 184 (4P)				210 (3P) 280 (4P)			
130				158				248				248				320			
70				70				110				110				120			
88				88				137				137				253			

3VA1 molded case circuit breakers, switch disconnectors up to 1000 A

Application

2



		3VA10	3VA11	3VA11
Electrical characteristics according to IEC 60947-2				
Number of poles		3/4-pole	1-pole	2-pole
Size	A	100	160	160
Rated current I_n at 50 °C ambient temperature	A	16 ... 100	16 ... 160	16 ... 160
3VA1 molded case circuit breakers for line protection, standard applications (IEC 60947-2)				
Service life/endurance (operating cycles)				
Mechanical (CLOSE-OPEN cycles)		20000	20000	20000
Electrical	380 ... 415 V	I_n 9000	9000	9000
		$I_n/2$ 15000	15000	15000
	690 V	6300	6300	6300
Trip units				
TM210	FTFM	■	■	■
TM220	ATFM	–	–	–
TM240	ATAM	–	–	–
3VA1 molded case circuit breakers for starter protection (standards and specifications acc. to IEC 60947-2, annex O)				
Rated current I_n at 50 °C ambient temperature		A	–	–
Service life/endurance (operating cycles)				
Mechanical (CLOSE-OPEN cycles)		–	–	–
Electrical	380 ... 415 V	–	–	–
Trip units				
TM120M	AM	–	–	–
Switch disconnectors (IEC 60947-3)				
Electrical characteristics according to IEC 60947-3				
Rated uninterrupted current I_u at 50 °C ambient temperature		A	–	–
Rated operational voltage U_e 50/60 Hz AC		V	–	–
Rated operational voltage U_e DC		V	–	–
Rated conditional short-circuit current I_q with upstream 3VA1 circuit breaker		kA	–	–
Permissible rated short-time current I_{cw} (1 s)		kA	–	–

■ Available – Not available/not present

**3VA11****3VA12****3VA13****3VA14****3VA15**

2

3VA11	3VA12	3VA13	3VA14	3VA15
3/4-pole	3/4-pole	3/4-pole	3/4-pole	3/4-pole
160	250	400	630	1000
16 ... 160	160 ... 250	320 ... 400	500 ... 630	630 ... 1000
20000	20000	20000	20000	10000
9000	8000	6000	4000	4600
15000	14000	12000	8000	7000
6300	5400	4200	3000	3200
■	–	–	–	–
■	–	–	–	–
■	■	■	■	■
1 ... 125	160, 200	250	400 ... 500	630 ... 800
20000	20000	20000	20000	10000
9000	8000	6000	4000	4600
■	■	■	■	■
63 ... 160	250	400	630 (3P), 500 (4P)	–
690	690	690	690	–
500 (3P), 600 (4P)	500 (3P), 600 (4P)	500 (3P), 600 (4P)	500 (3P), 600 (4P)	–
70 at 415 V	70 at 415 V	110 at 415 V 10 at 690 V	110 at 415 V 10 at 690 V	–
2	3	6	7.6 (3P), 6 (4P)	–

3VA2 molded case circuit breakers up to 1600 A

Technical specifications

2



		3VA20				3VA21				3VA22						
Electrical characteristics according to IEC 60947-2																
Number of poles		3/4-pole				3/4-pole				3/4-pole						
Size	A	100				160				250						
Rated current I_n	A	25 ... 100				25 ... 160				160 ... 250						
Rated operational voltage U_e 50/60 Hz AC	V	690				690				690						
Rated insulation voltage U_i	V	800				800				800						
Rated impulse withstand voltage U_{imp}	kV	8				8				8						
Use in IT networks (breaking capacity acc. to IEC 60947-2, annex H)	V	■				■				■						
Frequency	Hz	50/60				50/60				50/60						
Breaking capacity (line protection)		M	H	C	L	M	H	C	L	E	M	H	C	L	E	
Rated ultimate short-circuit breaking capacity I_{cu}																
50/60 Hz AC	220 ... 240 V	kA	85	110	150	200	85	110	150	200	–	85	110	150	200	–
	380 ... 415 V	kA	55	85	110	150	55	85	110	150	200	55	85	110	150	200
	440 V	kA	55	85	110	150	55	85	110	150	–	55	85	110	150	–
	500 V	kA	36	55	85	100	36	55	85	100	–	36	55	85	100	–
	690 V	kA	2	2	2	25	2.5	2.5	2.5	25	85	3	3	3	25	85
DC	125 V (1 switching pole)	kA	–	–	–	–	–	–	–	–	–	–	–	–	–	–
	250 V (2 switching poles)	kA	–	–	–	–	–	–	–	–	–	–	–	–	–	–
	500 V (3 switching poles)	kA	–	–	–	–	–	–	–	–	–	–	–	–	–	–
	600 V (4 switching poles)	kA	–	–	–	–	–	–	–	–	–	–	–	–	–	–
Rated service short-circuit breaking capacity I_{cs}																
50/60 Hz AC	220 ... 240 V	kA	85	110	150	200	85	110	150	200	–	85	110	150	200	–
	380 ... 415 V	kA	55	85	110	150	55	85	110	150	200	55	85	110	150	200
	440 V	kA	55	85	110	150	55	85	110	150	–	55	85	110	150	–
	500 V	kA	36	55	85	100	36	55	85	100	–	36	55	85	100	–
	690 V	kA	2	2	2	18	2.5	2.5	2.5	18	65	3	3	3	18	65
DC	125 V (1 switching pole)	kA	–	–	–	–	–	–	–	–	–	–	–	–	–	–
	250 V (2 switching poles)	kA	–	–	–	–	–	–	–	–	–	–	–	–	–	–
	500 V (3 switching poles)	kA	–	–	–	–	–	–	–	–	–	–	–	–	–	–
	600 V (4 switching poles)	kA	–	–	–	–	–	–	–	–	–	–	–	–	–	–
Dimensions																
	A	mm	105 (3P) 140 (4P)				105 (3P) 140 (4P)				105 (3P) 140 (4P)					
	B	mm	181				181				181					
	C	mm	86				86				86					
	D	mm	107				107				107					

¹⁾ Valid for $I_n = 400$ A, 500 A; for $I_n = 630$ A, $I_{cs} = 65$ kA applies

■ Available

– Not available/not present



3VA23					3VA24					3VA25			3VA26			3VA27		
3/4-pole					3/4-pole					3/4-pole			3/4-pole			3/4-pole		
400					630					1000			1250			1600		
250 ... 400					400 ... 630					630 ... 1000			1250			800 ... 1600		
690					690					690			690			690		
800					800					800			800			1000		
8					8					8			8			8		
■					■					≤ 500			≤ 500			■		
50/60					50/60					50/60			50/60			50/60		
M	H	C	L	E	M	H	C	L	E	M	H	C	M	H	C	M	H	C
85	110	150	200	–	85	110	150	200	–	85	110	200	85	110	200	100	150	200
55	85	110	150	200	55	85	110	150	200	55	85	110	55	85	110	55	85	110
55	85	110	–	–	55	85	110	–	–	55	85	110	55	85	110	55	85	100
36	55	85	–	–	36	55	85	–	–	36	55	85	36	55	85	36	55	85
5	5	5	25	85	6	6	6	25	85	25	35	35	25	35	35	25	36	50
–	–	–	–	–	–	–	–	–	–	–	–	–	–	–	–	–	–	–
–	–	–	–	–	–	–	–	–	–	–	–	–	–	–	–	–	–	–
–	–	–	–	–	–	–	–	–	–	–	–	–	–	–	–	–	–	–
–	–	–	–	–	–	–	–	–	–	–	–	–	–	–	–	–	–	–
85	110	150	200	–	85	110	150	200	–	85	110	150	85	110	150	100	150	200
55	85	110	150	200	55	85	110	150	200	55	85	85	55	85	85	55	85	110
55	85	110	–	–	55	85	110	–	–	55	70	70	55	70	70	55	85	100
36	55	65	–	–	36	55	85 ¹⁾	–	–	36	55	65	36	55	65	36	55	63
5	5	5	18	65	6	6	6	18	65	19	19	19	19	19	19	25	36	36
–	–	–	–	–	–	–	–	–	–	–	–	–	–	–	–	–	–	–
–	–	–	–	–	–	–	–	–	–	–	–	–	–	–	–	–	–	–
–	–	–	–	–	–	–	–	–	–	–	–	–	–	–	–	–	–	–
–	–	–	–	–	–	–	–	–	–	–	–	–	–	–	–	–	–	–
138 (3P) 184 (4P)					138 (3P) 184 (4P)					210 (3P) 280 (4P)			210 (3P) 280 (4P)			210 (3P) 280 (4P)		
248					248					320			320			291		
110					110					120			120			171 (handle operating mechanism) 183 (stored energy operating mechanism)		
137					137					253			253			225		

3VA2 molded case circuit breakers up to 1600 A

Application

2



		3VA20	3VA21	3VA22
Electrical characteristics according to IEC 60947-2				
Number of poles		3/4-pole	3/4-pole	3/4-pole
Size	A	100	160	250
Rated current I_n	A	25 ... 100	25 ... 160	160 ... 250
Service life/endurance (operating cycles)				
Mechanical (OPEN-CLOSE cycles)		25000	25000	25000
Electrical	380 ... 415 V I_n	15000	14000	12000
	$I_n/2$	20000	20000	17000
	690 V	10500	9800	7200
Trip units				
ETU320	LI	■	■	■
ETU330	LIG	■	■	■
ETU340	ELISA LI	–	■	■
ETU350	LSI	■	■	■
ETU550/ETU850	LSI	■	■	■
ETU560/ETU860	LSIG	■	■	■
ETU650	LSI	–	–	–
ETU360	LSIG	–	–	–
ETU660	LSIG	–	–	–
3VA2 molded case circuit breakers for motor/starter protection (IEC 60947-4-1 standards and specifications)				
Rated current I_n at 50 °C ambient temperature	A	–	25 ... 100	160 ... 200
Service life/endurance (operating cycles)				
Mechanical (CLOSE-OPEN cycles)		–	25000	25000
Electrical	380 ... 415 V	–	14000	12000
Trip units				
ETU310M	I	–	■	■
ETU350M	LSI	–	■	■
ETU550M	LSI	–	■	■
ETU860M	LSIG	–	■	■
ETU320	LI	–	–	–
ETU350	LSI	–	–	–
ETU360	LSIG	–	–	–
ETU650	LSIG	–	–	–
ETU660	LSIG	–	–	–

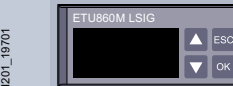

■ Available – Not available/not present



3VA23	3VA24	3VA25	3VA26	3VA27
3/4-pole	3/4-pole	3/4-pole	3/4-pole	3/4-pole
400	630	1000	1250	1600
250 ... 400	400 ... 630	630 ... 1000	1250	800 ... 1600
20000	20000	10000	10000	10000
6000	5000	4600	4600	2000
12000	8000	7000	7000	–
4200	3500	3200	3200	–
■	■	■	■	■
■	■	■	■	–
■	■	■	■	–
■	■	■	■	■
■	■	■	■	–
■	■	■	■	–
–	–	–	–	■
–	–	–	–	■
–	–	–	–	■
250	400 ... 500	630 ... 800	–	800 ... 1600
20000	20000	10000	–	10000
6000	5000 (400 A) 3000 (500 A)	4600	–	2000
■	■	–	–	–
■	■	■	–	–
■	■	■	–	–
■	■	■	–	–
–	–	–	–	■
–	–	–	–	■
–	–	–	–	■
–	–	–	–	■

Trip units

Protection system for 3VA molded case circuit breakers up to 1000 A

Trip units	Thermal-magnetic	Electronic	Electronic with display	Electronic with display and metering function
				
	TM 2-series	ETU 3-series	ETU 5-series	ETU 8-series
Protective function				
Line protection	TM210, TM220, TM240	ETU320, ETU330, ETU340, ETU350	ETU550, ETU560	ETU850, ETU860
Starter protection	TM120M	ETU310M	–	–
Motor protection	–	ETU350M	ETU550M	ETU860M
Integrated functions				
Parameterizing	Setting and reading the parameters <ul style="list-style-type: none"> Current values 	Setting and reading the parameters <ul style="list-style-type: none"> Current values Delay times 	Setting and reading the parameters <ul style="list-style-type: none"> Via display and communication Fine setting of the parameters Reading the measured values 	Setting and reading the parameters <ul style="list-style-type: none"> Via display and communication Fine setting of the parameters Reading the measured values
Status display	–	Indicating the ETU status via LEDs	Indicating the ETU status via LEDs	Indicating the ETU status via LEDs
Interface	–	Interface for test devices	Interface for test devices	Interface for test devices
Metering function	–	–	–	Metering function integrated
Optional expansions				
24 V module	–	–	 24 V module for continuous power supply (also without primary current through the molded case circuit breaker)	 24 V module for continuous power supply (also without primary current through the molded case circuit breaker)
External function box	–	 EFB300 external function box for connection to the ETU	 EFB300 external function box for connection to the ETU	 EFB300 external function box for connection to the ETU
Communications module	–	–	 COM060 communications module	 COM060 communications module
Data concentrator	–	–	 COM800/COM100 data concentrator with interface to <ul style="list-style-type: none"> PROFIBUS PROFINET Modbus RTU Ethernet (Modbus TCP) 	 COM800/COM100 data concentrator with interface to <ul style="list-style-type: none"> PROFIBUS PROFINET Modbus RTU Ethernet (Modbus TCP)
External display	–	–	 DSP800 external display for installing in the cubicle door	 DSP800 external display for installing in the cubicle door
Test device	–	 TD300/TD400/TD500 test device	 TD300/TD400/TD500 test device	 TD300/TD400/TD500 test device

Protective functions of the 3VA1 with thermal-magnetic trip unit

	TM120M AM	TM210 FTFM	TM220 ATFM	TM240 ATAM
Protection				
Starter protection	■	–	–	–
Line protection	–	■	■	■
Version available with				
1-pole and 2-pole breakers	–	■	–	–
3-pole breaker	■	■	■	■
4-pole breaker	–	■	■	■
Available protection parameters				
I_r adjustable	–	–	■	■
I_i adjustable	■	–	–	■
I_r fixed	–	■	–	–
I_i fixed	–	■	■	–
I_N ¹⁾	–	■	■	■

¹⁾ 3VA10 only without N protection
 3VA11, 3VA12, 3VA13, 3VA14 without, 50% or 100% N protection
 50% N protection from $I_{n1} \geq 100$ A

Protective functions of the 3VA2 with electronic trip unit

	ETU310M I	ETU320 LI	ETU330 LIG	ETU340 ELISA®	ETU350 LSI	ETU350M LSI	ETU550 LSI	ETU550M LSI	ETU560 LSIG	ETU850 LSI	ETU860 LSIG	ETU860M LSIG
Protection												
Starter protection	■	–	–	–	–	–	–	–	–	–	–	–
Motor protection	–	–	–	–	–	■	–	■	–	–	–	■
Line protection	–	■	■	■	■	–	–	–	■	■	■	–
Generator protection	–	■	■	–	■	–	■	–	■	■	■	–
Version available with												
3-pole without external neutral conductor transformer	■	■	■	■	■	■	–	■	–	–	–	■
3-pole with external neutral conductor transformer	–	–	–	–	–	–	■	–	■	■	■	–
4-pole with protected neutral conductor transformer	–	■	■	■	■	–	■	–	■	■	■	–
Available protection parameters												
Characteristic in L range	I^2t	I^2t	I^2t	I^4t	I^2t	I^2t	I^2t	I^2t	I^2t	I^2t	I^2t	I^2t
I_r	–	■	■	■	■	■	■	■	■	■	■	■
t_r at $6 \times I_r$	–	■	■	–	■	–	■	–	■	■	■	–
t_c	–	–	–	–	–	■	–	■	–	–	–	■
t_p	–	–	–	–	–	–	–	■	–	–	–	■
Thermal memory	■	■	■	■	■	■	■	■	■	■	■	■
Thermal memory can be switched on/off	–	–	–	–	–	–	■	–	■	–	■	–
I_{sd}	–	–	–	–	■	■	■	■	■	■	■	■
t_{sd} at $8 \times I_r$	–	–	–	–	■	■	■	■	■	■	■	■
Characteristic in S range: I^2t_{sd}	–	–	–	–	■	–	–	–	■	■	■	–
Characteristic in S range: selectable I^2t_{sd}/t_{sd}	–	–	–	–	–	–	–	–	■	–	■	–
I_i	■	■	■	■	■	■	■	■	■	■	■	■
I_N ¹⁾	–	■	■	■	■	–	■	–	■	■	■	–
I_g	–	–	■	–	–	–	–	–	■	–	■	■
t_g at $2 \times I_g$	–	–	■	–	–	–	–	–	■	–	■	■
Characteristic in G range: I^2t_g	–	–	–	–	–	–	–	–	■	–	■	■
Characteristic in G range: selectable I^2t_g/t_g	–	–	–	–	–	–	–	–	■	–	■	■
Ground-fault alarm function	–	–	–	–	–	–	–	–	■	–	■	■
Blocking protection	–	–	–	–	–	–	–	–	–	–	–	■
ZSI in combination with an EFB external function box	–	■	■	■	■	■	■	■	■	■	■	■

¹⁾ Available in a version with external current transformer for N conductor or 4-pole breaker

Available for:

- Circuit breakers with ETU (4-pole)
- Circuit breakers with ETU5/ETU8 3-pole with external neutral conductor transformer or 4-pole

Online configurator highlights

www.siemens.com/lowvoltage/configurators

Search function with global direct input

Searches for specific terms and jumps to the article number based on input to the correct configurator

SIEMENS

Log in Additional actions Support Language

Configurators for Low-voltage

Search for (e.g. 3WL1110-4EB36-6EQ8-Z A05+80...)

1 Select Type of Product 2 Select Category

Product list stores multiple configurations and can transfer them collectively to the shopping cart

List of products

Projectdata Load product list

Actions

No.	Article	Quantity	Unit price:	Documents
1	3WL1106-2EB62-1AA2 Fixed-mounted circuit breaker 3-pole, Size 1, IEC In=630 A to 690 V, 50/60 Hz AC Icu=55 kA at 500 V Rear horizontal connection Overcurrent release ETU 45 LSIN protection adjustable 0.4-1 in with cubicle bus Opt.... Further details	1 Piece	on request	> all documents for position
+ 2	3VA2450-6KP32-0AA0 3VA molded case circuit breaker circuit breaker 3VA2 IEC frame 630 breaking capacity class H Icu=85kA @ 415V 3-pole, line protection ETU850, LSI, In=500A overload protection Ir=200A...500A short-circuit protection Ird=0.6..10x In,... Further details	1 Piece	on request	> all documents for position

Recall of completed configurations for modification or additional configuration

List of products

Projectdata Load product list

Actions

No.	Article	Quantity	Unit price:	Documents
1	3WL1106-2EB62-1AA2 Fixed-mounted circuit breaker 3-pole, Size 1, IEC In=630 A to 690 V, 50/60 Hz AC Icu=55 kA at 500 V Rear horizontal connection Overcurrent release ETU 45 LSIN protection adjustable 0.4-1 in with cubicle bus Opt.... Further details	1 Piece	on request	> all documents for position
+ 2	3VA2450-6KP32-0AA0 3VA molded case circuit breaker circuit breaker 3VA2 IEC frame 630 breaking capacity class H Icu=85kA @ 415V 3-pole, line protection ETU850, LSI, In=500A overload protection Ir=200A...500A short-circuit protection Ird=0.6..10x In,... Further details	1 Piece	on request	> all documents for position

Duplicate Configure

Responsive Design

SIEMENS

Log in Additional actions Support Language

Configurators for Low-voltage

Search for (e.g. 3WL1110-4EB36-6EQ8-Z A05+80...)

1 Select Type of Product 2 Select Category

MCCB - molded case circuit breaker ACB - air circuit breaker Additional products

www.siemens.com/lowvoltage/3va-configurator and
www.siemens.com/lowvoltage/3va27-configurator

Visualization of the internally mountable accessories (slot assignment)

The configuration is complete. You can order this product.

Basic configuration | Trip units | Type of mounting | Connection technology | Auxiliary release/auxiliary switch | Mountable accessories | Result | CAD/CAE

2019_08.02


Assembly option

Field Assembly

Auxiliary release

- Shunt trip left (STL)
 - 110-127 V AC 50/60 Hz / DC
- Shunt trip left (STL ED)
 - None
- Undervoltage release (LVR)
 - None
- Universal release (LUN)
 - None

Slot assignment



Auxiliary switch/alarm switch (changeover contacts - Form C)

Auxiliary switch type HP

- AUX auxiliary switch
- LCS leading auxiliary switch

Auxiliary switch type HQ

- AUX auxiliary switch
- AUX auxiliary switch, suitable for electronic circuits
- LCS leading auxiliary switch
- LCS leading auxiliary switch, suitable for electronic circuits

Alarm switch type HP

- EAS alarm switch

Alarm switch type HQ

- EAS alarm switch
- EAS alarm switch, suitable for electronic circuits
- EAS electrical alarm switch
- EAS electrical alarm switch, suitable for electronic circuits

Download of the individual edz files for 3VA

The configuration is complete. You can order this product.

Basic configuration | Trip units | Type of mounting | Connection technology | Auxiliary release/auxiliary switch | Mountable accessories | Result | CAD/CAE


2019_08.02

Selection

- Assembly drawing
- 3VA molded-case circuit breaker

Preview

3D view | Unit Wiring Diagram IEC | Dimension drawing | Area Model View | Wire frame view



Download - all CAD formats

- View: Area Model view
- View option: Isometric
- File type: Bitmap (*.bmp)
- Start generation

Download - all documents

- open documents dialog

Documentation and reporting

Choose languages for the data sheet: deutsch

Project data for the datasheet

Download selection of document types

- Datasheets (PDF)
- EPLAN Macro (EDZ)

Selection of download format

All in a ZIP file

Start generation

Component documentation

- 3VA molded case circuit breaker (3VA250-7M32-0A0)
- Datasheet (PDF)
- EPLAN Macro (EDZ)

© Siemens AG | Application information

Automatic generation of the 3D model, the 2D dimension drawing and the internal circuit diagram according to IEC

Die Konfiguration ist vollständig, das Bestellen ist jetzt möglich.

Grundkonfiguration | Auslöser | Einbauart | Hauptleiteranschluss | Hilfsleiter/sens-schalter | Anbaubares Zubehör | Ergebnis | CAD/CAE


2019_04.07

Auswahl

- Assembly drawing
- 3VA Kompaktleistungsschalter
- Kommunikation
- Hauptleiteranschluss
- Hauptleiteranschlusszubehör
- Hauptleiteranschlusszubehör
- Aufbauart
- Hilfsleiter/sens-schalter
- Anbaubares Zubehör

Vorschau

Drainingsansicht | Geräteschaltplan IEC | Maßblatt | 3D Ansicht | Flächenansicht



Download - alle CAD-Formate

- Ansicht: Flächenansicht
- Ansichtoption: Dimetrisch
- Dateityp: Bitmap (*.bmp)
- Generierung starten

Download - alle Dokumente

- Dokumenten Dialog öffnen

System overview

For a complete and valid configuration of your molded case circuit breaker, please use our online configurator at www.siemens.com/lowvoltage/3va-configurator

Molded case circuit breakers and switch disconnectors



3VA1 for standard applications

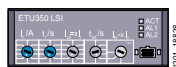


3VA2 for selective applications

Trip units



Thermal-magnetic trip unit (TMTU)



Electronic trip unit (ETU)



Electronic trip unit (ETU) with display, and optionally with metering function

Trip unit accessories



24 V module



Communications module



Data concentrator



External display



Test device

Type of mounting



Fixed-mounted



Withdrawable unit, complete kit



Plug-in unit, complete kit

Supplementary accessories



Auxiliary circuit connector



Door feedthrough



Position signaling switch



Cylinder lock adapter



Crank

Main conductor connection



Bus connectors



Bus connectors broadened



Circular conductor terminals



Box terminals



Nut keeper kits, right-angled

Connection accessories

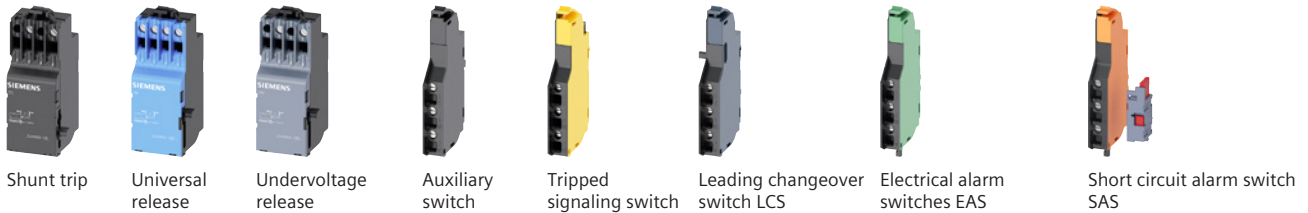


Insulation accessories

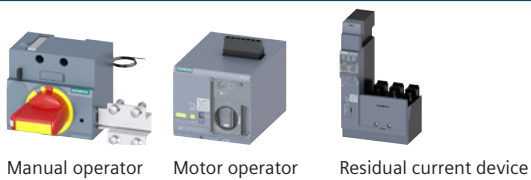
Note:

You will find a detailed range of accessories in the Accessories and spare parts section.

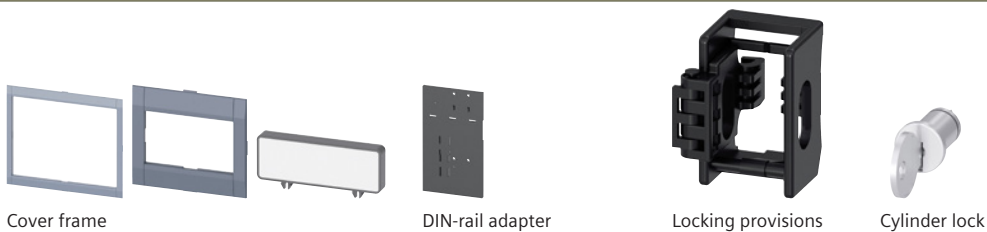
Auxiliary releases/auxiliary switches



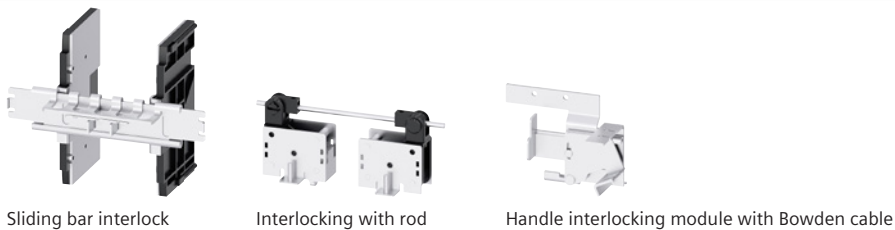
Mountable accessories



Additional circuit breaker accessories



Mechanical interlocking mechanisms

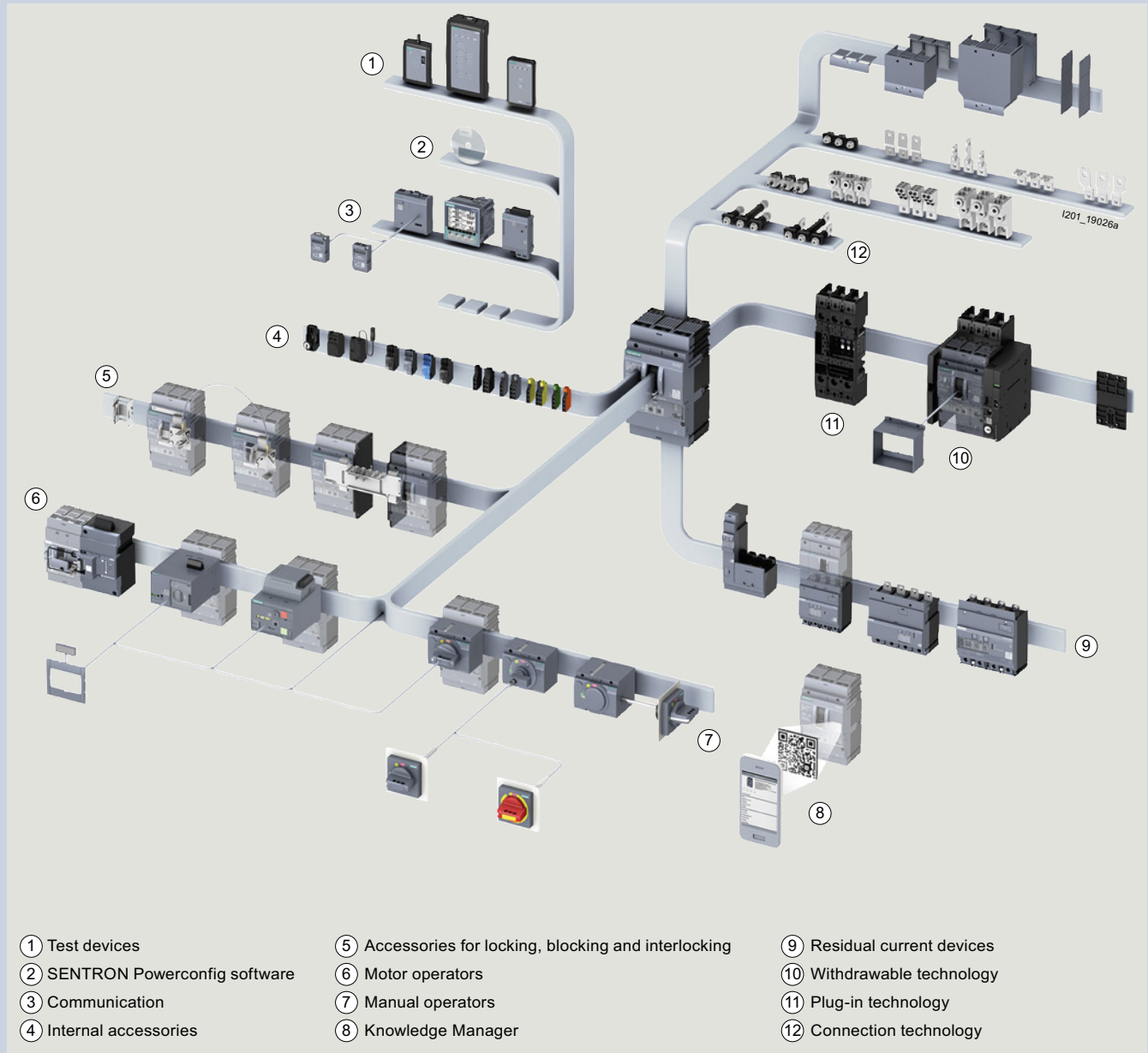


Note:

You will find a detailed range of accessories in the Accessories and spare parts section.

System overview

2



Structure of the article numbers

Basic configuration for line and generator protection

The structure shown below is intended as an overview of each position and its meaning. For a complete and valid configuration of your molded case circuit breaker, please use our online configurator at www.siemens.com/lowvoltage/3va-configurator

2

		3VA										4	5	6	7	8	9	10	11	12	- 0AA0			
Trip units		Thermal-magnetic										1	Electronic											
		3VA10	3VA11	3VA12	3VA13	3VA14	3VA15	3VA20	3VA21	3VA22	3VA23	3VA24	3VA25	3VA26										
Size (SZ)	100 A	■	-	-	-	-	-	■	-	-	-	-	-	-	0									
	160 A	-	■	-	-	-	-	-	■	-	-	-	-	-	1									
	250 A	-	-	■	-	-	-	-	-	■	-	-	-	-	2									
	400 A	-	-	-	■	-	-	-	-	-	■	-	-	-	3									
	630 A	-	-	-	-	■	-	-	-	-	-	■	-	-	4									
	1000 A	-	-	-	-	-	■	-	-	-	-	-	■	-	5									
	1250 A	-	-	-	-	-	-	-	-	-	-	-	-	■	6									
Max. rated current $I_{n \max}$	Line protection	16 A	■	■	-	-	-	-	-	-	-	-	-	-	9	6								
		20 A	■	■	-	-	-	-	-	-	-	-	-	-	-	2	0							
		25 A	■	■	-	-	-	-	■	■	-	-	-	-	-	2	5							
		32 A	■	■	-	-	-	-	-	-	-	-	-	-	-	3	2							
		40 A	■	■	-	-	-	-	■	■	-	-	-	-	-	4	0							
		50 A	■	■	-	-	-	-	-	-	-	-	-	-	-	5	0							
		63 A	■	■	-	-	-	-	■	■	-	-	-	-	-	6	3							
		80 A	■	■	-	-	-	-	-	-	-	-	-	-	-	8	0							
		100 A	■	■	-	-	-	-	■	■	-	-	-	-	-	1	0							
		125 A	-	■	-	-	-	-	-	-	-	-	-	-	-	1	2							
		160 A	-	■	■	-	-	-	-	■ ¹⁾	■	-	-	-	-	1	6							
		200 A	-	-	■	-	-	-	-	-	-	-	-	-	-	2	0							
		250 A	-	-	■	-	-	-	-	-	■ ¹⁾	■	-	-	-	2	5							
		320 A	-	-	-	■	-	-	-	-	-	-	-	-	-	3	2							
		400 A	-	-	-	■	-	-	-	-	-	■ ¹⁾	■	-	-	4	0							
	500 A	-	-	-	-	■	-	-	-	-	-	■ ²⁾	-	-	5	0								
	630 A	-	-	-	-	■	■	-	-	-	-	■	■	-	6	3								
	800 A	-	-	-	-	-	■	-	-	-	-	-	■	-	8	0								
	1000 A	-	-	-	-	-	■	-	-	-	-	-	■	-	1	0								
	1250 A	-	-	-	-	-	-	-	-	-	-	-	-	■	1	2								
	Generator protection	25 A	-	-	-	-	-	-	■	■	-	-	-	-	2	5								
		40 A	-	-	-	-	-	-	■	■	-	-	-	-	4	0								
		63 A	-	-	-	-	-	-	■	■	-	-	-	-	6	3								
		100 A	-	-	-	-	-	-	■	■	-	-	-	-	1	0								
		160 A	-	-	-	-	-	-	-	■	■	-	-	-	1	6								
		250 A	-	-	-	-	-	-	-	-	■	■	-	-	2	5								
		400 A	-	-	-	-	-	-	-	-	-	■	■ ²⁾	-	4	0								
		500 A	-	-	-	-	-	-	-	-	-	-	■ ²⁾	-	5	0								
		630 A	-	-	-	-	-	-	-	-	-	-	■	■	6	3								
		800 A	-	-	-	-	-	-	-	-	-	-	-	■	8	0								
		1000 A	-	-	-	-	-	-	-	-	-	-	-	■	1	0								
		1250 A	-	-	-	-	-	-	-	-	-	-	-	-	1	2								
		Switch disconnecter	63 A	-	■	-	-	-	-	-	-	-	-	-	-	6	3							
100 A			-	■	-	-	-	-	-	-	-	-	-	-	1	0								
125 A			-	■	-	-	-	-	-	-	-	-	-	-	1	2								
160 A	-		■	-	-	-	-	-	-	-	-	-	-	1	6									
250 A	-		-	■	-	-	-	-	-	-	-	-	-	2	5									
400 A	-		-	-	■	-	-	-	-	-	-	-	-	4	0									
500 A	-		-	-	-	■	-	-	-	-	-	-	-	5	0									
630 A	-	-	-	-	■	-	-	-	-	-	-	-	6	3										

¹⁾ Rated current not available with ETU340 ELISA LI
²⁾ With ETU 5-series and 8-series, utilization category B and ETU340 ELISA LI only

		3VA												- 0AA0					
		4	5	6	7	8	9	10	11	12									
		3VA10	3VA11	3VA12	3VA13	3VA14	3VA15	3VA20	3VA21	3VA22	3VA23	3VA24	3VA25	3VA26					
Short-circuit breaking capacity $I_{cu} = I_{cs}$ at 415 V	Without overload protection	-	■	-	■	-	■	-	-	-	-	-	-	-	1				
	Without short-circuit protection	-	■	■	■	■	-	-	-	-	-	-	-	-	1				
	16 kA	■	-	-	-	-	-	-	-	-	-	-	-	-	2				
	25 kA	■	■	-	-	-	-	-	-	-	-	-	-	-	3				
	36 kA	■	■	■	■	■	-	-	-	-	-	-	-	-	4				
	55 kA	-	■	■	■	■	■	-	-	-	-	-	-	-	5				
	70 kA	-	■	■	■	■	■	-	-	-	-	-	-	-	6				
	85 kA	-	■	■	■	■	■	-	-	-	-	-	-	-	6				
	110 kA	-	-	-	■	■	■	■	■	■	■	■	■	■	7				
	150 kA	-	-	-	-	-	-	■	■	■	■	■	■	■	8				
200 kA ¹⁾	-	-	-	-	-	-	-	■	■	■	■	■	■	0					
¹⁾ Available for 3 and 8-series ETUs																			
Protective function thermal-magnetic	No protection	-	■	■	■	■	-	-	-	-	-	-	-	-	SD100	-	A		
	Line protection	■	■	-	-	-	-	-	-	-	-	-	-	-	TM210	FTFM	D		
		-	■	■	■	■	■	-	-	-	-	-	-	-	TM220	ATFM	E		
		-	■	■	■	■	■	-	-	-	-	-	-	-	TM240	ATAM	F		
Protective function thermal-magnetic, neutral conductor protection	No protection															A			
	Line protection	Without neutral conductor protection														E			
		50% neutral conductor protection														F			
		100% neutral conductor protection														G			
Protective function electronic	Line protection	-	-	-	-	-	-	■	■	■	■	■	■	■	ETU320	LI	(N) ²⁾	H	L
		-	-	-	-	-	-	-	■	■	■	■	■	■	ETU330	LIG	(N) ²⁾	H	M
		-	-	-	-	-	-	-	■	■	■	■	■	■	ETU340	ELISA LI	(N) ²⁾	H	K
	Line and generator protection	-	-	-	-	-	-	-	■	■	■	■	■	■	ETU350	LSI	(N) ²⁾	H	N
		-	-	-	-	-	-	-	■	■	■	■	■	■	ETU550	LSI	(N) ³⁾	J	P
	Line and generator protection, with display	-	-	-	-	-	-	-	■	■	■	■	■	-	ETU560	LSIG	(N) ³⁾	J	Q
		-	-	-	-	-	-	-	■	■	■	■	■	-	ETU850	LSI	(N) ³⁾	K	P
	Line and generator protection, with display, with metering function	-	-	-	-	-	-	-	■	■	■	■	■	■	ETU860	LSIG	(N) ³⁾	K	Q
²⁾ Neutral conductor protection for 4-pole breakers																			
³⁾ Neutral conductor protection for 3-pole breakers with an external neutral conductor transformer or for 4-pole breakers																			
Number of poles	1-pole	Line protection	-	■ ⁴⁾	-	-	-	-	-	-	-	-	-	-				1	
		Generator protection	-	-	-	-	-	-	-	-	-	-	-	-				2	
	3-pole	Line protection	■	■	■	■	■	■	■	■	■	■	■	■				3	
		Generator protection	-	-	-	-	-	-	■	■	■	■	■	■				3	
	4-pole	Line protection	■	■	■	■	■	■	■	■	■	■	■	■				4	
		Generator protection	-	-	-	-	-	-	■	■	■	■	■	■				4	
⁴⁾ For TM210 only																			
Connection technology	Nut keeper kit	Line protection	■	■	■	■	■	■	■	■	■	■	■				2		
		Generator protection	-	-	-	-	-	-	■	■	■	■	■				2		
	Box terminal	Line protection	■	■	-	-	-	-	■	■	-	-	-	-			6		
		Generator protection	-	-	-	-	-	-	■	■	-	-	-	-			6		

Structure of the article numbers

Basic configuration for starter and motor protection

The structure shown below is intended as an overview of each position and its meaning. For a complete and valid configuration of your molded case circuit breaker, please use our online configurator at www.siemens.com/lowvoltage/3va-configurator

2

		3VA										4	5	6	7	8	9	10	11	12	-	0AA0	
Trip units	Thermal-magnetic											1											
	Electronic											2											
Size (SZ)	160 A	■	-	-	-	-	-	-	-	-	-	1											
	250 A	-	■	-	-	-	-	-	-	-	-	2											
	400 A	-	-	■	-	-	-	-	-	-	-	3											
	630 A	-	-	-	■	-	-	-	-	-	-	4											
	1000 A	-	-	-	-	■	-	-	-	-	-	5											
Max. rated current $I_{n\ max}$	Starter protection	1 A	■	-	-	-	-	-	-	-	-	-	8	1									
		2 A	■	-	-	-	-	-	-	-	-	-	0	2									
		4 A	■	-	-	-	-	-	-	-	-	-	0	4									
		8 A	■	-	-	-	-	-	-	-	-	-	0	8									
		12.5 A	■	-	-	-	-	-	-	-	-	-	9	2									
		20 A	■	-	-	-	-	-	-	-	-	-	2	0									
		25 A	-	-	-	-	-	■	-	-	-	-	2	5									
		32 A	■	-	-	-	-	-	-	-	-	-	3	2									
		40 A	■	-	-	-	-	■	-	-	-	-	4	0									
		50 A	■	-	-	-	-	-	-	-	-	-	5	0									
		63 A	■	-	-	-	-	■	-	-	-	-	6	3									
		80 A	■	-	-	-	-	-	-	-	-	-	8	0									
		100 A	■	-	-	-	-	■	-	-	-	-	1	0									
		125 A	■	-	-	-	-	-	-	-	-	-	1	2									
		160 A	-	■	-	-	-	-	■	-	-	-	1	6									
		200 A	-	■	-	-	-	-	■	-	-	-	2	0									
	250 A	-	-	■	-	-	-	-	■	-	-	2	5										
	320 A	-	-	■	-	-	-	-	-	-	-	3	2										
	400 A	-	-	-	■	-	-	-	-	■	-	4	0										
	500 A	-	-	-	■	-	-	-	-	■	-	5	0										
	630 A	-	-	-	-	■	-	-	-	-	■	6	3										
	800 A	-	-	-	-	-	■	-	-	-	-	8	0										
	Motor protection	25 A	-	-	-	-	-	■	-	-	-	2	5										
		40 A	-	-	-	-	-	■	-	-	-	4	0										
		63 A	-	-	-	-	-	■	-	-	-	6	3										
		100 A	-	-	-	-	-	■	-	-	-	1	0										
		160 A	-	-	-	-	-	-	■	-	-	1	6										
		200 A	-	-	-	-	-	-	■	-	-	2	0										
		250 A	-	-	-	-	-	-	-	■	-	2	5										
		400 A	-	-	-	-	-	-	-	-	■	-	4	0									
		500 A	-	-	-	-	-	-	-	-	■	-	5	0									
		630 A	-	-	-	-	-	-	-	-	-	■	6	3									
800 A	-	-	-	-	-	-	-	-	-	■	8	0											
Short-circuit breaking capacity $I_{cu} = I_{cs}$ at 415 V	55 kA	■	■	■	■	■	■	■	■	■			5										
	70 kA	■	■	■	■	■	-	-	-	-			6										
	110 kA	-	-	■	■	■	■	■	■	■	■		7										
	200 kA	-	-	-	-	-	■	■	■	■	■		0										

		3VA										- 0AA0					
		4	5	6	7	8	9	10	11	12							
		3VA11	3VA12	3VA13	3VA14	3VA15	3VA21	3VA22	3VA23	3VA24	3VA25						
Protective function thermal-magnetic	Starter protection	■	-	-	-	-	-	-	-	-	-	TM110M	FM	M	G		
		■	■	■	■	■	-	-	-	-	-	TM120M	AM	M	H		
Protective function electronic	Motor protection	-	-	-	-	-	■	■	■	■	■	ETU350M	LSI	M	N		
	Motor protection, with display	-	-	-	-	-	■	■	■	■	■	ETU550M	LSI	M	P		
	Motor protection, with display, with metering function	-	-	-	-	-	■	■	■	■	■	ETU860M	LSIG	M	Q		
	Starter protection	-	-	-	-	-	■	■	■	■	-	ETU310M	I	M	S		
Number of poles	3-pole																
	Starter protection	■	■	■	■	■	■	■	■	■	-					3	
	Motor protection	-	-	-	-	-	■	■	■	■	■					3	
Connection technology	Nut keeper kit	Starter protection	■	■	■	■	■	■	■	■	-					2	
		Motor protection	-	-	-	-	-	■	■	■	■	■					2
	Box terminals	Starter protection	■	-	-	-	-	■	-	-	-	-					6
		Motor protection	-	-	-	-	-	■	-	-	-	-					6

2

Internal accessories

Auxiliary switches and alarm switches

For a complete and valid configuration of your molded case circuit breaker, please use our online configurator at www.siemens.com/lowvoltage/3va-configurator

2

3VA20
3VA21
3VA22
3VA23
3VA24
3VA25
3VA26

3VA10

3VA11

3VA12

3VA13

3VA14

3VA15

Auxiliary switches AUX

- Used to signal the position of the main contacts of the molded case circuit breaker
- The contacts of the auxiliary switch and the molded case circuit breaker close in unison



Type	Width	I_e max (IEC 60947-5-1)	U_e AC/DC (IEC 60947-5-1)	Version					
HQ	7 mm (1 slot)	6 A	240 V/250 V	Standard					3VA9988-0AA12
		< 1 A	24 V/24 V	Electronic-compatible					3VA9988-0AA13
HP	14 mm (2 slots)	10 A	600 V/250 V	Standard	–				3VA9988-0AA11

Leading changeover switches LCS

- Used for load shedding, for example
- Signal the opening of the main contacts with a lead time of 20 ms in advance of molded case circuit breaker trips



Type	Width	I_e max (IEC 60947-5-1)	U_e AC/DC (IEC 60947-5-1)	Version					
HQ	7 mm (1 slot)	6 A	240 V/250 V	Standard	–				3VA9988-0AA22
		< 1 A	24 V/24 V	Electronic-compatible	–				3VA9988-0AA23
HP	14 mm (2 slots)	10 A	600 V/250 V	Standard	–				3VA9988-0AA21

Trip alarm switches TAS

- Signal every circuit breaker tripping operation
- Are actuated whenever the molded case circuit breaker switches to the TRIP position



Type	Width	I_e max (IEC 60947-5-1)	U_e AC/DC (IEC 60947-5-1)	Version					
HQ	7 mm (1 slot)	6 A	240 V/250 V	Standard					3VA9988-0AB12
		< 1 A	24 V/24 V	Electronic-compatible					3VA9988-0AB13
HP	14 mm (2 slots)	10 A	600 V/250 V	Standard	–				3VA9988-0AB11

Short circuit alarm switches SAS

- Signal tripping operations only if they have been initiated by a short circuit
- The tripping operation must be reset by deliberate acknowledgement of the fault before the molded case circuit breaker can be switched to ON again



Type	Width	I_e max (IEC 60947-5-1)	U_e AC/DC (IEC 60947-5-1)	Version					
HQ	7 mm (1 slot)	6 A	240 V/250 V	Standard	–	3VA9988-0AB32	3VA9988-0AB34	–	–
		< 1 A	24 V/24 V	Electronic-compatible	–	3VA9988-0AB33	3VA9988-0AB35	–	–

Electrical alarm switches EAS

- Are actuated as soon as the main contacts of the molded case circuit breaker open in the event that the breaker is tripped by the ETU








Type	Width	I_e max (IEC 60947-5-1)	U_e AC/DC (IEC 60947-5-1)	Version					
HQ	7 mm (1 slot)	6 A	240 V/250 V	Standard	–	–	–	–	3VA9988-0AB22
		< 1 A	24 V/24 V	Electronic-compatible	–	–	–	–	3VA9988-0AB23





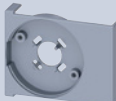
Auxiliary releases

For a complete and valid configuration of your molded case circuit breaker, please use our online configurator at www.siemens.com/lowvoltage/3va-configurator

2

			3VA10	3VA11	3VA12	3VA13	3VA14	3VA15	3VA20	3VA21	3VA22	3VA23	3VA24	3VA25	3VA26		
Shunt trips left STL																	
	<ul style="list-style-type: none"> Used for remote-controlled tripping of the molded case circuit breaker Have particularly low power consumption Especially suitable for electrical interlocking in the EI variant¹⁾ 																
	Version	U_e 50/60 Hz AC	U_e DC														
	Standard	–	12 V		3VA9988-OBL10												
		24 V	24 ... 30 V		3VA9988-OBL30												
		48 ... 60 V	48 ... 60 V		3VA9988-OBL31												
		110 ... 127 V	110 ... 127 V		3VA9988-OBL32												
		208 ... 277 V	220 ... 250 V		3VA9988-OBL33												
		380 ... 600 V	–		3VA9988-OBL20												
	Electrical (EI)	–	24 V		3VA9988-OBM10												
Shunt trips flexible STF																	
	<ul style="list-style-type: none"> Used for remote-controlled tripping of the molded case circuit breaker Flexible installation 																
	U_e 50/60 Hz AC	U_e DC															
	24 V	–	–	–	–	–	–	–	–	–	–	–	–	–	–	3VA9988-OBA20	–
	48 ... 60 V	–	–	–	–	–	–	–	–	–	–	–	–	–	–	3VA9988-OBA21	–
	110 ... 127 V	–	–	–	–	–	–	–	–	–	–	–	–	–	–	3VA9988-OBA22	–
	208 ... 277 V	–	–	–	–	–	–	–	–	–	–	–	–	–	–	3VA9988-OBA23	–
	380 ... 500 V	–	–	–	–	–	–	–	–	–	–	–	–	–	–	3VA9988-OBA24	–
	600 V	–	–	–	–	–	–	–	–	–	–	–	–	–	–	3VA9988-OBA25	–
Universal releases UNI																	
	<ul style="list-style-type: none"> Combination of shunt trip and undervoltage release 																
	U_e 50/60 Hz AC	U_e DC															
	–	–	12 V	3VA9908-0BD11													
		–	24 V	3VA9908-0BD12													
		–	48 V	3VA9908-0BD13													
Undervoltage releases UVR																	
	<ul style="list-style-type: none"> Trip the molded case circuit breaker in the event that the rated operational voltage of a monitored circuit drops below a minimum permissible limit or fails altogether 																
	U_e 50/60 Hz AC	U_e DC															
	–	–	12 V	3VA9908-0BB10													
		–	24 V	3VA9908-0BB11													
		–	48 V	3VA9908-0BB12													
		–	60 V	3VA9908-0BB13													
		–	125 ... 127 V	3VA9908-0BB14													
		–	220 ... 230 V	3VA9908-0BB15													
		–	250 V	3VA9908-0BB16													
	24 V	–	–	3VA9908-0BB20													
	48 V	–	–	3VA9908-0BB21													
	60 V	–	–	3VA9908-0BB22													
	110 V	–	–	3VA9908-0BB23													
	120 ... 127 V	–	–	3VA9908-0BB24													
	208 ... 230 V	–	–	3VA9908-0BB25													
	380 ... 400 V	–	–	3VA9908-0BB26													
	440 ... 480 V	–	–	3VA9908-0BB27													
Time-delay devices for undervoltage releases																	
	U_e 50/60 Hz AC	U_e DC															
	110 V	–	110 V	3VA9988-0BF21													
	230 V	–	230 V	3VA9988-0BF22													
	–	–	24 V	3VA9988-0BF23													





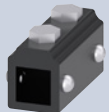



¹⁾ In combination with TAS and AUX. For circuit diagrams, see the operating instructions

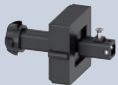

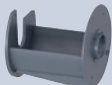

			3VA10 3VA11	3VA12	3VA20 3VA21 3VA22	3VA13 3VA14 3VA23 3VA24	3VA15 3VA25 3VA26
Side wall mounted rotary operators							
	<ul style="list-style-type: none"> Rotary operator with shaft 300 mm Handle with masking plate 75 × 75 mm Degree of protection IP65 For 3-pole and 4-pole breakers 						
Version	Mounting bracket	Illumination kit					
Standard (gray)	Without	Without	3VA9157-0PK11	3VA9257-0PK11	3VA9267-0PK11	3VA9467-0PK11	–
		With	3VA9157-0PK13	3VA9257-0PK13	3VA9267-0PK13	3VA9467-0PK13	–
EMERGENCY-OFF (red/yellow)	Without	Without	3VA9157-0PK15	3VA9257-0PK15	3VA9267-0PK15	3VA9467-0PK15	–
		With	3VA9157-0PK17	3VA9257-0PK17	3VA9267-0PK17	3VA9467-0PK17	–
Side wall mounted rotary operators with mounting bracket							
	<ul style="list-style-type: none"> Rotary operator with short shaft and mounting bracket for mounting directly on the side wall Handle with masking plate 75 × 75 mm Degree of protection IP65 For 3-pole and 4-pole breakers 						
Version	Mounting bracket	Illumination kit					
Standard (gray)	With	Without	3VA9157-0PK51	3VA9257-0PK51	3VA9267-0PK51	–	–
		With	3VA9157-0PK53	3VA9257-0PK53	3VA9267-0PK53	–	–
EMERGENCY-OFF (red/yellow)	With	Without	3VA9157-0PK55	3VA9257-0PK55	3VA9267-0PK55	–	–
		With	3VA9157-0PK57	3VA9257-0PK57	3VA9267-0PK57	–	–
Extended DIN rail for N/PE terminals							
	Version	Rated current					
	For mounting bracket	≤ 250 A	3VA9987-0GL30	3VA9987-0GL30	3VA9987-0GL30	–	–
Auxiliary switch modules for rotary operator							
	Version						
	2× leading to "ON"		3VA9257-0GX10	3VA9257-0GX10	3VA9467-0GX10	3VA9467-0GX10	–
	2× leading to "ON" and 1× leading to "OFF"		–	–	3VA9467-0GX20	3VA9467-0GX20	–
Mounting adapters for side wall mounted rotary operators							
	Version						
	Necessary accessories for 3VA side wall mounted rotary operators, if 3VA9...-0GX.0 auxiliary switch modules are used		3VA9257-0GX01	3VA9257-0GX01	3VA9467-0GX01	–	–

Manual operators

For a complete and valid configuration of your molded case circuit breaker, please use our online configurator at www.siemens.com/lowvoltage/3va-configurator

2

	3VA10 3VA11	3VA12	3VA20 3VA21 3VA22	3VA13 3VA14 3VA23 3VA24	3VA15 3VA25 3VA26
Supplementary handles for door mounted rotary operators					
	<ul style="list-style-type: none"> For operation when control cabinet door is open 				
Version					
Standard (gray)	3VA9287-0GC01	3VA9287-0GC01	3VA9487-0GC01	3VA9487-0GC11	3VA9687-0GC01
EMERGENCY-OFF (red/yellow)	3VA9287-0GC05	3VA9287-0GC05	3VA9487-0GC05	3VA9487-0GC15	3VA9687-0GC05
Handles					
	<ul style="list-style-type: none"> With masking plate 				
Version					
Tolerance compensation					
Standard (gray)	With		8UD1721-0AB21	8UD1731-0AB21	8UD1741-0AB21
	Without		8UD1721-0AB11	8UD1731-0AB11	8UD1741-0AB11
EMERGENCY-OFF (red/yellow)	With		8UD1721-0AB25	8UD1731-0AB25	8UD1741-0AB25
	Without		8UD1721-0AB15	8UD1731-0AB15	8UD1741-0AB15
Handle lever extensions					
	<ul style="list-style-type: none"> Note: The handle lever extension is already included in the scope of supply of the breakers. 				
				3VA9487-0SC10	3VA9987-0SC10
Shafts					
	Type	Length			
	8 × 8 mm	300 mm	8UD1900-2WA00		–
		600 mm	8UD1900-2WB00		–
	12 × 12 mm	300 mm	–	–	8UD1900-4WA00
		600 mm	–	–	8UD1900-4WB00
Adapters for shafts					
	Type	Use			
	8 × 8 mm	With door mounted rotary operator and side wall mounted rotary operator	8UD1900-2DA00		–
	12 × 12 mm	For door mounted rotary operator	–	–	8UD1900-4DA00
Door couplings					
	Type				
	8 × 8 mm		8UD1900-2HA00		–
	12 × 12 mm		–	–	8UD1900-4HA00

		3VA10 3VA11	3VA12	3VA20 3VA21 3VA22	3VA13 3VA14 3VA23 3VA24	3VA15 3VA25 3VA26	
Mounting tolerance compensations							
	Type	8UD1900-2GA00					–
	8 × 8 mm						
	Type	–	–	–	–	8UD1900-4GA00	
	12 × 12 mm						
Fixing brackets for shafts							
	Type	3VA9287-0GA80		3VA9487-0GA80		3VA9687-0GA80	
	Size						
Variable depth adapters							
	Type	3VA9487-0GB10					–
	8 × 8 mm						

Manual operators

For a complete and valid configuration of your molded case circuit breaker, please use our online configurator at www.siemens.com/lowvoltage/3va-configurator

2

					3VA20	
					3VA21	
					3VA22	
	3VA10	3VA13			3VA23	3VA25
	3VA11	3VA14			3VA24	3VA26
	3VA12		3VA15			

Labeling plates for manual operators



3VA9087-05X10

Illumination kits for manual operators



- 24 V DC voltage

Version	Rated current					
Front mounted rotary operator	100 ... 250 A	8UD1900-0KA10	–	–	–	–
	100 ... 630 A	–	8UD1900-0KA20	–	8UD1900-0KA20	–
	630 ... 1000 A	–	–	8UD1900-0KA30	–	8UD1900-0KA30
Door mounted rotary operator and side wall mounted rotary operator	100 ... 630 A	8UD1900-0KA20	8UD1900-0KA20	8UD1900-0KA20	8UD1900-0KA20	–
	630 ... 1000 A	–	–	–	–	8UD1900-0KA30

Cylinder locks (type Kaba), standard masking plates



Use	Key					
For door mounted rotary operator and side wall mounted rotary operator (in the masking plate), only for locking, not for interlocking	1	8UD1900-0MB01	8UD1900-0MB01	–	8UD1900-0MB01	–
	2	8UD1900-0NB01	8UD1900-0NB01	–	8UD1900-0NB01	–
	3	8UD1900-0PB01	8UD1900-0PB01	–	8UD1900-0PB01	–
	4	8UD1900-0QB01	8UD1900-0QB01	–	8UD1900-0QB01	–

Cylinder locks (type Kaba), EMERGENCY-OFF masking plates



Use	Key					
For door mounted rotary operator and side wall mounted rotary operator (in the masking plate), only for locking, not for interlocking	1	8UD1900-0MB05	8UD1900-0MB05	–	8UD1900-0MB05	–
	2	8UD1900-0NB05	8UD1900-0NB05	–	8UD1900-0NB05	–
	3	8UD1900-0PB05	8UD1900-0PB05	–	8UD1900-0PB05	–
	4	8UD1900-0QB05	8UD1900-0QB05	–	8UD1900-0QB05	–

Cylinder locks (type RONIS)



- Includes a lock with 2 keys
- For locking or interlocking
- For installation on the circuit breaker side in all rotary operators
- For mounting in the adapter kit for the accessories compartment
- **Note:** The cylinder lock adapter for rotary operators is also needed for locking or interlocking circuit breakers via rotary operators

Key					
1				3VA9980-0VL10	
3				3VA9980-0VL30	
4				3VA9980-0VL40	

Cylinder lock adapters for rotary operators



- To mount the cylinder lock in the rotary operator (also possible with door mounted rotary operator and side wall mounted rotary operator), on circuit breaker side, NOT in masking plate

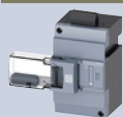
Rated current					
100 ... 630 A	3VA9980-0LF20	3VA9980-0LF20	–	3VA9980-0LF20	–
1000 A	–	–	3VA9680-0LF20	–	3VA9680-0LF20

Motor operators

For a complete and valid configuration of your molded case circuit breaker, please use our online configurator at www.siemens.com/lowvoltage/3va-configurator

2

Side mounted motor operators without stored energy mechanisms (MO310)



Addressable via control signals	Isolating features in accordance with IEC/EN 60947-1	Make time, typically		Break time, typically		Rated operational power
		For 3VA1	For 3VA2	For 3VA1	For 3VA2	
■	■	< 300 ms	–	< 300 ms	–	250 W, max. 500 W (60 ms)

Motor operators without stored energy mechanisms (MO320)



Addressable via control signals	Isolating features in accordance with IEC/EN 60947-1	Make time, typically		Break time, typically		Rated operational power
		For 3VA1	For 3VA2	For 3VA1	For 3VA2	
■	■	< 800 ms (160 A, 250A)	< 1000 ms (250 A), < 1700 ms (630 A)	< 800 ms (160 A, 250A)	< 1000 ms (250 A), < 1400 ms (630 A)	250 W, max. 500 W (60 ms)

Spare parts kit for MO320

Scope of supply
Mounting plate, plug

Motor operators with stored energy mechanisms (SEO520)



- Synchronizable motor operator with optional communications interface
- Up to 3VA22 (250 A), it has two spring assemblies that are used to switch the 3VA2 molded case circuit breaker on and off quickly. This new principle in the MCCB area ensures fast, reliable and easily controllable switching sequences, especially in load transfer switching applications.
- The connection with the COM060 communications module, via a plug-in connection, integrates the SEO520 into the communication environment of the 3VA molded case circuit breakers and ensures that the molded case circuit breaker can also be switched via the supported communication networks and the SENTRON Powerconfig and SENTRON Powermanager software packages.
- **Note:** On account of the fast switching times, the SEO520 cannot be used with a leading changeover switch LCS.

Addressable via control signals	Isolating features in accordance with IEC/EN 60947-1	Make time, typically		Break time, typically		Rated operational power
		For 3VA1	For 3VA2	For 3VA1	For 3VA2	
■	■	< 80 ms (400 A, 630 A)	< 80 ms (100 A ... 630 A)	< 5 s (400 A, 630 A)	< 80 ms (100 A ... 250 A) < 5 s (400 A, 630 A)	300 W, max. 500 W (60 ms)

Spare parts kit for SEO520

Scope of supply
Mounting plate, plug

Spare parts kit for SEO520 with communication

Scope of supply
Mounting plate, plug, SLC adapter

Mechanical operating cycles counters (for installation in the SEO520)



Mounting	Article No.
For installation in the SEO520	3VA9987-0HX10

Cylinder lock adapters for SEO520



Mounting	Article No.
For installation of cylinder locks in the SEO520 up to 250 A	3VA9980-0LF30

Cylinder locks (type RONIS)



- Includes a lock with 2 keys
- To locking the operating mode (Manual/Auto/Lock) for SEOs up to 250 A

Key	Article No.
1	3VA9980-0VL10
3	3VA9980-0VL30
4	3VA9980-0VL40

		3VA10	3VA11	3VA12	3VA20 3VA21 3VA22	3VA13 3VA14	3VA23 3VA24
Rated control supply voltage	With communication						
42 ... 60 V AC, 24 ... 60 V DC	–	–	3VA9117-0HB10	–	–	–	–
110 ... 230 V AC, 110 ... 250 V DC	–	–	3VA9117-0HB20	–	–	–	–
Rated control supply voltage	With communication						
24 ... 60 V DC	–	–	3VA9157-0HA10	3VA9257-0HA10	3VA9267-0HA10	3VA9467-0HA10	3VA9467-0HA10
110 V AC	–	–	–	–	3VA9267-0HA21 ¹⁾	3VA9467-0HA21 ¹⁾	3VA9467-0HA21 ¹⁾
110 ... 230 V AC, 110 ... 250 V DC	–	–	3VA9157-0HA20	3VA9257-0HA20	3VA9267-0HA20	3VA9467-0HA20	3VA9467-0HA20
230 V AC	–	–	–	–	3VA9267-0HA22 ¹⁾	3VA9467-0HA22 ¹⁾	3VA9467-0HA22 ¹⁾
		–	3VA9157-0HA00	3VA9257-0HA00	3VA9267-0HA00	3VA9467-0HA00	3VA9467-0HA00
Rated control supply voltage	With communication						
24 V DC	–	–	–	–	3VA9267-0HC10	3VA9467-0HC10 ²⁾	
42 ... 60 V AC/DC	–	–	–	–	3VA9267-0HC20	3VA9467-0HC20 ²⁾	
110 ... 230 V AC, 110 ... 250 V DC	–	–	–	–	3VA9267-0HC30	3VA9467-0HC30 ²⁾	
24 V DC	Yes	–	–	–	3VA9267-0HC15	–	3VA9467-0HC15 ²⁾
110 ... 230 V AC, 110 ... 250 V DC	Yes	–	–	–	3VA9267-0HC35	–	3VA9467-0HC35 ²⁾
		–	–	–	3VA9267-0HC00	–	–
		–	–	–	3VA9267-0HC05	–	–

¹⁾ Optimized for long control cable lengths, see FAQ at www.siemens.com/lowvoltage/product-support (109804710)

²⁾ For 3VA13 and 3VA14 (IEC) with product version < *E04* and for 3VA23 and 3VA24 (IEC) with product version < *E06*, the service life (mechanical operating cycles) of the molded case circuit breaker is reduced when the SEO520 is used. For newer product versions, this is not the case. We recommend upgrading the circuit breaker to a higher product version, if necessary.



Reset mode

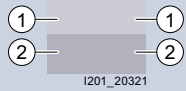
All motor operators have the following reset modes:

- Reset mode 1: Automatic reset
- Reset mode 2: Reset via OFF-signal

The motor operator with SEO520 stored energy operator additionally has:

- Reset mode 3: Reset via OFF-signal with additional acknowledge signal

Connection technology





- ① For mounting onto the circuit breaker
 ② For mounting on plug-in and withdrawable units



For a complete and valid configuration of your molded case circuit breaker, please use our online configurator at www.siemens.com/lowvoltage/3va-configurator

2



Box terminals

	Connection options		Scope of supply	Cable cross-section, copper stranded	Terminal short designation
	①	②			
	①	②	3 single terminals	1.5 ... 70 mm ²	TS1.1
				6 ... 120 mm ²	TS1.2
				25 ... 185 mm ²	TS1.4
				50 ... 185 mm ²	TS1.3
				35 ... 300 mm ²	TS1.5
	①	②	4 single terminals	1.5 ... 70 mm ²	TS1.1
				6 ... 120 mm ²	TS1.2
				25 ... 185 mm ²	TS1.4
				50 ... 185 mm ²	TS1.3
				35 ... 300 mm ²	TS1.5

Nut keeper kits

	Connection options		Scope of supply	Max. tap width	Max. tap thickness
	①	②			
	①	②	3 terminals	17 mm	6.5 mm
				25 mm	8 mm
				35 mm	10 mm
				Nut keeper kit for 3-pole breakers, 1 terminal cover	50 mm
	①	②	4 terminals	17 mm	6.5 mm
				25 mm	8 mm
				35 mm	10 mm
				Nut keeper kit for 4-pole breakers, 1 terminal cover	50 mm

Circular conductor terminals, 1 cable

	Connection options		Scope of supply	Cable cross-section	Copper/aluminum stranded ¹⁾		Terminal short designation
	①	②			Cu	Al ²⁾	
	①	②	3 single terminals	1.5 ... 10 mm ²	■	–	TA1.0
				1.5 ... 50 mm ²	■	–	TA1.3
				10 ... 95 mm ²	■	■	TA1.1
				16 ... 185 mm ²	■	■ ³⁾	TA1.4
				35 ... 185 mm ²	■	■	TA1.2
	①	②	4 single terminals	1.5 ... 10 mm ²	■	–	TA1.0
				1.5 ... 50 mm ²	■	–	TA1.3
				10 ... 95 mm ²	■	■	TA1.1
				16 ... 185 mm ²	■	■ ³⁾	TA1.4
				35 ... 185 mm ²	■	■	TA1.2
				50 ... 300 mm ²	■	■	TA1.5

¹⁾ All circular conductor terminals tested according to UL 486 A/B for Cu and Al cables

²⁾ Al cable tested according to IEC 60947-2 annex D

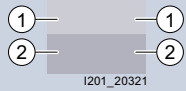
³⁾ Use antioxidants

⁴⁾ Maximum current-carrying capacity of cable connection 400 A
Flexible copper bar: No restrictions

⁵⁾ Maximum current-carrying capacity of copper cables 380 A
Maximum current-carrying capacity of aluminum cables 310 A

3VA10 3VA11	3VA12	3VA20 3VA21	3VA22	3VA13 3VA14 3VA23 3VA24	3VA15 3VA25
3VA9153-OJA11	–	–	–	–	–
–	3VA9253-OJA11	3VA9163-OJA12	3VA9163-OJA12	–	–
–	–	3VA9263-OJA12	3VA9263-OJA12	–	–
–	3VA9253-OJA12	–	–	–	–
–	–	–	–	3VA9483-OJA13 ⁴⁾	–
3VA9154-OJA11	–	–	–	–	–
–	3VA9254-OJA11	3VA9164-OJA12	3VA9164-OJA12	–	–
–	–	3VA9264-OJA12	3VA9264-OJA12	–	–
–	3VA9254-OJA12	–	–	–	–
–	–	–	–	3VA9484-OJA13 ⁴⁾	–
3VA9113-OQA00	–	–	–	–	–
–	3VA9213-OQA00	3VA9203-OQA00	3VA9203-OQA00	–	–
–	–	–	–	3VA9403-OQA00	–
–	–	–	–	–	3VA9603-OQA00
3VA9114-OQA00	–	–	–	–	–
–	3VA9214-OQA00	3VA9204-OQA00	3VA9204-OQA00	–	–
–	–	–	–	3VA9404-OQA00	–
–	–	–	–	–	3VA9604-OQA00
3VA9113-OJB10	–	–	–	–	–
–	–	3VA9103-OJB11	3VA9103-OJB11	–	–
3VA9113-OJB11	–	–	–	–	–
–	–	3VA9263-OJB12	3VA9263-OJB12	–	–
–	3VA9253-OJB12	–	–	–	–
–	–	–	–	3VA9383-OJB13 ⁵⁾	–
3VA9114-OJB10	–	–	–	–	–
–	–	3VA9104-OJB11	3VA9104-OJB11	–	–
3VA9114-OJB11	–	–	–	–	–
–	–	3VA9264-OJB12	3VA9264-OJB12	–	–
–	3VA9254-OJB12	–	–	–	–
–	–	–	–	3VA9384-OJB13 ⁵⁾	–

Connection technology



I201_20321

- ① For mounting onto the circuit breaker
② For mounting on plug-in and withdrawable units

For a complete and valid configuration of your molded case circuit breaker, please use our online configurator at www.siemens.com/lowvoltage/3va-configurator

2

Circular conductor terminals with control wire taps, 1 cable³⁾

	Connection options		Scope of supply	Cable cross-section	Copper/aluminum stranded ¹⁾		Terminal short designation
	①	②			Cu	Al ²⁾	
	①	②	3 single terminals	1.5 ... 10 mm ²	■	–	TA1.0
				1.5 ... 50 mm ²	■	–	TA1.3
				10 ... 95 mm ²	■	■	TA1.1
				16 ... 185 mm ²	■	■ ³⁾	TA1.4
				50 ... 185 mm ²	■	■	TA1.2
				50 ... 300 mm ²	■	■	TA1.5
	①	②	4 single terminals	1.5 ... 10 mm ²	■	–	TA1.0
				1.5 ... 50 mm ²	■	–	TA1.3
				10 ... 95 mm ²	■	■	TA1.1
				16 ... 185 mm ²	■	■ ³⁾	TA1.4
				50 ... 185 mm ²	■	■	TA1.2
				50 ... 300 mm ²	■	■	TA1.5

Circular conductor terminals, 2 cables

	Connection options		Scope of supply	Cable cross-section	Copper/aluminum stranded ¹⁾		Control wire tap ⁴⁾	Terminal short designation
	①	②			Cu	Al ²⁾		
	①	②	3 single terminals, 1 short terminal cover	120 ... 300 mm ²	■	■	No	TA3.1
							Yes	TA3.1
	①	②	4 single terminals, 1 short terminal cover	120 ... 300 mm ²	■	■	No	TA3.1
							Yes	TA3.1

Circular conductor terminals, 3 cables

	Connection options		Scope of supply	Cable cross-section	Copper/aluminum stranded ¹⁾		Control wire tap ⁴⁾	Terminal short designation
	①	②			Cu	Al ²⁾		
	①	②	3 single terminals, 1 short terminal cover	120 ... 185 mm ²	■	■	No	TA3.2
							Yes	TA3.2
	①	②	4 single terminals, 1 short terminal cover	120 ... 185 mm ²	■	■	No	TA3.2
							Yes	TA3.2

Control wire taps for box terminals³⁾

Connection options	
①	
②	

Control wire taps for busbars³⁾

Connection options	
①	
②	

¹⁾ All circular conductor terminals tested according to UL 486 A/B for Cu and Al cables

²⁾ Al cable tested according to IEC 60947-2 annex D

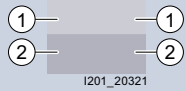
³⁾ Use antioxidants

⁴⁾ Maximum current-carrying capacity 15 A
Maximum cable connection up to 2.5 mm²

⁵⁾ Maximum current-carrying capacity of copper cables 380 A
Maximum current-carrying capacity of aluminum cables 310 A

3VA10 3VA11		3VA12	3VA20 3VA21	3VA22	3VA13 3VA14 3VA23 3VA24	3VA15 3VA25
3VA9113-0JG10	–	–	–	–	–	–
–	–	–	3VA9103-0JG11	3VA9103-0JG11	–	–
3VA9113-0JG11	–	–	–	–	–	–
–	–	–	3VA9263-0JG12	3VA9263-0JG12	–	–
–	3VA9253-0JG12	–	–	–	–	–
–	–	–	–	–	3VA9383-0JG13 ⁵⁾	–
3VA9114-0JG10	–	–	–	–	–	–
–	–	–	3VA9104-0JG11	3VA9104-0JG11	–	–
3VA9114-0JG11	–	–	–	–	–	–
–	–	–	3VA9264-0JG12	3VA9264-0JG12	–	–
–	3VA9254-0JG12	–	–	–	–	–
–	–	–	–	–	3VA9384-0JG13 ⁵⁾	–
–	–	–	–	–	–	3VA9503-0JB23
–	–	–	–	–	–	3VA9503-0JG23
–	–	–	–	–	–	3VA9504-0JB23
–	–	–	–	–	–	3VA9504-0JG23
–	–	–	–	–	–	3VA9503-0JB32
–	–	–	–	–	–	3VA9503-0JG32
–	–	–	–	–	–	3VA9504-0JB32
–	–	–	–	–	–	3VA9504-0JG32
3VA9110-0WB00	3VA9200-0WB00	3VA9200-0WB00	3VA9200-0WB00	3VA9480-0WB00	–	–
3VA9150-0WB00	3VA9280-0WB00	3VA9280-0WB00	3VA9280-0WB00	3VA9480-0WB00	–	–
3VA9110-0WC00	3VA9200-0WC00	3VA9200-0WC00	3VA9200-0WC00	3VA9480-0WC00	–	–
3VA9150-0WC00	3VA9280-0WC00	3VA9280-0WC00	3VA9280-0WC00	3VA9480-0WC00	–	–

Connection technology



- ① For mounting onto the circuit breaker
② For mounting on plug-in and withdrawable units

For a complete and valid configuration of your molded case circuit breaker, please use our online configurator at www.siemens.com/lowvoltage/3va-configurator

Note:

All bus connectors, bus connectors broadened and rear connections are Cu/Sn 6 r plated according to ISO 2093.

Front bus connectors



Number of poles	Connection options	Scope of supply	Max. tap width	Max. tap thickness
1P	① –	1 terminal	22 mm	8 mm
3P	– ②	3 terminals	6 x 50 mm	8 mm

Front bus connectors, with phase barriers

- 3-pole and 4-pole bus connectors only permitted if used with phase barriers!
- Phase barriers are included in the connection technology scope of supply or can be ordered as a spare part (3VA9...-WA00).



Number of poles	Connection options	Scope of supply	Max. tap width	Max. tap thickness
3P	① ②	3 terminals,	22 mm	8 mm
		2 phase barriers	32 mm	10 mm
			40 mm	12.5 mm
			50 mm	30 mm
		3 short terminals, ¹⁾	50 mm	30 mm
		2 phase barriers		



4P	① ②	4 terminals,	22 mm	8 mm
		3 phase barriers	32 mm	10 mm
			40 mm	12.5 mm
			50 mm	30 mm
		4 short terminals, ¹⁾	50 mm	30 mm
		3 phase barriers		

Bus connectors edgewise, with phase barriers

- 3-pole and 4-pole bus connectors only permitted if used with phase barriers!
- Phase barriers are included in the connection technology scope of supply or can be ordered as a spare part (3VA9...-WA00).



Number of poles	Connection options	Scope of supply	Max. tap width	Max. tap thickness
3P	① ②	3 terminals,	20 mm	6 mm
		2 phase barriers	25 mm	7 mm
			40 mm	8 mm



4P	① ②	4 terminals,	20 mm	6 mm
		3 phase barriers	25 mm	7 mm
			40 mm	8 mm

Front bus connectors broadened, with phase barriers

- 3-pole and 4-pole bus connectors broadened only permitted if used with phase barriers!
- Phase barriers are included in the connection technology scope of supply or can be ordered as a spare part (3VA9...-WA00).
- Distance between pole centers:
 - 100/160 A = 35 mm, 250 A = 45 mm, 400/630 A = 70 mm



Number of poles	Connection options	Scope of supply	Max. tap width	Max. tap thickness
3P	① ②	3 terminals,	30 mm	8 mm
		2 phase barriers	35 mm	10 mm
			60 mm	12.5 mm
			80 mm	10 mm



	– ②	3 terminals,	80 mm	15 mm
		2 phase barriers		
4P	① ②	4 terminals,	30 mm	8 mm
		3 phase barriers	35 mm	10 mm
			60 mm	12.5 mm
			80 mm	10 mm

¹⁾ Bus connectors short for use with terminal covers

3VA10 3VA11	3VA12	3VA20 3VA21 3VA22	3VA13 3VA14 3VA23 3VA24	3VA15 3VA25	3VA26
3VA9151-0QB00	-	-	-	-	-
-	-	-	-	3VA9603-0QB01	-
3VA9153-0QB00	-	-	-	-	-
-	3VA9253-0QB00	3VA9263-0QB00	-	-	-
-	-	-	3VA9483-0QB00	-	-
-	-	-	-	3VA9603-0QB00	-
-	-	-	-	3VA9603-0QB02	-
3VA9154-0QB00	-	-	-	-	-
-	3VA9254-0QB00	3VA9264-0QB00	-	-	-
-	-	-	3VA9484-0QB00	-	-
-	-	-	-	3VA9604-0QB00	-
-	-	-	-	3VA9604-0QB02	-
3VA9153-0QD00	-	-	-	-	-
-	3VA9253-0QD00	3VA9263-0QD00	-	-	-
-	-	-	3VA9483-0QD00	-	-
3VA9154-0QD00	-	-	-	-	-
-	3VA9254-0QD00	3VA9264-0QD00	-	-	-
-	-	-	3VA9484-0QD00	-	-
3VA9153-0QC00	-	-	-	-	-
-	3VA9253-0QC00	3VA9263-0QC00	-	-	-
-	-	-	3VA9483-0QC00	-	-
-	-	-	-	3VA9603-0QC00	-
-	-	-	-	3VA9603-0QC01	3VA9603-0QC01
3VA9154-0QC00	-	-	-	-	-
-	3VA9254-0QC00	3VA9264-0QC00	-	-	-
-	-	-	3VA9484-0QC00	-	-
-	-	-	-	3VA9604-0QC00	-

Connection technology





- ① For mounting onto the circuit breaker
 ② For mounting on plug-in and withdrawable units

For a complete and valid configuration of your molded case circuit breaker, please use our online configurator at www.siemens.com/lowvoltage/3va-configurator




Note:

All bus connectors, bus connectors broadened and rear connections are Cu/Sn 6 r plated according to ISO 2093.



Nut keeper kits, right-angled¹⁾

	Number of poles	Connection options		Scope of supply	Max. tap width	Max. tap thickness
	3P	①	②	3 terminals, 2 phase barriers	22 mm	8 mm
			–	–	32 mm	10 mm
			–	–	40 mm	12.5 mm
	4P	①	②	4 terminals, 3 phase barriers	22 mm	8 mm
			–	–	32 mm	10 mm
			–	–	40 mm	12.5 mm



Rear connection studs flat

	Number of poles	Connection options		Scope of supply	
	1P	①	②	1 short connection stud flat 1 long connection stud flat	
			–	–	–
	3P	①	②	2 short connection studs flat, 1 long connection stud flat	
			–	②	3 short connection studs flat
			–	②	3 short connection studs flat
	4P	①	②	2 short connection studs flat, 2 long connection stud flat	
			–	–	–




Rear connectors vertical

	Number of poles	Connection options		Scope of supply
	3P	①	–	3 rear connectors
			–	–
	4P	①	–	4 rear connectors
			–	–

Rear connectors horizontal

	Number of poles	Connection options		Scope of supply
	3P	①	–	3 rear connectors
			–	–
	4P	①	–	4 rear connectors
			–	–

Rear connection studs round

	Number of poles	Connection options		Scope of supply
	1P	①	②	1 short connection stud round 1 long connection stud round
			–	–
	3P	①	②	1 long connection stud round, 2 short connection studs round
			–	–
	4P	①	②	2 long connection studs round, 2 short connection studs round
			–	–

¹⁾ Can only be connected to breaker side N, 1, 3, 5

3VA10 3VA11		3VA12		3VA20 3VA21 3VA22		3VA13 3VA14 3VA23 3VA24		3VA15		3VA25 3VA26	
3VA9113-0QG00	–	–	–	–	–	–	–	–	–	–	–
–	3VA9213-0QG00	3VA9223-0QG00	–	–	–	–	–	–	–	–	–
–	–	–	–	–	–	3VA9403-0QG00	–	–	–	–	–
3VA9114-0QG00	–	–	–	–	–	–	–	–	–	–	–
–	3VA9214-0QG00	3VA9224-0QG00	–	–	–	–	–	–	–	–	–
–	–	–	–	–	–	3VA9404-0QG00	–	–	–	–	–
3VA9111-0QE10	3VA9211-0QE10	3VA9201-0QE10	3VA9401-0QE10	–	–	–	–	–	–	–	–
3VA9111-0QE20	3VA9211-0QE20	3VA9201-0QE20	3VA9401-0QE20	–	–	–	–	–	–	–	–
3VA9113-0QE00	3VA9213-0QE00	3VA9203-0QE00	3VA9403-0QE00	–	–	–	–	–	–	–	–
–	–	–	–	–	–	–	–	3VA9603-0QE01	–	3VA9603-0QE01	–
3VA9114-0QE00	3VA9214-0QE00	3VA9204-0QE00	3VA9404-0QE00	–	–	–	–	–	–	–	–
–	–	–	–	–	–	–	–	–	–	–	3VA9603-0QE00
–	–	–	–	–	–	–	–	–	–	–	3VA9604-0QE00
–	–	–	–	–	–	–	–	–	–	–	3VA9603-0QE60
–	–	–	–	–	–	–	–	–	–	–	3VA9604-0QE60
3VA9111-0QF10	3VA9211-0QF10	3VA9201-0QF10	3VA9401-0QF10	–	–	–	–	–	–	–	–
3VA9111-0QF20	3VA9211-0QF20	3VA9201-0QF20	3VA9401-0QF20	–	–	–	–	–	–	–	–
3VA9113-0QF00	3VA9213-0QF00	3VA9203-0QF00	3VA9403-0QF00	–	–	–	–	–	–	–	–
3VA9114-0QF00	3VA9214-0QF00	3VA9204-0QF00	3VA9404-0QF00	–	–	–	–	–	–	–	–

Connection technology



- ① For mounting onto the circuit breaker
 ② For mounting on plug-in and withdrawable units

For a complete and valid configuration of your molded case circuit breaker, please use our online configurator at www.siemens.com/lowvoltage/3va-configurator

Circular conductor terminals, 2P



Connection options	Scope of supply	Number of cables	Cable cross-section	Cu/Al stranded ¹⁾		Control wire tap ³⁾	Terminal short designation
				Cu	Al ²⁾		
① –	2 single terminals, 1 extended terminal cover, 1 insulation plate	1	25 ... 150 mm ²	■	■ ⁴⁾	Yes	TA2.1
		6	1.5 ... 35 mm ²	■	–	No	TA2.1 TA2.5

Circular conductor terminals, 3P



- Note on 3VA9603-0JJ25, 3VA9603-0JJ35 and 3VA9603-0JJ45:
1 set of front bus connectors 3VA9603-0QB01 is required for installing circular conductor terminals on the load side and/or outgoing side.

Connection options	Scope of supply	Number of cables	Cable cross-section	Cu/Al stranded ¹⁾		Control wire tap ³⁾	Terminal short designation
				Cu	Al ²⁾		
① –	3 single terminals, 1 extended terminal cover, 1 insulation plate	1	25 ... 150 mm ²	■	■ ⁴⁾	Yes	TA2.1
			50 ... 240 mm ²	■	■	No	TA2.1
			70 ... 300 mm ²	■	■	Yes	TA2.2
			120 ... 240 mm ²	■	–	No	TA2.2
		2	25 ... 150 mm ²	■	■ ⁴⁾	Yes	TA2.3
			70 ... 300 mm ²	■	■	No	TA2.3
			120 ... 240 mm ²	■	–	Yes	TA2.4
			120 ... 300 mm ²	■	■	No	TA2.4
		4	25 ... 150 mm ²	■	■ ⁴⁾	Yes	TA4.3
			70 ... 300 mm ²	■	■	No	TA4.3
			120 ... 240 mm ²	■	–	Yes	TA4.4
			120 ... 300 mm ²	■	■	No	TA4.4
– ②	3 single terminals, 1 extended terminal cover, 1 insulation plate	6	1.5 ... 35 mm ²	■	–	No	TA2.7
		1	25 ... 150 mm ²	■	■ ⁴⁾	Yes	TA2.1
			50 ... 240 mm ²	■	■	Yes	TA2.2
		2	25 ... 150 mm ²	■	■ ⁴⁾	Yes	TA2.3
			70 ... 300 mm ²	■	■	Yes	TA2.4
		3	150 ... 300 mm ²	■	■	Yes	TA5.1
4	150 ... 300 mm ²	■	–	Yes	TA5.2		
6	150 ... 300 mm ²	■	–	Yes	TA5.3		
	1.5 ... 35 mm ²	■	–	No	TA2.5 TA2.6 TA2.7		

¹⁾ All circular conductor terminals tested according to UL 486 A/B for Cu and Al cables

²⁾ Al cable tested according to IEC 60947-2 annex D

³⁾ Maximum current-carrying capacity 15 A
Maximum cable connection up to 2.5 mm²

⁴⁾ Max. 225 A

3VA10 3VA11	3VA12	3VA20 3VA21 3VA22	3VA13 3VA14 3VA23 3VA24	3VA15 3VA25
3VA9112-0JC12	–	–	–	–
3VA9112-0JJ12	–	–	–	–
3VA9112-0JF60	–	–	–	–
3VA9113-0JC12	–	–	–	–
3VA9113-0JJ12	–	–	–	–
–	3VA9213-0JC13	3VA9223-0JC13	–	–
–	3VA9213-0JJ13	3VA9223-0JJ13	–	–
–	3VA9213-0JC22	3VA9223-0JC22	–	–
–	3VA9213-0JJ22	3VA9223-0JJ22	–	–
–	–	–	3VA9403-0JC23	–
–	–	–	3VA9403-0JJ23	–
–	–	–	–	3VA9603-0JC43
–	–	–	–	3VA9603-0JJ43
–	–	–	–	3VA9603-0JC44
–	–	–	–	3VA9603-0JJ44
3VA9113-0JF60	3VA9213-0JF60	3VA9223-0JF60	3VA9303-0JF60	–
3VA9153-0JC12	–	–	–	–
–	3VA9253-0JC13	3VA9263-0JC13	–	–
–	3VA9253-0JC22	3VA9263-0JC22	–	–
–	–	–	3VA9483-0JC23	–
–	–	–	–	3VA9603-0JJ25
–	–	–	–	3VA9603-0JJ35
–	–	–	–	3VA9603-0JJ45
3VA9153-0JF60	–	–	–	–
–	3VA9253-0JF60	3VA9263-0JF60	–	–
–	–	–	3VA9383-0JF60	–

Connection technology



- ① For mounting onto the circuit breaker
② For mounting on plug-in and withdrawable units

For a complete and valid configuration of your molded case circuit breaker, please use our online configurator at www.siemens.com/lowvoltage/3va-configurator

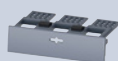
2

Circular conductor terminals, 4P



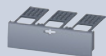
Connection options	Scope of supply	Number of cables	Cable cross-section	Cu/Al stranded ¹⁾		Control wire tap ³⁾	Terminal short designation
				Cu	Al ²⁾		
① –	4 single terminals, 1 extended terminal cover, 1 insulation plate	1	25 ... 150 mm ²	■	■ ⁴⁾	Yes	TA2.1
			50 ... 240 mm ²	■	■	No	TA2.1
			50 ... 240 mm ²	■	■	Yes	TA2.2
			50 ... 240 mm ²	■	■	No	TA2.2
		2	25 ... 150 mm ²	■	■ ⁴⁾	Yes	TA2.3
			25 ... 150 mm ²	■	■ ⁴⁾	No	TA2.3
			70 ... 300 mm ²	■	■	Yes	TA2.4
			70 ... 300 mm ²	■	■	No	TA2.4
		4	120 ... 240 mm ²	■	–	Yes	TA4.3
			120 ... 240 mm ²	■	–	No	TA4.3
			120 ... 300 mm ²	■	■	Yes	TA4.4
			120 ... 300 mm ²	■	■	No	TA4.4
6	1.5 ... 35 mm ²	■	–	No	TA2.5		
	1.5 ... 35 mm ²	■	–	No	TA2.6		
	1.5 ... 35 mm ²	■	–	No	TA2.7		
	1.5 ... 35 mm ²	■	–	No	TA2.7		
– ②	4 single terminals, 1 extended terminal cover, 1 insulation plate	1	25 ... 150 mm ²	■	■ ⁴⁾	Yes	TA2.1
			50 ... 240 mm ²	■	■	Yes	TA2.2
			25 ... 150 mm ²	■	■ ⁴⁾	Yes	TA2.3
			70 ... 300 mm ²	■	■	Yes	TA2.4
		2	25 ... 150 mm ²	■	■ ⁴⁾	Yes	TA2.3
			25 ... 150 mm ²	■	■ ⁴⁾	No	TA2.3
			70 ... 300 mm ²	■	■	Yes	TA2.4
			70 ... 300 mm ²	■	■	No	TA2.4
		6	1.5 ... 35 mm ²	■	–	No	TA2.5
			1.5 ... 35 mm ²	■	–	No	TA2.6
			1.5 ... 35 mm ²	■	–	No	TA2.7
			1.5 ... 35 mm ²	■	–	No	TA2.7

Terminal covers specially for fixed-mounted units



Version	Number of poles	Mounting location	
Short	1P	①	–
	2P	①	–
	3P	①	–
	4P	①	–
Intermediate	3P	①	–
	4P	①	–
Extended ⁵⁾	2P	①	–
	3P	①	–
	4P	①	–
Broadened ⁵⁾	3P	①	–
	4P	①	–

Terminal covers specially for plug-in and withdrawable units (spare part)



- To provide circuit breaker touch protection
- For mounting to the molded case circuit breaker
- Included in scope of supply: Cover for the infeed and outgoing terminal

Version	Number of poles	Mounting location	
Short	3P	①	–
	4P	①	–

¹⁾ All circular conductor terminals tested according to UL 486 A/B for Cu and Al cables

²⁾ Al cable tested according to IEC 60947-2 annex D

³⁾ Maximum current-carrying capacity 15 A
Maximum cable connection up to 2.5 mm²

⁴⁾ Max. 225 A

⁵⁾ Including insulating plate

⁶⁾ Suitable for circular conductor terminals 2/4 cables

Connection technology



- ① For mounting onto the circuit breaker
 ② For mounting on plug-in and withdrawable units

For a complete and valid configuration of your molded case circuit breaker, please use our online configurator at www.siemens.com/lowvoltage/3va-configurator

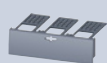
2

3VA10

3VA11

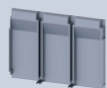
Terminal covers for plug-in or withdrawable sockets

- For touch protection in the termination area
- Of the plug-in or withdrawable socket
- For mounting onto the plug-in or withdrawable socket



Version	Number of poles	Mounting location		3VA10	3VA11
Short	3P	–	②	–	3VA9153-0KB03
	4P	–	②	–	3VA9154-0KB03
Extended ¹⁾	3P	–	②	–	3VA9153-0KB04
	4P	–	②	–	3VA9154-0KB04
Broadened ¹⁾	3P	–	②	–	3VA9153-0KB05
	4P	–	②	–	3VA9154-0KB05

Insulating plates



Version	Number of poles	Mounting location		3VA10	3VA11
Standard	2P	①	–	–	3VA9111-0WJ20
	3P	①	–	3VA9111-0WJ30	3VA9111-0WJ30
	4P	①	–	3VA9111-0WJ40	3VA9111-0WJ40
Broadened	3P	①	–	3VA9111-0WK30	3VA9111-0WK30
	4P	①	–	3VA9111-0WK40	3VA9111-0WK40

Phase barriers



Mounting location	Scope of supply	3VA10	3VA11
① ②	2 phase barriers	–	3VA9152-0WA00
– ②	2 phase barriers	–	–

Protective sleeve for insulation of rear connections



Mounting location	Scope of supply	3VA10	3VA11
②	3 protective sleeves	–	–

DC insulation plates for 3VA1 for fixed-mounted molded case circuit breakers



Number of poles	3VA10	3VA11
3P	–	3VA9113-0SG10
4P	–	3VA9114-0SG10

Side plates for 3VA1 for fixed-mounted molded case circuit breakers



Number of poles	Mounting	3VA10	3VA11
2P	On 2-pole molded case circuit breakers	–	3VA9112-0SG20

¹⁾ Including insulating plate

	3VA20 3VA21 3VA22	3VA13 3VA14 3VA23 3VA24	3VA15 3VA25	3VA26
3VA9253-0KB03	3VA9163-0KB03	3VA9353-0KB03	3VA9603-0KB03	–
3VA9254-0KB03	3VA9164-0KB03	3VA9354-0KB03	–	–
3VA9253-0KB04	3VA9163-0KB04	3VA9353-0KB04	–	–
3VA9254-0KB04	3VA9164-0KB04	3VA9354-0KB04	–	–
3VA9253-0KB05	3VA9163-0KB05	3VA9353-0KB05	–	–
3VA9254-0KB05	3VA9164-0KB05	3VA9354-0KB05	–	–
–	–	–	–	–
3VA9211-0WJ30	3VA9221-0WJ30	3VA9481-0WJ30	–	–
3VA9211-0WJ40	3VA9221-0WJ40	3VA9481-0WJ40	–	–
3VA9211-0WK30	3VA9221-0WK30	3VA9481-0WK30	–	–
3VA9211-0WK40	3VA9221-0WK40	3VA9481-0WK40	–	–
3VA9252-0WA00	3VA9262-0WA00	3VA9482-0WA00	3VA9602-0WA00 3VA9602-0WA05	3VA9602-0WA00 3VA9602-0WA05
–	–	–	3VA9603-0WH05	–
–	–	–	–	–
–	–	–	–	–
–	–	–	–	–

Plug-in and withdrawable technology



Thanks to plug-in and withdrawable technology:




- Molded case circuit breakers can be replaced quickly and easily for overhauls or servicing
- Electrical isolation and clearly visible isolating distance
- The socket can be interlocked to prevent the 3VA molded case circuit breaker from being plugged in or moved in
- Identical connection technology for all molded case circuit breakers, whether they are plug-in, withdrawable or fixed-mounted units

In addition, withdrawable technology offers:

- Transmission of the position of the molded case circuit breaker via communication (CONNECT, TEST, DISCONNECT)
- The ability to test the auxiliary and control circuit connections in the test position of the withdrawable unit, without contacted main current paths
- Transmission of the state of the molded case circuit breaker (ON, OFF, TRIP) via the COM060 communications module

For a complete and valid configuration of your molded case circuit breaker, please use our online configurator at www.siemens.com/lowvoltage/3va-configurator




	3VA11	3VA12	3VA20 3VA21 3VA22	3VA13 3VA14 3VA23 3VA24	3VA15 3VA25 3VA26
Withdrawable units, complete kits					
	<ul style="list-style-type: none"> • Scope of supply: <ul style="list-style-type: none"> – Withdrawable socket – Withdrawable unit, conversion kit – Mounting screw kit • Note: The crank for the withdrawable unit must be ordered separately. 				
Number of poles					
3P	–	3VA9213-0KD00	3VA9123-0KD00	3VA9323-0KD00	–
4P	–	3VA9214-0KD00	3VA9124-0KD00	3VA9324-0KD00	–
Withdrawable units, conversion kits					
	<ul style="list-style-type: none"> • Scope of supply: <ul style="list-style-type: none"> – Screw-fastened terminal covers for molded case circuit breakers – Side panels – Plug-in contacts – Cable cages – Autotrip plunger • Note: The crank for the withdrawable unit must be ordered separately. 				
Number of poles					
3P	–	3VA9213-0KD10	3VA9123-0KD10	3VA9323-0KD10	–
4P	–	3VA9214-0KD10	3VA9124-0KD10	3VA9324-0KD10	–

	3VA11	3VA12	3VA20 3VA21 3VA22	3VA13 3VA14 3VA23 3VA24	3VA15 3VA25 3VA26																		
Plug-in units, complete kits																							
	<ul style="list-style-type: none"> • Scope of supply: <ul style="list-style-type: none"> – Plug-in socket – Plug-in unit, conversion kit – Mounting screw kit • Note on 3VA9603-OKP00: <ul style="list-style-type: none"> – An undervoltage release (UVR) (article number 3VA9908-0BB..) is required in the circuit breaker in order to provide the protection trip specified in the standard for unplugging the circuit breaker under load. The required UVR voltage version must be ordered in addition. 																						
	<table border="1"> <thead> <tr> <th>Number of poles</th> <th></th> <th></th> <th></th> <th></th> <th></th> </tr> </thead> <tbody> <tr> <td>3P</td> <td>3VA9113-OKP00</td> <td>3VA9213-OKP00</td> <td>3VA9123-OKP00</td> <td>3VA9323-OKP00</td> <td>3VA9603-OKP00</td> </tr> <tr> <td>4P</td> <td>3VA9114-OKP00</td> <td>3VA9214-OKP00</td> <td>3VA9124-OKP00</td> <td>3VA9324-OKP00</td> <td>–</td> </tr> </tbody> </table>						Number of poles						3P	3VA9113-OKP00	3VA9213-OKP00	3VA9123-OKP00	3VA9323-OKP00	3VA9603-OKP00	4P	3VA9114-OKP00	3VA9214-OKP00	3VA9124-OKP00	3VA9324-OKP00
Number of poles																							
3P	3VA9113-OKP00	3VA9213-OKP00	3VA9123-OKP00	3VA9323-OKP00	3VA9603-OKP00																		
4P	3VA9114-OKP00	3VA9214-OKP00	3VA9124-OKP00	3VA9324-OKP00	–																		
Plug-in units, conversion kits																							
	<ul style="list-style-type: none"> • Scope of supply: <ul style="list-style-type: none"> – Screw-fastened terminal covers for molded case circuit breakers – Plug-in contacts – Cable cages – Autotrip plunger 																						
	<table border="1"> <thead> <tr> <th>Number of poles</th> <th></th> <th></th> <th></th> <th></th> <th></th> </tr> </thead> <tbody> <tr> <td>3P</td> <td>3VA9113-OKP10</td> <td>3VA9213-OKP10</td> <td>3VA9123-OKP10</td> <td>3VA9323-OKP10</td> <td>–</td> </tr> <tr> <td>4P</td> <td>3VA9114-OKP10</td> <td>3VA9214-OKP10</td> <td>3VA9124-OKP10</td> <td>3VA9324-OKP10</td> <td>–</td> </tr> </tbody> </table>						Number of poles						3P	3VA9113-OKP10	3VA9213-OKP10	3VA9123-OKP10	3VA9323-OKP10	–	4P	3VA9114-OKP10	3VA9214-OKP10	3VA9124-OKP10	3VA9324-OKP10
Number of poles																							
3P	3VA9113-OKP10	3VA9213-OKP10	3VA9123-OKP10	3VA9323-OKP10	–																		
4P	3VA9114-OKP10	3VA9214-OKP10	3VA9124-OKP10	3VA9324-OKP10	–																		
Plug-in units, conversion kits with blade contacts																							
	<ul style="list-style-type: none"> • Scope of supply: <ul style="list-style-type: none"> – 6× blade contacts – Guide frame for circuit breaker – 2× cover for blade contacts – Position signaling switch – Connecting cable for auxiliary circuits 																						
	<table border="1"> <thead> <tr> <th>Number of poles</th> <th></th> <th></th> <th></th> <th></th> <th></th> </tr> </thead> <tbody> <tr> <td>3P</td> <td>–</td> <td>–</td> <td>–</td> <td>–</td> <td>3VA9603-OKP10</td> </tr> </tbody> </table>						Number of poles						3P	–	–	–	–	3VA9603-OKP10					
Number of poles																							
3P	–	–	–	–	3VA9603-OKP10																		








Plug-in and withdrawable technology

For a complete and valid configuration of your molded case circuit breaker, please use our online configurator at www.siemens.com/lowvoltage/3va-configurator

2

	3VA11	3VA12	3VA20 3VA21 3VA22	3VA13 3VA14 3VA23 3VA24	3VA15 3VA25 3VA26
Cable cages for plug-in/withdrawable units (spare part)					
	<ul style="list-style-type: none"> For routing of the required cables from the internal accessories on the back of the circuit breaker 				
Number of poles					
3P/4P	3VA9157-OKB02	3VA9257-OKB02	3VA9167-OKB02	3VA9367-OKB02	–
Door feedthroughs					
	–	3VA9257-OKT00	3VA9167-OKT00	3VA9367-OKT00	–
Autotrip plungers (spare part)					
Version					
	3VA9157-OKP81	3VA9257-OKP81	3VA9267-OKP81	3VA9457-OKP81	–
Plug-in unit	–	3VA9257-OKD81	3VA9267-OKD81	3VA9457-OKD81	–
Withdrawable unit	–	–	–	–	–

Accessories

		3VA11	3VA12	3VA20	3VA21	3VA22	3VA13	3VA14	3VA15	3VA23	3VA24	3VA25	3VA26
Communications interface for withdrawable unit													
	Scope of supply	Set of cables with three special position signaling switches, 3VA9987-0KC10 connecting cables											
		3VA9987-0KC00	3VA9987-0KC00	3VA9987-0KC00	3VA9987-0KC00	3VA9987-0KC00	3VA9987-0KC00	3VA9987-0KC00	3VA9987-0KC00	3VA9987-0KC00	3VA9987-0KC00	3VA9987-0KC00	3VA9987-0KC00
Position signaling switches for withdrawable unit and plug-in unit													
	Note on 3VA9603-0KB00:	4 position signaling switches can be installed in the plug-in base.											
		3VA9987-0KB00	3VA9987-0KB00	3VA9987-0KB00	3VA9987-0KB00	3VA9987-0KB00	3VA9987-0KB00	3VA9987-0KB00	3VA9987-0KB00	3VA9987-0KB00	3VA9987-0KB00	3VA9987-0KB00	3VA9987-0KB00
Connecting cables													
	Use	Connection of position signaling switches for communication with COM060											
		3VA9987-0KC10	3VA9987-0KC10	3VA9987-0KC10	3VA9987-0KC10	3VA9987-0KC10	3VA9987-0KC10	3VA9987-0KC10	3VA9987-0KC10	3VA9987-0KC10	3VA9987-0KC10	3VA9987-0KC10	3VA9987-0KC10
	For auxiliary circuits	–	–	–	–	–	–	–	–	–	–	–	3VA9603-0KP80
Cranks for withdrawable units													
	Version	Insulated											
	Scope of supply	Including crank holder											
		3VA9987-0KD81	3VA9987-0KD81	3VA9987-0KD81	3VA9987-0KD81	3VA9987-0KD81	3VA9987-0KD81	3VA9987-0KD81	3VA9987-0KD81	3VA9987-0KD81	3VA9987-0KD81	3VA9987-0KD81	3VA9987-0KD81
Auxiliary circuit connectors													
	Note:	Each auxiliary circuit connector is designed for 4 cables.											
	Version	For all withdrawable units											
		3VA9987-0KD80	3VA9987-0KD80	3VA9987-0KD80	3VA9987-0KD80	3VA9987-0KD80	3VA9987-0KD80	3VA9987-0KD80	3VA9987-0KD80	3VA9987-0KD80	3VA9987-0KD80	3VA9987-0KD80	3VA9987-0KD80
	For all plug-in units	3VA9987-0KP80	3VA9987-0KP80	3VA9987-0KP80	3VA9987-0KP80	3VA9987-0KP80	3VA9987-0KP80	3VA9987-0KP80	3VA9987-0KP80	3VA9987-0KP80	3VA9987-0KP80	3VA9987-0KP80	3VA9987-0KP80
Cylinder locks													
	Scope of supply:	– 1 lock with 2 keys											
		For locking or interlocking											
	Note:	Not for 3VA15/3VA25!											
	Key	Lock number											
	1	3VA9980-0VL10	3VA9980-0VL10	3VA9980-0VL10	3VA9980-0VL10	3VA9980-0VL10	3VA9980-0VL10	3VA9980-0VL10	3VA9980-0VL10	3VA9980-0VL10	3VA9980-0VL10	3VA9980-0VL10	3VA9980-0VL10
	3	3VA9980-0VL30	3VA9980-0VL30	3VA9980-0VL30	3VA9980-0VL30	3VA9980-0VL30	3VA9980-0VL30	3VA9980-0VL30	3VA9980-0VL30	3VA9980-0VL30	3VA9980-0VL30	3VA9980-0VL30	3VA9980-0VL30
	4	3VA9980-0VL40	3VA9980-0VL40	3VA9980-0VL40	3VA9980-0VL40	3VA9980-0VL40	3VA9980-0VL40	3VA9980-0VL40	3VA9980-0VL40	3VA9980-0VL40	3VA9980-0VL40	3VA9980-0VL40	3VA9980-0VL40
Cylinder lock adapters for withdrawable units													
	Note:	To prevent unauthorized withdrawal or insertion of the circuit breaker into the withdrawable unit											
		Circuit breaker can be locked in the CONNECT, TEST and DISCONNECT positions											
	Use	For fitting a cylinder lock in the right-hand side wall of the withdrawable unit											
		3VA9980-0LF40	3VA9980-0LF40	3VA9980-0LF40	3VA9980-0LF40	3VA9980-0LF40	3VA9980-0LF40	3VA9980-0LF40	3VA9980-0LF40	3VA9980-0LF40	3VA9980-0LF40	3VA9980-0LF40	3VA9980-0LF40

2

Residual current devices RCD

According to IEC 60947-2 annex B (Type A, Type B) and according to DIN VDE 0664-400 (Type B+)

For a complete and valid configuration of your molded case circuit breaker, please use our online configurator at www.siemens.com/lowvoltage/3va-configurator

2

Residual current devices (RCD) for switch disconnectors and molded case circuit breakers

- Mounted onto the side (left)



Number of poles	Type	Sensitivity ³⁾	Rated residual response current $I_{\Delta n}$	Limit value of non-tripping time Δt	Rated operational voltage U_e	Fault current frequency	Pre-alarm			Trip alarm			
									COM			COM	
3-pole	RCD510	Type A	0.03 ... 5 A	0 ... 3 s	127 ... 480 V AC	50/60 Hz	1	–	–	–	■	■	–
4-pole	RCD310	Type A	0.03 ... 5 A	Instantaneous	127 ... 480 V AC	50/60 Hz	1	–	–	–	■	■	–
	RCD510	Type A	0.03 ... 5 A	0 ... 3 s	127 ... 480 V AC	50/60 Hz	1	–	–	–	■	■	–



Residual current devices (RCD) for molded case circuit breakers

- Mounted below (under trip unit)

Number of poles	Type	Sensitivity ³⁾	Rated residual response current $I_{\Delta n}$	Limit value of non-tripping time Δt	Rated operational voltage U_e	Fault current frequency	Pre-alarm			Trip alarm			
									COM			COM	
3-pole	RCD520	Type A	0.03 ... 5 A	0 ... 3 s	127 ... 480 V AC	50/60 Hz	1	–	–	–	■	■	–
	RCD520B ¹⁴⁾	Type B	0.03 ... 5 A	0 ... 10 s	127 ... 690 V AC	0 ... 100 kHz	1	■	–	–	■	■	–
		Type B+	0.03 ... 0.3 A										
4-pole	RCD820 ²⁾	Type A	0.03 ... 30 A ⁵⁾	0 ... 10 s	127 ... 690 V AC	50/60 Hz	2	■	■	■	■	■	■
	RCD320	Type A	0.03 ... 5 A	Instantaneous	127 ... 480 V AC	50/60 Hz	1	–	–	–	■	■	–
	RCD520	Type A	0.03 ... 5 A	0 ... 3 s	127 ... 480 V AC	50/60 Hz	1	–	–	–	■	■	–
	RCD520B ⁴⁾	Type B	0.03 ... 5 A	0 ... 10 s	127 ... 690 V AC	0 ... 100 kHz	1	■	–	–	■	■	–
		Type B+	0.03 ... 0.3 A										
	RCD820 ²⁾	Type A	0.03 ... 30 A ⁵⁾	0 ... 10 s	127 ... 690 V AC	50/60 Hz	2	■	■	■	■	■	■

Residual current releases (spare part)



Version	Scope of supply
For RCD310 or RCD510	RCR, RCR-RCD cables

RCD820 - 3VA2 ETU connecting cables (spare part)

- Connecting cable between the RCD820 and the electronic trip unit (ETU) of a 3VA2



Version	Scope of supply
For RCD820	1 × RCD-ETU cable

¹⁾ 3-pole version in 4-pole enclosure

²⁾ With energy infeed from below, the required auxiliary switch (AUX) must be ordered separately

³⁾ Type A: pulse current sensitive, type B/B+: universal current sensitive

⁴⁾ Sensitivity selectable for type B/B+

⁵⁾ $I_{\Delta n} = 30A$: type AC

⁶⁾ If the molded case circuit breaker has no box terminals as connections, a set of box terminals must be ordered additionally for the taps below the thermal-magnetic trip units.

⁷⁾ 1 set of box terminals is included in scope of supply of the RCD510 (3VA921.-0R520).

Modular residual current devices type A/B (according to IEC 60947-2 annex M), see monitoring devices, from page 11/1 onwards

			3VA11	3VA12	3VA20 3VA21	3VA22	3VA23	3VA24	3VA10 3VA13 3VA14 3VA15 3VA25 3VA26
Monitoring mode (tripping can be disabled as an option)	Remote test/remote reset	Communication-capable							
■	–	–	3VA9113-ORS20 ⁶⁾	3VA9213-ORS20 ⁷⁾	–	–	–	–	–
■	–	–	3VA9114-ORS10 ⁶⁾	–	–	–	–	–	–
■	–	–	3VA9114-ORS20 ⁶⁾	3VA9214-ORS20 ⁷⁾	–	–	–	–	–
Monitoring mode (tripping can be disabled as an option)	Remote test/remote reset	Communication-capable							
–	–	–	3VA9113-ORL20	3VA9213-ORL20	–	–	–	–	–
■	–	–	3VA9113-ORL21	–	–	–	–	–	–
■	■	■	–	–	3VA9123-ORL30	3VA9223-ORL30	3VA9323-ORL30	3VA9423-ORL30	–
–	–	–	3VA9114-ORL10	–	–	–	–	–	–
–	–	–	3VA9114-ORL20	3VA9214-ORL20	–	–	–	–	–
■	–	–	3VA9114-ORL21	–	–	–	–	–	–
■	■	■	–	–	3VA9124-ORL30	3VA9224-ORL30	3VA9324-ORL30	3VA9424-ORL30	–
			3VA9988-0BR10	3VA9988-0BR10	–	–	–	–	–
			–	–	3VA9927-ORC00	3VA9927-ORC00	3VA9927-ORC00	3VA9927-ORC00	–

Communication

2

Metering function ¹⁾			ETU 5-series	ETU 8-series	Display in ETU	Display DSP800	Communication COM800/COM100
Current							
Phase and neutral conductor currents	I_1, I_2, I_3, I_N	A	■	■	□	□	■
Residual current to ground	I_g	A	■	■	□	□	■
Phase with highest load		A	■	■	□	□	■
Average value over the three phase currents	$I_{LAVG} = (I_1 + I_2 + I_3)/3$	A	–	■	–	□	■
Asymmetry of the phase currents	I_{nba}	%	–	■	–	□	■
THD of the 3 phases	$THDI_1, THDI_2, THDI_3$	%	–	■	–	□	■
Voltage							
Phase voltages incl. average value	$U_{12}, U_{23}, U_{31}, U_{phavg}$	V	–	■	□	□	■
Voltages to N conductor incl. average value	$U_{1N}, U_{2N}, U_{3N}, U_{Navg}$	V	–	■	–	□	■
Voltage unbalance		%	–	■	–	□	■
THD phase/phase and phase/N	$THDI_1, THDI_2, THDI_3$	%	–	■	–	□	■
Power							
Active power, total and per phase	P_1, P_2, P_3, P_{tot}	kW	–	■	□ (P_{tot})	□	■
Apparent power, total and per phase	S_1, S_2, S_3, S_{tot}	kVA	–	■	–	□	■
Reactive power, total and per phase	Q_1, Q_2, Q_3, Q_{tot}	kVAr	–	■	□	□	■
Power factor of the fundamental	$P_{F1}, P_{F2}, P_{F3}, P_{Favg}$		–	■	□ (PF_{avg})	□	■
Energy							
Active energy, infeed and feedback	E_p	kWh	–	■	□	□	■
Reactive energy, infeed and feedback	E_q	kVArh	–	■	–	□	■
Apparent energy	E_s	kVAh	–	■	–	□	■
Frequency							
Present frequency	f	Hz	–	■	□	□	■
Min/max pointer function							
Min./max. current, voltage, power	With time stamp	–	–	–	–	–	■
Condition Monitoring ²⁾							
Operating cycles counter	CLOSE-OPEN cycle		■	■	–	–	■
Operating hours		h	■	■	–	–	■
Trip counter	Differentiated by trip causes		■	■	–	–	■
Health indicator ³⁾	Incl. contact state	%	■	■	■	–	■
Remaining life time ³⁾		Time	■	■	–	–	■

■ Available □ Displayable – Not available

¹⁾ Depending on ETU version

²⁾ Only available with continuous external power supply and COM060 and COM800/100 communication interfaces

³⁾ Firmware 4.4 or higher of ETU, COM060, COM800/100 required

	3VA20	3VA23
	3VA21	3VA24
	3VA22	3VA25
		3VA26

COM060 communications modules



- For mounting in the right-hand accessories compartment of the 3VA2 molded case circuit breaker (including ETU power supply)
- Including a T-Connector

Use

Communication to the COM800/COM100 data concentrator via 3VA line

3VA9187-0TB10

3VA9387-0TB10

SLC adapters (spare part)



Scope of supply

5 units

3VA9187-0TB60

3VA9387-0TB60

24 V modules



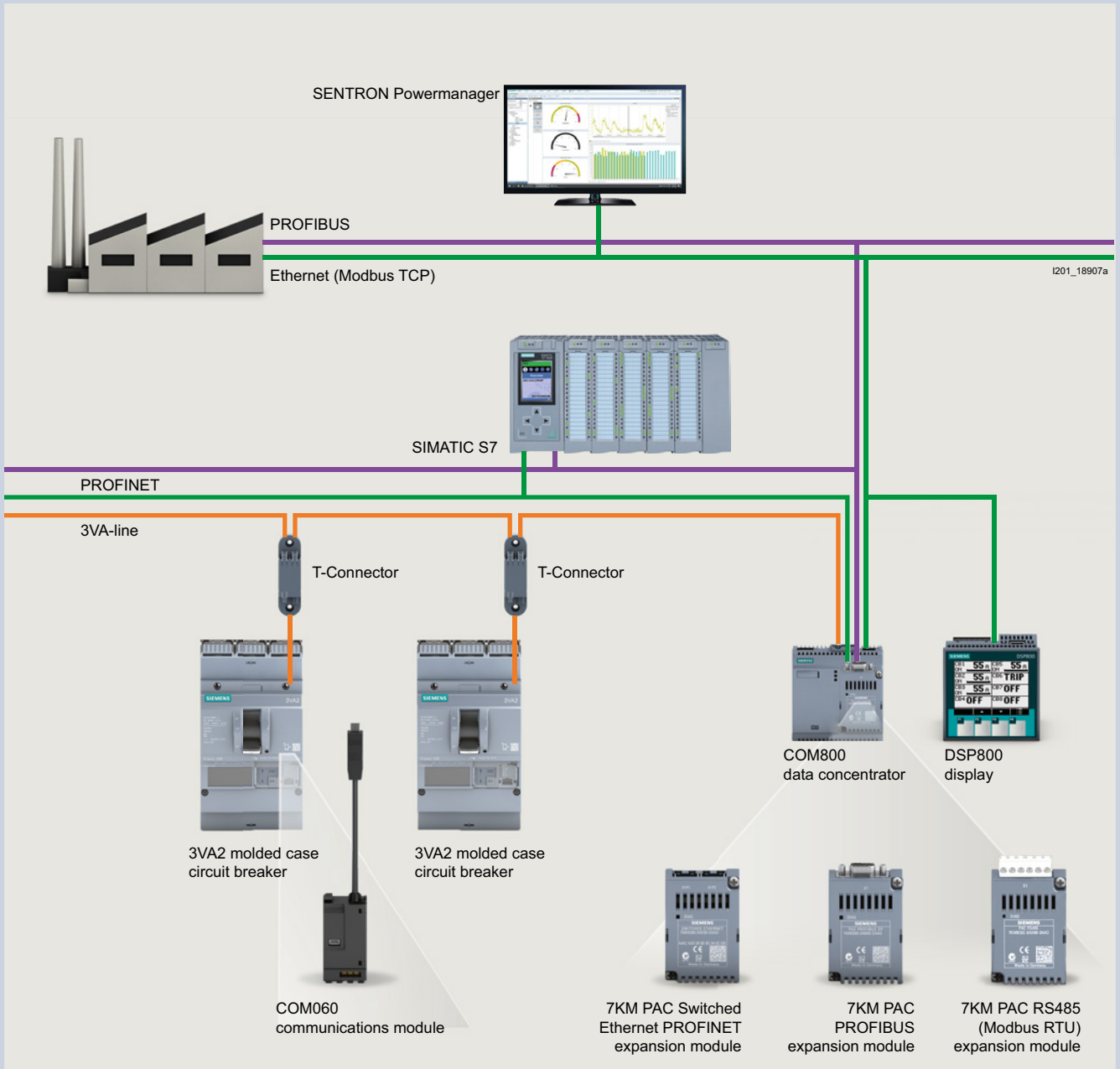
- 24 V DC
- For mounting in the right-hand accessories compartment of the 3VA2

Use

Optional energy supply for the ETU, also includes continuous operation of the ETU display and the metering function of the ETU 8-series

3VA9187-0TB50

3VA9387-0TB50



Communication

Data concentrator

COM800 data concentrators



Version

Central communications module for connection of up to eight 3VA2 molded case circuit breakers via the 3VA line, Ethernet 10/100 Mbps interface module socket for inserting an optional PROFIBUS DP or PROFINET module, 2 terminating resistors

Article No.

3VA9987-0TA10

COM100 data concentrators



Version

Central communications module for connection of a 3VA2 molded case circuit breaker via the 3VA line, Ethernet 10/100 Mbps interface module socket for inserting an optional PROFIBUS DP or PROFINET module, 2 terminating resistors

Article No.

3VA9987-0TA20

7KM PAC PROFIBUS DP expansion modules



Use

Used for connecting the COM800/COM100 data concentrator, and the 3VA molded case circuit breakers connected to it, to PROFIBUS DPV1. Supplies the state and measured variables of the 3VA molded case circuit breaker for the PROFIBUS DP master. Receives information (e.g. commands) from the PROFIBUS DP master and transmits them to the 3VA molded case circuit breaker.

Article No.

7KM9300-0AB01-0AA0

7KM PAC Switched Ethernet PROFINET expansion modules



Use

Used for connecting the COM800/COM100 data concentrator, and the connected 3VA molded case circuit breakers, to PROFINET via two Ethernet interfaces. Supplies the state and measured variables of the 3VA molded case circuit breakers to PROFINET via the PROFINET IO, PROFINET energy and Modbus TCP protocols.

Article No.

7KM9300-0AE02-0AA0

7KM PAC RS485 Modbus RTU expansion modules



Use

Used for connecting the COM800/COM100 data concentrator, and the 3VA molded case circuit breakers connected to it, to Modbus RTU. Supplies the state and measured variables of the 3VA molded case circuit breaker for the Modbus RTU master. Receives information (e.g. commands) from the Modbus RTU master and transmits them to the 3VA molded case circuit breaker.

Article No.

7KM9300-0AM00-0AA0

Interfaces

Interfaces to IEC 61850

- The SICAM A8000 smart data concentrator connects the circuit breakers from the SENTRON portfolio via the Modbus TCP/IP protocol and transmits data via communication protocols (e.g.: IEC 61850, IEC 60870-5-104, IEC 60870-5-101, Modbus and DNP) to higher-level systems.



Type	Processor assembly	Article No.
SICAM CP-8021 ¹⁾	–	6MF2802-1AA00
SICAM CP-8031 ²⁾	–	6MF2803-1AA00
SICAM CP-8050 ³⁾	–	6MF2805-0AA00
SICAM PS-8620	24 ... 60 V DC (12 W)	6MF2862-0AA00
SICAM PS-8622	110 ... 220 V DC (12 W)	6MF2862-2AA00

¹⁾ Dimensioned for device quantities of max. 1× 3WA and 1× 3VA

²⁾ Dimensioned for device quantities of 1× 3WA and 8× 3VA

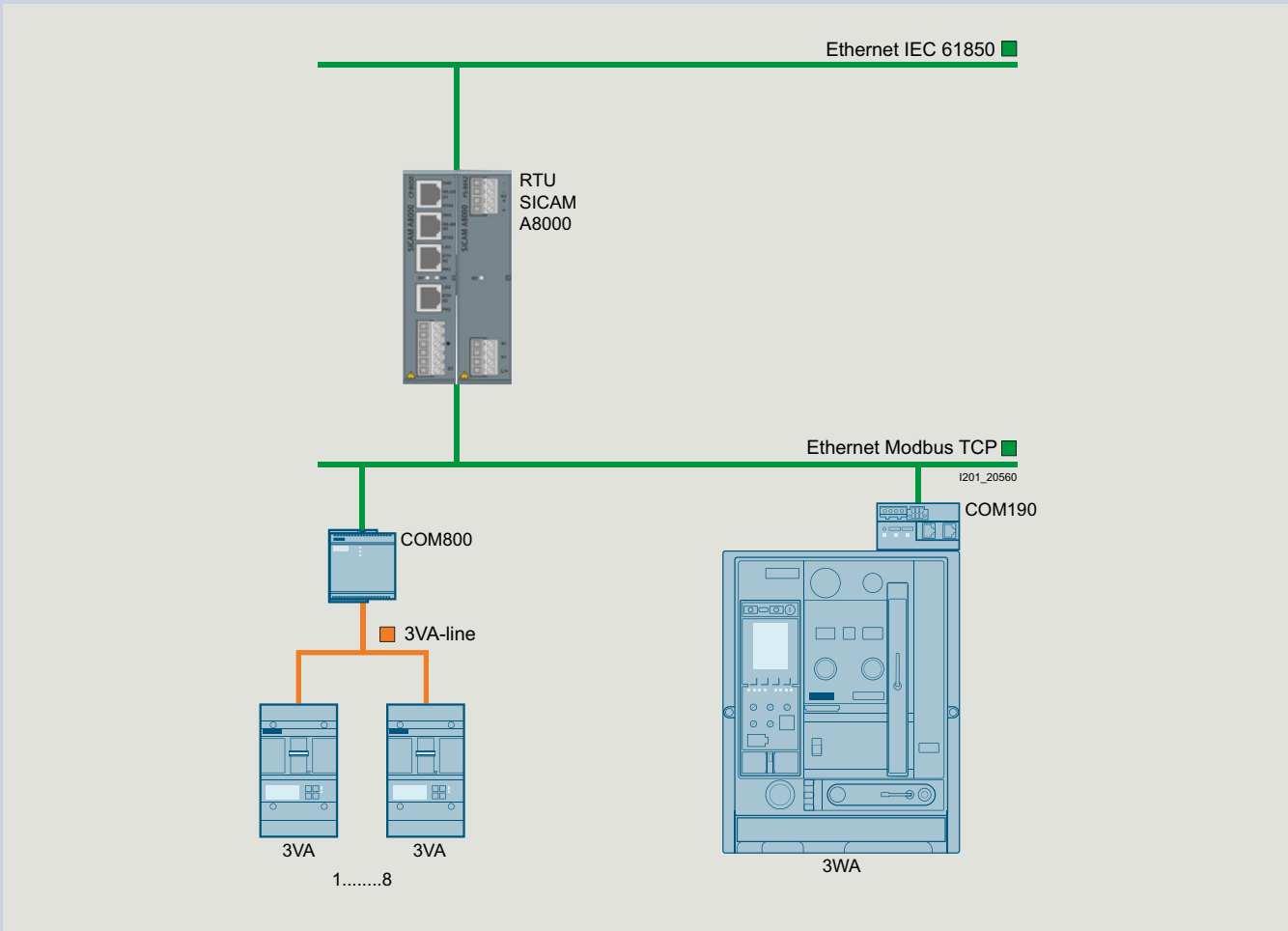
³⁾ Dimensioned for device quantities of 3× 3WA and 8× 3VA or 2× 3WA and 8× 3VA and 1× PAC4200

You will find further information at:

www.siemens.com/sicam-a8000










For the SICAM CP-8021, SICAM CP-8031 and SICAM CP-8050, predefined modules were created to reduce commissioning work to a minimum.

The modules can be obtained free of charge via SiePortal www.siemens.com/lowvoltage/product-support (109816057).




Communication

Accessories for communication

T-connectors (spare part)			
	Use		Article No.
	Provides a stub connection to the COM060 and loops through to the next circuit breaker.		3VA9987-0TG10
DIN-rail adapters			
	Use		Article No.
	For snapping the T-Connector onto a DIN rail.		3VA9987-0TG11
Prefabricated connecting cables, T-connector – T-connector or T-connector – COM800/COM100			
	Length		Article No.
	0.4 m		3VA9987-0TC10
	1 m		3VA9987-0TC20
	2 m		3VA9987-0TC30
	4 m		3VA9987-0TC40
Prefabricated connecting cables for extending the COM060 – T-connector stub connection			
	Length		Article No.
	0.4 m		3VA9987-0TF20
	0.8 m		3VA9987-0TF10
Additional bus terminating resistors (spare part)			
	Use		Article No.
	For COM800 and COM060		3VA9987-0TE10
Voltage tap to external N conductors (spare part)			
	Use		Article No.
	Cable for connection of the star point for the metering function of the 8-series ETU, length 1.5 m		3VA9987-0UC10
External current transformer for N conductors			
	Use	Rated current	Article No.
	For 3VA2 3-pole molded case circuit breakers, for 5 and 8-series ETUs, including connecting cables	25 ... 150 A	3VA9007-0NA10
		160 ... 350 A	3VA9107-0NA10
		400 ... 630 A	3VA9307-0NA10
External current transformers as straight-through transformers			
	Rated current		Article No.
	25 ... 150 A		3VA9077-0NA10
	160 ... 350 A		3VA9177-0NA10
	400 ... 630 A		3VA9377-0NA10
	600 ... 1250 A		3VA9677-0NA10
Connecting cables for external current transformers for N conductors (spare part)			
			Article No.
			3VA9907-0NB10

Display

DSP800 displays		
	Use	Article No.
	For displaying the status and measured values of up to eight devices	3VA9987-0TD10
	<ul style="list-style-type: none"> • 3VA2 via COM800/100 • 3VA27 • 3WL10 • 3WL11-13 • PAC3200T 	

External function box

EFB300 external function boxes



- 4 digital outputs for information output
- 1 digital input
- ZSI functionality
- S0 interface
- Including cable 1.5 m in length

Use	Article No.
For connection to the ETU of 3VA2 molded case circuit breakers	3VA9987-0UA10

Connecting cables for EFB300



Length	Use	Article No.
1.5 m	For 3VA2 with EFB	3VA9987-0UB10
3.0 m	For 3VA2 with EFB	3VA9987-0UB20
	For 3VA2 with EFB and RCD820	3VA9987-0UB30

Test devices

TD300 test devices



Use	Connection	Article No.
For activation of the ETU and initiation of a test tripping operation	On the front interface of the ETU	3VA9987-0MA10

TD400 test devices ¹⁾



- Energy supply via batteries or the USB-C interface
- USB-C interface for connecting a PC with SENTRON Powerconfig
- Bluetooth interface for connection to a PC, smartphone or tablet
- ETU parameterization
- Including adapter and connecting cable to 3VA2 molded case circuit breaker and IEC 3WL (ETU release 2)
- Including case

Use	Connection	Article No.
Initiation of a test tripping operation	On the front interface of the ETU (3VA and IEC 3WL ETU release 2)	3VW9011-0AT40

TD500 test devices



- USB interface for connecting a PC with SENTRON Powerconfig
- Including external power supply
- Including connecting cable to 3VA2 molded case circuit breaker

Use	Connection	Article No.
Initiation of various test tripping operations (LSING), ETU parameterization	On the front interface of the ETU	3VA9987-0MB10

External power supplies for TD500 (spare part)



Voltage	Article No.
110 ... 240 V	3VA9987-0MX10

Connecting cables for connecting TD500 to 3VA2 molded case circuit breakers (spare part)



Article No.
3VA9987-0MY10

¹⁾ A country-specific radio license is required to operate the Bluetooth interface. Before activating the Bluetooth function, ensure that the license is available: www.siemens.com/lowvoltage/certificates

Locking, blocking and interlocking

3VA20

3VA21

3VA22

3VA11

3VA12

Locking

- The locking provisions make it possible to lock the 3VA molded case circuit breakers in either the OFF or the ON operating position.

Version

Cylinder lock	Key 1 (lock number 1)	3VA9980-0VL10
	Key 3 (lock number 3)	3VA9980-0VL30
	Key 4 (lock number 4)	3VA9980-0VL40

Adapter kit for mounting the cylinder lock (type RONIS) in the accessories compartment of the molded case circuit breaker	3VA9157-0LF10	3VA9257-0LF10	3VA9167-0LF10
---	---------------	---------------	---------------

Locking provision for handle operating mechanism	3VA9088-0LB10	3VA9388-0LB10
--	---------------	---------------



Interlocking

- Using interlocking technology, it is possible to mutually interlock two or more molded case circuit breakers.
- The interlock system is designed to ensure that no more than one molded case circuit breaker can be operated at a time.
- The following methods of interlocking can be used on 3VA molded case circuit breakers:
 - Front interlock
 - Rear interlock

Version

Cylinder lock	Key 1 (lock number 1)	3VA9980-0VL10
	Key 3 (lock number 3)	3VA9980-0VL30
	Key 4 (lock number 4)	3VA9980-0VL40

Sliding bar interlock	3VA9158-0VF30	3VA9258-0VF30	3VA9168-0VF30
-----------------------	---------------	---------------	---------------

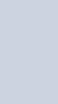
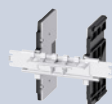
Handle interlocking module with Bowden cable	3VA9157-0VF10	3VA9257-0VF10	3VA9167-0VF10
--	---------------	---------------	---------------

Bowden cable	Length 0.6 m	3VA9980-0VC10
	Length 1.0 m	3VA9980-0VC20
	Length 1.5 m	3VA9980-0VC30

Rear interlock with rod	Circuit breaker, fixed-mounted	3VA9088-0VM10
	Plug-in/withdrawable technology	3VA9088-0VM30

Mounting frame for rear interlock with rod	Mounting rails	3VA9088-0VK10
--	----------------	---------------

Mounting plate	3VA9158-0VK20	3VA9258-0VK20	3VA9268-0VK20
----------------	---------------	---------------	---------------



¹⁾ With mounting frame for rear interlock.

Can be used with breaker 3VA15 from "E02" and 3VA25 from "E05" (Line protection CB with TMTU, 3-Series ETU and 5-Series ETU)

3VA13	
3VA14	3VA15
3VA23	3VA25
3VA24	3VA26

Locking

Use in	Locking in OFF position	Locking in ON position	Front mounting	Rear mounting	Interlocked breakers
3VA9980-0VL10 3VA9980-0VL30 3VA9980-0VL40	■	■	■	–	–
3VA9367-0LF10 3VA9587-0LF10	■	■	■	–	–
3VA9388-0LB10 3VA9588-0LB10	■	■	■	–	–

Interlocking

Use in	Locking in OFF position	Locking in ON position	Front mounting	Rear mounting	Interlocked breakers
3VA9980-0VL10 3VA9980-0VL30 3VA9980-0VL40	■	■	■	–	Unlimited
3VA9368-0VF30 –	–	–	■	–	3
3VA9367-0VF10 3VA9587-0VF10	–	–	■	–	3
3VA9980-0VC10 3VA9980-0VC20 3VA9980-0VC30					
3VA9088-0VM10 3VA9588-0VM10 ¹⁾ 3VA9088-0VM30 –	–	–	–	■	2
3VA9088-0VK10 –	–	–	–	■	
3VA9468-0VK20 –					

Cover frame and mounting

2

3VA10

3VA11

3VA12

Cover frames for door cut-outs for molded case circuit breakers

Number of poles	Door cut-out with trip unit		
		3VA10	3VA12
3P	No	3VA9053-OSB10	3VA9253-OSB10
	Yes	3VA9053-OSB20	3VA9253-OSB20
4P	No	3VA9054-OSB10	3VA9254-OSB10
	Yes	3VA9054-OSB20	3VA9254-OSB20

Cover frames for motor operators

Use		
MO320 motor operator	3VA9053-OSB20	3VA9257-OSB30
Motor operator with SEO520 stored energy mechanism	–	–

Cover frames for RCD320, RCD520 and RCD820 residual current devices

Number of poles		
3P	3VA9053-OSB10	3VA9253-OSB10
4P	3VA9054-OSB10	3VA9254-OSB10

Cover frames for front mounted rotary operators

	3VA9053-OSB10	3VA9253-OSB10
--	---------------	---------------

Cover frames for door feedthroughs

	–	3VA9253-OSB20
--	---	---------------

Labeling plates for cover frame

		3VA9087-OSX10
--	--	---------------

DIN-rail adapter for 3VA1 molded case circuit breakers

Number of poles		
1P	3VA9181-OSH10 ¹⁾	–
2P	3VA9182-OSH10	–
3P and 4P	3VA9187-OSH10	–
3P and 4P in connection with RCD310 or RCD510	3VA9187-OSH20	–

Mounting screw kits

Use	Number of poles		
For fixed-mounted circuit breakers	1P	3VA9111-OSS10	–
	2P and 3P (apart from 125 A/160 A with 55 kA and 70 kA)	3VA9116-OSS10	
	3P (125 A/160 A with 55 kA and 70 kA) and 4P	3VA9114-OSS10	
	3P	–	–
	4P	–	–
	3P and 4P	–	–
For plug-in units	–	3VA9114-OSS10	
For plug-in and withdrawable technology	–	–	3VA9114-OSS10

¹⁾ For 1-pole 3VA11 molded case circuit breakers up to 25 kA

Adapters for 60 mm busbar system (8US), [see page 13/26](#)

	3VA13	
3VA20	3VA14	3VA15
3VA21	3VA23	3VA25
3VA22	3VA24	3VA26
3VA9163-0SB10	3VA9383-0SB10	3VA9503-0SB10
3VA9163-0SB20	3VA9363-0SB20	3VA9503-0SB20
3VA9164-0SB10	3VA9384-0SB10	3VA9504-0SB10
3VA9164-0SB20	3VA9364-0SB20	3VA9504-0SB20
3VA9257-0SB30	3VA9377-0SB30	–
3VA9167-0SB30	3VA9377-0SB30	–
3VA9253-0SB10	3VA9303-0SB40	–
3VA9254-0SB10	3VA9304-0SB40	–
3VA9163-0SB10	3VA9383-0SB10	3VA9503-0SB50
3VA9253-0SB20	3VA9353-0SB20	–
3VA9087-0SX10		
–	–	–
–	–	–
–	–	–
–	–	–
–	–	–
–	–	–
–	–	–
3VA9126-0SS10	–	–
3VA9124-0SS10	–	–
–	3VA9328-0SS10	3VA9517-0SS10
–	–	3VA9603-0SS10
3VA9124-0SS10	3VA9328-0SS10	–

System overview

For a complete and valid configuration of your molded case circuit breaker, please use our online configurator at www.siemens.com/lowvoltage/3va27-configurator

Molded case circuit breakers

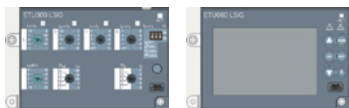


Handle



Stored energy mechanism

Trip units



Electronic trip unit (ETU)

Accessories



Communications module



Rating plugs



Breaker Connect module



Test devices and breaker data adapters

Main conductor connections

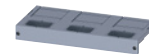
Rear vertical/
horizontalRear
broadenedFront
extendedFront
broadened

Cable lug

Accessories



Phase barriers



Terminal cover

Motors

Spring charging
motor

Accessories



Mechanical operating cycles counter (MOC)

Auxiliary releases/closing coils

Undervoltage release (UVR)/
Shunt trip (ST)Closing coil (CC)/
Remote reset magnet (RR)

Note:

You will find a detailed range of accessories in the Accessories and spare parts section.

Auxiliary switches



Trip alarm switch



Ready-to-close
signaling switch (RTC)



Auxiliary switch
ON/OFF (AUX)

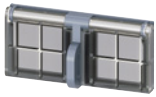


Trip alarm switch
(S24)



Trip alarm switch
(TAS)

Other accessories



Interlocking sets



Locking provision



Locking mechanism



Door sealing frame



Protective cover



Mechanical
interlock



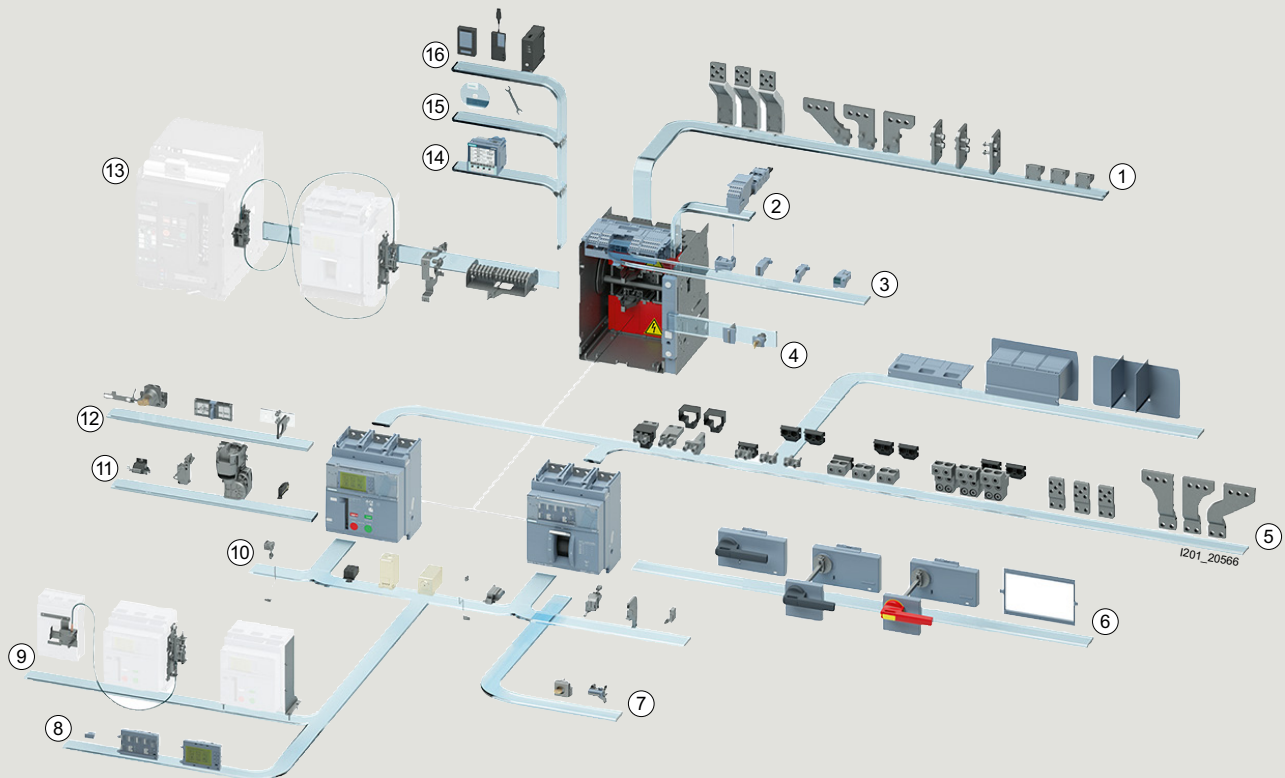
Manual operator

Note:

You will find a detailed range of accessories in the Accessories and spare parts section.

System overview

2



- | | |
|---|--|
| ① Connection technology for guide frame | ⑩ Auxiliary and alarm switches/auxiliary releases |
| ② Position signaling switch | ⑪ Spring charging motor and accessories |
| ③ Communication modules | ⑫ Accessories for locking, blocking, and interlocking for synchronizable spring charging motor (SEO) |
| ④ Locking for guide frame | ⑬ Interlocking for guide frame/external accessories |
| ⑤ Connection technology for fixed-mounted circuit breaker | ⑭ DSP800 display |
| ⑥ Manual operators | ⑮ SENTRON Powerconfig software |
| ⑦ Sliding bar interlock | ⑯ Test devices |
| ⑧ Electronic trip units (ETUs) | |
| ⑨ Interlocking for fixed-mounted circuit breaker | |

3VA27 6 7 8 9 10 11 12 13 14 15 16

Alarm switch combinations

Alarm switches	Without	0
	With trip alarm switch TAS and trip alarm switch S25	1
	With two leading changeover switches S26	2
	With trip alarm switch TAS and trip alarm switch S25 and two leading changeover switches S26	3

Auxiliary releases, closing coils

Closing coil (CC), remote reset magnet (RR)	Without	A
---	---------	---

2nd auxiliary release	Without 2nd auxiliary release		A	
	With undervoltage release (UVR)	24 V AC/DC		B
		30 V AC/DC		C
		48 V AC/DC		D
		60 V AC/DC		E
		110 ... 120 V AC/DC		F
		120 ... 127 V AC/DC		G
		220 ... 240 V AC/DC		H
		240 ... 250 V AC/DC		J
	With undervoltage release (UVR), delayable with external time-delay device Scope of supply: UVR + time-delay device	380 ... 400 V AC/DC		K
		415 ... 440 V AC/DC		L
	With 2nd shunt trip (ST2)	24 ... 30 V AC/DC		M
		110 ... 127 V AC/DC		N
		220 ... 250 V AC/DC		P
		24 V AC/DC		Q
		30 V AC/DC		R
48 V AC/DC			S	
	60 V AC/DC		T	
	110 ... 120 V AC/DC		U	
	120 ... 127 V AC/DC		V	
	220 ... 240 V AC/DC		W	
240 ... 250 V AC/DC		X		

1st auxiliary release	Without 1st auxiliary release		0
	Shunt trip (ST)	24 V AC/DC	1
		30 V AC/DC	2
		48 V AC/DC	3
		60 V AC/DC	4
		110 ... 120 V AC/DC	5
		120 ... 127 V AC/DC	6
		220 ... 240 V AC/DC	7
240 ... 250 V AC/DC	8		

Structure of the article numbers

Basic configuration with stored energy mechanism

The structure shown below is intended as an overview of each position and its meaning. For a complete and valid configuration of your molded case circuit breaker, please use our online configurator at www.siemens.com/lowvoltage/3va27-configurator

2

3VA27 6 7 8 9 10 11 12 13 14 15 16

Molded case circuit breakers and ETUs

Max. rated current	800 A																
$I_{n\max}$	1000 A	8	0														
	1250 A	1	0														
	1600 A	1	2														
		1	6														
Short-circuit breaking capacity	Stored energy mechanism	55 kA															
$I_{cu} = I_{cs}$ at 415 V		85 kA															
		110 kA															
Molded case switches	Without metering function, without communications interface	Without trip unit															
									A	A							
Circuit breakers, ETU 3-series	Without metering function, without communications interface	With trip unit	ETU320 LI	(N) ¹⁾					A	B							
			ETU350 LSI	(N) ¹⁾					A	C							
			ETU360 LSIG	(N) ¹⁾					A	D							
Circuit breakers, ETU 6-series		With trip unit	ETU650 LSI	(N) ¹⁾						E							
			ETU660 LSIG	(N) ¹⁾						F							
	Without a communications interface	Without metering function							A								
	With a communications interface	Without metering function							B								
		Metering function Basic	Voltage tap on bottom						C								
			Voltage tap on top						D								
		Metering function Advanced	Voltage tap on bottom						E								
			Voltage tap on top						F								

¹⁾ Neutral conductor protection for 3-pole breakers with an external neutral conductor transformer or 4-pole breakers

Number of poles	Fixed-mounted	3-pole																0
		4-pole	Neutral left															1
			Neutral right															2
	Withdrawable	3-pole																3
		4-pole	Neutral left															4
			Neutral right															5

Connections

Type of mounting	Withdrawable	Withdrawable circuit breaker without guide frame (guide frame must be ordered separately)																	0
	Fixed-mounted breaker/withdrawable breaker	Rear vertical connection																	1
		Rear horizontal connection																	2
		Front main connection																	3
		Front-accessible, extended main connection																	5
		Front-accessible, broadened main connection																	6
		Rear broadened bus connectors																	7

Motor

Operating mechanisms	Manual operator																		0
	Spring charging motor	24 ... 30 V AC/DC																	1
		48 ... 60 V AC/DC																	2
		110 V AC/DC																	3
		230 V AC/DC																	4

3VA27 6 7 8 9 10 11 12 13 14 15 16

Auxiliary releases, closing coils, remote reset magnets

Closing coil (CC), remote reset magnet (RR)	Without		A
	Closing coil (CC)	24 V AC/DC	B
		30 V AC/DC	C
		48 V AC/DC	D
		60 V AC/DC	E
		110 ... 120 V AC/DC	F
		120 ... 127 V AC/DC	G
		220 ... 240 V AC/DC	H
		240 ... 250 V AC/DC	J
	Closing coil (CC) and additional remote reset magnet (RR)	24 V AC/DC	K
110 V AC/DC		L	
220 V AC/DC		M	
2nd auxiliary release	Without 2nd auxiliary release		A
	With undervoltage release (UVR)	24 V AC/DC	B
		30 V AC/DC	C
		48 V AC/DC	D
		60 V AC/DC	E
		110 ... 120 V AC/DC	F
		120 ... 127 V AC/DC	G
		220 ... 240 V AC/DC	H
		240 ... 250 V AC/DC	J
		380 ... 400 V AC/DC	K
		415 ... 440 V AC/DC	L
	With undervoltage release (UVR), delayable with external time-delay device Scope of supply: UVR + time-delay device	24 ... 30 V AC/DC	M
		110 ... 127 V AC/DC	N
		220 ... 250 V AC/DC	P
	With 2nd shunt trip (ST2)	24 V AC/DC	Q
		30 V AC/DC	R
		48 V AC/DC	S
		60 V AC/DC	T
		110 ... 120 V AC/DC	U
		120 ... 127 V AC/DC	V
220 ... 240 V AC/DC		W	
240 ... 250 V AC/DC		X	
1st auxiliary release	Without 1st auxiliary release		0
	Shunt trip (ST)	24 V AC/DC	1
		30 V AC/DC	2
		48 V AC/DC	3
		60 V AC/DC	4
		110 ... 120 V AC/DC	5
		120 ... 127 V AC/DC	6
		220 ... 240 V AC/DC	7
		240 ... 250 V AC/DC	8

Accessory options

For a complete and valid configuration of your molded case circuit breaker, please use our online configurator at www.siemens.com/lowvoltage/3va27-configurator

To specify the options, add "-Z" to the complete article number and indicate the appropriate order code(s).

3VA27..-.....-.... -Z

Order code

Accessories for basic configuration

Mounting options for fixed-mounted circuit breakers

- In the basic configuration, the fixed-mounted circuit breaker is mounted onto the rear panel. Floor mounting is possible as an option. The device must additionally be modified if it is to be extended to include functionalities such as external auxiliary switches or mechanical interlocking mechanism.¹⁾

Mounting options for fixed-mounted circuit breakers ¹⁾						Order code
	Floor mounting	Mounting support standard				A07
		Mounting support extended ²⁾				S56
	Rear panel mounting onto mounting plate	Side wall extended ²⁾				S57

Accessories for electronic trip units ETU

Rating plugs

- As standard, the electronic trip units are equipped with a rating plug for setting the rated current I_{nr} , which is equal to the maximum rated circuit breaker current ($< I_{n,max}$). The rated current of the selected rating plug must be less than or equal to $I_{n,max}$.
- To downrate the circuit breaker, a rated current smaller than $I_{n,max}$ is selected for the rating plug via a Z option.
- Other functions can also be activated using rating plugs (L = OFF or Rc protection).

Rating plug						Order code	
For setting the rated current I_{nr}	For all ETUs	400 A				B04	
		630 A				B06	
		800 A				B08	
		1000 A				B10	
		1200 A				B12	
	For setting the rated current I_{nr} , with overload protection L = OFF	For 6-series ETUs	400 A				L04
			630 A				L06
			800 A				L08
			1000 A				L10
			1250 A				L12
			1600 A				L16
For setting the rated current I_{nr} , For enabling the residual current protective function. The residual current function is only possible with the MF Advanced metering function.	For ETU660 only	400 A				G04	
		630 A				G06	
		800 A				G08	
		1250 A				G12	

Communications modules

- Up to 2 different communication modules can be used at the same time.
- When using an IOM040 digital I/O module (Z option K56), only 1 communication module can be used.

Communications modules						Order code
COM040	PROFIBUS					F02
COM041	PROFINET					F03
COM043	Modbus TCP					F11
COM042	Modbus RTU					F12

Breaker Connect modules

- When a circuit breaker with a communications interface is ordered, a Breaker Connect module for external 24 V DC power supply of the electronic components is also supplied ready installed as standard.
- By means of this Z option, the Breaker Connect module for 24 V DC is replaced by a Breaker Connect module for 110–240 V AC/DC.

Breaker Connect module						Order code
110 ... 240 V AC/DC						F26

I/O modules internal

I/O modules internal						Order code
IOM040 digital I/O module	2 inputs, 2 outputs					K56

For molded case circuit breakers with stored energy mechanism

¹⁾ These functionalities can be applied directly to the frame of the withdrawable circuit breaker, without any modification of the side wall.

For molded case circuit breakers with handle operating mechanism

²⁾ Not possible in connection with or as an alternative to the mounting support, standard (A07).

To specify the options, add "-Z" to the complete article number and indicate the appropriate order code(s).

3VA27..-.....-.... -Z

Order code

2

Accessories for motors

Mechanical operating cycles counter, 5-digit					C01
--	--	--	--	--	-----


Auxiliary switches and signaling switches


- Auxiliary and signaling switches for currents > 100 mA and up to 400 V AC are installed as standard.
- For currents < 100 mA for PLC connections, these auxiliary and signaling switches can be replaced.
- The auxiliary/signaling switches for 24 V DC digital signals are designed for
 - a minimum load above 1 mA at 5 V DC, and
 - a maximum breaking capacity of 100 mA at 24 V DC.

Position signaling switches for guide frames ¹⁾		2 CO 2 CO 2 CO (connected test disconnected position)			K55
Signaling switch	Ready-to-close signaling switch	1 CO digital 24 V DC			K50
	Trip alarm switch (S24)	1 CO digital 24 V DC			K53
	Spring charge signaling switch (S21)	1 CO digital 24 V DC			K54
Auxiliary switch	On/Off AUX	4 CO digital 24 V DC			K51
		2 CO 400 V AC, and 2 CO digital 24 V DC			K52

Locking, blocking and interlocking

Locking provisions ¹⁾	To prevent movement of the withdrawable circuit breaker	Cylinder lock	Made by RONIS		R78
		For no more than 3 padlocks, 8 mm			R65
Locking mechanism	To prevent movement to disconnected position				R79
Locking provision	Against unauthorized closing in the operator panel (safe OFF)	Cylinder lock, made by RONIS			S08
		For no more than 3 padlocks, plastic 4 mm			S22
		For no more than 1 padlock, metal 7 mm			S23
		For no more than 2 padlocks, metal 8 mm			S07
Interlocking set	For mechanical ON and/or OFF on the operator panel	For no more than 3 padlocks, plastic 4 mm			S42
		For no more than 1 padlock, metal 7 mm			S43
		For no more than 2 padlocks, metal 8 mm			S44
Protective cover	For mechanical ON/OFF, not lockable				S41
Door sealing frame IP30	IP3x				T30

 For molded case circuit breakers with stored energy mechanism

 For molded case circuit breakers with handle operating mechanism

¹⁾ Can be used both for individual orders of the guide frame and complete orders (circuit breaker + guide frame).

Guide frames

3VA27

Guide frames for ordering separately without circuit breakers



- Guide frames without breakers up to 1600 A
- **Note:** All CB bus modules for communication COM04x/IOM300/Breaker Connect module, as well as COMPSS signaling switches are configured without frames in the withdrawable circuit breaker and defined there by means of Z options, and are included with the breaker. PSS Standard is always included in the frame and can be changed to an electronics-capable signal by means of a Z option.

Number of poles	Connection type	Article No.
3-pole	Rear vertical	3VW8116-7AA01
	Rear horizontal	3VW8116-7AB01
	Front straight bus connectors extended	3VW8116-7AE01
	Broadened bus connectors	3VW8116-7AF01
	Rear broadened bus connectors	3VW8116-7AG01
4-pole	Rear vertical	3VW8116-7BA01
	Rear horizontal	3VW8116-7BB01
	Front straight bus connectors extended	3VW8116-7BE01
	Broadened bus connectors	3VW8116-7BF01
	Rear broadened bus connectors	3VW8116-7BG01

To specify the options, add "-Z" to the complete article number and indicate the appropriate order code(s).

3VW8....-.....-..... -Z

Order code

Locking, blocking and interlocking

Locking provision	To prevent movement of the withdrawable circuit breaker	Cylinder lock, made by RONIS	☒	☒	R78
		For no more than 3 padlocks, 8 mm	☒	☒	R65
Locking mechanism	To prevent movement to disconnected position (only in combination with R78 or R65)		☒	☒	R79

Auxiliary/signaling switches

Position signaling switch PSS for guide frame	For 24 V DC digital signals, for minimum currents	2 CO 2 CO 2 CO (connected test disconnected position)	☒	☒	K55
---	---	---	---	---	-----

Auxiliary and signaling switches for currents > 100 mA and up to 400 V AC are installed as standard. For currents < 100 mA for PLC connections, these auxiliary and signaling switches can be modified. The auxiliary/signaling switches for 24 V DC digital signals are designed for

- a minimum load above 1 mA at 5 V DC, and
- a maximum breaking capacity of 100 mA at 24 V DC.

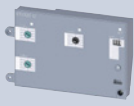

☒ For molded case circuit breakers with stored energy mechanism

☒ For molded case circuit breakers with handle operating mechanism


Electronic trip unit ETU and accessories

3VA27


Electronic trip units (ETU)

Version	With communications/ metering function, enhanced protective functions	Type	Protective function	Article No.	
	With rotary coding switches	No	ETU320	LIN	3VW9011-5AA00
			ETU350	LSIN	3VW9012-5AA00
			ETU360	LSING	3VW9012-7AA00
	With display	Yes	ETU650	LSIN	3VW9017-5AA00
			ETU660	LSING	3VW9017-7AA00

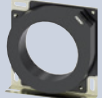
Metering functions for ETU650 or ETU660

Description	Protective function/version	Arrangement	Article No.
	Metering function	MF Basic	– 3VW9011-0AT01
		MF Advanced	– 3VW9011-0AT04
Set of cables for voltage tap for MF	For 4-pole circuit breakers with N conductor right	Top or bottom	3VW9011-0AT08
		Top	3VW9011-0AT75
	Bottom	3VW9011-0AT76	
	For 4-pole circuit breakers with N conductor left	Top	3VW9011-0AT72
		Bottom	3VW9011-0AT73

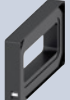
External current transformers for N conductors

Accessory for	Use	Article No.
 ETU320, ETU350, ETU360, ETU650, ETU660	Only for 3-pole circuit breakers	3VW9011-0AA30


External current transformers for grounded transformer neutral points

Accessory for	G_{ret} (Ground return)	Article No.
 ETU660	100 A	3VW9011-0GF30
	250 A	3VW9011-0GF31


Summation current transformers external Rc-CT for residual current measurement

Accessory for	Use	Article No.
 ETU660	<ul style="list-style-type: none"> Only with MF Advanced metering function and Rc rating plug 	
	For external residual current measurement	3VW9011-0RC30

Remote reset magnets RR for the circuit breakers including tripped signaling

Accessory for	Voltage	Article No.
 ETU320, ETU350, ETU360, ETU650, ETU660	24 V DC	– 3VW9011-0AK03
	110 V AC/DC	– 3VW9011-0AK05
	250 V AC/DC	– 3VW9011-0AK06

Spare part batteries for electronic trip unit ETU

Accessory for	Article No.
 ETU320, ETU350, ETU360, ETU650, ETU660	3VW9011-0AT38

For molded case circuit breakers with stored energy mechanism

For molded case circuit breakers with handle operating mechanism

































Electronic trip unit ETU and accessories

3VA27

Rating plugs



- Only one module is possible per circuit breaker.

Accessory for	Version	Rated current I_n	Article No.
ETU320, ETU350, ETU360, ETU650, ETU660	Rating plugs for setting ($< I_{n\max}$) the rated current I_n	400 A  	3VW9011-0AA53
		630 A  	3VW9011-0AA55
		800 A  	3VW9011-0AA56
		1000 A  	3VW9011-0AA57
		1250 A  	3VW9011-0AA58
		1600 A  	3VW9011-0AA61
ETU 6-series	Rating plug without overload protection (L = OFF) and for setting ($< I_{n\max}$) the rated current I_n	400 A  	3VW9011-0LF53
		630 A  	3VW9011-0LF55
		800 A  	3VW9011-0LF56
		1000 A  	3VW9011-0LF57
		1250 A  	3VW9011-0LF58
		1600 A  	3VW9011-0LF61
ETU660	Rating plug Rc for ETU660 for enabling of the residual current protective function and setting ($< I_{n\max}$) of the rated current I_n . A residual current function is only possible with the MF advanced metering function.	400 A  	3VW9011-0RC53
		630 A  	3VW9011-0RC55
		800 A  	3VW9011-0RC56
		1250 A  	3VW9011-0RC58

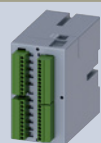
CB bus modules - communications modules





- Contains the communications module
- Up to 2 different communications modules can be used at the same time.
- When using a digital I/O module IOM040 (Z option K56), only 1 communications module can be used.
- Can only be used with ETU of the 6-series and require a Breaker Connect module for connection to the circuit breaker. This can also be configured directly on the device by means of a Z option if the communications interface to the ETU 6-series is selected.

Communications module	Protocol	Article No.
COM040	PROFIBUS  	3VW9011-0AT15
COM041	PROFINET  	3VW9011-0AT14
COM043	Modbus TCP  	3VW9011-0AT16
COM042	Modbus RTU  	3VW9011-0AT17

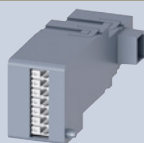
CB bus modules - I/O modules external IOM300



- For snapping onto DIN rail


Accessory for	Maximum switching current per contact	Inputs	Outputs	Article No.
ETU 6-series	<ul style="list-style-type: none"> 2 A at ≤ 30 V DC 0.8 A at 50 V DC 0.2 A at 150 V DC 4 A at 250 V AC 	11	10  	3VW9011-0AT20


CB bus modules - I/O modules internal IOM040



- When using a digital I/O module IOM040, only 1 communication module can be used.

Accessory for	Maximum switching current per contact	Inputs	Outputs	Article No.
ETU 6-series	<ul style="list-style-type: none"> 2 A at ≤ 30 V DC 0.8 A at 50 V DC 0.2 A at 150 V DC 4 A at 250 V AC 	2	2  	3VW9011-0AT30

 For molded case circuit breakers with stored energy mechanism

 For molded case circuit breakers with handle operating mechanism

3VA27

Actuator modules COM ACT



- For switching the circuit breaker on/off remotely via communication.
- Actuation of the closing coil (CC) and the 1st shunt trip (ST).
- Can only be used in combination with a communications module, spring charging motor, closing coil and 1st shunt trip.
- Automatically included if the communications interface of the ETU 6-series is selected in the basic circuit breaker configuration.

Accessory for

ETU 6-series



-

Article No.

3VW9011-0AT10

Breaker Connect modules



- For external power supply for the electronics components

Voltage

110 ... 240 V AC/DC



Article No.

3VW9011-0AT06

24 ... 48 V DC



3VW9011-0AT07

Auxiliary contact signals for communications interface



- Auxiliary contacts for signaling the readiness to close or for position signaling switches of the withdrawable positions.
- Can only be used in combination with communications module.
- Can be combined with standard position signaling switches or ready-to-close signaling contacts.
- **Note:** Both signaling switches are automatically included in the basic circuit breaker (COM PSS only with withdrawable versions) if the communications interface of the ETU 6-series is selected.

Function

Ready-to-close signaling switch for communication (COM RTC)



-

Article No.

3VW9011-0AT11

Position signaling switch COM PSS (for withdrawable breaker only)



3VW9011-0AT12

Test devices and breaker data adapters



- Usable for all ETU 3-series and 6-series

Description

Test device

Type

TD310



Article No.

3VW9011-0AT32

- For the trip test via ETU and tripping solenoid including release
- Activation of the ETU and the tripping solenoid by means of a battery built into the test device
- On activation in the ETU 6-series, the parameters can be configured on the display

Breaker data adapter

TD410



3VW9011-0AT34

- As gateway for parameterization of the ETU with SENTRON Powerconfig
- For generation of a report of the set parameters with powerservice

Test device and breaker data adapter

TD420



3VW9011-0AT33

- As gateway for parameterization of the ETU with SENTRON Powerconfig
 - Testing a tripping operation using SENTRON Powerconfig
- For use with the powerservice software
 - Testing of the basic protective functions LSING
 - Testing of the enhanced protective functions
 - Test data storage
 - Readout of ETU buffer
 - Generation of a report of the set parameters



For molded case circuit breakers with stored energy mechanism



For molded case circuit breakers with handle operating mechanism























2

Accessories for connection and insulation

3VA27













Front main connections acc. to IEC 60947-2

- Acc. to IEC 60947-2 for 3VA27 up to 1600 A (depending on application conditions)
- To be ordered separately for top and bottom

Mounting	Version	Mounting onto	Number of poles/quantity		Article No.	
Fixed-mounted	Front main connections	–	3-pole/3 units	 	3VW9011-0AL01	
			4-pole/4 units	 	3VW9011-0AL02	
	Extended main terminals, including insulation plate and phase barriers, standard	Front main connections	3-pole/3 units	 	3VW9011-0AL77	
			4-pole/4 units	 	3VW9011-0AL78	
	Broadened main terminals, including insulation plate and extended phase barriers	Front main connections, top	Front main connections, top	3-pole/3 units	 	3VW9011-0AL73
				3-pole/3 units	 	3VW9011-0AL75
4-pole/4 units				 	3VW9011-0AL74	
Withdrawable	Front-accessible terminals for main circuit connection	Guide frame flange	3-pole/3 units	 	3VW9011-0AN01	
			4-pole/4 units	 	3VW9011-0AN02	
	Broadened main circuit connections	Front-accessible terminals for main circuit connection	3-pole/3 units	 	3VW9011-0AN73	
			4-pole/4 units	 	3VW9011-0AN74	









Rear terminals for main circuit connections acc. to IEC 60947-2

- Acc. to IEC 60947-2 for 3VA27 up to 1600 A (depending on application conditions)
- To be ordered separately for top and bottom


Mounting	Version	Mounting onto	Number of poles/quantity		Article No.
Fixed-mounted	Rear terminals for main circuit connection, rotatable for horizontal/vertical connection, including terminal cover	–	3-pole/3 units	 	3VW9011-0AL32
			4-pole/4 units	 	3VW9011-0AL33
Withdrawable	Rear terminals for main circuit connection, rotatable for horizontal/vertical connection, including terminal cover	–	3-pole/3 units	 	3VW9011-0AN32
			4-pole/4 units	 	3VW9011-0AN33
	Broadened main terminals	Rear horizontal main connections	–	3-pole/3 units	 
4-pole/4 units				 	3VW9011-0AN76


Cu/Al cable connections acc. to IEC 60947-2

- Acc. to IEC 60947-2 for 3VA27 up to 1600 A (depending on application conditions)
- To be ordered separately for top and bottom

Mounting	Version	Mounting onto	Number of poles/quantity		Article No.
Fixed-mounted	Circular conductor terminals 4 × 240 mm ² for front cable connection ¹⁾ , including insulation plate and high, extended terminal cover	Front main connections	3-pole/3 units	 	3VW9011-0AL71
			4-pole/4 units	 	3VW9011-0AL72
Withdrawable	Set of circular conductor connection pieces 4 × 240 mm ² for cable lugs for rear cable connection	Rear vertical main connections	3-pole/3 units	 	3VW9011-0AN71
		–	4-pole/4 units	 	3VW9011-0AN72

¹⁾ For connecting Al cables up to 1000 A

 For molded case circuit breakers with stored energy mechanism

 For molded case circuit breakers with handle operating mechanism

3VA27

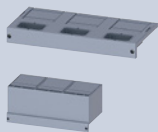
Auxiliary supply connectors in push-in version



- Control wire tap in push-in version for upgrading fixed-mounted circuit breakers and guide frames.
- The device is always fitted at the factory with the exact number of control wire taps required.

Version	Article No.
Push-in	3VW9011-0AB11

Terminal covers for fixed-mounted circuit breakers



- Finger-proof for front main connections for fixed-mounted versions
- Necessary isolation measures are always supplied with the corresponding connection technology and do not need to be ordered separately.

Version	Number of poles/quantity	Article No.
Standard	3-pole/2 units	3VW9723-0WD30
	4-pole/2 units	3VW9724-0WD40
Extended	3-pole/2 units	3VW9723-0WF30
	4-pole/2 units	3VW9724-0WF40

Phase barriers for fixed-mounted circuit breakers



- Necessary isolation measures are always supplied with the corresponding connection technology and do not need to be ordered separately.
- For operational voltages > 440 V AC the use of phase barriers is mandatory; up to 440 V AC their use is optional.

Height	Number of poles/quantity	Article No.
100 mm (standard)	3-pole/4 units	3VW9723-0WA00
	4-pole/6 units	3VW9724-0WA10
200 mm (extended)	3-pole/4 units	3VW9723-0WA01
	4-pole/6 units	3VW9724-0WA11

Supports for mounting the fixed-mounted circuit breakers on the floor



- For fixed-mounted versions only

Version	Use	Article No.
Mounting support standard (circuit breaker feet) (= Z option A07)		3VW9011-0BB51
Mounting support extended (circuit breaker feet) including mechanical transmission of switch position on circuit breaker side panel (= Z option S56)	<ul style="list-style-type: none"> • Fixation for external auxiliary switches AUX 15 CO (3VW9011-0AG15) • Locking mechanism for control cabinet door, direct (for 3VW9011-0BB10) • Locking mechanism for control cabinet door, Bowden cable (for 3VW9011-0BB16), • Mechanical interlock to 3WA/3WL/3VA (for 3VW9011-0BB21) 	3VW9011-0BB52

Extension kits for modification of the side wall of the fixed-mounted circuit breakers



- For fixed-mounted versions only
- Rear fixation on mounting plate
- For modification for mechanical transmission of switch position on circuit breaker side panel (= Z option S57)

Version	Use	Article No.
Extension kit for side wall	<ul style="list-style-type: none"> • Fixation for external auxiliary switches AUX 15 CO (3VW9011-0AG15) • Locking mechanism for control cabinet door, direct (for 3VW9011-0BB10) • Locking mechanism for control cabinet door, Bowden cable (for 3VW9011-0BB16), • Mechanical interlock to 3WA/3WL/3VA (for 3VW9011-0BB21) 	3VW9011-0BB53

For molded case circuit breakers with stored energy mechanism

For molded case circuit breakers with handle operating mechanism

2

Motor operators and manual operators

3VA27

Spring charging motor (MO)



Description	Voltage		Article No.
For automatic charging of the stored energy mechanism	24 ... 30 V AC/DC	-	3VW9011-0AF01
	48 ... 60 V AC/DC	-	3VW9011-0AF02
	100 ... 130 V AC/DC	-	3VW9011-0AF03
	220 ... 250 V AC/DC	-	3VW9011-0AF04

Mechanical operating cycles counter MOC



Description	Version		Article No.
Only possible in combination with a spring charging motor.	5 digits	-	3VW9011-0AH07

Manual operators for handle operating mechanism



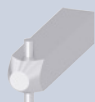
Description	Version	Color	Degree of protection		Article No.
Front mounted rotary operator incl. door sealing frame	Standard	Gray	IP30	-	3VW9727-0EK11
	EMERGENCY-OFF	Yellow-red	IP30	-	3VW9727-0EK15



Door mounted rotary operator	Standard	Gray	IP30	-	3VW9727-0FK21
	EMERGENCY-OFF	Yellow-red	IP30	-	3VW9727-0FK25



Basic without handle			IP30	-	3VW9727-0GK00
----------------------	--	--	------	---	---------------



Shaft stub			IP30	-	8UD1900-3WD00
------------	--	--	------	---	---------------



Handle	Gray	IP30	-	8UD1861-0AB11
	Yellow-red	IP30	-	8UD1861-0AB15

For molded case circuit breakers with stored energy mechanism

For molded case circuit breakers with handle operating mechanism

Auxiliary releases, closing coils

3VA27

Closing coils CC/shunt trips ST

- **Note:**
 - For molded case circuit breakers with handle operating mechanism, the products can only be used as closing shunt trips ST.
 - For molded case circuit breakers with stored energy mechanism, the products can be used as closing coils CC and shunt trips ST.



Voltage	Article No.
24 V AC/DC	3VW9011-0AD01
30 V AC/DC	3VW9011-0AD02
48 V AC/DC	3VW9011-0AD03
60 V AC/DC	3VW9011-0AD04
110 ... 120 V AC/DC	3VW9011-0AD05
120 ... 127 V AC/DC	3VW9011-0AD06
220 ... 240 V AC/DC	3VW9011-0AD07
240 ... 250 V AC/DC	3VW9011-0AD08
380 ... 400 V AC	3VW9011-0AD17
415 ... 440 V AC	3VW9011-0AD18

TD320 function test units for closing coils/shunt trips



- The TD320 test unit allows the operational availability and functions of the closing coils and shunt trips with a rated operational voltage between 24 V and 250 V (AC and DC) to be tested.
- The operational availability test is performed cyclically at intervals of 30 seconds.
- The unit has visual indicators in the form of LEDs on the front in order to display the following states:
 - LED POWER ON LIT: Correct function of the YO/YC test device
 - LED DEACTIVATION LIT: Power supply failure, wire break
 - LED SHORT-CIRCUIT LIT: Winding short-circuit
 - LED DEACTIVATION and SHORT-CIRCUIT FLASHING: Incorrect power supply
 - LED DEACTIVATION and SHORT-CIRCUIT OFF: Closing coil/shunt trips OK

Description	Article No.
For all closing coils/shunt trips	3VW9011-0AT31

Auxiliary/signaling switches



- The auxiliary/signaling switches for 24 V DC digital signals are designed for
 - a minimum load above 1 mA at 5 V DC, and
 - a maximum breaking capacity of 100 mA at 24 V DC
- For external auxiliary switches ON/OFF AUX 15 CO, a 3VW9011-0AG1x fixation must be ordered in addition, and for fixed-mounted circuit breakers a 3VW9011-0BB5x side wall modification

Description	Contacts	Article No.
Ready-to-close signal RTC	1 CO standard	3VW9011-0AH01
	1 CO digital	3VW9011-0AH02
Auxiliary switch ON/OFF AUX	4 CO standard	3VW9011-0AG01
	4 CO digital	3VW9011-0AG02
	2 CO standard + 2 CO digital	3VW9011-0AG03
External auxiliary switch ON/OFF AUX	15 CO standard	3VW9011-0AG05
	15 CO digital	3VW9011-0AG06
Trip alarm switch S24	1 CO standard	3VW9011-0AH14
	1 CO digital	3VW9011-0AH15
Spring charge signaling switch S21	1 CO standard	3VW9011-0AH10
	1 CO digital	3VW9011-0AH08
Position signaling switches PSS (only with withdrawable versions)	2 CO 2 CO 2 CO (connected test disconnected position) standard	3VW9011-0AH11
	2 CO 2 CO 2 CO (connected test disconnected position) digital	3VW9011-0AH12

For molded case circuit breakers with stored energy mechanism

For molded case circuit breakers with handle operating mechanism

Auxiliary releases, closing coils

3VA27

Auxiliary/signaling switches for handle operating mechanism



- Auxiliary and signaling switches are each offered in two versions:
 - Standard version for currents > 100 mA and up to 400/250 V AC, minimum load above 100 mA at 24 V DC, and maximum breaking capacity 5 A at 250 V AC
 - Digital version for currents < 100 mA for PLC connections, minimum load above 1 mA at 5 V DC, and maximum breaking capacity 100 mA at 24 V DC
- For external auxiliary switches ON/OFF AUX 15 CO, a 3VW9011-0AG1x fixation must be ordered in addition, and for fixed-mounted circuit breakers a 3VW9011-0BB5x side wall modification.

Description	Contacts		Article No.
Trip alarm switch TAS signals the trip position irrespective of the tripping reason	1 CO standard	–	3VW9727-0AB11
	1 CO digital	–	3VW9727-0AB13
Trip alarm switch via auxiliary release S25 signals tripping operations via auxiliary releases (UVR, ST) in UVR/ST2 pocket	1 CO standard	–	3VW9727-0AB41
	1 CO digital	–	3VW9727-0AB43
Leading changeover switch S26 (2 units)	1 NO standard, 250 V AC	–	3VW9727-0AA21

Fixation for external auxiliary switches AUX 15 CO



- External auxiliary switches ON/OFF AUX 15 CO must be ordered separately.

Version		Article No.
For fixed-mounted circuit breakers with rear panel or floor mounting (in combination with Z option S56 or S57)	☒	3VW9011-0AG15
For guide frames	☒	3VW9011-0AG17

Undervoltage releases UVR



Voltage		Article No.
24 V AC/DC	☒	3VW9011-0AE01
30 V AC/DC	☒	3VW9011-0AE02
48 V AC/DC	☒	3VW9011-0AE03
60 V AC/DC	☒	3VW9011-0AE04
110 ... 120 V AC/DC	☒	3VW9011-0AE05
120 ... 127 V AC/DC	☒	3VW9011-0AE06
220 ... 240 V AC/DC	☒	3VW9011-0AE07
240 ... 250 V AC/DC	☒	3VW9011-0AE08
380 ... 400 V AC	☒	3VW9011-0AE17
415 ... 440 V AC	☒	3VW9011-0AE18

External time-delay devices for undervoltage releases



- With adjustable delay time from 0.5 to 3 s.
- Suitable for mounting onto DIN rail.

Voltage		Article No.
24 ... 30 V AC/DC	☒	3VW9011-0AE10
48 V AC/DC	☒	3VW9011-0AE11
60 V AC/DC	☒	3VW9011-0AE15
110 ... 127 V AC/DC	☒	3VW9011-0AE12
220 ... 250 V AC/DC	☒	3VW9011-0AE13

☒ For molded case circuit breakers with stored energy mechanism

☒ For molded case circuit breakers with handle operating mechanism

Locking provisions and interlocks

3VA27

Locking provision to prevent movement of the withdrawable circuit breaker



Version	Article No.
RONIS cylinder lock (spare part for R78)	3VW9011-0BA80
Padlock 8 mm (spare part for R65), for no more than 3 padlocks	3VW9011-0BA87

Locking mechanisms to prevent movement of the withdrawable circuit breakers in disconnected position



- Only possible as a supplement in conjunction with R78 (3VW9011-0BA80) and/or R65 (3VW9011-0BA87).

Description	Article No.
Locking mechanism (spare part for R79)	3VW9011-0BA84

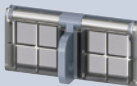
Locking provisions in OFF position



- For fixed-mounted and withdrawable versions
- Against unauthorized closing in the operator panel (safe OFF)
- The disconnecter unit fulfills the requirements for main circuit breakers according to EN 60204-1

Description	Article No.
Cylinder lock, made by RONIS (spare part for S08)	3VW9011-0BA33

Locking provisions in OFF position



- For fixed-mounted and withdrawable versions
- Against unauthorized closing in the operator panel (safe OFF)
- The disconnecter unit fulfills the requirements for main circuit breakers according to EN 60204-1

Description	Version	Article No.
Padlock 4 mm (spare part for S22)	Plastic for no more than 3 locks	3VW9011-0BA41
Padlock 7 mm (spare part for S23)	Metal for no more than 1 lock	3VW9011-0BA42
Padlock 8 mm (spare part for S07)	Metal for no more than 2 locks	3VW9011-0BA44

Locking provision in OFF position for handle operating mechanism with rotary operators



- Against unauthorized closing in the case of molded case circuit breakers with rotary operator

Description	Article No.
For RONIS	3VW9727-0VL10

Locking provision in OFF position for handle operating mechanism without rotary operators

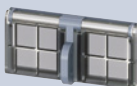


- Against unauthorized closing in the operator panel in the case of molded case circuit breakers without rotary operator

Description	Article No.
For padlocks	3VW9727-0LB10

For RONIS	3VW9727-0LF10
-----------	---------------

Interlocking sets for mechanical Open and/or Close on the operator panels



Description	Version	Article No.
Padlock 4 mm (spare part for S42)	Plastic for no more than 3 locks	3VW9011-0BA22
Padlock 7 mm (spare part for S43)	Metal for no more than 1 lock	3VW9011-0BA23
Padlock 8 mm (spare part for S44)	Metal for no more than 2 locks	3VW9011-0BA24

☰ For molded case circuit breakers with stored energy mechanism

⚡ For molded case circuit breakers with handle operating mechanism

2

Locking provisions and interlocks

3VA27

Protective covers for mechanical ON/OFF



- Mechanical ON/OFF to protect against unintentional actuation on the operator panel.
- Not lockable.

Description	Article No.
Not lockable (spare part for S41)	3VW9011-0BA21

Mechanical interlock



- Mechanical interlock with Bowden cable 2 m
- For fixed-mounted versions, an additional support 3VW9011-0BB52 (option S56) or extension kit 3VW9011-0BB53 (option S57) must be ordered

Mounting	Mounting	Article No.
Fixed-mounted	Rear panel or floor mounting	3VW9011-0BB21
Withdrawable	Mounting onto guide frame	3VW9011-0BB22

Bowden cables, separate

- One required for each circuit breaker

Type	Article No.
1000 mm	3VW9011-0BB23
2000 mm	3WL9111-0BB45-0AA0
3000 mm	3WL9111-0BB46-0AA0

Locking mechanisms to prevent opening of the control cabinet doors in ON position



- To prevent opening of the control cabinet door in ON position
- It additionally prevents the circuit breaker from being closed when the control cabinet door is open.

Mounting	Version	Article No.
Fixed mounted on side panel or floor	Direct fixed interlocking	3VW9011-0BB10
	Locking with Bowden cable	3VW9011-0BB16
Withdrawable	Direct fixed interlocking	3VW9011-0BB14
	Locking with Bowden cable	3VW9011-0BB18

Door sealing frames IP30



- For IP4x and higher, you must order the protective cover IP54 3VW9011-0AP03 or 3VW9011-0AP13.

Description	Mounting	Version	Article No.
Spare part for Z option T30.	Fixed-mounted	IP3x	3VW9011-0AP01
		IP3x	3VW9011-0AP02
	Withdrawable	IP3x	3VW9011-0AP04

Protective covers IP54



- Protective cover/hood IP54 lockable for fixed-mounted circuit breakers and withdrawable breakers
- For implementing degrees of protection IP4x and IP54 when installing in switchboard door.
- Cannot be combined with IP30 door sealing frame and door mounted rotary operator.

Description	Version	Article No.
Lock with unique key	IP54	3VW9011-0AP03
Lock with standard key	IP54	3VW9011-0AP13

For molded case circuit breakers with stored energy mechanism

For molded case circuit breakers with handle operating mechanism

3VL up to 1600 A, IEC



3VL molded case circuit breaker



2

Product Discontinuation

The 3VL molded case circuit breaker up to 1600 A IEC can only be ordered as a spare part since 10/2020, and will be removed from the order portfolio from 10/2025 onwards.

Documents available for downloading:

You can find comprehensive information on the 3VL molded case circuit breaker in the catalog extract.

3VL molded case circuit breakers

[www.siemens.com/lowvoltage/catalogs\(109769073\)](http://www.siemens.com/lowvoltage/catalogs(109769073))



Protecting electrical installations from damage

The number of electrical loads is constantly increasing, which places an ever greater load on the electrical installation.

In the event of an overload or short-circuit, miniature circuit breakers safely cut off the connected circuit and reliably protect electrical installations and equipment from damage. Miniature circuit breakers with communication and measuring function create transparency right down to the final circuit and increase system availability.

Miniature circuit breakers from the SENTRON portfolio are also simple to mount and install. The devices have a uniform design and, with the appropriate accessories, can be expanded by many additional functions.

For industry, buildings or infrastructure – with our versatile portfolio, you will find a suitable miniature circuit breaker for any application.

Miniature Circuit Breakers

All the information you need	3/2
Devices for all applications	3/4
System overview	3/5
Quick selection guide	3/6
Miniature circuit breakers	3/6
Circuit breakers for equipment	3/10
Basic units	3/12
5SL3 miniature circuit breakers	3/12
5SL6 miniature circuit breakers	3/14
5SL4 miniature circuit breakers	3/16
5SJ6...-KS miniature circuit breakers	3/18
5SL30 miniature circuit breakers	3/20
5SL60 miniature circuit breakers	3/22
5SY6 miniature circuit breakers	3/24
5SY4 miniature circuit breakers	3/26
5SP4 miniature circuit breakers	3/28
5SP5 miniature circuit breakers	3/30
5SY5 miniature circuit breakers	3/32
5SY7 miniature circuit breakers	3/34
5SY8 miniature circuit breakers	3/36
5SJ4..HG.. miniature circuit breakers	3/38
5SL6 COM miniature circuit breakers with communication and measuring functions	3/40
5SP3 selective main miniature circuit breakers (SHU)	3/44
5SY17 circuit breakers for equipment	3/46
5SK9 circuit breakers for equipment	3/47
Accessories	3/48
Overview of the modular system	3/48
Electrical accessories	3/50
Mechanical accessories	3/60
Standard busbars	3/62
Compact busbars	3/73
Accessories for busbars	3/78
Distribution blocks for DIN-rail mounting	3/84
SIKclip wiring system	3/87

A multitude of additional information ...

Information + ordering

All the important things at a glance

For information about miniature circuit breakers, please visit our websites

www.siemens.com/mcb

www.siemens.com/circuit-protection

Your product in detail

The SiePortal platform (knowledge base) provides comprehensive information

www.siemens.com/lowvoltage/product-support

- Technology Primer
 - Miniature circuit breakers (109482304)

The relevant tender specifications can be found at

www.siemens.com/tenderspecifications

Use our conversion tool for quick and easy conversion to Siemens products www.siemens.com/conversion-tool

Siemens YouTube channel

- Miniature circuit breakers (general) sie.ag/59PC9j

Everything you need for your order

Refer to SiePortal to find an overview of your products (product catalog)

- Miniature circuit breakers sie.ag/41HWeiL

Direct forwarding to the individual products in SiePortal by clicking on the article number in the catalog or entering this web address incl. article number

www.siemens.com/product_catalog_SIEP?Article.No.

The fast track to the experts

Contact persons in your region

We offer a comprehensive portfolio of services.

You can find your local contacts at

www.siemens.com/lowvoltage/components/contact

You will find further information on services at

www.siemens.com/service-offers

Competent expert advice on technical questions with a wide range of demand-optimized services for all our products and systems.

Assistance with technical queries is provided at

www.siemens.com/support-request

... can be found in our online services

Commissioning + operation

Your product in detail

The SiePortal platform (knowledge base) provides detailed technical information

www.siemens.com/lowvoltage/product-support

- Operating instructions
- Characteristic curves
- Certificates

Online Support app available for download from the [App Store](#) and [Play Store](#)

You will find further information at www.siemens.com/support-app

Provision of 3D data (step and u3d data formats)

- SiePortal (product catalog)
www.siemens.com/lowvoltage/product-catalog
- Image database
www.siemens.com/lowvoltage/picturedb

Engineering data for CAD or CAE systems are available in the CAx Download Manager at www.siemens.com/cax

Manuals

Manuals can be found in SiePortal at

www.siemens.com/lowvoltage/manuals

- Configuration Manual
 - Miniature circuit breakers ([45302792](#))
- Installation Manual
 - Circuit protection devices with communication and measuring function ([109791805](#))
- System Manual
 - Circuit protection devices with communication and measuring function ([109791806](#))

Face-to-face or online training

Our training courses can be found at

www.siemens.com/sitrain-lowvoltage

- SENTRON circuit protection devices with measuring and communication function (WT-LVBCOM)
- Basic principles of electrical engineering (WT-LVBGET)
- Protection concept (WT-LVBPC)

Technical overview – Miniature circuit breakers



The fast way to get you to our online services

This page provides you with comprehensive information and links on miniature circuit breakers

www.siemens.com/lowvoltage/product-support ([109769082](#))

Devices for all applications

Miniature circuit breakers for basic applications

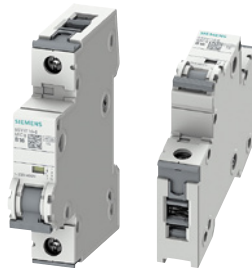


Ideal for standard applications

The 5SL miniature circuit breakers are the new standard with B and C tripping characteristics for applications up to 63 A. They can be used as main control switches to disconnect or isolate equipment.

The 5SL devices are mainly installed in meter panels and small distribution boards to protect circuits for lamps, cookers and even machines, for example, in residential or commercial buildings.

Miniature circuit breakers for advanced applications



Ideal for industrial applications

For circuits with motors or large lamps, semiconductors or strong pulse-generating equipment such as transformers and solenoid valves – the 5SY and 5SP devices are optimized for industrial applications and are proven in use.

The 5SY devices offer you top quality and functionality for installation in complex buildings and industry. With a rated breaking capacity of up to 25 kA, they are able to handle the most challenging requirements at a rated current of 0.3 to 80 A.

Special features

- Dual-chamber terminals
- Simple to detach without tools using sliding catches
- Separate switching position indication
- A wide range of accessories
- 5SL60 available as communication-capable miniature circuit breaker

Circuit breakers for equipment for advanced applications



Ideal for devices in industry

Circuit breakers for equipment from Siemens offer optimum protection for all applications in AC and DC control circuits in industrial applications and plant engineering.

Thermomagnetic 5SY17 circuit breakers for equipment are used to protect solenoid valves, servo motors, signal lamps or even PLC inputs. Everywhere where loads have to be precisely protected from overloads and short-circuits.

Electronic 5SK9 circuit breakers for equipment are optimally suited to protecting, for example, relays, programmable controllers, motors, sensors, actuators and valves. A current analysis in conjunction with fast tripping in the event of a fault avoid the danger of overloading the switched-mode power supply.

5SL6 COM miniature circuit breakers and 5ST3 COM auxiliary switches/fault signal contacts with communication and measuring functions

The new communication-capable protective devices and auxiliary components record measured values and status information and transmit this data wirelessly to higher-level systems.



5SL6 COM

[see page 3/40](#)



5ST3 COM

[see page 3/54](#)



SENTRON
Powercenter 1000

[see page 10/20](#)

- Recording of energy and active power, current, voltage, line frequency and temperature
- Measurement of residual currents in various frequency ranges
- Integrated status acquisition, operating hours counter and trip counter
- Higher system availability through early response to warning messages
- Convenient integration into new and existing systems thanks to compact mounting widths of 1 MW
- Fast parameterization and commissioning with the SENTRON Powerconfig mobile app or the SENTRON Powerconfig software
- Wireless transmission of measurement data from up to 24 communication-capable devices to the SENTRON Powercenter 1000 data transceiver

System overview

Basic units and accessories

Miniature circuit breakers for basic applications



5SL3

5SL6

5SL4

5SJ6...-KS

5SL30

5SL60

5SP3

Miniature circuit breakers for advanced applications



5SY6

5SY4

5SP4

5SP5

5SY5

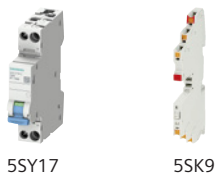
5SY7

5SY8

5SJ4..HG..

5SL6 COM
(EM)5SL6 COM
(RCM/EM)

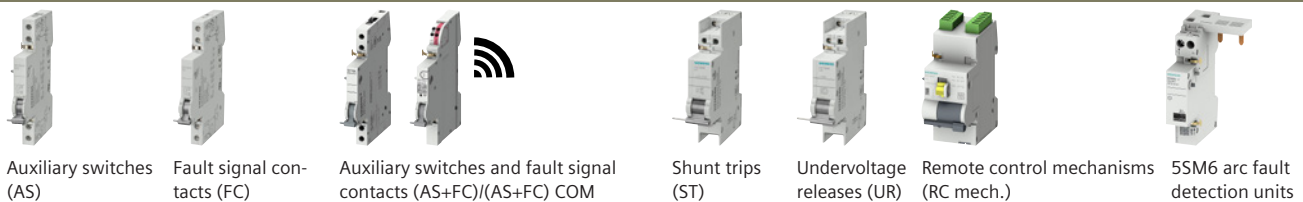
Circuit breakers for equipment for advanced applications



5SY17

5SK9

Electrical accessories

Auxiliary switches
(AS)Fault signal con-
tacts (FC)Auxiliary switches and fault signal
contacts (AS+FC)/(AS+FC) COMShunt trips
(ST)Undervoltage
releases (UR)Remote control mechanisms
(RC mech.)5SM6 arc fault
detection units

Mechanical accessories

Rotary operating
mechanisms

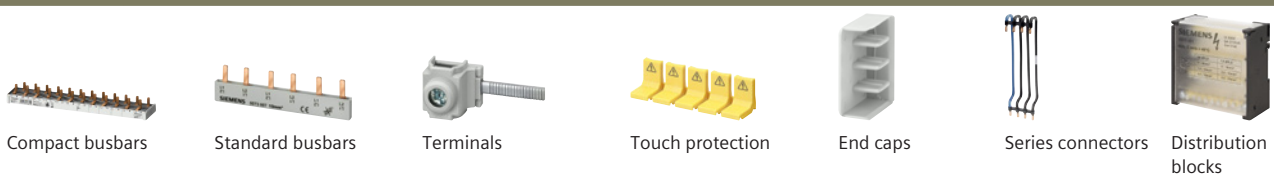
Spacers

Terminal covers

Wall enclosures

Molded-plastic
enclosuresHolders for front
panel installationIntermediate
frames

Busbars and accessories



Compact busbars

Standard busbars

Terminals

Touch protection

End caps

Series connectors

Distribution
blocks

Note:

You will find a detailed range of accessories with the basic units and in the Accessories section.

Miniature circuit breakers

For basic applications for buildings and infrastructure



5SL3



5SL6

Standards			IEC/EN 60898-1	IEC/EN 60898-1
Standards			IEC/EN 60898-1	IEC/EN 60898-1
Basic data				
Breaking capacity I_{cn} for AC (230/400 V)	kA		4.5	6
Rated current	A		0.3 ... 63	0.3 ... 63
Number of poles			1P 2P 3P 4P 1P+N 3P+N	1P 2P 3P 4P 1P+N 3P+N
Tripping characteristic			B C	B C
Approvals				
General product approvals			VDE, CEBC, TSE	VDE, CEBC, TSE
Marine classifications			–	–
Voltage/frequency				
Rated voltage AC	V		230/400	230/400
Max. operational voltage AC	V		250/440	250/440
Rated voltage DC per phase pole	V		60	60
Max. operational voltage DC per phase pole	V		72 ¹⁾	72 ¹⁾
Rated impulse voltage U_{imp}	kV		4	4
Rated frequency f_n	Hz		50/60	50/60
Connection				
Dual-chamber terminal			–	–
Conductor cross-section 1 wire	Solid/stranded	mm ²	0.75 ... 35	0.75 ... 35
	Finely stranded with end sleeve	mm ²	0.75 ... 25	0.75 ... 25
	Finely stranded without end sleeve	mm ²	1 ... 35	1 ... 35
Conductor cross-section 2 wires (same cross-section and same conductor type)	Solid/stranded	mm ²	0.75 ... 10	0.75 ... 10
	Finely stranded with end sleeve	mm ²	0.75 ... 4	0.75 ... 4
	Finely stranded without end sleeve	mm ²	1 ... 4	1 ... 4
Conductor cross-section 1-wire + busbar (pin thickness 1.5 mm)	Solid/stranded	mm ²	10 ... 25	10 ... 25
	Finely stranded with non-insulated end sleeve	mm ²	6 ... 25	6 ... 25
	Finely stranded with insulated end sleeve	mm ²	6 ... 16	6 ... 16
Ambient conditions				
Ambient temperature ⁵⁾	°C		–25 ... +45 ²⁾	–25 ... +45 ²⁾
Storage temperature	°C		–40 ... +75 ⁴⁾	–40 ... +75 ⁴⁾
Shock acc. to IEC 60068-2-27 150 m/s ² at 11 ms half-sine			–	–
Resistance to vibrations acc. to IEC 60068-2-6: 5 ... 25 Hz (±1 mm) and at 25 ... 150 Hz (50 m/s ²)			–	–
Resistant to shock and vibrations acc. to EN 61373 and EN 50155 "1B" (railway engineering)			–	–
Fire behavior of materials acc. to EN 45545-2 (fire protection on railway vehicles)			–	–
Degree of pollution for overvoltage category			2/III	2/III
Further information				
			See page 3/12	See page 3/14

¹⁾ Except for characteristic C: 0.3 A ... 1 A and characteristic D: 0.3 A ... 2 A

²⁾ Periodically +55 °C, max. 95% humidity

³⁾ Max. 95% humidity

⁴⁾ Max. 85% rel. humidity, > 45 °C max. 0.056kg/m³ abs. humidity

⁵⁾ The device properties specified, for example, in the product standards, such as service life, breaking capacity and surface temperature, cannot be guaranteed at the specified ambient temperatures that lie outside the specified product standards.

**5SL4****5SJ6...-KS****5SL30****5SL60****5SP3**

IEC/EN 60898-1	IEC/EN 60898-1	IEC/EN 60898-1	IEC/EN 60898-1	DIN VDE 0641-21
10	6	4.5	6	25
0.3 ... 63	10 ... 20	2 ... 40	2 ... 40	16 ... 63
1P 2P 3P 4P 1P+N 3P+N	1P 2P 3P 1P+N	1P+N	1P+N	1P 2P 3P 4P
B C D	B C	C	B C	E
VDE, CEBC, IMQ	VDE	VDE, IMQ, NF, CCC	VDE, IMQ, NF, CCC	VDE
–	–	–	DNV-GL	–
230/400	230/400	230	230	230/400
250/440	250/440	250	250	250/440
60	60	60	60	–
72 ¹⁾	60	72 ¹⁾	72 ¹⁾	–
4	4	4	4	6
50/60	50/60	50/60	50/60	50/60
–	Plug-in terminal on outgoing side	–	–	–
0.75 ... 35	1.5 ... 4 (top) 0.75 ... 25 (bottom)	0.75 ... 16	0.75 ... 16	2.5 ... 50 (bottom)
0.75 ... 25	1.5 ... 2.5 (top) 0.75 ... 25 (bottom)	0.75 ... 10	0.75 ... 10	2.5 ... 50 (bottom)
1 ... 35	1.5 ... 4	0.75 ... 16	0.75 ... 16	2.5 ... 16 (top)
0.75 ... 10	–	0.75 ... 4	0.75 ... 4	–
0.75 ... 4	–	0.75 ... 1.5	0.75 ... 1.5	–
1 ... 4	–	0.75 ... 4	0.75 ... 4	–
10 ... 25	–	–	–	–
6 ... 25	–	6 ... 10	6 ... 10	–
6 ... 16	–	6 ... 10	6 ... 10	–
–25 ... +55 ³⁾	–25 ... +45 ²⁾	–25 ... +60 ⁴⁾	–25 ... +60 ⁴⁾	–25 ... +55
–40 ... +75 ⁴⁾	–40 ... +75 ⁴⁾	–40 ... +75	–40 ... +75	–40 ... +70
–	–	–	–	–
–	–	–	–	–
–	–	–	–	–
–	–	–	–	–
2/III	2/III	2/III	2/III	3/IV
See page 3/16	See page 3/18	See page 3/20	See page 3/22	See page 3/44

Miniature circuit breakers

For advanced applications for buildings and infrastructure and for industry and mechanical engineering



5SL6 COM

5SY6

5SY4

Standards

Standards	IEC/EN 60898-1	IEC/EN 60898-1 IEC/EN 60947-2 UL 1077	IEC/EN 60898-1 IEC/EN 60947-2 UL 1077
-----------	----------------	---	---

Basic data

Breaking capacity I_{cn}	For AC (230/400 V) acc. to IEC/EN 60898-1	kA	6	6	10	
	For DC (220/440 V) acc. to IEC/EN 60898-2	kA	–	–	–	
	Acc. to UL1077 and CSA C22.2 No.235		–	Supplementary protector, OC, FW 0, OL 0, TC 3 at 50 °C U2: see Certificate of Compliance	Supplementary protector, OC, FW 0, OL 0, TC 3 at 50 °C U2: see Certificate of Compliance	
Rated breaking capacity I_{cu}	Acc. to IEC/EN 60947-2 AC at U_e 230 V at U_e 400 V (1P, 1P+N) (2P, 3P, 4P, 3P+N)	I_n 0.3 ... 2 A	kA	–	30 30	35 35
		I_n 3 ... 6 A	kA	–	30 30	35 35
		I_n 8 ... 10 A	kA	–	15 15	20 20
		I_n 13 ... 32 A	kA	–	15 15	20 20
	Acc. to IEC/EN 60947-2 DC at U_e 220 V at U_e 440 V (1P) (2P, 3P, 4P)	I_n 35 ... 40 A	kA	–	10 10	15 15
		I_n 50 ... 63 A	kA	–	10 10	15 15
		I_n 80 ... 125 A	kA	–	– –	10 10
			kA	–	–	–
Rated current		A	2 ... 32	0.3 ... 63	0.3 ... 80	
Number of poles			1P+N	1P 2P 3P 4P 1P+N 3P+N	1P 2P 3P 4P 1P+N 3P+N	
Tripping characteristic			B C	B C	A B C D	

Approvals

General product approvals			VDE, RED	VDE, IMQ, CCC, 	VDE, IMQ, CCC,
Marine classifications			–	DNV-GL, LR, BV, RINA, ABS	DNV-GL, LR, BV, RINA, ABS

Voltage/frequency

Rated voltage AC		V	230	230/400	230/400
	Acc. to UL 489, UL 1077, CSA C22.2 No.235	V	–	277/480	277/480
Max. operational voltage AC		V	250	250/440	250/440
Rated voltage DC per phase pole		V	–	60	60
Max. operational voltage DC per phase pole		V	–	72 ¹⁾	72 ¹⁾
Rated impulse voltage U_{imp}		kV	4	4	4
Rated frequency f_n		Hz	50/60	50/60	50/60

Connection

Dual-chamber terminal			–	■	■
Conductor cross-section 1 wire	Solid/stranded	mm ²	0.75 ... 16	0.75 ... 35	0.75 ... 35
	Finely stranded with end sleeve	mm ²	0.75 ... 10	0.75 ... 25	0.75 ... 25
	Conductors (Cu 60/75 °C $I_n \leq 40$ A; 60 °C $I_n > 40$ A)		–	AWG 18 ... 4	AWG 18 ... 4
Terminal tightening torque		Nm	1.2 ... 2 max.	2.5 ... 3.5 max.	2.5 ... 3.5 max.
		lb-in	11 ... 18	22 ... 26	22 ... 26

Ambient conditions

Ambient temperature ⁷⁾		°C	–25 ... +60 ⁵⁾	–25 ... +55 ⁴⁾	–40 ... +70 ³⁾
Storage temperature		°C	–40 ... +75	–40 ... +75 ³⁾	–40 ... +75 ³⁾
Shock acc. to IEC 60068-2-27 150 m/s ² at 11 ms half-sine			–	■	■
Resistance to vibrations acc. to IEC 60068-2-6: 5 ... 25 Hz (± 1 mm) and at 25 ... 150 Hz (50 m/s ²)			–	■	■
Resistant to shock and vibrations acc. to EN 61373 and EN 50155 "1B" (railway engineering)			■	–	■
Fire behavior of materials acc. to EN 45545-2 (fire protection on railway vehicles)			■	–	■
Degree of pollution for overvoltage category			2/III	3/III	3/III

Additional functions

Communication and measuring function ⁸⁾			■	–	–
--	--	--	---	---	---

Further information

See page 3/40

See page 3/24

See page 3/26

¹⁾ Exempt: C/D 0.3 A ... 0.5 A

²⁾ 5SY54.. 4-pole, degree of pollution 2 for overvoltage category II

³⁾ 95% humidity up to 55 °C, 55% humidity up to 70 °C, 30% humidity up to 75 °C

⁴⁾ Max. 95% humidity

⁵⁾ Max. 85% rel. humidity, > 45 °C max. 0.056kg/m³ abs. humidity

⁶⁾ When used with a busbar at the front or 2 conductors, the terminal area at the rear is restricted, see notes on the Internet

**5SP4****5SP5****5SY5****5SY7****5SY8****5SJ4..HG..**IEC/EN 60898-1
UL 1077

IEC/EN 60947-2

IEC/EN 60898-2
UL 1077IEC/EN 60898-1
IEC/EN 60947-2
UL 1077IEC/EN 60947-2
UL 1077IEC/EN 60947-2
UL 489

10

-

10

15

25

-

-

-

10

-

-

-

Supplementary protector,
OC, FW 0, OL 0,
TC 3 at 50 °C

-

Supplementary protector,
OC, FW 0, OL 0,
TC 3 at 50 °CSupplementary protector,
OC, FW 0, OL 0,
TC 3 at 50 °CSupplementary protector,
OC, FW 0, OL 0,
TC 3 at 50 °C

-

U2: see Certificate of
Compliance

-

U2: see Certificate of
ComplianceU2: see Certificate of
ComplianceU2: see Certificate of
Compliance

-

-| -

-| -

-| -

50 | 50

70 | 70

10

-| -

-| -

-| -

40 | 40

50 | 50

10

-| -

-| -

-| -

30 | 30

40 | 40

10

-| -

-| -

-| -

25 | 25

30 | 30

10

-| -

-| -

-| -

20 | 20

25 | 25

10

-| -

-| -

-| -

15 | 15

20 | 20

10

10 | 10

-| -

-| -

-| -

-| -

-

-

10

15

-

-

-

80 ... 125

80 ... 125

0.3 ... 63

0.3 ... 63

0.3 ... 63

0.3 ... 63

1P | 2P | 3P | 4P

1P | 2P

1P | 2P | 4P

1P | 2P | 3P | 4P | 1P+N |
3P+N1P | 2P | 3P | 4P | 1P+N |
3P+N

1P | 2P | 3P

B | C | D

-

B | C

B | C | D

C | D

B | C | D

VDE, CCC,

LR

-

VDE, CCC,

ABSVDE, IMQ, CCC,

DNV-GL, LR, BV, RINA, ABS
ABSVDE, CCC,

-

230/400

-

230/400

230/400

230/400

230/400

277/480

-

-

277/480

277/480

240/415 (5SJ4..HG40/41)
277/480 (5SJ4..HG42)

250/440

-

250/440

250/440

250/440

250/440

60

220

220

60

60

60

72

250

250

72 ¹⁾72 ¹⁾

60

4

4

4

4

4

4

50/60

50/60

50/60

50/60

50/60

50/60

-

-

■

■

■

■

10 ... 50

10 ... 50

0.75 ... 35

0.75 ... 35

0.75 ... 35

0.75 ... 25 (16) ⁶⁾

10 ... 35

10 ... 35

0.75 ... 25

0.75 ... 25

0.75 ... 25

0.75 ... 25 (10)

AWG 3 ... 1

AWG 3 ... 1

AWG 18 ... 4

AWG 18 ... 4

AWG 18 ... 4

AWG 18 ... 4 (5)

2.5 ... 3.5 max.

2.5 ... 3.5 max.

2.5 ... 3.5 max.

2.5 ... 3.5 max.

2.5 ... 3.5 max.

2.5 ... 3.5 max.

22 ... 31

22 ... 31

22 ... 26

22 ... 26

22 ... 26

22 ... 26

-25 ... +55 ⁴⁾-25 ... +55 ⁴⁾-40 ... +70 ³⁾-40 ... +70 ³⁾-25 ... +55 ⁴⁾-25 ... +55 ⁴⁾-40 ... +75 ³⁾-40 ... +75 ³⁾-40 ... +75 ³⁾-40 ... +75 ³⁾-40 ... +75 ³⁾-40 ... +75 ³⁾

-

-

■

■

-

■

■

-

■

■

■

■

-

-

■

■

-

-

■

-

■

■

-

-

3/III

3/III

3/III ⁴⁾

3/III

3/III

3/III

-

-

-

-

-

-

See page 3/28

See page 3/30

See page 3/32

See page 3/34

See page 3/36

See page 3/38

⁷⁾ The device properties specified, for example, in the product standards, such as service life, breaking capacity and surface temperature, cannot be guaranteed at the specified ambient temperatures that lie outside the specified product standards.

⁸⁾ Please note the country-specific radio licenses of the products at www.siemens.com/lowvoltage/certificates (109801197)

Circuit breakers for equipment

For advanced applications for industry and mechanical engineering



5SY17

Standards

Standards

IEC/EN 60934
UL 1077

Basic data

Breaking capacity I_{cn}	At rated voltage	kA	3
Rated current		A	0.5 ... 16
Number of poles			1P+AS
DC tripping	Magnetic		F1 (2.5 ... 4 × I_n) F2 (4 ... 7 × I_n)
	Thermal		1.05 × holding current 1.35 × tripping current TC3 1.35 × I_n
	Electronic		–
Service life/endurance	Actuations		6000

Approvals

General product approvals

CCC,
cRU_{us}

Voltage/frequency

Rated voltage AC	Acc. to IEC/DIN EN 60934	V	230
	Acc. to UL 1077	V	277
Min. operational voltage AC		V	12 ²⁾
Max. operational voltage AC		V	250
Rated voltage DC per phase pole		V	60
Min. operational voltage DC per phase pole		V	12 ²⁾
Max. operational voltage DC per phase pole		V	72
Rated impulse voltage U_{imp}		kV	4
Rated frequency f_n		Hz	50/60

Auxiliary switch

Min. operational voltage (AC)	V	12
Max. operational voltage (AC)	V	250
Min. operational voltage (DC)	V	12
Max. operational voltage (DC)	V	60
Utilization category AC-12		6 A at 230 V AC
Utilization category AC-14		6 A at 230 V AC
Utilization category DC-13		1 A at 60 V DC

Connection

Dual-chamber terminal			–
Conductor cross-section 1 wire	Solid/stranded	mm ²	0.75 ... 16
	Finely stranded with end sleeve	mm ²	0.75 ... 10
	Finely stranded with insulated end sleeve	mm ²	0.75 ... 10
	Finely stranded without end sleeve	mm ²	0.75 ... 16
	Conductor cross-section AWG		–
2-wire (same cross-section)	Solid/stranded	mm ²	0.75 ... 4
	Finely stranded with end sleeve	mm ²	0.75 ... 2.5
	Finely stranded with insulated end sleeve	mm ²	0.75 ... 1.5
	Finely stranded without end sleeve	mm ²	0.75 ... 4
Terminal tightening torque		Nm	2.0 ... 2.5 max.
		lb-in	17.7 ... 22.1

Ambient conditions

Ambient temperature	°C	–25 ... +60 ³⁾
Storage temperature	°C	–40 ... +70
Shock acc. to IEC 60068-2-27 150 m/s ² at 11 ms half-sine		–
Resistance to vibrations acc. to IEC 60068-2-6: 5 ... 25 Hz (±1 mm) and at 25 ... 150 Hz (50 m/s ²)		–
Resistant to shock and vibrations acc. to EN 61373 and EN 50155 "1B" (railway engineering)		■
Fire behavior of materials acc. to EN 45545-2 (fire protection on railway vehicles)		■
Degree of pollution for overvoltage category	Acc. to IEC	2/III

Further information

See page 3/46

¹⁾ Max. 95% humidity

²⁾ At a minimum current of 100 mA

³⁾ Max. 85% rel. humidity, > 45 °C max. 0.056 kg/m³ abs. humidity



5SK9

EN 61000-6-2, EN 61000-6-3, EN 60068-2-78,
EN 50178, EN 60068-2-6, EN 60068-2-27,
UL 508, UL 2367

–

1 ... 8

1P+AS

–

–

Overload $1.2 \times I_n/1s$ | Short-circuit $2 \times I_n / < 10\text{ ms}$

–



–

–

–

–

24

–

30

0.5

–

–

–

–

–

–

–

–

–

–

–

–

0.2 ... 4

0.2 ... 2.5

0.2 ... 2.5

–

AWG 24 ... 12

–

–

–

–

–

–

–25 ... +60¹⁾

–40 ... +70

–

–

–




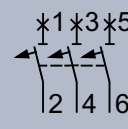
–

–

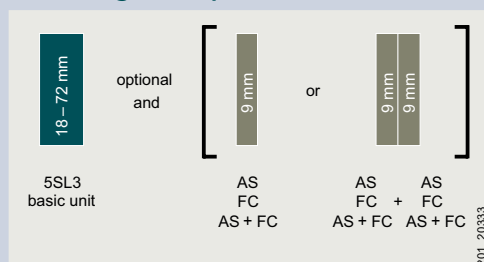
[See page 3/47](#)

5SL3 miniature circuit breakers

4.5 kA

	1P	1P+N	2P	3P				
Rated voltage U_n	230/400 V AC	230 V AC	400 V AC	400 V AC				
Mounting width	1 MW 	2 MW 	2 MW 	3 MW 				
Rated current I_n	Characteristic		Characteristic		Characteristic		Characteristic	
	B	C	B	C	B	C	B	C
0.3 A	–	5SL3114-7	–	5SL3514-7	–	5SL3214-7	–	–
0.5 A	–	5SL3105-7	–	5SL3505-7	–	5SL3205-7	–	–
1 A	–	5SL3101-7	–	5SL3501-7	–	5SL3201-7	–	5SL3301-7
1.6 A	–	5SL3115-7	–	5SL3515-7	–	5SL3215-7	–	–
2 A	–	5SL3102-7	–	5SL3502-7	–	5SL3202-7	–	5SL3302-7
3 A	–	5SL3103-7	–	5SL3503-7	–	5SL3203-7	–	5SL3303-7
4 A	–	5SL3104-7	–	5SL3504-7	–	5SL3204-7	–	5SL3304-7
6 A	5SL3106-6	5SL3106-7	5SL3506-6	5SL3506-7	5SL3206-6	5SL3206-7	5SL3306-6	5SL3306-7
8 A	–	5SL3108-7	–	5SL3508-7	–	5SL3208-7	–	–
10 A	5SL3110-6	5SL3110-7	5SL3510-6	5SL3510-7	5SL3210-6	5SL3210-7	5SL3310-6	5SL3310-7
13 A	5SL3113-6	5SL3113-7	5SL3513-6	5SL3513-7	5SL3213-6	5SL3213-7	–	–
16 A	5SL3116-6	5SL3116-7	5SL3516-6	5SL3516-7	5SL3216-6	5SL3216-7	5SL3316-6	5SL3316-7
20 A	5SL3120-6	5SL3120-7	5SL3520-6	5SL3520-7	5SL3220-6	5SL3220-7	5SL3320-6	5SL3320-7
25 A	5SL3125-6	5SL3125-7	5SL3525-6	5SL3525-7	5SL3225-6	5SL3225-7	5SL3325-6	5SL3325-7
32 A	5SL3132-6	5SL3132-7	5SL3532-6	5SL3532-7	5SL3232-6	5SL3232-7	5SL3332-6	5SL3332-7
40 A	5SL3140-6	5SL3140-7	5SL3540-6	5SL3540-7	5SL3240-6	5SL3240-7	5SL3340-6	5SL3340-7
50 A	5SL3150-6	5SL3150-7	5SL3550-6	5SL3550-7	5SL3250-6	5SL3250-7	5SL3350-6	5SL3350-7
63 A	5SL3163-6	5SL3163-7	5SL3563-6	5SL3563-7	5SL3263-6	5SL3263-7	5SL3363-6	5SL3363-7

Mounting concept



AS Auxiliary switches
 FC Fault signal contacts
 AS+FC Auxiliary switches and fault signal contacts

See page 3/48
 See page 3/50
 See page 3/53



3P+N		4P	
400 V AC		400 V AC	
4 MW		4 MW	
Characteristic		Characteristic	
B	C	B	C
–	–	–	–
–	–	–	–
–	5SL3601-7	–	5SL3401-7
–	–	–	–
–	5SL3602-7	–	5SL3402-7
–	5SL3603-7	–	5SL3403-7
–	5SL3604-7	–	5SL3404-7
5SL3606-6	5SL3606-7	–	5SL3406-7
–	5SL3608-7	–	–
5SL3610-6	5SL3610-7	–	5SL3410-7
5SL3613-6	5SL3613-7	–	5SL3413-7
5SL3616-6	5SL3616-7	–	5SL3416-7
5SL3620-6	5SL3620-7	–	5SL3420-7
5SL3625-6	5SL3625-7	–	5SL3425-7
5SL3632-6	5SL3632-7	–	5SL3432-7
5SL3640-6	5SL3640-7	–	5SL3440-7
5SL3650-6	5SL3650-7	–	5SL3450-7
5SL3663-6	5SL3663-7	–	5SL3463-7

3




Accessories

Auxiliary switches (AS)		Article No.
1 NO + 1 NC	Standard	5ST3010
	For low power	5ST3013
	For low power (with diode)	5ST3013-0XX01
2 NO	Standard	5ST3011
	For low power	5ST3014
2 NC	Standard	5ST3012
	For low power	5ST3015
1 CO	Standard	5ST3016

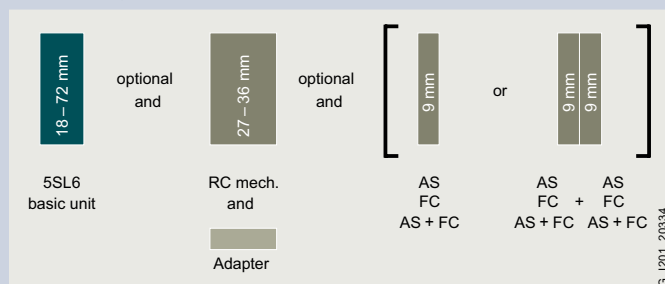
Fault signal contacts (FC)		Article No.
1 NO + 1 NC		5ST3020
2 NO		5ST3021
2 NC		5ST3022
Auxiliary switches and fault signal contacts (AS+FC)		Article No.
1 CO (AS) + 1 CO (FC)		5ST3062
5ST3 COM (AS+FC)		5ST3062-0MC

5SL6 miniature circuit breakers

6 kA

	1P	1P+N	2P			
Rated voltage U_n	230/400 V AC	230 V AC	400 V AC			
Mounting width	1 MW 	2 MW 	2 MW 			
Rated current I_n	Characteristic		Characteristic		Characteristic	
	B	C	B	C	B	C
0.3 A	–	5SL6114-7	–	5SL6514-7	–	5SL6214-7
0.5 A	–	5SL6105-7	–	5SL6505-7	–	5SL6205-7
1 A	–	5SL6101-7	–	5SL6501-7	–	5SL6201-7
1.6 A	–	5SL6115-7	–	5SL6515-7	–	5SL6215-7
2 A	5SL6102-6	5SL6102-7	–	5SL6502-7	–	5SL6202-7
3 A	–	5SL6103-7	–	5SL6503-7	–	5SL6203-7
4 A	5SL6104-6	5SL6104-7	–	5SL6504-7	–	5SL6204-7
6 A	5SL6106-6	5SL6106-7	5SL6506-6	5SL6506-7	5SL6206-6	5SL6206-7
8 A	–	5SL6108-7	–	5SL6508-7	–	5SL6208-7
10 A	5SL6110-6	5SL6110-7	5SL6510-6	5SL6510-7	5SL6210-6	5SL6210-7
13 A	5SL6113-6	5SL6113-7	5SL6513-6	5SL6513-7	5SL6213-6	5SL6213-7
16 A	5SL6116-6	5SL6116-7	5SL6516-6	5SL6516-7	5SL6216-6	5SL6216-7
20 A	5SL6120-6	5SL6120-7	5SL6520-6	5SL6520-7	5SL6220-6	5SL6220-7
25 A	5SL6125-6	5SL6125-7	5SL6525-6	5SL6525-7	5SL6225-6	5SL6225-7
32 A	5SL6132-6	5SL6132-7	5SL6532-6	5SL6532-7	5SL6232-6	5SL6232-7
40 A	5SL6140-6	5SL6140-7	5SL6540-6	5SL6540-7	5SL6240-6	5SL6240-7
50 A	5SL6150-6	5SL6150-7	5SL6550-6	5SL6550-7	5SL6250-6	5SL6250-7
63 A	5SL6163-6	5SL6163-7	5SL6563-6	5SL6563-7	5SL6263-6	5SL6263-7

Mounting concept



AS Auxiliary switches
 FC Fault signal contacts
 AS+FC Auxiliary switches and fault signal contacts
 RC mech. Remote control mechanisms

[See page 3/50](#)
[See page 3/52](#)
[See page 3/53](#)
[See page 3/58](#)



3P		3P+N		4P	
400 V AC		400 V AC		400 V AC	
3 MW		4 MW		4 MW	
Characteristic		Characteristic		Characteristic	
B	C	B	C	B	C
–	5SL6314-7	–	5SL6614-7	–	5SL6414-7
–	5SL6305-7	–	5SL6605-7	–	5SL6405-7
–	5SL6301-7	–	5SL6601-7	–	5SL6401-7
–	5SL6315-7	–	5SL6615-7	–	5SL6415-7
–	5SL6302-7	–	5SL6602-7	–	5SL6402-7
–	5SL6303-7	–	5SL6603-7	–	5SL6403-7
–	5SL6304-7	–	5SL6604-7	–	5SL6404-7
5SL6306-6	5SL6306-7	5SL6606-6	5SL6606-7	5SL6406-6	5SL6406-7
–	5SL6308-7	–	5SL6608-7	–	5SL6408-7
5SL6310-6	5SL6310-7	5SL6610-6	5SL6610-7	5SL6410-6	5SL6410-7
5SL6313-6	5SL6313-7	5SL6613-6	5SL6613-7	5SL6413-6	5SL6413-7
5SL6316-6	5SL6316-7	5SL6616-6	5SL6616-7	5SL6416-6	5SL6416-7
5SL6320-6	5SL6320-7	5SL6620-6	5SL6620-7	5SL6420-6	5SL6420-7
5SL6325-6	5SL6325-7	5SL6625-6	5SL6625-7	5SL6425-6	5SL6425-7
5SL6332-6	5SL6332-7	5SL6632-6	5SL6632-7	5SL6432-6	5SL6432-7
5SL6340-6	5SL6340-7	5SL6640-6	5SL6640-7	5SL6440-6	5SL6440-7
5SL6350-6	5SL6350-7	5SL6650-6	5SL6650-7	5SL6450-6	5SL6450-7
5SL6363-6	5SL6363-7	5SL6663-6	5SL6663-7	5SL6463-6	5SL6463-7

Accessories

Auxiliary switches (AS)			Remote control mechanisms (RC mech.)		
		Article No.			Article No.
1 NO + 1 NC	Standard	5ST3010	Basic	12 ... 30 V AC, 12 ... 48 V DC	5ST3053
	For low power	5ST3013		177 ... 270 V AC	5ST3054
	For low power (with diode)	5ST3013-0XX01	Power	12 ... 30 V AC, 12 ... 48 V DC	5ST3055
2 NO	Standard	5ST3011		177 ... 270 V AC	5ST3056
	For low power	5ST3014	Power with ARD	12 ... 30 V AC, 12 ... 48 V DC	5ST3057
2 NC	Standard	5ST3012		177 ... 270 V AC	5ST3058
	For low power	5ST3015	Power with extended function	12 ... 30 V AC, 12 ... 48 V DC	5ST3070
1 CO	Standard	5ST3016		170 ... 277 V AC, 77 ... 286 V DC	5ST3071
Fault signal contacts (FC)			Adapters for remote control mechanisms (RC mech.)		
		Article No.			Article No.
1 NO + 1 NC		5ST3020	1 ... 2 MW		5ST3820-6
		5ST3021		3 ... 4 MW	
		5ST3022			
Auxiliary switches and fault signal contacts (AS+FC)					
		Article No.			
1 CO (AS) + 1 CO (FC)		5ST3062			
5ST3 COM (AS+FC)		5ST3062-OMC			

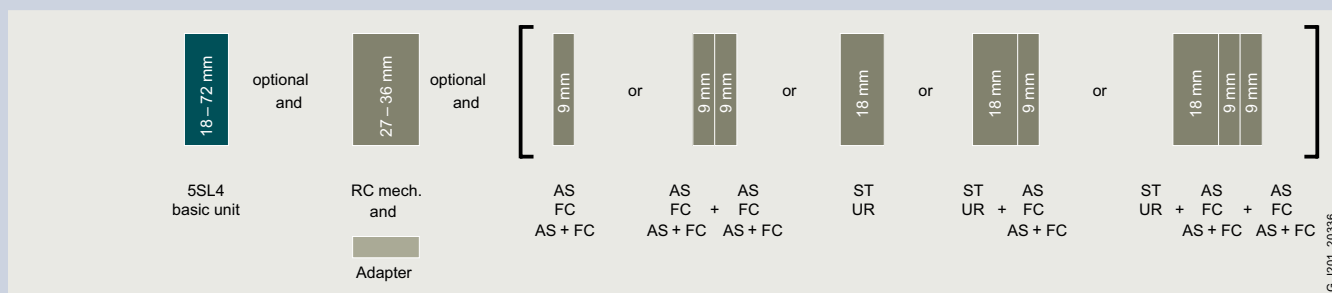
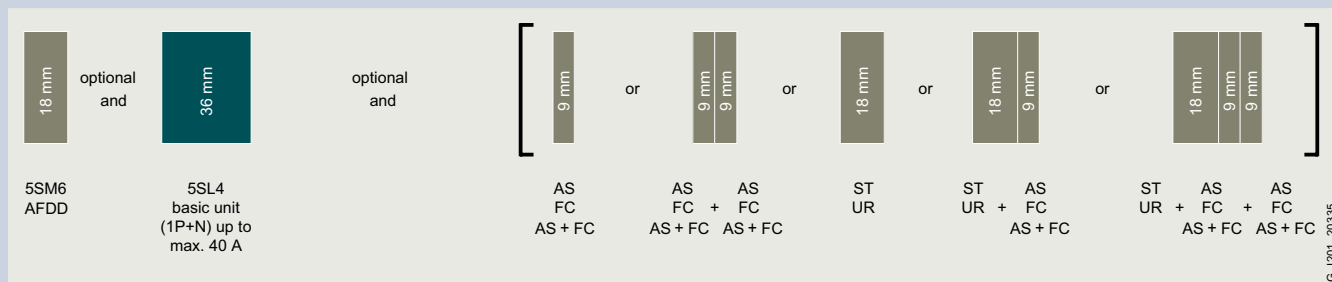
5SL4 miniature circuit breakers

10 kA

	1P	1P+N	2P
Rated voltage U_n	230/400 V AC	230 V AC	400 V AC
Mounting width	1 MW	2 MW	2 MW

Rated current I_n	Characteristic			Characteristic			Characteristic		
	B	C	D	B	C	D	B	C	D
0.3 A	–	5SL4114-7	5SL4114-8	–	5SL4514-7	5SL4514-8	–	5SL4214-7	5SL4214-8
0.5 A	–	5SL4105-7	5SL4105-8	–	5SL4505-7	5SL4505-8	–	5SL4205-7	5SL4205-8
1 A	5SL4101-6	5SL4101-7	5SL4101-8	5SL4501-6	5SL4501-7	5SL4501-8	5SL4201-6	5SL4201-7	5SL4201-8
1.6 A	–	5SL4115-7	5SL4115-8	–	5SL4515-7	5SL4515-8	–	5SL4215-7	5SL4215-8
2 A	5SL4102-6	5SL4102-7	5SL4102-8	5SL4502-6	5SL4502-7	5SL4502-8	5SL4202-6	5SL4202-7	5SL4202-8
3 A	5SL4103-6	5SL4103-7	5SL4103-8	5SL4503-6	5SL4503-7	5SL4503-8	5SL4203-6	5SL4203-7	5SL4203-8
4 A	5SL4104-6	5SL4104-7	5SL4104-8	5SL4504-6	5SL4504-7	5SL4504-8	5SL4204-6	5SL4204-7	5SL4204-8
6 A	5SL4106-6	5SL4106-7	5SL4106-8	5SL4506-6	5SL4506-7	5SL4506-8	5SL4206-6	5SL4206-7	5SL4206-8
8 A	5SL4108-6	5SL4108-7	5SL4108-8	5SL4508-6	5SL4508-7	5SL4508-8	5SL4208-6	5SL4208-7	5SL4208-8
10 A	5SL4110-6	5SL4110-7	5SL4110-8	5SL4510-6	5SL4510-7	5SL4510-8	5SL4210-6	5SL4210-7	5SL4210-8
13 A	5SL4113-6	5SL4113-7	5SL4113-8	5SL4513-6	5SL4513-7	5SL4513-8	5SL4213-6	5SL4213-7	5SL4213-8
16 A	5SL4116-6	5SL4116-7	5SL4116-8	5SL4516-6	5SL4516-7	5SL4516-8	5SL4216-6	5SL4216-7	5SL4216-8
20 A	5SL4120-6	5SL4120-7	5SL4120-8	5SL4520-6	5SL4520-7	5SL4520-8	5SL4220-6	5SL4220-7	5SL4220-8
25 A	5SL4125-6	5SL4125-7	5SL4125-8	5SL4525-6	5SL4525-7	5SL4525-8	5SL4225-6	5SL4225-7	5SL4225-8
32 A	5SL4132-6	5SL4132-7	5SL4132-8	5SL4532-6	5SL4532-7	5SL4532-8	5SL4232-6	5SL4232-7	5SL4232-8
40 A	5SL4140-6	5SL4140-7	5SL4140-8	5SL4540-6	5SL4540-7	5SL4540-8	5SL4240-6	5SL4240-7	5SL4240-8
50 A	5SL4150-6	5SL4150-7	5SL4150-8	5SL4550-6	5SL4550-7	5SL4550-8	5SL4250-6	5SL4250-7	5SL4250-8
63 A	5SL4163-6	5SL4163-7	5SL4163-8	5SL4563-6	5SL4563-7	5SL4563-8	5SL4263-6	5SL4263-7	5SL4263-8

Mounting concept



AFDD Arc fault detection units [See page 3/59](#) AS+FC Auxiliary switches and fault signal contacts [See page 3/53](#) UR Undervoltage releases [See page 3/57](#)
AS Auxiliary switches [See page 3/50](#) FC Fault signal contacts [See page 3/52](#) ST Shunt trips [See page 3/56](#) RC mech. Remote control mechanisms [See page 3/58](#)



3P			3P+N			4P		
400 V AC			400 V AC			400 V AC		
3 MW			4 MW			4 MW		
Characteristic			Characteristic			Characteristic		
B	C	D	B	C	D	B	C	D
–	5SL4314-7	5SL4314-8	–	5SL4614-7	5SL4614-8	–	5SL4414-7	5SL4414-8
–	5SL4305-7	5SL4305-8	–	5SL4605-7	5SL4605-8	–	5SL4405-7	5SL4405-8
5SL4301-6	5SL4301-7	5SL4301-8	5SL4601-6	5SL4601-7	5SL4601-8	5SL4401-6	5SL4401-7	5SL4401-8
–	5SL4315-7	5SL4315-8	–	5SL4615-7	5SL4615-8	–	5SL4415-7	5SL4415-8
5SL4302-6	5SL4302-7	5SL4302-8	5SL4602-6	5SL4602-7	5SL4602-8	5SL4402-6	5SL4402-7	5SL4402-8
5SL4303-6	5SL4303-7	5SL4303-8	5SL4603-6	5SL4603-7	5SL4603-8	5SL4403-6	5SL4403-7	5SL4403-8
5SL4304-6	5SL4304-7	5SL4304-8	5SL4604-6	5SL4604-7	5SL4604-8	5SL4404-6	5SL4404-7	5SL4404-8
5SL4306-6	5SL4306-7	5SL4306-8	5SL4606-6	5SL4606-7	5SL4606-8	5SL4406-6	5SL4406-7	5SL4406-8
5SL4308-6	5SL4308-7	5SL4308-8	5SL4608-6	5SL4608-7	5SL4608-8	5SL4408-6	5SL4408-7	5SL4408-8
5SL4310-6	5SL4310-7	5SL4310-8	5SL4610-6	5SL4610-7	5SL4610-8	5SL4410-6	5SL4410-7	5SL4410-8
5SL4313-6	5SL4313-7	5SL4313-8	5SL4613-6	5SL4613-7	5SL4613-8	5SL4413-6	5SL4413-7	5SL4413-8
5SL4316-6	5SL4316-7	5SL4316-8	5SL4616-6	5SL4616-7	5SL4616-8	5SL4416-6	5SL4416-7	5SL4416-8
5SL4320-6	5SL4320-7	5SL4320-8	5SL4620-6	5SL4620-7	5SL4620-8	5SL4420-6	5SL4420-7	5SL4420-8
5SL4325-6	5SL4325-7	5SL4325-8	5SL4625-6	5SL4625-7	5SL4625-8	5SL4425-6	5SL4425-7	5SL4425-8
5SL4332-6	5SL4332-7	5SL4332-8	5SL4632-6	5SL4632-7	5SL4632-8	5SL4432-6	5SL4432-7	5SL4432-8
5SL4340-6	5SL4340-7	5SL4340-8	5SL4640-6	5SL4640-7	5SL4640-8	5SL4440-6	5SL4440-7	5SL4440-8
5SL4350-6	5SL4350-7	5SL4350-8	5SL4650-6	5SL4650-7	5SL4650-8	5SL4450-6	5SL4450-7	5SL4450-8
5SL4363-6	5SL4363-7	5SL4363-8	5SL4663-6	5SL4663-7	5SL4663-8	5SL4463-6	5SL4463-7	5SL4463-8


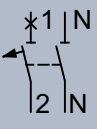

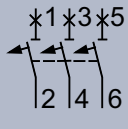
Accessories

Auxiliary switches (AS)		Article No.	Undervoltage releases (UR)		Article No.
1 NO + 1 NC	Standard	5ST3010	With integrated auxiliary switch	230 V AC	5ST3040
	For low power	5ST3013		110 V DC	5ST3041
	For low power (with diode)	5ST3013-0XX01		24 V DC	5ST3042
2 NO	Standard	5ST3011	Without integrated auxiliary switch	230 V AC	5ST3043
	For low power	5ST3014		110 V DC	5ST3044
2 NC	Standard	5ST3012		24 V DC	5ST3045
	For low power	5ST3015			
1 CO	Standard	5ST3016	Remote control mechanisms (RC mech.)		Article No.
Fault signal contacts (FC)		Article No.	Basic	12 ... 30 V AC, 12 ... 48 V DC	5ST3053
1 NO + 1 NC		5ST3020		177 ... 270 V AC	5ST3054
2 NO		5ST3021	Power	12 ... 30 V AC, 12 ... 48 V DC	5ST3055
2 NC		5ST3022		177 ... 270 V AC	5ST3056
Auxiliary switches and fault signal contacts (AS+FC)		Article No.	Power with ARD	12 ... 30 V AC, 12 ... 48 V DC	5ST3057
1 CO (AS) + 1 CO (FC)		5ST3062		177 ... 270 V AC	5ST3058
5ST3 COM (AS+FC)		5ST3062-0MC	Power with extended function	12 ... 30 V AC, 12 ... 48 V DC	5ST3070
Shunt trips (ST)		Article No.		170 ... 277 V AC, 77 ... 286 V DC	5ST3071
110 ... 415 V AC, 110 ... 220 V DC		5ST3030	Adapters for remote control mechanisms (RC mech.)		Article No.
24 ... 48 V AC/DC		5ST3031	1 ... 2 MW		5ST3820-6
12 V DC		5ST3031-0XX01	3 ... 4 MW		5ST3820-7
			Arc fault detection units (AFDD)		Article No.
			For basic units 1P+N (2 MW), not in combination with RC mech.	I_n up to 16 A	5SM6021-2
				I_n up to 40 A	5SM6024-2

5SJ6...-KS miniature circuit breakers

6 kA – plug-in terminal on outgoing side


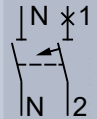


	1P	1P+N	2P	3P				
Rated voltage U_n	230/400 V AC	230/400 V AC	230/400 V AC	230/400 V AC				
Mounting width	1 MW 	2 MW 	2 MW 	3 MW 				
Rated current I_n	Characteristic		Characteristic		Characteristic		Characteristic	
	B	C	B	C	B	C	B	C
10 A	5SJ6110-6KS	5SJ6110-7KS	5SJ6510-6KS	5SJ6510-7KS	5SJ6210-6KS	5SJ6210-7KS	5SJ6310-6KS	5SJ6310-7KS
13 A	5SJ6113-6KS	5SJ6113-7KS	5SJ6513-6KS	5SJ6513-7KS	5SJ6213-6KS	5SJ6213-7KS	5SJ6313-6KS	5SJ6313-7KS
16 A	5SJ6116-6KS	5SJ6116-7KS	5SJ6516-6KS	5SJ6516-7KS	5SJ6216-6KS	5SJ6216-7KS	5SJ6316-6KS	5SJ6316-7KS
20 A	5SJ6120-6KS	5SJ6120-7KS	5SJ6520-6KS	5SJ6520-7KS	5SJ6220-6KS	5SJ6220-7KS	5SJ6320-6KS	5SJ6320-7KS

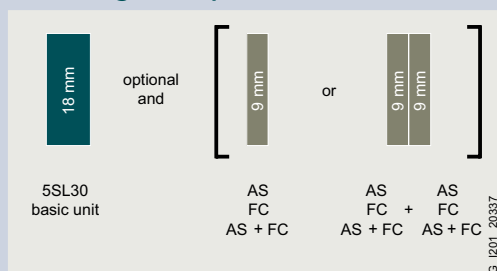
3

5SL30 miniature circuit breakers

1P+N 4.5 kA compact miniature circuit breakers

	1P+N (N pole right)	1P+N (N pole left)
Rated voltage U_n	230 V AC	230 V AC
Mounting width	2 MW	2 MW
		
Rated current I_n	Characteristic C	Characteristic C
2 A	5SL3002-7	5SL3002-7KL
4 A	5SL3004-7	5SL3004-7KL
6 A	5SL3006-7	5SL3006-7KL
8 A	5SL3008-7	5SL3008-7KL
10 A	5SL3010-7	5SL3010-7KL
13 A	5SL3013-7	5SL3013-7KL
16 A	5SL3016-7	5SL3016-7KL
20 A	5SL3020-7	5SL3020-7KL
25 A	5SL3025-7	5SL3025-7KL
32 A	5SL3032-7	5SL3032-7KL
40 A	5SL3040-7	5SL3040-7KL

Mounting concept



AS Auxiliary switches
 FC Fault signal contacts
 AS+FC Auxiliary switches and fault signal contacts

[See page 3/50](#)
[See page 3/52](#)
[See page 3/53](#)





Accessories

Auxiliary switches (AS)		Article No.
1 NO + 1 NC	Standard	5ST3010
	For low power	5ST3013
	For low power (with diode)	5ST3013-0XX01
2 NO	Standard	5ST3011
	For low power	5ST3014
2 NC	Standard	5ST3012
	For low power	5ST3015
1 CO	Standard	5ST3016

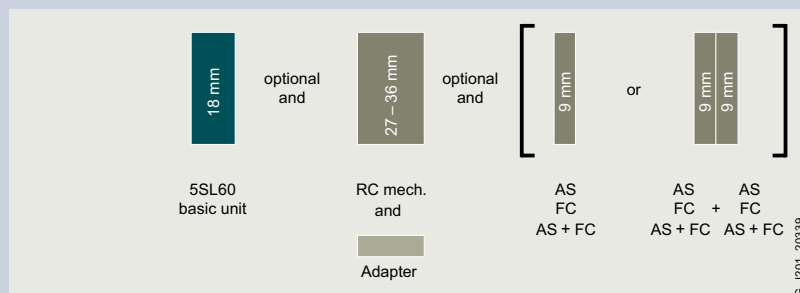
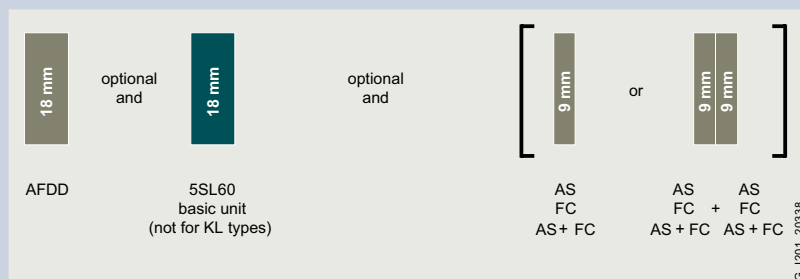
Fault signal contacts (FC)		Article No.
1 NO + 1 NC		5ST3020
2 NO		5ST3021
2 NC		5ST3022
Auxiliary switches and fault signal contacts (AS+FC)		Article No.
1 CO (AS) + 1 CO (FC)		5ST3062
5ST3 COM (AS+FC)		5ST3062-0MC

5SL60 miniature circuit breakers

1P+N 6 kA compact miniature circuit breakers

	1P+N (N pole right)	1P+N (N pole left)	
Rated voltage U_n	230 V AC	230 V AC	
Mounting width	1 MW 	1 MW 	
Rated current I_n	Characteristic		Characteristic
	B	C	C
2 A	–	5SL6002-7	5SL6002-7KL
4 A	–	5SL6004-7	5SL6004-7KL
6 A	5SL6006-6	5SL6006-7	5SL6006-7KL
8 A	–	5SL6008-7	5SL6008-7KL
10 A	5SL6010-6	5SL6010-7	5SL6010-7KL
13 A	5SL6013-6	5SL6013-7	5SL6013-7KL
16 A	5SL6016-6	5SL6016-7	5SL6016-7KL
20 A	5SL6020-6	5SL6020-7	5SL6020-7KL
25 A	5SL6025-6	5SL6025-7	5SL6025-7KL
32 A	5SL6032-6	5SL6032-7	5SL6032-7KL
40 A	5SL6040-6	5SL6040-7	5SL6040-7KL

Mounting concept



AFDD Arc fault detection units
AS Auxiliary switches
FC Fault signal contacts
AS+FC Auxiliary switches and fault signal contacts
RC mech. Remote control mechanisms

[See page 3/59](#)
[See page 3/50](#)
[See page 3/52](#)
[See page 3/53](#)
[See page 3/58](#)






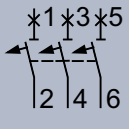
Accessories

Auxiliary switches (AS)		Article No.
1 NO + 1 NC	Standard	5ST3010
	For low power	5ST3013
	For low power (with diode)	5ST3013-0XX01
2 NO	Standard	5ST3011
	For low power	5ST3014
2 NC	Standard	5ST3012
	For low power	5ST3015
1 CO	Standard	5ST3016
Fault signal contacts (FC)		Article No.
1 NO + 1 NC		5ST3020
2 NO		5ST3021
2 NC		5ST3022
Auxiliary switches and fault signal contacts (AS+FC)		Article No.
1 CO (AS) + 1 CO (FC)		5ST3062
5ST3 COM (AS+FC)		5ST3062-OMC

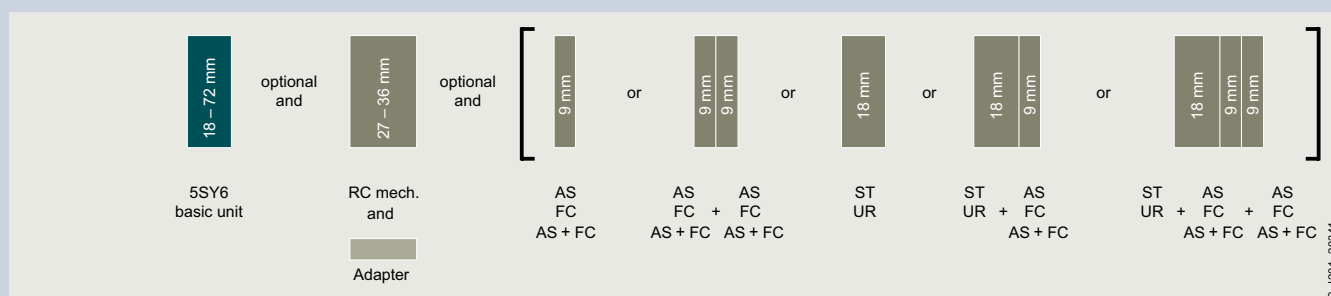
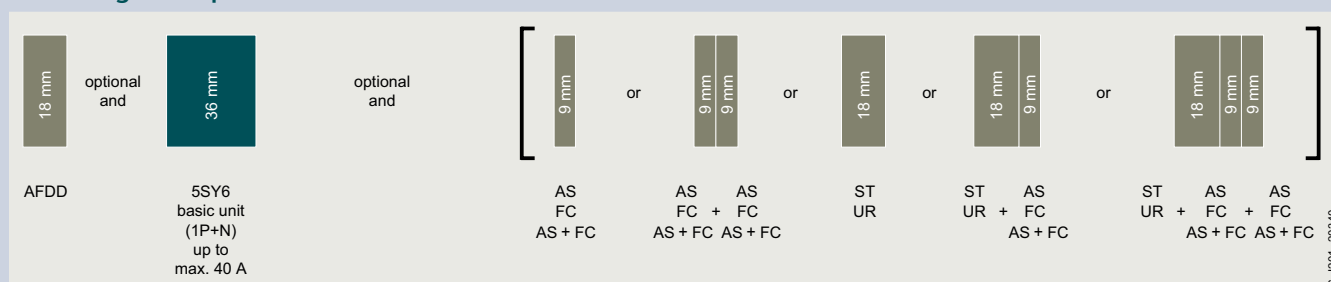
Remote control mechanisms (RC mech.)		Article No.
Basic	12 ... 30 V AC, 12 ... 48 V DC	5ST3053
	177 ... 270 V AC	5ST3054
Power	12 ... 30 V AC, 12 ... 48 V DC	5ST3055
	177 ... 270 V AC	5ST3056
Power with ARD	12 ... 30 V AC, 12 ... 48 V DC	5ST3057
	177 ... 270 V AC	5ST3058
Power with extended function	12 ... 30 V AC, 12 ... 48 V DC	5ST3070
	170 ... 277 V AC, 77 ... 286 V DC	5ST3071
Adapters for remote control mechanisms (RC mech.)		Article No.
1 MW		5ST3820-6
Arc fault detection units (AFDD)		Article No.
For basic units 1P + N (1 MW), not for KL types	I_n up to 16 A	5SM6011-2
	I_n up to 40 A	5SM6014-2

5SY6 miniature circuit breakers

6 kA

	1P	1P+N	2P	3P				
Rated voltage U_n	230/400 V AC	230 V AC	400 V AC	400 V AC				
Mounting width	1 MW 	2 MW 	2 MW 	3 MW 				
Rated current I_n	Characteristic		Characteristic		Characteristic		Characteristic	
	B	C	B	C	B	C	B	C
0.3 A	–	5SY6114-7	–	5SY6514-7	–	5SY6214-7	–	5SY6314-7
0.5 A	–	5SY6105-7	–	5SY6505-7	–	5SY6205-7	–	5SY6305-7
1 A	–	5SY6101-7	–	5SY6501-7	–	5SY6201-7	–	5SY6301-7
1.6 A	–	5SY6115-7	–	5SY6515-7	–	5SY6215-7	–	5SY6315-7
2 A	5SY6102-6	5SY6102-7	–	5SY6502-7	–	5SY6202-7	–	5SY6302-7
3 A	–	5SY6103-7	–	5SY6503-7	–	5SY6203-7	–	5SY6303-7
4 A	5SY6104-6	5SY6104-7	–	5SY6504-7	–	5SY6204-7	–	5SY6304-7
5 A	–	5SY6111-7	–	–	–	5SY6211-7	–	5SY6311-7
6 A	5SY6106-6	5SY6106-7	5SY6506-6	5SY6506-7	5SY6206-6	5SY6206-7	5SY6306-6	5SY6306-7
8 A	–	5SY6108-7	–	5SY6508-7	–	5SY6208-7	–	5SY6308-7
10 A	5SY6110-6	5SY6110-7	5SY6510-6	5SY6510-7	5SY6210-6	5SY6210-7	5SY6310-6	5SY6310-7
13 A	5SY6113-6	5SY6113-7	5SY6513-6	5SY6513-7	5SY6213-6	5SY6213-7	5SY6313-6	5SY6313-7
15 A	–	5SY6118-7	–	–	–	5SY6218-7	–	5SY6318-7
16 A	5SY6116-6	5SY6116-7	5SY6516-6	5SY6516-7	5SY6216-6	5SY6216-7	5SY6316-6	5SY6316-7
20 A	5SY6120-6	5SY6120-7	5SY6520-6	5SY6520-7	5SY6220-6	5SY6220-7	5SY6320-6	5SY6320-7
25 A	5SY6125-6	5SY6125-7	5SY6525-6	5SY6525-7	5SY6225-6	5SY6225-7	5SY6325-6	5SY6325-7
30 A	–	5SY6130-7	–	–	–	5SY6230-7	–	5SY6330-7
32 A	5SY6132-6	5SY6132-7	5SY6532-6	5SY6532-7	5SY6232-6	5SY6232-7	5SY6332-6	5SY6332-7
40 A	5SY6140-6	5SY6140-7	5SY6540-6	5SY6540-7	5SY6240-6	5SY6240-7	5SY6340-6	5SY6340-7
50 A	5SY6150-6	5SY6150-7	5SY6550-6	5SY6550-7	5SY6250-6	5SY6250-7	5SY6350-6	5SY6350-7
63 A	5SY6163-6	5SY6163-7	5SY6563-6	5SY6563-7	5SY6263-6	5SY6263-7	5SY6363-6	5SY6363-7

Mounting concept



AFDD Arc fault detection units
AS Auxiliary switches
FC Fault signal contacts

See page 3/59
See page 3/50
See page 3/52

AS+FC Auxiliary switches and fault signal contacts
ST Shunt trips

See page 3/53
See page 3/56

UR Undervoltage releases
RC mech. Remote control mechanisms

See page 3/57
See page 3/58



3P+N		4P	
400 V AC		400 V AC	
4 MW		4 MW	
Characteristic		Characteristic	
B	C	B	C
–	5SY6614-7	–	5SY6414-7
–	5SY6605-7	–	5SY6405-7
–	5SY6601-7	–	5SY6401-7
–	5SY6615-7	–	5SY6415-7
–	5SY6602-7	–	5SY6402-7
–	5SY6603-7	–	5SY6403-7
–	5SY6604-7	–	5SY6404-7
–	–	–	–
5SY6606-6	5SY6606-7	5SY6406-6	5SY6406-7
–	5SY6608-7	–	5SY6408-7
5SY6610-6	5SY6610-7	5SY6410-6	5SY6410-7
5SY6613-6	5SY6613-7	5SY6413-6	5SY6413-7
–	–	–	–
5SY6616-6	5SY6616-7	5SY6416-6	5SY6416-7
5SY6620-6	5SY6620-7	5SY6420-6	5SY6420-7
5SY6625-6	5SY6625-7	5SY6425-6	5SY6425-7
–	–	–	–
5SY6632-6	5SY6632-7	5SY6432-6	5SY6432-7
5SY6640-6	5SY6640-7	5SY6440-6	5SY6440-7
5SY6650-6	5SY6650-7	5SY6450-6	5SY6450-7
5SY6663-6	5SY6663-7	5SY6463-6	5SY6463-7

Accessories

Auxiliary switches (AS)		Article No.
1 NO + 1 NC	Standard	5ST3010
	For low power	5ST3013
	For low power (with diode)	5ST3013-0XX01
2 NO	Standard	5ST3011
	For low power	5ST3014
2 NC	Standard	5ST3012
	For low power	5ST3015
1 CO	Standard	5ST3016
Fault signal contacts (FC)		Article No.
1 NO + 1 NC		5ST3020
2 NO		5ST3021
2 NC		5ST3022
Auxiliary switches and fault signal contacts (AS+FC)		Article No.
1 CO (AS) + 1 CO (FC)		5ST3062
5ST3 COM (AS+FC)		5ST3062-0MC
Shunt trips (ST)		Article No.
110 ... 415 V AC, 110 ... 220 V DC		5ST3030
24 ... 48 V AC/DC		5ST3031
12 V DC		5ST3031-0XX01

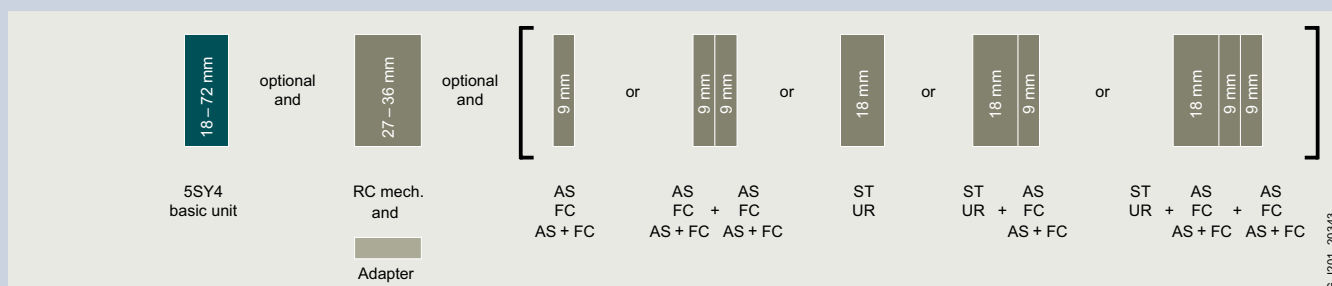
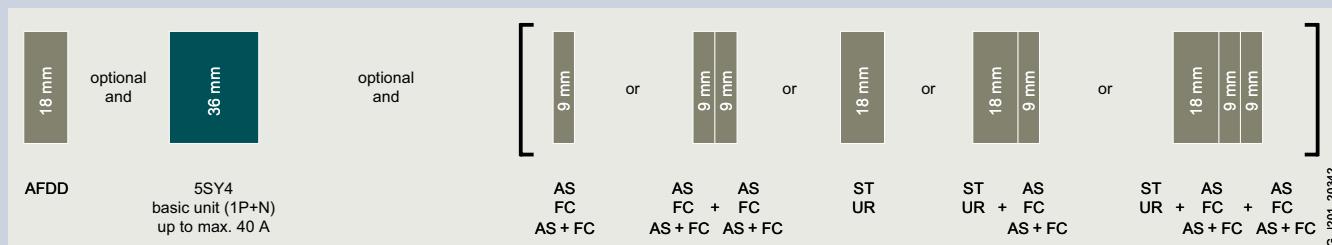
Undervoltage releases (UR)		Article No.
With integrated auxiliary switch	230 V AC	5ST3040
	110 V DC	5ST3041
	24 V DC	5ST3042
Without integrated auxiliary switch	230 V AC	5ST3043
	110 V DC	5ST3044
	24 V DC	5ST3045
Remote control mechanisms (RC mech.)		Article No.
Basic	12 ... 30 V AC, 12 ... 48 V DC	5ST3053
	177 ... 270 V AC	5ST3054
Power	12 ... 30 V AC, 12 ... 48 V DC	5ST3055
	177 ... 270 V AC	5ST3056
Power with ARD	12 ... 30 V AC, 12 ... 48 V DC	5ST3057
	177 ... 270 V AC	5ST3058
Power with extended function	12 ... 30 V AC, 12 ... 48 V DC	5ST3070
	170 ... 277 V AC, 77 ... 286 V DC	5ST3071
Adapters for remote control mechanisms (RC mech.)		Article No.
1 ... 2 MW		5ST3820-1
3 ... 4 MW		5ST3820-2
Arc fault detection units (AFDD)		Article No.
For basic units 1P+N (2 MW), not in combination with RC mech.	I_n up to 16 A	5SM6021-2
	I_n up to 40 A	5SM6024-2

5SY4 miniature circuit breakers

10 kA

	1P	1P+N	2P									
Rated voltage U_n	230/400 V AC	230 V AC	400 V AC									
Mounting width	1 MW 	2 MW 	2 MW 									
Rated current I_n	Characteristic				Characteristic				Characteristic			
	A	B	C	D	A	B	C	D	A	B	C	D
0.3 A	–	–	5SY4114-7	5SY4114-8	–	–	5SY4514-7	5SY4514-8	–	–	5SY4214-7	5SY4214-8
0.5 A	5SY4105-5	–	5SY4105-7	5SY4105-8	–	–	5SY4505-7	5SY4505-8	5SY4205-5	–	5SY4205-7	5SY4205-8
1 A	5SY4101-5	5SY4101-6	5SY4101-7	5SY4101-8	5SY4501-5	–	5SY4501-7	5SY4501-8	5SY4201-5	5SY4201-6	5SY4201-7	5SY4201-8
1.6 A	5SY4115-5	5SY4115-6	5SY4115-7	5SY4115-8	5SY4515-5	5SY4515-6	5SY4515-7	5SY4515-8	5SY4215-5	5SY4215-6	5SY4215-7	5SY4215-8
2 A	5SY4102-5	5SY4102-6	5SY4102-7	5SY4102-8	5SY4502-5	–	5SY4502-7	5SY4502-8	5SY4202-5	5SY4202-6	5SY4202-7	5SY4202-8
3 A	5SY4103-5	5SY4103-6	5SY4103-7	5SY4103-8	5SY4503-5	–	5SY4503-7	5SY4503-8	5SY4203-5	5SY4203-6	5SY4203-7	5SY4203-8
4 A	5SY4104-5	5SY4104-6	5SY4104-7	5SY4104-8	5SY4504-5	5SY4504-6	5SY4504-7	5SY4504-8	5SY4204-5	5SY4204-6	5SY4204-7	5SY4204-8
5 A	–	–	5SY4111-7	–	–	–	–	–	–	–	5SY4211-7	–
6 A	5SY4106-5	5SY4106-6	5SY4106-7	5SY4106-8	5SY4506-5	5SY4506-6	5SY4506-7	5SY4506-8	5SY4206-5	5SY4206-6	5SY4206-7	5SY4206-8
8 A	5SY4108-5	5SY4108-6	5SY4108-7	5SY4108-8	5SY4508-5	–	5SY4508-7	5SY4508-8	5SY4208-5	5SY4208-6	5SY4208-7	5SY4208-8
10 A	5SY4110-5	5SY4110-6	5SY4110-7	5SY4110-8	5SY4510-5	5SY4510-6	5SY4510-7	5SY4510-8	5SY4210-5	5SY4210-6	5SY4210-7	5SY4210-8
13 A	5SY4113-5	5SY4113-6	5SY4113-7	5SY4113-8	5SY4513-5	5SY4513-6	5SY4513-7	5SY4513-8	5SY4213-5	5SY4213-6	5SY4213-7	5SY4213-8
15 A	–	–	5SY4118-7	–	–	–	–	–	–	–	5SY4218-7	–
16 A	5SY4116-5	5SY4116-6	5SY4116-7	5SY4116-8	5SY4516-5	5SY4516-6	5SY4516-7	5SY4516-8	5SY4216-5	5SY4216-6	5SY4216-7	5SY4216-8
20 A	5SY4120-5	5SY4120-6	5SY4120-7	5SY4120-8	5SY4520-5	5SY4520-6	5SY4520-7	5SY4520-8	5SY4220-5	5SY4220-6	5SY4220-7	5SY4220-8
25 A	5SY4125-5	5SY4125-6	5SY4125-7	5SY4125-8	5SY4525-5	5SY4525-6	5SY4525-7	5SY4525-8	5SY4225-5	5SY4225-6	5SY4225-7	5SY4225-8
30 A	–	–	5SY4130-7	–	–	–	–	–	–	–	5SY4230-7	–
32 A	5SY4132-5	5SY4132-6	5SY4132-7	5SY4132-8	5SY4532-5	5SY4532-6	5SY4532-7	5SY4532-8	5SY4232-5	5SY4232-6	5SY4232-7	5SY4232-8
35 A	–	–	5SY4135-7	–	–	–	–	–	–	–	5SY4235-7	–
40 A	5SY4140-5	5SY4140-6	5SY4140-7	5SY4140-8	5SY4540-5	5SY4540-6	5SY4540-7	5SY4540-8	5SY4240-5	5SY4240-6	5SY4240-7	5SY4240-8
45 A	–	–	5SY4145-7	–	–	–	–	–	–	–	5SY4245-7	–
50 A	5SY4150-5	5SY4150-6	5SY4150-7	5SY4150-8	5SY4550-5	5SY4550-6	5SY4550-7	5SY4550-8	5SY4250-5	5SY4250-6	5SY4250-7	5SY4250-8
60 A	–	–	5SY4160-7	–	–	–	–	–	–	–	5SY4260-7	–
63 A	5SY4163-5	5SY4163-6	5SY4163-7	5SY4163-8	5SY4563-5	5SY4563-6	5SY4563-7	5SY4563-8	5SY4263-5	5SY4263-6	5SY4263-7	5SY4263-8
80 A	–	5SY4180-6	5SY4180-7	–	–	–	5SY4580-7	–	–	5SY4280-6	5SY4280-7	–

Mounting concept






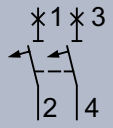
3P				3P+N				4P			
400 V AC				400 V AC				400 V AC			
3 MW				4 MW				4 MW			
Characteristic				Characteristic				Characteristic			
A	B	C	D	A	B	C	D	A	B	C	D
–	–	5SY4314-7	5SY4314-8	–	–	5SY4614-7	5SY4614-8	–	–	5SY4414-7	5SY4414-8
5SY4305-5	–	5SY4305-7	5SY4305-8	–	–	5SY4605-7	5SY4605-8	–	–	5SY4405-7	5SY4405-8
5SY4301-5	5SY4301-6	5SY4301-7	5SY4301-8	5SY4601-5	–	5SY4601-7	5SY4601-8	5SY4401-5	–	5SY4401-7	5SY4401-8
5SY4315-5	5SY4315-6	5SY4315-7	5SY4315-8	5SY4615-5	–	5SY4615-7	5SY4615-8	5SY4415-5	–	5SY4415-7	5SY4415-8
5SY4302-5	5SY4302-6	5SY4302-7	5SY4302-8	5SY4602-5	–	5SY4602-7	5SY4602-8	5SY4402-5	–	5SY4402-7	5SY4402-8
5SY4303-5	5SY4303-6	5SY4303-7	5SY4303-8	5SY4603-5	–	5SY4603-7	5SY4603-8	5SY4403-5	–	5SY4403-7	5SY4403-8
5SY4304-5	5SY4304-6	5SY4304-7	5SY4304-8	5SY4604-5	–	5SY4604-7	5SY4604-8	5SY4404-5	–	5SY4404-7	5SY4404-8
–	–	5SY4311-7	–	–	–	–	–	–	–	–	–
5SY4306-5	5SY4306-6	5SY4306-7	5SY4306-8	5SY4606-5	5SY4606-6	5SY4606-7	5SY4606-8	5SY4406-5	5SY4406-6	5SY4406-7	5SY4406-8
5SY4308-5	5SY4308-6	5SY4308-7	5SY4308-8	5SY4608-5	–	5SY4608-7	5SY4608-8	5SY4408-5	–	5SY4408-7	5SY4408-8
5SY4310-5	5SY4310-6	5SY4310-7	5SY4310-8	5SY4610-5	5SY4610-6	5SY4610-7	5SY4610-8	5SY4410-5	5SY4410-6	5SY4410-7	5SY4410-8
5SY4313-5	5SY4313-6	5SY4313-7	5SY4313-8	5SY4613-5	5SY4613-6	5SY4613-7	5SY4613-8	5SY4413-5	5SY4413-6	5SY4413-7	5SY4413-8
–	–	5SY4318-7	–	–	–	–	–	–	–	–	–
5SY4316-5	5SY4316-6	5SY4316-7	5SY4316-8	5SY4616-5	5SY4616-6	5SY4616-7	5SY4616-8	5SY4416-5	5SY4416-6	5SY4416-7	5SY4416-8
5SY4320-5	5SY4320-6	5SY4320-7	5SY4320-8	5SY4620-5	5SY4620-6	5SY4620-7	5SY4620-8	5SY4420-5	5SY4420-6	5SY4420-7	5SY4420-8
5SY4325-5	5SY4325-6	5SY4325-7	5SY4325-8	5SY4625-5	5SY4625-6	5SY4625-7	5SY4625-8	5SY4425-5	5SY4425-6	5SY4425-7	5SY4425-8
–	–	5SY4330-7	–	–	–	–	–	–	–	–	–
5SY4332-5	5SY4332-6	5SY4332-7	5SY4332-8	5SY4632-5	5SY4632-6	5SY4632-7	5SY4632-8	5SY4432-5	5SY4432-6	5SY4432-7	5SY4432-8
–	–	5SY4335-7	–	–	–	–	–	–	–	–	–
5SY4340-5	5SY4340-6	5SY4340-7	5SY4340-8	5SY4640-5	5SY4640-6	5SY4640-7	5SY4640-8	5SY4440-5	5SY4440-6	5SY4440-7	5SY4440-8
–	–	5SY4345-7	–	–	–	–	–	–	–	–	–
5SY4350-5	5SY4350-6	5SY4350-7	5SY4350-8	5SY4650-5	5SY4650-6	5SY4650-7	5SY4650-8	5SY4450-5	5SY4450-6	5SY4450-7	5SY4450-8
–	–	5SY4360-7	–	–	–	–	–	–	–	–	–
5SY4363-5	5SY4363-6	5SY4363-7	5SY4363-8	5SY4663-5	5SY4663-6	5SY4663-7	5SY4663-8	5SY4463-5	5SY4463-6	5SY4463-7	5SY4463-8
–	5SY4380-6	5SY4380-7	–	–	–	5SY4680-7	–	–	5SY4480-6	5SY4480-7	–

Accessories

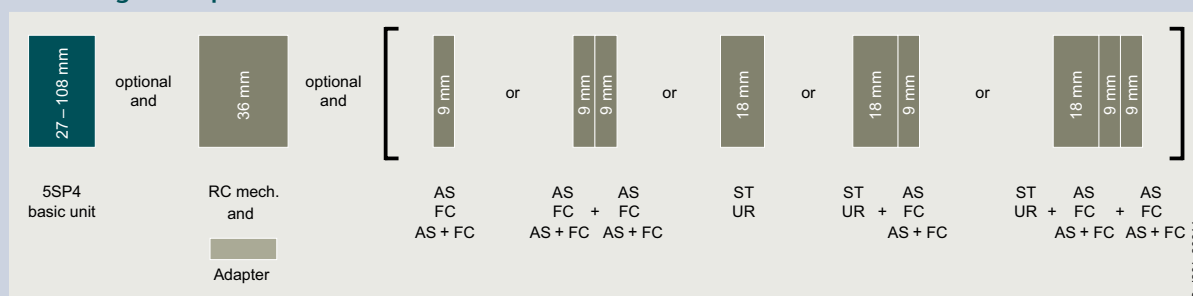
Auxiliary switches (AS)		Article No.	Arc fault detection units (AFDD)		Article No.
1 NO + 1 NC	Standard	5ST3010	For basic units 1P+N (2 MW)	I_n up to 16 A	5SM6021-2
	For low power	5ST3013		I_n up to 40 A	5SM6024-2
	For low power (with diode)	5ST3013-0XX01			
2 NO	Standard	5ST3011	Undervoltage releases (UR)		
	For low power	5ST3014	With integrated auxiliary switch	230 V AC	5ST3040
2 NC	Standard	5ST3012		110 V DC	5ST3041
	For low power	5ST3015		24 V DC	5ST3042
1 CO	Standard	5ST3016	Without integrated auxiliary switch	230 V AC	5ST3043
Fault signal contacts (FC)				110 V DC	5ST3044
				24 V DC	5ST3045
1 NO + 1 NC		5ST3020	Remote control mechanisms (RC mech.)		
2 NO		5ST3021	Basic	12 ... 30 V AC, 12 ... 48 V DC	5ST3053
2 NC		5ST3022		177 ... 270 V AC	5ST3054
Auxiliary switches and fault signal contacts (AS+FC)			Power	12 ... 30 V AC, 12 ... 48 V DC	5ST3055
1 CO (AS) + 1 CO (FC)		5ST3062		177 ... 270 V AC	5ST3056
5ST3 COM (AS+FC)		5ST3062-0MC	Power with ARD	12 ... 30 V AC, 12 ... 48 V DC	5ST3057
Shunt trips (ST)				177 ... 270 V AC	5ST3058
110 ... 415 V AC, 110 ... 220 V DC		5ST3030	Power with extended function	12 ... 30 V AC, 12 ... 48 V DC	5ST3070
24 ... 48 V AC/DC		5ST3031		170 ... 277 V AC, 77 ... 286 V DC	5ST3071
12 V DC		5ST3031-0XX01	Adapters for remote control mechanisms (RC mech.)		
			1 ... 2 MW		5ST3820-1
			3 ... 4 MW		5ST3820-2

5SP4 miniature circuit breakers

10 kA

	1P	2P	
Rated voltage U_n	230/400 V AC	400 V AC	
Mounting width	1.5 MW 	3 MW 	
Rated current I_n	Characteristic		
	B	C	D
80 A	5SP4180-6	5SP4180-7	5SP4180-8
100 A	5SP4191-6	5SP4191-7	5SP4191-8
125 A	5SP4192-6	5SP4192-7	–

Mounting concept



AS	Auxiliary switches	See page 3/50
FC	Fault signal contacts	See page 3/52
AS+FC	Auxiliary switches and fault signal contacts	See page 3/53
ST	Shunt trips	See page 3/56
UR	Undervoltage releases	See page 3/57
RC mech.	Remote control mechanisms	See page 3/58



3P			4P		
400 V AC			400 V AC		
4.5 MW			6 MW		
Characteristic			Characteristic		
B	C	D	B	C	D
5SP4380-6	5SP4380-7	5SP4380-8	5SP4480-6	5SP4480-7	5SP4480-8
5SP4391-6	5SP4391-7	5SP4391-8	5SP4491-6	5SP4491-7	5SP4491-8
5SP4392-6	5SP4392-7	–	5SP4492-6	5SP4492-7	–

3


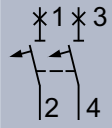
Accessories

Auxiliary switches (AS)		Article No.
1 NO + 1 NC	Standard	5ST3010
	For low power	5ST3013
	For low power (with diode)	5ST3013-0XX01
2 NO	Standard	5ST3011
	For low power	5ST3014
2 NC	Standard	5ST3012
	For low power	5ST3015
1 CO	Standard	5ST3016
Fault signal contacts (FC)		Article No.
1 NO + 1 NC		5ST3020
2 NO		5ST3021
2 NC		5ST3022
Auxiliary switches and fault signal contacts (AS+FC)		Article No.
1 CO (AS) + 1 CO (FC)		5ST3062
5ST3 COM (AS+FC)		5ST3062-0MC
Shunt trips (ST)		Article No.
110 ... 415 V AC, 110 ... 220 V DC		5ST3030
24 ... 48 V AC/DC		5ST3031
12 V DC		5ST3031-0XX01

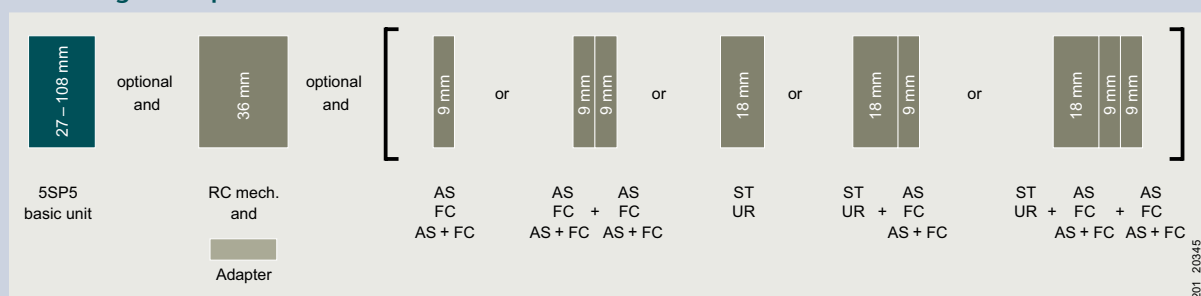
Undervoltage releases (UR)		Article No.
With integrated auxiliary switch	230 V AC	5ST3040
	110 V DC	5ST3041
	24 V DC	5ST3042
Without integrated auxiliary switch	230 V AC	5ST3043
	110 V DC	5ST3044
	24 V DC	5ST3045
Remote control mechanisms (RC mech.)		Article No.
Power	12 ... 30 V AC, 12 ... 48 V DC	5ST3055
	177 ... 270 V AC	5ST3056
Power with extended function	12 ... 30 V AC, 12 ... 48 V DC	5ST3070
	170 ... 277 V AC, 77 ... 286 V DC	5ST3071
Adapters for remote control mechanisms (RC mech.)		Article No.
1.5 MW		5ST3820-1
3 ... 6 MW		5ST3820-2

5SP5 miniature circuit breakers

10 kA

	1P	2P
Rated voltage U_n	220 V DC	440 V DC
Mounting width	1.5 MW 	3 MW 
Rated current I_n		
80 A	5SP5180-7CC	5SP5280-7CC
100 A	5SP5191-7CC	5SP5291-7CC
125 A	5SP5192-7CC	5SP5292-7CC

Mounting concept



AS Auxiliary switches

FC Fault signal contacts

AS+FC Auxiliary switches and fault signal contacts

ST Shunt trips

UR Undervoltage releases

RC mech. Remote control mechanisms

[See page 3/50](#)[See page 3/52](#)[See page 3/53](#)[See page 3/56](#)[See page 3/57](#)[See page 3/58](#)




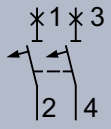
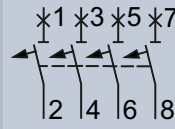
Accessories

Auxiliary switches (AS)		Article No.
1 NO + 1 NC	Standard	5ST3010
	For low power	5ST3013
	For low power (with diode)	5ST3013-0XX01
2 NO	Standard	5ST3011
	For low power	5ST3014
2 NC	Standard	5ST3012
	For low power	5ST3015
1 CO	Standard	5ST3016
Fault signal contacts (FC)		Article No.
1 NO + 1 NC		5ST3020
2 NO		5ST3021
2 NC		5ST3022
Auxiliary switches and fault signal contacts (AS+FC)		Article No.
1 CO (AS) + 1 CO (FC)		5ST3062
5ST3 COM (AS+FC)		5ST3062-0MC
Shunt trips (ST)		Article No.
110 ... 415 V AC, 110 ... 220 V DC		5ST3030
24 ... 48 V AC/DC		5ST3031
12 V DC		5ST3031-0XX01

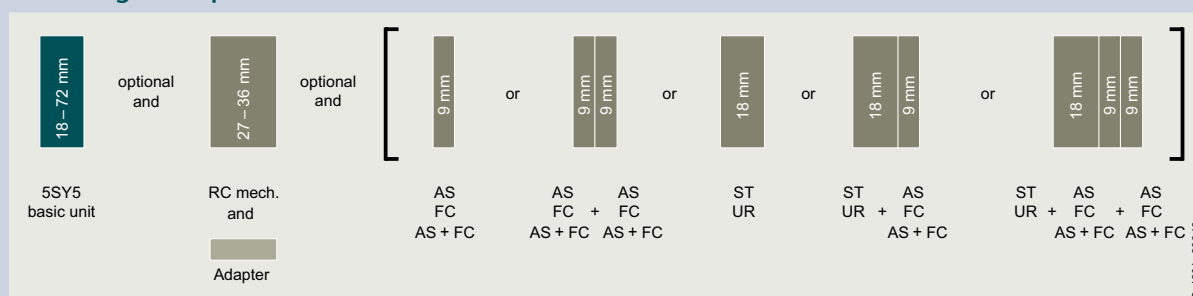
Undervoltage releases (UR)		Article No.
With integrated auxiliary switch	230 V AC	5ST3040
	110 V DC	5ST3041
	24 V DC	5ST3042
Without integrated auxiliary switch	230 V AC	5ST3043
	110 V DC	5ST3044
	24 V DC	5ST3045
Remote control mechanisms (RC mech.)		Article No.
Power	12 ... 30 V AC, 12 ... 48 V DC	5ST3055
	177 ... 270 V AC	5ST3056
Power with extended function	12 ... 30 V AC, 12 ... 48 V DC	5ST3070
	170 ... 277 V AC, 77 ... 286 V DC	5ST3071
Adapters for remote control mechanisms (RC mech.)		Article No.
1.5 MW		5ST3820-1
3 ... 6 MW		5ST3820-2

5SY5 miniature circuit breakers

10 kA

	1P	2P	4P			
Rated voltage U_n	230/400 V AC, 220 V DC	400 V AC, 440 V DC	400 V AC, 880 V DC			
Mounting width	1 MW 	2 MW 	4 MW 			
Rated current I_n	Characteristic		Characteristic		Characteristic	
	B	C	B	C	B	C
0.3 A	–	5SY5114-7	–	5SY5214-7	–	5SY5414-7
0.5 A	–	5SY5105-7	–	5SY5205-7	–	5SY5405-7
1 A	–	5SY5101-7	–	5SY5201-7	–	5SY5401-7
1.6 A	–	5SY5115-7	–	5SY5215-7	–	5SY5415-7
2 A	5SY5102-6	5SY5102-7	5SY5202-6	5SY5202-7	–	5SY5402-7
3 A	–	5SY5103-7	–	5SY5203-7	–	5SY5403-7
4 A	5SY5104-6	5SY5104-7	5SY5204-6	5SY5204-7	–	5SY5404-7
6 A	5SY5106-6	5SY5106-7	5SY5206-6	5SY5206-7	5SY5406-6	5SY5406-7
8 A	5SY5108-6	5SY5108-7	5SY5208-6	5SY5208-7	–	5SY5408-7
10 A	5SY5110-6	5SY5110-7	5SY5210-6	5SY5210-7	5SY5410-6	5SY5410-7
13 A	5SY5113-6	5SY5113-7	5SY5213-6	5SY5213-7	5SY5413-6	5SY5413-7
16 A	5SY5116-6	5SY5116-7	5SY5216-6	5SY5216-7	5SY5416-6	5SY5416-7
20 A	5SY5120-6	5SY5120-7	5SY5220-6	5SY5220-7	5SY5420-6	5SY5420-7
25 A	5SY5125-6	5SY5125-7	5SY5225-6	5SY5225-7	5SY5425-6	5SY5425-7
32 A	5SY5132-6	5SY5132-7	5SY5232-6	5SY5232-7	5SY5432-6	5SY5432-7
40 A	5SY5140-6	5SY5140-7	5SY5240-6	5SY5240-7	5SY5440-6	5SY5440-7
50 A	5SY5150-6	5SY5150-7	5SY5250-6	5SY5250-7	5SY5450-6	5SY5450-7
63 A	5SY5163-6	5SY5163-7	5SY5263-6	5SY5263-7	5SY5463-6	5SY5463-7

Mounting concept



AS	Auxiliary switches
FC	Fault signal contacts
AS+FC	Auxiliary switches and fault signal contacts
ST	Shunt trips
UR	Undervoltage releases
RC mech.	Remote control mechanisms

[See page 3/50](#)

[See page 3/52](#)

[See page 3/53](#)

[See page 3/56](#)

[See page 3/57](#)

[See page 3/58](#)





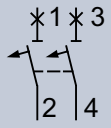
Accessories

Auxiliary switches (AS)		Article No.
1 NO + 1 NC	Standard	5ST3010
	For low power	5ST3013
	For low power (with diode)	5ST3013-0XX01
2 NO	Standard	5ST3011
	For low power	5ST3014
2 NC	Standard	5ST3012
	For low power	5ST3015
1 CO	Standard	5ST3016
Fault signal contacts (FC)		Article No.
1 NO + 1 NC		5ST3020
2 NO		5ST3021
2 NC		5ST3022
Auxiliary switches and fault signal contacts (AS+FC)		Article No.
1 CO (AS) + 1 CO (FC)		5ST3062
5ST3 COM (AS+FC)		5ST3062-0MC
Shunt trips (ST)		Article No.
110 ... 415 V AC, 110 ... 220 V DC		5ST3030
24 ... 48 V AC/DC		5ST3031
12 V DC		5ST3031-0XX01

Undervoltage releases (UR)		Article No.
With integrated auxiliary switch	230 V AC	5ST3040
	110 V DC	5ST3041
	24 V DC	5ST3042
Without integrated auxiliary switch	230 V AC	5ST3043
	110 V DC	5ST3044
	24 V DC	5ST3045
Remote control mechanisms (RC mech.)		Article No.
Basic	12 ... 30 V AC, 12 ... 48 V DC	5ST3053
	177 ... 270 V AC	5ST3054
Power	12 ... 30 V AC, 12 ... 48 V DC	5ST3055
	177 ... 270 V AC	5ST3056
Power with ARD	12 ... 30 V AC, 12 ... 48 V DC	5ST3057
	177 ... 270 V AC	5ST3058
Power with extended function	12 ... 30 V AC, 12 ... 48 V DC	5ST3070
	170 ... 277 V AC, 77 ... 286 V DC	5ST3071
Adapters for remote control mechanisms (RC mech.)		Article No.
1 ... 2 MW		5ST3820-1
4 MW		5ST3820-2

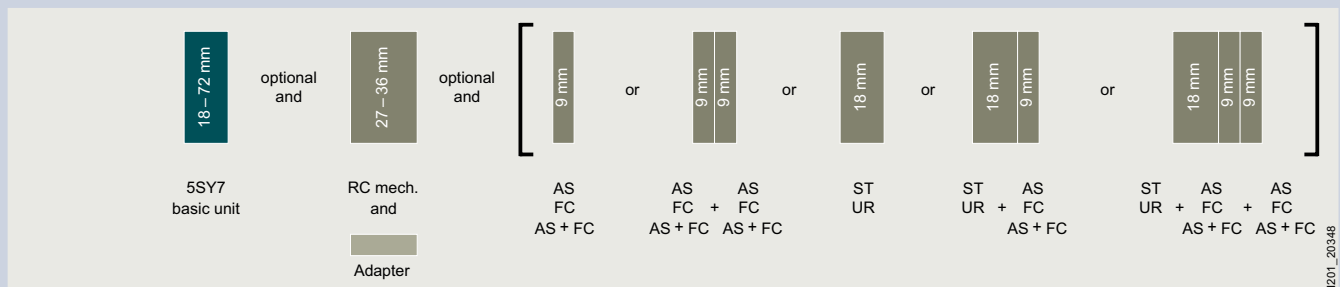
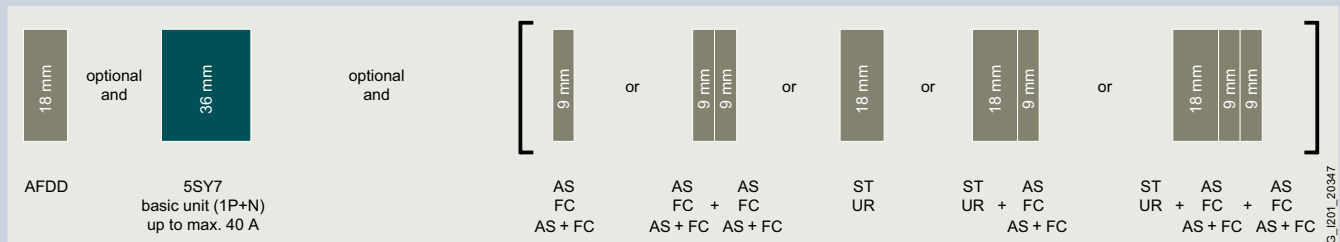
5SY7 miniature circuit breakers

15 kA

	1P	1P+N	2P
Rated voltage U_n	230/400 V AC	230 V AC	400 V AC
Mounting width	1 MW 	2 MW 	2 MW 

Rated current I_n	Main MCB, line side of meter	Characteristic			Characteristic			Characteristic		
		B	C	D	B	C	D	B	C	D
0.3 A	–	–	5SY7114-7	5SY7114-8	–	5SY7514-7	5SY7514-8	–	5SY7214-7	5SY7214-8
0.5 A	–	–	5SY7105-7	5SY7105-8	–	5SY7505-7	5SY7505-8	–	5SY7205-7	5SY7205-8
1 A	–	–	5SY7101-7	5SY7101-8	–	5SY7501-7	5SY7501-8	–	5SY7201-7	5SY7201-8
1.6 A	–	–	5SY7115-7	5SY7115-8	–	5SY7515-7	5SY7515-8	–	5SY7215-7	5SY7215-8
2 A	–	–	5SY7102-7	5SY7102-8	–	5SY7502-7	5SY7502-8	–	5SY7202-7	5SY7202-8
3 A	–	–	5SY7103-7	5SY7103-8	–	5SY7503-7	5SY7503-8	–	5SY7203-7	5SY7203-8
4 A	–	–	5SY7104-7	5SY7104-8	–	5SY7504-7	5SY7504-8	–	5SY7204-7	5SY7204-8
6 A	–	5SY7106-6	5SY7106-7	5SY7106-8	5SY7506-6	5SY7506-7	5SY7506-8	5SY7206-6	5SY7206-7	5SY7206-8
	■	5SY7106-6KK13	–	–	–	–	–	–	–	–
8 A	–	–	5SY7108-7	5SY7108-8	–	5SY7508-7	5SY7508-8	–	5SY7208-7	5SY7208-8
10 A	–	5SY7110-6	5SY7110-7	5SY7110-8	5SY7510-6	5SY7510-7	5SY7510-8	5SY7210-6	5SY7210-7	5SY7210-8
	■	5SY7110-6KK13	–	–	–	–	–	–	–	–
13 A	–	5SY7113-6	5SY7113-7	5SY7113-8	5SY7513-6	5SY7513-7	5SY7513-8	5SY7213-6	5SY7213-7	5SY7213-8
16 A	–	5SY7116-6	5SY7116-7	5SY7116-8	5SY7516-6	5SY7516-7	5SY7516-8	5SY7216-6	5SY7216-7	5SY7216-8
20 A	–	5SY7120-6	5SY7120-7	5SY7120-8	5SY7520-6	5SY7520-7	5SY7520-8	5SY7220-6	5SY7220-7	5SY7220-8
25 A	–	5SY7125-6	5SY7125-7	5SY7125-8	5SY7525-6	5SY7525-7	5SY7525-8	5SY7225-6	5SY7225-7	5SY7225-8
32 A	–	5SY7132-6	5SY7132-7	5SY7132-8	5SY7532-6	5SY7532-7	5SY7532-8	5SY7232-6	5SY7232-7	5SY7232-8
40 A	–	5SY7140-6	5SY7140-7	5SY7140-8	5SY7540-6	5SY7540-7	5SY7540-8	5SY7240-6	5SY7240-7	5SY7240-8
50 A	–	5SY7150-6	5SY7150-7	5SY7150-8	5SY7550-6	5SY7550-7	5SY7550-8	5SY7250-6	5SY7250-7	5SY7250-8
63 A	–	5SY7163-6	5SY7163-7	5SY7163-8	5SY7563-6	5SY7563-7	5SY7563-8	5SY7263-6	5SY7263-7	5SY7263-8

Mounting concept



AFDD Arc fault detection units [See page 3/59](#) AS+FC Auxiliary switches and fault signal contacts [See page 3/53](#) UR Undervoltage releases [See page 3/57](#)
AS Auxiliary switches [See page 3/50](#) ST Shunt trips [See page 3/56](#) RC mech. Remote control mechanisms [See page 3/58](#)
FC Fault signal contacts [See page 3/52](#)



3P			3P+N			4P		
400 V AC			400 V AC			400 V AC		
3 MW			4 MW			4 MW		
Characteristic			Characteristic			Characteristic		
B	C	D	B	C	D	B	C	D
–	5SY7314-7	5SY7314-8	–	5SY7614-7	5SY7614-8	–	5SY7414-7	5SY7414-8
–	5SY7305-7	5SY7305-8	–	5SY7605-7	5SY7605-8	–	5SY7405-7	5SY7405-8
–	5SY7301-7	5SY7301-8	–	5SY7601-7	5SY7601-8	–	5SY7401-7	5SY7401-8
–	5SY7315-7	5SY7315-8	–	5SY7615-7	5SY7615-8	–	5SY7415-7	5SY7415-8
–	5SY7302-7	5SY7302-8	–	5SY7602-7	5SY7602-8	–	5SY7402-7	5SY7402-8
–	5SY7303-7	5SY7303-8	–	5SY7603-7	5SY7603-8	–	5SY7403-7	5SY7403-8
–	5SY7304-7	5SY7304-8	–	5SY7604-7	5SY7604-8	–	5SY7404-7	5SY7404-8
5SY7306-6	5SY7306-7	5SY7306-8	5SY7606-6	5SY7606-7	5SY7606-8	5SY7406-6	5SY7406-7	5SY7406-8
–	–	–	–	–	–	–	–	–
–	5SY7308-7	5SY7308-8	–	5SY7608-7	5SY7608-8	–	5SY7408-7	5SY7408-8
5SY7310-6	5SY7310-7	5SY7310-8	5SY7610-6	5SY7610-7	5SY7610-8	5SY7410-6	5SY7410-7	5SY7410-8
–	–	–	–	–	–	–	–	–
5SY7313-6	5SY7313-7	5SY7313-8	5SY7613-6	5SY7613-7	5SY7613-8	5SY7413-6	5SY7413-7	5SY7413-8
5SY7316-6	5SY7316-7	5SY7316-8	5SY7616-6	5SY7616-7	5SY7616-8	5SY7416-6	5SY7416-7	5SY7416-8
5SY7320-6	5SY7320-7	5SY7320-8	5SY7620-6	5SY7620-7	5SY7620-8	5SY7420-6	5SY7420-7	5SY7420-8
5SY7325-6	5SY7325-7	5SY7325-8	5SY7625-6	5SY7625-7	5SY7625-8	5SY7425-6	5SY7425-7	5SY7425-8
5SY7332-6	5SY7332-7	5SY7332-8	5SY7632-6	5SY7632-7	5SY7632-8	5SY7432-6	5SY7432-7	5SY7432-8
5SY7340-6	5SY7340-7	5SY7340-8	5SY7640-6	5SY7640-7	5SY7640-8	5SY7440-6	5SY7440-7	5SY7440-8
5SY7350-6	5SY7350-7	5SY7350-8	5SY7650-6	5SY7650-7	5SY7650-8	5SY7450-6	5SY7450-7	5SY7450-8
5SY7363-6	5SY7363-7	5SY7363-8	5SY7663-6	5SY7663-7	5SY7663-8	5SY7463-6	5SY7463-7	5SY7463-8




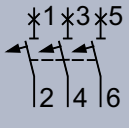
Accessories

Auxiliary switches (AS)		Article No.	Undervoltage releases (UR)		Article No.
1 NO + 1 NC	Standard	5ST3010	With integrated auxiliary switch	230 V AC	5ST3040
	For low power	5ST3013		110 V DC	5ST3041
	For low power (with diode)	5ST3013-0XX01		24 V DC	5ST3042
2 NO	Standard	5ST3011	Without integrated auxiliary switch	230 V AC	5ST3043
	For low power	5ST3014		110 V DC	5ST3044
2 NC	Standard	5ST3012		24 V DC	5ST3045
	For low power	5ST3015			
1 CO	Standard	5ST3016	Remote control mechanisms (RC mech.)		Article No.
Fault signal contacts (FC)		Article No.	Basic	12 ... 30 V AC, 12 ... 48 V DC	5ST3053
1 NO + 1 NC		5ST3020		177 ... 270 V AC	5ST3054
2 NO		5ST3021	Power	12 ... 30 V AC, 12 ... 48 V DC	5ST3055
2 NC		5ST3022		177 ... 270 V AC	5ST3056
Auxiliary switches and fault signal contacts (AS+FC)		Article No.	Power with ARD	12 ... 30 V AC, 12 ... 48 V DC	5ST3057
1 CO (AS) + 1 CO (FC)		5ST3062		177 ... 270 V AC	5ST3058
5ST3 COM (AS+FC)		5ST3062-0MC	Power with extended function	12 ... 30 V AC, 12 ... 48 V DC	5ST3070
				170 ... 277 V AC, 77 ... 286 V DC	5ST3071
Shunt trips (ST)		Article No.	Adapters for remote control mechanisms (RC mech.)		Article No.
110 ... 415 V AC, 110 ... 220 V DC		5ST3030	1 ... 2 MW		5ST3820-1
24 ... 48 V AC/DC		5ST3031	3 ... 4 MW		5ST3820-2
12 V DC		5ST3031-0XX01	Arc fault detection units (AFDD)		Article No.
			For basic units 1P+N	I_n up to 16 A	5SM6021-2
			(2 MW)	I_n up to 40 A	5SM6024-2

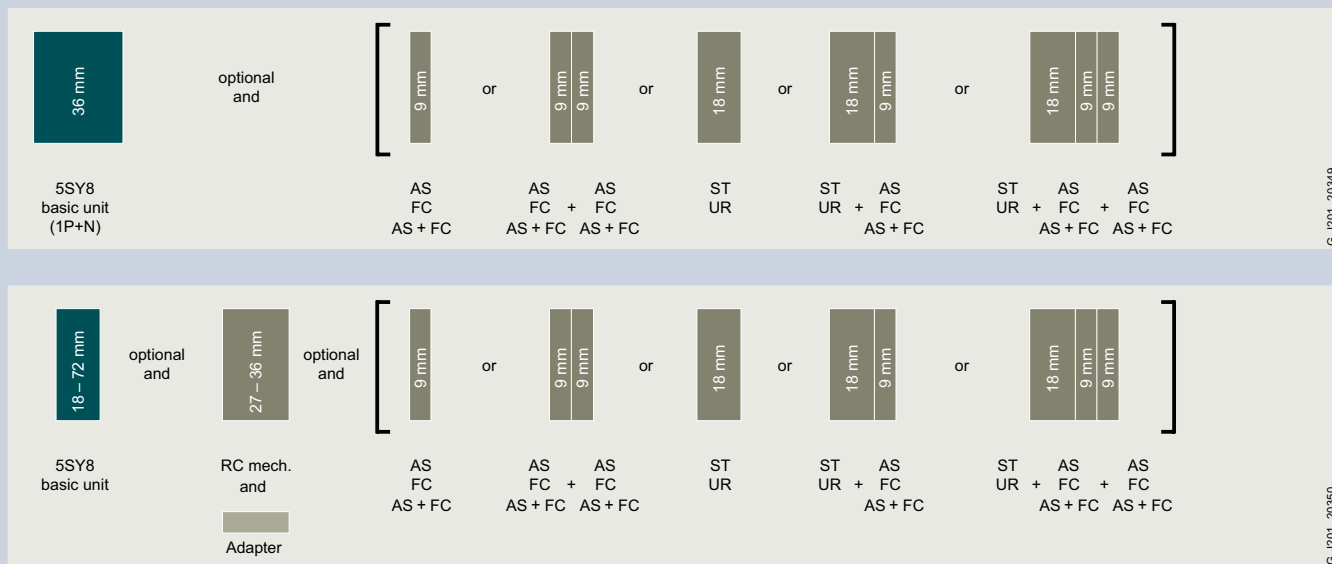
5SY8 miniature circuit breakers

25 kA

3

	1P	1P+N	2P	3P				
Rated voltage U_n	230/400 V AC	230 V AC	400 V AC	400 V AC				
Mounting width	1 MW 	2 MW 	2 MW 	3 MW 				
Rated current I_n	Characteristic		Characteristic		Characteristic		Characteristic	
	C	D	C	D	C	D	C	D
0.3 A	5SY8114-7	5SY8114-8	5SY8514-7	5SY8514-8	5SY8214-7	5SY8214-8	5SY8314-7	5SY8314-8
0.5 A	5SY8105-7	5SY8105-8	5SY8505-7	5SY8505-8	5SY8205-7	5SY8205-8	5SY8305-7	5SY8305-8
1 A	5SY8101-7	5SY8101-8	5SY8501-7	5SY8501-8	5SY8201-7	5SY8201-8	5SY8301-7	5SY8301-8
1.6 A	5SY8115-7	5SY8115-8	5SY8515-7	5SY8515-8	5SY8215-7	5SY8215-8	5SY8315-7	5SY8315-8
2 A	5SY8102-7	5SY8102-8	5SY8502-7	5SY8502-8	5SY8202-7	5SY8202-8	5SY8302-7	5SY8302-8
3 A	5SY8103-7	5SY8103-8	5SY8503-7	5SY8503-8	5SY8203-7	5SY8203-8	5SY8303-7	5SY8303-8
4 A	5SY8104-7	5SY8104-8	5SY8504-7	5SY8504-8	5SY8204-7	5SY8204-8	5SY8304-7	5SY8304-8
6 A	5SY8106-7	5SY8106-8	5SY8506-7	5SY8506-8	5SY8206-7	5SY8206-8	5SY8306-7	5SY8306-8
8 A	5SY8108-7	5SY8108-8	5SY8508-7	5SY8508-8	5SY8208-7	5SY8208-8	5SY8308-7	5SY8308-8
10 A	5SY8110-7	5SY8110-8	5SY8510-7	5SY8510-8	5SY8210-7	5SY8210-8	5SY8310-7	5SY8310-8
12.5 A	–	–	–	–	–	–	–	–
13 A	5SY8113-7	5SY8113-8	5SY8513-7	5SY8513-8	5SY8213-7	5SY8213-8	5SY8313-7	5SY8313-8
16 A	5SY8116-7	5SY8116-8	5SY8516-7	5SY8516-8	5SY8216-7	5SY8216-8	5SY8316-7	5SY8316-8
20 A	5SY8120-7	5SY8120-8	5SY8520-7	5SY8520-8	5SY8220-7	5SY8220-8	5SY8320-7	5SY8320-8
25 A	5SY8125-7	5SY8125-8	5SY8525-7	5SY8525-8	5SY8225-7	5SY8225-8	5SY8325-7	5SY8325-8
32 A	5SY8132-7	5SY8132-8	5SY8532-7	5SY8532-8	5SY8232-7	5SY8232-8	5SY8332-7	5SY8332-8
40 A	5SY8140-7	5SY8140-8	5SY8540-7	5SY8540-8	5SY8240-7	5SY8240-8	5SY8340-7	5SY8340-8
50 A	5SY8150-7	5SY8150-8	5SY8550-7	5SY8550-8	5SY8250-7	5SY8250-8	5SY8350-7	5SY8350-8
63 A	5SY8163-7	5SY8163-8	5SY8563-7	5SY8563-8	5SY8263-7	5SY8263-8	5SY8363-7	5SY8363-8

Mounting concept



- AFDD Arc fault detection units [See page 3/59](#)
- AS Auxiliary switches [See page 3/50](#)
- FC Fault signal contacts [See page 3/52](#)
- AS+FC Auxiliary switches and fault signal contacts [See page 3/53](#)
- ST Shunt trips [See page 3/56](#)
- UR Undervoltage releases [See page 3/57](#)
- RC mech. Remote control mechanisms [See page 3/58](#)



3P+N		4P	
400 V AC		400 V AC	
4 MW		4 MW	
Characteristic		Characteristic	
C	D	C	D
5SY8614-7	5SY8614-8	5SY8414-7	5SY8414-8
5SY8605-7	5SY8605-8	5SY8405-7	5SY8405-8
5SY8601-7	5SY8601-8	5SY8401-7	5SY8401-8
5SY8615-7	5SY8615-8	5SY8415-7	5SY8415-8
5SY8602-7	5SY8602-8	5SY8402-7	5SY8402-8
5SY8603-7	5SY8603-8	5SY8403-7	5SY8403-8
5SY8604-7	5SY8604-8	5SY8404-7	5SY8404-8
5SY8606-7	5SY8606-8	5SY8406-7	5SY8406-8
5SY8608-7	5SY8608-8	5SY8408-7	5SY8408-8
5SY8610-7	5SY8610-8	5SY8410-7	5SY8410-8
–	–	–	–
5SY8613-7	5SY8613-8	5SY8413-7	5SY8413-8
5SY8616-7	5SY8616-8	5SY8416-7	5SY8416-8
5SY8620-7	5SY8620-8	5SY8420-7	5SY8420-8
5SY8625-7	5SY8625-8	5SY8425-7	5SY8425-8
5SY8632-7	5SY8632-8	5SY8432-7	5SY8432-8
5SY8640-7	5SY8640-8	5SY8440-7	5SY8440-8
5SY8650-7	5SY8650-8	5SY8450-7	5SY8450-8
5SY8663-7	5SY8663-8	5SY8463-7	5SY8463-8

Accessories

Auxiliary switches (AS)		Article No.
1 NO + 1 NC	Standard	5ST3010
	For low power	5ST3013
	For low power (with diode)	5ST3013-0XX01
2 NO	Standard	5ST3011
	For low power	5ST3014
2 NC	Standard	5ST3012
	For low power	5ST3015
1 CO	Standard	5ST3016
Fault signal contacts (FC)		Article No.
1 NO + 1 NC		5ST3020
2 NO		5ST3021
2 NC		5ST3022
Auxiliary switches and fault signal contacts (AS+FC)		Article No.
1 CO (AS) + 1 CO (FC)		5ST3062
5ST3 COM (AS+FC)		5ST3062-0MC
Shunt trips (ST)		Article No.
110 ... 415 V AC, 110 ... 220 V DC		5ST3030
24 ... 48 V AC/DC		5ST3031
12 V DC		5ST3031-0XX01

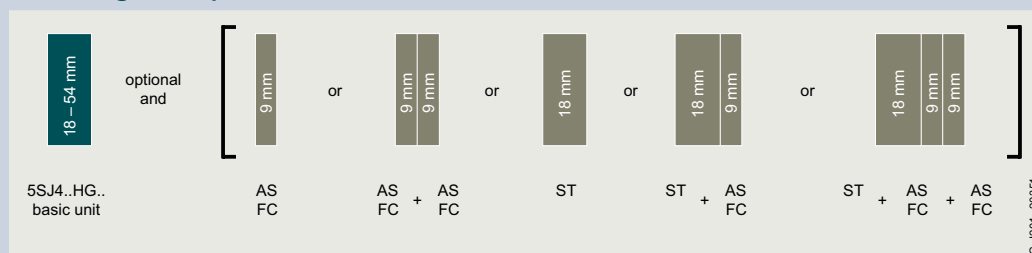
Undervoltage releases (UR)		Article No.
With integrated auxiliary switch	230 V AC	5ST3040
	110 V DC	5ST3041
	24 V DC	5ST3042
Without integrated auxiliary switch	230 V AC	5ST3043
	110 V DC	5ST3044
	24 V DC	5ST3045
Remote control mechanisms (RC mech.)		Article No.
Basic	12 ... 30 V AC, 12 ... 48 V DC	5ST3053
	177 ... 270 V AC	5ST3054
Power	12 ... 30 V AC, 12 ... 48 V DC	5ST3055
	177 ... 270 V AC	5ST3056
Power with ARD	12 ... 30 V AC, 12 ... 48 V DC	5ST3057
	177 ... 270 V AC	5ST3058
Power with extended function	12 ... 30 V AC, 12 ... 48 V DC	5ST3070
	170 ... 277 V AC, 77 ... 286 V DC	5ST3071
Adapters for remote control mechanisms (RC mech.)		Article No.
1 ... 2 MW		5ST3820-1
3 ... 4 MW		5ST3820-2

5SJ4..HG.. miniature circuit breakers

According to UL489, 14/10 kA

Rated voltage U_n Mounting width	1P "same polarity only"			1P			
	240 V AC	240 V AC	240 V AC	240 V AC	480Y/277 V AC	240 V AC	480Y/277 V AC
1 MW							
Rated current I_n	Characteristic			Characteristic			
	B	C	D	C	C	D	D
0.3 A	–	5SJ4114-7HG40	5SJ4114-8HG40	5SJ4114-7HG41	5SJ4114-7HG42	5SJ4114-8HG41	5SJ4114-8HG42
0.5 A	–	5SJ4105-7HG40	5SJ4105-8HG40	5SJ4105-7HG41	5SJ4105-7HG42	5SJ4105-8HG41	5SJ4105-8HG42
1 A	–	5SJ4101-7HG40	5SJ4101-8HG40	5SJ4101-7HG41	5SJ4101-7HG42	5SJ4101-8HG41	5SJ4101-8HG42
1.6 A	–	5SJ4115-7HG40	5SJ4115-8HG40	5SJ4115-7HG41	5SJ4115-7HG42	5SJ4115-8HG41	5SJ4115-8HG42
2 A	–	5SJ4102-7HG40	5SJ4102-8HG40	5SJ4102-7HG41	5SJ4102-7HG42	5SJ4102-8HG41	5SJ4102-8HG42
3 A	–	5SJ4103-7HG40	5SJ4103-8HG40	5SJ4103-7HG41	5SJ4103-7HG42	5SJ4103-8HG41	5SJ4103-8HG42
4 A	–	5SJ4104-7HG40	5SJ4104-8HG40	5SJ4104-7HG41	5SJ4104-7HG42	5SJ4104-8HG41	5SJ4104-8HG42
5 A	–	5SJ4111-7HG40	5SJ4111-8HG40	5SJ4111-7HG41	5SJ4111-7HG42	5SJ4111-8HG41	5SJ4111-8HG42
6 A	5SJ4106-6HG40	5SJ4106-7HG40	5SJ4106-8HG40	5SJ4106-7HG41	5SJ4106-7HG42	5SJ4106-8HG41	5SJ4106-8HG42
8 A	–	5SJ4108-7HG40	5SJ4108-8HG40	5SJ4108-7HG41	5SJ4108-7HG42	5SJ4108-8HG41	5SJ4108-8HG42
10 A	5SJ4110-6HG40	5SJ4110-7HG40	5SJ4110-8HG40	5SJ4110-7HG41	5SJ4110-7HG42	5SJ4110-8HG41	5SJ4110-8HG42
13 A	5SJ4113-6HG40	5SJ4113-7HG40	5SJ4113-8HG40	5SJ4113-7HG41	5SJ4113-7HG42	5SJ4113-8HG41	5SJ4113-8HG42
15 A	5SJ4118-6HG40	5SJ4118-7HG40	5SJ4118-8HG40	5SJ4118-7HG41	5SJ4118-7HG42	5SJ4118-8HG41	5SJ4118-8HG42
16 A	5SJ4116-6HG40	5SJ4116-7HG40	5SJ4116-8HG40	5SJ4116-7HG41	5SJ4116-7HG42	5SJ4116-8HG41	5SJ4116-8HG42
20 A	5SJ4120-6HG40	5SJ4120-7HG40	5SJ4120-8HG40	5SJ4120-7HG41	5SJ4120-7HG42	5SJ4120-8HG41	5SJ4120-8HG42
25 A	5SJ4125-6HG40	5SJ4125-7HG40	5SJ4125-8HG40	5SJ4125-7HG41	5SJ4125-7HG42	5SJ4125-8HG41	5SJ4125-8HG42
30 A	5SJ4130-6HG40	5SJ4130-7HG40	5SJ4130-8HG40	5SJ4130-7HG41	5SJ4130-7HG42	5SJ4130-8HG41	5SJ4130-8HG42
32 A	5SJ4132-6HG40	5SJ4132-7HG40	5SJ4132-8HG40	5SJ4132-7HG41	5SJ4132-7HG42	5SJ4132-8HG41	5SJ4132-8HG42
35 A	5SJ4135-6HG40	5SJ4135-7HG40	5SJ4135-8HG40	5SJ4135-7HG41	5SJ4135-7HG42	5SJ4135-8HG41	–
40 A	5SJ4140-6HG40	5SJ4140-7HG40	5SJ4140-8HG40	5SJ4140-7HG41	5SJ4140-7HG42	5SJ4140-8HG41	–
45 A	5SJ4145-6HG40	5SJ4145-7HG40	5SJ4145-8HG40	5SJ4145-7HG41	–	5SJ4145-8HG41	–
50 A	5SJ4150-6HG40	5SJ4150-7HG40	5SJ4150-8HG40	5SJ4150-7HG41	–	5SJ4150-8HG41	–
60 A	5SJ4160-6HG40	5SJ4160-7HG40	5SJ4160-8HG40	5SJ4160-7HG41	–	5SJ4160-8HG41	–
63 A	5SJ4163-6HG40	5SJ4163-7HG40	5SJ4163-8HG40	5SJ4163-7HG41	–	5SJ4163-8HG41	–

Mounting concept



AS Auxiliary switches
FC Fault signal contacts
ST Shunt trips

[See page 3/50](#)
[See page 3/52](#)
[See page 3/56](#)



2P				3P			
240 V AC	480Y/277 V AC	240 V AC	480Y/277 V AC	240 V AC	480Y/277 V AC	240 V AC	480Y/277 V AC
2 MW				3 MW			
Characteristic				Characteristic			
C	C	D	D	C	C	D	D
5SJ4214-7HG41	5SJ4214-7HG42	5SJ4214-8HG41	5SJ4214-8HG42	5SJ4314-7HG41	5SJ4314-7HG42	5SJ4314-8HG41	5SJ4314-8HG42
5SJ4205-7HG41	5SJ4205-7HG42	5SJ4205-8HG41	5SJ4205-8HG42	5SJ4305-7HG41	5SJ4305-7HG42	5SJ4305-8HG41	5SJ4305-8HG42
5SJ4201-7HG41	5SJ4201-7HG42	5SJ4201-8HG41	5SJ4201-8HG42	5SJ4301-7HG41	5SJ4301-7HG42	5SJ4301-8HG41	5SJ4301-8HG42
5SJ4215-7HG41	5SJ4215-7HG42	5SJ4215-8HG41	5SJ4215-8HG42	5SJ4315-7HG41	5SJ4315-7HG42	5SJ4315-8HG41	5SJ4315-8HG42
5SJ4202-7HG41	5SJ4202-7HG42	5SJ4202-8HG41	5SJ4202-8HG42	5SJ4302-7HG41	5SJ4302-7HG42	5SJ4302-8HG41	5SJ4302-8HG42
5SJ4203-7HG41	5SJ4203-7HG42	5SJ4203-8HG41	5SJ4203-8HG42	5SJ4303-7HG41	5SJ4303-7HG42	5SJ4303-8HG41	5SJ4303-8HG42
5SJ4204-7HG41	5SJ4204-7HG42	5SJ4204-8HG41	5SJ4204-8HG42	5SJ4304-7HG41	5SJ4304-7HG42	5SJ4304-8HG41	5SJ4304-8HG42
5SJ4211-7HG41	5SJ4211-7HG42	5SJ4211-8HG41	5SJ4211-8HG42	5SJ4311-7HG41	5SJ4311-7HG42	5SJ4311-8HG41	5SJ4311-8HG42
5SJ4206-7HG41	5SJ4206-7HG42	5SJ4206-8HG41	5SJ4206-8HG42	5SJ4306-7HG41	5SJ4306-7HG42	5SJ4306-8HG41	5SJ4306-8HG42
5SJ4208-7HG41	5SJ4208-7HG42	5SJ4208-8HG41	5SJ4208-8HG42	5SJ4308-7HG41	5SJ4308-7HG42	5SJ4308-8HG41	5SJ4308-8HG42
5SJ4210-7HG41	5SJ4210-7HG42	5SJ4210-8HG41	5SJ4210-8HG42	5SJ4310-7HG41	5SJ4310-7HG42	5SJ4310-8HG41	5SJ4310-8HG42
5SJ4213-7HG41	5SJ4213-7HG42	5SJ4213-8HG41	5SJ4213-8HG42	5SJ4313-7HG41	5SJ4313-7HG42	5SJ4313-8HG41	5SJ4313-8HG42
5SJ4218-7HG41	5SJ4218-7HG42	5SJ4218-8HG41	5SJ4218-8HG42	5SJ4318-7HG41	5SJ4318-7HG42	5SJ4318-8HG41	5SJ4318-8HG42
5SJ4216-7HG41	5SJ4216-7HG42	5SJ4216-8HG41	5SJ4216-8HG42	5SJ4316-7HG41	5SJ4316-7HG42	5SJ4316-8HG41	5SJ4316-8HG42
5SJ4220-7HG41	5SJ4220-7HG42	5SJ4220-8HG41	5SJ4220-8HG42	5SJ4320-7HG41	5SJ4320-7HG42	5SJ4320-8HG41	5SJ4320-8HG42
5SJ4225-7HG41	5SJ4225-7HG42	5SJ4225-8HG41	5SJ4225-8HG42	5SJ4325-7HG41	5SJ4325-7HG42	5SJ4325-8HG41	5SJ4325-8HG42
5SJ4230-7HG41	5SJ4230-7HG42	5SJ4230-8HG41	5SJ4230-8HG42	5SJ4330-7HG41	5SJ4330-7HG42	5SJ4330-8HG41	5SJ4330-8HG42
5SJ4232-7HG41	5SJ4232-7HG42	5SJ4232-8HG41	5SJ4232-8HG42	5SJ4332-7HG41	5SJ4332-7HG42	5SJ4332-8HG41	5SJ4332-8HG42
5SJ4235-7HG41	5SJ4235-7HG42	5SJ4235-8HG41	–	5SJ4335-7HG41	5SJ4335-7HG42	5SJ4335-8HG41	–
5SJ4240-7HG41	5SJ4240-7HG42	5SJ4240-8HG41	–	5SJ4340-7HG41	5SJ4340-7HG42	5SJ4340-8HG41	–
5SJ4245-7HG41	–	5SJ4245-8HG41	–	5SJ4345-7HG41	–	5SJ4345-8HG41	–
5SJ4250-7HG41	–	5SJ4250-8HG41	–	5SJ4350-7HG41	–	5SJ4350-8HG41	–
5SJ4260-7HG41	–	5SJ4260-8HG41	–	5SJ4360-7HG41	–	5SJ4360-8HG41	–
5SJ4263-7HG41	–	5SJ4263-8HG41	–	5SJ4363-7HG41	–	5SJ4363-8HG41	–

Accessories

Auxiliary switches (AS) acc. to UL 489	Article No.
1 NO + 1 NC	5ST3010-OHG
2 NO	5ST3011-OHG
2 NC	5ST3012-OHG
Fault signal contacts (FC) acc. to UL 489	Article No.
1 NO + 1 NC	5ST3020-OHG
2 NO	5ST3021-OHG
2 NC	5ST3022-OHG
Shunt trips (ST) acc. to UL 489	Article No.
110 ... 415 V AC, 110 ... 220 V DC	5ST3030-OHG
24 ... 48 V AC/DC	5ST3031-OHG

5SL6 COM miniature circuit breakers with communication and measuring function

With energy monitoring (EM), 1P+N 6 kA compact miniature circuit breakers

1P+N (N pole right)

Rated voltage U_n 230 V AC
Mounting width 1 MW



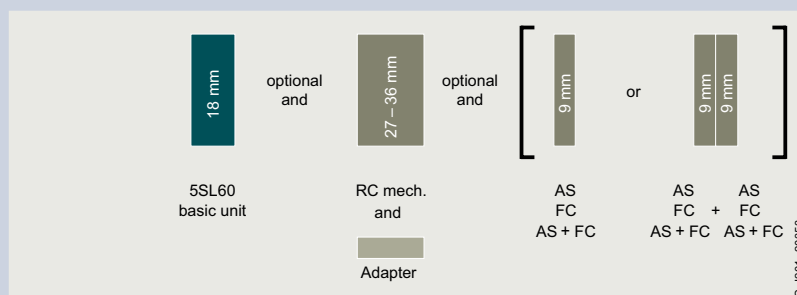
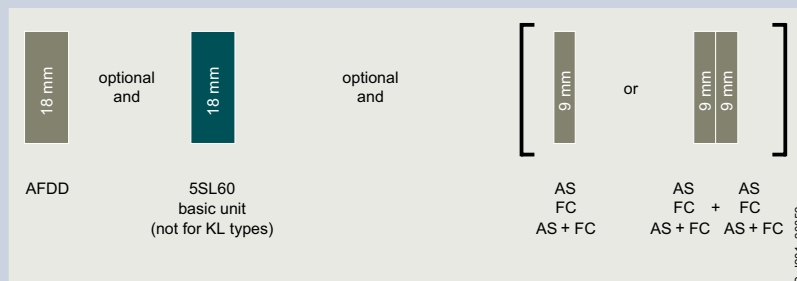
Rated current I_n	Characteristic	
	B	C
2 A	5SL6002-6MC	5SL6002-7MC
4 A	5SL6004-6MC	5SL6004-7MC
6 A	5SL6006-6MC	5SL6006-7MC
8 A	–	5SL6008-7MC
10 A	5SL6010-6MC	5SL6010-7MC
13 A	5SL6013-6MC	5SL6013-7MC
16 A	5SL6016-6MC	5SL6016-7MC
20 A	5SL6020-6MC	5SL6020-7MC
25 A	5SL6025-6MC	5SL6025-7MC
32 A	5SL6032-6MC	5SL6032-7MC

Note:

Please note the country-specific radio licenses of the products at

www.siemens.com/lowvoltage/certificates
(109801197)

Mounting concept



AFDD Arc fault detection units
AS Auxiliary switches
FC Fault signal contacts
AS+FC Auxiliary switches and fault signal contacts
RC mech. Remote control mechanisms

See page 3/59
See page 3/50
See page 3/52
See page 3/53
See page 3/58


Accessories

Auxiliary switches (AS)		Article No.
1 NO + 1 NC	Standard	5ST3010
	For low power	5ST3013
	For low power (with diode)	5ST3013-0XX01
2 NO	Standard	5ST3011
	For low power	5ST3014
2 NC	Standard	5ST3012
	For low power	5ST3015
1 CO	Standard	5ST3016
Fault signal contacts (FC)		Article No.
1 NO + 1 NC		5ST3020
2 NO		5ST3021
2 NC		5ST3022
Auxiliary switches and fault signal contacts (AS+FC)		Article No.
1 CO (AS) + 1 CO (FC)		5ST3062
5ST3 COM (AS+FC)		5ST3062-0MC

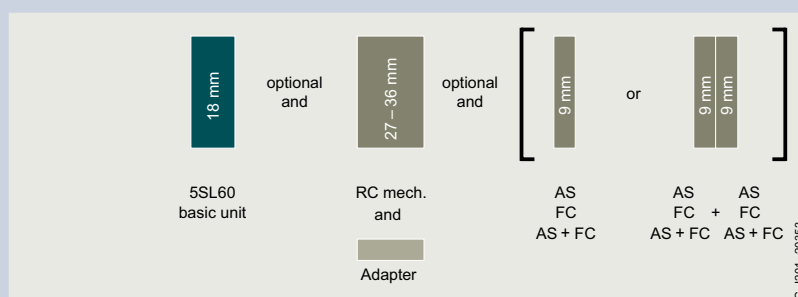
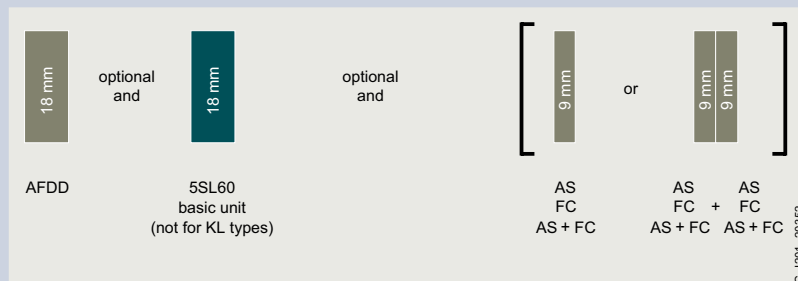
Remote control mechanisms (RC mech.)		Article No.
Basic	12 ... 30 V AC, 12 ... 48 V DC	5ST3053
	177 ... 270 V AC	5ST3054
Power	12 ... 30 V AC, 12 ... 48 V DC	5ST3055
	177 ... 270 V AC	5ST3056
Power with ARD	12 ... 30 V AC, 12 ... 48 V DC	5ST3057
	177 ... 270 V AC	5ST3058
Power with extended function	12 ... 30 V AC, 12 ... 48 V DC	5ST3070
	170 ... 277 V AC, 77 ... 286 V DC	5ST3071
Adapters for remote control mechanisms (RC mech.)		Article No.
1 MW		5ST3820-6
Arc fault detection units (AFDD)		Article No.
For basic units 1P + N	I_n up to 16 A	5SM6011-2
(1 MW), not for KL types	I_n up to 40 A	5SM6014-2
Data transceiver (essential accessory)		Article No.
SENTRON Powercenter 1000		7KN1110-0MC00

5SL6 COM miniature circuit breakers with communication and measuring function

With residual current monitoring (RCM) and energy monitoring (EM),
1P+N 6 kA compact miniature circuit breakers

1P+N (N pole right)	
Rated voltage U_n	230 V AC
Mounting width	1 MW
	
Rated current I_n	Characteristic
	B C
2 A	– 5SL6002-7MF
4 A	– 5SL6004-7MF
6 A	5SL6006-6MF 5SL6006-7MF
8 A	– 5SL6008-7MF
10 A	5SL6010-6MF 5SL6010-7MF
13 A	5SL6013-6MF 5SL6013-7MF
16 A	5SL6016-6MF 5SL6016-7MF
20 A	5SL6020-6MF 5SL6020-7MF
25 A	5SL6025-6MF 5SL6025-7MF
32 A	5SL6032-6MF 5SL6032-7MF

Mounting concept



Note:

Please note the country-specific radio licenses of the products at www.siemens.com/lowvoltage/certificates (109801197)

AFDD	Arc fault detection units
AS	Auxiliary switches
FC	Fault signal contacts
AS+FC	Auxiliary switches and fault signal contacts
RC mech.	Remote control mechanisms

See page 3/59
See page 3/50
See page 3/52
See page 3/53
See page 3/58

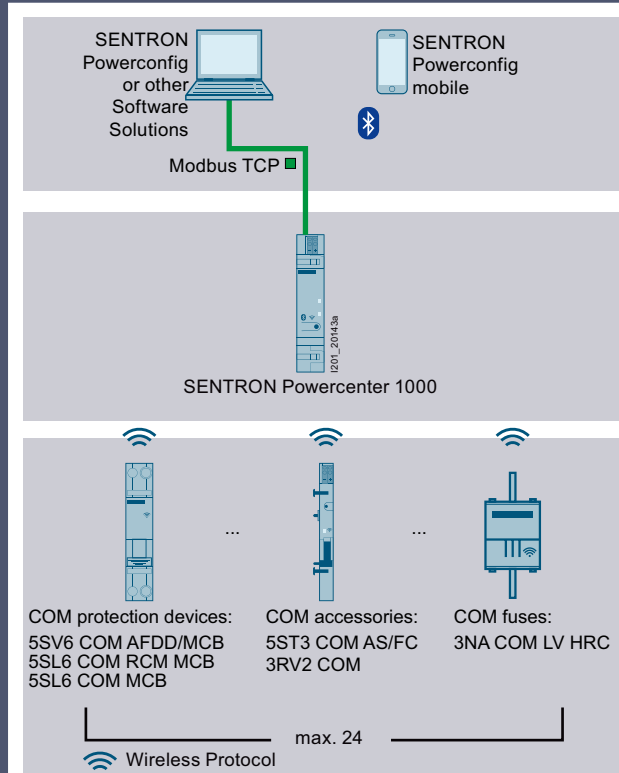
Accessories

Auxiliary switches (AS)		Article No.
1 NO + 1 NC	Standard	5ST3010
	For low power	5ST3013
	For low power (with diode)	5ST3013-0XX01
2 NO	Standard	5ST3011
	For low power	5ST3014
2 NC	Standard	5ST3012
	For low power	5ST3015
1 CO	Standard	5ST3016
Fault signal contacts (FC)		Article No.
1 NO + 1 NC		5ST3020
2 NO		5ST3021
2 NC		5ST3022
Auxiliary switches and fault signal contacts (AS+FC)		Article No.
1 CO (AS) + 1 CO (FC)		5ST3062
5ST3 COM (AS+FC)		5ST3062-0MC

Remote control mechanisms (RC mech.)		Article No.
Basic	12 ... 30 V AC, 12 ... 48 V DC	5ST3053
	177 ... 270 V AC	5ST3054
Power	12 ... 30 V AC, 12 ... 48 V DC	5ST3055
	177 ... 270 V AC	5ST3056
Power with ARD	12 ... 30 V AC, 12 ... 48 V DC	5ST3057
	177 ... 270 V AC	5ST3058
Power with extended function	12 ... 30 V AC, 12 ... 48 V DC	5ST3070
	170 ... 277 V AC, 77 ... 286 V DC	5ST3071
Adapters for remote control mechanisms (RC mech.)		Article No.
1 MW		5ST3820-6
Arc fault detection units (AFDD)		Article No.
For basic units 1P + N	I_n up to 16 A	5SM6011-2
(1 MW), not for KL types	I_n up to 40 A	5SM6014-2
Data transceiver (essential accessory)		Article No.
SENTRON Powercenter 1000		7KN1110-0MC00



SENTRON Powercenter 1000 data transceiver



- Wireless radio transmission of measured values and data to the SENTRON Powercenter 1000 data transceiver
- Commissioning, parameter assignment, firmware updates and further processing of the data via the SENTRON Powercenter 1000 data transceiver



SENTRON Powercenter 1000

Article No.

7KN1110-0MC00

See page 10/20

You will find further information at www.siemens.com/lowvoltage/manuals

Installation Manual – Circuit protection devices with communication and measuring function (109791805)



System Manual – Circuit protection devices with communication and measuring function (109791806)



Monitoring functions with limit monitoring

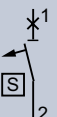
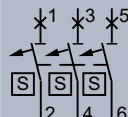
- Switching state with trip monitoring: short-circuit, overload
- Counters incl. limit monitoring
 - Operating hours
 - Operating hours with load current
 - Operating cycles (ON/OFF)
 - Tripping operations
 - Short circuits
- Limit alarms
 - Overcurrent alarm 1 and alarm 2
 - Undercurrent alarm 1 and alarm 2
 - Overvoltage alarm 1 and alarm 2
 - Undervoltage alarm 1 and alarm 2
 - Temperature
 - Residual current pre-alarm (low-pass channels)
 - Residual current main alarm (low-pass channels)

Measured values	Unit
Temperature	°C
Average temperature	°C
Current	A
Average current	A
Maximum current	A
Voltage	V
Line frequency	Hz
Active power	W
Apparent power	VA
Reactive power	Var
Power factor	
Active energy imported	Wh
Active energy exported	Wh
Reactive energy imported	Varh
Reactive energy exported	Varh
Residual current measurement channels with adjustable measuring ranges	Unit
Line frequency 50 Hz	mA
Harmonic of line frequency	mA
Low-pass filter (AC)	mA
Low-pass filter (AC + pulsating DC)	mA
Band-pass filter	mA
High-pass filter	mA

5SP3 selective main miniature circuit breakers (SHU)

25 kA, mounting on a 40 mm busbar

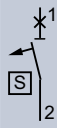
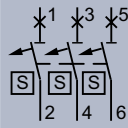
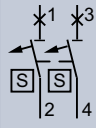
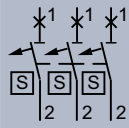
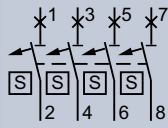


	1P	3 × 1P
Rated voltage U_n	230/400 V AC	230/400 V AC
Mounting width	1.5 MW	4.5 MW
		

Rated current I_n	Characteristic				Characteristic	
	E	L1	L2	L3		E
16 A		5SP3716-2KK01	5SP3716-2KK02	5SP3716-2KK03	5SP3716-2	5SP3816-2
20 A		5SP3720-2KK01	5SP3720-2KK02	5SP3720-2KK03	5SP3720-2	5SP3820-2
25 A		5SP3725-2KK01	5SP3725-2KK02	5SP3725-2KK03	5SP3725-2	5SP3825-2
35 A		5SP3735-2KK01	5SP3735-2KK02	5SP3735-2KK03	5SP3735-2	5SP3835-2
40 A		5SP3740-2KK01	5SP3740-2KK02	5SP3740-2KK03	5SP3740-2	5SP3840-2
50 A		5SP3750-2KK01	5SP3750-2KK02	5SP3750-2KK03	5SP3750-2	5SP3850-2
63 A		5SP3763-2KK01	5SP3763-2KK02	5SP3763-2KK03	5SP3763-2	5SP3863-2



25 kA, mounting on a DIN rail

	1P	3 × 1P	2P	3P	4P
Rated voltage U_n	230/400 V AC	230/400 V AC	230/400 V AC	230/400 V AC	230/400 V AC
Mounting width	1.5 MW	4.5 MW	3 MW	4.5 MW	6 MW
					
Rated current I_n	Characteristic E	Characteristic E	Characteristic E	Characteristic E	Characteristic E
16 A	5SP3716-3	5SP3816-3	5SP3216-3	5SP3316-3	5SP3416-3
20 A	5SP3720-3	5SP3820-3	5SP3220-3	5SP3320-3	5SP3420-3
25 A	5SP3725-3	5SP3825-3	5SP3225-3	5SP3325-3	5SP3425-3
35 A	5SP3735-3	5SP3835-3	5SP3235-3	5SP3335-3	5SP3435-3
40 A	5SP3740-3	5SP3840-3	5SP3240-3	5SP3340-3	5SP3440-3
50 A	5SP3750-3	5SP3850-3	5SP3250-3	5SP3350-3	5SP3450-3
63 A	5SP3763-3	5SP3863-3	5SP3263-3	5SP3363-3	5SP3463-3

5SY17 circuit breakers for equipment

Electromechanical

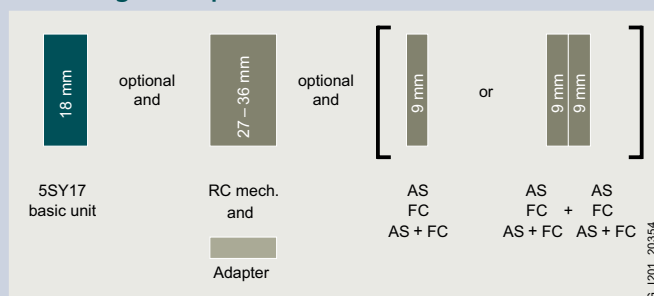


1P+AS
 Rated voltage U_n 230 V AC/12 ... 72 V DC
 Mounting width 1 MW (18 mm)



Rated current I_n	Characteristic	
	F1 (quick)	F2 (slow)
0.5 A	5SY1705-2	5SY1705-4
1 A	5SY1701-2	5SY1701-4
2 A	5SY1702-2	5SY1702-4
4 A	5SY1704-2	5SY1704-4
6 A	5SY1706-2	5SY1706-4
8 A	5SY1708-2	5SY1708-4
10 A	5SY1710-2	5SY1710-4
16 A	5SY1716-2	5SY1716-4

Mounting concept



AS Auxiliary switches
 FC Fault signal contacts
 AS+FC Auxiliary switches and fault signal contacts
 RC mech. Remote control mechanisms

[See page 3/50](#)
[See page 3/52](#)
[See page 3/53](#)
[See page 3/58](#)

Accessories

Auxiliary switches (AS)		Article No.
1 NO + 1 NC	Standard	5ST3010
	For low power	5ST3013
	For low power (with diode)	5ST3013-0XX01
2 NO	Standard	5ST3011
	For low power	5ST3014
2 NC	Standard	5ST3012
	For low power	5ST3015
1 CO	Standard	5ST3016
Fault signal contacts (FC)		Article No.
1 NO + 1 NC		5ST3020
2 NO		5ST3021
2 NC		5ST3022

Auxiliary switches and fault signal contacts (AS+FC)		Article No.
1 CO (AS) + 1 CO (FC)		5ST3062
5ST3 COM (AS+FC)		5ST3062-0MC
Remote control mechanisms (RC mech.)		Article No.
Basic	12 ... 30 V AC, 12 ... 48 V DC	5ST3053
	177 ... 270 V AC	5ST3054
Power	12 ... 30 V AC, 12 ... 48 V DC	5ST3055
	177 ... 270 V AC	5ST3056
Power with ARD	12 ... 30 V AC, 12 ... 48 V DC	5ST3057
	177 ... 270 V AC	5ST3058
Power with extended function	12 ... 30 V AC, 12 ... 48 V DC	5ST3070
	170 ... 277 V AC, 77 ... 286 V DC	5ST3071
Adapters for remote control mechanisms (RC mech.)		Article No.
1 MW		5ST3820-6

5SK9 circuit breakers for equipment

Electronic



	1P+AS
Rated voltage U_n	24 V DC
Mounting width	6.2 mm

Rated current I_n	
1 A	5SK9101-1
2 A	5SK9102-1
3 A	5SK9103-1
4 A	5SK9104-1
6 A	5SK9106-1
8 A	5SK9108-1

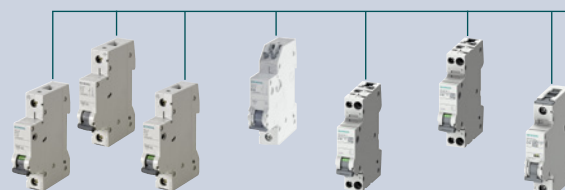
Specific accessories

Connecting combs				
	Type	Number of poles	Max. load current I_{max}	Article No.
	For parallel infeed	2-pole	32 A	8WH9020-6CC10
	For remote signal – group signal	5-pole	32 A	8WH9020-6CF10
	For remote signal – group signal	2-pole	32 A	8WH9020-6CC10
Reducing combs for terminal blocks of 10 mm ²				
	Type	Number of poles	Max. load current I_{max}	Article No.
	For bypassing the power supply	2-pole	40 A	8WH9020-0AC10

See general accessories, from page 3/60 onwards

Overview of the modular system

Miniature circuit breakers



				5SL3	5SL6	5SL4	5SJ6...-.KS	5SL30	5SL60/ 5SL6 COM	5SY
Auxiliary switches (AS)				Article No.						
	1 NO + 1 NC	Standard	5ST3010	■	■	■	–	■	■	■
		For low power	5ST3013	■	■	■	–	■	■	■
		For low power (with diode)	5ST3013-0XX01	■	■	■	–	■	■	■
	2 NO	Standard	5ST3011	■	■	■	–	■	■	■
		For low power	5ST3014	■	■	■	–	■	■	■
	2 NC	Standard	5ST3012	■	■	■	–	■	■	■
For low power		5ST3015	■	■	■	–	■	■	■	
1 CO	Standard	5ST3016	■	■	■	–	■	■	■	
		5ST1010-0FP	–	–	–	–	–	–	–	
Fault signal contacts (FC)				Article No.						
	1 NO + 1 NC		5ST3020	■	■	■	–	■	■	■
	2 NO		5ST3021	■	■	■	–	■	■	■
	2 NC		5ST3022	■	■	■	–	■	■	■
Auxiliary switches and fault signal contacts (AS+FC)				Article No.						
	1 CO (AS) + 1 CO (FC)	Standard	5ST3062	■	■	■	–	■	■	■
	5ST3 COM (AS+FC)	With communication and measuring function	5ST3062-0MC	■	■	■	–	■	■	■
Shunt trips (ST)				Article No.						
	110 ... 415 V AC, 110 ... 220 V DC		5ST3030	–	–	■	–	–	–	■
	24 ... 48 V AC/DC		5ST3031	–	–	■	–	–	–	■
	12 V DC		5ST3031-0XX01	–	–	■	–	–	–	■
Undervoltage releases (UR)				Article No.						
	With integrated auxiliary switch	230 V AC	5ST3040	–	–	■	–	–	–	■
		110 V DC	5ST3041	–	–	■	–	–	–	■
		24 V DC	5ST3042	–	–	■	–	–	–	■
	Without integrated auxiliary switch	230 V AC	5ST3043	–	–	■	–	–	–	■
		110 V DC	5ST3044	–	–	■	–	–	–	■
		24 V DC	5ST3045	–	–	■	–	–	–	■
Remote control mechanisms (RC mech.)				Article No.						
	Basic	12 ... 30 V AC, 12 ... 48 V DC	5ST3053	–	■	■	–	–	■	■
		177 ... 270 V AC	5ST3054	–	■	■	–	–	■	■
	Power	12 ... 30 V AC, 12 ... 48 V DC	5ST3055	–	■	■	–	–	■	■
		177 ... 270 V AC	5ST3056	–	■	■	–	–	■	■
	Power with ARD	12 ... 30 V AC, 12 ... 48 V DC	5ST3057	–	■	■	–	–	■	■
		177 ... 270 V AC	5ST3058	–	■	■	–	–	■	■
Power with extended function	12 ... 30 V AC, 12 ... 48 V DC	5ST3070	–	■	■	–	–	■	■	
	170 ... 277 V AC, 77 ... 286 V DC	5ST3071	–	■	■	–	–	■	■	
5SM6 arc fault detection units				Article No.						
	Rated current up to 16 A	Standard	5SM6021-2	–	–	□	–	–	–	□
		For compact devices 1P+N in 1 MW	5SM6011-2	–	–	–	–	–	□	–
	Rated current up to 40 A	Standard	5SM6024-2	–	–	□	–	–	–	□
		For compact devices 1P+N in 1 MW	5SM6014-2	–	–	–	–	–	□	–
Standard busbars				Article No.						
	Cannot be cut		5ST36..	■	■	■	■	■	■	■
	Can be cut		5ST37..	■	■	■	■	■	■	■
Compact busbars				Article No.						
	Cannot be cut		5ST36..	□	□	□	–	■	■	–
	Can be cut		5ST37..	□	□	□	–	■	■	–

From page 3/12

■ Suitable for all versions

□ Suitable for some versions

Electrical accessories



Auxiliary switches (AS)

- Signals the contact position of the mounted device
- Version for the switching of small currents and voltages according to EN 61131-2 for control of programmable control systems (PLCs)
- Test button enables the testing of control circuits without the need to switch the mounted device

For combining with basic units						Contacts	Version	Mounting width (1 MW = 18 mm)	Article No.						
Miniature circuit breakers	Circuit breakers for equipment	RCCBs	RCBOs	Arc fault detection devices	ON/OFF switches										
Auxiliary switches (AS)															
5SL, 5SY, 5SP4, 5SP5	5SY17	5SV	5SU1 ¹⁾ , 5SV1	5SV6	5TL1, 5TE8	1 NO + 1 NC	Standard	0.5 MW	5ST3010						
							For low power	0.5 MW	5ST3013						
							For low power (with diode)	0.5 MW	5ST3013-0XX01						
												2 NO	Standard	0.5 MW	5ST3011
											For low power		0.5 MW	5ST3014	
											2 NC	Standard	0.5 MW	5ST3012	
												For low power	0.5 MW	5ST3015	
											1 CO	Standard	0.5 MW	5ST3016	
						Auxiliary switches (AS) with TEST button									
5SL, 5SY, 5SP4, 5SP5	5SY17	5SV	5SU1 ¹⁾ , 5SV1	5SV6	5TL1, 5TE8	1 NO + 1 NC	Standard	0.5 MW	5ST3010-2						
							For low power	0.5 MW	5ST3013-2						
							2 NO	Standard	0.5 MW	5ST3011-2					
						For low power		0.5 MW	5ST3014-2						
							2 NC	Standard	0.5 MW	5ST3012-2					
						For low power		0.5 MW	5ST3015-2						
Auxiliary switches (AS) acc. to UL 489															
5SJ4...-HG	-	-	-	-	-	1 NO + 1 NC	Standard	0.5 MW	5ST3010-0HG						
						2 NO	Standard	0.5 MW	5ST3011-0HG						
						2 NC	Standard	0.5 MW	5ST3012-0HG						

¹⁾ 5ST3805-1 handle coupler required

Further technical specifications

5ST3010,
5ST3011,
5ST3012,
5ST30165ST3010-0HG,
5ST3011-0HG,
5ST3012-0HG5ST3010-2,
5ST3011-2,
5ST3012-25ST3013,
5ST3014,
5ST3015,
5ST3013-0XX01 ¹⁾5ST3013-2,
5ST3014-2,
5ST3015-2

Standards				
Standards	IEC/EN	IEC/EN 62019, IEC/EN 60947-5-1	–	IEC/EN 62019, IEC/EN 60947-5-1
	UL, CSA	UL 1077, CSA C22.2 No. 235	UL 489, CSA 22.2 No. 5-02	– UL 1077, CSA C22.2 No. 235 –
Contacts				
Minimum contact load		50 mA, 24 V		1 mA, 5 V DC 5 mA, 5 V DC
Maximum contact load		–		100 mA, 30 V DC 50 mA, 30 V DC
Contact load acc. to IEC/EN 62019/ IEC/EN 60947-5-1	230 V AC, AC-12	–		–
	230 V AC, AC-13	6 A/6 A		–
	400 V AC, AC-13	2 A/2 A		–
	230 V AC, AC-14	6 A/6 A		–
	400 V AC, AC-14	2 A/2 A		–
	24 V DC, DC-13	6 A/3 A		–
	30 V DC, DC-14	–		0.1 A
	60 V DC, DC-13	3 A/1.5 A		–
	110 V DC, DC-13	1 A/0.75 A		–
	220 V DC, DC-12	–		–
	220 V DC, DC-13	1 A/0.5 A		–
	Contact load acc. to UL	120 V AC	–	6 A
125 V AC		3 A	–	–
240 V AC		4 A	–	–
277 V AC		–	3 A	–
480 V AC		1.5 A	–	–
60 V DC		–	3 A	–
125 V DC		1.1 A	1 A	–
250 V DC		0.55 A	–	–
Service life, on average, with rated load	Actuations	20000	12000	20000
Safety				
Short-circuit protection		5SY... 6A miniature circuit breaker or gG 6 A fuse		
Connections				
Conductor cross-sections		0.5 ... 2.5 mm ² (AWG 22 ... 14)		
Terminals	Max. tightening torque	0.5 Nm (4.5 lb-in)		
Ambient conditions				
Permissible ambient temperature		–40 ... +70 °C		
Permissible storage temperature		–40 ... +75 °C		
Resistance to climate	Acc. to IEC 60068-2-30	28 cycles		
Mounting position		Any		
Shock at 11 ms half-sine	Acc. to IEC 60068-2-27	150 m/s ²		
Resistance to vibrations at 5 ... 150 Hz	Acc. to IEC 60068-2-6	50 m/s ²		

¹⁾ No approvals

Electrical accessories



Fault signal contacts (FC)

- Signals automatic tripping of the circuit protection device in the event of a fault, such as an overload or a short circuit
- If the fault signal contact is activated, the contact position does not change if the mounted circuit protection device is tripped manually
- Version with TEST and RESET buttons enables the testing of control circuits without operation of the circuit protection device
- Red RESET button in the operating handle indicates automatic tripping of the mounted circuit protection device

For combining with basic units					Contacts	Mounting width (1 MW = 18 mm)	Article No.
Miniature circuit breakers	Circuit breakers for equipment	RCCBs	RCBOs	Arc fault detection devices			
Fault signal contacts (FC)							
5SL, 5SY, 5SP4, 5SP5	5SY17	5SV	5SU1 ¹⁾ , 5SV1	5SV6	1 NO + 1 NC	0.5 MW	5ST3020
					2 NO	0.5 MW	5ST3021
					2 NC	0.5 MW	5ST3022
Fault signal contacts (FC) with TEST and RESET button							
5SL, 5SY, 5SP4, 5SP5	5SY17	5SV	5SU1 ¹⁾ , 5SV1	5SV6	1 NO + 1 NC	0.5 MW	5ST3020-2
					2 NO	0.5 MW	5ST3021-2
					2 NC	0.5 MW	5ST3022-2
Fault signal contacts (FC) acc. to UL 489							
5SJ4...-HG	–	–	–	–	1 NO + 1 NC	0.5 MW	5ST3020-0HG
					2 NO	0.5 MW	5ST3021-0HG
					2 NC	0.5 MW	5ST3022-0HG

¹⁾ 5ST3805-1 handle coupler required

Further technical specifications

		5ST3020, 5ST3021, 5ST3022	5ST3020-2, 5ST3021-2, 5ST3022-2	5ST3020-0HG, 5ST3021-0HG, 5ST3022-0HG
Standards				
Standards	IEC/EN UL, CSA	IEC/EN 62019, IEC/EN 60947-5-1 UL 1077, CSA C22.2 No. 235	–	UL 489, CSA 22.2 No. 5-02
Contacts				
Minimum contact load		50 mA, 24 V		
Contact load acc. to IEC/EN 62019/IEC/EN 60947-5-1	230 V AC, AC-13 400 V AC, AC-13 230 V AC, AC-14 400 V AC, AC-14 24 V DC, DC-13 60 V DC, DC-13 110 V DC, DC-13 220 V DC, DC-13	6 A/6 A 6 A/6 A 2 A/2 A 2 A/2 A 6 A/3 A 3 A/1.5 A 1 A/0.75 A 1 A/0.5 A		
Contact load acc. to UL	120 V AC 125 V AC 240 V AC 277 V AC 480 V AC 60 V DC 125 V DC 250 V DC	– 3 A 4 A – 1.5 A – 1.1 A 0.55 A		6 A – – 3 A – 3 A 1 A –
Service life, on average, with rated load	Actuations	20000		12000
Safety				
Short-circuit protection		Miniature circuit breaker or gG 6 A fuse		
Connections				
Conductor cross-sections		0.5 ... 2.5 mm ² (AWG 22 ... 14)		
Terminals	Max. tightening torque	0.5 Nm (4.5 lb-in)		
Ambient conditions				
Permissible ambient temperature		–25 ... +55 °C		
Permissible storage temperature		–40 ... +75 °C		
Resistance to climate	Acc. to IEC 60068-2-30	28 cycles		
Mounting position		Any		
Shock at 11 ms half-sine	Acc. to IEC 60068-2-27	150 m/s ²		
Resistance to vibrations at 10 ... 150 Hz	Acc. to IEC 60068-2-6	50 m/s ²		



Auxiliary switches and fault signal contacts (AS+FC)

- Combines the function of both switches in a width of only 0.5 MW (9 mm)
- Signals the contact position of the mounted circuit protection device
- Signals automatic tripping of the circuit protection device in the event of a fault, such as an overload, a short circuit or a fault current
- If the fault signal contact is activated, the contact position does not change if the mounted circuit protection device is tripped manually

For combining with basic units					Contacts	Mounting width (1 MW = 18 mm)	Article No.
Miniature circuit breakers	Circuit breakers for equipment	RCCBs	RCBOs	Arc fault detection devices			
Auxiliary switches and fault signal contacts (AS+FC)							
5SL, 5SY, 5SP4, 5SP5	5SY17	5SV	5SU1 ¹⁾ , 5SV1	5SV6	1 CO (AS) + 1 CO (FC)	0.5 MW	5ST3062

¹⁾ 5ST3805-1 handle coupler required

Further technical specifications

5ST3062

Standards		
Standards	IEC/EN UL, CSA	IEC/EN 62019, IEC/EN 60947-5-1 UL 1077, CSA C22.2 No. 235
Contacts		
Minimum contact load		50 mA, 24 V
Maximum contact load		–
Contact load acc. to IEC/EN 62019/IEC/EN 60947-5-1	230 V AC, AC-13 400 V AC, AC-14	6 A/6 A 2 A/2 A
Contact load acc. to IEC/EN 62019/IEC/EN 60947-5-1	24 V DC, DC-13 60 V DC, DC-13 110 V DC, DC-13 220 V DC, DC-13	3 A/3 A 3 A/1 A 0.5 A/0.5 A 0.5 A/0.3 A
Contact load acc. to UL	125 V AC 240 V AC 480 V AC 125 V DC 250 V DC	2 A 1.5 A 0.75 A 0.5 A 0.3 A
Service life, on average, with rated load	Actuations	20000
Safety		
Short-circuit protection		Miniature circuit breaker or gG 6 A fuse
Connections		
Conductor cross-sections		0.5 ... 2.5 mm ² (AWG 22 ... 14)
Terminals	Max. tightening torque	0.5 Nm (4.5 lb-in)
Ambient conditions		
Permissible ambient temperature		–25 ... +55 °C
Permissible storage temperature		–40 ... +75 °C
Resistance to climate	Acc. to IEC 60068-2-30	28 cycles
Mounting position		Any
Shock at 11 ms half-sine	Acc. to IEC 60068-2-27	150 m/s ²
Resistance to vibrations at 10 ... 150 Hz	Acc. to IEC 60068-2-6	50 m/s ²

Electrical accessories



5ST3 COM auxiliary switches and fault signal contacts (AS+FC) with communication and measuring function

- Reports the switching state of the mounted standard circuit protection device (ON, tripped, manual OFF, tripped with locked handle)
- Measures the temperature of the device and counts operating cycles, trips and operating hours
- Communication via radio to SENTRON Powercenter 1000 data transceiver
- Plug-in terminals for 24 V DC power supply incl. daisy chain function
- Low space requirements of 0.5 MW (9 mm)

For combining with basic units					Mounting width (1 MW = 18 mm)	Article No.
Miniature circuit breakers	Circuit breakers for equipment	RCCBs	RCBOs	Arc fault detection devices	Communication	
5ST3 COM auxiliary switches and fault signal contacts (AS+FC) with communication and measuring function						
5SL, 5SY, 5SP4, 5SP5	5SY17	5SV	5SU1 ¹⁾ , 5SV1	5SV6	Radio link to SENTRON Powercenter 1000	0.5 MW 5ST3062-0MC

¹⁾ 5ST3805-1 handle coupler required

Note:

Please note the country-specific radio licenses of the products at www.siemens.com/lowvoltage/certificates (109801197)

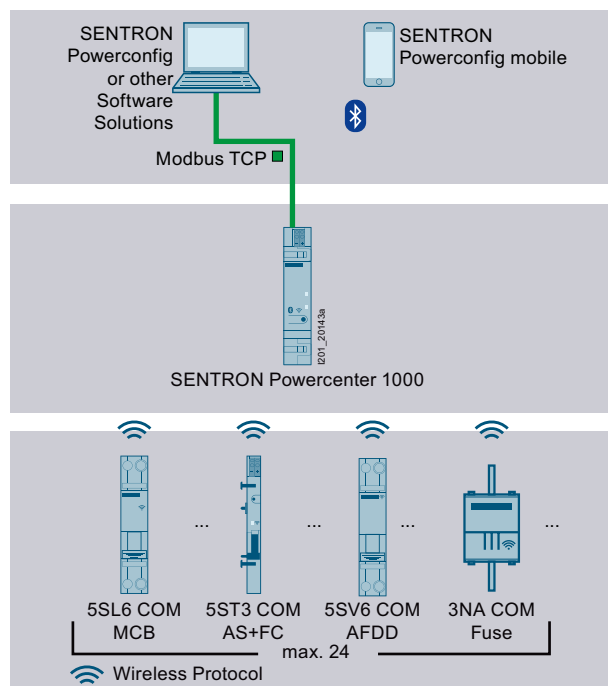
Further technical specifications

5ST3062-0MC

Standards		
Standards	IEC/EN RED	60669-2-5 2014/53/EU
Power supply		
Power supply		24 V DC ±20%, SELV
Conductor cross-sections		0.2 ... 1.5 mm ²
Connection type		Plug-in terminal
Safety		
Degree of pollution for overvoltage category		2/II
Degree of protection		IP40, with front cover
Ambient conditions		
Permissible ambient temperature		-25 ... +60 °C
Permissible storage temperature		-40 ... +85 °C
Humidity		93% at 40 °C
Resistance to climate	Acc. to IEC 60068-2-30	28 cycles
Mounting position		Any
Shock		150 m/s ²
Resistance to vibrations at 10 ... 150 Hz	Acc. to IEC 60068-2-6	50 m/s ²
Service life/endurance		10000
Communication		
Interface	SETRON Powercenter 1000	Radio link
Temperature		Measuring accuracy of 2 °C with limit monitoring incl. storage (1 hour in 1-minute intervals and 7 days in 15-minute intervals)
Operating cycles counters		Mechanical operation with limit monitoring
Trip counter		Trip of the mounted circuit protection device with limit monitoring
Operating hours counter		Operating hours with limit monitoring



SENTRON Powercenter 1000 data transceiver



- Wireless radio transmission of measured values and data to the SENTRON Powercenter 1000 data transceiver
- Commissioning, parameter assignment, firmware updates and further processing of the data via the SENTRON Powercenter 1000 data transceiver



SENTRON Powercenter 1000

Article No.

7KN1110-0MC00

See page 10/20

You will find further information at www.siemens.com/lowvoltage/manuals

Installation Manual – Circuit protection devices with communication and measuring function (109791805)



System Manual – Circuit protection devices with communication and measuring function (109791806)



Electrical accessories



Shunt trips (ST)

- For remote-controlled tripping of the mounted device

For combining with basic units			Rated operational voltage U_e	Mounting width (1 MW = 18 mm)	Article No.
Miniature circuit breakers	RCCBs	RCBOs			
Shunt trips (ST)					
5SL4, 5SY, 5SP	5SV	5SU1 ¹⁾	110 ... 415 V AC, 110 ... 220 V DC	1 MW	5ST3030
			24 ... 48 V AC/DC	1 MW	5ST3031
			12 V DC	1 MW	5ST3031-0XX01
Shunt trips (ST) acc. to UL 489					
5SJ4...-HG	–	–	110 ... 415 V AC, 110 ... 220 V DC	1 MW	5ST3030-OHG
			24 ... 60 V AC/DC	1 MW	5ST3031-OHG

¹⁾ 5ST3805-1 handle coupler required

Further technical specifications

	5ST3030	5ST3031	5ST3031-0XX01	5ST3030-OHG	5ST3031-OHG
Standards					
Standards	IEC/EN UL, CSA		EN 60947-1 –	IEC/EN 60947-1 UL 489, UL-File E321559, CSA 22.2 No. 5-02	
Supply					
Primary operating range	0.7 ... 1.1 × U_n				
Rated frequency f_n	50 ... 60 Hz		–	50 ... 60 Hz	
Contacts					
Minimum contact load	50 mA, 24 V		1 mA, 5 V	50 mA, 24 V	
Tripping operations	Max. 2000				
Service life, on average, with rated load	Actuations 20000			12000	
Safety					
Short-circuit protection	Miniature circuit breaker B/C 6 A or fuse gG 6 A				
Connections					
Conductor cross-sections	0.5 ... 2.5 mm ² (AWG 22 ... 14)				
Terminals	Max. tightening torque 0.8 Nm (6.8 lb-in)				
Ambient conditions					
Permissible ambient temperature	–25 ... +55 °C		–40 ... +70 °C	–25 ... +55 °C	
Permissible storage temperature	–40 ... +75 °C				
Resistance to climate	Acc. to IEC 60068-2-30		28 cycles		
Mounting position	Any				
Shock at 11 ms half-sine	Acc. to IEC 60068-2-27		150 m/s ²		
Resistance to vibrations at 10 ... 150 Hz	Acc. to IEC 60068-2-6		50 m/s ²		



Undervoltage releases (UR)

- Are integrated (e.g. in EMERGENCY-OFF loops), thus ensuring that the MCB trips in the event of an emergency. EMERGENCY-OFF is a function provided to disconnect the electricity supply to all or some parts of the installation in case of emergency, when there is a risk of electric shock or any other hazard caused by electrical power
- In addition, an undervoltage release also trips if the voltage is interrupted or too low, or prevents the MCB from closing
- Combination with 5SV RCCB not suitable for implementation of EMERGENCY-OFF/ EMERGENCY-STOP circuits

For combining with basic units			Rated operational voltage U_e	Mounting width (1 MW = 18 mm)	Article No.
Miniature circuit breakers	RCCBs	RCBOs			
With integrated auxiliary switch					
5SL4, 5SY, 5SP4, 5SP5	5SV	5SU1 ¹⁾	230 V AC	1 MW	5ST3040
			110 V DC	1 MW	5ST3041
			24 V DC	1 MW	5ST3042
Without integrated auxiliary switch					
5SL4, 5SY, 5SP4, 5SP5	5SV	5SU1 ¹⁾	230 V AC	1 MW	5ST3043
			110 V DC	1 MW	5ST3044
			24 V DC	1 MW	5ST3045

¹⁾ 5ST3805-1 handle coupler required

Further technical specifications

5ST304.

Standards		
Standards	IEC/EN	EN 60947-1
Supply		
Primary operating range		0.85 ... 1.1 × U_n
Rated frequency f_n		50/60 Hz
Contacts		
Minimum contact load		50 mA, 24 V
Tripping operations		Max. 2000
Service life, on average, with rated load	Actuations	20000
Safety		
Short-circuit protection		Miniature circuit breaker B/C 6 A or fuse gG 6 A
Connections		
Conductor cross-sections		0.5 ... 2.5 mm ² (AWG 22 ... 14)
Terminals	Max. tightening torque	0.8 Nm (6.8 lb-in)
Ambient conditions		
Permissible ambient temperature		−25 ... +55 °C
Permissible storage temperature		−40 ... +75 °C
Resistance to climate	Acc. to IEC 60068-2-30	28 cycles
Mounting position		Any
Shock at 11 ms half-sine	Acc. to IEC 60068-2-27	150 m/s ²
Resistance to vibrations at 10 ... 150 Hz	Acc. to IEC 60068-2-6	50 m/s ²

Electrical accessories



5ST3 remote control mechanisms (RC mech.)

- For locations that are spread out over a wide area or not permanently attended
- Permits direct and immediate access to the installation even if it is remote or in a location that is hard to access
- Permits fast reconnection after a fault
- Version with ARD with automatic restart
- Versions with ARD and Power with integrated auxiliary switches and fault signal contacts

Type of remote control mechanism	Display	Ambient temperature	Vibration and shock requirements	Rated operational voltage U_e	Mounting width (1 MW = 18 mm)	Article No.
Basic	–	–25 °C ... +45 °C	–	12 ... 30 V AC, 12 ... 48 V DC	1.5 MW	5ST3053
				177 ... 270 V AC	2 MW	5ST3054
Power	LED	–25 °C ... +45 °C	–	12 ... 30 V AC, 12 ... 48 V DC	2 MW	5ST3055
				177 ... 270 V AC	2 MW	5ST3056
Power with ARD	LED	–25 °C ... +45 °C	–	12 ... 30 V AC, 12 ... 48 V DC	2 MW	5ST3057
				177 ... 270 V AC	2 MW	5ST3058
Power with extended function	LED	–40 °C ... +70 °C	Acc. to EN 61373/ EN 50155 "1B"	12 ... 30 V AC, 12 ... 48 V DC	2 MW	5ST3070
				170 ... 277 V AC, 77 ... 286 V DC	2 MW	5ST3071

Further technical specifications

	5ST3053	5ST3054	5ST3055	5ST3056	5ST3057	5ST3058	5ST3070	5ST3071
Standards								
Standards	EN 50557 (VDE 0640-20)							
Supply								
Rated frequency f_n	50 ... 60 Hz							
Rated power dissipation in standby	≤ 1 VA							
Contacts								
Service life, on average, with rated load	Actuations	10000						
Number of remote switching operations per minute	2							
Number of automatic reclose attempts	–				3		–	
Cable length in the control circuit	≤ 1500 m						≤ 1500 m (DC)/ ≤ 200 m (AC)	
Sliding selector with locking device	–	■						
Integrated auxiliary switches	–		1CO; 2 A; 250 V					
Integrated fault signal contacts	–		1CO; 2 A; 250 V					
Connections								
Conductor cross-sections	0.5 ... 1.5 mm ² (AWG 14 ... 30)							
Terminal tightening torque	0.2 ... 0.25 Nm (2.0 lb-in)							
Ambient conditions								
Permissible storage temperature	–40 ... +55 °C					–40 ... +70 °C		
Degree of protection	IP20							
Degree of pollution for overvoltage category	3/II							

Suitable adapters for combination with basic units



Basic units	Mounting width			Article No.
	1 ... 2 MW	3 ... 4 MW	3 ... 6 MW	
5SY4/5/6/7/8	■	–	–	5ST3820-1
	–	■	–	5ST3820-2
5SL3/4/6	■	–	–	5ST3820-6
	–	■	–	5ST3820-7
5SL60/5SY17	■	–	–	5ST3820-6
5SP4, 5SP5	■	–	–	5ST3820-1
	–	–	■	5ST3820-2



5SM6 arc fault detection units (AFDD)

- Detects arcing faults
- Offers extremely effective protection against fires started by electrical faults
- Ensures adequate fire protection even in applications without residual current protective device

For combining with basic units			Rated current I_n	Mounting width (1 MW = 18 mm)	Article No.
Width of basic unit	Miniature circuit breakers	RCBOs			
1 MW	5SL60 1P + N (no KL types)	5SV1	Up to 16 A	1 MW	5SM6011-2
			Up to 40 A	1 MW	5SM6014-2
2 MW	5SY ¹⁾ , 5SL4 (1P+N devices only, not compact)	5SU1.5	Up to 16 A	1 MW	5SM6021-2
			Up to 40 A	1 MW	5SM6024-2

¹⁾ Not suitable for use with 5SY5, 5SY8

Further technical specifications

5SM6

Standards		
Standards		IEC/EN 62606
Supply		
Rated voltage U_n		230 V
Rated current I_n		Up to 16/40 A
Rated frequency		50 Hz
Power loss		0.6 W
Contacts		
Number of poles		2-pole
Service life	Average number of operating cycles	> 10000
Safety		
Touch protection	Acc. to EN 50274 (VDE 0660-514)	Finger and back-of-hand safe
Degree of protection	Acc. to EN 60529 (VDE 0470-1)	IP20, with connected conductors
Overvoltage category		III
Tripping in the event of overvoltage		> 275 V
Connections		
Terminal/conductor cross-sections	Solid and stranded	0.75 ... 16 mm ²
	Finely stranded with end sleeve	0.75 ... 10 mm ²
Terminal tightening torque		2.0 ... 2.5 Nm
Mains connection		Bottom
Ambient conditions		
Permissible ambient temperature		-25 ... +40 °C
Permissible storage temperature		-40 ... +75 °C
Resistance to climate at 95% relative humidity	Acc. to IEC 60068-2-30	28 cycles, 55 °C
Degree of pollution		2
CFC and silicone-free		Yes
Mounting position		Any

See suitable busbars, from page 3/62 onwards

See suitable terminals and end caps, from page 3/78 onwards

Mechanical accessories

Mechanical rotary operating mechanisms complete with handle



- For 5SY, 5SP4, 5SP5, 5SL (but not for 5SL0 1P + N in 1MW), 5TL1, 5TE2, 5TE8, 5SU1

Types	Article No.
Handle black	5ST3060
Handle red/yellow	5ST3061

Terminal cover



- For miniature circuit breakers, but not for 5SL60..
- For additional covering of the screw openings per pole
- Lockable
- In the case of 5SY, also prevents removal of device from the DIN rail

Article No.
5ST3800

Handle locking devices

- To prevent undesired mechanical ON/OFF switching
- Sealable and lockable

For miniature circuit breakers	For padlocks with	Article No.
5SP4, 5SP5, 5SY	Max. 3 mm shackle	5ST3801



5SL, 5TL1	3 ... 6 mm shackle	5ST3806
-----------	--------------------	---------

Padlocks



- For 5ST3801 and 5ST3806 handle locking devices and remote control mechanisms 5ST3054 ... 58, 5ST3070

Article No.
5ST3802

Locking devices

- Comprising 5ST3801 or 5ST3806 handle locking device and 5ST3802 padlock

For miniature circuit breakers	Comprising	Article No.
5SP4, 5SP5, 5SY	5ST3801 handle locking device, 5ST3802 padlock	5ST3803
5SL, 5SV, 5TL1	5ST3806 handle locking device, 5ST3802 padlock	5ST3807

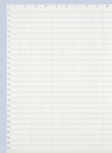
Spacers



- Can be placed on either side of the DIN rail. Two spacers allow for convenient cable routing

Mounting width	Article No.
0.5 MW	5TG8240

Device labels



- For adhesive attachment
- For modular installation devices, e.g. 5SY, 5SL, 5TL1

Types	Article No.
15 × 6 mm, white (WIN 098)	8WH8210-0AA35
15 × 6 mm, yellow (WIN 099)	8WH8210-0AA36

Terminal covers, gray



- For surface mounting, degree of protection IP40
- Sealable
- Can be used with 35 mm DIN rail

For width up to	Article No.
2.5 MW	5SW3004
4.5 MW	5SW3005

Wall enclosures, gray



- For flush mounting, degree of protection IP40
- Can be used with 35 mm DIN rail

For width up to	Article No.
2.5 MW	5SW3006
4.5 MW	5SW3007

Covers



- Can be assembled as mini distribution board
- Suitable for all devices
- Cover parts prepared for rail mounting of conventional label caps

Comprising	Article No.
End plate	5ST2134
Angled profile	5ST2135
Flat profile as alternative	5ST2136

Holders for front panel installation



- Universal use for devices from 1 to 6 MW

Cutout height	Cutout width	Article No.
45 ^{+0.5} mm	23, 41, 59, 77, 95 or 113 mm	7LF9006

Intermediate frames



- For 70 mm devices in 55 mm ALPHA SIMBOX small distribution boards

Types	Article No.
1-tier	8GB4561
2-tier	8GB4562
3-tier	8GB4563
4-tier	8GB4564

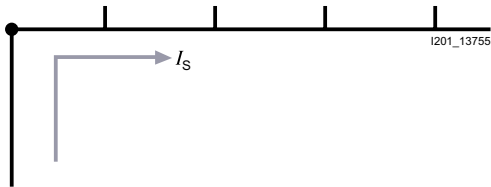
Standard busbars

General information



Infeed

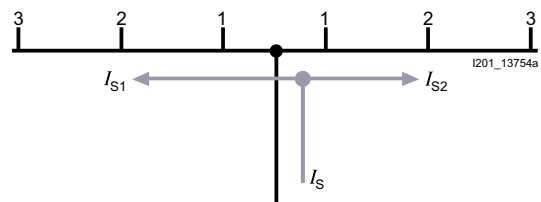
At the start or end of the busbar



Maximum busbar current I_s /phase

- Cross-section 10 mm²: 63 A
- Cross-section 16 mm²: 80 A

Along the busbar or midpoint infeed



Maximum busbar current I_s /phase

- Cross-section 10 mm²: 100 A
- Cross-section 16 mm²: 130 A



Fixed lengths, cannot be cut

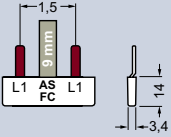
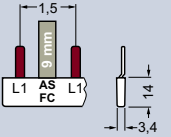
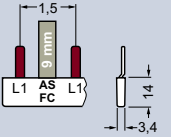
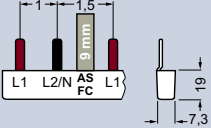
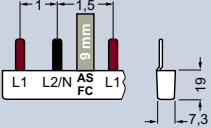
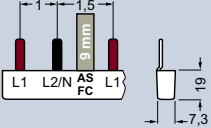
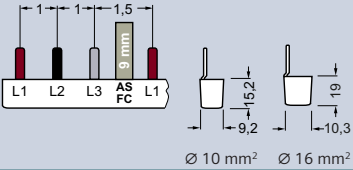
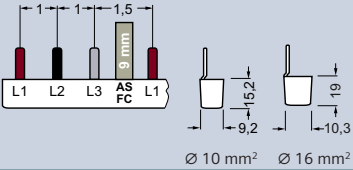
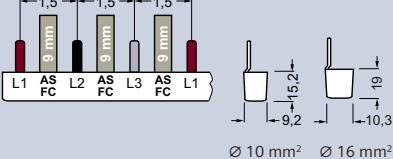
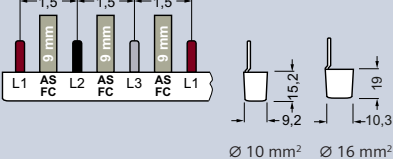
For miniature circuit breakers (MCBs)

Pin spacing in MW (1 MW = 18 mm)	Application	No. of MW	Length	Conductor cross-section	
				10 mm ²	16 mm ²
1-phase					
	For 2 MCBs 1P	2 MW	33 mm	5ST3600	5ST3630
	For 6 MCBs 1P	6 MW	105 mm	5ST3601	5ST3631
	For 12 MCBs 1P	12 MW	212 mm	5ST3602	5ST3632
	2-phase/1-phase + N				
	For 2 MCBs (2P/1P+N)	4 MW	76 mm	5ST3606	5ST3636
	For 3 MCBs (2P/1P+N)	6 MW	105 mm	5ST3607	5ST3637
	For 6 MCBs (2P/1P+N)	12 MW	210 mm	5ST3608	5ST3638
				Ø 10 mm ² Ø 16 mm ²	
3-phase					
	For 2 MCBs 3P	6 MW	102 mm	5ST3613	5ST3643
	For 3 MCBs 3P	9 MW	157.5 mm	5ST3614	5ST3644
	For 4 MCBs 3P	12 MW	210 mm	5ST3615	5ST3645
	For 14 MCBs 1P	14 MW	250 mm	5ST3613-4	–
	Combi pack: 20 × 5ST3613 + 10 × 5ST3614 + 50 × 5ST3615 + 50 × 5ST3655			5ST3656	–
	Combi pack: 20 × 5ST3643 + 10 × 5ST3644 + 50 × 5ST3645 + 50 × 5ST3655			–	5ST3657
				Ø 10 mm ² Ø 16 mm ²	
4-phase/3-phase + N					
	For 2 MCBs (4P/3P+N)	8 MW	138 mm/ 140 mm	5ST3621	5ST3651
	For 3 MCBs (4P/3P+N)	12 MW	210 mm	5ST3622	5ST3652
				Ø 10 mm ² Ø 16 mm ²	
	For 6 MCBs 1P+N	12 MW	210 mm	5ST3623	5ST3653
	For 7 MCBs 1P+N	14 MW	248 mm	5ST3623-4	–
				Ø 10 mm ² Ø 16 mm ²	

Standard busbars

Fixed lengths, cannot be cut

For MCBs equipped with auxiliary switch (AS) or fault signal contact (FC)

Pin spacing in MW (1 MW = 18 mm)	Application	No. of MW	Length	Conductor cross-section	
				10 mm ² Article No.	16 mm ² Article No.
1-phase					
	For 2 MCBs 1P	2 MW	40 mm	5ST3603	5ST3633
	For 6 MCBs 1P	6 MW	158 mm	5ST3604	5ST3634
	For 9 MCBs 1P	9 MW	237 mm	5ST3605	5ST3635
2-phase/1-phase + N					
	For 2 MCBs (2P/1P+N)	4 MW	76 mm	–	5ST3640
	For 3 MCBs (2P/1P+N)	6 MW	121 mm	–	5ST3641
	For 5 MCBs (2P/1P+N)	10 MW	210 mm	–	5ST3642
3-phase					
	For 2 MCBs 3P	6 MW	115 mm	5ST3616	5ST3646
	For 4 MCBs 3P	12 MW	237 mm	5ST3617	5ST3647
	For 6 MCBs 1P	9 MW	156 mm/ 158 mm	5ST3618	5ST3648
	For 9 MCBs 1P	12 MW	227 mm	5ST3620	5ST3650

Accessories

Terminals for 5ST36 and 5ST37		Article No.
For conductors 6 ... 25 mm ²	Cable entry on the left	5ST3768-4
	Cable entry in the center	5ST3768-3
	Cable entry on the right	5ST3768-5
For conductors 6 ... 50 mm ²	Cable entry on the left	5ST3760-4
	Cable entry in the center	5ST3760-3
	Cable entry on the right	5ST3760-5

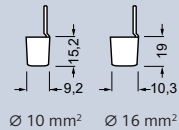
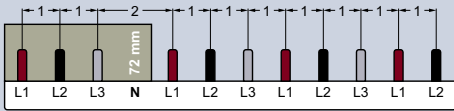
Terminals for infeed at side		Article No.
For conductors 6 ... 25 mm ²	Short	5ST3768
	Short, IP20	5ST3771-2
Touch protection		Article No.
For free connections, yellow (RAL 1004) 5 × 1 pin		5ST3655



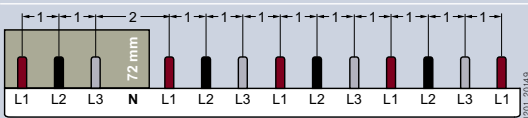
For MCBs with RCCB

Pin spacing in MW
(1 MW = 18 mm)

3-phase



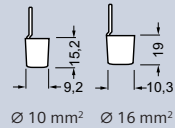
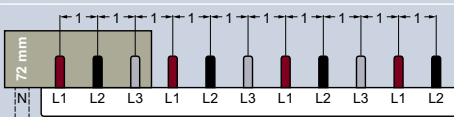
Application	No. of MW	Length	Conductor cross-section 10 mm ² Article No.	16 mm ² Article No.
For 8 MCBs 1P with 1 RCCB 3P+N, N right	12 MW	210 mm	5ST3624	5ST3654



For 10 MCBs 1P with 1 RCCB 3P+N or for 1 RCCB 3P+N, 1 MCB 3P and 7 MCBs 1P	14 MW	249 mm	5ST3624-4	–
--	-------	--------	-----------	---

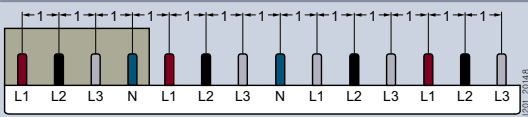


For 6 MCBs 1P with 1 RCCB 3P+N or for 1 RCCB 3P+N, 1 MCB 3P and 3 MCBs 1P	10 MW	176 mm	5ST3624-1	–
---	-------	--------	-----------	---

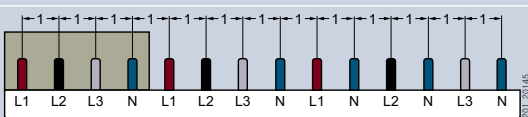


For 8 MCBs 1P with 1 RCCB 3P+N, N left	11 MW	192 mm	5ST3667	5ST3668
--	-------	--------	---------	---------

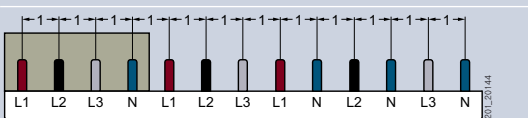
4-phase/3-phase + N



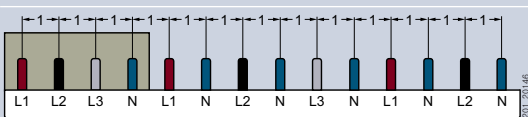
Application	No. of MW	Length	Article No.	Article No.
For 1 RCCB 3P+N, 1 MCB 3P+N and 6 MCBs 1P	14 MW	248 mm	5ST3724-4	–



For 1 RCCB 3P+N, 1 MCB 3P+N and 3 MCBs 1P+N	14 MW	248 mm	5ST3725-4	–
---	-------	--------	-----------	---



For 1 RCCB 3P+N, 1 MCB 3P and 3 MCBs 1P+N	13 MW	230 mm	5ST3725-3	–
---	-------	--------	-----------	---

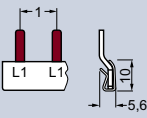
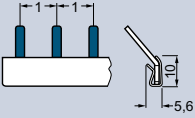
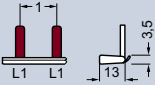
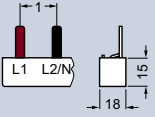
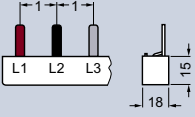
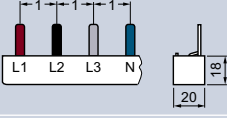
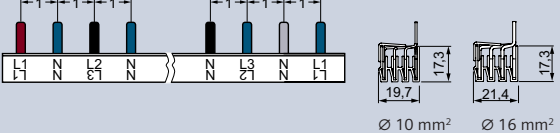


For 1 RCCB 3P+N and 5 MCBs 1P+N	14 MW	248 mm	5ST3625-4	–
---------------------------------	-------	--------	-----------	---

Standard busbars

Can be cut

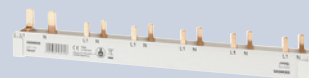
For miniature circuit breakers (MCBs)

Pin spacing in MW (1 MW = 18 mm)	Application	No. of MW	Length	End caps included	Color	Conductor cross-section		
						10 mm ²	16 mm ²	
						Article No.	Article No.	
1-phase, straight 	For MCBs 1P+N compact	12 MW	216 mm	■	Gray	5ST3762	–	
		56 MW	1016 mm	–	Blue	5ST3687-0	–	
						Gray	5ST3764	–
						Blue	5ST3787-0	–
1-phase, angled 45° 	For MCBs 1P+N compact	12 MW	216 mm	■	Blue	5ST3763	–	
		56 MW	1016 mm	–	Blue	5ST3765	–	
1-phase, angled 90° 	For MCBs 1P	12 MW	214 mm	■		5ST3730	5ST3700	
		56 MW	1016 mm	–		5ST3731	5ST3701	
2-phase/1-phase + N 	For 2MW devices (2P/1P+N)	12 MW	214 mm	■		5ST3734	5ST3704	
		56 MW	1016 mm	–		5ST3735	5ST3705	
3-phase 	For MCBs 3P	12 MW	214 mm	■		5ST3738	5ST3708	
		56 MW	1016 mm	–		5ST3740	5ST3710	
4-phase/3-phase + N 	For MCBs 4P or 3P+N	12 MW	214 mm	■		5ST3745	5ST3715	
		56 MW	1016 mm	–		5ST3746	5ST3716	
	For RCCB/MCBs or MCBs 1P+N	56 MW	1000 mm	–		5ST3770-2	5ST3770-3	

Accessories

Terminals for 5ST36 and 5ST37		Article No.
For conductors 6 ... 25 mm ²	Cable entry on the left	5ST3768-4
	Cable entry in the center	5ST3768-3
	Cable entry on the right	5ST3768-5
For conductors 6 ... 50 mm ²	Cable entry on the left	5ST3760-4
	Cable entry in the center	5ST3760-3
	Cable entry on the right	5ST3760-5
Terminals for Infeed at side		Article No.
For conductors 6 ... 25 mm ²	Short	5ST3768
	Short, IP20	5ST3771-2

End caps		Article No.
For 1-phase busbars (MCB 1P+N compact)	Gray	5ST3766
	Blue	5ST3767
	White	5ST3748
For 2 and 3-phase busbars		5ST3750
Touch protection		Article No.
For free connections, yellow (RAL 1004) 5 × 1 pin		5ST3655



For MCBs equipped with auxiliary switch (AS) or fault signal contact (FC)

Pin spacing in MW (1 MW = 18 mm)	Application	No. of MW	Length	End caps included	Conductor cross-section	
					10 mm ²	16 mm ²
1-phase, angled 90°					Article No.	Article No.
	For MCBs 1P	12 MW	214 mm	■	5ST3732	5ST3702
		56 MW	1016 mm	–	5ST3733	5ST3703
2-phase/1-phase + N					Article No.	Article No.
	For 2 MW devices (2P/1P+N)	12 MW	214 mm	■	5ST3736	5ST3706
		56 MW	1016 mm	–	5ST3737	5ST3707
3-phase					Article No.	Article No.
	For MCBs 3P	12 MW	214 mm	■	5ST3741	5ST3711
		56 MW	1016 mm	–	5ST3742	5ST3712
For MCBs 1P					Article No.	Article No.
	For MCBs 1P	12 MW	214 mm	■	5ST3743	5ST3713
		56 MW	1016 mm	–	5ST3744	5ST3714
4-phase/3-phase + N					Article No.	Article No.
	For MCBs 1P+N	56 MW	1016 mm	–	5ST3746-2	–

For MCBs equipped with undervoltage release (UR) or shunt trips (ST)

Pin spacing in MW (1 MW = 18 mm)	Application	No. of MW	Length	End caps included	Conductor cross-section	
					10 mm ²	16 mm ²
2-phase					Article No.	Article No.
	For MCBs 1P with UR/ST	56 MW	1016 mm	–	5ST3735-2	–

Standard busbars

Can be cut



For MCBs with line-side RCCB or RCCBs equipped with AS/FC devices

Pin spacing in MW (1 MW = 18 mm)	Application	No. of MW	Length	End caps included	Conductor cross-section	
					10 mm ²	16 mm ²
4-phase/3-phase + N					Article No.	Article No.
	For RCCB/MCBs	56 MW	1016 mm	–	5ST3746-2	–
	For 6 MCBs 1P+N with 1 RCCB 3P+N, N right	16 MW	292 mm	■	5ST3770-4	5ST3770-5

Accessories

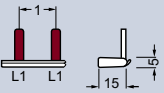
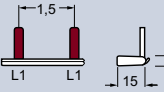
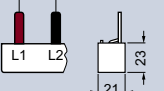
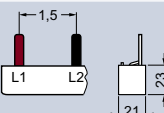
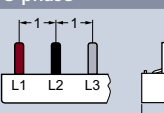

Terminals for 5ST36 and 5ST37		Article No.
For conductors 6 ... 25 mm ²	Cable entry on the left	5ST3768-4
	Cable entry in the center	5ST3768-3
	Cable entry on the right	5ST3768-5
For conductors 6 ... 50 mm ²	Cable entry on the left	5ST3760-4
	Cable entry in the center	5ST3760-3
	Cable entry on the right	5ST3760-5

End caps	Article No.
For 2 and 3-phase busbars	5ST3750
For 4-phase busbars	5ST3718
Touch protection	Article No.
For free connections, yellow (RAL 1004) 5 × 1 pin	5ST3655



5ST37 acc. to UL 508, can be cut

For miniature circuit breakers (MCBs)

Pin spacing in MW (1 MW = 18 mm)	Application	No. of MW	Length	Conductor cross-section	
				18 mm ²	25 mm ²
1-phase					
	For MCBs 1P or fuse holders 10 × 38 mm/class CC	56 MW	1000 mm	Article No. 5ST3701-0HG	Article No. –
	For MCBs 1P or fuse holders 14 × 51 mm	56 MW	1000 mm	–	Article No. 5ST3701-2HG
2-phase					
	For MCBs 2P or fuse holders 10 × 38 mm/class CC	56 MW	1000 mm	Article No. 5ST3705-0HG	Article No. –
	For MCBs 2P or fuse holders 14 × 51 mm	56 MW	1000 mm	–	Article No. 5ST3705-2HG
3-phase					
	For MCBs 3P or fuse holders 10 × 38 mm/class CC	56 MW	1000 mm	Article No. 5ST3710-0HG	Article No. –
	For MCBs 3P or fuse holders 14 × 51 mm	56 MW	1000 mm	–	Article No. 5ST3710-2HG

Standard busbars



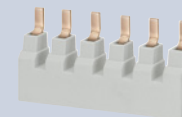
5ST37 acc. to UL 508, can be cut

For MCBs equipped with auxiliary switch (AS) or fault signal contact (FC)

Pin spacing in MW (1 MW = 18 mm)	Application	No. of MW	Length	Conductor cross-section	
				18 mm ²	25 mm ²
1-phase					
	For MCBs 1P	56 MW	1000 mm	Article No. 5ST3703-OHG	Article No. –
2-phase					
	For MCBs 2P	56 MW	1000 mm	Article No. 5ST3707-OHG	Article No. –
3-phase					
	For MCBs 3P	56 MW	1000 mm	Article No. 5ST3712-OHG	Article No. –
	For MCBs 1P	56 MW	1000 mm	Article No. 5ST3714-OHG	Article No. –

Accessories

Terminals according to UL 508		Article No.	
For infeed at the device	6 ... 35 mm ²	5ST3770-OHG	
For infeed at the busbar	2.5 ... 50 mm ²	5ST3770-1HG	
End caps according to UL 508		Article No.	
For 1-phase busbars		5ST3748-OHG	
For 2 and 3-phase busbars		5ST3750-OHG	
Touch protection according to UL 508		Article No.	
For open terminals, yellow 5 × 1 pin		5ST3655-OHG	



5ST3.. acc. to UL 489 specially for 5SJ4... -HG..

Fixed lengths, cannot be cut, for miniature circuit breakers (MCBs)¹⁾

Pin spacing in MW (1 MW = 18 mm)	Application	No. of MW	Length	Conductor cross-section 16 mm ²	Article No.
1-phase					
	For 6 MCBs 1P	6 MW	100 mm		5ST3663-0HG
	For 12 MCBs 1P	12 MW	205 mm		5ST3663-1HG
	For 18 MCBs 1P	18 MW	310 mm		5ST3663-2HG
2-phase					
	For 3 MCBs 2P	6 MW	100 mm		5ST3664-0HG
	For 6 MCBs 2P	12 MW	205 mm		5ST3664-1HG
	For 9 MCBs 2P	18 MW	310 mm		5ST3664-2HG
3-phase					
	For 2 MCBs 3P	6 MW	100 mm		5ST3665-0HG
	For 4 MCBs 3P	12 MW	205 mm		5ST3665-1HG
	For 6 MCBs 3P	18 MW	310 mm		5ST3665-2HG

¹⁾All unassigned pins of the busbars that cannot be cut must be covered with 5ST3666-1HG touch protection covers.

Can be cut, for MCBs

Pin spacing in MW (1 MW = 18 mm)	Application	No. of MW	Length	Conductor cross-section 18 mm ²	Article No.
1-phase					
	For MCBs 1P	56 MW	1016 mm		5ST3701-3HG
2-phase					
	For MCBs 2P	56 MW	1016 mm		5ST3705-3HG
3-phase					
	For MCBs 3P	56 MW	1016 mm		5ST3710-3HG

Standard busbars



5ST3.. acc. to UL 489 specially for 5SJ4... -HG..

Can be cut, for MCBs equipped with auxiliary switch (AS) or fault signal contact (FC)

Pin spacing in MW (1 MW = 18 mm)	Application	No. of MW	Length	Conductor cross-section 18 mm ²
1-phase				
	For MCBs 1P	56 MW	1016 mm	Article No. 5ST3703-3HG
2-phase				
	For MCBs 2P	56 MW	1016 mm	Article No. 5ST3707-3HG
3-phase				
	For MCBs 3P	56 MW	1016 mm	Article No. 5ST3712-3HG
	For MCBs 1P	56 MW	1016 mm	Article No. 5ST3714-3HG

Accessories

Terminals according to UL 489	Article No.
For infeed at the 5SJ4... -HG.. miniature circuit breaker	2.5 ... 35 mm ² 5ST3666-0HG 6 ... 35 mm ² 5ST3770-3HG
For infeed at the busbar	2.5 ... 50 mm ² 5ST3666-2HG
End caps according to UL 489	Article No.
For 1, 2 and 3-phase busbars	5ST3750-3HG

Touch protection according to UL 489	Article No.
For open terminals, yellow 3 × 1 pin	For 5ST37...-HG busbars that cannot be cut 5ST3666-1HG For 5ST37...-3HG busbars that can be cut 5ST3655-3HG

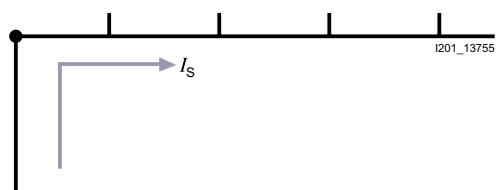
Compact busbars

General information



Infeed

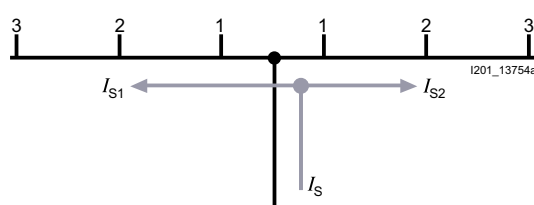
At the start or end of the busbar



Maximum busbar current I_s /phase

- Cross-section 10 mm²: 63 A
- Cross-section 16 mm²: 80 A

Along the busbar or midpoint infeed



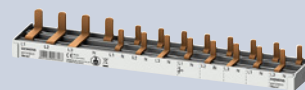
Maximum busbar current I_s /phase

- Cross-section 10 mm²: 100 A
- Cross-section 16 mm²: 130 A

Compact busbars

5ST36, fixed lengths, cannot be cut

Pin spacing in MW (1 MW = 18 mm)	Application	No. of MW	Length	End caps included	Conductor cross-section 10 mm ²
2-phase/1-phase + N, for infeed via RCCB					
	For 1 × RCCB 1P+N and 5 × compact devices equipped with 5SM6 arc fault detection unit	12 MW	216 mm	■	Article No. 5ST3685-0
2-phase/1-phase + N					
	For compact devices	6 MW	113 mm	■	Article No. 5ST3674-6
		9 MW	166 mm	■	5ST3674-7
		12 MW	218 mm	■	5ST3674-0
	For 12 × 5SY17 CBE (circuit breaker for equipment)	12 MW	218 mm	■	5ST3674-1
	For 6 × compact devices equipped with 5SM6 arc fault detection unit	11 MW	200 mm	■	5ST3676-0
4-phase/3-phase + N					
	For compact devices	6 MW	113 mm	■	Article No. 5ST3673-6
		9 MW	116 mm	■	5ST3673-7
		12 MW	218 mm	■	5ST3673-0
		14 MW	254 mm	■	5ST3673-4
	For 6 × compact devices equipped with 5SM6 arc fault detection unit	11 MW	200 mm	■	5ST3675-0



5ST37, can be cut

Pin spacing in MW (1 MW = 18 mm)	Application	No. of MW	Length	End caps included	Conductor cross-section 10 mm ²	Article No.
2-phase/1-phase + N, for infeed via RCCB						
	For 1 × RCCB 1P+N and 10 × compact devices	12 MW	215 mm	■		5ST3784-0
	For 1 × RCCB 1P+N (RCCB N left only) and 10 × compact devices	12 MW	215 mm	■		5ST3784-OKL
2-phase/1-phase + N						
	For compact devices	60 MW	1060 mm	–		5ST3774-0
	For compact devices equipped with 5SM6 arc fault detection unit	59 MW	1042 mm	–		5ST3776-0
	For compact devices equipped with auxiliary switch	59.5 MW	1055 mm	–		5ST3778-0
	For compact devices equipped with 5SM6 arc fault detection unit and auxiliary switch	58.5 MW	1036 mm	–		5ST3780-0
	For 2 MW units (MCBs or RCBOs) with mounted 5SM6 arc fault detection unit and auxiliary switch	54 MW	956 mm	–		5ST3786-0

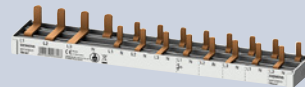
Accessories

Terminals for infeed at side	Article No.	Touch protection	Article No.
For conductors 6 ... 25 mm ² Short, IP20	5ST3771-2	For free connections, yellow (RAL 1004)	5ST3655
End caps	Article No.	For pins L2, L3	5ST3655-0HG
For 2 and 4-phase compact busbars	5ST3788-0		

Compact busbars

5ST37, can be cut

Pin spacing in MW (1 MW = 18 mm)	Application	No. of MW	Length	End caps included	Conductor cross-section 10 mm ²	Article No.
4-phase/3-phase + N, for infeed via RCCB						
	For 1 × RCCB 3P+N and 6 × compact devices	10 MW	181 mm	■		5ST3783-1
	For 1 × RCCB 3P+N and 8 × compact devices	12 MW	216 mm	■		5ST3783-0
	For 1 × RCCB 3P+N and 10 × compact devices	14 MW	251 mm	■		5ST3783-4
	For 1 × RCCB 3P+N (RCCB N left only) and 6 × compact devices	10 MW	181 mm	■		5ST3783-1KL
	For 1 × RCCB 3P+N (RCCB N left only) and 8 × compact devices	12 MW	216 mm	■		5ST3783-0KL
	For 1 × RCCB 3P+N, 1 × MCBs 3P and 7 × compact devices	14 MW	253 mm	■		5ST3785-4
	For 1 × RCCB 3P+N, 2 × MCBs 3P+N and 12 × compact devices	24 MW	430 mm	■		5ST3790-1
	For 1 × RCCB 3P+N, 2 × MCBs 3P+N and 45 × compact devices	57 MW	1009 mm	–		5ST3790-2
	For 1 × RCCB 3P+N, 1 × MCBs 3P+N and 4 × compact devices	12 MW	217 mm	■		5ST3795-0
	For 1 × RCCB 3P+N, 1 × MCBs 3P+N and 6 × compact devices	14 MW	253 mm	■		5ST3795-4



Pin spacing in MW (1 MW = 18 mm)	Application	No. of MW	Length	End caps included	Conductor cross-section 10 mm ²	Article No.
<p>4-phase/3-phase + N</p>	For compact devices	60 MW	1060 mm	–		5ST3773-0
	For compact devices equipped with 5SM6 arc fault detection unit	59 MW	1042 mm	–		5ST3775-0
	For compact devices equipped with auxiliary switch	59.5 MW	1055 mm	–		5ST3777-0

3








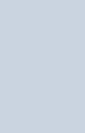
Accessories

Terminals for infeed at side	Article No.	Touch protection	Article No.
For conductors 6 ... 25 mm ² Short, IP20	5ST3771-2	For free connections,	For pins L1, N
End caps	Article No.	yellow (RAL 1004)	5ST3655
For 2 and 4-phase compact busbars	5ST3788-0		For pins L2, L3
			5ST3655-0HG

Accessories for busbars

General accessories

Terminals

	For conductors	Version	Cable entry	Infeed	Article No.
	6 ... 25 mm ²	Short	–	Lateral	5ST3768
		Short, IP20	–	Lateral	5ST3771-2
	6 ... 25 mm ²	–	Center	–	5ST3768-3
			Left	–	5ST3768-4
			Right	–	5ST3768-5
	6 ... 50 mm ²	–	Center	–	5ST3760-3
			Left	–	5ST3760-4
			Right	–	5ST3760-5
	2.5 ... 50 mm ²	–	–	Busbar	5ST3770-1HG
	6 ... 35 mm ²	–	–	Device	5ST3770-0HG
	2.5 ... 35 mm ²	For 5SJ4... -HG..	–	Miniature circuit breaker	5ST3666-0HG
	6 ... 35 mm ²	For 5ST37..-3HG that can be cut	–	Miniature circuit breaker	5ST3770-3HG
	2.5 ... 50 mm ²	–	–	Busbar	5ST3666-2HG

5ST36	5ST37	5ST37 (acc. to UL 508)	5ST3.. (acc. to UL 489)	5ST3 compact
■ ■	■ ■			■
	■ ■ ■			
	■ ■ ■			
		■		
		■		
			■ ■	
			■	

Accessories for busbars

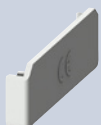
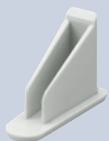
General accessories

Touch protection



Version	Scope of supply	Version	Article No.
For free connections, yellow (RAL 1004)	5 × 1 pin	–	5ST3655
			5ST3655-0HG
	3 × 1 pin	–	5ST3666-1HG
		–	5ST3655-3HG
For conductors 10 mm ²	20 × 5ST3613 + 10 × 5ST3614 + 50 × 5ST3615 + 50 × 5ST3655	–	5ST3656
For conductors 16 mm ²	20 × 5ST3643 + 10 × 5ST3644 + 50 × 5ST3645 + 50 × 5ST3655	For 5ST337...3HG	5ST3657

End caps



Version	Color	Article No.
For 1-phase busbars	Gray	5ST3748
For 2 and 3-phase busbars	Gray	5ST3750
For 4-phase busbars	Gray	5ST3718
For 1, 2 and 3-phase busbars	Gray	5ST3750-3HG
–	Gray	5ST3766
	Blue	5ST3767
For 1-phase busbars	Gray	5ST3748-0HG
For 2 and 3-phase busbars	Gray	5ST3750-0HG
For 2 and 4-phase compact busbars	Gray	5ST3788-0

5ST36	5ST37	5ST37 (acc. to UL 508)	5ST3.. (acc. to UL 489)	5ST3 compact
■		■		■
			■	■
■			■	
■				
	■			
	■			
	■			
■			■	
■				
			■	
			■	
				■

Accessories for busbars

General accessories

Series connectors




Conductor cross-section	Length of cable	Color	Number of phases	Article No.	
10 mm ²	125 mm	N conductor blue	1	5ST3781-0	
		Cable black	1	5ST3791-0	
			3	5ST3793-0	
	150 mm	N conductor blue	1	5ST3781-1	
		Cable black	1	5ST3791-1	
			3	5ST3793-1	
16 mm ²	125 mm	N conductor blue	1	5ST3782-0	
		Cable black	1	5ST3792-0	
			3	5ST3794-0	
	150 mm	N conductor blue	1	5ST3782-1	
		Cable black	1	5ST3792-1	
			3	5ST3794-1	
	200 mm	N conductor blue	1	5ST3781-2	
			1	5ST3791-2	
		Cable black	3	5ST3793-2	
			3 + N	5ST3793-3	
		3 × cables black and 1 × N conductor blue			

Distribution blocks for DIN-rail mounting

Acc. to IEC



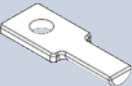
Distribution blocks acc. to IEC

	Number of poles	Rated operational voltage U_e	Rated current I_n	Mounting width	Article No.
	4-pole	690 V AC	80 A	5 MW	5ST2501
			125 A	5.5 MW	5ST2502
			160 A	9 MW	5ST2503

Further technical specifications

Further technical specifications		5ST2501	5ST2502	5ST2503	
Standards					
Standards		IEC 60947-7-1			
Supply					
Rated operational voltage AC		690 V			
Max. rated current		80 A	125 A	160 A	
Conductor cross-section					
Inputs per pole	Solid/stranded	1 × 2.5 ... 16 mm ²	1 × 6 ... 35 mm ²	1 × 10 ... 50 mm ²	
	Finely stranded with end sleeve	1 × 1.5 ... 10 mm ²	1 × 6 ... 25 mm ²	1 × 10 ... 35 mm ²	
Outputs per pole	Solid/stranded	8 × 1.5 ... 10 mm ²	5 × 1.5 ... 6 mm ² 2 × 4 ... 16 mm ²	8 × 2.5 ... 16 mm ² 3 × 10 ... 35 mm ²	
	Finely stranded with end sleeve	8 × 1.5 ... 10 mm ²	5 × 1.5 ... 6 mm ² (small) 2 × 4 ... 10 mm ² (large)	8 × 1.5 ... 16 mm ² (small) 3 × 10 ... 25 mm ² (large)	
Tightening torque					
Inputs	Screw terminals	13.5 lb-in (1.5 Nm)		3.5 ... 5 lb-in (2 Nm)	
	Tools	PZ2			
Outputs	Screw terminals	Large	13.5 lb-in (1.5 Nm)		
		Small	–	7.2 lb-in (0.8 Nm)	13.5 lb-in (1.5 Nm)
	Tools	Large	PZ1	PZ2	
		Small	–	PZ1	PZ2
Safety					
Rated peak withstand current I_{pk}		21.6 kA	24 kA	20 kA	
Rated short-time withstand current I_{cw} (1 s)		3 kA	4.2 kA	6.2 kA	
Ambient conditions					
Permissible ambient temperature		–25 ... +70 °C			
Degree of protection	Acc. to EN 60529	IP20			
Approved cable		Copper			

According to IEC and UL

Distribution blocks acc. to IEC and UL						
	Number of poles	Rated operational voltage U_e	Rated current I_n	Mounting width	Article No.	
	1-pole	600 V AC	80 A	1.5 MW	5ST2504	
			125 A	1.5 MW	5ST2505	
			160 A	2 MW	5ST2507	
			250 A	2.5 MW	5ST2508	
350 A			2.5 MW	5ST2511		
Connector for 5ST2505 distribution board						
	<ul style="list-style-type: none"> • Touch protection • 20 mm² • 32 mm² 					
	Version				Article No.	
	1-phase				5ST2506	
Terminal lug for ring terminal ends						
	Types				Article No.	
		For 5ST2508 distribution block				5ST2510
		For 5ST2511 distribution block				5ST2512

3

Further technical specifications		5ST2504	5ST2505	5ST2507	5ST2508	5ST2511		
Standards								
Standards		UL 1059/UL 486E/IEC 60947-7-1 UL File No. E80027/XCFR2 C22.2 No. 158 -1987/XCFR8						
Supply								
Rated operational voltage		UL	600 V AC					
		IEC	1000/1500 V AC/DC					
Max. rated current		UL	80 A	115 A	160 A	230 A	310 A	
		IEC	80 A	125 A	160 A	250 A	400 A	
Conductor cross-section								
Inputs per pole	Solid/stranded	Large	3 × 2.5 ... 25 mm ²	10 ... 35 mm ²	10 ... 70 mm ²	35 ... 120 mm ²	95 ... 185 mm ²	
			AWG 3 × 14 ... 4	AWG 1 × 8 ... 2	AWG 1 × 8 ... 2/0	AWG 1 × 2 ... 4/0	AWG 1 × 3/0 ... 350 MCM	
	Small	–	2.5 ... 25 mm ²	–	–	–	–	
		–	–	AWG 1 × 14 ... 6	–	–	–	
	Finely stranded with end sleeve	Large	3 × 2.5 ... 16 mm ²	10 ... 35 mm ²	10 ... 50 mm ²	35 ... 95 mm ²	95 ... 150 mm ²	
			AWG 3 × 14 ... 6	AWG 1 × 8 ... 2	AWG 1 × 8 ... 1	AWG 1 × 2 ... 3/0	AWG 3/0 ... 300 MCM	
Small	–	–	2.5 ... 25 mm ²	–	–	–		
	–	–	–	AWG 1 × 14 ... 6	–	–		
Outputs per pole	Solid/stranded	Top	2.5 ... 6 mm ²	2.5 ... 16 mm ²		2.5 ... 10 mm ²	2 × 2.5... 35 mm ²	
			AWG 4 × 14 ... 10	AWG 6 × 14 ... 4		AWG 4 × 16 ... 8	AWG 2 × 14 ... 2	
		Center	–	–		2.5 ... 16 mm ²	5 × 2.5 ... 16 mm ²	
			–	–		AWG 5 × 14 ... 6	–	
		Bottom	2.5 ... 6 mm ²	–	–		2 × 2.5... 35 mm ²	4 × 2.5 ... 10 mm ²
			AWG 4 × 14 ... 10	–	–		AWG 2 × 14 ... 2	AWG 4 × 14 ... 8
	Finely stranded with end sleeve	Top	2.5 ... 6 mm ²	2.5 ... 16 mm ²		2 × 2.5... 25 mm ²		
			AWG 4 × 14 ... 10	AWG 6 × 14 ... 6	AWG 6 × 14 ... 4	AWG 2 × 14 ... 4		
		Bottom	2.5 ... 6 mm ²	–	–		2 × 2.5... 25 mm ²	4 × 2.5 ... 25 mm ²
			AWG 4 × 14 ... 10	–	–		AWG 2 × 14 ... 4	AWG 5 × 14 ... 4

Continued on next page

Distribution blocks for DIN-rail mounting

According to IEC and UL (continued)

Further technical specifications			5ST2504	5ST2505	5ST2507	5ST2508	5ST2511
Tightening torque							
Inputs	Screw terminals		13.2 ... 26.5 lb-in (1.5 ... 3 Nm)	31 ... 44 lb-in (3.5 ... 5 Nm)	44 ... 53 lb-in (5 ... 6 Nm)	170 ... 186 lb-in (19 ... 21 Nm)	222 lb-in (25 Nm)
	Tools		PZ2	Allen key 4 mm	Allen key 5 mm	Allen key 6 mm	Allen key 8 mm
Outputs	Screw terminals	Large	13.2 ... 26.5 lb-in (1.5 ... 3 Nm)	17.7 ... 26.5 lb-in (2 ... 3 Nm)	13.2 ... 26.5 lb-in (1.5 ... 3 Nm)	31 ... 62 lb-in (3.5 ... 7 Nm)	
		Small	7 ... 13.2 lb-in (0.8 ... 1.5 Nm)	–		18 ... 27 lb-in (2 ... 3 Nm)	
	Tools	Large	PZ2			Standard screwdriver	
		Small	PZ1	PZ2		Standard screwdriver	
Safety							
Rated peak withstand current I_{pk}			2.7 kA	30 kA		51 kA	
Rated short-time withstand current I_{cw} (1 s)			1.9 kA	4.2 kA	11 kA	21 kA	
Overcurrent protection class			J				
Short circuit current rating (SCCR)	RMS Sym A		100 kA				
Electrical isolation	Creepage distances		1/2" (12.7 mm)				
	Clearances		3/8" (9.5 mm)				
Ambient conditions							
Permissible ambient temperature			–25 ... +70 °C				
Degree of protection	Acc. to EN 60529		IP20				
Fire class			UL 94V-0				
Approved cable			Copper				

SIKclip wiring system

SIKclip busbar



Length	Article No.
12 MW	5ST2520
24 MW	5ST2521
36 MW	5ST2522

Connecting cables with plug



Length	Conductor cross-section	Color	Article No.
120 mm	6 mm ²	Black	5ST2523
		Blue	5ST2524
	10 mm ²	Black	5ST2525
		Blue	5ST2526
200 mm	6 mm ²	Black	5ST2527
		Blue	5ST2528
	10 mm ²	Black	5ST2530
		Blue	5ST2531

Crimp connector



- For connection to cables 4/6 mm²

Article No.
5ST2532

Mounting brackets



- For mounting on the rear of the DIN rail (pair)

Article No.
5ST2533

Further technical specifications

5ST25..

Standards

Test specifications EN 60947-1, EN 61439-1

Rated values

Rated operational voltage U_n 400 V AC

Max. rated current I_n 250 A

Max. rated output current I_n (at 40 °C ambient temperature) 63 A

Rated insulation voltage 660 V AC

Test voltage (50 Hz) 2.5 kV

Ambient conditions

Degree of protection IP20

Connecting cables 40 A (6 mm²), 63 A (10 mm²)

Connecting cable type H07VK

Ambient temperature -5 ... +60 °C



More safety for humans, plants and assets

The number of electrical consumers in residential homes and commercial buildings has increased dramatically in recent decades.

Modern appliances often have quite different characteristics in terms of current consumption than earlier equipment due, for example, to the use of frequency converters in washing machines, or switched-mode power supply units in TVs, PCs or LED lights.

There are also decentralized power generators like photovoltaic systems or charging devices for electric vehicles.

All of this requires new protection strategies for electrical installations. This also includes appropriate residual current protective devices or residual current operated circuit breakers that will cut the current immediately and safely in the event of a fault.

Residual Current Protective Devices/ Arc Fault Detection Devices (AFDDs)



All the information you need	4/2
System overview	4/4
Introduction	4/5
Quick selection guide	4/6
RCCBs	4/6
RC units	4/8
RCBOs	4/10
Arc fault detection devices (AFDD)	4/12
Basic units	4/14
5SV RCCBs, type A, F and AC	4/14
5SV3 RCCBs, type B and B+ (SIQUENCE)	4/28
5SM3 RCCBs, type A and AC	4/32
5SM2 RC units, type A, F and AC	4/34
5SU1 RCBOs, type A, F, AC, B and B+	4/40
5SV1 RCBOs (1 MW), type A, F and AC	4/52
5SM6 arc fault detection units	4/54
5SV6 arc fault detection device	4/55
5SV6 COM AFDD/MCB with communication and measuring function	4/56
Accessories	4/58
Overview of modular system	4/58
Electrical accessories	4/60
Mechanical accessories	4/69
RCCB protective socket outlets	4/70
Standard busbars	4/72
Compact busbars	4/77

A wealth of additional information ...

Information + ordering

All the important things at a glance

For information about residual current protective devices/arc fault detection devices, please visit our websites

www.siemens.com/rccb

www.siemens.com/circuit-protection

Your product in detail

The SiePortal platform (knowledge base) provides comprehensive information

www.siemens.com/lowvoltage/product-support

- Technology Primer
 - Residual current protective devices ([109482301](#))

The relevant tender specifications can be found at www.siemens.com/tenderspecifications

Use our conversion tool for quick and easy conversion to Siemens products www.siemens.com/conversion-tool

Siemens YouTube channel

- Residual current protective devices (general) sie.ag/58TyMb

Everything you need for your order

Refer to SiePortal to find an overview of your products (product catalog)

- Residual current protective devices sie.ag/2m55Y7j
- Arc fault detection devices sie.ag/3KPJpNn

Direct forwarding to the individual products in SiePortal by clicking on the article number in the catalog or entering this web address incl. article number

www.siemens.com/product_catalog_SIEP?Article No.

The fast track to the experts

Contact persons in your region

We offer a comprehensive portfolio of services.

You can find your local contacts at

www.siemens.com/lowvoltage/components/contact

You will find further information on services at

www.siemens.com/service-offers

Competent expert advice on technical questions with a wide range of demand-optimized services for all our products and systems.

Assistance with technical queries is provided at

www.siemens.com/support-request

... can be found in our online services

Commissioning + operation

Your product in detail

The SiePortal platform (knowledge base) provides detailed technical information

www.siemens.com/lowvoltage/product-support

- Operating instructions
- Characteristic curves
- Certificates

Online Support app available for download from the [App Store](#) and [Play Store](#)

You will find further information at www.siemens.com/support-app

Provision of 3D data (step and u3d data formats)

- SiePortal (product catalog)
www.siemens.com/lowvoltage/product-catalog
- Image database
www.siemens.com/lowvoltage/picturedb

Engineering data for CAD or CAE systems are available in the CAx Download Manager at www.siemens.com/cax

Manuals

Manuals can be found in SiePortal at www.siemens.com/lowvoltage/manuals

- Configuration Manual
 - Residual current protective devices/arc fault detection devices **(45303255)**
- Installation Manual
 - Circuit protection devices with communication and measuring function **(109791805)**
- System Manual
 - Circuit protection devices with communication and measuring function **(109791806)**

Face-to-face or online training

Our training courses can be found at www.siemens.com/sitrain-lowvoltage

- 5SM6/5SV6 arc fault detection devices (WT-LVBAFDD)
- SENTRON circuit protection devices with measuring and communication function (WT-LVBCOM)
- Basic principles of electrical engineering (WT-LVBGET)
- Protection concept (WT-LVBPC)

Technical overview – Residual current protective devices/arc fault detection devices



The fast way to get you to our online services

This page provides you with comprehensive information and links on residual current protective devices/arc fault detection devices

www.siemens.com/lowvoltage/product-support **(109769082)**

System overview

Basic units and accessories

Basic units



5SV3 RCCBs



5SM3 RCCBs



5SM2 RC units



5SU1 RCBOs



5SV1 RCBOs

5SM6 arc fault detection units and
5SV6 AFDD/RCB and
5SV6 COM AFDD/RCB

4

Electrical accessories



Auxiliary switches (AS)

Fault signal contacts
(FC)Auxiliary switches and
fault signal contacts
(AS + FC)/(AS + FC) COM

Shunt trips (ST)

Undervoltage releases
(UR)Remote control mecha-
nisms
(RC mech.)

Mechanical accessories



Locking devices



Handle couplers



Touch protection



Wall enclosures

Molded-plastic enclo-
sures

Terminal covers

Busbars and accessories



Compact busbars



Standard busbars



Terminals



Touch protection



End caps

RCCB protective socket outlets

In molded-plastic
enclosureFor mounting
on device box

Note:

You will find a detailed range of accessories with the basic units and in the Accessories section.

Introduction

Residual current protective devices

Selection criteria

Equipment, power, ambient conditions

Design

RCCBs
RCBOs
RC units

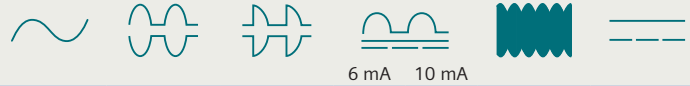
Number of pole

1P+N
2P
3P
3P+N
4P

Rated current I_n

0.3 ... 125 A

Types and waveform



Type AC		■	-	-	-	-	-	-
Type A		■	■	■	■	-	-	-
Type F		■	■	■	■	■	■	-
Type B		■	■	■	■	■	■	■
Type B+		■	■	■	■	■	■	■

Version

SIGRES	With active condensation protection for use in severe ambient conditions
[G]/[K]	Super resistant, 10 ms short-term delayed devices with increased immunity to false triggering due to transient disruptions
[S]	As an upstream group switch for selective shutdown against downstream RCCBs
500 V	With their creepage distances and clearances designed for power grids up to 500 V alternating voltage
50 ... 400 Hz	Meet the triggering conditions up to 400 Hz due to low decrease in sensitivity with increasing frequency

Protection objective, equipment directives
VDE 0100-410,
VDE 0100-530,
VDE 0100-7xx,
VDS 3501,
shutdown conditions according to VDE 0100-410

Rated residual current $I_{\Delta n}$ (protection objective)

Additional protection $I_{\Delta n} \leq 30$ mA
Error protection $I_{\Delta n} > 30$ mA
Fire protection $I_{\Delta n} \leq 300$ mA

Characteristic CB (for residual current operated circuit breakers)

A
B
C
D

RCCBs



5SV

Types		Instantaneous	SIGRES, instantaneous	Short-time delayed [G]/[K]
Type AC		■	–	–
Type A		■	■	■
Type F		–	–	–
Type B/B+		–	–	–
Peak withstand current 8/20 μs				
Type A	kA	> 1		> 3
Type F	kA	–	–	> 3
Type B/B+	kA	–	–	–
Minimum operational voltage for operation of test equipment				
30-mA devices	V AC			195
Non-30-mA devices	V AC			100
24 V devices	V AC			20
Terminal conductor cross-sections				
1 conductor	Solid/stranded	mm ²	0.75 ... 35	
	Finely stranded with end sleeve	mm ²	0.75 ... 25	
	Finely stranded without end sleeve	mm ²	1 ... 35	
2 conductors, same cross-section, same conductor type	Solid/stranded	mm ²	0.75 ... 10	
	Finely stranded with end sleeve	mm ²	0.75 ... 4	
	Finely stranded without end sleeve	mm ²	1 ... 4	
1 conductor + busbar (pin thickness 1.5 mm)	Solid/stranded	mm ²	10 ... 25	
	Finely stranded with non-insulated end sleeve	mm ²	6 ... 25	
	Finely stranded with insulated end sleeve	mm ²	6 ... 16	
Terminal tightening torque		Nm	2.5... 3.5	
Poles				
Number of poles			1P+N 3P+N	
Rated voltage U_n	V AC		24 ... 125 230 400 500	
Operating frequency	Hz		50 50 ... 400 50/60	
Standards				
			IEC/EN 61008 (VDE 0664-10), IEC/EN 61008-2-1 (VDE 0664-11), IEC/EN 61543 (VDE 0664-30), IEC/EN 62423 (VDE 0664-40), ÖVE EN 61008, ÖVE/ÖNORM E 8601	
Rated residual current $I_{\Delta n}$	mA		10, 30, 100, 300, 500, 1000	
Rated current I_n	A		16 ... 80	
Rated breaking capacity I_{cn}	kA		–	
Connection			N right N left	
Service life	Average number of operating cycles		> 10000	
Test button test cycles			Half-yearly ¹⁾ SIGRES annually ²⁾	
Degree of protection	Acc. to EN 60529 (VDE 0470-1)		IP20, if the distribution board is installed, with connected conductors	
Touch protection	Acc. to EN 50274 (VDE 0660-514)		Finger and back-of-hand safe	
Temperature	Storage temperature	°C	–40 ... +75 °C	
	Ambient temperature	°C	–25 ... +45, marked with	
Resistance to climate	Acc. to IEC 60068-2-30		28 cycles (55 °C; 95% rel. humidity)	
CFC and silicone-free			■	
Mains connection			Top bottom SIGRES on top only	
Overvoltage category Degree of pollution			III 2	

Further information

¹⁾ Extension to annual test interval under certain conditions

²⁾ Extension to four-yearly test interval under certain conditions

See page 4/14



5SV



SIQUENCE 5SV3




5SM3

5SV			SIQUENCE 5SV3			5SM3
Super resistant [K]	Selective [S]	SIGRES, selective [S]	SIGRES, super resistant [K]	SIGRES, super resistant [K], 6 mA DC	SIGRES, selective [S]	Instantaneous
-	-	-	-	-	-	■
■	■	■	-	■	-	■
■	■	-	-	■	-	-
-	-	-	■	■	■	-
> 3		> 5	-	> 1	-	> 1
> 3	-	-	-	> 3	-	-
-	-	-	> 3	> 3	> 5	-
	195			70		195
	100			70		195
	20			-		-
	0.75 ... 35			0.75 ... 35		1.5 ... 50 (2 MW)
	0.75 ... 25			0.75 ... 25		-
	1 ... 35			1 ... 35		-
	0.75 ... 10			0.75 ... 10		-
	0.75 ... 4			0.75 ... 4		-
	1 ... 4			1 ... 4		-
	10 ... 25			0.75 ... 35		-
	6 ... 25			0.75 ... 25		-
	6 ... 16			1 ... 35		-
	2.5... 3.5			2.5 ... 3.0		3.0... 3.5
	1P+N 3P+N			1P+N 3P+N		1P+N
	24 ... 125 230 400 500			230 400		230
	50/60			50/60		50
	IEC/EN 61008 (VDE 0664-10), IEC/EN 61008-2-1 (VDE 0664-11), IEC/EN 61543 (VDE 0664-30), IEC/EN 62423 (VDE 0664-40), ÖVE EN 61008, ÖVE/ÖNORM E 8601			IEC/EN 62423 (VDE 0664-40), IEC/EN 61543 (VDE 0664-30), DIN VDE 0664-400 (Type B+ only)		IEC/EN 61008-1 (VDE 0664-10), IEC/EN 61008-2-1 (VDE 0664-11), IEC/EN 61543 (VDE 0664-30), IEC/EN 62423 (VDE 0664-40)
	10, 30, 100, 300, 500, 1000			30, 300, 500		30, 100, 300
	16 ... 80			16 ... 80		100 ... 125
	-			-		-
	N right N left			N right		N right
	> 10000			> 10000		> 10000
	Half-yearly ¹⁾ SIGRES annually ²⁾			Annually ²⁾		Half-yearly
	IP20, if the distribution board is installed, with connected conductors			IP20, if the distribution board is installed, with connected conductors		IP20, if the distribution board is installed, with connected conductors
	Finger and back-of-hand safe			Finger and back-of-hand safe		Finger and back-of-hand safe
	-40 ... +75 °C			-40 ... +75 °C		-40 ... +75 °C
	-25 ... +45, marked with			-25 ... +45, marked with		-25 ... +45, marked with
	28 cycles (55 °C; 95% rel. humidity)			28 cycles (55 °C; 95% rel. humidity)		28 cycles (55 °C; 95% rel. humidity)
	■			■		■
	Top bottom SIGRES on top only			Top bottom SIGRES on top only		Top bottom
	III 2			III 2		III 2
	See page 4/14			See page 4/28		See page 4/32

RC units



5SM2 (0.3 ... 63 A)

Types		Instantaneous
Type AC		■
Type A		■
Type F		–
Peak withstand current 8/20 μs		
Type A	kA	> 1
Type F	kA	–
Minimum operational voltage for test equipment		
30-mA devices	V AC	195
Non-30-mA devices	V AC	100
Terminal conductor cross-sections		
Solid/stranded	mm ²	1.0 ... 25
Terminal tightening torque	Nm	2.5 ... 3.0
Poles		
Number of poles		2P 3P 4P
Rated voltage U_n	V AC	230 400
Operating frequency	Hz	50 50/60
Standards		
		IEC/EN 61009-1 (VDE 0664-20), IEC/EN 61009-2-1 (VDE 0664-21), IEC/EN 61543 (VDE 0664-30), IEC/EN 62423 (VDE 0664-40)
Rated residual current $I_{\Delta n}$	mA	10, 30, 100, 300, 500, 1000
Rated current I_n	A	0.3 ... 63
Service life	Average number of operating cycles	> 10000
Test button test cycles		Half-yearly ¹⁾
Degree of protection	Acc. to EN 60529 (VDE 0470-1)	IP20, if the distribution board is installed, with connected conductors
Touch protection	Acc. to EN 50274 (VDE 0660-514)	Finger and back-of-hand safe
Temperature	Storage temperature	–40 ... +75 °C
	Ambient temperature	–25 ... +45, marked with 
Resistance to climate	Acc. to IEC 60068-2-30	28 cycles (55 °C; 95% rel. humidity)
CFC and silicone-free		■
Mains connection		Top bottom
Overvoltage category Degree of pollution		III 2

See page 4/34

¹⁾ Extension to annual test interval under certain conditions

²⁾ Extension to four-yearly test interval under certain conditions



5SM2 (0.3 ... 63 A)

5SM2 (80 ... 100 A)

Super resistant [K]	Selective [S]	SIGRES, instantaneous	Instantaneous	Selective [S]
■	■	–	■	■
■	■	■	■	■
■	–	–	–	–
> 3	> 5	> 1	> 1	> 5
> 3	–	–	–	–
	195		195	
	100		100	
	1.0 ... 25		6.0 ... 50	
	2.5 ... 3.0		2.5 ... 3.0	
2P 3P 4P		4P	2P 4P	
	230 400		230 400	
	50 50/60		50 50/60	
IEC/EN 61009-1 (VDE 0664-20), IEC/EN 61009-2-1 (VDE 0664-21), IEC/EN 61543 (VDE 0664-30), IEC/EN 62423 (VDE 0664-40)			IEC/EN 61009-1 (VDE 0664-20), IEC/EN 61009-2-1 (VDE 0664-21), IEC/EN 61543 (VDE 0664-30), IEC/EN 62423 (VDE 0664-40)	
30	300, 500, 1000	30, 300	30, 300	300, 1000
	0.3 ... 63		80 ... 100	
	> 10000		> 10000	
Half-yearly ¹⁾		Yearly ²⁾	Half-yearly ¹⁾	
IP20, if the distribution board is installed, with connected conductors			IP20, if the distribution board is installed, with connected conductors	
Finger and back-of-hand safe			Finger and back-of-hand safe	
–40 ... +75 °C			–40 ... +75 °C	
–25 ... +45, marked with			–25 ... +45, marked with	
28 cycles (55 °C; 95% rel. humidity)			28 cycles (55 °C; 95% rel. humidity)	
	■		■	
	Top bottom		Top bottom	
	III 2		III 2	
See page 4/34			See page 4/34	

RCBOs



5SU1 (up to 40 A)

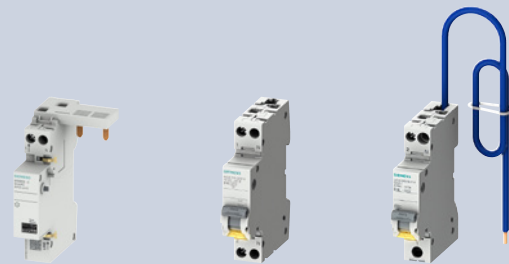
Types		Instantaneous	Short-time delayed/ Super resistant	Selective [S]
Type AC		■	■	–
Type A		■	■	■
Type B		–	–	–
Type B+		–	–	–
Type F		–	■	–
Peak withstand current 8/20 μs				
Type A	kA	> 1	> 3	> 5
Type F	kA	–	> 3	–
Minimum voltage for operation of the test equipment				
30-mA devices	V AC		195	
Non-30-mA devices	V AC		100	
Terminal conductor cross-sections				
1 conductor at front + busbar at rear	Solid/stranded	mm ²	0.75 ... 35	
	Finely stranded with end sleeve	mm ²	0.75 ... 25	
	Finely stranded without end sleeve	mm ²	1 ... 25	
2 conductors at rear	Solid/stranded	mm ²	0.75 ... 6	
	Finely stranded with non-insulated end sleeve	mm ²	0.75 ... 4	
	Finely stranded with insulated end sleeve	mm ²	0.75 ... 4	
	Finely stranded without end sleeve	mm ²	1 ... 4	
Terminal tightening torque	Nm		2.5 ... 3.0	
Poles				
Number of poles			1P+N 2P	
Rated voltage U_n	V AC		110 230	
Operating frequency	Hz		50 50/60	
Standards				
			IEC/EN 61009-1 (VDE 0664-20), IEC/EN 61009-2-1 (VDE 0664-21), IEC/EN 61543 (VDE 0664-30), IEC/EN 62423 (VDE 0664-40)	
Rated residual current $I_{\Delta n}$	mA		10, 30, 100, 300	
Rated current I_n	A		6 ... 40	
Rated breaking capacity I_{cn}	kA		4.5 6 10	
Connection			N right N left	
Service life	Average number of operating cycles		> 10000	
Test button test cycles			Half-yearly ¹⁾	
Degree of protection	Acc. to EN 60529 (VDE 0470-1)		IP20, if the distribution board is installed, with connected conductors	
Touch protection	Acc. to EN 50274 (VDE 0660-514)		Finger and back-of-hand safe	
Temperature	Storage temperature	°C	–40 ... +75 °C	
	Ambient temperature	°C	–25 ... +45, marked with	
Resistance to climate	Acc. to IEC 60068-2-30		28 cycles (55 °C; 95% rel. humidity)	
CFC and silicone-free			■	
Mains connection			Top bottom	
Energy limitation class			3	
Overvoltage category Degree of pollution			III 2	
Further information				
			See page 4/44	

¹⁾ Extension to annual test interval under certain conditions



5SV1		5SU1 (up to 32 A)		5SU1 (125 A)		5SU1 (100 A, 125 A)	
Instantaneous	Short-time delayed/ Super resistant	Instantaneous	Short-time delayed/ Super resistant	Instantaneous	Short-time delayed/ Super resistant	Short-time delayed/ Super resistant	Selective [S]
■	–	–	–	■	■	–	–
■	■	■	■	■	■	–	–
–	–	–	–	–	–	■	■
–	–	–	–	–	–	■	■
–	■	–	–	–	–	–	–
> 1	> 3	> 0.25	> 3	> 1	> 3	> 3	> 5
–	> 3	–	–	–	–	–	–
195		2P, 4P: 195 V 3P: 340 V		195		195	
100		2P, 4P: 195 V 3P: 340 V		100		100	
0.75 ... 16		1 ... 35		25 ... 50		20 ... 50	
0.75 ... 10		1 ... 35		25 ... 35		25 ... 35	
0.75 ... 16		–		–		–	
0.75 ... 4		–		–		–	
0.75 ... 2.5		–		–		–	
0.75 ... 1.5		–		–		–	
0.75 ... 4		–		–		–	
1.2 ... 2.0		2.0		3.0 ... 3.5		3.0 ... 3.5	
1P+N		2P 3P 4P		2P 4P		4P	
230		230 V 400 V		230 400		400 430	
50 50/60		50 50/60		50 50/60		50/60	
IEC/EN 61009-1 (VDE 0664-20), IEC/EN 61009-2-1 (VDE 0664-21), IEC/EN 61543 (VDE 0664-30), IEC/EN 62423 (VDE 0664-40)		IEC/EN 61009-1 (VDE 0664-20), IEC/EN 61009-2-1 (VDE 0664-21)		IEC/EN 61009-1 (VDE 0664-20), IEC/EN 61009-2-1 (VDE 0664-21), IEC/EN 61543 (VDE 0664-30), IEC/EN 62423 (VDE 0664-40)		IEC/EN 61009-1 (VDE 0664-20), IEC/EN 61009-2-1 (VDE 0664-21), IEC/EN 61543 (VDE 0664-30), IEC/EN 62423 (VDE 0664-40)	
30, 300		30, 300		30, 300, 1000		30, 300	
2 ... 16		6 ... 32		125		100, 125	
4.5 6		6 10		10		10	
N right		–		N right N left		N right N left	
> 10 000		> 10000		> 10000		> 10000	
Half-yearly ¹⁾		Monthly		Half-yearly ¹⁾		Half-yearly ¹⁾	
IP20, if the distribution board is installed, with connected conductors		IP20, if the distribution board is installed, with connected conductors		IP20, if the distribution board is installed, with connected conductors		IP20, if the distribution board is installed, with connected conductors	
Finger and back-of-hand safe		Finger and back-of-hand safe		Finger and back-of-hand safe		Finger and back-of-hand safe	
–40 ... +75 °C		–40 ... +70 °C		–40 ... +75 °C		–40 ... +75 °C	
–25 ... +45, marked with		–25 ... +40, marked with		–25 ... +45, marked with		–25 ... +45, marked with	
28 cycles (55 °C; 95% rel. humidity)		28 cycles (55 °C; 95% rel. humidity)		28 cycles (55 °C; 95% rel. humidity)		28 cycles (55 °C; 95% rel. humidity)	
■		–		■		■	
Top bottom		Top bottom		Top bottom		Top bottom	
3		3 1		3		3	
III 2		III 3		III 2		III 2	
See page 4/52		See page 4/46		See page 4/48		See page 4/51	

Arc fault detection devices (AFDDs)



5SM6





5SV6

5SV6...KP..

Poles			5SM6	5SV6	5SV6...KP..
Number of poles			2P	1P+N	1P+N
Rated voltage U_n	V AC		230	230	230
Operating frequency	Hz		50	50	50
Terminal conductor cross-sections					
Solid and stranded	mm ²		0.75 ... 16	0.75 ... 16	0.75 ... 16 (top) 0.75 ... 35 (bottom)
Finely stranded with end sleeve	mm ²		0.75 ... 10	0.75 ... 10	0.75 ... 10 (top) 0.75 ... 25 (bottom)
Terminal tightening torque	Nm		2.0 ... 2.5	1.2 ... 2.0	1.2 ... 2.0 (top) 2.5 ... 3.5 (bottom)
Standards			IEC/EN 62606	IEC/EN 62606	IEC/EN 62606
Rated current I_n	A		Up to 16/40 A	6 ... 40	6 ... 40
Service life	Average number of operating cycles		> 10000	> 10000	> 10000
Mounting position			Any	Any	Any
Degree of protection	Acc. to EN 60529 (VDE 0470-1)		IP20, with connected conductors	IP20, with connected conductors	IP20, with connected conductors
Touch protection	Acc. to EN 50274 (VDE 0660-514)		Finger and back-of-hand safe	Finger and back-of-hand safe	Finger and back-of-hand safe
Temperature	Storage temperature	°C	-40 ... +75 °C	-40 ... +75 °C	-40 ... +75 °C
	Ambient temperature	°C	-25 ... +45, marked with	-25 ... +45, marked with	-25 ... +45, marked with
Resistance to climate	Acc. to IEC 60068-2-30		28 cycles (55 °C; 95% rel. humidity)	28 cycles (55 °C; 95% rel. humidity)	28 cycles (55 °C; 95% rel. humidity)
CFC and silicone-free			■	■	■
Mains connection			Bottom	Top bottom	Bottom
Overvoltage category Degree of pollution			III 2	III 2	III 2
Tripping in the event of overvoltage	V		> 275	> 285	> 285
Additional functions					
Communication and measuring function			-	■	-
Further information			See page 4/54	See page 4/55 and page 4/14	See page 4/55

5SV RCCBs

Type A, 1P+N

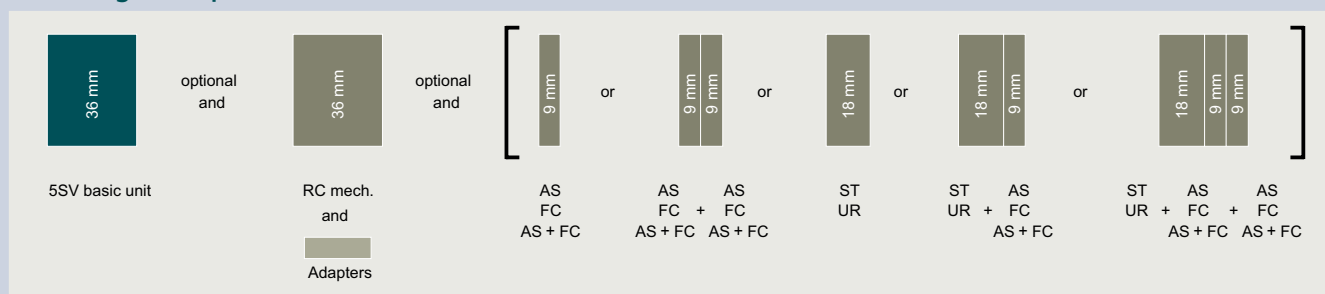
Rated voltage U_n N connection	Instantaneous			Instantaneous (only available in Belgium) ²⁾
	24 ... 125 V AC	230 V AC		230 V AC
Right			Left 	Right 

$I_{\Delta n}$	I_n	Thermal overload protection ¹⁾	Bulk packaging (36 units)				
Type A							
10 mA	16 A	–	–	–	5SV3111-6	5SV3111-6KL	–
	25 A	–	–	–	5SV3112-6	–	–
30 mA	16 A	–	–	5SV3311-6KK13	5SV3311-6	5SV3311-6KL	–
	–	–	■	–	5SV3311-6GV01	–	–
	25 A	–	–	5SV3312-6KK13	5SV3312-6	5SV3312-6KL	5SV3312-6BA
	–	–	■	–	5SV3312-6GV01	–	–
40 A	–	–	–	5SV3314-6KK13	5SV3314-6	5SV3314-6KL	5SV3314-6BA
	–	–	■	–	5SV3314-6GV01	–	–
	–	–	–	–	5SV3314-6LA	–	–
	–	–	–	–	–	–	–
63 A	–	–	–	5SV3316-6KK13	5SV3316-6	5SV3316-6KL	5SV3316-6BA
	80 A	–	–	–	5SV3317-6	5SV3317-6KL	–
100 mA	25 A	–	–	–	5SV3412-6	5SV3412-6KL	5SV3612-6BA
	40 A	–	–	–	5SV3414-6	5SV3414-6KL	5SV3614-6BA
	63 A	–	–	–	5SV3416-6	5SV3416-6KL	5SV3616-6BA
	80 A	–	–	–	5SV3417-6	5SV3417-6KL	–
300 mA	25 A	–	–	–	5SV3612-6	5SV3612-6KL	–
	40 A	–	–	–	5SV3614-6	5SV3614-6KL	–
	63 A	–	–	–	5SV3616-6	5SV3616-6KL	–
	80 A	–	–	–	5SV3617-6	5SV3617-6KL	–

¹⁾ Thermal overload protection according to OVE E 8101 possible up to rated current of the RCCB (40 A, 63 A).







²⁾ These products cannot be used in France according to NF C 15-100. Product complies with the specifications of the Belgian market only. (Simultaneous tripping of the 3 poles and the N conductor.) Available for the export market only.

Mounting concept



AS	Auxiliary switch	See page 4/60
FC	Fault signal contact	See page 4/62
AS + FC	Auxiliary switch and fault signal contact	See page 4/63
ST	Shunt trips	See page 4/66
UR	Undervoltage release	See page 4/67
RC mech.	Remote control mechanism	See page 4/68

1201_20467

SIGRES, instantaneous	Short-time delayed [G]	Super resistant [K]	Selective [S]		SIGRES, super resistant [K], 6 mA DC
230 V AC	230 V AC	230 V AC	230 V AC		230 V AC
Right	Right	Right	Right	Left	Right
					
–	–	–	–	–	–
–	–	–	–	–	–
5SV3311-6KK12	–	–	–	–	–
–	–	–	–	–	–
5SV3312-6KK12	–	5SV3312-6KK01	–	–	5SV3322-6KK60
–	–	–	–	–	–
5SV3314-6KK12	–	5SV3314-6KK01	–	–	5SV3324-6KK60
–	–	–	–	–	–
–	5SV3314-6LA01	–	–	–	–
5SV3316-6KK12	–	5SV3316-6KK01	–	–	–
–	–	5SV3317-6KK01	–	–	–
–	–	–	–	–	–
–	–	–	–	–	–
–	–	–	5SV3416-8	–	–
–	–	–	–	–	–
–	–	5SV3612-6KK01	5SV3612-8	–	–
–	–	5SV3614-6KK01	5SV3614-8	5SV3614-8KL	–
–	–	5SV3616-6KK01	5SV3616-8	5SV3616-8KL	–
–	–	5SV3617-6KK01	5SV3617-8	–	–

Accessories




Auxiliary switches (AS)		Article No.
1 NO + 1 NC	Standard	5ST3010
	For low power	5ST3013
	For low power (with diode)	5ST3013-0XX01
2 NO	Standard	5ST3011
	For low power	5ST3014
2 NC	Standard	5ST3012
	For low power	5ST3015
1 CO	Standard	5ST3016
Fault signal contacts (FC)		Article No.
1 NO + 1 NC		5ST3020
2 NO		5ST3021
2 NC		5ST3022
Auxiliary switches and fault signal contacts (AS + FC)		Article No.
1 CO (AS) + 1 CO (FC)		5ST3062
5ST3 COM (AS + FC)		5ST3062-0MC

¹⁾ Combination of undervoltage release with 5SV RCCB not suitable for implementation of EMERGENCY-OFF/EMERGENCY-STOP circuits

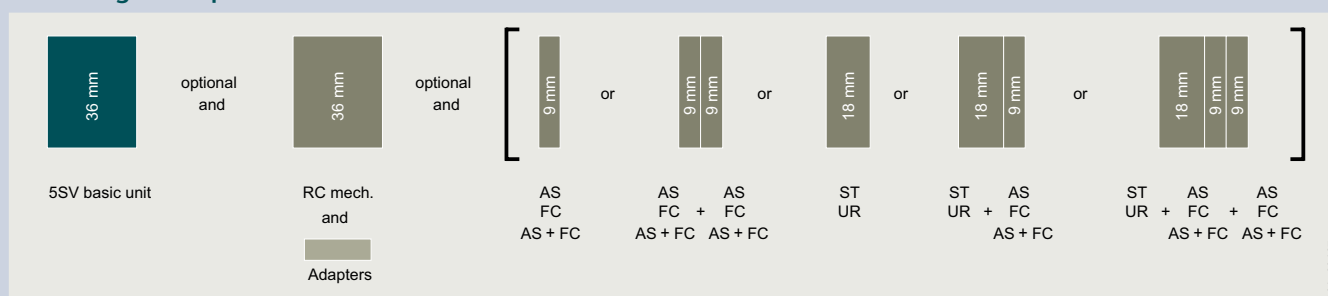
Shunt trips (ST)		Article No.
110 ... 415 V AC, 110 ... 220 V DC		5ST3030
24 ... 48 V AC/DC		5ST3031
12 V DC		5ST3031-0XX01
Undervoltage releases (UR) ¹⁾		Article No.
With integrated auxiliary switch	230 V AC	5ST3040
	110 V DC	5ST3041
	24 V DC	5ST3042
Without integrated auxiliary switch	230 V AC	5ST3043
	110 V DC	5ST3044
	24 V DC	5ST3045
Remote control mechanisms (RC mech.)		Article No.
Power	12 ... 30 V AC, 12 ... 48 V DC	5ST3055
	177 ... 270 V AC	5ST3056
Power with ARD	12 ... 30 V AC, 12 ... 48 V DC	5ST3057
	177 ... 270 V AC	5ST3058
Power with extended function	12 ... 30 V AC, 12 ... 48 V DC	5ST3070
	170 ... 277 V AC, 77 ... 286 V DC	5ST3071
Adapters for remote control mechanisms (RC mech.)		Article No.
2 MW		5ST3820-6

5SV RCCBs

Type F, 1P+N

	Super resistant [K]	Selective [S]	SIGRES, super resistant [K], 6 mA DC
Rated voltage U_n	230 V AC	230 V AC	230 V AC
N connection	Right	Right	Right
			
$I_{\Delta n}$	I_n		
Type F			
30 mA	25 A	5SV3312-3	–
	40 A	5SV3314-3	–
	63 A	5SV3316-3	–
	80 A	5SV3317-3	–
300 mA	25 A	5SV3612-3	–
	40 A	5SV3614-3	5SV3614-7
	63 A	5SV3616-3	–
	80 A	5SV3617-3	5SV3617-7

Mounting concept



AS	Auxiliary switch	See page 4/60
FC	Fault signal contact	See page 4/62
AS + FC	Auxiliary switch and fault signal contact	See page 4/63
ST	Shunt trips	See page 4/66
UR	Undervoltage release	See page 4/67
RC mech.	Remote control mechanism	See page 4/68

t201_20467

Accessories

Auxiliary switches (AS)		Article No.
1 NO + 1 NC	Standard	5ST3010
	For low power	5ST3013
	For low power (with diode)	5ST3013-0XX01
2 NO	Standard	5ST3011
	For low power	5ST3014
2 NC	Standard	5ST3012
	For low power	5ST3015
1 CO	Standard	5ST3016
Fault signal contacts (FC)		Article No.
1 NO + 1 NC		5ST3020
2 NO		5ST3021
2 NC		5ST3022
Auxiliary switches and fault signal contacts (AS + FC)		Article No.
1 CO (AS) + 1 CO (FC)		5ST3062
5ST3 COM (AS + FC)		5ST3062-OMC


¹⁾ Combination of undervoltage release with 5SV RCCB not suitable for implementation of EMERGENCY-OFF/EMERGENCY-STOP circuits

Shunt trips (ST)		Article No.
110 ... 415 V AC, 110 ... 220 V DC		5ST3030
24 ... 48 V AC/DC		5ST3031
12 V DC		5ST3031-0XX01
Undervoltage releases (UR) ¹⁾		Article No.
With integrated auxiliary switch	230 V AC	5ST3040
	110 V DC	5ST3041
	24 V DC	5ST3042
Without integrated auxiliary switch	230 V AC	5ST3043
	110 V DC	5ST3044
	24 V DC	5ST3045
Remote control mechanisms (RC mech.)		Article No.
Power	12 ... 30 V AC, 12 ... 48 V DC	5ST3055
	177 ... 270 V AC	5ST3056
Power with ARD	12 ... 30 V AC, 12 ... 48 V DC	5ST3057
	177 ... 270 V AC	5ST3058
Power with extended function	12 ... 30 V AC, 12 ... 48 V DC	5ST3070
	170 ... 277 V AC, 77 ... 286 V DC	5ST3071
Adapters for remote control mechanisms (RC mech.)		Article No.
2 MW		5ST3820-6

5SV RCCBs

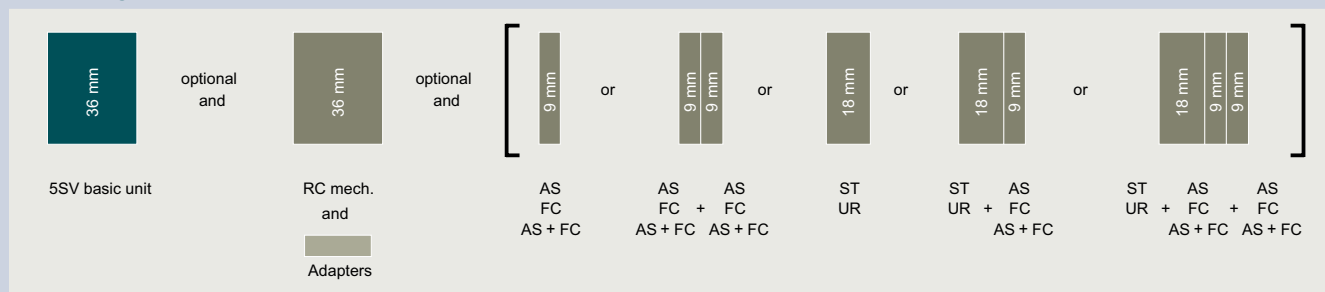
Type AC, 1P+N (2 MW)

Rated voltage U_n N connection	Instantaneous		
	230 V AC	Right	Left



$I_{\Delta n}$	I_n	Bulk packaging (36 units)			
Type AC					
10 mA	16 A	–	5SV4111-0	5SV4111-0KL	–
	25 A	–	5SV4112-0	–	–
30 mA	16 A	–	5SV4311-0	5SV4311-0KL	5SV4311-0KK13
	25 A	–	5SV4312-0	5SV4312-0KL	5SV4312-0KK13
		■	5SV4312-0GV01	–	–
	40 A	–	5SV4314-0	5SV4314-0KL	5SV4314-0KK13
		■	5SV4314-0GV01	5SV4314-0GV02	–
	63 A	–	5SV4316-0	5SV4316-0KL	5SV4316-0KK13
100 mA	80 A	–	5SV4317-0	5SV4317-0KL	–
	25 A	–	5SV4412-0	–	–
	40 A	–	5SV4414-0	5SV4414-0KL	–
	63 A	–	5SV4416-0	5SV4416-0KL	–
300 mA	80 A	–	5SV4417-0	–	–
	25 A	–	5SV4612-0	5SV4612-0KL	–
	40 A	–	5SV4614-0	5SV4614-0KL	–
	63 A	–	5SV4616-0	5SV4616-0KL	–
	80 A	–	5SV4617-0	5SV4617-0KL	–

Mounting concept



AS	Auxiliary switch	See page 4/58
FC	Fault signal contact	See page 4/62
AS + FC	Auxiliary switch and fault signal contact	See page 4/63
ST	Shunt trips	See page 4/66
UR	Undervoltage release	See page 4/67
RC mech.	Remote control mechanism	See page 4/68

1201_204/67

Accessories

Auxiliary switches (AS)		Article No.
1 NO + 1 NC	Standard	5ST3010
	For low power	5ST3013
	For low power (with diode)	5ST3013-0XX01
2 NO	Standard	5ST3011
	For low power	5ST3014
2 NC	Standard	5ST3012
	For low power	5ST3015
1 CO	Standard	5ST3016
Fault signal contacts (FC)		Article No.
1 NO + 1 NC		5ST3020
2 NO		5ST3021
2 NC		5ST3022
Auxiliary switches and fault signal contacts (AS + FC)		Article No.
1 CO (AS) + 1 CO (FC)		5ST3062
5ST3 COM (AS + FC)		5ST3062-0MC

¹⁾ Combination of undervoltage release with 5SV RCCB not suitable for implementation of EMERGENCY-OFF/EMERGENCY-STOP circuits

Shunt trips (ST)		Article No.
110 ... 415 V AC, 110 ... 220 V DC		5ST3030
24 ... 48 V AC/DC		5ST3031
12 V DC		5ST3031-0XX01
Undervoltage releases (UR) ¹⁾		Article No.
With integrated auxiliary switch	230 V AC	5ST3040
	110 V DC	5ST3041
	24 V DC	5ST3042
Without integrated auxiliary switch	230 V AC	5ST3043
	110 V DC	5ST3044
	24 V DC	5ST3045
Remote control mechanisms (RC mech.)		Article No.
Power	12 ... 30 V AC, 12 ... 48 V DC	5ST3055
	177 ... 270 V AC	5ST3056
Power with ARD	12 ... 30 V AC, 12 ... 48 V DC	5ST3057
	177 ... 270 V AC	5ST3058
Power with extended function	12 ... 30 V AC, 12 ... 48 V DC	5ST3070
	170 ... 277 V AC, 77 ... 286 V DC	5ST3071
Adapters for remote control mechanisms (RC mech.)		Article No.
2 MW		5ST3820-6

5SV RCCBs

Type A, 3P+N (4 MW)

Instantaneous

Rated voltage U_n
N connection

400 V AC

Right



Left



400 V AC/400 Hz

Right



500 V AC

Right

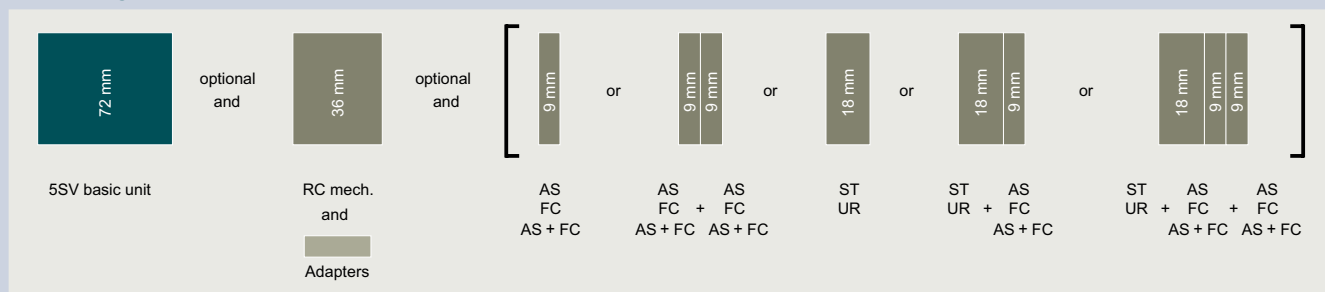


$I_{\Delta n}$	I_n	Thermal overload protection ¹⁾	Bulk packaging (18 units)				
Type A							
30 mA	25 A	–	–	5SV3342-6	5SV3342-6KL	5SV3342-6KK03	5SV3352-6
		–	■	5SV3342-6GV01	–	–	–
	40 A	–	–	5SV3344-6	5SV3344-6KL	5SV3344-6KK03	5SV3354-6
		–	■	5SV3344-6GV01	5SV3344-6GV02	–	–
	63 A	–	–	5SV3344-6LA	–	–	–
		–	■	5SV3346-6	5SV3346-6KL	–	5SV3356-6
100 mA	25 A	–	–	5SV3347-6	5SV3347-6KL	–	5SV3357-6
		–	■	5SV3347-6LA	–	–	–
	40 A	–	–	5SV3442-6	–	–	–
		–	■	5SV3444-6	–	–	–
	63 A	–	–	5SV3444-6LA	–	–	–
		–	■	5SV3446-6	–	–	–
300 mA	25 A	–	–	5SV3446-6LA	–	–	–
		–	■	5SV3642-6	5SV3642-6KL	–	5SV3652-6
	40 A	–	–	5SV3644-6	5SV3644-6KL	–	5SV3654-6
		–	■	–	–	–	–
	63 A	–	–	5SV3646-6	5SV3646-6KL	–	5SV3656-6
		–	■	–	–	–	–
500 mA	25 A	–	–	5SV3647-6	5SV3647-6KL	–	5SV3657-6
		–	■	5SV3742-6	–	–	–
	40 A	–	–	5SV3744-6	–	–	–
		–	■	5SV3746-6	5SV3746-6KL	–	–
	63 A	–	–	5SV3746-6	5SV3746-6KL	–	–
		–	■	5SV3746-6GV01	–	–	–
1000 mA	63 A	–	–	5SV3747-6	–	–	–
		–	■	–	–	–	–

¹⁾ Thermal overload protection according to OVE E 8101 possible up to rated current of the RCCB (40 A, 63 A).

²⁾ These products cannot be used in France according to NF C 15-100. Product complies with the specifications of the Belgian market only. (Simultaneous tripping of the 3 poles and the N conductor.) Available for the export market only.

Mounting concept











AS Auxiliary switch
FC Fault signal contact
AS + FC Auxiliary switch and fault signal contact

See page 4/60
See page 4/62
See page 4/63

ST Shunt trips
UR Undervoltage release
RC mech. Remote control mechanism

See page 4/66
See page 4/67
See page 4/68

Instantaneous (only available in Belgium) ²⁾	SIGRES, instantaneous	Short-time delayed [G]	Super resistant [K]	Selective [S]		SIGRES, selective [S]	SIGRES, super resistant [K], 6 mA DC
400 V AC	400 V AC	400 V AC	400 V AC	400 V AC		400 V AC	230 V AC
Right	Right	Right	Right	Right	Left	Right	Rechts
							
5SV3342-6BA	5SV3342-6KK12	–	5SV3342-6KK01	–	–	–	5SV3342-6KK60
–	–	–	–	–	–	–	–
5SV3344-6BA	5SV3344-6KK12	5SV3344-6LB01	5SV3344-6KK01	–	–	–	5SV3344-6KK60
–	–	–	–	–	–	–	–
–	–	5SV3344-6LA01	–	–	–	–	–
5SV3346-6BA	5SV3346-6KK12	5SV3346-6LB01	5SV3346-6KK01	–	–	–	5SV3346-6KK60
–	–	–	–	–	–	–	–
–	–	5SV3346-6LA01	–	–	–	–	–
–	5SV3347-6KK12	5SV3347-6LB01	5SV3347-6KK01	–	–	–	–
–	–	–	–	–	–	–	–
–	–	5SV3444-6LB01	–	5SV3444-8	–	–	–
–	–	5SV3444-6LA01	–	5SV3444-8LA	–	–	–
–	–	5SV3446-6LB01	–	5SV3446-8	–	–	–
–	–	5SV3446-6LA01	–	5SV3446-8LA	–	–	–
–	–	–	–	–	–	–	–
5SV3642-6BA	5SV3642-6KK12	–	5SV3642-6KK01	5SV3642-8	–	–	–
5SV3644-6BA	5SV3644-6KK12	–	5SV3644-6KK01	5SV3644-8	–	–	–
–	–	–	–	5SV3644-8LA	–	–	–
5SV3646-6BA	5SV3646-6KK12	–	5SV3646-6KK01	5SV3646-8	5SV3646-8KL	5SV3646-8KK12	–
–	–	–	–	5SV3646-8LA	–	–	–
–	5SV3647-6KK12	–	5SV3647-6KK01	5SV3647-8	–	–	–
–	–	–	–	–	–	–	–
–	–	–	–	–	–	–	–
–	–	–	–	–	–	–	–
–	–	–	–	–	–	–	–
–	–	–	–	–	–	–	–
–	–	–	–	5SV3846-8	–	–	–

Accessories




Auxiliary switches (AS)		Article No.
1 NO + 1 NC	Standard	5ST3010
	For low power	5ST3013
	For low power (with diode)	5ST3013-0XX01
2 NO	Standard	5ST3011
	For low power	5ST3014
2 NC	Standard	5ST3012
	For low power	5ST3015
1 CO	Standard	5ST3016
Fault signal contacts (FC)		Article No.
1 NO + 1 NC		5ST3020
2 NO		5ST3021
2 NC		5ST3022
Auxiliary switches and fault signal contacts (AS + FC)		Article No.
1 CO (AS) + 1 CO (FC)		5ST3062
5ST3 COM (AS + FC)		5ST3062-0MC

¹⁾ Combination of undervoltage release with 5SV RCCB not suitable for implementation of EMERGENCY-OFF/EMERGENCY-STOP circuits

Shunt trips (ST)		Article No.
110 ... 415 V AC, 110 ... 220 V DC		5ST3030
24 ... 48 V AC/DC		5ST3031
12 V DC		5ST3031-0XX01
Undervoltage releases (UR) ¹⁾		Article No.
With integrated auxiliary switch	230 V AC	5ST3040
	110 V DC	5ST3041
	24 V DC	5ST3042
Without integrated auxiliary switch	230 V AC	5ST3043
	110 V DC	5ST3044
	24 V DC	5ST3045
Remote control mechanisms (RC mech.)		Article No.
Power	12 ... 30 V AC, 12 ... 48 V DC	5ST3055
	177 ... 270 V AC	5ST3056
Power with ARD	12 ... 30 V AC, 12 ... 48 V DC	5ST3057
	177 ... 270 V AC	5ST3058
Power with extended function	12 ... 30 V AC, 12 ... 48 V DC	5ST3070
	170 ... 277 V AC, 77 ... 286 V DC	5ST3071
Adapters for remote control mechanisms (RC mech.)		Article No.
4 MW		5ST3820-7

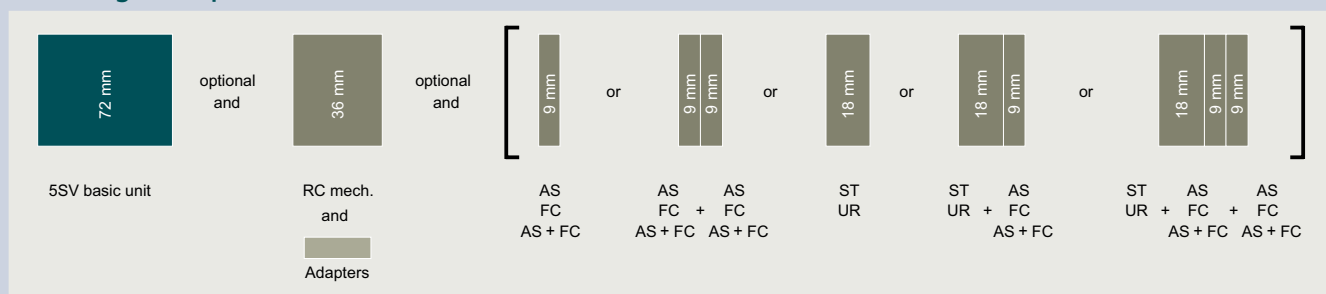
5SV RCCBs

Type F, 3P+N (4 MW)

	Super resistant [K]	Selective [S]	SIGRES, super resistant [K], 6 mA DC
Rated voltage U_n	400 V AC	400 V AC	230 V AC
N connection	Right	Right	Right
			

$I_{\Delta n}$	I_n			
Type F				
30 mA	25 A	5SV3342-3	–	5SV3342-3KK60
	40 A	5SV3344-3	–	5SV3344-3KK60
	63 A	5SV3346-3	–	5SV3346-3KK60
	80 A	5SV3347-3	–	–
300 mA	25 A	5SV3642-3	–	–
	40 A	5SV3644-3	5SV3644-7	–
	63 A	5SV3646-3	–	–
	80 A	5SV3647-3	5SV3647-7	–

Mounting concept



AS	Auxiliary switch	See page 4/60
FC	Fault signal contact	See page 4/62
AS + FC	Auxiliary switch and fault signal contact	See page 4/63
ST	Shunt trips	See page 4/66
UR	Undervoltage release	See page 4/67
RC mech.	Remote control mechanism	See page 4/68

Accessories



Auxiliary switches (AS)		Article No.
1 NO + 1 NC	Standard	5ST3010
	For low power	5ST3013
	For low power (with diode)	5ST3013-0XX01
2 NO	Standard	5ST3011
	For low power	5ST3014
2 NC	Standard	5ST3012
	For low power	5ST3015
1 CO	Standard	5ST3016
Fault signal contacts (FC)		Article No.
1 NO + 1 NC		5ST3020
2 NO		5ST3021
2 NC		5ST3022
Auxiliary switches and fault signal contacts (AS + FC)		Article No.
1 CO (AS) + 1 CO (FC)		5ST3062
5ST3 COM (AS + FC)		5ST3062-0MC

¹⁾ Combination of undervoltage release with 55V RCCB not suitable for implementation of EMERGENCY-OFF/EMERGENCY-STOP circuits

Shunt trips (ST)		Article No.
110 ... 415 V AC, 110 ... 220 V DC		5ST3030
24 ... 48 V AC/DC		5ST3031
12 V DC		5ST3031-0XX01
Undervoltage releases (UR) ¹⁾		Article No.
With integrated auxiliary switch	230 V AC	5ST3040
	110 V DC	5ST3041
	24 V DC	5ST3042
Without integrated auxiliary switch	230 V AC	5ST3043
	110 V DC	5ST3044
	24 V DC	5ST3045
Remote control mechanisms (RC mech.)		Article No.
Power	12 ... 30 V AC, 12 ... 48 V DC	5ST3055
	177 ... 270 V AC	5ST3056
Power with ARD	12 ... 30 V AC, 12 ... 48 V DC	5ST3057
	177 ... 270 V AC	5ST3058
Power with extended function	12 ... 30 V AC, 12 ... 48 V DC	5ST3070
	170 ... 277 V AC, 77 ... 286 V DC	5ST3071
Adapters for remote control mechanisms (RC mech.)		Article No.
4 MW		5ST3820-7

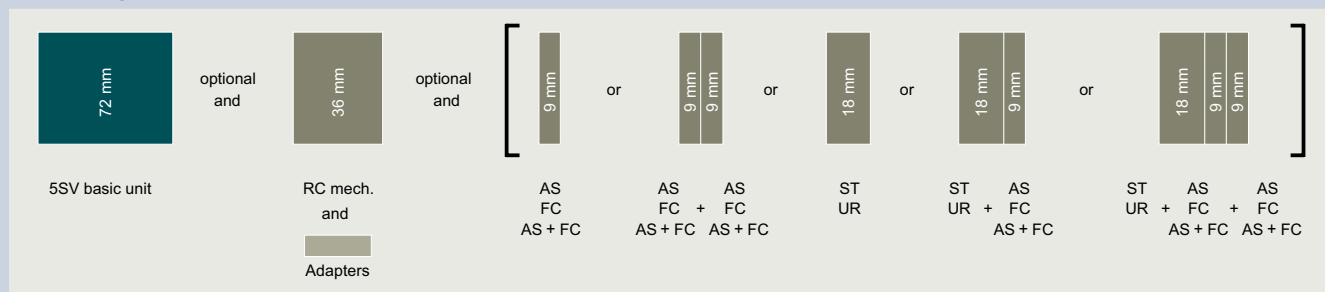
5SV RCCBs

Type AC, 3P+N (4 MW)

Rated voltage U_n N connection	Instantaneous	
	Right	Left
400 V AC		

$I_{\Delta n}$	I_n	Bulk packaging (18 units)		
Type AC				
30 mA	25 A	–	5SV4342-0	5SV4342-0KL
		■	5SV4342-0GV01	–
	40 A	–	5SV4344-0	5SV4344-0KL
		■	5SV4344-0GV01	–
		–	5SV4346-0	5SV4346-0KL
100 mA	80 A	–	5SV4347-0	5SV4347-0KL
	25 A	–	5SV4442-0	–
		–	5SV4444-0	–
		–	5SV4446-0	–
–		5SV4447-0	–	
300 mA	40 A	–	5SV4642-0	5SV4642-0KL
	–	–	5SV4644-0	5SV4644-0KL
	–	–	5SV4646-0	5SV4646-0KL
	–	–	5SV4647-0	5SV4647-0KL
500 mA	25 A	–	5SV4742-0	–
	–	–	5SV4744-0	–
	–	–	5SV4746-0	–
	–	–	5SV4747-0	–

Mounting concept



AS	Auxiliary switch	See page 4/60
FC	Fault signal contact	See page 4/62
AS + FC	Auxiliary switch and fault signal contact	See page 4/63
ST	Shunt trips	See page 4/66
UR	Undervoltage release	See page 4/67
RC mech.	Remote control mechanism	See page 4/68

Accessories

Auxiliary switches (AS)		Article No.
1 NO + 1 NC	Standard	5ST3010
	For low power	5ST3013
	For low power (with diode)	5ST3013-0XX01
2 NO	Standard	5ST3011
	For low power	5ST3014
2 NC	Standard	5ST3012
	For low power	5ST3015
1 CO	Standard	5ST3016
Fault signal contacts (FC)		Article No.
1 NO + 1 NC		5ST3020
2 NO		5ST3021
2 NC		5ST3022
Auxiliary switches and fault signal contacts (AS + FC)		Article No.
1 CO (AS) + 1 CO (FC)		5ST3062
5ST3 COM (AS + FC)		5ST3062-0MC

¹⁾ Combination of undervoltage release with 55V RCCB not suitable for implementation of EMERGENCY-OFF/EMERGENCY-STOP circuits

Shunt trips (ST)		Article No.
110 ... 415 V AC, 110 ... 220 V DC		5ST3030
24 ... 48 V AC/DC		5ST3031
12 V DC		5ST3031-0XX01
Undervoltage releases (UR) ¹⁾		Article No.
With integrated auxiliary switch	230 V AC	5ST3040
	110 V DC	5ST3041
	24 V DC	5ST3042
Without integrated auxiliary switch	230 V AC	5ST3043
	110 V DC	5ST3044
	24 V DC	5ST3045
Remote control mechanisms (RC mech.)		Article No.
Power	12 ... 30 V AC, 12 ... 48 V DC	5ST3055
	177 ... 270 V AC	5ST3056
Power with ARD	12 ... 30 V AC, 12 ... 48 V DC	5ST3057
	177 ... 270 V AC	5ST3058
Power with extended function	12 ... 30 V AC, 12 ... 48 V DC	5ST3070
	170 ... 277 V AC, 77 ... 286 V DC	5ST3071
Adapters for remote control mechanisms (RC mech.)		Article No.
4 MW		5ST3820-7

5SV RCCBs



Type A and AC, 3P+N (4 MW), high-current **new**

	Instantaneous	Selective [S]	Short-time delayed [K]
Rated voltage U_n	400 V AC	400 V AC	400 V AC
N connection	Right	Right	Right
			

$I_{\Delta n}$	I_n			
Type A				
30 mA	100 A	5SV3348-6	–	–
	125 A	5SV3345-6	–	5SV3345-6KK01
100 mA	100 A	5SV3448-6	–	–
	125 A	5SV3445-6	–	5SV3445-6KK01
300 mA	100 A	5SV3648-6	–	–
	125 A	5SV3645-6	5SV3645-8	5SV3645-6KK01
500 mA	100 A	5SV3748-6	–	–
	125 A	5SV3745-6	5SV3745-8	5SV3745-6KK01
Type AC				
30 mA	100 A	5SV4348-0	–	–
	125 A	5SV4345-0	–	–
100 mA	100 A	5SV4448-0	–	–
	125 A	5SV4445-0	–	–
300 mA	100 A	5SV4648-0	–	–
	125 A	5SV4645-0	–	–
500 mA	100 A	5SV4748-0	–	–
	125 A	5SV4745-0	–	–

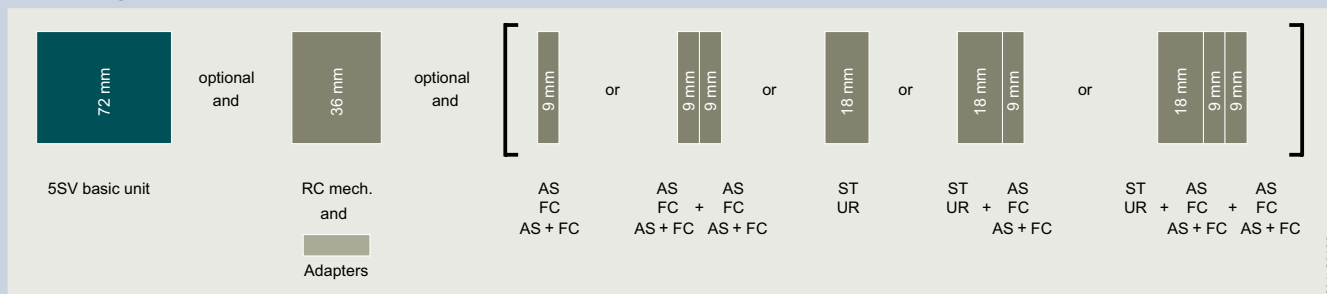
5SV3 RCCBs (SIQUENCE)

Type B, 1P+N (4 MW)

	SIGRES, super resistant [K]	SIGRES, super resistant [K], 6 mA DC
Rated voltage U_n	230 V AC	230 V AC
N connection	Right	Right
		

$I_{\Delta n}$	I_n	Bulk packaging (18 units)			
Type B					
30 mA	16 A	–	5SV3321-4	–	
	25 A	–	5SV3322-4	5SV3322-4KK60	
	40 A	–	–	5SV3324-4	5SV3324-4KK60
		■	–	5SV3324-4GV01	–
	63 A	–	–	5SV3326-4	5SV3326-4KK60
	80 A	–	–	–	5SV3327-4KK60
300 mA	16 A	–	5SV3621-4	–	
	25 A	–	5SV3622-4	–	
	40 A	–	5SV3624-4	–	
	63 A	–	5SV3626-4	–	

Mounting concept



AS	Auxiliary switch	See page 4/60
FC	Fault signal contact	See page 4/62
AS + FC	Auxiliary switch and fault signal contact	See page 4/63
ST	Shunt trips	See page 4/66
UR	Undervoltage release	See page 4/67
RC mech.	Remote control mechanism	See page 4/68

Accessories




Auxiliary switches (AS)		Article No.
1 NO + 1 NC	Standard	5ST3010
	For low power	5ST3013
	For low power (with diode)	5ST3013-OXX01
2 NO	Standard	5ST3011
	For low power	5ST3014
2 NC	Standard	5ST3012
	For low power	5ST3015
1 CO	Standard	5ST3016
Fault signal contacts (FC)		Article No.
1 NO + 1 NC		5ST3020
2 NO		5ST3021
2 NC		5ST3022
Auxiliary switches and fault signal contacts (AS + FC)		Article No.
1 CO (AS) + 1 CO (FC)		5ST3062
5ST3 COM (AS + FC)		5ST3062-0MC

¹⁾ Combination of undervoltage release with 55V RCCB not suitable for implementation of EMERGENCY-OFF/EMERGENCY-STOP circuits

Shunt trips (ST)		Article No.
110 ... 415 V AC, 110 ... 220 V DC		5ST3030
24 ... 48 V AC/DC		5ST3031
12 V DC		5ST3031-OXX01
Undervoltage releases (UR) ¹⁾		Article No.
With integrated auxiliary switch	230 V AC	5ST3040
	110 V DC	5ST3041
	24 V DC	5ST3042
Without integrated auxiliary switch	230 V AC	5ST3043
	110 V DC	5ST3044
	24 V DC	5ST3045
Remote control mechanisms (RC mech.)		Article No.
Power	12 ... 30 V AC, 12 ... 48 V DC	5ST3055
	177 ... 270 V AC	5ST3056
Power with ARD	12 ... 30 V AC, 12 ... 48 V DC	5ST3057
	177 ... 270 V AC	5ST3058
Power with extended function	12 ... 30 V AC, 12 ... 48 V DC	5ST3070
	170 ... 277 V AC, 77 ... 286 V DC	5ST3071
Adapters for remote control mechanisms (RC mech.)		Article No.
4 MW		5ST3820-7

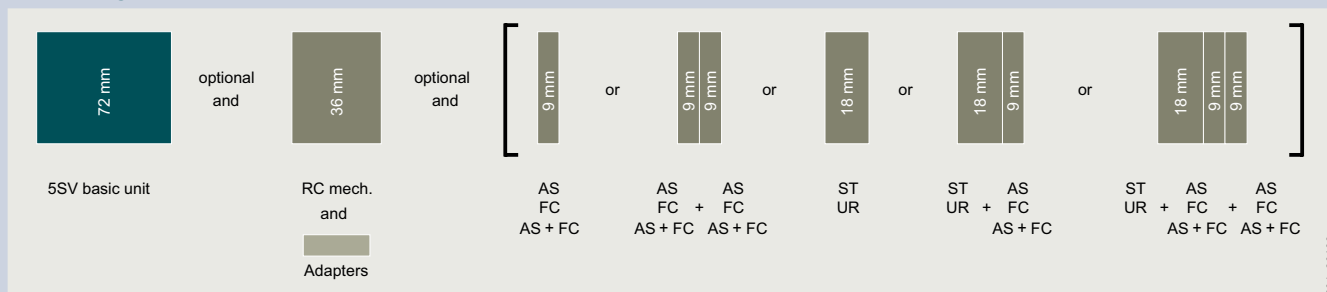
5SV3 RCCBs (SIQUENCE)

Type B and B+, 3P+N (4 MW)

	SIGRES, super resistant [K]	SIGRES, super resistant [K], 6 mA DC	SIGRES, selective [S]
Rated voltage U_n	AC 230 ... 400 V	AC 230 ... 400 V	AC 230 ... 400 V
N connection	Right	Right	Right
			

$I_{\Delta n}$	I_n	Bulk packaging (18 units)			
Type B					
30 mA	25 A	–	5SV3342-4	5SV3342-4KK60	–
		■	5SV3342-4GV01	–	–
	40 A	–	5SV3344-4	5SV3344-4KK60	–
		■	5SV3344-4GV01	–	–
	63 A	–	5SV3346-4	5SV3346-4KK60	–
300 mA	25 A	–	5SV3347-4	5SV3347-4KK60	–
		■	5SV3642-4	–	–
		■	5SV3642-4GV01	–	–
500 mA	40 A	–	5SV3644-4	–	–
		■	5SV3644-4GV01	–	–
	63 A	–	5SV3646-4	–	5SV3646-5
		■	5SV3646-4GV01	–	–
	80 A	–	5SV3647-4	–	5SV3647-5
Type B+					
30 mA	25 A	–	5SV3342-4KK14	–	–
	40 A	–	5SV3344-4KK14	–	–
	63 A	–	5SV3346-4KK14	–	–
	80 A	–	5SV3347-4KK14	–	–
300 mA	25 A	–	5SV3642-4KK14	–	–
	40 A	–	5SV3644-4KK14	–	–
	63 A	–	5SV3646-4KK14	–	5SV3646-5KK14
	80 A	–	5SV3647-4KK14	–	5SV3647-5KK14

Mounting concept



AS	Auxiliary switch	See page 4/60
FC	Fault signal contact	See page 4/62
AS + FC	Auxiliary switch and fault signal contact	See page 4/63
ST	Shunt trips	See page 4/66
UR	Undervoltage release	See page 4/67
RC mech.	Remote control mechanism	See page 4/68

1201_20468

Accessories

Auxiliary switches (AS)		Article No.
1 NO + 1 NC	Standard	5ST3010
	For low power	5ST3013
	For low power (with diode)	5ST3013-0XX01
2 NO	Standard	5ST3011
	For low power	5ST3014
2 NC	Standard	5ST3012
	For low power	5ST3015
1 CO	Standard	5ST3016
Fault signal contacts (FC)		Article No.
1 NO + 1 NC		5ST3020
2 NO		5ST3021
2 NC		5ST3022
Auxiliary switches and fault signal contacts (AS + FC)		Article No.
1 CO (AS) + 1 CO (FC)		5ST3062
5ST3 COM (AS + FC)		5ST3062-0MC


¹⁾ Combination of undervoltage release with 5SV RCCB not suitable for implementation of EMERGENCY-OFF/EMERGENCY-STOP circuits

Shunt trips (ST)		Article No.
110 ... 415 V AC, 110 ... 220 V DC		5ST3030
24 ... 48 V AC/DC		5ST3031
12 V DC		5ST3031-0XX01
Undervoltage releases (UR) ¹⁾		Article No.
With integrated auxiliary switch	230 V AC	5ST3040
	110 V DC	5ST3041
	24 V DC	5ST3042
Without integrated auxiliary switch	230 V AC	5ST3043
	110 V DC	5ST3044
	24 V DC	5ST3045
Remote control mechanisms (RC mech.)		Article No.
Power	12 ... 30 V AC, 12 ... 48 V DC	5ST3055
	177 ... 270 V AC	5ST3056
Power with ARD	12 ... 30 V AC, 12 ... 48 V DC	5ST3057
	177 ... 270 V AC	5ST3058
Power with extended function	12 ... 30 V AC, 12 ... 48 V DC	5ST3070
	170 ... 277 V AC, 77 ... 286 V DC	5ST3071
Adapters for remote control mechanisms (RC mech.)		Article No.
4 MW		5ST3820-7

5SM3 RCCBs

Type A and AC, 1P+N (2 MW), high-current

	Instantaneous
Rated voltage U_n	230 V AC
N connection	Right



$I_{\Delta n}$	I_n	
Type A		
30 mA	100 A	5SM3318-6KK
	125 A	5SM3315-6KK
100 mA	100 A	5SM3418-6KK
	125 A	5SM3415-6KK
300 mA	100 A	5SM3618-6KK
	125 A	5SM3615-6KK
Type AC		
30 mA	100 A	5SM3318-0KK
	125 A	5SM3315-0KK
100 mA	100 A	5SM3418-0KK
	125 A	5SM3415-0KK
300 mA	100 A	5SM3618-0KK
	125 A	5SM3615-0KK

5SM2 RC units

Type A, F and AC, 2-pole

For 5SY miniature circuit breakers ¹⁾

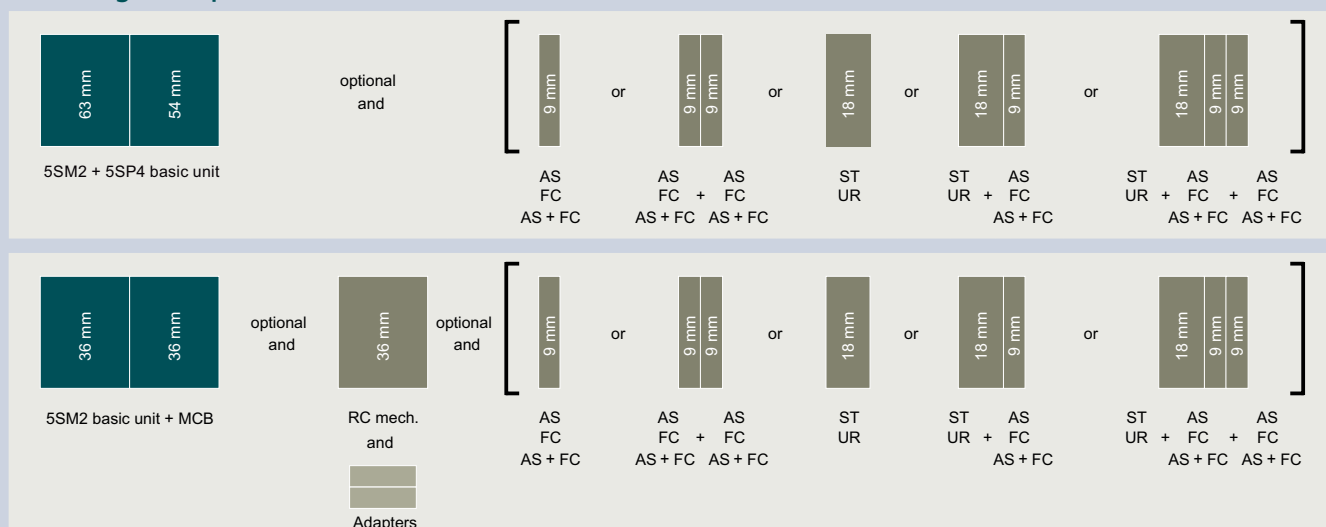
Rated voltage U_n	230 V AC		
Version	Instantaneous	Super resistant [K]	Selective [S]
Mounting width	2 MW	2 MW	2 MW



$I_{\Delta n}$	I_n			
Type A				
10 mA	0.3 ... 16 A	5SM2121-6	–	–
30 mA	0.3 ... 40 A	5SM2322-6	5SM2322-6KK01	–
	0.3 ... 63 A	5SM2325-6	5SM2325-6KK01	–
100 mA	80 ... 100 A	–	–	–
	0.3 ... 63 A	5SM2425-6	–	–
300 mA	0.3 ... 40 A	5SM2622-6	–	5SM2622-8
	0.3 ... 63 A	5SM2625-6	–	5SM2625-8
	80 ... 100 A	–	–	–
500 mA	0.3 ... 63 A	5SM2725-6	–	–
1000 mA	0.3 ... 40 A	–	–	5SM2822-8
	0.3 ... 63 A	–	–	5SM2825-8
	80 ... 100 A	–	–	–
Type F				
30 mA	0.3 ... 40 A	–	5SM2322-3	–
	0.3 ... 63 A	–	5SM2325-3	–
Type AC				
10 mA	0.3 ... 40 A	5SM2121-0	–	–
30 mA	0.3 ... 40 A	5SM2322-0	–	–
	0.3 ... 63 A	5SM2325-0	–	–
	80 ... 100 A	–	–	–
300 mA	0.3 ... 40 A	5SM2622-0	–	5SM2622-2
	0.3 ... 63 A	5SM2625-0	–	5SM2625-2
	80 ... 100 A	–	–	–
500 mA	0.3 ... 63 A	5SM2725-0	–	–
1000 mA	0.3 ... 63 A	5SM2825-0	–	–

¹⁾ Not suitable for use with 5SY5 and type A + type F not suitable for use with 5SY8

Mounting concept



MCB Miniature circuit breaker [See page 3/1](#)

AS Auxiliary switch [See page 4/60](#)

FC Fault signal contact [See page 4/62](#)





AS + FC Auxiliary switch and

fault signal contact [See page 4/63](#)

ST Shunt trips [See page 4/66](#)

UR Undervoltage release [See page 4/67](#)

RC mech. Remote control mechanism [See page 4/68](#)

For 5SL4 miniature circuit breakers		For 5SP4 miniature circuit breakers (B and C characteristics)	
230 V AC		230 V AC	
Instantaneous	Selective [S]	Instantaneous	Selective [S]
2 MW	2 MW	3.5 MW	3.5 MW
			
-	-	-	-
5SM2323-6	-	-	-
5SM2326-6	-	-	-
-	-	5SM2327-6	-
-	-	-	-
5SM2623-6	5SM2623-8	-	-
5SM2626-6	5SM2626-8	-	-
-	-	5SM2627-6	5SM2627-8
-	-	-	-
-	-	-	-
-	-	-	-
-	-	-	5SM2827-8
-	-	-	-
-	-	-	-
-	-	-	-
5SM2323-0	-	-	-
5SM2326-0	-	-	-
-	-	-	-
5SM2623-0	5SM2623-2	5SM2327-0	-
5SM2626-0	5SM2626-2	5SM2627-0	-
-	-	-	-
-	-	-	-
-	-	-	-

Accessories

Auxiliary switches (AS)		Article No.	Undervoltage releases (UR)		Article No.
1 NO + 1 NC	Standard	5ST3010	With integrated auxiliary switch	230 V AC	5ST3040
	For low power	5ST3013		110 V DC	5ST3041
	For low power (with diode)	5ST3013-0XX01		24 V DC	5ST3042
2 NO	Standard	5ST3011	Without integrated auxiliary switch	230 V AC	5ST3043
	For low power	5ST3014		110 V DC	5ST3044
2 NC	Standard	5ST3012		24 V DC	5ST3045
	For low power	5ST3015	Remote control mechanisms (RC mech.)		Article No.
1 CO	Standard	5ST3016	Power	12 ... 30 V AC, 12 ... 48 V DC	5ST3055
Fault signal contacts (FC)				177 ... 270 V AC	5ST3056
1 NO + 1 NC		5ST3020	Power with ARD	12 ... 30 V AC, 12 ... 48 V DC	5ST3057
2 NO		5ST3021		177 ... 270 V AC	5ST3058
2 NC		5ST3022	Power with extended function	12 ... 30 V AC, 12 ... 48 V DC	5ST3070
Auxiliary switches and fault signal contacts (AS + FC)			Adapters for remote control mechanisms (RC mech.)		
1 CO (AS) + 1 CO (FC)		5ST3062	5SM2 with 5SY (2P)		5ST3820-3 + 5ST3820-1
5ST3 COM (AS + FC)		5ST3062-0MC	5SM2 with 5SL (2P)		5ST3820-3 + 5ST3820-6
Shunt trips (ST)					
110 ... 415 V AC, 110 ... 220 V DC		5ST3030			
24 ... 48 V AC/DC		5ST3031			
12 V DC		5ST3031-0XX01			

5SM2 RC units

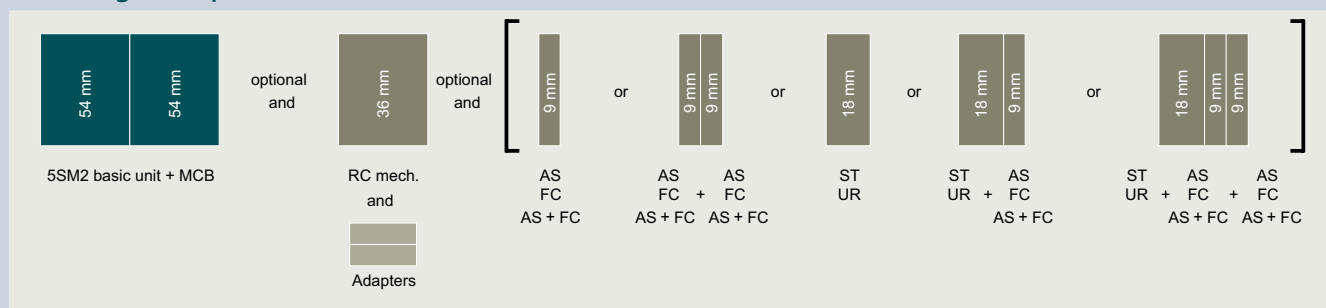
Type A and AC, 3-pole

Rated voltage U_n Version Mounting width	For 5SY miniature circuit breakers ¹⁾			For 5SL4 miniature circuit breakers	
	Instantaneous	Super resistant [K]	Selective [S]	Instantaneous	Selective [S]
400 V AC	3 MW	3 MW	3 MW	3 MW	3 MW

$I_{\Delta n}$	I_n	For 5SY miniature circuit breakers ¹⁾			For 5SL4 miniature circuit breakers	
Type A						
30 mA	0.3 ... 40 A	5SM2332-6	5SM2332-6KK01	–	5SM2333-6	–
	0.3 ... 63 A	5SM2335-6	5SM2335-6KK01	–	5SM2336-6	–
100 mA	0.3 ... 63 A	5SM2435-6	–	–	–	–
	0.3 ... 40 A	5SM2632-6	–	–	5SM2633-6	–
300 mA	0.3 ... 63 A	5SM2635-6	–	5SM2635-8	5SM2636-6	5SM2636-8
	0.3 ... 40 A	5SM2735-6	–	5SM2735-8	–	–
500 mA	0.3 ... 40 A	–	–	5SM2832-8	–	–
	0.3 ... 63 A	–	–	5SM2835-8	–	–
Type AC						
30 mA	0.3 ... 40 A	5SM2332-0	–	–	5SM2333-0	–
	0.3 ... 63 A	5SM2335-0	–	–	5SM2336-0	–
300 mA	0.3 ... 40 A	5SM2632-0	–	–	5SM2633-0	–
	0.3 ... 63 A	5SM2635-0	–	–	5SM2636-0	–
500 mA	0.3 ... 40 A	5SM2735-0	–	–	–	–
	0.3 ... 63 A	–	–	–	–	–

¹⁾ Not suitable for use with 5SY5 and type A not suitable for use with 5SY8

Mounting concept



MCB Miniature circuit breaker
AS Auxiliary switch
FC Fault signal contact
AS + FC Auxiliary switch and fault signal contact

[See page 3/1](#)
[See page 4/60](#)
[See page 4/62](#)
[See page 4/63](#)

ST Shunt trips
UR Undervoltage release
RC mech. Remote control mechanism

[See page 4/66](#)
[See page 4/67](#)
[See page 4/68](#)

1201_20471

Accessories


Auxiliary switches (AS)		Article No.
1 NO + 1 NC	Standard	5ST3010
	For low power	5ST3013
	For low power (with diode)	5ST3013-0XX01
2 NO	Standard	5ST3011
	For low power	5ST3014
2 NC	Standard	5ST3012
	For low power	5ST3015
1 CO	Standard	5ST3016
Fault signal contacts (FC)		Article No.
1 NO + 1 NC		5ST3020
2 NO		5ST3021
2 NC		5ST3022
Auxiliary switches and fault signal contacts (AS + FC)		Article No.
1 CO (AS) + 1 CO (FC)		5ST3062
5ST3 COM (AS + FC)		5ST3062-0MC
Shunt trips (ST)		Article No.
110 ... 415 V AC, 110 ... 220 V DC		5ST3030
24 ... 48 V AC/DC		5ST3031
12 V DC		5ST3031-0XX01

Undervoltage releases (UR)		Article No.
With integrated auxiliary switch	230 V AC	5ST3040
	110 V DC	5ST3041
	24 V DC	5ST3042
Without integrated auxiliary switch	230 V AC	5ST3043
	110 V DC	5ST3044
	24 V DC	5ST3045
Remote control mechanisms (RC mech.)		Article No.
Power	12 ... 30 V AC, 12 ... 48 V DC	5ST3055
	177 ... 270 V AC	5ST3056
Power with ARD	12 ... 30 V AC, 12 ... 48 V DC	5ST3057
	177 ... 270 V AC	5ST3058
Power with extended function	12 ... 30 V AC, 12 ... 48 V DC	5ST3070
Adapters for remote control mechanisms (RC mech.)		Article No.
5SM2 with 5SY (3P)		5ST3820-3 + 5ST3820-2
5SM2 with 5SL (3P)		5ST3820-3 + 5ST3820-7

5SM2 RC units

Type A and AC, 4-pole

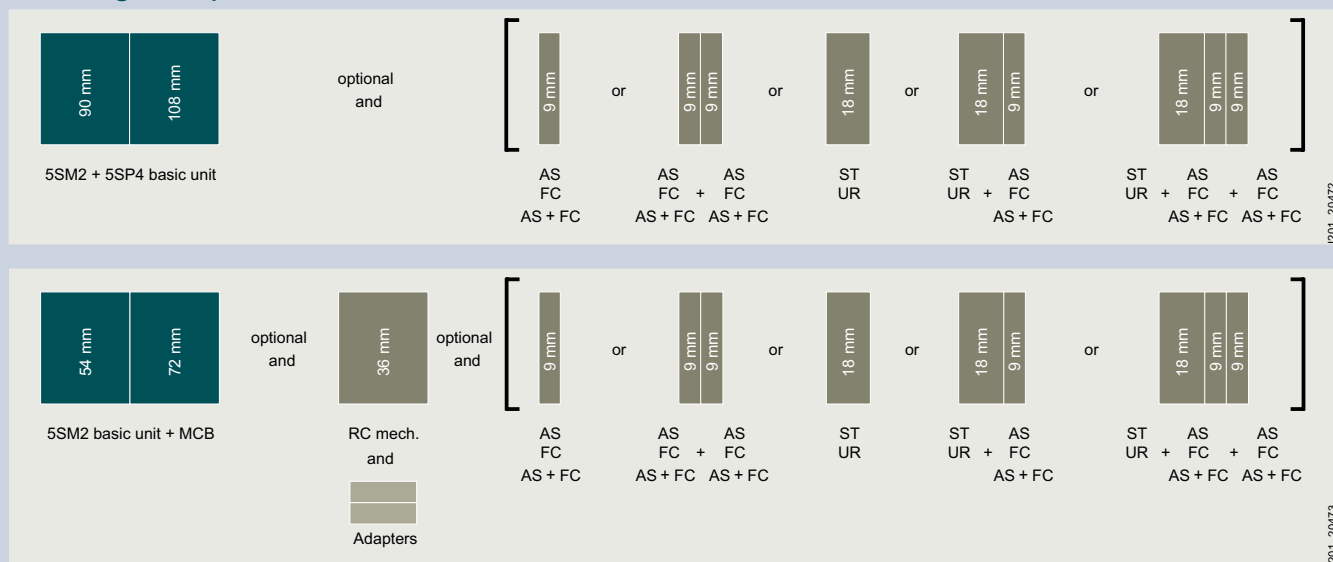
Rated voltage U_n	For 5SY miniature circuit breakers ¹⁾			
	Version	Super resistant [K]	Selective [S]	SIGRES, instantaneous
400 V AC	Instantaneous	3 MW	3 MW	3 MW
Mounting width	3 MW	3 MW	3 MW	3 MW



$I_{\Delta n}$	I_n				
Type A					
30 mA	0.3 ... 40 A	5SM2342-6	5SM2342-6KK01	–	–
	0.3 ... 63 A	5SM2345-6	5SM2345-6KK01	–	5SM2345-6KK12
	80 ... 100 A	–	–	–	–
100 mA	0.3 ... 63 A	5SM2445-6	–	–	–
	80 ... 100 A	–	–	–	–
300 mA	0.3 ... 40 A	5SM2642-6	–	–	–
	0.3 ... 63 A	5SM2645-6	–	5SM2645-8	5SM2645-6KK12
	80 ... 100 A	–	–	–	–
500 mA	0.3 ... 63 A	5SM2745-6	–	5SM2745-8	–
	80 ... 100 A	–	–	–	–
1000 mA	0.3 ... 40 A	–	–	5SM2842-8	–
	0.3 ... 63 A	–	–	5SM2845-8	–
	80 ... 100 A	–	–	–	–
Type AC					
30 mA	0.3 ... 40 A	5SM2342-0	–	–	–
	0.3 ... 63 A	5SM2345-0	–	–	–
	80 ... 100 A	–	–	–	–
300 mA	0.3 ... 40 A	5SM2642-0	–	–	–
	0.3 ... 63 A	5SM2645-0	–	5SM2645-2	–
	80 ... 100 A	–	–	–	–
500 mA	0.3 ... 63 A	5SM2745-0	–	–	–
	80 ... 100 A	–	–	–	–
1000 mA	0.3 ... 63 A	–	–	5SM2845-2	–

¹⁾ Not suitable for use with 5SY5 and type A not suitable for use with 5SY8





Mounting concept



MCB Miniature circuit breaker [See page 3/1](#)
 AS Auxiliary switch [See page 4/60](#)
 FC Fault signal contact [See page 4/62](#)

AS + FC Auxiliary switch and fault signal contact [See page 4/63](#)
 ST Shunt trips [See page 4/66](#)

UR Undervoltage release [See page 4/67](#)
 RC mech. Remote control mechanism [See page 4/68](#)

For 5SL4 miniature circuit breakers		For 5SP4 miniature circuit breakers (B and C characteristics)	
400 V AC		400 V AC	
Instantaneous	Selective [S]	Instantaneous	Selective [S]
3 MW	3 MW	5 MW	5 MW
			
5SM2343-6	–	–	–
5SM2346-6	–	–	–
–	–	5SM2347-6	–
–	–	–	–
5SM2643-6	–	–	–
5SM2646-6	5SM2646-8	–	–
–	–	5SM2647-6	5SM2647-8
–	–	–	–
–	–	–	–
–	–	–	–
–	–	–	5SM2847-8
5SM2343-0	–	–	–
5SM2346-0	–	–	–
–	–	5SM2347-0	–
5SM2643-0	–	–	–
5SM2646-0	5SM2646-2	–	–
–	–	5SM2647-0	–
–	–	–	–
–	–	–	–

Accessories

Auxiliary switches (AS)		Article No.
1 NO + 1 NC	Standard	5ST3010
	For low power	5ST3013
	For low power (with diode)	5ST3013-0XX01
2 NO	Standard	5ST3011
	For low power	5ST3014
2 NC	Standard	5ST3012
	For low power	5ST3015
1 CO	Standard	5ST3016
Fault signal contacts (FC)		Article No.
1 NO + 1 NC		5ST3020
2 NO		5ST3021
2 NC		5ST3022
Auxiliary switches and fault signal contacts (AS + FC)		Article No.
1 CO (AS) + 1 CO (FC)		5ST3062
5ST3 COM (AS + FC)		5ST3062-0MC
Shunt trips (ST)		Article No.
110 ... 415 V AC, 110 ... 220 V DC		5ST3030
24 ... 48 V AC/DC		5ST3031
12 V DC		5ST3031-0XX01

Undervoltage releases (UR)		Article No.
With integrated auxiliary switch	230 V AC	5ST3040
	110 V DC	5ST3041
	24 V DC	5ST3042
Without integrated auxiliary switch	230 V AC	5ST3043
	110 V DC	5ST3044
	24 V DC	5ST3045
Remote control mechanisms (RC mech.)		Article No.
Power	12 ... 30 V AC, 12 ... 48 V DC	5ST3055
	177 ... 270 V AC	5ST3056
Power with ARD	12 ... 30 V AC, 12 ... 48 V DC	5ST3057
	177 ... 270 V AC	5ST3058
Power with extended function	12 ... 30 V AC, 12 ... 48 V DC	5ST3070
Adapters for remote control mechanisms (RC mech.)		Article No.
5SM2 with 5SY (4P)		5ST3820-3 + 5ST3820-2
		5ST3820-3 + 5ST3820-7
5SM2 with 5SL (4P)		5ST3820-3 + 5ST3820-7

5SU1 RCBOs

Type A, 1P+N

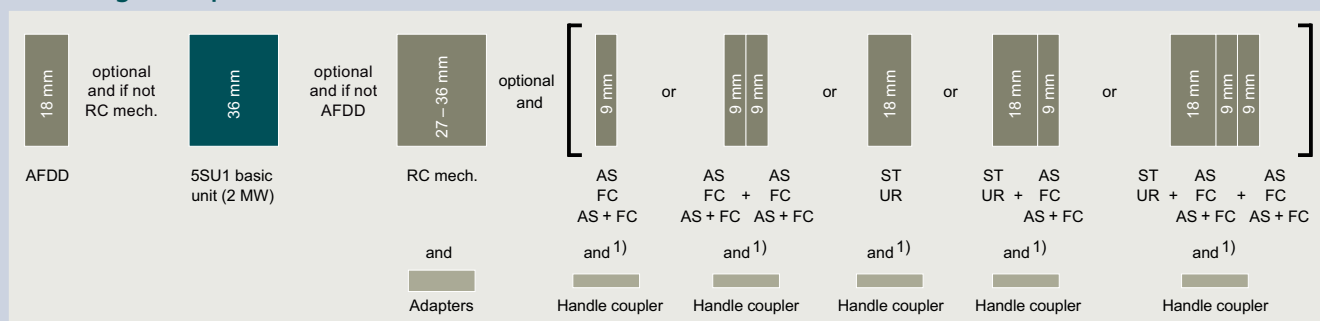
	Instantaneous		
Rated voltage U_n	230 V AC		
Mounting width	2 MW	2 MW	2 MW
Short-circuit breaking capacity	4.5 kA	4.5 kA	6 kA
N connection	Right	Left	Right



4

$I_{\Delta n}$	I_n	Bulk packaging (36 units)	Characteristic C		Characteristic B	
			C	C	B	C
Type A						
10 mA	6 A	–	–	–	–	–
	10 A	–	–	–	–	–
	13 A	–	–	–	–	–
	16 A	–	–	–	–	–
30 mA	6 A	–	5SU1353-7KK06	5SU1353-7KL06	5SU1356-6KK06	5SU1356-7KK06
		■	–	–	5SU1356-6GV06	5SU1356-7GV06
	8 A	–	5SU1353-7KK08	–	–	5SU1356-7KK08
	10 A	–	5SU1353-7KK10	5SU1353-7KL10	5SU1356-6KK10	5SU1356-7KK10
		■	–	–	5SU1356-6GV10	5SU1356-7GV10
	13 A	–	5SU1353-7KK13	–	5SU1356-6KK13	5SU1356-7KK13
	16 A	–	5SU1353-7KK16	5SU1353-7KL16	5SU1356-6KK16	5SU1356-7KK16
		■	–	–	5SU1356-6GV16	5SU1356-7GV16
	20 A	–	5SU1353-7KK20	5SU1353-7KL20	5SU1356-6KK20	5SU1356-7KK20
	25 A	–	5SU1353-7KK25	5SU1353-7KL25	5SU1356-6KK25	5SU1356-7KK25
	32 A	–	5SU1353-7KK32	5SU1353-7KL32	5SU1356-6KK32	5SU1356-7KK32
300 mA	40 A	–	5SU1353-7KK40	5SU1353-7KL40	5SU1356-6KK40	5SU1356-7KK40
	6 A	–	5SU1653-7KK06	–	5SU1656-6KK06	5SU1656-7KK06
	10 A	–	5SU1653-7KK10	–	5SU1656-6KK10	5SU1656-7KK10
	13 A	–	5SU1653-7KK13	–	5SU1656-6KK13	5SU1656-7KK13
	16 A	–	5SU1653-7KK16	–	5SU1656-6KK16	5SU1656-7KK16
	20 A	–	5SU1653-7KK20	–	5SU1656-6KK20	5SU1656-7KK20
	25 A	–	5SU1653-7KK25	–	5SU1656-6KK25	5SU1656-7KK25
	32 A	–	5SU1653-7KK32	–	5SU1656-6KK32	5SU1656-7KK32
40 A	–	5SU1653-7KK40	–	5SU1656-6KK40	5SU1656-7KK40	

Mounting concept





¹⁾ Handle couplers are required for direct attachment of the components to the 5SU1. No handle coupler is required for attaching the components to the RC mech.

AFDD Arc fault detection unit
 AS Auxiliary switch
 FC Fault signal contact
 AS + FC Auxiliary switch and fault signal contact

[See page 4/54](#)
[See page 4/60](#)
[See page 4/62](#)
[See page 4/63](#)

ST Shunt trips
 UR Undervoltage release
 RC mech. Remote control mechanism

[See page 4/66](#)
[See page 4/67](#)
[See page 4/68](#)

Instantaneous		Short-time delayed [G], super resistant [K]	
230 V AC		230 V AC	
2 MW		2 MW	
10 kA		10 kA	
Right		Right	
			
Characteristic		Characteristic	
B	C	B	C
5SU1154-6KK06	5SU1154-7KK06	–	–
5SU1154-6KK10	5SU1154-7KK10	–	–
5SU1154-6KK13	5SU1154-7KK13	–	–
5SU1154-6KK16	5SU1154-7KK16	–	–
5SU1354-6KK06	5SU1354-7KK06	–	–
5SU1354-6GV06	5SU1354-7GV06	–	–
–	5SU1354-7KK08	–	–
5SU1354-6KK10	5SU1354-7KK10	5SU1354-6LB10	5SU1354-7LB10
5SU1354-6GV10	5SU1354-7GV10	–	–
5SU1354-6KK13	5SU1354-7KK13	5SU1354-6LB13	5SU1354-7LB13
5SU1354-6KK16	5SU1354-7KK16	5SU1354-6LB16	5SU1354-7LB16
5SU1354-6GV16	5SU1354-7GV16	–	–
5SU1354-6KK20	5SU1354-7KK20	5SU1354-6LB20	5SU1354-7LB20
5SU1354-6KK25	5SU1354-7KK25	5SU1354-6LB25	5SU1354-7LB25
5SU1354-6KK32	5SU1354-7KK32	5SU1354-6LB32	5SU1354-7LB32
5SU1354-6KK40	5SU1354-7KK40	5SU1354-6LB40	5SU1354-7LB40
5SU1654-6KK06	5SU1654-7KK06	–	–
5SU1654-6KK10	5SU1654-7KK10	–	–
5SU1654-6KK13	5SU1654-7KK13	–	–
5SU1654-6KK16	5SU1654-7KK16	–	–
5SU1654-6KK20	5SU1654-7KK20	–	–
5SU1654-6KK25	5SU1654-7KK25	–	–
5SU1654-6KK32	5SU1654-7KK32	–	–
5SU1654-6KK40	5SU1654-7KK40	–	–

Accessories

Auxiliary switches (AS)		Article No.	
1 NO + 1 NC	Standard	5ST3010	
	For low power	5ST3013	
	For low power (with diode)	5ST3013-0XX01	
2 NO	Standard	5ST3011	
	For low power	5ST3014	
2 NC	Standard	5ST3012	
	For low power	5ST3015	
1 CO	Standard	5ST3016	
Fault signal contacts (FC)		Article No.	
1 NO + 1 NC		5ST3020	
2 NO		5ST3021	
2 NC		5ST3022	
Auxiliary switches and fault signal contacts (AS + FC)		Article No.	
1 CO (AS) + 1 CO (FC)		5ST3062	
5ST3 COM (AS + FC)		5ST3062-0MC	
Shunt trips (ST)		Article No.	
110 ... 415 V AC, 110 ... 220 V DC		5ST3030	
24 ... 48 V AC/DC		5ST3031	
12 V DC		5ST3031-0XX01	
Undervoltage releases (UR)		Article No.	
With integrated auxiliary switch	230 V AC	5ST3040	
	110 V DC	5ST3041	
	24 V DC	5ST3042	
Without integrated auxiliary switch	230 V AC	5ST3043	
	110 V DC	5ST3044	
	24 V DC	5ST3045	
Handle couplers for AS, FC, AS + FC, ST and UR		Article No.	
1 set = 5 units		5ST3805-1	
Remote control mechanisms (RC mech.)		Article No.	
Basic	12 ... 30 V AC, 12 ... 48 V DC	5ST3053	
	177 ... 270 V AC	5ST3054	
Power	12 ... 30 V AC, 12 ... 48 V DC	5ST3055	
	177 ... 270 V AC	5ST3056	
Power with ARD	12 ... 30 V AC, 12 ... 48 V DC	5ST3057	
	177 ... 270 V AC	5ST3058	
Power with extended function	12 ... 30 V AC, 12 ... 48 V DC	5ST3070	
	170 ... 277 V AC, 77 ... 286 V DC	5ST3071	
Adapters for remote control mechanisms (RC mech.)		Article No.	
2 MW		5ST3820-5	
Arc fault detection units (AFDD)		Article No.	
For 5SU1 basic units	I_n up to 16 A	5SM6021-2	
	I_n up to 40 A	5SM6024-2	

5SU1 RCBOs

Type F, 1P+N

Rated voltage U_n	230 V AC
Mounting width	2 MW
Short-circuit breaking capacity	10 kA
N connection	Right

Super resistant [K]

230 V AC

2 MW

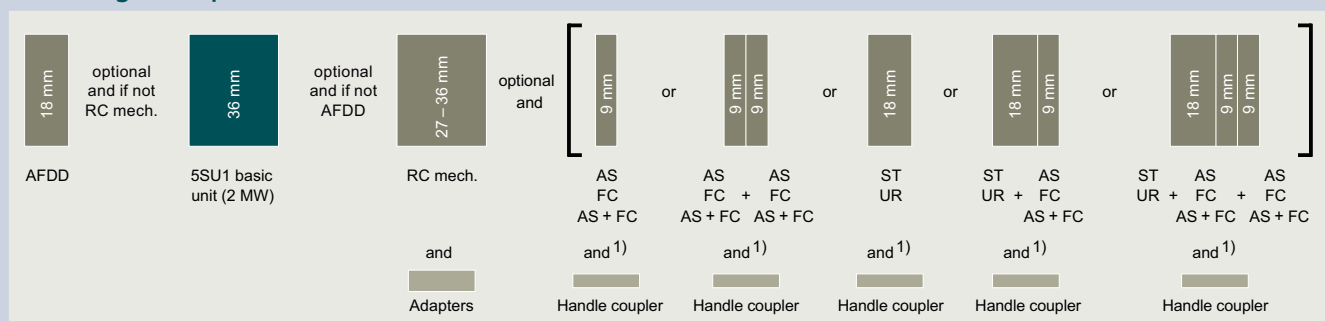
10 kA

Right



$I_{\Delta n}$	I_n	Characteristic	
		B	C
Type F			
30 mA	6 A	5SU1354-3KK06	5SU1354-4KK06
	10 A	5SU1354-3KK10	5SU1354-4KK10
	13 A	5SU1354-3KK13	5SU1354-4KK13
	16 A	5SU1354-3KK16	5SU1354-4KK16
	20 A	5SU1354-3KK20	5SU1354-4KK20
	25 A	5SU1354-3KK25	5SU1354-4KK25
	32 A	5SU1354-3KK32	5SU1354-4KK32
	40 A	5SU1354-3KK40	5SU1354-4KK40

Mounting concept



¹⁾ Handle couplers are required for direct attachment of the components to the 5SU1. No handle coupler is required for attaching the components to the RC mech.

AFDD Arc fault detection unit
 AS Auxiliary switch
 FC Fault signal contact
 AS + FC Auxiliary switch and fault signal contact

[See page 4/54](#)
[See page 4/60](#)
[See page 4/62](#)
[See page 4/63](#)



ST Shunt trips
 UR Undervoltage release
 RC mech. Remote control mechanism

[See page 4/66](#)
[See page 4/67](#)
[See page 4/68](#)

Accessories

Auxiliary switches (AS)		Article No.
1 NO + 1 NC	Standard	5ST3010
	For low power	5ST3013
	For low power (with diode)	5ST3013-0XX01
2 NO	Standard	5ST3011
	For low power	5ST3014
2 NC	Standard	5ST3012
	For low power	5ST3015
1 CO	Standard	5ST3016
Fault signal contacts (FC)		Article No.
1 NO + 1 NC		5ST3020
2 NO		5ST3021
2 NC		5ST3022
Auxiliary switches and fault signal contacts (AS + FC)		Article No.
1 CO (AS) + 1 CO (FC)		5ST3062
5ST3 COM (AS + FC)		5ST3062-0MC
Shunt trips (ST)		Article No.
110 ... 415 V AC, 110 ... 220 V DC		5ST3030
24 ... 48 V AC/DC		5ST3031
12 V DC		5ST3031-0XX01

Undervoltage releases (UR)		Article No.
With integrated auxiliary switch	230 V AC	5ST3040
	110 V DC	5ST3041
	24 V DC	5ST3042
Without integrated auxiliary switch	230 V AC	5ST3043
	110 V DC	5ST3044
	24 V DC	5ST3045
Handle couplers for AS, FC, AS + FC, ST and UR		Article No.
1 set = 5 units		5ST3805-1
Remote control mechanisms (RC mech.)		Article No.
Basic	12 ... 30 V AC, 12 ... 48 V DC	5ST3053
	177 ... 270 V AC	5ST3054
Power	12 ... 30 V AC, 12 ... 48 V DC	5ST3055
	177 ... 270 V AC	5ST3056
Power with ARD	12 ... 30 V AC, 12 ... 48 V DC	5ST3057
	177 ... 270 V AC	5ST3058
Power with extended function	12 ... 30 V AC, 12 ... 48 V DC	5ST3070
	AC 170 ... 277 V, DC 77 ... 286 V	5ST3071
Adapters for remote control mechanisms (RC mech.)		Article No.
2 MW		5ST3820-5
Arc fault detection units (AFDD)		Article No.
For 5SU1 basic units	I_n up to 16 A	5SM6021-2
	I_n up to 40 A	5SM6024-2

Instantaneous		Short-time delayed [G], super resistant [K]	
230 V AC		230 V AC	
2 MW		2 MW	
10 kA		10 kA	
Right		Right	
			
Characteristic		Characteristic	
B	C	B	C
5SU1354-0KK06	5SU1354-1KK06	–	–
–	5SU1354-1KK08	–	–
5SU1354-0KK10	5SU1354-1KK10	5SU1354-0LB10	5SU1354-1LB10
–	–	–	–
5SU1354-0KK13	5SU1354-1KK13	5SU1354-0LB13	5SU1354-1LB13
5SU1354-0KK16	5SU1354-1KK16	5SU1354-0LB16	5SU1354-1LB16
–	–	–	–
5SU1354-0KK20	5SU1354-1KK20	5SU1354-0LB20	5SU1354-1LB20
5SU1354-0KK25	5SU1354-1KK25	5SU1354-0LB25	5SU1354-1LB25
5SU1354-0KK32	5SU1354-1KK32	5SU1354-0LB32	5SU1354-1LB32
5SU1354-0KK40	5SU1354-1KK40	5SU1354-0LB40	5SU1354-1LB40
–	5SU1454-1KK06	–	–
–	5SU1454-1KK10	–	–
–	5SU1454-1KK13	–	–
–	5SU1454-1KK16	–	–
–	5SU1454-1KK20	–	–
–	5SU1454-1KK25	–	–
–	5SU1454-1KK32	–	–
–	5SU1454-1KK40	–	–
5SU1654-0KK06	5SU1654-1KK06	–	–
5SU1654-0KK10	5SU1654-1KK10	–	–
5SU1654-0KK13	5SU1654-1KK13	–	–
5SU1654-0KK16	5SU1654-1KK16	–	–
–	–	–	–
5SU1654-0KK20	5SU1654-1KK20	–	–
5SU1654-0KK25	5SU1654-1KK25	–	–
5SU1654-0KK32	5SU1654-1KK32	–	–
5SU1654-0KK40	5SU1654-1KK40	–	–

Accessories

Auxiliary switches (AS)		Article No.
1 NO + 1 NC	Standard	5ST3010
	For low power	5ST3013
	For low power (with diode)	5ST3013-0XX01
2 NO	Standard	5ST3011
	For low power	5ST3014
2 NC	Standard	5ST3012
	For low power	5ST3015
1 CO	Standard	5ST3016
Fault signal contacts (FC)		Article No.
1 NO + 1 NC		5ST3020
2 NO		5ST3021
2 NC		5ST3022
Auxiliary switches and fault signal contacts (AS + FC)		Article No.
1 CO (AS) + 1 CO (FC)		5ST3062
5ST3 COM (AS + FC)		5ST3062-0MC
Shunt trips (ST)		Article No.
110 ... 415 V AC, 110 ... 220 V DC		5ST3030
24 ... 48 V AC/DC		5ST3031
12 V DC		5ST3031-0XX01

Undervoltage releases (UR)		Article No.
With integrated auxiliary switch	230 V AC	5ST3040
	110 V DC	5ST3041
	24 V DC	5ST3042
Without integrated auxiliary switch	230 V AC	5ST3043
	110 V DC	5ST3044
	24 V DC	5ST3045
Handle couplers for AS, FC, AS + FC, ST and UR		Article No.
1 set = 5 units		5ST3805-1
Remote control mechanisms (RC mech.)		Article No.
Basic	12 ... 30 V AC, 12 ... 48 V DC	5ST3053
	177 ... 270 V AC	5ST3054
Power	12 ... 30 V AC, 12 ... 48 V DC	5ST3055
	177 ... 270 V AC	5ST3056
Power with ARD	12 ... 30 V AC, 12 ... 48 V DC	5ST3057
	177 ... 270 V AC	5ST3058
Power with extended function	12 ... 30 V AC, 12 ... 48 V DC	5ST3070
	170 ... 277 V AC, 77 ... 286 V DC	5ST3071
Adapters for remote control mechanisms (RC mech.)		Article No.
2 MW		5ST3820-5
Arc fault detection units (AFDD)		Article No.
For 5SU1 basic units	I_n up to 16 A	5SM6021-2
	I_n up to 40 A	5SM6024-2

5SU1 RCBOs

Type A, 2/3/4-pole with residual current tripped indication

2-pole
Instantaneous

Rated voltage U_n 230 V AC
Short-circuit breaking capacity 6 kA

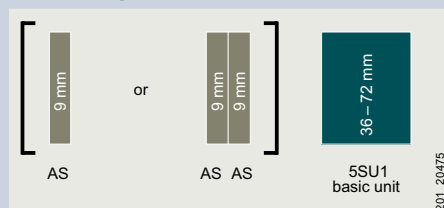


10 kA



$I_{\Delta n}$	I_n	Characteristic		Characteristic	
		B	C	B	C
30 mA	6 A	5SU1326-6FP06	5SU1326-7FP06	5SU1324-6FP06	5SU1324-7FP06
	10 A	5SU1326-6FP10	5SU1326-7FP10	5SU1324-6FP10	5SU1324-7FP10
	13 A	5SU1326-6FP13	5SU1326-7FP13	5SU1324-6FP13	5SU1324-7FP13
	16 A	5SU1326-6FP16	5SU1326-7FP16	5SU1324-6FP16	5SU1324-7FP16
	20 A	5SU1326-6FP20	5SU1326-7FP20	5SU1324-6FP20	5SU1324-7FP20
	25 A	5SU1326-6FP25	5SU1326-7FP25	5SU1324-6FP25	5SU1324-7FP25
	32 A	5SU1326-6FP32	5SU1326-7FP32	5SU1324-6FP32	5SU1324-7FP32
300 mA	6 A	–	–	–	–
	10 A	–	–	–	–
	16 A	–	–	–	–
	20 A	–	–	–	–
	25 A	–	–	–	–
	32 A	–	–	–	–




Mounting concept



AS

Auxiliary switch

[See page 4/60](#)

2-pole Short-time delayed, super resistant [K]		3-pole Instantaneous		4-pole Instantaneous	
230 V AC		400 V AC		400 V AC	
10 kA		6 kA		6 kA	
					
Characteristic		Characteristic		Characteristic	
B	C	B	C	B	C
–	5SU1324-7FR06	5SU1336-6FP06	5SU1336-7FP06	5SU1346-6FP06	5SU1346-7FP06
–	5SU1324-7FR10	5SU1336-6FP10	5SU1336-7FP10	5SU1346-6FP10	5SU1346-7FP10
–	–	5SU1336-6FP13	5SU1336-7FP13	5SU1346-6FP13	5SU1346-7FP13
5SU1324-6FR16	5SU1324-7FR16	5SU1336-6FP16	5SU1336-7FP16	5SU1346-6FP16	5SU1346-7FP16
5SU1324-6FR20	5SU1324-7FR20	5SU1336-6FP20	5SU1336-7FP20	5SU1346-6FP20	5SU1346-7FP20
5SU1324-6FR25	5SU1324-7FR25	5SU1336-6FP25	5SU1336-7FP25	5SU1346-6FP25	5SU1346-7FP25
–	5SU1324-7FR32	5SU1336-6FP32	5SU1336-7FP32	5SU1346-6FP32	5SU1346-7FP32
–	–	5SU1636-6FP06	5SU1636-7FP06	5SU1646-6FP06	5SU1646-7FP06
–	–	5SU1636-6FP10	5SU1636-7FP10	5SU1646-6FP10	5SU1646-7FP10
–	–	5SU1636-6FP16	5SU1636-7FP16	5SU1646-6FP16	5SU1646-7FP16
–	–	5SU1636-6FP20	5SU1636-7FP20	5SU1646-6FP20	5SU1646-7FP20
–	–	5SU1636-6FP25	5SU1636-7FP25	5SU1646-6FP25	5SU1646-7FP25
–	–	5SU1636-6FP32	5SU1636-7FP32	5SU1646-6FP32	5SU1646-7FP32

4

Accessories

Auxiliary switches (AS)		Article No.
1 CO	Standard	5ST1010-0FP

5SU1 RCBOs

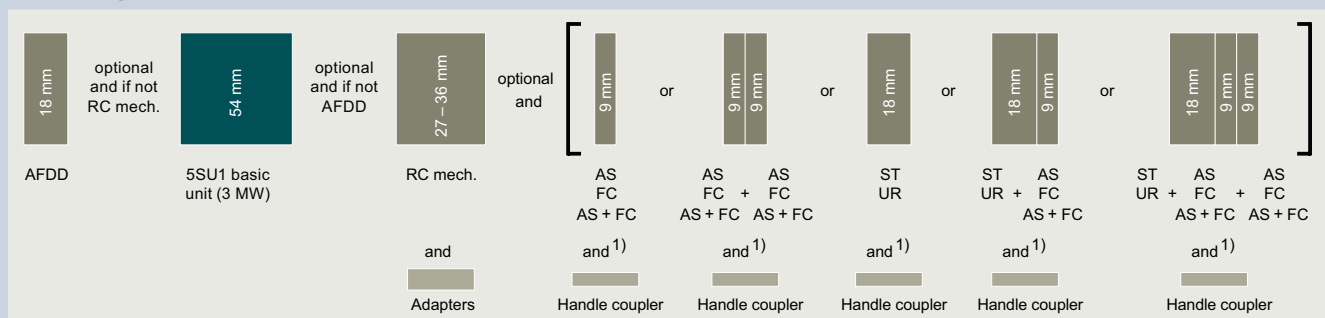
Type A and AC, 2-pole

	Instantaneous	
Rated voltage U_n	110 V AC	230 V AC
Mounting width	3 MW	3 MW
Short-circuit breaking capacity	10 kA	10 kA

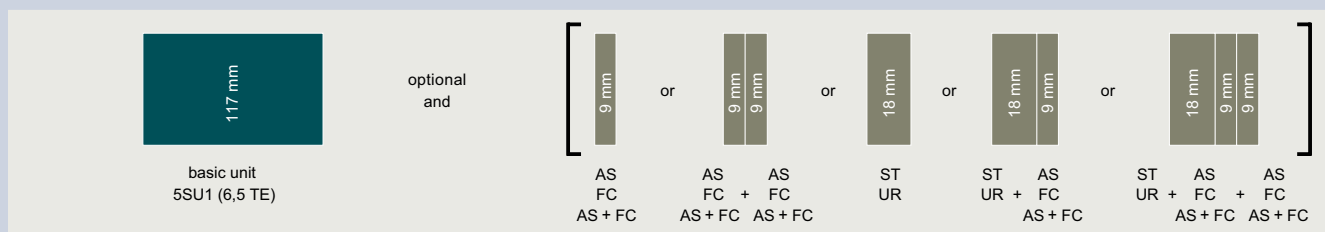


$I_{\Delta n}$	I_n	Characteristic		Characteristic
		B	C	B
Type A				
30 mA	6 A	5SU1324-6KX06	5SU1324-7KX06	5SU1324-6FA06
	10 A	5SU1324-6KX10	5SU1324-7KX10	5SU1324-6FA10
	13 A	5SU1324-6KX13	5SU1324-7KX13	5SU1324-6FA13
	16 A	5SU1324-6KX16	5SU1324-7KX16	5SU1324-6FA16
	20 A	5SU1324-6KX20	5SU1324-7KX20	5SU1324-6FA20
	25 A	5SU1324-6KX25	5SU1324-7KX25	5SU1324-6FA25
	32 A	5SU1324-6KX32	5SU1324-7KX32	5SU1324-6FA32
	40 A	5SU1324-6KX40	5SU1324-7KX40	5SU1324-6FA40
	125 A	–	–	–
300 mA	125 A	–	–	–
Type AC				
30 mA	125 A	–	–	–
300 mA	125 A	–	–	–

Mounting concept





¹⁾ Handle couplers are required for direct attachment of the components to the 5SU1. No handle coupler is required for attaching the components to the RC mech.



AFDD Arc fault detection unit [See page 4/54](#)
 AS Auxiliary switch [See page 4/60](#)
 FC Fault signal contact [See page 4/62](#)

AS + FC Auxiliary switch and fault signal contact [See page 4/63](#)
 ST Shunt trips [See page 4/66](#)

UR Undervoltage release [See page 4/67](#)
 RC mech. Remote control mechanism [See page 4/68](#)

			Selective [S]	
			230 V AC	
6.5 MW			6.5 MW	
10 kA			10 kA	
				
Characteristic			Characteristic	
C	B	C	B	C
5SU1324-7FA06	–	–	–	–
5SU1324-7FA10	–	–	–	–
5SU1324-7FA13	–	–	–	–
5SU1324-7FA16	–	–	–	–
5SU1324-7FA20	–	–	–	–
5SU1324-7FA25	–	–	–	–
5SU1324-7FA32	–	–	–	–
5SU1324-7FA40	–	–	–	–
–	5SU1324-6KK82	5SU1324-7KK82	–	–
–	5SU1624-6KK82	5SU1624-7KK82	5SU1624-6WK82	5SU1624-7WK82
–	5SU1324-0KK82	5SU1324-1KK82	–	–
–	5SU1624-0KK82	5SU1624-1KK82	–	–

Accessories

Auxiliary switches (AS)		Article No.
1 NO + 1 NC	Standard	5ST3010
	For low power	5ST3013
	For low power (with diode)	5ST3013-0XX01
2 NO	Standard	5ST3011
	For low power	5ST3014
2 NC	Standard	5ST3012
	For low power	5ST3015
1 CO	Standard	5ST3016
Fault signal contacts (FC)		Article No.
1 NO + 1 NC		5ST3020
2 NO		5ST3021
2 NC		5ST3022
Auxiliary switches and fault signal contacts (AS + FC)		Article No.
1 CO (AS) + 1 CO (FC)		5ST3062
5ST3 COM (AS + FC)		5ST3062-0MC
Shunt trips (ST)		Article No.
110 ... 415 V AC, 110 ... 220 V DC		5ST3030
24 ... 48 V AC/DC		5ST3031
12 V DC		5ST3031-0XX01

Undervoltage releases (UR)		Article No.
With integrated auxiliary switch	230 V AC	5ST3040
	110 V DC	5ST3041
	24 V DC	5ST3042
Without integrated auxiliary switch	230 V AC	5ST3043
	110 V DC	5ST3044
	24 V DC	5ST3045
Handle couplers for AS, FC, AS + FC, ST and UR		Article No.
1 set = 5 units		5ST3805-1
Remote control mechanisms (RC mech.)		Article No.
Basic	12 ... 30 V AC, 12 ... 48 V DC	5ST3053
	177 ... 270 V AC	5ST3054
	12 ... 30 V AC, 12 ... 48 V DC	5ST3055
Power	177 ... 270 V AC	5ST3056
	12 ... 30 V AC, 12 ... 48 V DC	5ST3057
Power with ARD	177 ... 270 V AC	5ST3058
	12 ... 30 V AC, 12 ... 48 V DC	5ST3070
Power with extended function	170 ... 277 V AC, 77 ... 286 V DC	5ST3071
	12 ... 30 V AC, 12 ... 48 V DC	5ST3071
Adapters for remote control mechanisms (RC mech.)		Article No.
2 MW		5ST3820-5
Arc fault detection units (AFDD)		Article No.
For 5SU1 basic units (3 MW)	I_n up to 16 A	5SM6021-2
	I_n up to 40 A	5SM6024-2

5SU1 RCBOs

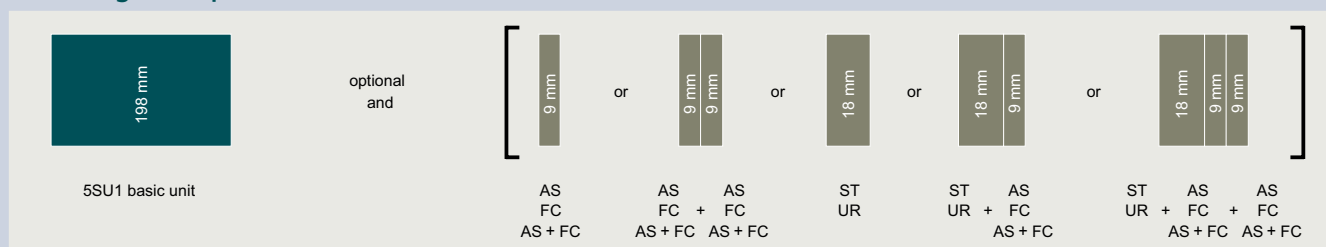
Type A and AC, 4-pole

	Instantaneous	Selective [S]
Rated voltage U_n	400 V AC	400 V AC
Mounting width	11 MW	11 MW
Short-circuit breaking capacity	10 kA	10 kA



$I_{\Delta n}$	I_n	Characteristic		Characteristic	
		B	C	B	C
Type A					
30 mA	125 A	5SU1344-6KK82	5SU1344-7KK82	–	–
300 mA	125 A	5SU1644-6KK82	5SU1644-7KK82	5SU1644-6WK82	5SU1644-7WK82
1000 mA	125 A	–	–	5SU1844-6WK82	5SU1844-7WK82
Type AC					
30 mA	125 A	5SU1344-0KK82	5SU1344-1KK82	–	–
300 mA	125 A	5SU1644-0KK82	5SU1644-1KK82	–	–

Mounting concept



AS Auxiliary switch
 FC Fault signal contact
 AS + FC Auxiliary switch and fault signal contact



[See page 4/60](#)
[See page 4/62](#)
[See page 4/63](#)

ST Shunt trips
 UR Undervoltage release

[See page 4/66](#)
[See page 4/67](#)

Type B and B+, 4-pole

		Super resistant [K]		Selective [S]	
Rated voltage U_n		400 V AC		480 V AC	400 V AC
Mounting width		11 MW		11 MW	11 MW
Short-circuit breaking capacity		10 kA		10 kA	10 kA

$I_{\Delta n}$	I_n	Characteristic		Characteristic		Characteristic	
		C	D	C	C	D	D
Type B							
30 mA	100 A	5SU1374-7AK81	5SU1374-8AK81	–	–	–	–
	125 A	5SU1374-7AK82	–	–	–	–	–
300 mA	100 A	5SU1674-7AK81	5SU1674-8AK81	5SU1674-7CK81	–	–	5SU1674-8BK81
	125 A	5SU1674-7AK82	–	5SU1674-7CK82	5SU1674-7BK82	–	–
Type B+							
30 mA	100 A	5SU1374-7DK81	5SU1374-8DK81	–	–	–	–
	125 A	5SU1374-7DK82	–	–	–	–	–
300 mA	100 A	5SU1674-7DK81	5SU1674-8DK81	5SU1674-7FK81	–	–	5SU1674-8EK81
	125 A	5SU1674-7DK82	–	5SU1674-7FK82	5SU1674-7EK82	–	–

4

Accessories

Auxiliary switches (AS)		Article No.	Auxiliary switches and fault signal contacts (AS + FC)		Article No.
1 NO + 1 NC	Standard	5ST3010	1 CO (AS) + 1 CO (FC)		5ST3062
	For low power	5ST3013	5ST3 COM (AS + FC)		5ST3062-OMC
	For low power (with diode)	5ST3013-0XX01	Shunt trips (ST)	Article No.	
2 NO	Standard	5ST3011	110 ... 415 V AC, 110 ... 220 V DC		5ST3030
	For low power	5ST3014	24 ... 48 V AC/DC		5ST3031
2 NC	Standard	5ST3012	12 V DC		5ST3031-0XX01
	For low power	5ST3015	Undervoltage releases (UR)	Article No.	
1 CO	Standard	5ST3016	With integrated auxiliary switch	230 V AC	5ST3040
Fault signal contacts (FC)				110 V DC	5ST3041
1 NO + 1 NC		5ST3020		24 V DC	5ST3042
2 NO		5ST3021	Without integrated auxiliary switch	230 V AC	5ST3043
2 NC		5ST3022		110 V DC	5ST3044
				24 V DC	5ST3045

5SV1 RCBOs

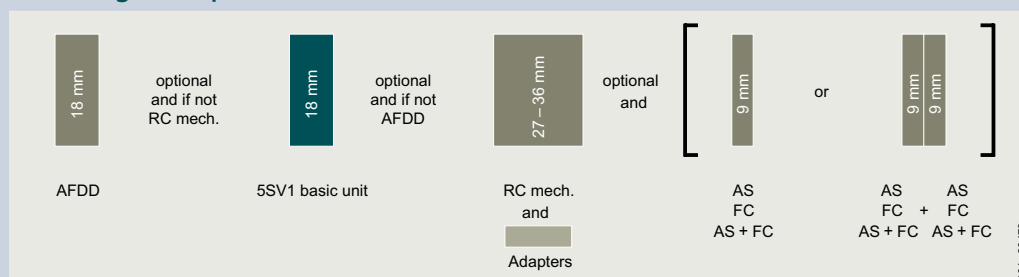
Type A, 1P+N

	Instantaneous	Short-time delayed [G], Super resistant [K]
Rated voltage U_n	230 V AC	230 V AC
Mounting width	1 MW	1 MW
Short-circuit breaking capacity	4.5 kA	6 kA
N connection	Right	Right



$I_{\Delta n}$	I_n	Bulk packaging (12 units)	Characteristic		Characteristic		Characteristic	
			B	C	B	C	B	C
Typ A								
30 mA	2 A	–	–	5SV1313-7KK02	–	5SV1316-7KK02	–	–
	4 A	–	–	5SV1313-7KK04	–	5SV1316-7KK04	–	–
	6 A	–	5SV1313-6KK06	5SV1313-7KK06	5SV1316-6KK06	5SV1316-7KK06	5SV1316-6LK06	5SV1316-7LK06
		■	–	–	5SV1316-6GV06	5SV1316-7GV06	–	–
	10 A	–	5SV1313-6KK10	5SV1313-7KK10	5SV1316-6KK10	5SV1316-7KK10	5SV1316-6LK10	5SV1316-7LK10
		■	–	–	5SV1316-6GV10	5SV1316-7GV10	–	–
	13 A	–	5SV1313-6KK13	5SV1313-7KK13	5SV1316-6KK13	5SV1316-7KK13	5SV1316-6LK13	5SV1316-7LK13
		■	–	–	5SV1316-6GV13	5SV1316-7GV13	–	–
16 A	–	5SV1313-6KK16	5SV1313-7KK16	5SV1316-6KK16	5SV1316-7KK16	5SV1316-6LK16	5SV1316-7LK16	
	■	–	–	5SV1316-6GV16	5SV1316-7GV16	–	–	
300 mA	2 A	–	–	5SV1613-7KK02	–	5SV1616-7KK02	–	–
	4 A	–	–	5SV1613-7KK04	–	5SV1616-7KK04	–	–
	6 A	–	5SV1613-6KK06	5SV1613-7KK06	5SV1616-6KK06	5SV1616-7KK06	–	–
	10 A	–	5SV1613-6KK10	5SV1613-7KK10	5SV1616-6KK10	5SV1616-7KK10	–	–
	13 A	–	5SV1613-6KK13	5SV1613-7KK13	5SV1616-6KK13	5SV1616-7KK13	–	–
	16 A	–	5SV1613-6KK16	5SV1613-7KK16	5SV1616-6KK16	5SV1616-7KK16	–	–

Mounting concept



1201_20479

AFDD Arc fault detection units
AS Auxiliary switch
FC Fault signal contact




[See page 4/54](#)
[See page 4/60](#)
[See page 4/62](#)

AS + FC Auxiliary switch and fault signal contact
RC mech. Remote control mechanism

[See page 4/63](#)
[See page 4/68](#)

Type F and AC, 1P+N

	Instantaneous		Super resistant [K]
Rated voltage U_n	230 V AC		230 V AC
Mounting width	1 MW	1 MW	1 MW
Short-circuit breaking capacity	4.5 kA	6 kA	6 kA
N connection	Right	Right	Right

$I_{\Delta n}$	I_n	Bulk packaging (12 units)	Characteristic			Characteristic	
			C	B	C	B	C
Type F							
30 mA	6 A	–	–	–	–	5SV1316-3KK06	5SV1316-4KK06
	10 A	–	–	–	–	5SV1316-3KK10	5SV1316-4KK10
	13 A	–	–	–	–	5SV1316-3KK13	5SV1316-4KK13
	16 A	–	–	–	–	5SV1316-3KK16	5SV1316-4KK16
Type AC							
30 mA	2 A	–	5SV1313-1KK02	–	5SV1316-1KK02	–	–
	4 A	–	5SV1313-1KK04	–	5SV1316-1KK04	–	–
	6 A	–	5SV1313-1KK06	5SV1316-0KK06	5SV1316-1KK06	–	–
	10 A	–	5SV1313-1KK10	5SV1316-0KK10	5SV1316-1KK10	–	–
		■	5SV1313-1GV10	–	5SV1316-1GV10	–	–
	13 A	–	5SV1313-1KK13	5SV1316-0KK13	5SV1316-1KK13	–	–
	16 A	–	5SV1313-1KK16	5SV1316-0KK16	5SV1316-1KK16	–	–
		■	5SV1313-1GV16	–	5SV1316-1GV16	–	–
300 mA	2 A	–	5SV1613-1KK02	–	5SV1616-1KK02	–	–
	4 A	–	5SV1613-1KK04	–	5SV1616-1KK04	–	–
	6 A	–	5SV1613-1KK06	5SV1616-0KK06	5SV1616-1KK06	–	–
	10 A	–	5SV1613-1KK10	5SV1616-0KK10	5SV1616-1KK10	–	–
	13 A	–	5SV1613-1KK13	5SV1616-0KK13	5SV1616-1KK13	–	–
	16 A	–	5SV1613-1KK16	5SV1616-0KK16	5SV1616-1KK16	–	–

Accessories

Auxiliary switches (AS)		Article No.
1 NO + 1 NC	Standard	5ST3010
	For low power	5ST3013
	For low power (with diode)	5ST3013-0XX01
2 NO	Standard	5ST3011
	For low power	5ST3014
2 NC	Standard	5ST3012
	For low power	5ST3015
1 CO	Standard	5ST3016
Fault signal contacts (FC)		Article No.
1 NO + 1 NC		5ST3020
2 NO		5ST3021
2 NC		5ST3022
Auxiliary switches and fault signal contacts (AS + FC)		Article No.
1 CO (AS) + 1 CO (FC)		5ST3062
5ST3 COM (AS + FC)		5ST3062-0MC

Remote control mechanisms (RC mech.)		Article No.
Basic	12 ... 30 V AC, 12 ... 48 V DC	5ST3053
	177 ... 270 V AC	5ST3054
Power	12 ... 30 V AC, 12 ... 48 V DC	5ST3055
	177 ... 270 V AC	5ST3056
Power with ARD	12 ... 30 V AC, 12 ... 48 V DC	5ST3057
	177 ... 270 V AC	5ST3058
Power with extended function	12 ... 30 V AC, 12 ... 48 V DC	5ST3070
	170 ... 277 V AC, 77 ... 286 V DC	5ST3071
Adapters for remote control mechanisms (RC mech.)		Article No.
1 MW		5ST3820-6
Arc fault detection units (AFDD)		Article No.
For 5SV1 basic units	I_n up to 16 A	5SM6011-2

5SM6 arc fault detection units

For combination with an MCB or RCBO

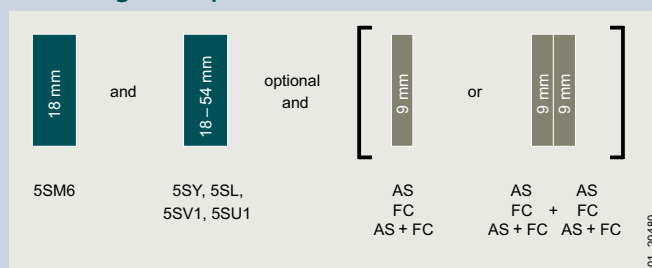


For combination with basic units			Rated current I_n	
Width of basic unit	Miniature circuit breakers	RCBO		
1 MW	5SL60 (no KL types)	5SV1	Up to 16 A	5SM6011-2
			Up to 40 A	5SM6014-2
2 MW	5SY ¹⁾ , 5SL4 (only 1+N devices, not compact)	5SU1 (2 MW, 3 MW)	Up to 16 A	5SM6021-2
			Up to 40 A	5SM6024-2

¹⁾ Not suitable for use with 5SY5 or 5SY8

4

Mounting concept



AS Auxiliary switch

FC Fault signal contact

AS + FC Auxiliary switch and fault signal contact

[See page 4/60](#)

[See page 4/62](#)

[See page 4/63](#)

The mounting concept shown is only one example of how devices and accessories can be combined.

Accessories

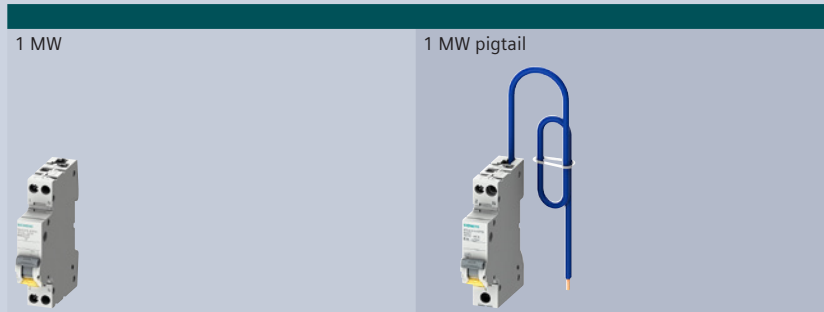
Auxiliary switches (AS)		Article No.
1 NO + 1 NC	Standard	5ST3010
	For low power	5ST3013
	For low power (with diode)	5ST3013-0XX01
2 NO	Standard	5ST3011
	For low power	5ST3014
2 NC	Standard	5ST3012
	For low power	5ST3015
1 CO	Standard	5ST3016
Fault signal contacts (FC)		Article No.
1 NO + 1 NC		5ST3020
2 NO		5ST3021
2 NC		5ST3022
Auxiliary switches and fault signal contacts (AS + FC)		Article No.
1 CO (AS) + 1 CO (FC)		5ST3062
5T3 COM (AS + FC)		5ST3062-OMC

See suitable busbars, from page 4/72 onwards

See suitable terminals and end caps, from page 4/76 onwards

5SV6 AFDD/MCB

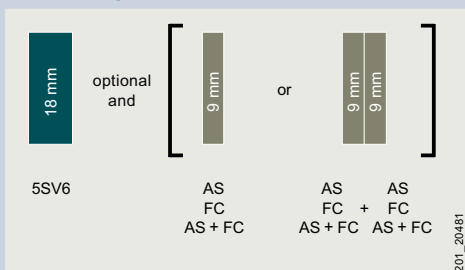
Mounting width



Rated current I_n	Bulk packaging (12 units)	Characteristic		Characteristic	
		B	C	B	C
6 A	– ■	5SV6016-6KK06 5SV6016-6GV06	5SV6016-7KK06 5SV6016-7GV06	5SV6016-6KP06 –	5SV6016-7KP06 –
10 A	– ■	5SV6016-6KK10 5SV6016-6GV10	5SV6016-7KK10 5SV6016-7GV10	5SV6016-6KP10 –	5SV6016-7KP10 –
13 A	– ■	5SV6016-6KK13 5SV6016-6GV13	5SV6016-7KK13 –	5SV6016-6KP13 –	5SV6016-7KP13 –
16 A	– ■	5SV6016-6KK16 5SV6016-6GV16	5SV6016-7KK16 5SV6016-7GV16	5SV6016-6KP16 –	5SV6016-7KP16 –
20 A	–	5SV6016-6KK20	5SV6016-7KK20	5SV6016-6KP20	5SV6016-7KP20
25 A	– ■	5SV6016-6KK25 5SV6016-6GV25	5SV6016-7KK25 –	5SV6016-6KP25 –	5SV6016-7KP25 –
32 A	–	5SV6016-6KK32	5SV6016-7KK32	5SV6016-6KP32	5SV6016-7KP32
40 A	–	5SV6016-6KK40	5SV6016-7KK40	5SV6016-6KP40	5SV6016-7KP40

4

Mounting concept



- AS Auxiliary switch [See page 4/60](#)
- FC Fault signal contact [See page 4/62](#)
- AS + FC Auxiliary switch and fault signal contact [See page 4/63](#)

Accessories

Auxiliary switches (AS)		Article No.
1 NO + 1 NC	Standard	5ST3010
	For low power	5ST3013
	For low power (with diode)	5ST3013-0XX01
2 NO	Standard	5ST3011
	For low power	5ST3014
2 NC	Standard	5ST3012
	For low power	5ST3015
	Standard	5ST3016
Fault signal contacts (FC)		Article No.
1 NO + 1 NC		5ST3020
2 NO		5ST3021
2 NC		5ST3022
Auxiliary switches and fault signal contacts (AS + FC)		Article No.
1 CO (AS) + 1 CO (FC)		5ST3062
5T3 COM (AS + FC)		5ST3062-0MC

See suitable busbars, from page 4/72 onwards
See suitable terminals and end caps, from page 4/76 onwards

5SV6 COM AFDD/MCB

With communication and measuring function

Mounting width 1 MW

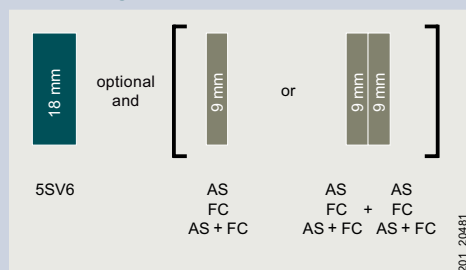


Rated current I_n	Characteristic	
	B	C
6 A	5SV6016-6MC06	5SV6016-7MC06
10 A	5SV6016-6MC10	5SV6016-7MC10
13 A	5SV6016-6MC13	5SV6016-7MC13
16 A	5SV6016-6MC16	5SV6016-7MC16
20 A	5SV6016-6MC20	5SV6016-7MC20
25 A	5SV6016-6MC25	5SV6016-7MC25
32 A	5SV6016-6MC32	5SV6016-7MC32

Note:

Please note the country-specific radio licenses of the products at www.siemens.com/lowvoltage/certificates (109801197)

Mounting concept



AS Auxiliary switch

FC Fault signal contact

AS + FC Auxiliary switch and fault signal contact

See page 4/60

See page 4/62

See page 4/63

Accessories

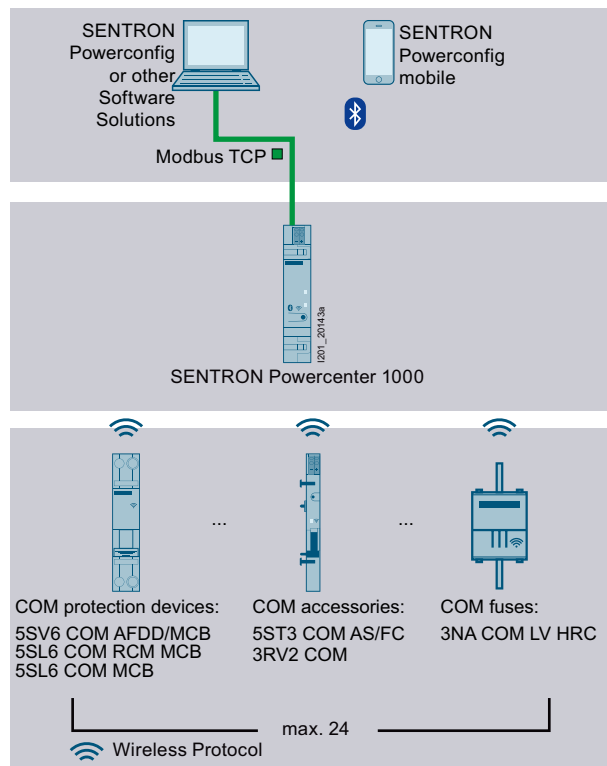
Auxiliary switches (AS)		Article No.
1 NO + 1 NC	Standard	5ST3010
	For low power	5ST3013
	For low power (with diode)	5ST3013-0XX01
2 NO	Standard	5ST3011
	For low power	5ST3014
2 NC	Standard	5ST3012
	For low power	5ST3015
	Standard	5ST3016
1 CO	Standard	5ST3016
Fault signal contacts (FC)		Article No.
1 NO + 1 NC		5ST3020
2 NO		5ST3021
2 NC		5ST3022
Auxiliary switches and fault signal contacts (AS + FC)		Article No.
1 CO (AS) + 1 CO (FC)		5ST3062
5ST3 COM (AS + FC)		5ST3062-0MC
Data transceiver (essential accessory)		Article No.
SENTRON Powercenter 1000		7KN1110-0MC00

See suitable busbars, from page 4/72 onwards

See suitable terminals and end caps, from page 4/76 onwards



SENTRON Powercenter 1000 data transceiver



- Wireless radio transmission of measured values and data to the SENTRON Powercenter 1000 data transceiver
- Commissioning, parameter assignment, firmware updates and further processing of the data via the SENTRON Powercenter 1000 data transceiver



SENTRON Powercenter 1000	Article No.
	7KN1110-0MC00

See page 10/20

You will find further information at www.siemens.com/lowvoltage/manuals

Installation Manual – Circuit protection devices with communication and measuring function (109791805)



System Manual – Circuit protection devices with communication and measuring function (109791806)



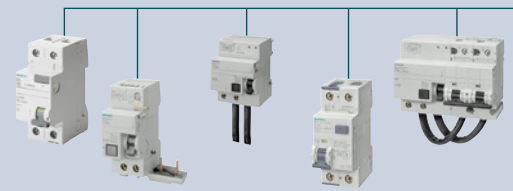
Monitoring functions with limit monitoring


- Switching state with trip monitoring: short-circuit, overload, arc fault
- Counters incl. limit monitoring for:
 - Operating hours
 - Operating hours with load current
 - Operating cycles (ON/OFF)
 - Tripping operations
 - Short circuits
- Limit values for:
 - Overcurrent alarm 1 and alarm 2
 - Undercurrent alarm 1 and alarm 2
 - Overvoltage alarm 1 and alarm 2
 - Undervoltage alarm 1 and alarm 2
 - Lower voltage threshold for AFDD tripping
 - Temperature

Measured values	Unit	Memory
Temperature	°C	1 hour in 1-minute intervals; 7 days in 15-minute intervals
Average temperature	°C	–
Current	A	Min. and max. values over 10 days; 1 hour in 10-second intervals; 7 days in 15-minute intervals
Average current	A	–
Maximum current	A	–
Voltage	V	Min. and max. values over 10 days
Line frequency	Hz	Min. and max. values over 10 days
Active power	W	Min. and max. values over 10 days
Apparent power	VA	Min. and max. values over 10 days
Reactive power	Var	–
Power factor	–	–
Active energy imported	Wh	7 days in 15-minute intervals; 30 days in 1-day intervals
Active energy exported	Wh	–
Reactive energy imported	Varh	–
Reactive energy exported	Varh	–

Overview of the modular system

Residual current protective devices



				5SV	5SM2 + MCB	5SM2 + 5SP4	5SU1	5SU1 (125 A)
5SM6 arc fault detection units				Article No.				
	Rated current up to 16 A	Standard	5SM6021-2	–	–	–	■	–
		For compact devices 1P+N in 1 MW	5SM6011-2	–	–	–	–	–
	Rated current up to 40 A	Standard	5SM6024-2	–	–	–	■	–
		For compact devices 1P+N in 1 MW	5SM6014-2	–	–	–	–	–
Auxiliary switches (AS)				Article No.				
	1 NO + 1 NC	Standard	5ST3010	■	■	■	■	■
		For low power	5ST3013	■	■	■	■	■
		For low power (with diode)	5ST3013-0XX01	■	■	■	■	■
	2 NO	Standard	5ST3011	■	■	■	■	■
		For low power	5ST3014	■	■	■	■	■
	2 NC	Standard	5ST3012	■	■	■	■	■
		For low power	5ST3015	■	■	■	■	■
	1 CO	Standard	5ST3016	■	■	■	■	■
			5ST1010-0FP	–	–	–	–	–
	Fault signal contacts (FC)				Article No.			
	1 NO + 1 NC		5ST3020	■	■	■	■	■
	2 NO		5ST3021	■	■	■	■	■
	2 NC		5ST3022	■	■	■	■	■
Auxiliary switches and fault signal contacts (AS + FC)				Article No.				
	1 CO (AS) + 1 CO (FC)	Standard	5ST3062	■	■	■	■	■
	5ST3 COM (AS + FC)	With communication and measuring function	5ST3062-0MC	■	■	■	■	■
Shunt trips (ST)				Article No.				
	110 ... 415 V AC, 110 ... 220 V DC		5ST3030	■	■	■	■	■
	24 ... 48 V AC/DC		5ST3031	■	■	■	■	■
	12 V DC		5ST3031-0XX01	■	■	■	■	■
Undervoltage releases (UR)				Article No.				
	With integrated auxiliary switch	230 V AC	5ST3040	■	■	■	■	■
		110 V DC	5ST3041	■	■	■	■	■
		24 V DC	5ST3042	■	■	■	■	■
	Without integrated auxiliary switch	230 V AC	5ST3043	■	■	■	■	■
		110 V DC	5ST3044	■	■	■	■	■
		24 V DC	5ST3045	■	■	■	■	■
Remote control mechanisms (RC mech.)				Article No.				
	Basic	12 ... 30 V AC, 12 ... 48 V DC	5ST3053	–	–	–	■	–
		177 ... 270 V AC	5ST3054	–	–	–	–	–
	Power	12 ... 30 V AC, 12 ... 48 V DC	5ST3055	■	■	–	■	–
		177 ... 270 V AC	5ST3056	■	■	–	■	–
	Power with ARD	12 ... 30 V AC, 12 ... 48 V DC	5ST3057	■	■	–	■	–
		177 ... 270 V AC	5ST3058	■	■	–	■	–
	Power with extended function	12 ... 30 V AC, 12 ... 48 V DC	5ST3070	■	■	–	■	–
		170 ... 277 V AC, 77 ... 286 V DC	5ST3071	■	–	–	■	–
Standard busbars				Article No.				
	Cannot be cut		5ST36..	■	■	■	■	■
	Can be cut		5ST37..	■	■	■	■	■
Compact busbars				Article No.				
	Cannot be cut		5ST36..	■	–	–	–	–
	Can be cut		5ST37..	■	–	–	–	–

From page 4/14

■ Suitable for all versions

□ Suitable for some versions

Electrical accessories



Auxiliary switches (AS)

- Signals the contact position of the mounted device
- Version for the switching of small currents and voltages according to EN 61131-2 for control of programmable control systems (PLCs)
- Test button enables the testing of control circuits without the need to switch the mounted device

For combining with basic units						Contacts	Version	Mounting width (1 MW = 18 mm)	Article No.
Miniature circuit breakers	Circuit breakers for equipment	RCCBs	RCBOs	Arc fault detection devices	ON/OFF switches				
Auxiliary switches (AS)									
–	–	5SM3 (3P+N, 100/125 A)	–	–	–	1 NO + 1 NC	Standard	0.5 MW	5SW3330
5SL, 5SY, 5SP4, 5SP5	5SY17	5SV	5SU1 ¹⁾ , 5SV1	5SV6	5TL1, 5TE8	1 NO + 1 NC	Standard	0.5 MW	5ST3010
							For low power	0.5 MW	5ST3013
							For low power (with diode)	0.5 MW	5ST3013-0XX01
						2 NO	Standard	0.5 MW	5ST3011
							For low power	0.5 MW	5ST3014
						2 NC	Standard	0.5 MW	5ST3012
							For low power	0.5 MW	5ST3015
1 CO	Standard	0.5 MW	5ST3016						
–	–	–	5SU1... FP/FR	–	–	1 CO	Standard	0.5 MW	5ST1010-0FP
Auxiliary switches (AS) with TEST button									
5SL, 5SY, 5SP4, 5SP5	5SY17	5SV	5SU1 ¹⁾ , 5SV1	5SV6	5TL1, 5TE8	1 NO + 1 NC	Standard	0.5 MW	5ST3010-2
							For low power	0.5 MW	5ST3013-2
							2 NO	Standard	0.5 MW
						2 NO	For low power	0.5 MW	5ST3014-2
							2 NC	Standard	0.5 MW
						For low power	0.5 MW	5ST3015-2	

¹⁾ 5ST3805-1 handle coupler required

Further technical specifications

		5ST3010, 5ST3011, 5ST3012, 5ST3016	5ST3010-2, 5ST3011-2, 5ST3012-2	5ST3013, 5ST3014, 5ST3015, 5ST3013-0XX01 ¹⁾	5ST3013-2, 5ST3014-2, 5ST3015-2	5SW3330	5ST1010-OFP
Standards							
Standards	IEC/EN	IEC/EN 62019, IEC/EN 60947-5-1			IEC/EN 62019		
	UL, CSA	UL 1077, CSA C22.2 No. 235	–	UL 1077, CSA C22.2 No. 235	–		
Contacts							
Minimum contact load		50 mA, 24 V		1 mA, 5 V DC	5 mA, 5 V DC	50 mA, 24 V	5 mA, 24 V DC
Maximum contact load		–		100 mA, 30 V DC	50 mA, 30 V DC	–	
Contact load acc. to IEC/EN 62019 and IEC/EN 60947-5-1	230 V AC, AC-12	–				5/–	6 A/–
	230 V AC, AC-13	6 A/6 A		–			
	400 V AC, AC-13	2 A/2 A		–			
	230 V AC, AC-14	6 A/6 A		–			
	400 V AC, AC-14	2 A/2 A		–			
	24 V DC, DC-13	6 A/3 A		–			
	30 V DC, DC-14	–		0.1 A		–	
	60 V DC, DC-13	3 A/1.5 A		–			
	110 V DC, DC-13	1 A/0.75 A		–			
	220 V DC, DC-12	–				0.5/–	1 A/–
Contact load acc. to UL	120 V AC	–					
	125 V AC	3 A	–				
	240 V AC	4 A	–				
	277 V AC	–					
	480 V AC	–					
	60 V DC	–					
	125 V DC	1.1 A	–				
	250 V DC	0.55 A	–				
Service life, on average, with rated load	Actuations	20000			–	8000	
Safety							
Short-circuit protection		Miniature circuit breakers 5SY... 6 A or gG 6 A fuse			B6 or C6 or gL/gG 6 A fuse		
Connections							
Conductor cross-sections		0.5 ... 2.5 mm ² (AWG 22 ... 14)			0.75 ... 2.5 mm ²		
Terminals	Max. tightening torque	0.5 Nm (4.5 lb-in)			–	0.6 Nm	
Ambient conditions							
Permissible ambient temperature		–40 ... +70 °C			–25 ... +60 °C		
Permissible storage temperature		–40 ... +75 °C			–40 ... +70 °C		
Resistance to climate	Acc. to IEC 60068-2-30	28 cycles					
Mounting position		Any					
Shock at 11 ms half-sine	Acc. to IEC 60068-2-27	150 m/s ²			–		
Resistance to vibrations at 10 ... 150 Hz	Acc. to IEC 60068-2-6	50 m/s ²			–		

¹⁾ No approvals

Electrical accessories



Fault signal contacts (FC)

- Signals automatic tripping of the circuit protection device in the event of a fault, such as an overload or a short circuit
- If the fault signal contact is activated, the contact position does not change if the mounted circuit protection device is tripped manually
- Version with TEST and RESET buttons enables the testing of control circuits without operation of the circuit protection device
- Red RESET button in the operating handle indicates automatic tripping of the mounted circuit protection device

For combining with basic units					Contacts	Mounting width (1 MW = 18 mm)	Article No.
Miniature circuit breakers	Circuit breakers for equipment	RCCBs	RCBOs	Arc fault detection devices			
Fault signal contacts (FC)							
5SL, 5SY, 5SP4, 5SP5	5SY17	5SV	5SU1 ¹⁾ , 5SV1	5SV6	1 NO + 1 NC	0.5 MW	5ST3020
					2 NO	0.5 MW	5ST3021
					2 NC	0.5 MW	5ST3022
Fault signal contacts (FC) with TEST and RESET buttons							
5SL, 5SY, 5SP4, 5SP5	5SY17	5SV	5SU1 ¹⁾ , 5SV1	5SV6	1 NO + 1 NC	0.5 MW	5ST3020-2
					2 NO	0.5 MW	5ST3021-2
					2 NC	0.5 MW	5ST3022-2

¹⁾ 5ST3805-1 handle coupler required

Further technical specifications

Standards		
Standards	IEC/EN UL, CSA	IEC/EN 62019, IEC/EN 60947-5-1 UL 1077, CSA C22.2 No. 235 –
Contacts		
Minimum contact load		50 mA, 24 V
Contact load acc. to IEC/EN 62019/IEC/EN 60947-5-1	230 V AC, AC-13	6 A/6 A
	400 V AC, AC-13	6 A/6 A
	230 V AC, AC-14	2 A/2 A
	400 V AC, AC-14	2 A/2 A
	24 V DC, DC-13	6 A/3 A
	60 V DC, DC-13	3 A/1.5 A
	110 V DC, DC-13	1 A/0.75 A
	220 V DC, DC-13	1 A/0.5 A
Contact load acc. to UL	120 V AC	–
	125 V AC	3 A –
	240 V AC	4 A –
	277 V AC	–
	480 V AC	1.5 A –
	60 V DC	–
	125 V DC	1.1 A –
	250 V DC	0.55 A –
Service life, on average, with rated load	Actuations	20000
Safety		
Short-circuit protection		Miniature circuit breaker or gG 6 A fuse
Connections		
Conductor cross-sections		0.5 ... 2.5 mm ² (AWG 22 ... 14)
Terminals	Max. tightening torque	0.5 Nm (4.5 lb-in)
Ambient conditions		
Permissible ambient temperature		–25 ... +55 °C
Permissible storage temperature		–40 ... +75 °C
Resistance to climate	Acc. to IEC 60068-2-30	28 cycles
Mounting position		Any
Shock at 11 ms half-sine	Acc. to IEC 60068-2-27	150 m/s ²
Resistance to vibration at 10 ... 150 Hz	Acc. to IEC 60068-2-6	50 m/s ²

**5ST3020,
5ST3021,
5ST3022**

**5ST3020-2,
5ST3021-2,
5ST3022-2**



Auxiliary switches and fault signal contacts (AS + FC)

- Combines the function of both switches in a width of only 0.5 MW (9 mm)
- Signals the contact position of the mounted circuit protection device
- Signals automatic tripping of the circuit protection device in the event of a fault, such as an overload, a short circuit or a fault current
- If the fault signal contact is activated, the contact position does not change if the mounted circuit protection device is tripped manually

For combining with basic units				Contacts	Mounting width (1 MW = 18 mm)	Article No.
Miniature circuit breakers	Circuit breakers for equipment	RCCBs	RCBOs	Arc fault detection devices		
Auxiliary switches and fault signal contacts (AS + FC)						
5SL, 5SY, 5SP4, 5SP5	5SY17	5SV	5SU1 ¹⁾ , 5SV1	5SV6	1 CO (AS) + 1 CO (FC)	0.5 MW 5ST3062

¹⁾ 5ST3805-1 handle coupler required

4

Further technical specifications

5ST3062

Standards		
Standards	IEC/EN UL, CSA	IEC/EN 62019, IEC/EN 60947-5-1 UL 1077, CSA C22.2 No. 235
Contacts		
Minimum contact load		50 mA, 24 V
Maximum contact load		–
Contact load according to IEC/EN 62019/ IEC/EN 60947-5-1	230 V AC, AC-13	6 A/6 A
	400 V AC, AC-14	2 A/2 A
Contact load according to IEC/EN 62019/ IEC/EN 60947-5-1	24 V DC, DC-13	3 A/3 A
	60 V DC, DC-13	3 A/1 A
	110 V DC, DC-13	0.5 A/0.5 A
	220 V DC, DC-13	0.5 A/0.3 A
Contact load acc. to UL	125 V AC	2 A
	240 V AC	1.5 A
	480 V AC	0.75 A
	125 V DC	0.5 A
	250 V DC	0.3 A
Service life, on average, with rated load	Actuations	20000
Safety		
Short-circuit protection		Miniature circuit breaker or gG 6 A fuse
Connections		
Conductor cross-sections		0.5 ... 2.5 mm ² (AWG 22 ... 14)
Terminals	Max. tightening torque	0.5 Nm (4.5 lb-in)
Ambient conditions		
Permissible ambient temperature		–25 ... +55 °C
Permissible storage temperature		–40 ... +75 °C
Resistance to climate	Acc. to IEC 60068-2-30	28 cycles
Mounting position		Any
Shock at 11 ms half-sine	Acc. to IEC 60068-2-27	150 m/s ²
Resistance to vibrations at 10 ... 150 Hz	Acc. to IEC 60068-2-6	50 m/s ²

Electrical accessories



5ST3 COM auxiliary switches and fault signal contacts (AS + FC) with communication and measuring function

- Reports the switching state of the mounted standard circuit protection device (ON, tripped, manual OFF, tripped with locked handle)
- Measures the temperature of the device and counts operating cycles, trips and operating hours
- Communication via radio to SENTRON Powercenter 1000 data transceiver
- Plug-in terminals for 24 V DC power supply incl. daisy chain function
- Low space requirements of 0.5 MW (9 mm)

For combining with basic units					Mounting width (1 MW = 18 mm)	Article No.
Miniature circuit breakers	Circuit breakers for equipment	RCCBs	RCBOs	Arc fault detection devices	Communication	
5ST3 COM auxiliary switches and fault signal contacts (AS + FC) with communication and measuring function						
5SL, 5SY, 5SP4, 5SP5	5SY17	5SV	5SU1 ¹⁾ , 5SV1	5SV6	Radio link to SENTRON Powercenter 1000	0.5 MW 5ST3062-0MC

¹⁾ 5ST3805-1 handle coupler required

Note:

Please note the country-specific radio licenses of the products at www.siemens.com/lowvoltage/certificates (109801197)

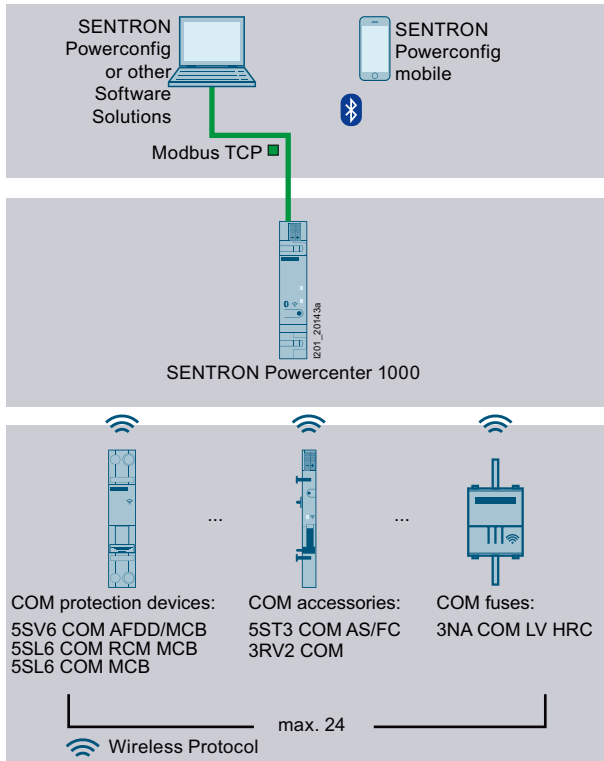
Further technical specifications

5ST3062-0MC

Standards		
Standards	IEC/EN; UL, CSA RED	60669-2-5 2014/53/EU
Power supply		
Power supply		24 V DC ±20%, SELV
Conductor cross-sections		0.2 ... 1.5 mm ²
Connection type		Plug-in terminal
Safety		
Degree of pollution for overvoltage category		2/II
Degree of protection		IP40, with front cover
Ambient conditions		
Permissible ambient temperature		-25 ... +60 °C
Permissible storage temperature		-40 ... +85 °C
Humidity		93% at 40 °C
Resistance to climate	Acc. to IEC 60068-2-30	28 cycles
Mounting position		Any
Shock		150 m/s ²
Resistance to vibrations at 10 ... 150 Hz	Acc. to IEC 60068-2-6	50 m/s ²
Service life/endurance		10000
Communication		
Interface	SETRON Powercenter 1000	Radio link
Temperature		Measuring accuracy of 2 °C with limit monitoring incl. storage (1 hour in 1-minute intervals and 7 days in 15-minute intervals)
Operating cycles counters		Mechanical operation with limit monitoring
Trip counter		Trip of the mounted circuit protection device with limit monitoring
Operating hours counter		Operating hours with limit monitoring



SENTRON Powercenter 1000 data transceiver



- Wireless radio transmission of measured values and data to the SENTRON Powercenter 1000 data transceiver
- Commissioning, parameter assignment, firmware updates and further processing of the data via the SENTRON Powercenter 1000 data transceiver



SENTRON Powercenter 1000	Article No.
	7KN1110-0MC00

See page 10/20

You will find further information at www.siemens.com/lowvoltage/manuals

Installation Manual – Circuit protection devices with communication and measuring function (109791805)



System Manual – Circuit protection devices with communication and measuring function (109791806)



Electrical accessories



Shunt trips (ST)

- For remote-controlled tripping of the mounted device

For combining with basic units			Rated operational voltage U_e	Mounting width (1 MW = 18 mm)	Article No.
Miniature circuit breakers	RCCBs	RCBOs			
Shunt trips (ST)					
5SL4, 5SY, 5SP4, 5SP5	5SV	5SU1 ¹⁾	110 ... 415 V AC, 110 ... 220 V DC	1 MW	5ST3030
			24 ... 48 V AC/DC	1 MW	5ST3031
			12 V DC	1 MW	5ST3031-0XX01

¹⁾ 5ST3805-1 handle coupler required

4

Further technical specifications

	5ST3030	5ST3031	5ST3031-0XX01
Standards			
Standards	IEC/EN		EN 60947-1
Supply			
Primary operating range	0.7 ... 1.1 × U_n		
Rated frequency f_n	50 ... 60 Hz		–
Contacts			
Minimum contact load	50 mA, 24 V		1 mA, 5 V
Tripping operations	Max. 2000		
Service life, on average, with rated load	Actuations		20000
Safety			
Short-circuit protection	Miniature circuit breaker B/C 6 A or fuse gG 6 A		
Connections			
Conductor cross-sections	0.5 ... 2.5 mm ² (AWG 22 ... 14)		
Terminals	Max. tightening torque		0.8 Nm (6.8 lb-in)
Ambient conditions			
Permissible ambient temperature	–25 ... +55 °C		–40 ... +70 °C
Permissible storage temperature	–40 ... +75 °C		
Resistance to climate	Acc. to IEC 60068-2-30		28 cycles
Mounting position	Any		
Shock at 11 ms half-sine	Acc. to IEC 60068-2-27		150 m/s ²
Resistance to vibrations at 10 ... 150 Hz	Acc. to IEC 60068-2-6		50 m/s ²



Undervoltage releases (UR)

- Are integrated (e.g. in EMERGENCY-OFF loops), thus ensuring that the MCB trips in the event of an emergency. EMERGENCY-OFF is a function provided to disconnect the electricity supply to all or some parts of the installation in case of emergency, when there is a risk of electric shock or any other hazard caused by electrical power
- In addition, an undervoltage release also trips if the voltage is interrupted or too low, or prevents the MCB from closing
- Combination with 5SV RCCB not suitable for implementation of EMERGENCY-OFF/ EMERGENCY-STOP circuits

For combining with basic units			Rated operational voltage U_e	Mounting width (1 MW = 18 mm)	Article No.
Miniature circuit breakers	RCCBs	RCBOs			
With integrated auxiliary switch					
5SL4, 5SY, 5SP4, 5SP5	5SV	5SU1 ¹⁾	230 V AC	1 MW	5ST3040
			110 V DC	1 MW	5ST3041
			24 V DC	1 MW	5ST3042
Without integrated auxiliary switch					
5SL4, 5SY, 5SP4, 5SP5	5SV	5SU1 ¹⁾	230 V AC	1 MW	5ST3043
			110 V DC	1 MW	5ST3044
			24 V DC	1 MW	5ST3045

¹⁾ 5ST3805-1 handle coupler required

Further technical specifications

5ST304.

Standards		
Standards	IEC/EN	EN 60947-1
Supply		
Primary operating range		0.85 ... 1.1 × U_n
Rated frequency f_n		50/60 Hz
Contacts		
Minimum contact load		50 mA, 24 V
Tripping operations		Max. 2000
Service life, on average, with rated load	Actuations	20000
Safety		
Short-circuit protection		Miniature circuit breaker B/C 6 A or fuse gG 6 A
Connections		
Conductor cross-sections		0.5 ... 2.5 mm ² (AWG 22 ... 14)
Terminals	Max. tightening torque	0.8 Nm (6.8 lb-in)
Ambient conditions		
Permissible ambient temperature		−25 ... +55 °C
Permissible storage temperature		−40 ... +75 °C
Resistance to climate	Acc. to IEC 60068-2-30	28 cycles
Mounting position		Any
Shock at 11 ms half-sine	Acc. to IEC 60068-2-27	150 m/s ²
Resistance to vibrations at 10 ... 150 Hz	Acc. to IEC 60068-2-6	50 m/s ²

Electrical accessories



5ST3 remote control mechanisms (RC mech.)

- For locations that are spread out over a wide area or not permanently attended
- Permits direct and immediate access to the installation even if it is remote or in a location that is hard to access
- Permits fast reconnection after a fault
- Version with ARD with automatic restart
- Versions with ARD and Power with integrated auxiliary switches and fault signal contacts

Type of remote control mechanism	Display	Ambient temperature	Vibration and shock requirements	Rated operational voltage U_e	Mounting width (1 MW = 18 mm)	Article No.
Basic	–	–25 °C ... +45 °C	–	12 ... 30 V AC, 12 ... 48 V DC	1.5 MW	5ST3053
				177 ... 270 V AC	2 MW	5ST3054
Power	LED	–25 °C ... +45 °C	–	12 ... 30 V AC, 12 ... 48 V DC	2 MW	5ST3055
				177 ... 270 V AC	2 MW	5ST3056
Power with ARD	LED	–25 °C ... +45 °C	–	12 ... 30 V AC, 12 ... 48 V DC	2 MW	5ST3057
				177 ... 270 V AC	2 MW	5ST3058
Power with extended function	LED	–40 °C ... +70 °C	Acc. to EN 61373/ EN 50155 "1B"	12 ... 30 V AC, 12 ... 48 V DC	2 MW	5ST3070
				170 ... 277 V AC, 77 ... 286 V DC	2 MW	5ST3071

Further technical specifications



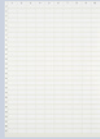

	5ST3053	5ST3054	5ST3055	5ST3056	5ST3057	5ST3058	5ST3070	5ST3071
Standards								
Standards	EN 50557 (VDE 0640-20)							
Supply								
Rated frequency f_n	50 ... 60 Hz							
Rated power dissipation on standby	≤ 1 VA							
Contacts								
Service life, on average, with rated load	Actuations	10000						
Number of remote switching operations per minute	2							
Number of automatic reclose attempts	–				3	–		
Cable length in the control circuit	≤ 1500 m							≤ 1500 m (DC) ≤ 200 m (AC)
Sliding selector with locking device	–	■						
Integrated auxiliary switches	–		1CO; 2 A; 250 V					
Integrated fault signal contacts	–		1CO; 2 A; 250 V					
Connections								
Conductor cross-sections	0.5 ... 1.5 mm ² (AWG 14 ... 30)							
Terminal tightening torque	0.2 ... 0.25 Nm (2.0 lb-in)							
Ambient conditions								
Permissible storage temperature	–40 ... +55 °C						–40 ... +70 °C	
Degree of protection	IP20							
Degree of pollution for overvoltage category	3/II							

Suitable adapters for combination with basic units



Basic units	Mounting width							Article No.
	1 MW	2 MW	3 MW	4 MW	2-pole	3-pole	4-pole	
5SU1	–	■	■	–	–	–	–	5ST3820-5
5SV1	■	–	–	–	–	–	–	5ST3820-6
5SV3	–	■	–	■	–	–	–	5ST3820-6
5SM2 with 5SY	–	–	–	–	■	–	–	5ST3820-3 + 5ST3820-1
	–	–	–	–	–	■	■	5ST3820-3 + 5ST3820-2
5SM2 with 5SL	–	–	–	–	■	–	–	5ST3820-3 + 5ST3820-6
	–	–	–	–	–	■	■	5ST3820-3 + 5ST3820-7

Mechanical accessories

Handle couplers for additional components							
	<ul style="list-style-type: none"> Necessary for mounting the additional components auxiliary switches, fault signal contacts, shunt trips and undervoltage releases onto the 5SU1 RCBO 1 set = 5 units 						
	Article No. 5ST3805-1						
Handle locking devices							
	<ul style="list-style-type: none"> To prevent undesired mechanical ON/OFF switching Sealable and lockable For padlock with 3 ... 6 mm shackle 						
	<table border="1"> <thead> <tr> <th>Version</th> <th>Article No.</th> </tr> </thead> <tbody> <tr> <td>For 5SV RCCBs, 5SV1 RCBOs, 5SV6 AFDD/MCB</td> <td>5ST3806</td> </tr> <tr> <td>For 5SU1 RCBOs</td> <td>5ST3801-1</td> </tr> </tbody> </table>	Version	Article No.	For 5SV RCCBs, 5SV1 RCBOs, 5SV6 AFDD/MCB	5ST3806	For 5SU1 RCBOs	5ST3801-1
	Version	Article No.					
For 5SV RCCBs, 5SV1 RCBOs, 5SV6 AFDD/MCB	5ST3806						
For 5SU1 RCBOs	5ST3801-1						
Locking device							
	<ul style="list-style-type: none"> For 5SV RCCBs, 5SV1 RCBOs, 5SV6 AFDD/MCB 						
	<table border="1"> <thead> <tr> <th>Comprising</th> <th>Article No.</th> </tr> </thead> <tbody> <tr> <td>5ST3806 handle locking device and 5ST3802 padlock</td> <td>5ST3807</td> </tr> </tbody> </table>	Comprising	Article No.	5ST3806 handle locking device and 5ST3802 padlock	5ST3807		
Comprising	Article No.						
5ST3806 handle locking device and 5ST3802 padlock	5ST3807						
Padlock							
	<ul style="list-style-type: none"> For 5ST3801-1 and 5ST3806 handle locking devices and 5ST3054 ... 58, 5ST3070 remote control mechanisms 						
	Article No. 5ST3802						
Device labels							
	<ul style="list-style-type: none"> For adhesive attachment For modular installation devices, e.g. 5SY, 5SL, 5TL1 						
	<table border="1"> <thead> <tr> <th>Types</th> <th>Article No.</th> </tr> </thead> <tbody> <tr> <td>15 mm × 6 mm, white (WIN 098)</td> <td>8WH8210-0AA35</td> </tr> <tr> <td>15 mm × 6 mm, yellow (WIN 099)</td> <td>8WH8210-0AA36</td> </tr> </tbody> </table>	Types	Article No.	15 mm × 6 mm, white (WIN 098)	8WH8210-0AA35	15 mm × 6 mm, yellow (WIN 099)	8WH8210-0AA36
Types	Article No.						
15 mm × 6 mm, white (WIN 098)	8WH8210-0AA35						
15 mm × 6 mm, yellow (WIN 099)	8WH8210-0AA36						
Covers for connection terminals							
	<ul style="list-style-type: none"> For 5SV3 and 5SV4 residual current operated circuit breakers, sealable (2 units in plastic bag) 						
	<table border="1"> <thead> <tr> <th>Mounting width</th> <th>Article No.</th> </tr> </thead> <tbody> <tr> <td>2 MW</td> <td>5SW3010</td> </tr> <tr> <td>4 MW</td> <td>5SW3008</td> </tr> </tbody> </table>	Mounting width	Article No.	2 MW	5SW3010	4 MW	5SW3008
Mounting width	Article No.						
2 MW	5SW3010						
4 MW	5SW3008						
Terminal covers, gray							
	<ul style="list-style-type: none"> For surface mounting, degree of protection IP40 Sealable Can be used with 35 mm DIN rail 						
	<table border="1"> <thead> <tr> <th>For width up to</th> <th>Article No.</th> </tr> </thead> <tbody> <tr> <td>2.5 MW</td> <td>5SW3004</td> </tr> <tr> <td>4.5 MW</td> <td>5SW3005</td> </tr> </tbody> </table>	For width up to	Article No.	2.5 MW	5SW3004	4.5 MW	5SW3005
For width up to	Article No.						
2.5 MW	5SW3004						
4.5 MW	5SW3005						
Wall enclosures, gray							
	<ul style="list-style-type: none"> For flush mounting, degree of protection IP40 Can be used with 35 mm DIN rail 						
	<table border="1"> <thead> <tr> <th>For width up to</th> <th>Article No.</th> </tr> </thead> <tbody> <tr> <td>2.5 MW</td> <td>5SW3006</td> </tr> <tr> <td>4.5 MW</td> <td>5SW3007</td> </tr> </tbody> </table>	For width up to	Article No.	2.5 MW	5SW3006	4.5 MW	5SW3007
For width up to	Article No.						
2.5 MW	5SW3006						
4.5 MW	5SW3007						

RCCB protective socket outlets

Acc. to VDE 0664

Covers



- Can be assembled as mini-distribution board
- Suitable for all devices
- Cover parts prepared for rail mounting of conventional label caps

Comprising	Article No.
End plates	5ST2134
Angled profile	5ST2135
Flat profile as alternative	5ST2136

RCCB protective socket outlets in molded-plastic enclosures



- Equipped with RCCB and flush-mounted SCHUKO® socket outlet
- Degree of protection IP54

Rated residual current $I_{\Delta n}$	Rated current I_n	Article No.
10 mA	16 A	5SZ9206
30 mA	16 A	5SZ9216

4

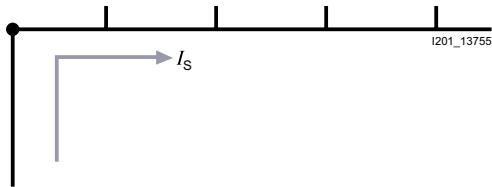
Standard busbars

General information



Infeed

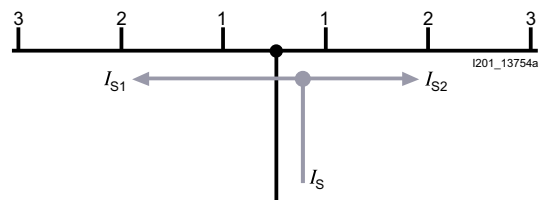
At the start or end of the busbar



Maximum busbar current I_s /phase

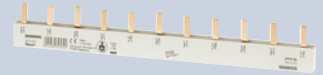
- Cross-section 10 mm²: 63 A
- Cross-section 16 mm²: 80 A

Along the busbar or midpoint infeed



Maximum busbar current I_s /phase

- Cross-section 10 mm²: 100 A
- Cross-section 16 mm²: 130 A

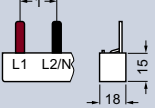
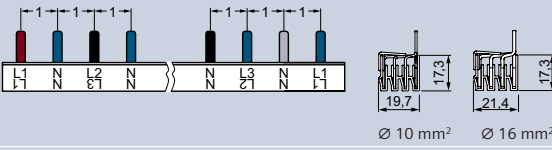
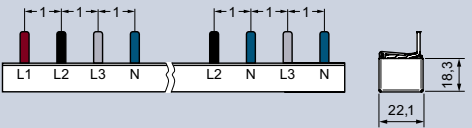


Fixed lengths, cannot be cut


Pin spacing in MW (1 MW = 18 mm)	Application	No. of MW	Length	Conductor cross-section	
				10 mm ²	16 mm ²
2-phase/1-phase + N <p>Ø 10 mm² Ø 16 mm²</p>	For 6 × 2 MW devices (2P)	12 MW	210 mm	Article No. 5ST3608	Article No. 5ST3638
3-phase, for MCBs with RCCB <p>Ø 10 mm² Ø 16 mm²</p>	For 8 MCBs 1P with 1 RCCB 3P+N, N right	12 MW	210 mm	Article No. 5ST3624	Article No. 5ST3654
<p>Ø 10 mm² Ø 16 mm²</p>	For 10 MCBs 1P with 1 RCCB 3P+N or for 1 RCCB 3P+N, 1 MCB 3P and 7 MCBs 1P	14 MW	249 mm	5ST3624-4	–
<p>Ø 10 mm² Ø 16 mm²</p>	For 6 MCBs 1P with 1 RCCB 3P+N or for 1 RCCB 3P+N, 1 MCB 3P and 3 MCBs 1P	10 MW	176 mm	5ST3624-1	–
<p>Ø 10 mm² Ø 16 mm²</p>	For 8 MCBs 1P with 1 RCCB 3P+N, N left	11 MW	192 mm	5ST3667	5ST3668
4-phase/3-phase + N <p>Ø 10 mm² Ø 16 mm²</p>	For 6 × 2MW devices (1P+N)	12 MW	215 mm	Article No. 5ST3623	Article No. 5ST3653
4-phase/3-phase + N, for MCBs with RCCB <p>Ø 10 mm² Ø 16 mm²</p>	For 1 RCCB 3P+N, 1 MCB 3P+N and 6 MCBs 1P	14 MW	248 mm	Article No. 5ST3724-4	–
<p>Ø 10 mm² Ø 16 mm²</p>	For 1 RCCB 3P+N, 1 MCB 3P+N and 3 MCBs 1P+N	14 MW	248 mm	5ST3725-4	–
<p>Ø 10 mm² Ø 16 mm²</p>	For 1 RCCB 3P+N, 1 MCB 3P and 3 MCBs 1P+N	13 MW	230 mm	5ST3725-3	–
<p>Ø 10 mm² Ø 16 mm²</p>	For 1 RCCB 3P+N and 5 MCBs 1P+N	14 MW	248 mm	5ST3625-4	–

Standard busbars

Can be cut

Pin spacing in MW (1 MW = 18 mm)	Application	No. of MW	Length	End caps included	Conductor cross-section	
					10 mm ²	16 mm ²
	For 2 MW units (2P/1+N)	12 MW	214 mm	■	Article No.	Article No.
		56 MW	1016 mm	–	5ST3734	5ST3704
	For RCBOs or MCBs 1P+N	56 MW	1000 mm	–	Article No.	Article No.
					5ST3770-2	5ST3770-3
	For 6 MCBs 1P+N with 1 RCCB 3P+N, N right	16 MW	292 mm	■	5ST3770-4	5ST3770-5

Accessories for busbars 5ST36 and 5ST37

End caps for 5ST37		
Version	Article No.	
For 2- and 3-phase busbars	5ST3750	
For 4-phase busbars	5ST3718	



5ST36 and 5ST37

Fixed lengths, cannot be cut, for devices with add-on 5SM6 arc fault detection units

Pin spacing in MW (1 MW = 18 mm)	Application	No. of MW	Length	End caps included	Color	Conductor cross-section 10 mm ²	Article No.
3-phase	For 5SM601.	12 MW	210 mm	–	Gray	10 mm ²	Article No.
							5ST3615-1

4

Can be cut, for devices with add-on 5SM6 arc fault detection units

Pin spacing in MW (1 MW = 18 mm)	Application	No. of MW	Length	End caps included	Color	Conductor cross-section 10 mm ²	Article No.
1-phase, straight	For 5SM601.	56 MW	1000 mm	–	Gray	10 mm ²	Article No.
					5ST3764-1		
1-phase, angled 45°	For 5SM601.	56 MW	1000 mm	–	Blue	10 mm ²	Article No.
	5ST3765-1						
2-phase/1-phase + N	For 5SM602. (1P+N)	56 MW	1000 mm	–	Gray	10 mm ²	Article No.
	5ST3735-1						
3-phase	For 5SM601.	60 MW	1050 mm	–	Gray	10 mm ²	Article No.
	5ST3740-1						
4-phase/3-phase + N	For 5SM602.	52 MW	950 mm	–	Gray	10 mm ²	Article No.
	5ST3746-1						

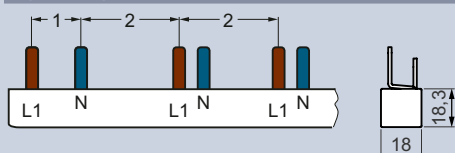
Standard busbars

5ST36 and 5ST37



Can be cut, for devices with add-on 5SM6 arc fault detection units and infeed via RCCB

Pin spacing in MW (1 MW = 18 mm)	Application	No. of MW	Length	End caps included	Color	Conductor cross-section 16 mm ²	Article No.
2-phase/1-phase + N	For RCCB 2P N-right and 5 AFDD (5SM601.) + compact device	12 MW	214 mm	■	Gray		5ST3772



4

Accessories

Terminals for infeed at side		Article No.
For conductors 6 ... 25 mm ²	Short	5ST3768
	Short, IP20	5ST3771-2
	Long	5ST3771-1
End caps		Article No.
For 1-phase busbars	Gray	5ST3766
	Blue	5ST3767
For 2 and 3-phase busbars		5ST3750
For 4-phase busbars		5ST3718
Touch protection		Article No.
For free connections, yellow (RAL 1004) 5 × 1 pin		5ST3655

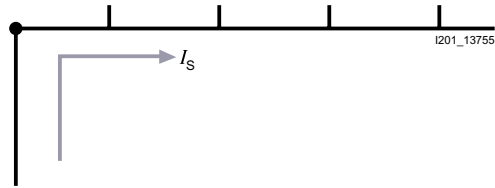
Compact busbars

General information



Infeed

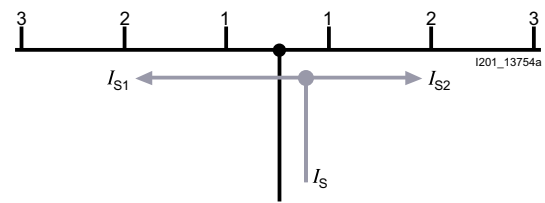
At the start or end of the busbar



Maximum busbar current I_s /phase

- Cross-section 10 mm²: 63 A
- Cross-section 16 mm²: 80 A

Along the busbar or midpoint infeed



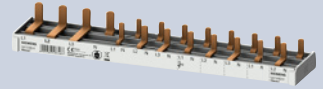
Maximum busbar current I_s /phase

- Cross-section 10 mm²: 100 A
- Cross-section 16 mm²: 130 A

Compact busbars

5ST36, fixed lengths, cannot be cut

Pin spacing in MW (1 MW = 18 mm)	Application	No. of MW	Length	End caps included	Conductor cross-section 10 mm ²
2-phase/1-phase + N, for infeed via RCCB 	For 1 × RCCB 1P+N and 5 × compact devices equipped with 5SM6 arc fault detection unit	12 MW	216 mm	■	Article No. 5ST3685-0
2-phase/1-phase + N 	For compact devices	6 MW 9 MW 12 MW	113 mm 166 mm 218 mm	■ ■ ■	Article No. 5ST3674-6 5ST3674-7 5ST3674-0
	For 6 × compact devices equipped with 5SM6 arc fault detection unit	12 MW	200 mm	■	5ST3676-0
4-phase/3-phase + N 	For compact devices	6 MW 9 MW 12 MW 14 MW	113 mm 166 mm 218 mm 254 mm	■ ■ ■ ■	Article No. 5ST3673-6 5ST3673-7 5ST3673-0 5ST3673-4
	For 6 × compact devices equipped with 5SM6 arc fault detection unit	11 MW	200 mm	■	5ST3675-0



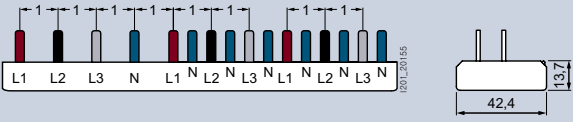
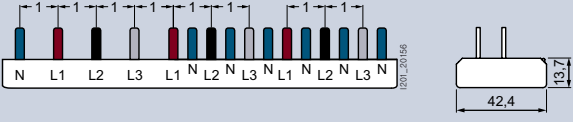

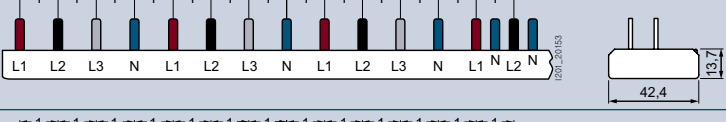
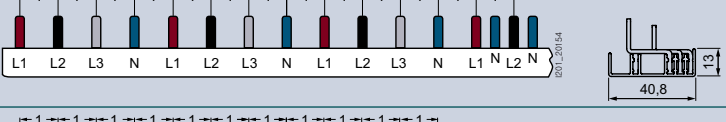
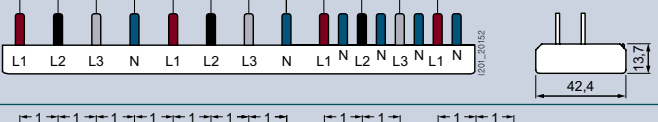
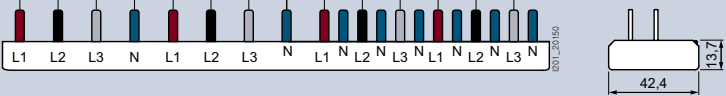
5ST37, can be cut

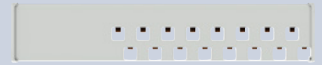
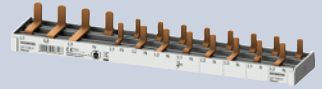


Pin spacing in MW (1 MW = 18 mm)	Application	No. of MW	Length	End caps included	Conductor cross-section 10 mm ²	Article No.
2-phase/1-phase + N, for infeed via RCCB						
	For 1 × RCCB 1P+N and 10 × compact devices	12 MW	215 mm	■		5ST3784-0
	For 1 × RCCB 1P+N (RCCB N left only) and 10 × compact devices	12 MW	215 mm	■		5ST3784-0KL
2-phase/1-phase + N						
	For compact devices	60 MW	1060 mm	–		5ST3774-0
	For compact devices equipped with 5SM6 arc fault detection unit	59 MW	1042 mm	–		5ST3776-0
	For compact devices equipped with auxiliary switch	59.5 MW	1055 mm	–		5ST3778-0
	For compact devices equipped with 5SM6 arc fault detection unit and auxiliary switch	58.5 MW	1036 mm	–		5ST3780-0
	For 2 MW units (MCBs or RCBOs) with mounted 5SM6 arc fault detection unit and auxiliary switch	54 MW	956 mm	–		5ST3786-0

Compact busbars

5ST37, can be cut

Pin spacing in MW (1 MW = 18 mm)	Application	No. of MW	Length	End caps included	Conductor cross-section 10 mm ²	Article No.
4-phase/3-phase + N, for infeed via RCCB						
	For 1 × RCCB 3P+N and 6 × compact devices	10 MW	181 mm	■		5ST3783-1
	For 1 × RCCB 3P+N and 8 × compact devices	12 MW	216 mm	■		5ST3783-0
	For 1 × RCCB 3P+N and 10 × compact devices	14 MW	251 mm	■		5ST3783-4
	For 1 × RCCB 3P+N (RCCB N left only) and 6 × compact devices	10 MW	181 mm	■		5ST3783-1KL
	For 1 × RCCB 3P+N (RCCB N left only) and 8 × compact devices	12 MW	216 mm	■		5ST3783-0KL
	For 1 × RCCB 3P+N, 1 × MCB 3P and 7 × compact devices	14 MW	253 mm	■		5ST3785-4
	For 1 × RCCB 3P+N, 2 × MCBs 3P+N and 12 × compact devices	24 MW	430 mm	■		5ST3790-1
	For 1 × RCCB 3P+N, 2 × MCBs 3P+N and 45 × compact devices	57 MW	1009 mm	–		5ST3790-2
	For 1 × RCCB 3P+N, 1 × MCB 3P+N and 4 × compact devices	12 MW	217 mm	■		5ST3795-0
	For 1 × RCCB 3P+N, 1 × MCB 3P+N and 6 × compact devices	14 MW	253 mm	■		5ST3795-4




Pin spacing in MW (1 MW = 18 mm)	Application	No. of MW	Length	End caps included	Conductor cross-section 10 mm ² Article No.
<p>4-phase/3-phase + N</p>	For compact devices	60 MW	1060 mm	–	5ST3773-0
	For compact devices equipped with 5SM6 arc fault detection unit	59 MW	1042 mm	–	5ST3775-0
	For compact devices equipped with auxiliary switch	59.5 MW	1055 mm	–	5ST3777-0

4

Accessories for 5ST3 compact busbars, versions that can and cannot be cut

Touch protection for 5ST3				
	Version	Color	Article No.	
	For free connections, for pins L1, N	Yellow (RAL1004)	5ST3655	
	For pins L2, L3	Yellow (RAL1004)	5ST3655-0HG	
End caps for 5ST3				
	Version	Color	Article No.	
	For 2- and 4-phase busbars	Gray	5ST3788-0	
Terminals, short, IP20				
	Version	For conductors	Infeed	Article No.
	Infeed terminal for connection of larger cross-section	Up to 25 mm ²	Lateral	5ST3771-2

An aerial photograph of a city skyline, likely Seattle, with a river and mountains in the background. Overlaid on the right side of the image are stylized circuit lines in blue and green, featuring diamond and circle nodes, representing an electrical network.

Electrical switching – on the safe side

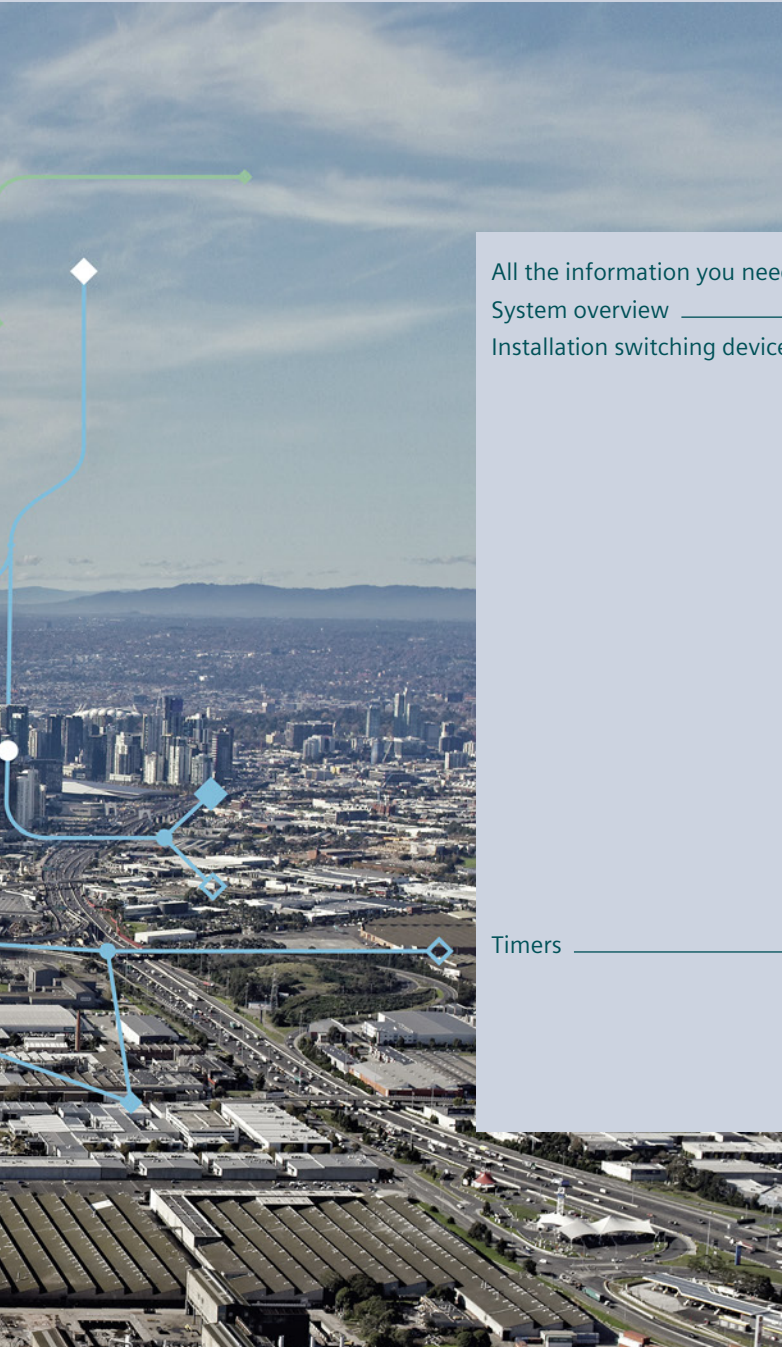
Control and automatic functions always employ electrical switching.

Remote control switches for pulse controls, switching relays, or Insta contactors switch electrical loads.

Our low-voltage circuit protection technology offers a wide variety of contact versions and rated currents for the different requirements of these devices.

Safety, convenience and energy savings – these characterize automatic switching.

Switching Devices



All the information you need	5/2
System overview	5/4
Installation switching devices	5/6
5TE8 control switches	5/6
5TE48 pushbuttons	5/8
5TE58 light indicators	5/10
5TE81/82 On/Off switches	5/12
5TL1 On/Off switches	5/14
5TE DC isolator	5/16
5TE busbars	5/18
5TT41 remote control switches	5/20
5TT44 remote control switches	5/24
5TT4 auxiliary switches	5/26
5TT42 switching relays	5/28
5TT50 Insta contactors	5/30
5TT58 Insta contactors	5/32
5TT5 auxiliary switches	5/36
5TT3 soft-starting devices	5/37
Timers	5/38
7LF4 digital time switches	5/38
7LF5 mechanical time switches	5/44
7LF6 timers for buildings	5/48
5TT3 timers for industrial applications	5/49

A multitude of additional information ...

Information + ordering

All the important things at a glance

For information about transfer switching equipment and load transfer switches, please visit our website www.siemens.com/switching-devices

Your product in detail

The relevant tender specifications can be found at www.siemens.com/tenderspecifications

Use our conversion tool for quick and easy conversion to Siemens products www.siemens.com/conversion-tool

Everything you need for your order

Refer to SiePortal to find an overview of your products (product catalog)

- Switching devices sie.ag/2m4eG5M

Direct forwarding to the individual products in SiePortal by clicking on the article number in the catalog or entering this web address incl. article number www.siemens.com/product_catalog_SIEP?Article No.

5

The fast track to the experts

Contact persons in your region

We offer a comprehensive portfolio of services. You can find your local contacts at www.siemens.com/lowvoltage/components/contact

You will find further information on services at www.siemens.com/service-offers

Competent expert advice on technical questions with a wide range of demand-optimized services for all our products and systems.

Assistance with technical queries is provided at www.siemens.com/support-request

... can be found in our online services

Commissioning + operation

Your product in detail

The SiePortal platform (knowledge base) provides detailed technical information

www.siemens.com/lowvoltage/product-support

- Operating instructions
- Certificates

Online Support app available for download from the [App Store](#) and [Play Store](#)

You will find further information at www.siemens.com/support-app

Provision of 3D data (step and u3d data formats)

- SiePortal (product catalog)
www.siemens.com/lowvoltage/product-catalog
- Image database
www.siemens.com/lowvoltage/picturedb

Engineering data for CAD or CAE systems are available in the CAx Download Manager at www.siemens.com/cax

Manuals

Manuals can be found in SiePortal at

www.siemens.com/lowvoltage/manuals

- Configuration Manual
– Switching devices (45315361)

Face-to-face or online training

Our training courses can be found at

www.siemens.com/sitrain-lowvoltage

- Basic principles of electrical engineering (WT-LVBGET)

Technical overview – Switching devices



The fast way to get you to our online services

This page provides you with comprehensive information and links on switching devices

www.siemens.com/lowvoltage/product-support (109769083)

System overview

Basic units and accessories

Installation switching devices



5TE8
control switches



5TE48
pushbuttons



5TE58
light indicators



5TE81/82, 5TL1
On/Off switches



5TE
DC isolators



5TE
busbars



5TT41, 5TT44
remote control switches



5TT4, 5TT5
auxiliary switches



5TT42
switching relays



5TT50, 5TT58
Insta contactors



5TT3
soft-starting devices

5

Accessories



Auxiliary switches
(AS)



Shunt trips
(ST)



Undervoltage
releases (UR)



Remote control
mechanisms
(RC mech.)



Handle locking
devices



LEDs



Caps/covers



Connectors

Timers



7LF4 digital
time switches



7LF5 mechanical
time switches



7LF6 timers for
buildings



5TT3 timers for
industrial applications

Accessories



Holders

Note:

You will find a detailed range of accessories with the basic units.

5TE8 control switches

	Control switches	Two-way switches	Group switches with center position
Rated operational current I_e per conducting path	20 A	20 A	20 A
Rigid conductor cross-section	1 ... 6 mm ²	1 ... 6 mm ²	1 ... 6 mm ²
Flexible conductor cross-section, with end sleeve	1 ... 6 mm ²	1 ... 6 mm ²	1 ... 6 mm ²



Contacts	U_e AC	Mounting width	Auxiliary switches		Auxiliary switches		Auxiliary switches
			Cannot be retrofitted	Mounted	Cannot be retrofitted	Mounted	Cannot be retrofitted
1 NO	48 V	1 MW	5TE8101-3	–	–	–	–
	230 V	1 MW	5TE8101	–	–	–	–
2 NO	400 V	1 MW	5TE8102	–	–	–	–
3 NO	400 V	1 MW	5TE8103	–	–	–	–
		1.5 MW	–	5TE8108	–	–	–
1 NO + 1 NC	400 V	1 MW	–	–	–	5TE8151	–
2 NO + 2 NC	400 V	1 MW	–	–	5TE8152	–	–
3 NO + 1 NC	400 V	1 MW	–	–	5TE8153	–	–
1 CO	230 V	1 MW	–	–	5TE8161	–	–
2 CO	400 V	1 MW	–	–	5TE8162	–	–
1 toggle switch	230 V	1 MW	–	–	–	–	5TE8141
2 toggle switches	400 V	1 MW	–	–	–	–	5TE8142

Further technical specifications

5TE8

Standards		
Standards		IEC/EN 60947-3 (VDE 0660-107), IEC/EN 60669-1 (VDE 0632-1)
Approvals		IEC/EN 60947-3 (VDE 0660-107), GB14048.3-2008 CCC
Supply		
Rated power dissipation P_v	Per pole	0.7 VA
Contacts		
Minimum contact load		10 V; 300 mA
Rated making/rated breaking capacity	At p.f. = 0.65	60 A/60 A
Rated short-time withstand current I_{cw} per conducting path at p.f. = 0.7	Up to 0.2 s	650 A
	Up to 0.5 s	400 A
	Up to 1 s	290 A
	Up to 3 s	170 A
Thermal rated current I_{th}		20 A
Electrical endurance/mechanical service life	Actuations	10000/25000
Safety		
Clearances	Open contacts	2 × > 2 mm
	Between the poles	> 7 mm
Creepage distances		> 7 mm
Sealable switch position		Yes
Separate handle locking device		Yes
Rated short-circuit making capacity I_{cm}		10 kA
Rated impulse voltage U_{imp}		> 5 kV
Connections		
Terminals	± Screw (Pozidriv)	PZ1
	Max. tightening torque	0.8 ... 1.0 Nm
Ambient conditions		
Permissible ambient temperature		–5 ... +40 °C
Resistance to climate at 95% relative humidity	Acc. to DIN 50015	45 °C

Accessories

Handle locking device



- To prevent undesired mechanical On/Off switching
- Sealable
- For padlock with max. 3 mm shackle

Article No.

5ST3801

Spacer



- Contour for modular devices with a mounting depth of 70 mm
- Can be snapped onto either side of the busbar for convenient cable routing
- Spacer is recommended for better heat dissipation

Article No.

5TG8240

Set of mixed caps






- For manual changing of the luminous plates for the control switches

Article No.

5TG8068

5TE48 pushbuttons

With/without LED

	Pushbuttons without maintained-contact function	Pushbuttons with maintained-contact function	Control pushbuttons with maintained-contact function or momentary-contact function
	Without LED	Without LED	With LED
Rated operational current I_e per conducting path	20 A	20 A	20 A
Rigid/flexible conductor cross-section	1 ... 6 mm ²	1 ... 6 mm ²	1 ... 6 mm ²
Max. cable length	Standard	Standard	Standard
			



Contacts	U_e AC	Mounting width						
1 NO	230 V	1 MW	–	–	–	–	1 × red	5TE4821
			–	–	–	–	–	–
2x 1 NO	400 V	1 MW	1 × green, 1 × blue	5TE4804	–	–	–	–
2 NO	400 V	1 MW	–	–	1 × gray	5TE4811	1 × red	5TE4823
1 NO + 1 NC	400 V	1 MW	1 × gray	5TE4800	1 × gray	5TE4810	–	–
			1 × red	5TE4805	–	–	1 × red	5TE4820
			1 × green	5TE4806	–	–	–	–
			1 × yellow	5TE4807	–	–	–	–
			1 × blue	5TE4808	–	–	–	–
2x (1 NO + 1 NC)	400 V	1 MW	–	–	–	–	–	–
2 NO + 2 NC	400 V	1 MW	1 × gray	5TE4801-2	1 × gray	5TE4811-2	–	–
3 NO + 1 NC	400 V	1 MW	1 × gray	5TE4802	1 × gray	5TE4812-1	–	–
3 NO + N	400 V	1 MW	–	–	1 × gray	5TE4812	–	–
2 NC	400 V	1 MW	–	–	–	–	1 × red	5TE4824
4 NC	400 V	1 MW	–	–	1 × gray	5TE4813	–	–
2 CO	400 V	1 MW	–	–	1 × gray	5TE4814	–	–

Further technical specifications

5TE48

Standards		
Standards	IEC/EN 60947-3 (VDE 0660-107), IEC/EN 60669-1 (VDE 0632-1)	
Approvals	IEC/EN 60947-3 (VDE 0660-107)	
Supply		
Rated power dissipation P_v	Per pole	0.6 VA
Contacts		
Minimum contact load	10 V; 300 mA	
Rated making/rated breaking capacity	At p.f. = 0.65	60 A/60 A
Rated short-time withstand current I_{cw} per conducting path at p.f. = 0.7	Up to 0.2 s	650 A
	Up to 0.5 s	400 A
	Up to 1 s	290 A
	Up to 3 s	170 A
Thermal rated current I_{th}	20 A	
Mechanical service life	Actuations	25000
Safety		
Clearances	Open contacts	2 × > 2 mm
	Between the poles	> 7 mm
Creepage distances	> 7 mm	
Rated impulse voltage U_{imp}	> 5 kV	
Connections		
Terminals	± Screw (Pozidriv)	PZ1
	Max. tightening torque	0.8 ... 1.0 Nm
Ambient conditions		
Permissible ambient temperature	–5 ... +40 °C	
Resistance to climate at 95% relative humidity	Acc. to DIN 50015	45 °C

Double pushbuttons with maintained-contact function and/or momentary-contact function

With LED		Without LED	With LED		
20 A		20 A	20 A		
1 ... 6 mm ²		1 ... 6 mm ²	1 ... 6 mm ²		
150 m		Standard	Standard		
					
1 × red	5TE4822	–	–	–	
1 × blue	5TE4822-1	–	–	–	
–	–	–	1 × green, 1 × red	5TE4840	
–	–	–	–	–	
–	–	–	–	–	
–	–	–	–	–	
–	–	1 × green, 1 × red	5TE4830	1 × green, 1 × red	5TE4841
–	–	–	–	–	
–	–	–	–	–	
–	–	1 × green, 1 × red	5TE4831	–	
–	–	–	–	–	
–	–	–	–	–	
–	–	–	–	–	
–	–	–	–	–	
–	–	–	–	–	
–	–	–	–	–	

Accessories

LEDs for manual spare part



I_e	U_e	Color	Article No.
0.4 A	12 ... 60 V AC/DC	White	5TG8056-0
		Red	5TG8056-1
		Yellow	5TG8056-2
		Green	5TG8056-3
	115 V AC/DC	Blue	5TG8056-4
		White	5TG8057-0
		Red	5TG8057-1
		Yellow	5TG8057-2
	230 V AC	Green	5TG8057-3
		Blue	5TG8057-4
		White	5TG8058-0
		Red	5TG8058-1
		Yellow	5TG8058-2
		Green	5TG8058-3
		Blue	5TG8058-4



Cap sets

- For manual changing of colored caps with or without lamps
- 1 set = 5 units

Color	Article No.
 Red, transparent	5TG8061
 Green, transparent	5TG8062
 Yellow, transparent	5TG8063
 Blue, transparent	5TG8064
 Black, non-transparent	5TG8065
 White, transparent	5TG8066
 Gray, non-transparent	5TG8060

Sets of mixed caps

- For manual changing of colored caps with or without lamps

Color	Article No.
 10 × each of red/green + 5 × each of yellow/blue/white	5TG8067
 1 × each of red/green/yellow	5TG8070

Color coding according to IEC 60073

Color	Safety of people/environment	Process state	System state
Red	Danger	Emergency	Faulty
Green	Safety	Normal	Normal
Yellow	Warning/Caution	Abnormal	Abnormal
Blue	Stipulation		
Black, white, gray	No special significance assigned		

5TE58 light indicators

With LED

5TE58 light indicators

	1.5 ... 6 mm ²	1.5 ... 6 mm ²
Rigid conductor cross-section	1.5 ... 6 mm ²	1.5 ... 6 mm ²
Flexible conductor cross-section, with end sleeve	1 ... 6 mm ²	1 ... 6 mm ²
Max. cable length	Standard	250 m



U _e AC	Mounting width				
230 V	1 MW	1 × red	5TE5800	1 × red	5TE5804
		1 × green, 1 × red	5TE5801		–
		3 × green	5TE5802		–
		1 × red, 1 × yellow, 1 × green	5TE5803		–
12 ... 60 V	1 MW	1 × red	5TE5810		–
		1 × green	5TE5810-1		–
		1 × green, 1 × red	5TE5811		–
		3 × green	5TE5812		–
		1 × red, 1 × yellow, 1 × green	5TE5812-1		–

Further technical specifications

5TE58

Standards		
Standards		DIN VDE 62094-1/A11
Supply		
Rated power dissipation P _v	LED	0.4 VA
Safety		
Clearances	Between the terminals	> 7 mm
Connections		
Terminals	± Screw (Pozidriv)	PZ1
	Max. tightening torque	0.8 ... 1.0 Nm
Ambient conditions		
Permissible ambient temperature		–5 ... +40 °C
Resistance to climate at 95% relative humidity	Acc. to DIN 50015	45 °C

Accessories

LEDs for manual spare part



I_e	U_e	Color	Article No.
0.4 A	12 ... 60 V AC/DC	White	5TG8056-0
		Red	5TG8056-1
		Yellow	5TG8056-2
		Green	5TG8056-3
		Blue	5TG8056-4
		115 V AC/DC	White
	Red	5TG8057-1	
	Yellow	5TG8057-2	
	Green	5TG8057-3	
	Blue	5TG8057-4	
	230 V AC	White	5TG8058-0
		Red	5TG8058-1
Yellow		5TG8058-2	
Green		5TG8058-3	
		Blue	5TG8058-4

Cap sets

- For manual changing of colored caps
- 1 set = 5 units

Color	Article No.
Red, transparent	5TG8061
Green, transparent	5TG8062
Yellow, transparent	5TG8063
Blue, transparent	5TG8064
White, transparent	5TG8066

Sets of mixed caps

- For manual changing of colored caps

Color	Article No.
10 × each of red/green + 5 × each of yellow/blue/white	5TG8067
1 × each of red/green/yellow	5TG8070

Color coding according to IEC 60073

Color	Safety of people/ environment	Process state	System state
Red	Danger	Emergency	Faulty
Green	Safety	Normal	Normal
Yellow	Warning/Caution	Abnormal	Abnormal
Blue	Stipulation		
Black, white, gray	No special significance assigned		

5TE81/82 On/Off switches

	5TE81 On/Off switches	5TE82 On/Off switches
Rated operational current I_e per conducting path	20 A	32 A
Rigid conductor cross-section	1.5 ... 6 mm ²	1.5 ... 6 mm ²
Flexible conductor cross-section, with end sleeve	1 ... 6 mm ²	1 ... 6 mm ²
		

Contacts	U_e AC	Mounting width	Auxiliary switches			Auxiliary switches		
			Can be retrofitted	Cannot be retrofitted	Mounted	Can be retrofitted	Cannot be retrofitted	Mounted
1 NO	230 V	1 MW	5TE8111	–	–	5TE8211	–	–
2 NO	400 V	1 MW	5TE8112	–	–	5TE8212	–	–
3 NO	400 V	1 MW	5TE8113	–	–	5TE8213	–	–
3 NO + N	400 V	1 MW	–	5TE8114	–	–	5TE8214	–
		1.5 MW	–	–	5TE8118	–	–	5TE8218

Further technical specifications

	5TE81	5TE82
Standards		
Standards	IEC/EN 60947-3 (VDE 0660-107), IEC/EN 60669-1	IEC/EN 60947-3 (VDE 0660-107)
Approvals	IEC/EN 60947-3 (VDE 0660-107)	
Supply		
Rated power dissipation P_v	Per pole	0.7 VA
Contacts		
Minimum contact load	10 V; 300 mA	
Rated making/rated breaking capacity	At p.f. = 0.65	60 A/60 A
Rated short-time withstand current I_{cw} per conducting path at p.f. = 0.7	Up to 0.2 s	650 A
	Up to 0.5 s	400 A
	Up to 1 s	290 A
	Up to 3 s	170 A
Thermal rated current I_{th}	20 A	32 A
Electrical endurance/mechanical service life	Actuations	10000/25000
Safety		
Clearances	Open contacts	2 × > 2 mm
	Between the poles	> 7 mm
Creepage distances	> 7 mm	
Rated short-circuit making capacity I_{cm}	10 kA	
Rated impulse voltage U_{imp}	> 5 kV	
Connections		
Terminals	± Screw (Pozidriv)	PZ1
	Max. tightening torque	0.8 ... 1.0 Nm
Ambient conditions		
Permissible ambient temperature	–5 ... +40 °C	
Resistance to climate at 95% relative humidity	Acc. to DIN 50015	45 °C

Accessories

Auxiliary switches (AS)



- For right-hand-side retrofitting with factory-fitted brackets

Contacts	Type	Article No.
1 NO + 1 NC	Standard	5ST3010
	For low power	5ST3013
	For low power (with diode)	5ST3013-0XX01
2 NO	Standard	5ST3011
	For low power	5ST3014
2 NC	Standard	5ST3012
	For low power	5ST3015
1 CO	Standard	5ST3016

Handle locking device



- To prevent undesired mechanical On/Off switching
- Sealable
- For padlock with max. 3 mm shackle

Article No.
5ST3801

Terminal cover



- For covering screw openings
- Sealable

Article No.
5ST3800

Spacer



- Contour for modular devices with a mounting depth of 70 mm
- Can be snapped onto either side of the busbar for convenient cable routing
- Spacer is recommended for better heat dissipation

Article No.
5TG8240

5TL1 On/Off switches



	Rated operational current I_e per conducting path				
	32 A	40 A	63 A	80 A	100 A
Rigid conductor cross-section	1 ... 35 mm ²	1 ... 35 mm ²	1 ... 35 mm ²	2.5 ... 50 mm ²	2.5 ... 50 mm ²
Flexible conductor cross-section, with end sleeve	1 ... 25 mm ²	1 ... 25 mm ²	1 ... 25 mm ²	2.5 ... 50 mm ²	2.5 ... 50 mm ²



Contacts	Rated operational voltage U_e AC	Mounting width	Gray handle	Gray handle	Gray handle	Red handle	Gray handle	Gray handle
1 NO	230 V	1 MW	5TL1132-0	5TL1140-0	5TL1163-0	5TL1163-1	5TL1180-0	5TL1191-0
2 NO	400 V	2 MW	5TL1232-0	5TL1240-0	5TL1263-0	5TL1263-1	5TL1280-0	5TL1291-0
3 NO	400 V	3 MW	5TL1332-0	5TL1340-0	5TL1363-0	5TL1363-1	5TL1380-0	5TL1391-0
4 NO	400 V	4 MW	5TL1432-0	5TL1440-0	5TL1463-0	–	5TL1480-0	5TL1491-0
3 NO + N	400 V	4 MW	5TL1632-0	5TL1640-0	5TL1663-0	5TL1663-1	5TL1680-0	5TL1691-0

Further technical specifications

		5TL1.32	5TL1.40	5TL1.63	5TL1.80	5TL1.91	5TL1.92
Standards							
Standards		IEC/EN 60947-3 (VDE 0660-107)					
Approvals		IEC/EN 60947-3 (VDE 0660-107)					
Supply							
Rated power dissipation P_v	Per pole, max.	0.7 VA	0.9 VA	2.2 VA	3.5 VA	5.5 VA	8.6 VA
Contacts							
Minimum contact load		24 V; 300 mA					
Rated making/rated breaking capacity AC-22A	At p.f. = 0.65	96 A/ 96 A	120 A/ 120 A	196 A/ 196 A	240 A/ 240 A	300 A/ 300 A	375 A/ 375 A
Rated short-time withstand current I_{cw} per conducting path at p.f. = 0.7 ¹⁾	Up to 0.2 s	760 A	950 A	1500 A	2700 A	3400 A	
	Up to 0.5 s	500 A	630 A	1000 A	1650 A	2100 A	
	Up to 1 s	400 A	500 A	800 A	1350 A	1700 A	
	Up to 3 s	280 A	350 A	560 A	800 A	1000 A	
Thermal rated current I_{th}		32 A	40 A	63 A	80 A	100 A	125 A
Electrical endurance/mechanical service life	Switching cycles	10000/ 20000	10000	5000	2000		
Rated power for the switching of resistive load including moderate overload AC-21	1-pole	5 kW	6.5 kW	10 kW	13 kW	16 kW	
	2-pole	9 kW	11 kW	18 kW	22 kW	28 kW	
	3/4-pole	15 kW		30 kW	39 kW	48 kW	
Safety							
Creepage distances		> 7 mm					
Clearances	Open contacts	> 7 mm					
	Between the poles	> 7 mm					
Rated short-circuit making capacity I_{cm} (in conjunction with fuse of the same rated operational current EN 60269 gL/gG)		10 kA					
Rated impulse voltage U_{imp}		6 kV					
Connections							
Terminals	± Screw (Pozidriv)	PZ2					
	Max. tightening torque	3.5 Nm					
Ambient conditions							
Permissible ambient temperature		–5 ... +40 °C					
Resistance to climate at 95% relative humidity	Acc. to DIN 50015	45 °C					

125 A	
	2.5 ... 50 mm ²
	2.5 ... 50 mm ²
	
Red handle	Gray handle
5TL1191-1	5TL1192-0
5TL1291-1	5TL1292-0
5TL1391-1	5TL1392-0
–	5TL1492-0
5TL1691-1	5TL1692-0

Accessories

Auxiliary switches (AS)



- For right-hand-side retrofitting with factory-fitted brackets

Contacts	Type	Article No.
1 NO + 1 NC	Standard	5ST3010
	For low power	5ST3013
	For low power (with diode)	5ST3013-0XX01
2 NO	Standard	5ST3011
	For low power	5ST3014
2 NC	Standard	5ST3012
	For low power	5ST3015
1 CO	Standard	5ST3016

Remote control mechanisms (RC mech.)



Type	U_e	Article No.
Basic	12 ... 30 V AC, 12 ... 48 V DC	5ST3053
	177 ... 270 V AC	5ST3054
Power	12 ... 30 V AC, 12 ... 48 V DC	5ST3055
	177 ... 270 V AC	5ST3056
Power with ARD	12 ... 30 V AC, 12 ... 48 V DC	5ST3057
	177 ... 270 V AC	5ST3058

Adapters for remote control mechanisms (RC mech.)



Mounting width	Article No.
1–2 MW	5ST3820-6
3–4 MW	5ST3820-7

Handle locking device



- To prevent undesired mechanical On/Off switching
- Sealable
- For padlock with max. 3 mm shackle

Article No.
5ST3806

Terminal cover



- For covering screw openings
- Sealable

Article No.
5ST3800

Spacer



- Contour for modular devices with a mounting depth of 70 mm
- Can be snapped onto either side of the busbar for convenient cable routing
- Spacer is recommended for better heat dissipation

Article No.
5TG8240

Phase connectors



- For easy wiring in various circuit versions and bus mountings
- As a support terminal for conductors from 2.5 to 50 mm²

Number of poles	I_e	U_e AC	Mounting width	Article No.
1-pole	125 A	230 V	1 MW	5TL1192-4

N conductor connectors



- For easy wiring in various circuit versions and bus mountings
- As a support terminal for N conductors from 2.5 to 50 mm² with blue color marking

Number of poles	I_e	U_e AC	Mounting width	Article No.
1-pole	125 A	230 V	1 MW	5TL1192-3

5TE DC isolator

Can be used as switch disconnectors according to EN 60947-3

Rated operational current I_e
63 A

Rigid conductor cross-section 0.75 ... 35 mm²
Flexible conductor cross-section, with end sleeve 0.75 ... 25 mm²



Contacts	Max. operational voltage U_{max} DC	Mounting width	Auxiliary switches can be retrofitted
4 NO	1000 V	4 MW	5TE2515-1

Further technical specifications

Standards		
Standards	IEC/EN 60947-3; GB14048.3-2008 CCC	
Supply		
Rated operational voltage U_e	For 4 poles in series	880 V DC
Rated power dissipation P_v	Per pole, max.	4.4 W
Contacts		
Minimum contact load	24 V; 300 mA	
Rated short-time withstand current I_{cw}	1000 V DC, 4-pole	760 A
Electrical endurance/mechanical service life	Actuations	5000/10000
Safety		
Rated short-circuit making capacity I_{cm}	1000 V DC, 4-pole	500 A
Rated impulse voltage U_{imp}	> 5 kV	
Overvoltage category	At U = 440 ... 880 V	II
	At U = 1000 V	I
Utilization category	DC-21B	
Connections		
Terminals	± Screw (Pozidriv)	PZ2
	Max. tightening torque	2.5 ... 3 Nm
Ambient conditions		
Permissible ambient temperature	-25 ... +40 °C	
Resistance to climate at 95% relative humidity	Acc. to DIN 50015	45 °C

Accessories

Auxiliary switches (AS)



- For right-hand-side retrofitting with factory-fitted brackets

Contacts	Type	Article No.
1 NO + 1 NC	Standard	5ST3010
	For low power	5ST3013
	For low power (with diode)	5ST3013-0XX01
2 NO	Standard	5ST3011
	For low power	5ST3014
2 NC	Standard	5ST3012
	For low power	5ST3015
1 CO	Standard	5ST3016

Shunt trips (ST)



Rated operational voltage U_e	Article No.
110 ... 415 V AC, 110 ... 220 V DC	5ST3030
24 ... 48 V AC/DC	5ST3031
12 V AC/DC	5ST3031-0XX01

Undervoltage releases (UR)

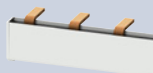


Type	Rated operational voltage U_e	Article No.
With integrated auxiliary switch	230 V AC	5ST3040
	110 V DC	5ST3041
	24 V DC	5ST3042
Without integrated auxiliary switch	230 V AC	5ST3043
	110 V DC	5ST3044
	24 V DC	5ST3045

5TE busbars

For modular installation devices

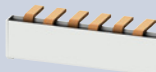
1-phase busbar



- For all 5TE8 switches, 20 A and 32 A
- For the cutting of unused terminal lugs and to ensure insulation clearances if one device terminal is to be supplied separately despite being mounted on the bus
- Infeed to unit terminal with conductor cross-section of 6 mm² up to 32 A
- Can be mounted from either top or bottom, in the front or rear terminal area
- An end cap is not required on 1-phase busbars

Length	Division	Article No.
210 mm	12 MW version with 1 MW modular clearance	5TE9100

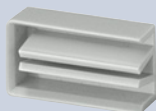
2-phase busbar



- For all 5TE8 switches, 20 A and 32 A
- Infeed to unit terminal with conductor cross-section of 6 mm² up to 32 A
- Can be mounted from either top or bottom, in the front and/or rear terminal area, thus allowing realization of a 4-wire connection using 2 2-phase busbars
- Both copper conductors of the 2-phase busbar are insulated together

Length	Division	Article No.
220 mm	12 MW version each with 1 MW modular clearance, phases offset by 0.5 MW	5TE9101

End caps for 2-phase busbars



- End caps for 5TE9101 2-phase busbars to maintain insulation clearances when the bar is being cut
- 1 set = 10 units

Article No.
5TE9102

5TT41 remote control switches

Rated current 16 A

Rated operational current I_e
16 A

Rigid conductor cross-section
Flexible conductor cross-section, with end sleeve

1 ... 6 mm²

1 ... 6 mm²



Contacts	U_e	U_c AC	U_c DC	Mounting width		Auxiliary switches can be retrofitted		
				1 MW	2 MW			
1 NO	250 V	230 V	–	■	–	5TT4101-0		
		115 V	–	■	–	5TT4101-1		
		24 V	–	■	–	5TT4101-2		
		12 V	–	■	–	5TT4101-3		
		8 V	–	■	–	5TT4101-4		
		–	110 V	■	–	5TT4111-1		
		–	24 V	■	–	5TT4111-2		
		–	12 V	■	–	5TT4111-3		
		1 NO + 1 NC	250 V	230 V	–	■	–	5TT4105-0
				115 V	–	■	–	5TT4105-1
24 V	–			■	–	5TT4105-2		
12 V	–			■	–	5TT4105-3		
8 V	–			■	–	5TT4105-4		
–	110 V			■	–	5TT4115-1		
–	24 V			■	–	5TT4115-2		
–	12 V			■	–	5TT4115-3		
2 NO	400 V			230 V	–	■	–	5TT4102-0
				115 V	–	■	–	5TT4102-1
		24 V	–	■	–	5TT4102-2		
		12 V	–	■	–	5TT4102-3		
		8 V	–	■	–	5TT4102-4		
		–	110 V	■	–	5TT4112-1		
		–	24 V	■	–	5TT4112-2		
		–	12 V	■	–	5TT4112-3		
		3 NO	400 V	230 V	–	–	■	5TT4103-0
				24 V	–	–	■	5TT4103-2
4 NO	400 V	230 V	–	–	■	5TT4104-0		
		24 V	–	–	■	5TT4104-2		
		–	110 V	–	■	5TT4114-1		
		24 V	–	–	■	5TT4114-2		

Further technical specifications

5TT4101	5TT4111	5TT4103
5TT4102	5TT4112	5TT4104
5TT4105	5TT4115	5TT4114

Standards		
Standards	IEC 60669-1, IEC 60669-2, IEC 60669-3, EN 60669 (VDE 0632), EN 60669-2-2, EN 60669-2-2/A1	
Approvals	VDE	
Supply		
Rated operational current I_e	At p.f. = 0.6 ... 1 (AC-15)	16 A
Primary operating range	$0.8 \dots 1.1 \times U_c$	
Rated frequency f_c	50 Hz	
Rated power dissipation P_v	Magnet coil, only pulse	4.5 W/7 VA
	Per pole, max.	1.2 W
9 W/13 VA		
Contacts		
Contact gap	> 1.2 mm	
Minimum contact load	10 V; 100 mA	
Electrical endurance at I_e/U_e , p.f. = 0.6, incandescent lamp load 600 W	Operating cycles	50000
Incandescent lamp load (switching of incandescent lamps for 15000 switching cycles)	At AC-5b (230 V)	1200 W
Glow lamp load at 230 V		5 mA
	With 1 5TT4920 compensator	25 mA
	With 2 5TT4920 compensators	45 mA
Minimum pulse duration	50 ms	
Safety		
Different phases between magnet coil and contact	Permissible	
Clearances	Between magnet coil and contact	> 6 mm
Creepage distances	Between magnet coil and contact	> 6 mm
Rated impulse voltage U_{imp}	4 kV	
Function		
Manual operation	Yes	
Switching position indication	Yes	
Connections		
Terminals	± Screw (Pozidriv)	PZ1
	Max. tightening torque	0.8 ... 1 Nm
Ambient conditions		
Permissible ambient temperature	-10 ... +40 °C	
Resistance to climate at 95% relative humidity	Acc. to DIN 50015	35 °C
Degree of protection	Acc. to EN 60529	IP20, with connected conductors

5

Accessories

Auxiliary switches



- One device per remote control switch can be retrofitted

Contacts	Type	I_e	U_e	Mounting width	Article No.
1 CO	Standard	5 A	250 V AC	0.5 MW	5TT4900
	For low power	0.1 A	30 V AC/DC	0.5 MW	5TT4901

Compensator







- For increasing the glow lamp load by 20 mA

U_e	Mounting width	Article No.
250 V AC	1 MW	5TT4920

5TT41 remote control switches

For special applications, rated current 16 A

				Remote control switches with central On/Off switching	Remote control switches with central and group On/Off switching
Rigid conductor cross-section				1 ... 6 mm ²	1 ... 6 mm ²
Flexible conductor cross-section, with end sleeve				1 ... 6 mm ²	1 ... 6 mm ²
					
Contacts	U _e	U _c AC	Mounting width	Auxiliary switches cannot be retrofitted	Auxiliary switches cannot be retrofitted
1 NO	250 V	230 V	1.5 MW	5TT4121-0	5TT4151-0
		24 V	1.5 MW	5TT4121-2	5TT4151-2
2 NO	400 V	230 V	1.5 MW	5TT4122-0	5TT4152-0
		24 V	1.5 MW	5TT4122-2	5TT4152-2
3 NO	400 V	230 V	2.5 MW	5TT4123-0	–
1 NO + 1 NC	250 V	115 V	1.5 MW	5TT4125-0	–

				Series remote control switch contact sequence 1 – 2 – 1+2 – 0	Shutter/blind remote control switch contact sequence 1 – 0 – 2 – 0
Rigid conductor cross-section				1 ... 6 mm ²	1 ... 6 mm ²
Flexible conductor cross-section, with end sleeve				1 ... 6 mm ²	1 ... 6 mm ²
					
Contacts	U _e	U _c AC	Mounting width	Auxiliary switches cannot be retrofitted	Auxiliary switches cannot be retrofitted
2 NO	250 V	230 V	1 MW	5TT4132-0	5TT4142-0
		24 V	1 MW	–	5TT4142-2
		12 V	1 MW	5TT4132-3	5TT4142-3

Further technical specifications

		5TT412 5TT415	5TT413 5TT414
Standards			
Standards		EN 60669-1 (VDE 0632-1)/EN 60669-1/A1/A2 EN 60669-2-2 (VDE 0632-2-2)/EN 60669-2-2	
Approvals		VDE	
Supply			
Rated operational current I_e	At p.f. = 0.6 ... 1 (AC-15)	16 A	
Primary operating range		0.8 ... 1.1 × U_c	
Rated frequency f_c		50 Hz	
Rated power dissipation P_v	Magnet coil, only pulse	4.5 W/7 VA	
	Per pole, max.	1.2 W	
Contacts			
Contact gap		> 1.2 mm	
Minimum contact load		10 V; 100 mA	
Electrical endurance at I_e/U_e , p.f. = 0.6, incandescent lamp load 600 W	Operating cycles	50000	
Incandescent lamp load (switching of incandescent lamps for 15000 switching cycles)	At AC-5b (230 V)	1200 W	
Glow lamp load at 230 V		5 mA	
	With 1 5TT4920 compensator	25 mA	
	With 2 5TT4920 compensators	45 mA	
Minimum pulse duration		50 ms	
Safety			
Different phases between magnet coil and contact		Permissible	
Clearances	Between magnet coil and contact	> 6 mm	
Creepage distances	Between magnet coil and contact	> 6 mm	
Rated impulse voltage U_{imp}		4 kV	
Function			
Manual operation		Yes	
Switching position indication		Yes	–
Connections			
Terminals	± Screw (Pozidriv)	PZ1	
	Max. tightening torque	0.8 ... 1 Nm	
Ambient conditions			
Permissible ambient temperature		–10 ... +40 °C	
Resistance to climate at 95% relative humidity	Acc. to DIN 50015	35 °C	
Degree of protection	Acc. to EN 60529	IP20, with connected conductors	

Accessories

Auxiliary switches



- One device per remote control switch can be retrofitted

Contacts	Type	I_e	U_e	Mounting width	Article No.
1 CO	Standard	5 A	250 V AC	0.5 MW	5TT4900
	For low power	0.1 A	30 V AC/DC	0.5 MW	5TT4901

Compensator




- For increasing the glow lamp load by 20 mA

U_e	Mounting width	Article No.
250 V AC	1 MW	5TT4920

5TT44 remote control switches

Rated current 20 A – 63 A

	Rated operational current I_e				
	20 A	25 A	32 A	40 A	63 A
Rigid conductor cross-section	1 ... 10 mm ²	1 ... 10 mm ²	1 ... 10 mm ²	2.5 ... 25 mm ²	2.5 ... 25 mm ²
Flexible conductor cross-section, with end sleeve	1 ... 10 mm ²	1 ... 10 mm ²	1 ... 10 mm ²	2.5 ... 25 mm ²	2.5 ... 25 mm ²






Contacts	U_e	U_c AC	U_c DC	Mounting width					
For AC applications – auxiliary switches can be retrofitted									
1 NO + 1 NC	440 V	230 V	–	1 MW	5TT4405-0	5TT4425-0	5TT4455-0	–	–
				2 MW	–	–	–	5TT4465-0	5TT4475-0
		24 V	–	1 MW	5TT4405-2	5TT4425-2	5TT4455-2	–	–
				2 MW	–	–	–	5TT4465-2	5TT4475-2
1 CO	250 V	230 V	–	1 MW	5TT4407-0	–	–	–	–
		24 V	–	1 MW	5TT4407-2	–	–	–	–
2 NO	440 V	230 V	–	1 MW	5TT4402-0	5TT4422-0	5TT4452-0	–	–
				2 MW	–	–	–	5TT4462-0	5TT4472-0
		24 V	–	1 MW	5TT4402-2	5TT4422-2	5TT4452-2	–	–
				2 MW	–	–	–	5TT4462-2	5TT4472-2
2 CO	440 V	230 V	–	2 MW	–	5TT4428-0	5TT4458-0	5TT4468-0	5TT4478-0
		24 V	–	2 MW	–	5TT4428-2	5TT4458-2	5TT4468-2	5TT4478-2
4 NO	440 V	230 V	–	2 MW	–	5TT4424-0	5TT4454-0	–	–
				4 MW	–	–	–	5TT4464-0	5TT4474-0
		24 V	–	2 MW	–	5TT4424-2	5TT4454-2	–	–
				4 MW	–	–	–	5TT4464-2	5TT4474-2
2 NO + 2 NC	440 V	230 V	–	2 MW	–	5TT4426-0	5TT4456-0	–	–
				4 MW	–	–	–	5TT4466-0	5TT4476-0
		24 V	–	2 MW	–	5TT4426-2	5TT4456-2	–	–
				4 MW	–	–	–	5TT4466-2	5TT4476-2
For DC applications									
1 NO	250 V	–	24 V	1 MW	5TT4411-5	5TT4431-5	5TT4451-5	–	–
2 NO	440 V	–	24 V	1 MW	5TT4412-5	5TT4432-5	5TT4452-5	–	–
1 NO + 1 NC	440 V	–	24 V	1 MW	5TT4415-5	5TT4435-5	5TT4455-5	–	–
1 CO	250 V	–	24 V	1 MW	5TT4417-5	5TT4437-5	5TT4457-5	–	–

Further technical specifications

		5TT440	5TT442	5TT445	5TT446	5TT447
Standards						
Standards		IEC 60669-2-2			EN 60669-1 (VDE 0632-1)/EN 60669-1/A1/A2 EN 60669-2-2 (VDE 0632-2-2)/EN 60669-2-2	
Approvals		CE				
Supply						
Rated operational current I_e	At p.f. = 0.6 ... 1 (AC-15)	20 A	25 A	32 A	40 A	63 A
Rated frequency f_c		50/60 Hz				
Rated power dissipation P_v	Magnet coil, "On" pulse	13 W/18 VA			12 W/26 VA	
	Per pole, max.	1.5 W	2 W	3 W	3.5 W	
Rated operational power (AC-3)	1-phase, at 230 V	0.5 kW	0.75 kW	1.1 kW	2.2 kW	4 kW
	3-phase, at 230 V	1.5 kW	2.2 kW	3 kW	5.5 kW	11 kW
	3-phase, at 400 V	3 kW	4 kW	5.5 kW	11 kW	18.5 kW
Contacts						
Contact gap		> 3 mm				
Minimum contact load AC		10 V; 100 mA				
Electrical endurance at I_e/U_e , p. f. = 0.6, incandescent lamp load 600 W	Operating cycles	50000				
Incandescent lamp load (switching of incandescent lamps for 15000 switching cycles)	At AC-5b (230 V)	4400 W	5500 W	7000 W	8800 W	13800 W
Max. switching speed	In switching cycles per hour	600 h ⁻¹	450 h ⁻¹	360 h ⁻¹		
Safety						
Different phases between magnet coil and contact		Permissible				
Rated impulse voltage U_{imp}		3 kV				
Function						
Manual operation		Yes				
Switching position indication		Yes				
Connections						
Terminals	± Screw (Pozidriv)	Coil: PZ1, contact: PZ2				
	Max. tightening torque	Coil: 0.6 Nm, contact: 1.2 Nm			Coil: 0.6 Nm, contact: 2 Nm	
Coil conductor cross-sections		1 ... 4 mm ²				
Ambient conditions						
Permissible ambient temperature	For operation/for storage	-25 ... +55 °C/-30 ... +80 °C				
Resistance to climate at 95% relative humidity	Acc. to DIN 50015	55 °C				
Degree of protection	Acc. to EN 60529	IP20				
Mounting position		Any (not upside down)				

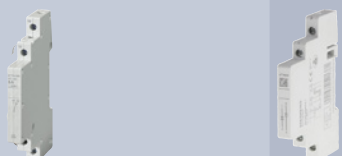
Accessories

Auxiliary switch						
	Contacts	U_e	I_e	Mounting width	Article No.	
	1 NO + 1 NC	250 V AC	16 A	0.5 MW	5TT4930	
Central switch, central with diode						
	<ul style="list-style-type: none"> For central function (no auxiliary switch) 			U_e	Mounting width	Article No.
		250 V AC		0.5 MW	5TT4931	
Central switch, group with several diodes						
	<ul style="list-style-type: none"> For group function (no auxiliary switch) 			U_e	Mounting width	Article No.
		250 V AC		0.5 MW	5TT4932	

5TT4 auxiliary switches

For 5TT4 remote control switches

	Auxiliary switches for 5TT41	Auxiliary switches for 5TT44
Rigid conductor cross-section	0.5 ... 2.5 mm ²	1 ... 4 mm ²
Flexible conductor cross-section, with end sleeve	0.5 ... 2.5 mm ²	1 ... 4 mm ²



Contacts	Type	I_e	U_e	Mounting width		
Auxiliary switches						
1 NO + 1 NC	Standard	16 A	250 V AC	0.5 MW	–	5TT4930
1 CO	Standard	5 A	250 V AC	0.5 MW	5TT4900	–
	For low power	0.1 A	30 V AC/DC	0.5 MW	5TT4901	–
Auxiliary switches, central with diode for central function						
			250 V AC	0.5 MW	–	5TT4931
Auxiliary switches, group with several diodes for group function						
			250 V AC	0.5 MW	–	5TT4932

Further technical specifications		Auxiliary switches for 5TT41		Auxiliary switches for 5TT44		
		5TT4900	5TT4901	5TT4930	5TT4931	5TT4932
Standards						
Standards		EN 60947-1 (VDE 0660 Part 100) EN 60947-5-1 (VDE 0660 Part 200)		IEC/EN 60947-5-1		
Approvals		–		CE, EAC		
Supply						
Rated operational current I_e	At p.f. = 0.6 ... 1 (AC-15)	16 A		4 A	–	
Rated frequency f_c		–		50/60 Hz		
Rated power dissipation P_v	Per pole, max.	–		0.3 W		
Contacts						
Contact gap		< 1.2 mm		> 3 mm		
Minimum contact load		5 V; 1 mA		12 V; 5 mA		
Electrical endurance at $I_e U_{e,r}$, p.f. = 0.6, incandescent lamp load 600 W	Operating cycles	–		100000	–	
Safety						
Clearances	Between magnet coil and contact	> 6 mm		–		
Creepage distances	Between magnet coil and contact	> 6 mm		–		
Rated impulse voltage U_{imp}		1 kV		1 kV		
Pushbutton malfunction protected against continuous voltage, safe due to design		Yes		–		
Function						
Manual operation		–		No		
Switching position indication		–		No		
Connections						
Terminals	± Screw (Pozidriv)	PZ1		PZ1		
	Max. tightening torque	0.5 Nm		0.8 Nm		
Ambient conditions						
Permissible ambient temperature	For operation/for storage	–10 ... +40 °C/–10 ... +40 °C		–25 ... +70 °C/–30 ... +80 °C		
Resistance to climate at 95% relative humidity	Acc. to DIN 50015	35 °C		55 °C		
Degree of protection	Acc. to EN 60529	IP20, with connected conductors		IP20		
Mounting position		Any		Any (not upside down)		

Accessories

Compensator



- For increasing the glow lamp load by 20 mA

U_e	Mounting width	Article No.
250 V AC	1 MW	5TT4920

5TT42 switching relays

Rated current 16 A

Rated operational current I_e
16 A

Rigid conductor cross-section 1 ... 6 mm²
Flexible conductor cross-section, with end sleeve 1 ... 6 mm²



Contacts	U_e	U_c AC	U_c DC	Mounting width	
1 NO	250 V	230 V	–	1 MW	5TT4201-0
		115 V	–	1 MW	5TT4201-1
		24 V	–	1 MW	5TT4201-2
		12 V	–	1 MW	5TT4201-3
		8 V	–	1 MW	5TT4201-4
2 NO	400 V	230 V	–	1 MW	5TT4202-0
		115 V	–	1 MW	5TT4202-1
		24 V	–	1 MW	5TT4202-2
		12 V	–	1 MW	5TT4202-3
		8 V	–	1 MW	5TT4202-4
4 NO	400 V	230 V	–	1 MW	5TT4204-0
		115 V	–	1 MW	5TT4204-1
		24 V	–	1 MW	5TT4204-2
		12 V	–	1 MW	5TT4204-3
		8 V	–	1 MW	5TT4204-4
1 NO + 1 NC	400 V	230 V	–	1 MW	5TT4205-0
		115 V	–	1 MW	5TT4205-1
		24 V	–	1 MW	5TT4205-2
		12 V	–	1 MW	5TT4205-3
		8 V	–	1 MW	5TT4205-4
1 CO	250 V	230 V	–	1 MW	5TT4206-0
		115 V	–	1 MW	5TT4206-1
		24 V	–	1 MW	5TT4206-2
		12 V	–	1 MW	5TT4206-3
		8 V	–	1 MW	5TT4206-4
2 CO	400 V	230 V	–	1 MW	5TT4207-0
		115 V	–	1 MW	5TT4207-1
		24 V	–	1 MW	5TT4207-2
		12 V	–	1 MW	5TT4207-3
		8 V	–	1 MW	5TT4207-4
		–	110 V	1 MW	5TT4217-1
		–	30 V	1 MW	5TT4217-6
		–	24 V	1 MW	5TT4217-2
		–	12 V	1 MW	5TT4217-3
		–	–	–	–

Further technical specifications		5TT4201-	5TT4202-	5TT4204-	5TT4205-	5TT4206-	5TT4207-	5TT4217-
Standards								
Standards		EN 60947-5-1, EN 60669-2-2						
Approvals		VDE, CCC						
Supply								
Rated operational current I_e		At p.f. = 0.6 ... 1		16 A				
Primary operating range		0.8 ... $1.1 \times U_c$						
Rated frequency f_c		50 Hz						
Rated power dissipation P_v		Magnet coil		2.4 W 3.0 VA		4.8 W 6.0 VA		2.4 W 3.0 VA
		Per pole, max.		1.0 W				
Per pole, max.		1.0 W						
Contacts								
Contact gap		> 1.2 mm						
Minimum contact load		10 V AC; 100 mA						
Electrical endurance at $I_e/U_{e,r}$ p.f. = 0.6, incandescent lamp load 600 W		Operating cycles		50000				
Safety								
Different phases between magnet coil and contact		Permissible						
Safe separation		> 6 mm						
Rated impulse voltage U_{imp}		4 kV						
Function								
Manual operation		Yes						
Connections								
Terminals		± Screw (Pozidriv)		PZ1				
		Max. tightening torque		0.8 ... 1 Nm				
Ambient conditions								
Permissible ambient temperature		-10 ... +40 °C						
Resistance to climate at 95% relative humidity		Acc. to DIN 50015		35 °C				
Degree of protection		Acc. to EN 60529		IP20, with connected conductors				

Accessories

Spacer



- Contour for modular devices with a mounting depth of 70 mm
- Can be snapped onto either side of the busbar for convenient cable routing
- Spacer is recommended for better heat dissipation

Article No.

5TG8240

5TT50 Insta contactors

AC/DC technology – hum-free Insta contactors

	Rated operational current I_e			
	20 A	25 A	40 A	63 A
Main connection conductor cross-section, solid	1.0 ... 10 mm ²	1.5 ... 25 mm ²	1.5 ... 25 mm ²	1.5 ... 25 mm ²
Main connection conductor cross-section, stranded with end sleeve	1.0 ... 6 mm ²	1.5 ... 16 mm ²	1.5 ... 16 mm ²	1.5 ... 16 mm ²
Main connection conductor cross-section, AWG	16 ... 8	16 ... 4	16 ... 4	16 ... 4



Contacts	U_e	U_c AC	U_c DC	Mounting width				
Insta contactors with manual switch								
2 NO	230 V	230 V	220 V	1 MW	5TT5000-0	–	–	–
		24 V	24 V	1 MW	5TT5000-2	–	–	–
4 NO	400 V	230 V	220 V	2 MW	–	5TT5030-0	–	–
				3 MW	–	–	5TT5040-0	5TT5050-0
		24 V	24 V	2 MW	–	5TT5030-1	–	–
				3 MW	–	5TT5030-2	–	–
2 NC	230 V	230 V	220 V	1 MW	5TT5002-0	–	–	
		24 V	24 V	1 MW	5TT5002-2	–	–	
4 NC	400 V	230 V	220 V	2 MW	–	5TT5033-0	–	–
				3 MW	–	–	5TT5043-0	–
		24 V	24 V	2 MW	–	5TT5033-2	–	–
				3 MW	–	–	5TT5043-2	–
1 NO + 1 NC	230 V	230 V	220 V	1 MW	5TT5001-0	–	–	
				1 MW	5TT5001-2	–	–	
2 NO + 2 NC	400 V	230 V	220 V	2 MW	–	5TT5032-0	–	–
				3 MW	–	–	5TT5042-0	5TT5052-0
		24 V	24 V	2 MW	–	5TT5032-2	–	–
				3 MW	–	–	5TT5042-2	5TT5052-2
3 NO + 1 NC	400 V	230 V	220 V	2 MW	–	5TT5031-0	–	–
				3 MW	–	–	5TT5041-0	5TT5051-0
		24 V	24 V	2 MW	–	5TT5031-2	–	–
				3 MW	–	–	5TT5041-2	5TT5051-2
Insta contactors with O//Automatic								
2 NO	230 V	230 V	220 V	1 MW	5TT5000-6	–	–	
		24 V	24 V	1 MW	5TT5000-8	–	–	
4 NO	400 V	230 V	220 V	2 MW	–	5TT5030-6	–	
		24 V	24 V	2 MW	–	5TT5030-8	–	
1 NO + 1 NC	230 V	230 V	220 V	1 MW	5TT5001-6	–	–	
		24 V	24 V	1 MW	5TT5001-8	–	–	
3 NO + 1 NC	400 V	230 V	220 V	2 MW	–	5TT5031-6	–	
		24 V	24 V	2 MW	–	5TT5031-8	–	

Note:

Provision must be made for spacers to ensure heat dissipation.

See Configuration Manual – Switching devices www.siemens.com/lowvoltage/manuals (45315361).

Accessories

Spacer



- Contour for modular devices with a mounting depth of 70 mm
- Can be snapped onto either side of the busbar for convenient cable routing
- Spacer is recommended for better heat dissipation

Article No.

5TG8240


Further technical specifications


		5TT500	5TT503	5TT504	5TT505
Standards					
Standards		EN 60947-4-1; EN 60947-5-1; EN 61095			
Approvals		UL 508; UL File No. E303328			
Supply					
Rated operational current I_e	AC-1/AC-7a, NO contacts/NC contacts	20 A/20 A	25 A/25 A	40 A/40 A	63 A/63 A
	AC-3/AC-7b, NO contacts/NC contacts	9 A/6 A	8.5 A/8.5 A	22 A/22 A	30 A/30 A
Primary operating range		0.85 ... 1.1 × U_c			
Rated frequency f_c at AC		50/60 Hz			
Rated power dissipation P_v	Pick-up power (without manual switch or with manual switch in "I" position)	2.1 VA/2.1 W	2.6 VA/2.6 W	5 VA/5 W	
	Pick-up power (with manual switch in "AUTO" position)	2.1 VA/4.1 W	2.6 VA/2.6 W	5 VA/5 W	
	Holding power	2.1 VA/2.1 W	2.6 VA/2.6 W	5 VA/5 W	
	Per contact AC-1/AC-7a	1.7 VA	2.2 VA	4 VA	8 VA
Contacts					
Contact gap (NO contacts)	Min.	3.6 mm			
Minimum switching capacity	(= minimum contact load)	≥ 17 V; 50 mA			
Electrical endurance at I_e and load	AC-1/AC-7a operating cycles	200000		100000	
	AC-3/AC-7b operating cycles	300000	500000	150000	
Mechanical service life	Operating cycles	3 million			
Switching of resistive loads AC-1 for rated operational power P_s	1-phase (NO contacts)	4 kW (230 V)	5.4 kW (400 V)	8.7 kW (400 V)	13.3 kW (400 V)
	3-phase (NO contacts)	–	16 kW (400 V)	26 kW (400 V)	40 kW (400 V)
Switching of three-phase asynchronous motors AC-3 for rated operational power P_s	1-phase (NO contacts)	1.3 kW/0.75 kW	1.3 kW/1.3 kW	3.7 kW/3.7 kW	5/5 kW
	3-phase (NO contacts)	–	4 kW	11 kW	15 kW
Maximum switching frequency at load	AC-1/AC-7a/AC-3/AC-7b	600 h ⁻¹			
Safety					
Rated impulse voltage U_{imp}		≤ 4 kV			
Short-circuit protection, according to coordination type 1	Back-up fuse characteristic gL/gG	20 A	25 A	63 A	80 A
Overload withstand capability at 10 s	Per conducting path (NO contacts only)	72 A	68 A	176 A	240 A
Function					
Switching times	Closing (NO contacts)	15 ... 45 ms		15 ... 20 ms	
	Opening (NO contacts)	20 ... 50 ms	20 ... 70 ms	35 ... 45 ms	
Connections					
Coil/main connection terminals	± Screw (Pozidriv)	PZ1/PZ1	PZ1/PZ2		
Coil connection conductor cross-section	Solid	1.0 ... 2.5 mm ²			
	Stranded, with end sleeve	1.0 ... 2.5 mm ²			
	AWG cables	16 ... 10			
Main connection conductor cross-section	Solid	1.0 ... 10 mm ²	1.5 ... 25 mm ²		
	Stranded, with end sleeve	1.0 ... 6 mm ²	1.5 ... 16 mm ²		
	AWG cables	16 ... 8	16 ... 4		
Tightening torque	Coil connection	0.6 Nm/8 lbs/in.			
	Main connection	1.2 Nm/9 lbs/in.	3.5 Nm/20 lbs/in.		
Ambient conditions					
Permissible ambient temperature	For operation ¹⁾ /For storage	–15 ... +55 °C/–50 ... +80 °C			
Degree of protection	Acc. to EN 60529	IP20, with connected conductors			
Characteristics according to UL 508					
Rated operational current I_n		20 A	25 A	40 A	63 A
UL 508 General Use 240 V/480 V	FLA	20 A	25 A	40 A	63 A
UL 508 AC discharge lamps		20 A	25 A	30 A	40 A
UL 508 motor load	Power 240 V/480 V	1 hp/–	3 hp/5 hp	7.5 hp/15 hp	10 hp/20 hp
UL 508 short-circuit at 480 V	K5 fuses	20 A	25 A	60 A	70 A

¹⁾ Contactors can be operated at ambient temperatures of between –25 °C and +70 °C, but only under special conditions.

For further information, please contact Siemens Support. For questions concerning heat dissipation, please refer to the instructions in the Configuration Manual "Switching devices".

Accessories

Auxiliary switches			
	<ul style="list-style-type: none"> • For right-hand-side retrofitting • Max. one auxiliary switch per Insta contactor 		
	Contacts	Mounting width	Article No.
	2 NO	0.5 MW	5TT5910-0
	1 NO + 1 NC	0.5 MW	5TT5910-1

Sealable terminal covers			
	For Insta contactor	Mounting width	Article No.
	20 A	1 MW	5TT5910-5
	25 A	2 MW	5TT5910-6
40 A and 63 A	3 MW	5TT5910-7	


5TT58 Insta contactors

AC technology

Main connection conductor cross-section, rigid

Main connection conductor cross-section, flexible with end sleeve

Rated operational current I_e				
20 A	25 A	32 A	40 A	63 A
1.0 ... 10 mm ²	1.0 ... 10 mm ²	1.0 ... 10 mm ²	1 ... 25 mm ²	1 ... 25 mm ²
1.0 ... 6 mm ²	1.0 ... 6 mm ²	1.0 ... 6 mm ²	1 ... 16 mm ²	1 ... 16 mm ²



Contacts	U_e	U_c AC		Mounting width					
Insta contactors without manual switch									
2 NO	230 V	230 V		1 MW	5TT5800-0	5TT5810-0	5TT5860-0	–	
				2 MW new	–	–	–	5TT5870-0	–
4 NO	400 V	230 V	Standard	1 MW	5TT5800-2	–	–	–	
				2 MW	–	5TT5830-0	–	–	–
		Capacitive loads up to 150 µF	3 MW	–	–	–	5TT5840-0	5TT5850-0	
			2 MW	–	5TT5820-0	–	–	–	
		115 V	2 MW	–	5TT5830-1	–	–	–	
		24 V	2 MW	–	5TT5830-2	–	–	–	
2 NC	230 V	230 V		1 MW	5TT5802-0	–	–	–	
				1 MW	5TT5802-2	–	–	–	–
4 NC	400 V	230 V		2 MW	–	5TT5833-0	–	–	
				3 MW	–	–	–	5TT5843-0	5TT5853-0
		24 V	2 MW	–	5TT5833-2	–	–	–	
			3 MW	–	–	–	5TT5843-2	5TT5853-2	
1 NO + 1 NC	230 V	230 V		1 MW	5TT5801-0	–	–	–	
				1 MW	5TT5801-2	–	–	–	–
2 NO + 2 NC	400 V	230 V		2 MW	–	5TT5832-0	–	–	
				3 MW	–	–	–	5TT5842-0	5TT5852-0
		24 V	2 MW	–	5TT5832-2	–	–	–	
			3 MW	–	–	–	5TT5842-2	5TT5852-2	
3 NO + 1 NC	400 V	230 V		2 MW	–	5TT5831-0	–	–	
				3 MW	–	–	–	5TT5841-0	5TT5851-0
		115 V	2 MW	–	5TT5831-1	–	–	–	
			24 V	2 MW	–	5TT5831-2	–	–	–
				3 MW	–	–	–	5TT5841-2	5TT5851-2
Insta contactors with manual switch O//Automatic									
2 NO	230 V	230 V		1 MW	5TT5800-6	–	–	–	
				1 MW	5TT5800-8	–	–	–	–
4 NO	400 V	230 V		2 MW	–	5TT5830-6	–	–	
				3 MW	–	–	–	5TT5840-6	5TT5850-6
		24 V	2 MW	–	5TT5830-8	–	–	–	
			3 MW	–	–	–	5TT5840-8	–	
1 NO + 1 NC	230 V	230 V		1 MW	5TT5801-6	–	–	–	
				1 MW	5TT5801-8	–	–	–	–
3 NO + 1 NC	400 V	230 V		2 MW	–	5TT5831-6	–	–	
				3 MW	–	–	–	5TT5841-6	–
		24 V	2 MW	–	5TT5831-8	–	–	–	
			3 MW	–	–	–	5TT5841-8	–	

Note:

Provision must be made for spacers to ensure heat dissipation.

See Configuration Manual – Switching devices www.siemens.com/lowvoltage/manuals (45315361).

Further technical specifications		5TT580.	5TT581.	5TT582. 5TT583.	5TT584.	5TT585.	5TT586.	5TT587. new				
Standards												
Standards		IEC 60947-4-1, IEC 60947-5-1, IEC 61095; EN 60947-4-1, EN 60947-5-1, EN 61095, VDE 0660										
Supply												
Number of poles		2		4		2						
Rated operational current I_e		20 A		25 A		40 A		63 A	32 A	40 A		
Primary operating range		0.85 ... 1.1 × U_c										
Rated frequency f_c at AC		50/60 Hz										
Rated power dissipation P_v		Pick-up power (without manual switch or manual switch in "I" position)		6 VA/3.8 W		12 VA/10 W		10 VA/5 W		15.4 VA/4.6 W	12 VA/10 W	33 VA/25 W
		Pick-up power (with manual switch in "AUTO" position)		12 VA/10 W		–		33 VA/25 W		62 VA/50 W		–
		Holding power		2.8 VA/1.2 W		–		5.5 VA/1.6 W		7.7 VA/3 W	2.8 VA/1.2 W	5.5 VA/1.6 W
		Per contact AC-1/AC-7a		1.7 VA		2.0 VA		2.2 VA		4 VA	8 VA	2.5 VA
Contacts												
Contact gap		Minimum		3.6 mm		–		3.4 mm		3.6 mm		
Minimum switching capacity (= minimum contact load)		≥ 17 V; 50 mA										
Electrical endurance at I_e and load		AC-1/AC-7a operating cycles		200000		–		100000		150000	100000	
		AC-3/AC-7b operating cycles		300000		500000		150000		300000	150000	
Mechanical service life		Operating cycles		3 million								
Switching of resistive loads AC-1/AC-7a for rated operational power P_s		1-phase (230 V) (NO contacts)		4 kW		5.4 kW		8.7 kW		13.3 kW	5.9 kW	3.7 kW
		3-phase (400 V) (NO contacts)		–		16 kW		26 kW		40 kW		–
Switching of 3-phase asynchronous motors AC-3/AC-7b for rated operational power P_s		1-phase (230 V) (NO contacts)		1.3 kW ¹⁾		1.3 kW		3.7 kW		5 kW	1.3 kW	–
		3-phase (400 V) (NO contacts)		–		4 kW		11 kW		15 kW		–
Maximum switching frequency at load		600 h ⁻¹										
Safety												
Rated insulation voltage U_i		440 V		–		500 V		440 V		230 V		
Rated impulse voltage U_{imp}		4 kV										
Short-circuit protection, according to coordination type 1		Back-up fuse characteristic gL/gG		20 A		25 A		63 A		80 A	32 A	63 A
Overload withstand capability at 10 s		Per conducting path (NO contacts only)		72 A		68 A		176 A		240 A	72 A	176 A
Function												
Switching times		Closing (NO contacts)		15 ... 25 ms		10 ... 20 ms		15 ... 20 ms		15 ... 25 ms	10 ... 20 ms	
		Opening (NO contacts)		20 ms		10 ... 30 ms		20 ms		10 ms	10 ... 30 ms	10 ... 15 ms
		Closing (NC contacts)		20 ... 30 ms		–		20 ... 30 ms		5 ... 10 ms		–
		Opening (NC contacts)		10 ms		–		10 ms		10 ... 15 ms		–
Connections												
Coil connection terminals		± Screw (Pozidriv)		PZ1								
Main connection terminals		± Screw (Pozidriv)		PZ1		–		PZ2		PZ1		
Coil connection conductor cross-section		Rigid		1.0 ... 2.5 mm ²								
		Flexible, with end sleeve		1.0 ... 2.5 mm ²								
Main connection conductor cross-section		Rigid		1.0 ... 10 mm ²		–		1 ... 25 mm ²		1.0 ... 10 mm ²	1.5 ... 25 mm ²	
		Flexible, with end sleeve		1.0 ... 6 mm ²		–		1 ... 16 mm ²		1.0 ... 6 mm ²	1.5 ... 16 mm ²	
Tightening torque		Coil connection		0.6 Nm								
		Main connection		1.2 Nm		–		3.5 Nm		1.2 Nm	2.5 Nm	
Ambient conditions												
Permissible ambient temperature		For operation/for storage		–5 ... +55 °C/–30 ... +80 °C								
Degree of protection		Acc. to EN 60529		IP20, with connected conductors								

¹⁾ For NO contacts only.

5TT58 Insta contactors

AC technology

Accessories

Auxiliary switches



- For right-hand-side retrofitting
- Max. one auxiliary switch per Insta contactor

Contacts	Mounting width	Article No.
2 NO	0.5 MW	5TT5910-0
1 NO + 1 NC	0.5 MW	5TT5910-1

Sealable terminal covers



For Insta contactor	Mounting width	Article No.
20 A	1 MW	5TT5910-5
25 A	2 MW	5TT5910-6
40 A and 63 A	3 MW	5TT5910-7

Spacer



- Contour for modular devices with a mounting depth of 70 mm
- Can be snapped onto either side of the busbar for convenient cable routing
- Spacer is recommended for better heat dissipation

For Insta contactor	Mounting width	Article No.
20 A	1 MW	5TG8240

5TT5 auxiliary switches

For 5TT5 Insta contactor

Rigid conductor cross-section 1 ... 2.5 mm²
Flexible conductor cross-section, with end sleeve 1 ... 2.5 mm²



Contacts	U_e AC	Mounting width	
2 NO	230 V/400 V	0.5 MW	5TT5910-0
1 NO + 1 NC	230 V/400 V	0.5 MW	5TT5910-1

5

Further technical specifications

5TT5910

Standards		
Standards		IEC 60947-5-1
Approvals		CCC
Supply		
Number of poles		2
Rated operational current I_e	230 V	6 A
	400 V	4 A
Rated frequency f_c at AC		50/60 Hz
Contacts		
Contact gap	Minimum	4 mm
Minimum switching capacity	(= minimum contact load)	≥ 12 V; 5 mA
Mechanical service life	Operating cycles	3 million
Maximum switching frequency at load		600 h ⁻¹
Safety		
Rated insulation voltage U_i		500 V
Rated impulse voltage U_{imp}		4 kV
Short-circuit protection, according to coordination type 1	Back-up fuse characteristic gL/gG	6 A
Connections		
Terminals	\pm Screw (Pozidriv)	PZ1
Conductor cross-section	Rigid	1 ... 2.5 mm ²
	Flexible, with end sleeve	1 ... 2.5 mm ²
Tightening torque		0.8 Nm
Ambient conditions		
Permissible ambient temperature	For operation/for storage	-5 ... +55 °C/-30 ... +80 °C
Degree of protection	Acc. to EN 60529	IP20, with connected conductors

5TT3 soft-starting devices

For 2-phase motor control

Rigid conductor cross-section Max. $2 \times 2.5 \text{ mm}^2$
Flexible conductor cross-section, with end sleeve Min. $1 \times 0.5 \text{ mm}^2$



Version	U_e AC	Mounting width	
3-phase	400 V	6 MW	5TT3440

Further technical specifications

5TT3440

Standards		
Standards		EN 60947-4-2 (VDE 0660-117)
Supply		
Line/motor voltage		400 V AC
Primary operating range		$0.8 \dots 1.1 \times U_c$
Rated frequency f_c at AC		50/60 Hz
Rated power		3.5 VA
Rated power dissipation P_v at rated operational current		Coil/drive Per contact
		3.5 VA 4.6 VA
Rated output of motor at 400 V		Max. Min.
		5500 VA 300 VA
Startup voltage		30 ... 70%
Starting ramp		0.1 ... 10 s
Safety		
Quick-acting semiconductor fuse		35 A
Function		
Switching frequency $3 \times I_N, T_{AN} = 10 \text{ s}, v_U = 20\%$		Operating cycles (up to 3 kW) Operating cycles (from 3 ... 5.5 kW)
		36 h ⁻¹ 20 h ⁻¹
Recovery time		100 ms
Connections		
Conductor cross-section		Rigid Flexible, with end sleeve
		Max. $2 \times 2.5 \text{ mm}^2$ Min. $1 - 0.5 \text{ mm}^2$
Ambient conditions		
Permissible ambient temperature		-20 ... +60 °C
Resistance to climate		Acc. to EN 60068-1 20/60/4

7LF4 digital time switches

Mini



- Weekly program
- 28 programs
- Automatic daylight-saving adjustment

Contacts	U_c	Channels	Mounting width	
1 NO	230 V AC	1	1 MW	7LF4501-5

Further technical specifications

Mini

Standards		
Standards		EN 60730-1, -2-7; VDE 0631-1, -2-7
Supply		
Primary operating range		0.85 ... 1.1 × U_c
Frequency range		50/60 Hz
Rated power dissipation P_v		0.9 VA
Channels		
Rated operational voltage U_e		250 V AC
Rated operational current I_c	At p.f. = 1	16 A
	At p.f. = 0.6	10 A
Contacts		
Minimum contact load		12 V/100 mA
Electrical operating cycles	At p.f. = 1	6000 (20 A)
Mechanical operating cycles		> 5 million
Incandescent lamp load		5 A
Energy-saving lamp load		300 W
Fluorescent lamp load	Parallel p.f. correction 70 μF	60 VA
	Uncorrected	2500 VA
Safety		
Different phases between operating mechanism and contact		Permissible
Rated impulse voltage U_{imp}		4 kV
Electrostatic discharge	Acc. to IEC 61000-4-2	> 8.0 kV
EMC: Burst	Acc. to IEC 61000-4-4	> 4.4 kV
EMC: Surge	Acc. to IEC 61000-4-5	> 2.0 kV
Overvoltage category	Acc. to EN 61010-1	III
Function		
Clock errors per day	Typical	±1 s/day
Power reserve storage	Battery	3 years
Make and break cycles		1 min
Minimum switching sequences		1 min
Control input	Terminal S	–
Programs ¹⁾		28
Battery type		Li primary cell
Connections		
Terminals	± Screw (Pozidriv)	PZ1
Conductor cross-sections of main conducting path	Rigid	1.5 ... 4 mm ²
	Flexible, with end sleeve	Max. 2.5 mm ²
Ambient conditions		
Permissible ambient temperature	For operation/ for storage	–10 ... +55 °C/ –20 ... +60 °C
Resistance to climate	Acc. to EN 60068-1	10/055/21
Degree of protection	Acc. to EN 60529	IP20, with connected conductors
Protection class	Acc. to EN 61140	II

¹⁾ A program consists of an ON time, an OFF time and assigned ON and OFF days or day blocks.

Top



- Weekly program
- 28 programs
- Text-assisted programming concept
 - Language: English
- Manual daylight-saving adjustment

Contacts	U_c	Channels	Mounting width	
1 CO	230 V AC	1	2 MW	7LF4511-0
2 CO	230 V AC	2	2 MW	7LF4512-0

Further technical specifications

Standards		Top
Standards		EN 60730-1, -2-7; VDE 0631-1, -2-7
Supply		
Primary operating range		0.85 ... $1.1 \times U_c$
Frequency range		50/60 Hz
Rated power dissipation P_v		2 VA
Channels		
Rated operational voltage U_e		250 V AC
Rated operational current I_e		At p.f. = 1 16 A At p.f. = 0.6 10 A
Contacts		
Minimum contact load		12 V/100 mA
Electrical operating cycles		At p.f. = 1 100000
Mechanical operating cycles		10 million
Incandescent lamp load		8 A
Energy-saving lamp load		60 VA
Fluorescent lamp load		Parallel p.f. correction 70 μ F 60 VA Uncorrected 2300 VA
Safety		
Different phases between operating mechanism and contact		Permissible ²⁾
Rated impulse voltage U_{imp}		4 kV
Electrostatic discharge		Acc. to IEC 61000-4-2 > 8.0 kV
EMC: Burst		Acc. to IEC 61000-4-4 > 4.4 kV
EMC: Surge		Acc. to IEC 61000-4-5 > 2.0 kV
Overvoltage category		Acc. to EN 61010-1 III
Function		
Clock errors per day		Typical ± 1.5 s/day
Power reserve storage		Battery 3 years
Make and break cycles		1 min
Minimum switching sequences		1 min
Control input		Terminal S No
Programs ¹⁾		28 (14 per channel)
Program memory		Captive No
Battery type		Li primary cell
Connections		
Terminals		\pm Screw (Pozidriv) PZ1
Conductor cross-sections of main conducting path		Rigid 1.5 ... 4 mm ² Flexible, with end sleeve Max. 2.5 mm ²
Ambient conditions		
Permissible ambient temperature		For operation/ for storage –20 ... +55 °C/ –20 ... +60 °C
Resistance to climate		Acc. to EN 60068-1 20/055/21
Degree of protection		Acc. to EN 60529 IP20, with connected conductors
Protection class		Acc. to EN 61140 II

¹⁾ A program consists of an ON time, an OFF time and assigned ON and OFF days or day blocks.

²⁾ The combination of line voltage (230 V) and SELV is not permissible in conjunction with a 2-channel time switch. This requirement is, however, admissible in the case of 1-channel time switch.

7LF4 digital time switches

Profi



- Weekly program
- Vacation program
- Random program
- Expert mode
- Cycle function
- Text-assisted programming concept
 - 15 languages
- Simple program creation on a PC using the supplied software, with 7LF4941-0 USB adapter
- Automatic daylight-saving adjustment
- Operating hours counter, counting range: 65535 h
- Accurate to the second hh:mm:ss
- Synchronization 50/60 Hz

Contacts	U_c	Channels	Mounting width	
1 CO	230 V AC	1	2 MW	7LF4521-0
	24 V AC/DC	1	2 MW	7LF4521-2
2 CO	230 V AC	2	2 MW	7LF4522-0
	24 V AC/DC	2	2 MW	7LF4522-2

Further technical specifications

Profi

Standards		
Standards		EN 60730-1, -2-7; VDE 0631-1, -2-7
Approvals		UL File No. E301698
Supply		
Primary operating range	U_c 230 V	0.85 ... $1.1 \times U_c$
	U_c 24 V	0.9 ... $1.1 \times U_c$
Frequency range	U_c 230 V	50/60 Hz
	U_c 24 V	50/60 Hz
Rated power dissipation P_v	U_c 230 V	2 VA
	U_c 24 V	2 VA
Channels		
Rated operational voltage U_e		250 V AC
Rated operational current I_e	At p.f. = 1	16 A
	At p.f. = 0.6	10 A
Contacts		
Minimum contact load		12 V/100 mA
Electrical operating cycles	At p.f. = 1	100000
Mechanical operating cycles		10 million
Incandescent lamp load		8 A
Energy-saving lamp load		1000 W
Fluorescent lamp load	Parallel p.f. correction 70 μ F	600 VA
	Uncorrected	2000 VA
Safety		
Different phases between operating mechanism and contact		Permissible ²⁾
Rated impulse voltage U_{imp}		4 kV
Electrostatic discharge	Acc. to IEC 61000-4-2	> 8.0 kV
EMC: Burst	Acc. to IEC 61000-4-4	> 4.4 kV
EMC: Surge	Acc. to IEC 61000-4-5	> 2.0 kV
Overvoltage category	Acc. to EN 61010-1	III
Function		
Clock errors per day	Typical	± 0.1 s/day
Power reserve storage	Battery	5 years
Make and break cycles		1 s
Minimum switching sequences		1 s
Control input	Terminal S	No
Programs ¹⁾		28
Program memory	Captive	Yes
Battery type		Li primary cell
Connections		
Terminals	\pm Screw (Pozidriv)	PZ1
Conductor cross-sections of main conducting path	Rigid	1.5 ... 4 mm ²
	Flexible, with end sleeve	Max. 2.5 mm ²
Ambient conditions		
Permissible ambient temperature	For operation/for storage	-20 ... +55 °C/ -20 ... +60 °C
Resistance to climate	Acc. to EN 60068-1	20/055/21
Degree of protection	Acc. to EN 60529	IP20, with connected conductors
Protection class	Acc. to EN 61140	II

¹⁾ A program consists of an ON time, an OFF time and assigned ON and OFF days or day blocks.

²⁾ The combination of line voltage (230 V) and SELV is not permissible in conjunction with a 2-channel time switch. This requirement is, however, admissible in the case of 1-channel time switch.

Astro



- Weekly program
- Vacation program
- Random program
- Expert mode
- Astro function
- Text-assisted programming concept
 - 15 languages
- Simple program creation on a PC using the supplied software, with 7LF4941-0 USB adapter
- Automatic daylight-saving adjustment
- Operating hours counter, counting range: 65535 h
- Accurate to the second hh:mm:ss
- Synchronization 50/60 Hz
- Input disable via PIN code
- Daylight-saving correction
- 1 h test

Contacts	U_c	Channels	Mounting width	
1 CO	230 V AC	1	2 MW	7LF4531-0
2 CO	230 V AC	2	2 MW	7LF4532-0

Further technical specifications

Astro

Standards		
Standards		EN 60730-1, -2-7; VDE 0631-1, -2-7
Approvals		UL File No. E301698
Supply		
Primary operating range		0.85 ... 1.1 × U_c
Frequency range		50/60 Hz
Rated power dissipation P_v		2 VA
Channels		
Rated operational voltage U_e		250 V AC
Rated operational current I_e	At p.f. = 1	16 A
	At p.f. = 0.6	10 A
Contacts		
Minimum contact load		12 V/100 mA
Electrical operating cycles	At p.f. = 1	100000
Mechanical operating cycles		10 million
Incandescent lamp load		8 A
Energy-saving lamp load		1000 W
Fluorescent lamp load	Parallel p.f. correction 70 μF	600 VA
	Uncorrected	2000 VA
Safety		
Different phases between operating mechanism and contact		Permissible ²⁾
Rated impulse voltage U_{imp}		4 kV
Electrostatic discharge	Acc. to IEC 61000-4-2	> 8.0 kV
EMC: Burst	Acc. to IEC 61000-4-4	> 4.4 kV
EMC: Surge	Acc. to IEC 61000-4-5	> 2.0 kV
Overvoltage category	Acc. to EN 61010-1	III
Function		
Clock errors per day	Typical	±0.1 s/day
Power reserve storage	Battery	5 years
Make and break cycles		1 s
Minimum switching sequences		1 s
Control input	Terminal S	Yes (with 1K clock)
Programs ¹⁾		56 (2 × 28)
Program memory	Captive	Yes
Battery type		Li primary cell
Connections		
Terminals	± Screw (Pozidriv)	PZ1
Conductor cross-sections of main conducting path	Rigid	1.5 ... 4 mm ²
	Flexible, with end sleeve	Max. 2.5 mm ²
Ambient conditions		
Permissible ambient temperature	For operation/ for storage	–20 ... +55 °C/ –20 ... +60 °C
Resistance to climate	Acc. to EN 60068-1	20/055/21
Degree of protection	Acc. to EN 60529	IP20, with connected conductors
Protection class	Acc. to EN 61140	II

¹⁾ A program consists of an ON time, an OFF time and assigned ON and OFF days or day blocks.

²⁾ The combination of line voltage (230 V) and SELV is not permissible in conjunction with a 2-channel time switch. This requirement is, however, admissible in the case of 1-channel time switch.

7LF5 mechanical time switches

Time switches without power reserve

For DIN rail

For wall mounting
(surface mounting)



Contacts	Mounting width			
With day disk				
1 NO	1 MW	7LF5300-1	–	–
1 CO	3 MW	–	7LF5300-5	–
	–	–	–	7LF5301-0
With week disk				
1 CO	3 MW	–	7LF5300-6	–

Further technical specifications

	7LF5300-1	7LF5300-5	7LF5300-6	7LF5301-0
Standards				
Standards	EN 60730-1, -2-7, UL 917, UL 917, CSA C22.2 No. 14 and 177			
Approvals	VDE, UL file: E301698			
Supply				
Rated control supply voltage U_c	230 V AC			
Primary operating range	U_c 230 V AC	0.85 ... 1.1 × U_c		
Rated frequency	50 Hz			
Frequency range	50 Hz			
Rated power dissipation P_v	1 VA			
Channels				
Rated operational voltage U_e	250 V AC			
Rated operational current I_e	At p.f. = 1	16 A		
	At p.f. = 0.6	4 A		
Contacts				
Minimum contact load	4 V/1 mA			
Electrical operating cycles	At p.f. = 1	100000		
Mechanical operating cycles	20 million			
Incandescent lamp load	5 A			
Fluorescent lamp load	Parallel p.f. correction 70 μF	60 VA		
	Uncorrected	1400 VA		
Safety				
Different phases between operating mechanism and contact	Permissible			
Electrical isolation, creepage distances and clearances	Operating mechanism	8 mm		
	Contact	6 mm		
Rated impulse voltage U_{imp}	4 kV			
Electrostatic discharge	Acc. to IEC 61000-4-2	> 8.0 kV		
EMC: Burst	Acc. to IEC 61000-4-4	> 4.4 kV		
EMC: Surge	Acc. to IEC 61000-4-5	> 2.0 kV		
Overvoltage category	Acc. to EN 61010-1	III		
Function				
Switching accuracy	±5 min	±30 min	±5 min	
Clock errors	System-synchronized			
Make and break cycles	15 min	120 min	10 min	
Minimum switching sequences	30 min	240 min	30 min	
Connections				
Terminals	± Screw (Pozidriv)	PZ1		
Conductor cross-sections of main conducting path	Rigid	1.5 ... 4 mm ²		
	Flexible, with end sleeve	Max. 2.5 mm ²		
	Flexible, without end sleeve	Max. 4 mm ²		
Ambient conditions				
Permissible ambient temperature	For operation/for storage	−10 ... +55 °C/−10 ... +60 °C		
Resistance to climate	Acc. to EN 60068-1	10/055/21		
Degree of protection	Acc. to EN 60529	IP20, with connected conductors		
Protection class	Acc. to EN 61140	II		

Accessories

Holders for front panel installation



- Universal application for devices from 1 MW ... 6 MW
- Cutout dimensions:
 - Height 45^{+0.5} mm
 - Width 23 mm, 41 mm, 59 mm, 77 mm, 95 mm or 113 mm


Article No.

7LF9006

7LF5 mechanical time switches

Time switches with power reserve

	For DIN rail		For wall mounting (surface mounting)	
Time buffering in the event of a power failure	–	–	■	–
Automatic daylight-saving adjustment	–	–	■	–
Automatic time setting for Central European time zone during commissioning	–	–	■	–



Contacts	Mounting width				
With day disk					
1 NO	1 MW	7LF5301-1	–	–	–
1 CO	3 MW	–	7LF5301-6	7LF5301-4	–
	–	–	–	–	7LF5305-0
With week disk					
1 CO	3 MW	–	7LF5301-7	7LF5301-5	–

Further technical specifications

		7LF5301-1	7LF5301-4	7LF5301-5	7LF5301-6	7LF5301-7	7LF5305-0
Standards							
Standards		EN 60730-1, -2-7, UL 917, UL 917, CSA C22.2 No. 14 and 177					
Approvals		VDE, UL file: E301698					
Supply							
Rated control supply voltage U_c		230 V AC					
Primary operating range		0.85 ... 1.1 × U_c					
Rated frequency		50 Hz					
Frequency range		50/60 Hz					
Rated power dissipation P_v		1 VA	0.2 VA		1 VA		
Channels							
Rated operational voltage U_e		250 V AC					
Rated operational current I_e	At p.f. = 1	16 A					
	At p.f. = 0.6	4 A					
Contacts							
Minimum contact load		4 V/1 mA					
Electrical operating cycles	At p.f. = 1	100000					
Mechanical operating cycles		20 million					
Incandescent lamp load		5 A					
Fluorescent lamp load	Parallel p.f. correction 70 μF	60 VA					
	Uncorrected	1400 VA					
Safety							
Different phases between operating mechanism and contact		Permissible					
Electrical isolation, creepage distances and clearances	Operating mechanism	8 mm					
	Contact	6 mm					
Rated impulse voltage U_{imp}		4 kV					
Electrostatic discharge	Acc. to IEC 61000-4-2	> 8.0 kV					
EMC: Burst	Acc. to IEC 61000-4-4	> 4.4 kV					
EMC: Surge	Acc. to IEC 61000-4-5	> 2.0 kV					
Overvoltage category	Acc. to EN 61010-1	III					
Function							
Switching accuracy		±5 min		±30 min	±5 min	±30 min	±5 min
Clock errors		±2.5 s/day	±0.2 s/day	±60 s/day	±2.5 s/day		
Power reserve storage		100 h	6 years		100 h		
Make and break cycles		15 min		120 min	15 min	120 min	15 min
Minimum switching sequences		30 min		240 min	30 min	240 min	30 min
Battery type		NiMH cell	Li primary cell		NiMH cell		
Minimum loading time		48 h	–		48 h		
Service life of battery	At 20 °C	6 years	10 years		6 years		
	At 40 °C	5 years					
Connections							
Terminals	± Screw (Pozidriv)	PZ1					
Conductor cross-sections of main conducting path	Rigid	1.5 ... 4 mm ²					
	Flexible, with end sleeve	Max. 2.5 mm ²					
	Flexible, without end sleeve	Max. 4 mm ²					
Ambient conditions							
Permissible ambient temperature	Storage/operation	–10 ... +60 °C/–10 ... +55 °C					
Resistance to climate	Acc. to EN 60068-1	10/055/21					
Degree of protection	Acc. to EN 60529	IP20, with connected conductors					
Protection class	Acc. to EN 61140	II					

Accessories

Holders for front panel installation



- Universal application for devices from 1 MW ... 6 MW
- Cutout dimensions:
 - Height 45^{+0.5} mm
 - Width 23 mm, 41 mm, 59 mm, 77 mm, 95 mm or 113 mm

Article No.

7LF9006

7LF6 timers for buildings



		Stairwell lighting timers	
		Standard	Multi
3-wire circuit		■	■
4-wire circuit		■	■
Zero crossing circuit		■	■
Operation		Resettable	Resettable
			
Contacts	Warning of impending switch-off	Mounting width	
1 NO	–	1 MW	7LF6310
	Flickering	1 MW	–
			7LF6311

Further technical specifications

		7LF6310	7LF6311
Supply			
Rated operational current I_e	At p.f. = 1	16 A	
Rated operational voltage U_e		250 V AC	
Rated control supply voltage U_c		230 V AC	
Frequency range		50/60 Hz	
Rated power dissipation P_v		1 W	
Rated impulse voltage U_{imp}		4 kV	
Contacts			
Channels		1	
Max. glow lamp load		25 mA	50 mA
Separate multi-voltage input		–	8 ... 230 V AC/DC
Switching capacity	Inductive p.f. = 0.6	2000 VA	
Incandescent lamp load	Max.	3680 W	
Fluorescent lamp load	Series p.f. correction	2000 VA	
	Parallel p.f. correction at 70 μ F	1000 W	
Compact fluorescent lamp load		1000 W	
LED		1000 W	
Electronic transformers		2000 VA	
Conventional transformers		2000 VA	
Function			
Setting range		0.5 ... 10 min	0.5 ... 12 min
Manual switches		Yes	
Programs		–	7 ¹⁾
Ambient conditions			
Permissible ambient temperature	For operation	–20 ... +55 °C	
	For storage	–20 ... +60 °C	
Degree of protection	Installed	IP30	
Pollution degree		2	

¹⁾ 7 functions, can be selected using selector switch on the device

5TT3 timers for industrial applications

	Multifunction timers	Delay timers
Programmable for:	<ul style="list-style-type: none"> • Response delay • Passing make contact function • Pulse generator, delayed • Clock generator, starting with impulse • OFF-delay • Pulse converter • Passing break contact function • Response delay/OFF-delay 	–
		
Contacts	Mounting width	
1 CO	1 MW	
	5TT3185	5TT3181

Further technical specifications		5TT3185	5TT3181
Standards			
Standards		EN 60255; DIN VDE 0435-110	
Supply			
Rated operational current I_e		4 A	8 A
Rated operational voltage U_e		250 V AC	
Rated control supply voltage U_c		12 ... 240 V AC	220 ... 240 V AC
		12 ... 240 V DC	–
Primary operating range		U_c 230 V AC, 50/60 Hz	
		0.8 ... 1.1 × U_c	
Rated frequency f_n		45 ... 400 Hz	50/60 Hz
Rated power dissipation P_v		Approx. 3 VA	Approx. 5 VA
Contacts			
Contact gap		µm contact	
Minimum contact load		10 V/300 mA	
Electrical endurance		Switching cycles	–
		At AC-15	1.5 × 10 ⁵
		–	1.5 × 10 ⁵
Safety			
Rated impulse voltage U_{imp}		Input/output	> 4 kV
Function			
Setting range		1 s ... 300 h	
Recovery time		15 ... 80 ms	Approx. 40 ms
Connections			
Terminals		± Screw (Pozidriv)	PZ2
Conductor cross-sections of main conducting path		Rigid	Max. 2 × 2.5 mm ²
		Flexible, with end sleeve	Min. 2 × 1.5 mm ²
Ambient conditions			
Permissible ambient temperature		–40 ... +60 °C	
Resistance to climate		Acc. to EN 60068-1	40/60/4

Overvoltage protection devices

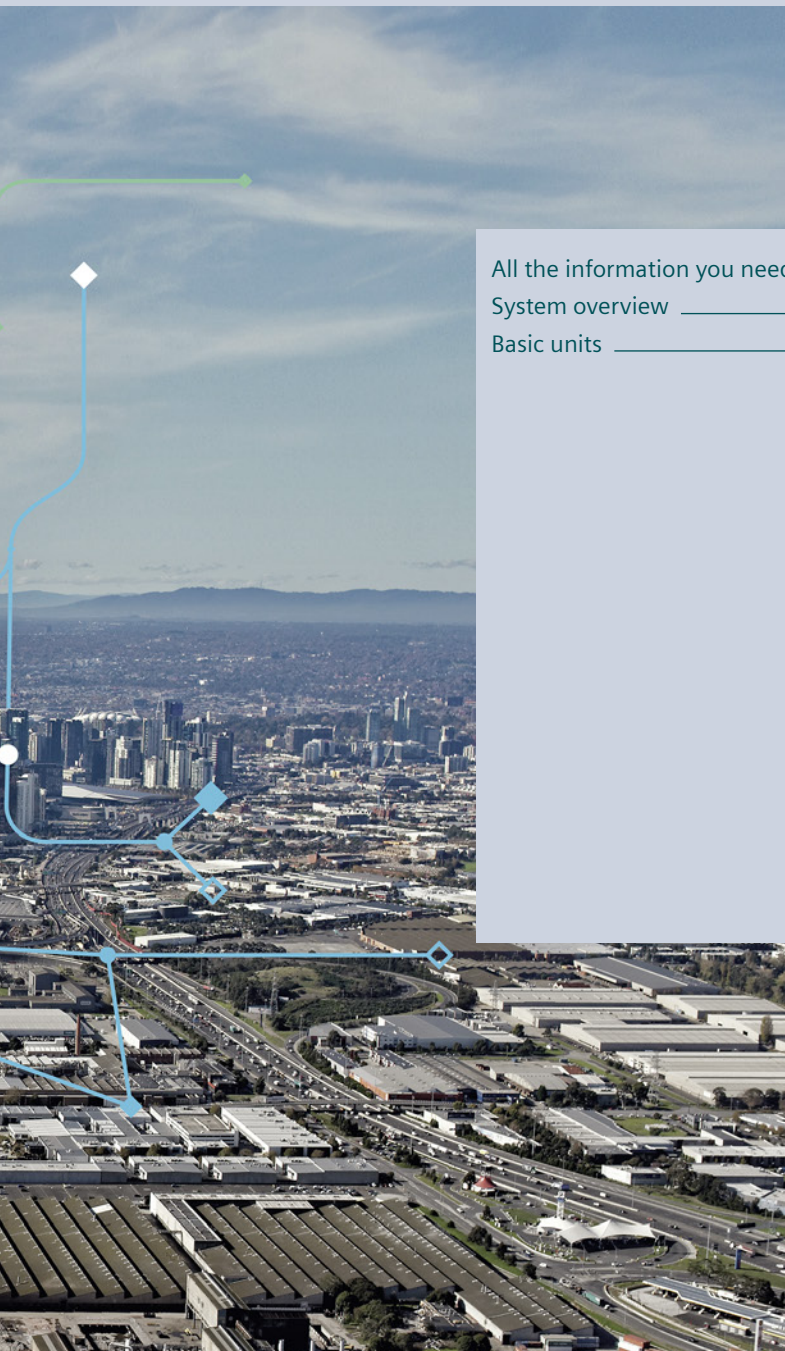
The more than one million lightning strikes in Germany every year pose a considerable risk for buildings and systems that can be damaged due to the unhindered effect of lightning currents, overvoltage and power surges. In many cases however, it is not apparent that such damage has been caused by lightning currents, overvoltage and power surges.

Overvoltage results in considerable damage to electrical and electronic equipment. Even brief transients in power supply lines or between electrical lines and other conductive parts (e.g. grounded metallic parts, ground) are sufficient to cause such damage. The damage patterns of destroyed lines, printed circuit boards or switchgear demonstrate this. Such damage can be prevented employing suitable overvoltage protection means.

Reliably protected by Siemens lightning and surge arresters !



Overvoltage Protection Devices



All the information you need	6/2
System overview	6/4
Basic units	6/6
5SD74 lightning arresters, type 1	6/6
5SD74 combination surge arresters, type 1 + type 2	6/8
5SD74 combination surge arresters with integrated back-up fuse	6/10
5SD74 surge arresters, type 1 + type 2 + type 3 for 40 mm busbar system	6/12
5SD74 combination surge arresters, type 1/type 2	6/14
5SD74 surge arresters, type 2	6/16
5SD74 surge arresters, type 3	6/20

A multitude of additional information ...

Information + ordering

All the important things at a glance

For information about overvoltage protection devices, please visit our website
www.siemens.com/overvoltage-protection

Your product in detail

The SiePortal platform (knowledge base) provides comprehensive information
www.siemens.com/lowvoltage/product-support

- Technology Primer
 - Overvoltage protection devices (**109756965**)

The relevant tender specifications can be found at
www.siemens.com/tenderspecifications

Use our conversion tool for quick and easy conversion to Siemens products www.siemens.com/conversion-tool

Everything you need for your order

Refer to SiePortal to find an overview of your products (product catalog)

- Overvoltage protection devices sie.ag/3ZMwRuw

Direct forwarding to the individual products in SiePortal by clicking on the article number in the catalog or entering this web address incl. article number
www.siemens.com/product_catalog_SIEP?Article No.

6

The fast track to the experts

Contact persons in your region

We offer a comprehensive portfolio of services. You can find your local contacts at
www.siemens.com/lowvoltage/components/contact

You will find further information on services at
www.siemens.com/service-offers

Competent expert advice on technical questions with a wide range of demand-optimized services for all our products and systems.

Assistance with technical queries is provided at
www.siemens.com/support-request

... can be found in our online services

Commissioning + operation

Your product in detail

The SiePortal platform (knowledge base) provides detailed technical information
www.siemens.com/lowvoltage/product-support

- Operating instructions
- Certificates

Online Support app available for download from the [App Store](#) and [Play Store](#)

You will find further information at
www.siemens.com/support-app

Provision of 3D data (step and u3d data formats)

- SiePortal (product catalog)
www.siemens.com/lowvoltage/product-catalog
- Image database
www.siemens.com/lowvoltage/picturedb

Engineering data for CAD or CAE systems are available in the CAX Download Manager at
www.siemens.com/cax

Manuals

Manuals can be found in SiePortal at
www.siemens.com/lowvoltage/manuals

- Configuration Manual
 – Overvoltage protection devices ([45315289](#))

Face-to-face or online training

Our training courses can be found at
www.siemens.com/sitrain-lowvoltage

- Basic principles of electrical engineering (WT-LVBGET)
- Protection concept (WT-LVBPC)

Technical overview – Overvoltage protection devices



The fast way to get you to our online services

This page provides you with comprehensive information and links on overvoltage protection devices
www.siemens.com/lowvoltage/product-support (109769084)

System overview

Basic units



5SD74 lightning arresters, type 1



5SD74 combination surge arresters, type 1 + type 2



5SD74 combination surge arresters with integrated back-up fuse



5SD74 surge arresters, type 1 + type 2 + type 3 for 40 mm busbar system



5SD74 combination surge arresters, type 1/type 2



5SD74 surge arresters, type 2 (standard design)



5SD74 surge arresters, type 3

6

Spare part plugs



N-PE



L-N, L-PEN (type 1)



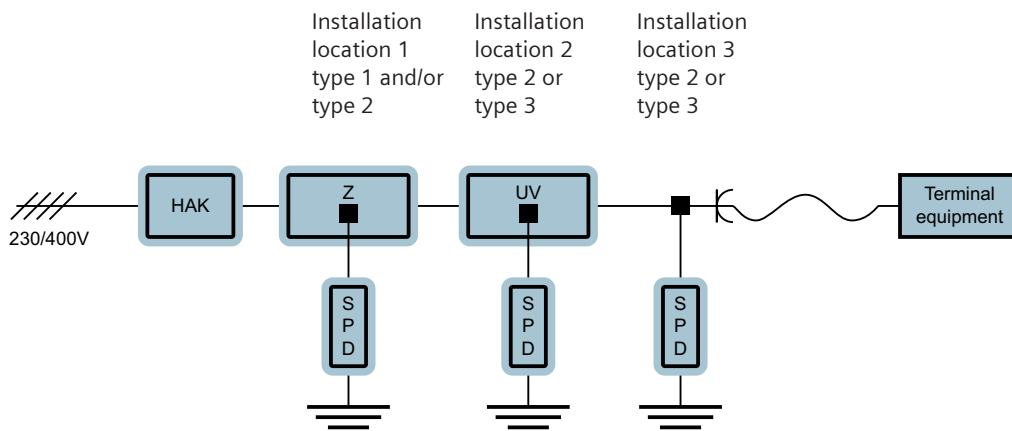
L-PEN

Note:

You will find a detailed range of accessories with the basic units.



Installation locations for surge protection devices (SPDs)



I201_20825





HAK: Main terminal box

Z/HV: In or close to the central meter system/main distribution board

UV: Subdistribution board

Installation location 1 must be as close as possible to the supply point for the electrical system, so that the downstream installations are protected. The SPDs at installation locations 2 and 3 shall not be used without SPDs at installation location 1, and they must be coordinated with these SPDs (i.e. SPDs all from the same manufacturer).

5SD74 lightning arresters, type 1

	For TN-C systems and IT networks	For TN-C systems	For TN-S and TT systems	
Protection paths	L-PE	L-PEN	L-N, L-PE and N-PE	L-N, L-PE and N-PE
Rated voltage U_n	690 V AC	240/415 V AC	240 V AC	240/415 V AC
Maximum continuous voltage U_c	800 V AC	350 V AC	350 V AC	350 V AC
				

Circuit	Mounting width				
With remote signaling					
1 + 0	– ¹⁾	5SD7411-2	–	–	–
1 + 1	4 MW	–	–	5SD7412-1	–
3 + 0	6 MW	–	5SD7413-1	–	–
3 + 1	8 MW	–	–	–	5SD7414-1

¹⁾ No modular installation device.

Further technical specifications

		5SD7411-2	5SD7412-1	5SD7413-1	5SD7414-1
Standards					
Standards		IEC 61643-11; EN 61643-11			
Approvals		–	KEMA, UL/cUL		
Voltage					
Protection level U_p	L-N and L-PEN	≤ 4.50 kV	≤ 1.50 kV		–
	L-PE	–	≤ 2.50 kV	–	≤ 2.50 kV
	N-PE	–	≤ 1.50 kV	–	≤ 1.50 kV
Current					
Lightning impulse current I_{imp} (10/350 μs)	L-N and L-PEN, 1P/3P	35 kA	25 kA	25/75 kA	
	N-PE	–	100 kA	–	100 kA
Rated discharge surge current I_n (8/20 μs)	L-N and L-PEN, 1P/3P	35 kA	25 kA	25/75 kA	
	N-PE	–	100 kA	–	100 kA
Follow current discharge capacity I_n (AC)	L-N and L-PEN for 264/350 V	–	50/25 kA		–
	N-PE	–	100 A	–	100 A
Function					
Response time t_A	L-N and L-PEN	≤ 100 ns			
	L-N and N-PE	–	≤ 100 ns	–	≤ 100 ns
Connections					
Conductor cross-section	Finely stranded	16 ... 50 mm ²	2.5 ... 25 mm ²		
	Solid	16 ... 50 mm ²	2.5 ... 35 mm ²		
Protection devices					
Max. back-up fuse acc. to IEC 61643-1	For stub wiring (gL/gG)	400 A	315 A		
	For V wiring (gL/gG)	125 A	125 A		
Short-circuit strength	With max. back-up fuse	50 kA	50 kA		
Ambient conditions					
Degree of protection		IP20, with connected conductors			
Temperature range		–40 ... +80 °C			

Accessories




Spare part plugs



Protection paths	Basic units	Article No.
N-PE	5SD7412-1 and 5SD7414-1	5SD7418-0
L-N and L-PEN	For 5SD7412-1, 5SD7413-1 and 5SD7414-1	5SD7418-1

5SD74 combination surge arresters, type 1 + type 2

	For TN-C systems	For TN-S and TT systems	
Protection paths	L-PEN	L-N, L-PE and N-PE	L-N, L-PE and N-PE
Rated voltage U_n	240/415 V AC	240 V AC	240 V AC
Maximum continuous voltage U_c	350 V AC	350 V AC	350 V AC

Circuit	Mounting width		
With remote signaling			
1 + 1	4 MW	–	5SD7442-1
3 + 0	6 MW	5SD7443-1	–
3 + 1	8 MW	–	5SD7444-1

Further technical specifications

		5SD7442-1	5SD7443-1	5SD7444-1
Standards				
Standards		IEC 61643-11; EN 61643-11		
Approvals		KEMA, UL/cUL		
Voltage				
Protection level U_p	L-N and L-PEN	≤ 1.50 kV		
	L-PE	≤ 2.20 kV	–	≤ 2.20 kV
	N-PE	≤ 1.50 kV	–	≤ 1.50 kV
Current				
Lightning impulse current I_{imp} (10/350 μs)	L-N and L-PEN	25 kA		
	N-PE	100 kA	–	100 kA
Rated discharge surge current I_n (8/20 μs)	L-N and L-PEN	25 kA		
	N-PE	100 kA	–	100 kA
Follow current discharge capacity I_{fi} (AC)	L-N and L-PEN	25 kA		
	N-PE	100 A	–	100 A
Function				
Response time t_A	L-N and L-PEN	≤ 25 ns		
	L-N and N-PE	≤ 100 ns	–	≤ 100 ns
Connections				
Conductor cross-section	Finely stranded	2.5 ... 25 mm ²		
	Solid	2.5 ... 35 mm ²		
Protection devices				
Max. back-up fuse acc. to IEC 61643-1	For stub wiring (gL/gG)	315 A		
	For V wiring (gL/gG)	125 A		
Short-circuit strength	With max. back-up fuse	25 kA		
Ambient conditions				
Degree of protection		IP20, with connected conductors		
Temperature range		–40 ... +80 °C		
Display				
Visual function/fault indication		Yes		

Accessories

Spare part plugs



Protection paths	Type	Basic units	Article No.
N-PE	–	5SD7442-1 and 5SD7444-1	5SD7418-0
L-N and L-PEN	1	5SD7442-1, 5SD7443-1 and 5SD7444-1	5SD7448-1
	2	5SD7442-1, 5SD7443-1 and 5SD7444-1	5SD7428-1

5SD74 combination surge arresters with integrated back-up fuse

For TN-S and TT systems

Protection paths	L-N
Rated voltage U_n	230 V AC
Maximum continuous voltage U_c	255 V AC



Circuit	Mounting width	
1+0	2 MW	5SD7441-1KF00

Further technical specifications

5SD7441-1KF00

Standards		
Standards		EN 61643-11/... IEC 61643-11
Approvals		KEMA
Voltage		
Protection level U_p	L-N and L-N/PE	≤ 1.50 kV
Current		
Lightning impulse current I_{imp} (10/350 μ s)	L-N and L-N/PE	25 kA
Rated discharge surge current I_n (8/20 μ s)	L-N and L-N/PE	25 kA
Follow current discharge capacity I_{fi} (AC)	L-N and L-N/PE	50 kA
Function		
Response time t_A	L-N and L-N/PE	≤ 100 ns
Connections		
Conductor cross-section	Finely stranded	25 mm ²
	Solid/stranded	35 mm ²
Protection devices		
Max. back-up fuse		None necessary because integrated coordinated back-up fuse contained in the device
Ambient conditions		
Degree of protection		IP20, with connected conductors
Temperature range		-40 ... +80 °C

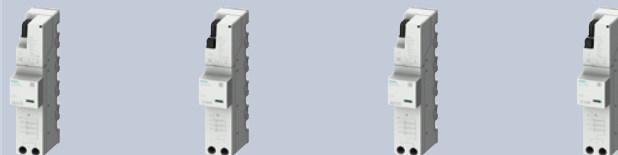
Accessories

Connection bars

	Version	Number of poles	Article No.
	1-phase	3-pole	5SD7490-6
		4-pole	5SD7490-7

5SD74 surge arresters, type 1 + type 2 + type 3 for 40 mm busbar system

Protection paths	For TN-C systems			
	L-PEN			
Lightning impulse current I_{imp} (10/350 μ s)	12.5 kA		7.5 kA	
Rated voltage U_n	240/415 V AC	240/415 V AC	240/415 V AC	240/415 V AC
Maximum continuous voltage U_c	300 V AC	300 V AC	300 V AC	300 V AC



Circuit	Mounting width				
With remote signaling					
3 + 0	47 mm	5SD7443-8KK21	–	5SD7443-8KK11	–
3 + 1	47 mm	–	–	–	–
With remote signaling and phase tap					
3 + 0	47 mm	–	5SD7443-8KK22	–	5SD7443-8KK12
3 + 1	47 mm	–	–	–	–

Further technical specifications

		5SD7443-8KK21	5SD7443-8KK22	5SD7443-8KK11	5SD7443-8KK12
Standards					
Standards		IEC 61643-11			
Approvals		VDE			
Voltage					
Protection level U_p	L-N and L-PEN	≤ 1.50 kV			
	L-N/N-PE				$\leq 1.5/1.5$ kV
Current					
Lightning impulse current I_{imp} (10/350 μ s)	L-N/N-PEN and N-PE	12.5 kA		7.5 kA	
Rated discharge surge current I_n (8/20 μ s)	L-N/L-PEN and N-PE	20 kA			
Follow current discharge capacity I_{fi} (AC)	N-PE	–			
Connections					
Conductor cross-section	Feindrahchtig	25 mm ²			
	Eindrahchtig	35 mm ²			
Type of mounting					
40 mm busbar system		5 and 10 mm			
Protection devices					
Max. back-up fuse acc. to IEC 61643-1	For stub wiring (GL/GG)	315 A			
Short-circuit strength	With max. back-up fuse	25 kA			
Ambient conditions					
Degree of protection		IP20			
Temperature range		–40 ... +80 °C			
Display					
Visual function/fault indication		Yes			

For TN-S and TT systems

L-N, L-PE and N-PE

12.5 kA		7.5 kA	
240/415 V AC	240/415 V AC	240/415 V AC	240/415 V AC
300 V AC	300 V AC	300 V AC	300 V AC








–	–	–	–
5SD7444-8KK21	–	5SD7444-8KK11	–
–	–	–	–
–	5SD7444-8KK22	–	5SD7444-8KK12

5SD7444-8KK21 | 5SD7444-8KK22 | 5SD7444-8KK11 | 5SD7444-8KK12

12.5 kA | 7.5 kA
 20/80 kA
 100 A RMS

5SD74 combination surge arresters, type 1/type 2

	For TN-C systems and IT networks	For TN-C systems	For TN-S and TT systems		For photovoltaic systems
Protection paths	L-PE	L-PEN	L-N, L-PE and N-PE	L-N, L-PE and N-PE	(L+) – (L–)
Rated voltage U_n	690 V AC	240/415 V AC	240 V AC	240/415 V AC	–
Maximum continuous voltage U_c	800 V AC	335 V AC	335 V AC	335 V AC	1000 V DC
					

Circuit	Mounting width					Plug-in
With remote signaling						
1 + 0	– ¹⁾	5SD7411-2	–	–	–	–
3 + 0	3 MW	–	5SD7413-3	–	–	–
3 + 1	4 MW	–	–	–	5SD7414-3	–
Without remote signaling						
1 + 1	2 MW	–	–	5SD7412-2	–	–
3 + 0	3 MW	–	5SD7413-2	–	–	5SD7483-6
3 + 1	4 MW	–	–	–	5SD7414-2	–

¹⁾ No modular installation device.

Further technical specifications

		5SD7411-2	5SD7412-2	5SD7413-2 5SD7413-3	5SD7414-2 5SD7414-3	5SD7483-6
Standards						
Standards		IEC 61643-11				EN 61643-31
Approvals		–	KEMA			–
Voltage						
Protection level U_p	L-N and L-PEN	≤ 4.50 kV	≤ 1.20 kV		≤ 3.50 kV	
	L-PE	–	–			≤ 2.0 kV
	N-PE	–	≤ 1.70 kV	–	≤ 1.70 kV	
Current						
Lightning impulse current I_{imp} (10/350 μs)	L-N and L-PEN	35 kA	12.5 kA	–		≤ 5 kA
	N-PE	–	50 kA	–	50 kA	–
Rated discharge surge current I_n (8/20 μs)	L-N and L-PEN	35 kA	12.5 kA	–		15 kA
	N-PE	–	50 kA	–		
Max. discharge surge current I_{max} (8/20 μs)	L-N	100 kA	12.5 kA	50 kA		40 kA
	N-PE	–	50 kA	–	50 kA	–
Function						
Response time t_A	L-N and L-PEN	< 100 ns	≤ 25 ns		–	
	L-N and N-PE	–	≤ 100 ns	–	≤ 100 ns	≤ 25 ns
Connections						
Conductor cross-section	Finely stranded	16 ... 50 mm ²	1.5 ... 25 mm ²			
	Solid	16 ... 50 mm ²	1.5 ... 35 mm ²			
Protection devices						
Max. back-up fuse acc. to IEC 61643-1	For stub wiring (gL/gG)	400 A	160 A			–
	For V wiring (gL/gG)	125 A	80 A			–
Short-circuit strength	With max. back-up fuse	50 kA	25 kA			–
Ambient conditions						
Degree of protection		IP20, with connected conductors				
Temperature range		–40 ... +80 °C				

Accessories

Spare part plugs



Protection paths	Type	Basic units	Article No.
N-PE	–	5SD7412-2, 5SD7412-3, 5SD7414-2 and 5SD7414-3	5SD7418-2
L-N and L-PEN	1	5SD7412-2, 5SD7412-3, 5SD7413-2, 5SD7413-3, 5SD7414-2 and 5SD7414-3	5SD7418-3
L-PE (PV)	2	5SD7483-6	5SD7498-3

5SD74 surge arresters, type 2




Standard design

	For TN and TT systems		For TN-C systems and IT networks		For TN-C systems		For IT networks	
Protection paths	N-PE	L-PEN and L-N	L-PEN and L-N	L-PEN	L-PEN and L-PE	L-PEN and L-PE	L-PEN and L-PE	
Rated voltage U_n	240/415 V AC	240/415 V AC	400/690 V AC	240/415 V AC	400/690 V AC	554/960 V AC		
Maximum continuous voltage U_c	260 V AC	350 V AC	800 V AC	350 V AC	580 V AC	760 V AC		



Circuit	Mounting width						
With remote signaling							
1 + 0	1 MW	–	5SD7461-1	–	–	–	–
	2 MW	–	–	5SD7481-1	–	–	–
3 + 0	3 MW	–	–	–	5SD7463-1	5SD7473-1	5SD7483-5
3 + 1	4 MW	–	–	–	–	–	–
Without remote signaling							
1 + 0	1 MW	5SD7481-0	5SD7461-0	–	–	–	–
3 + 0	3 MW	–	–	–	5SD7463-0	–	–
3 + 1	4 MW	–	–	–	–	–	–

Further technical specifications		5SD7481-0	5SD7461-0 5SD7461-1	5SD7481-1	5SD7463-0 5SD7463-1	5SD7464-0 5SD7464-1	5SD7473-1	5SD7483-5
Standards								
Standards		IEC 61643-11; DIN EN 61643-11						
Approvals		KEMA					–	KEMA, UL/cUL
Voltage								
Protection level U_p	L-N and L-PEN	–	≤ 1.50 kV	≤ 5 kV	≤ 1.50 kV	≤ 1.60 kV	≤ 2.50 kV	≤ 2.90 kV
	L-PE	–	–	–	–	≤ 1.90 kV	–	–
	N-PE	≤ 1.50 kV	–	–	–	≤ 1.50 kV	–	–
Current								
Rated discharge surge current I_n (8/20 μs)	L-N and L-PEN	–	20 kA	15 kA	20 kA	–	15 kA	–
	N-PE	20 kA	–	–	–	20 kA	–	–
Max. discharge surge current I_{max} (8/20 μs)	L-N	–	40 kA	30 kA	40 kA	–	30 kA	–
	N-PE	40 kA	–	–	–	40 kA	–	–
Function								
Response time t_A	L-N and L-PEN	–	≤ 25 ns	≤ 100 ns	≤ 25 ns	–	–	–
	L-N and N-PE	≤ 100 ns	–	–	–	≤ 100 ns	–	–
Connections								
Conductor cross-section	Finely stranded	1.5 ... 25 mm ²						
	Solid	1.5 ... 35 mm ²						
Protection devices								
Max. back-up fuse acc. to IEC 61643-1	For stub wiring (gL/gG)	–	125 A	100 A	125 A	–	–	100 A
	For V wiring (gL/gG)	–	–	80 A	–	–	–	–
Short-circuit strength	With max. back-up fuse	25 kA						
Ambient conditions								
Degree of protection		IP20, with connected conductors						
Temperature range		–40 ... +80 °C						

For TN-S and TT systems	Fuse bases for photovoltaic fuses	
L-N, L-PE and N-PE	(L+) – (L–); (L+) – PE; (L–) – PE	(L+) – (L–); (L+) – PE; (L–) – PE
240/415 V AC	–	–
350 V AC (L-N, L-PE)	1000 V DC	600 V DC
260 V AC (N-PE)		
		
–	–	–
–	–	–
–	–	–
5SD7464-1	–	–
–	–	–
–	5SD7483-0KK02	5SD7483-0KK01
5SD7464-0	–	–

5SD7483-0KK01 5SD7483-0KK02

EN 61643-31
KEMA
≤ 3.70 kV
–
–
15 kA
–
40 kA
–
≤ 25 ns
≤ 25 ns
1.5 ... 25 mm ²
1.5 ... 35 mm ²
–
–
–
IP20, with connected conductors
–40 ... +80 °C

Accessories

Spare part plugs



Protection paths	Basic units	Article No.
N-PE	5SD7481-0, 5SD7464-0 und 5SD7464-1	5SD7488-0
L-N and L-PEN	5SD7461-0, 5SD7461-1, 5SD7463-0, 5SD7463-1, 5SD7464-0 und 5SD7464-1	5SD7468-1
L-PEN	5SD7481-1 und 5SD7483-5	5SD7488-2
	5SD7481-1	5SD7488-4
L-PE (PV)	5SD7483-0KK02	5SD7498-4
	5SD7483-0KK01	5SD7498-5

5SD74 surge arresters, type 2

Narrow design

	For TN-S and TT systems	
Protection paths	L-N and N-PE	L-N and N-PE
Rated voltage U_n	240 V AC	240/415 V AC
Rated arrester voltage U_C ; L-N, N-PE, L-(PE)N	350 V AC	350 V AC
Rated arrester voltage U_C ; N-PE	264 V AC	264 V AC



Circuit	Mounting width	Rated discharge surge current I_n (8/20 μ s)			
		L-N or L-(PE)N	N-PE		
With remote signaling					
1 + 1	24 mm (1 1/3 MW)	20 kA	20 kA	5SD7422-1	–
3 + 1	48 mm (2 2/3 MW)	20 kA	20 kA	–	5SD7424-1
		20 kA	40 kA	–	–
Without remote signaling					
1 + 1	24 mm (1 1/3 MW)	20 kA	20 kA	5SD7422-0	–
3 + 1	48 mm (2 2/3 MW)	20 kA	20 kA	–	5SD7424-0
		20 kA	40 kA	–	–

Further technical specifications

5SD7422-0
5SD7422-1

5SD7424-0
5SD7424-1

Standards		
Standards		IEC 61643-11; EN 61643-11
Approvals		KEMA/UL/cUL
Voltage		
Protection level U_p	L-N and L-PEN	≤ 1.50 kV
	L-PE	≤ 1.90 kV
	N-PE	≤ 1.50 kV
Current		
Rated discharge surge current I_n (8/20 μ s)	L-N and L-PEN	20 kA
	N-PE	20 kA
Max. discharge surge current I_{max} (8/20 μ s)	L-N	40 kA
	N-PE	40 kA
Function		
Response time t_A	L-N and L-PEN	≤ 25 ns
	L-N and N-PE	≤ 100 ns
Connections		
Conductor cross-section	Finely stranded	2.5 ... 16 mm ²
	Solid	2.5 ... 25 mm ²
Protection devices		
Max. back-up fuse acc. to IEC 61643-1	For stub wiring (gL/gG)	315 A
	For V wiring (gL/gG)	63 A
Short-circuit strength	With max. back-up fuse	25 kA
Ambient conditions		
Degree of protection		IP20, with connected conductors
Temperature range		–40 ... +80 °C




Accessories

Spare part plugs



Protection paths	Basic units	Article No.
N-PE	5SD7422-0, 5SD7422-1, 5SD7424-0 and 5SD7424-1	5SD7428-0
L-N and L-PEN	5SD7422-0, 5SD7422-1, 5SD7424-0 and 5SD7424-1	5SD7428-1

5SD74 surge arresters, type 3

	For TN-S and TT systems		
Protection paths	L-N, L-PE, N-PE, (L+) – (L-) and (L+/L-) – PE	L-N, L-PE, N-PE, (L+) – (L-) and (L+/L-) – PE	L-N, L-PE, N-PE, (L+) – (L-) and (L+/L-) – PE
Rated voltage U_n	24 V AC	120 V AC	230 V AC
Rated arrester voltage U_c	34 V AC	150 V AC	264 V AC
			

Circuit	Mounting width			
With remote signaling				
1 + 0	1 MW	5SD7432-5	5SD7432-6	5SD7432-7

Further technical specifications

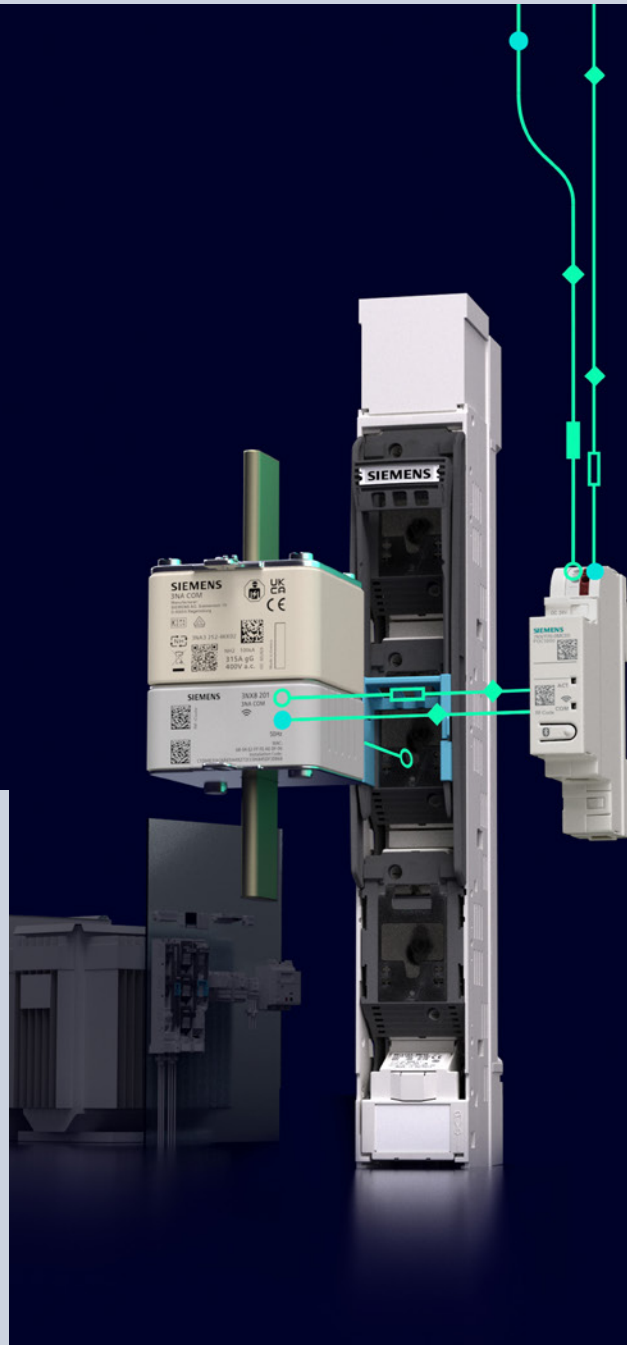
	5SD7432-5	5SD7432-6	5SD7432-7	
Standards				
Standards	IEC 61643-11; DIN EN 61643-11			
Approvals	KEMA/UR	KEMA/UL	KEMA/UR	
Voltage				
Protection level U_p	L-N, L-PE and N-PE	$\leq 200/\leq 600$ V	$\leq 750/\leq 850$ V	$\leq 1250/\leq 1400$ V
Current				
Rated load current I_L (at 30 °C)	26 A			
Rated discharge surge current I_n (8/20 μ s)	1 kA	5 kA		
Combined surge U_{oc}	2 kV	6 kV		
Function				
Response time t_A	≤ 100 ns			
Connections				
Conductor cross-section	Finely stranded	0.2 ... 2.5 mm ²		
	Solid	0.2 ... 4 mm ²		
Protection devices				
Required back-up fuse, max.	(gG/B/C)	25 A		
Ambient conditions				
Degree of protection	IP20, with connected conductors			
Temperature range	-40 ... +80 °C			
Display				
Visual function/fault indication	Yes			

Mandatory basic protection in electrical installations

Overcurrents in electrical installations occur as a result of excessive load or short-circuits and can cause serious accidents, fires and financial damage. Appropriate protection devices have therefore been mandatory ever since electricity was first harnessed to power equipment. As a pioneer in fuse systems, we offer you the complete range of devices for the protection of cables as well as electrical devices and installations in the event of overloads and short-circuits.

Fuses are capable of safely switching off circuits as soon as an overload or short-circuit occurs. This prevents damage to electrical equipment or extended power failures. Specific variants of fuse systems are used for different applications.

Among other things, our fuses are used for protecting cables and lines, switching devices and semiconductors as well as in photovoltaics and wind power.



Fuse Systems

All the information you need	7/2
System overview	7/4
Overview of fuse systems according to IEC	7/6
Fuse holders and bases	7/8
Quick selection guide	7/8
MINIZED fuse switch disconnectors	7/12
MINIZED switch disconnectors with fuses	7/13
NEOZED bus-mounting switch disconnectors with fuses	7/14
NEOZED fuse bases	7/16
DIAZED fuse bases	7/18
Bus-mounting bases for busbar systems	7/20
LV HRC fuse bases	7/22
Cylindrical fuse holders	7/24
Fuse holders and bases for SITOR semiconductor fuses	7/25
Fuse holders and bases for photovoltaic fuses	7/26
Class J fuse holders	7/28
Class CC fuse holders	7/29
Fuse links	7/30
Quick selection guide	7/30
NEOZED fuse links	7/32
DIAZED fuse links	7/33
SILIZED fuse links	7/34
LV HRC fuse links	7/36
3NA COM LV HRC fuse links with communication and measuring function	7/50
Cylindrical fuse links	7/52
SITOR semiconductor fuse links, LV HRC design (AC/DC)	7/54
SITOR semiconductor fuse links, LV HRC design (DC)	7/70
SITOR semiconductor fuses, cylindrical fuse design (AC/DC)	7/76
Photovoltaic fuse links	7/84
Class CC fuse links	7/86
Accessories	7/88
Busbars	7/88
LV HRC signal detectors, electronic fuse monitoring	7/94

A multitude of additional information ...

Information + ordering

All the important things at a glance

For information about fuse systems, please visit our website www.siemens.com/fuses

Your product in detail

The SiePortal platform (knowledge base) provides comprehensive information

www.siemens.com/lowvoltage/product-support

- Technology Primer
 - Fuse systems (109482303)

The relevant tender specifications can be found at www.siemens.com/tenderspecifications

Use our conversion tool for quick and easy conversion to Siemens products www.siemens.com/conversion-tool

Siemens YouTube channel

- Siemens fuse systems sie.ag/2J9ihb

Everything you need for your order

Refer to SiePortal to find an overview of your products (product catalog)

- Fuse systems sie.ag/2kW3pnU

Direct forwarding to the individual products in SiePortal by clicking on the article number in the catalog or entering this web address incl. article number www.siemens.com/product_catalog_SIEP?Article No.

Configurators

The configurator reduces the time and effort required in the planning and ordering process, and allows for individual adaptations. Configure your SITOR semiconductor fuse at

www.siemens.com/lowvoltage/sitor-configurator

The fast track to the experts

Contact persons in your region

We offer a comprehensive portfolio of services. You can find your local contacts at www.siemens.com/lowvoltage/components/contact

You will find further information on services at www.siemens.com/service-offers

Competent expert advice on technical questions with a wide range of demand-optimized services for all our products and systems.

Assistance with technical queries is provided at www.siemens.com/support-request

... can be found in our online services

Commissioning + operation

Your product in detail

The SiePortal platform (knowledge base) provides detailed technical information

www.siemens.com/lowvoltage/product-support

- Operating instructions
- Characteristic curves
- Certificates

Online Support app available for download from the [App Store](#) and [Play Store](#)

You will find further information at

www.siemens.com/support-app

Provision of 3D data (step and u3d data formats)

- SiePortal (product catalog)
www.siemens.com/lowvoltage/product-catalog
- Image database
www.siemens.com/lowvoltage/picturedb

Engineering data for CAD or CAE systems are available in the CAx Download Manager at

www.siemens.com/cax

Manuals

Manuals can be found in SiePortal at

www.siemens.com/lowvoltage/manuals

- Configuration Manual
 - Fuse systems **(45314810)**
- Planning Manual
 - Planning with SIVACON 8PS **(109478425)**
- Installation Manual
 - Circuit protection devices with communication and measuring function **(109791805)**
- System Manual
 - Circuit protection devices with communication and measuring function **(109791806)**



Face-to-face or online training

Our training courses can be found at

www.siemens.com/sitrain-lowvoltage

- SENTRON circuit protection devices with measuring and communication function (WT-LVBCOM)

Technical overview – Fuse systems



The fast way to get you to our online services

This page provides you with comprehensive information and links on fuse systems

www.siemens.com/lowvoltage/product-support **(109769085)**

System overview

Fuse holders and bases

IEC fuse holders and bases



MINIZED



NEOZED



DIAZED



Bus-mounting bases for busbars



Photovoltaic fuses (LV HRC design)

IEC/UL fuse holders and bases



LV HRC fuses



Cylindrical fuses



SITOR semiconductor fuses (LV HRC design)



SITOR semiconductor fuses (cylindrical fuse design)



Photovoltaic fuses (cylindrical fuse design)

UL fuse holders and bases

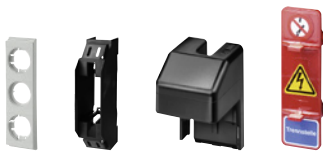


Class CC



Class J

Accessories for fuse holders and bases



Covers



Screw caps



Adapter sleeves

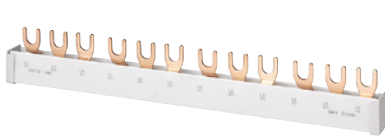


Isolating blades



LV HRC signal detectors

Busbars and accessories



Can be cut



Terminals



Touch protection



End caps

Note:

You will find a detailed range of accessories with the basic units.

Fuse links

IEC fuse links



NEOZED



DIAZED



LV HRC



LV HRC
(3NA COM)



Cylindrical
fuses



SILIZED



SILIZED



Photovoltaic fuses
(LV HRC design)



Photovoltaic fuses
(cylindrical fuse design)

IEC/UL fuse links



SITOR semiconductor fuses
(LV HRC design)



SITOR semiconductor fuses
(cylindrical fuse design)

UL fuse links



Class CC

Note:

You will find a detailed range of accessories with the basic units.

Overview of fuse systems according to IEC

Fuse links



	IEC	IEC
Standard	IEC	IEC
Rated current I_n	2 ... 100 A	2 ... 100 A
Rated voltage U_n (AC)	400 V	500 ... 750 V
Rated voltage U_n (DC)	250 V	500 ... 750 V
Design/application	NEOZED/SILIZED	DIAZED/SILIZED
Selection according to protection task		
Cables and conductors, general (gG, gFF)	■	■
Motor protection (aM)	-	-
Power semiconductor (aR, gR, gS)	■	■
Photovoltaic protection (gPV)	-	-
Battery protection (aR, gR, gBAT)	-	-
Type	5SE	5SA, 5SB, 5SC, 5SD
Further information	See page 7/32, 7/34	See page 7/33, 7/34

Fuse holders and bases

For protection tasks

Overview, see page 7/8

	Floor mounting	DIN rail	Busbar	Type	Standard	Further information		
Fuse bases 	-	■	■	5SG	IEC	See page 7/12	■	-
	■	■	■	5SF	IEC	See page 7/18	-	■
	■	-	-	3NH	IEC/UL	See page 7/22	-	-
	■	-	-	3NH7	IEC	See page 7/22	-	-
	-	■	■	3NW7	IEC/UL	See page 7/24	-	-
	-	■	-	3NC..	IEC/UL	See page 7/25	-	-
	-	■	-	3NW7...-4	IEC	See page 7/26	-	-
	-	■	-				-	-

For protection and switching tasks

System overview, see page 8/82, 8/116

	Floor mounting	DIN rail	Busbar	Type	Standard	Further information		
Fuse switch disconnectors 	■	■	■	3NP1	IEC/UL	See page 8/84	-	-
	■	-	■	3NP5	IEC/UL	See page 8/98	-	-
	-	■	■	5SG76	IEC	See page 8/114	■	-
	-	-	■	3NJ4	IEC	See page 8/102	-	-
Switch disconnectors with fuse 	■	■	-	3KF LV HRC	IEC	See page 8/128	-	-
	■	■	-	3KF SITOR	IEC/UL	See page 8/130	-	-
	-	-	■	3NJ63	IEC	See page 8/136	-	-
	-	■	■	5SG71	IEC	See page 8/144	■	-

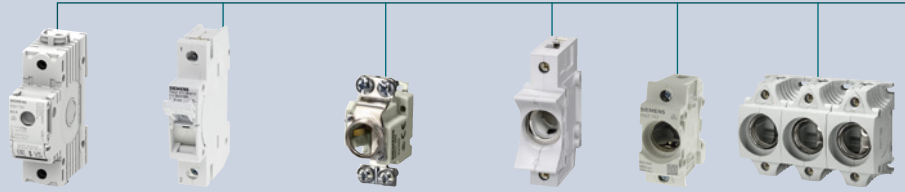
Overview, see page 7/30



IEC	IEC	IEC	IEC/UL	IEC/UL	IEC	UL
2 ... 1250 A	80 ... 315 A	0.5 ... 100 A	2 ... 2400 A	1 ... 125 A	2 ... 630 A	0.5 ... 30 A
400 ... 690 V	400 V	400 ... 690 V	500 ... 2500 V	600 ... 1500 V	-	600 V
250 ... 400 V	250 V	-	440 ... 3000 V	250 ... 1000 V	1000 ... 1500 V	150 ... 300 V
LV HRC	LV HRC	Cylindrical	SITOR LV HRC	SITOR cylindrical	Photovoltaic	Class CC
■	■	■	-	-	-	■
■	-	■	-	-	-	■
-	-	-	■	■	-	-
-	-	-	-	-	■	-
-	-	-	■	■	-	-
3NA, 3ND	3NA COM	3NW6, 3NW8	3NE, 3NC	3NC10	3NE..., 3NW...	3NW1, 3NW2, 3NW3
See page 7/36	See page 7/50	See page 7/52	See page 7/54	See page 7/78	See page 7/84	See page 7/86
-	-	-	-	-	-	-
-	-	-	-	-	-	-
■	■	-	■	-	-	-
-	-	-	-	-	■	-
-	-	■	-	-	-	■
-	-	-	-	■	-	-
-	-	-	-	-	■	-
■	■	-	■	-	-	-
■	■	-	■	-	-	-
-	-	-	-	-	-	-
■	■	-	-	-	-	-
■	■	-	(■)	-	-	-
-	-	-	■	-	-	-
■	■	-	-	-	-	-
-	-	-	-	-	-	-

Quick selection guide of fuse holders, bases and D0 fuse switching devices

IEC



MINIZED switch disconnectors with fuses	MINIZED fuse switch disconnectors	NEOZED fuse bases			NEOZED comfort bases	NEOZED fuse bases	DIAZED fuse bases
---	-----------------------------------	-------------------	--	--	----------------------	-------------------	-------------------

Basic data

Size/for fuses of size	D02	D01	D01	D02	D03	D01, D02	D01, D02	NDz, DII, DIII
Type	5SG71	5SG76	5SG15 5SG55	5SG16 5SG56	5SG18	5SG1301 5SG1701 5SG5301 5SG5701	5SG1302 5SG1702 5SG5302 5SG5702	5SF
Direction of incoming supply	Any	Any	From below			From below	From below	From below

Standards

Standards	DIN VDE 0638; IEC/EN 60947-3 (VDE 0660-107) IEC/EN 60947-3	DIN VDE 0638; IEC/EN 60947-3 (VDE 0660-107) IEC/EN 60947-3	IEC 60269-3; DIN VDE 0636-3			IEC 60269-3; DIN VDE 0636-3	IEC 60269-3; DIN VDE 0636-3	IEC 60269-3; DIN VDE 0635; DIN VDE 0636-3; CEE 16
-----------	---	---	--------------------------------	--	--	-----------------------------------	-----------------------------------	--

Approvals	–	–	–	–	–	–	–	–
Certifications	–	–	–	–	–	–	–	–

Technical specifications AC

Rated voltage U_n	V AC	230/400, 240/415	230/400, 240/415	400	400	400	–	–	500, 690, 750
Rated insulation voltage	V AC	500	690	–	–	–	–	–	–
Short-circuit strength	kA AC	50	50	50	50	50	50	50	50
Rated current I_n	A	63	16	16	63	100	16/63	16/63	2 ... 100
Rated impulse withstand voltage	kV AC	6	6	–	–	–	–	–	–
Utilization category	Acc. to VDE 0638	A	AC-22	AC-22	–	–	–	–	–
	Acc. to EN 60947-3	A	AC-22B, AC-23B (35A)	AC-22A	–	–	–	–	–

Technical specifications DC

Rated voltage	U_n	V DC	65 (1P), 130 (2P)	48 (1P), 110 (2P)	250	250	250	–	–	500, 600, 750
	U_n acc. to UL	V DC	–	–	–	–	–	–	–	–
Short-circuit strength		kA DC	–	–	8	8	8	8	8	–
Utilization category	Acc. to EN 60947-3	A	DC-22B	–	–	–	–	–	–	–

Further technical specifications

Overvoltage category		IV	IV	–	–	–	–	–	III; II (DIAZED fuse bases made of molded plastic for use at 690 V AC/ 600 V DC)
Max. power dissipation of fuse links (conductor cross-section used)	W	–	–	–	–	–	–	–	–
Pollution degree		–	–	–	–	–	–	–	–

Further information

See page 7/13	See page 7/12	See page 7/16	See page 7/18
---------------	---------------	---------------	---------------

¹⁾ Extended rated voltage up to 1000 V

IEC

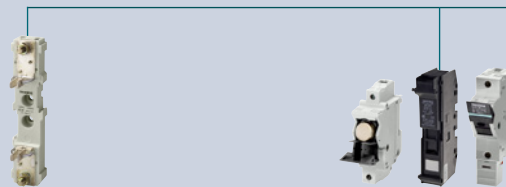


Cylindrical fuse holders		LV HRC fuse bases							Fuse bases for photovoltaic fuses	NEOZED bus-mounting bases for 8US 60 mm compact busbar systems	NEOZED bus-mounting bases for 8US 60 mm busbar systems	DIAZED bus-mounting bases for 8US 60 mm busbar systems	
8 × 32 mm	22 × 58 mm	000/00	0	1	2	3	4	1	D02	D02	DII	DII	
3NW73..	3NW72..	–	–	–	–	–	–	3NH7...-4	5SG6208	5SG6202 5SG6206 5SG6207	5SF6014 5SF6015 5SF6020	5SF6214 5SF6215 5SF6220	
Any		Any							Any	From the busbar	From the busbar	From the busbar	
IEC 60269-1, -2, -3; NF C 60-200, NF C 63-210, -211; NBN C 63269-2-1; CEI 32-4, -12; UL 4248-1		IEC 60269-1, -2; EN 60269-1; DIN VDE 0636-2, UL 4248-1 (only downstream from the branch protection)							IEC 60269, IEC 60269-2	IEC 60269-3, DIN VDE 0636-3	IEC 60269-3, DIN VDE 0636-3	IEC 60269-3, DIN VDE 0636-3	IEC 60269-3, DIN VDE 0636-3
UL File number E171267		KEMA; UL file number E171267-IZLT2							–	–	–	–	–
–	–	–	–	–	–	–	–	–	–	–	–	–	
400	690	690 ¹⁾	690 ¹⁾	690 ¹⁾	690 ¹⁾	690 ¹⁾	690	–	400	400	500	690	
–	–	–	–	–	–	–	–	–	–	–	–	–	
20	100	–	–	–	–	–	–	–	–	–	–	–	
20	100	160	160	250	400	630	1250	160	63	63	25	63	
–	–	–	–	–	–	–	–	–	–	–	–	–	
–	–	–	–	–	–	–	–	–	–	–	–	–	
AC-20B (switching without load)		–	–	–	–	–	–	–	–	–	–	–	
–	–	250	440	440	440	440	440	1000	250	250	–	600	
–	–	–	–	–	–	–	–	–	–	–	–	–	
–	–	25	25	25	25	25	25	–	8	8	8	8	
DC-20B (switching without load)		–	–	–	–	–	–	DC-20B (switching without load)	–	–	–	–	
–	–	–	–	–	–	–	–	–	–	–	–	–	
–	–	12	25	32	45	60	90	40	–	–	–	–	
–	–	–	–	–	–	–	–	–	–	–	–	–	
See page 7/24		See page 7/22							See page 7/26	See page 7/20			

7

Quick selection guide of fuse holders, bases and D0 fuse switching devices

IEC/UL

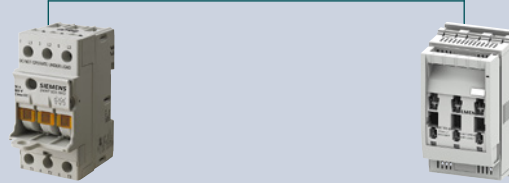


	LV HRC fuse bases					Fuse holders for SITOR semiconductor fuses (cylindrical fuse design)					
Basic data											
Size/for fuses of size	000/00	0	1	2	3	10 × 38 mm	14 × 51 mm	22 × 58 mm	22 × 127 mm		
Type ²⁾	3NH3030 3NH4030	3NH3120	3NH3220 3NH3230 3NH4230	3NH3320 3NH3330	3NH3420 3NH3430	3NC10	3NC14	3NC22	3NC23		
Direction of incoming supply	Any					Any					
Standards											
Standards	IEC 60269-1, -2; EN 60269-1; DIN VDE 0636-2, UL 4248-1 (only downstream from the branch protection)					UL 4248-1; CSA C22.2; IEC 60269-2, IEC 60947-3	UL 4248-1; CSA C22.2; IEC 60269-2, IEC 60947-3	UL 4248-1; CSA C22.2; IEC 60269-2, IEC 60947-3	IEC 60269-2, IEC 60947-3		
Approvals	KEMA; UL file number E171267-IZLT2					UL 4248-1; UL File number E171267; CSA C22.2 No. 39-M				–	
Certifications	–					☉, ☉	☉, ☉	☉, ☉	–		
Technical specifications AC											
Rated voltage	U_n	V AC	690 ¹⁾	690 ¹⁾	690 ¹⁾	690 ¹⁾	690 ¹⁾	690	690	690	1500
	U_n acc. to UL	V AC	690	690	1000	1000	1000	600	600	600	–
	U_n acc. to CSA	V AC	600	600	600	600	600	–	–	–	–
Rated insulation voltage		V AC	–	–	–	–	–	–	–	–	–
Short-circuit strength		kA AC	–	–	–	–	–	50	50 (100 at 400 V)	50 (100 at 500 V)	30
Rated current	I_n	A	160	160	250	400	630	32	50	100	63
	I_n acc. to UL	A	160	160	250	–	500	30	50	80	–
	I_n acc. to CSA	A	160	160	250	–	850	30	40	80	–
Rated impulse withstand voltage		kV AC	–	–	–	–	–	6	6	6	–
Utilization category	Acc. to VDE 0638	A	–	–	–	–	–	–	–	–	–
	Acc. to EN 60947-3	A	–	–	–	–	–	AC-22B (400 V)	AC-22B (400 V)	AC-20B (690 V)	AC-20B
Technical specifications DC											
Rated voltage	U_n	V DC	250	440	440	440	440	800			1000
	U_n acc. to UL	V DC	–	–	–	–	–	–	–	–	–
Short-circuit strength		kA DC	25	25	25	25	25	–	–	–	50
Utilization category	Acc. to EN 60947-3	A	–	–	–	–	–	–	–	–	DC-20B
Further technical specifications											
Overvoltage category			–	–	–	–	–	–	–	–	–
Max. power dissipation of fuse links (conductor cross-section used)		W	12	25	32	45	60	3 (6 mm ²), 4.3 (10 mm ²)	5 (10 mm ²), 6.5 (25 mm ²)	9.5 (35 mm ²), 11 (50 mm ²)	15 (1 ... 50 mm ²)
Pollution degree			–	–	–	–	–	2	2	2	–
Further information											
	See page 7/22					See page 7/25					

¹⁾ Extended rated voltage up to 1000 V²⁾ Types with UL approval and types with CSA approval may differ






IEC/UL

UL



Cylindrical fuse holders		Cylindrical fuse holders for PV fuses		Class CC fuse holders	Class J fuse holders				
10 x 38 mm	14 x 51 mm	10 x 38 mm	10 x 85 mm	–	–				
3NW70.. 3NW703.-1	3NW71..	3NW70..-4	3NW76..-4	3NW75.3-0HG 3NW753.-1HG	3NW75.3-3HG, 3NW75.3-5HG, 3NW75.3-6HG, 3NW75.3-7HG, 3NW75.3-8HG, 3NW7431-6HG, 3NW7431-7HG, 3NW7431-8HG				
Any		Any		Any	Any				
IEC 60269-1, -2, -3; NF C 60-200, NF C 63-210, -211; NBN C 63269-2-1; CEI 32-4, -12; UL 4248-1		IEC 60269, IEC 60269-2, IEC 60947, UL 4248-1, -18	IEC 60269, IEC 60269-2, IEC 60947, UL 4248-1, -18	UL 4248-1; CSA C22.2	UL 4248-1 Ed.1, UL 4248-8 Ed.1				
UL File number E171267		RV (File number E469670, CCC) (types without signal detector)	RV (E355487)	UL 4248-1; UL File number E171267; CSA C22.2	UL File number E171267; CSA File number 233322; Class number 6225-01				
RV, CE	RV	–	–	–	UL, CE	UL, CE	RV US	RV US	UL, CE Busbar device: RV US
690	690	–	–	–	–	–	–	–	–
600	700	–	–	600	600	600	600	600	600
–	–	–	–	–	–	–	–	–	–
100	100	–	–	200	200	200	200	200	200
32	50	30	32	30	30	60	100	200	400
–	–	–	–	–	–	–	–	–	–
–	–	–	–	–	–	–	–	–	–
–	–	6	–	6	No information as the devices are only tested and certified to UL/CSA and not to IEC				
–	–	–	–	–	–				
AC-20B (switching without load)		–	–	AC-20B (switching without load)	AC-20B (switching without load)				
–	–	1000	1500	300	–	–	–	–	–
–	–	–	–	–	600	600	600	600	600
–	–	–	–	–	–	–	–	–	–
DC-20B (switching without load)		–	–	DC-20B (switching without load)	DC-20B (switching without load)				
–	–	II	–	II	No information as the devices are only tested and certified to UL/CSA and not to IEC				
–	–	4	6	3 (6 mm ²), 4.3 (10 mm ²)	–				
–	–	2	–	2	No information as the devices are only tested and certified to UL/CSA and not to IEC				
See page 7/24		See page 7/26		See page 7/29	See page 7/28				

MINIZED fuse switch disconnectors

		Number of poles				
		1P	1P+N	2P	3P	3P+N
						
Size	I_n					
D01	2 ... 6 A	5SG7611-0KK06	–	–	5SG7631-0KK06	–
	10 A	5SG7611-0KK10	–	–	5SG7631-0KK10	–
	16 A	5SG7611-0KK16	5SG7651-0KK16	5SG7621-0KK16	5SG7631-0KK16	5SG7661-0KK16

Note:

NEOZED adapter sleeves are not required for these devices

7

Accessories






Electronic fuse monitor



- For all low-voltage fuse systems
- For monitoring all types and versions of melting fuses that cannot be equipped with a fault signal contact
- Can be used in asymmetric systems afflicted with harmonics and regenerative feedback motors
- Signal also for disconnected loads

U_e AC	I_n	U_c	Article No.
230 V	4 A	3 AC 380 ... 415 V	5TT3170

MINIZED switch disconnectors with fuses

		Number of poles				
		1P	1P+N	2P	3P	3P+N
						
Size	I_n					
D02	25 A	–	–	–	5SG7133-8BA25 ¹⁾	–
	35 A	–	–	–	5SG7133-8BA35 ¹⁾	–
	50 A	–	–	–	5SG7133-8BA50 ¹⁾	–
	63 A	5SG7113	5SG7153	5SG7123	5SG7133	5SG7163

¹⁾ Versions for Austria only, with permanently fitted adapter sleeves and incl. fuse link

Note:

NEOZED adapter sleeves are required for these devices, [see page 7/16](#)
Use fuse links from 35 A with silver-plated contact caps, [see page 7/32](#)

Accessories

Reducers



Use

For D01 fuse links in MINIZED switch disconnectors with fuses D02

Article No.

5SH5527

Auxiliary switches (AS)



Version

1 NO + 1 NC
2 NO
2 NC

Article No.

5ST3010
5ST3011
5ST3012

Auxiliary switches (AS) with TEST button



Version

1 NO + 1 NC
2 NO
2 NC

Article No.

5ST3010-2
5ST3011-2
5ST3012-2

5ST3 COM Auxiliary switches and fault signal contacts (AS+FC) with communication and measuring function



- Wireless information about manual ON/OFF, temperature, operating cycles, operating hours, warnings

Article No.

5ST3062-0MC

Electronic fuse monitor



- For all low-voltage fuse systems
- For monitoring all types and versions of melting fuses that cannot be equipped with a fault signal contact
- Can be used in asymmetric systems afflicted with harmonics and regenerative feedback motors
- Signal also for disconnected loads

U_e AC

230 V

I_n

4 A

U_c




3 AC 380 ... 415 V

Article No.

5TT3170

NEOZED bus-mounting switch disconnectors with fuses

For 8US 60 mm busbar systems

Mounting width	Size D02		
	1.5 MW	1.5 MW	1.5 MW
			

For flat copper profiles	I_n IEC	UL 508	U_n			Standard	Without LED signal detector			With LED signal detector
			IEC AC	IEC DC	UL 508					
Box terminals										
5 mm and 10 mm	63 A ¹⁾	–	400 V AC	–	–	IEC	5SG7234-1	–	5SG7234-2	
	63 A ²⁾	–	400 V AC	110 V DC	–	IEC	–	5SG7230	–	

¹⁾ In the case of permanent load over 35 A, we recommend the use of lateral module 5SH5533. Please observe EN 60439-1, Table 1.

²⁾ In the case of permanent load over 35 A, we recommend the use of lateral module 5SH5526. Please observe EN 60439-1, Table 1.

7

Suitable accessories

Auxiliary switches



- For signaling the switching state for bus-mounting switch disconnectors

Contacts	Mounting width	Article No.	Article No.	Article No.
1 CO	0.5 MW	–	5SH5525	–

Lateral modules



- For greater heat dissipation for loads from 35 A

Mounting width	Article No.	Article No.	Article No.
0.5 MW	5SH5533	5SH5526	5SH5533

Reducers



- Use
- For NEOZED D01 fuse links in bus-mounting switch disconnectors

Use	Article No.	Article No.	Article No.
For NEOZED D01 fuse links in bus-mounting switch disconnectors	5SH5527	5SH5527	5SH5527

Electronic fuse monitor









- For all low-voltage fuse systems
- For monitoring all types and versions of melting fuses that cannot be equipped with a fault signal contact
- Can be used in asymmetric systems afflicted with harmonics and regenerative feedback motors
- Signal also for disconnected loads

U_e AC	I_n	U_c	Article No.	Article No.	Article No.
230 V	4 A	3 AC 380 ... 415 V AC	5TT3170	5TT3170	5TT3170



See Busbar systems, [from page 13/1 onwards](#)

NEOZED fuse bases

Number of poles	Comfort bases made of molded plastic		Fuse bases made of molded plastic				
	1P	3P	Without LED signal detector		With LED signal detector		
							
Size	I_n						
D01	16 A	5SG1301	5SG5301	5SG1302	5SG5302	5SG1302-1	5SG5302-1
D02	63 A	5SG1701	5SG5701	5SG1702	5SG5702	5SG1702-1	5SG5702-1
D03	100 A	–	–	–	–	–	–

Accessories

NEOZED screw caps

	Material	Version	Fuse size	Article No.
	Molded plastic	With inspection hole	D01	5SH4116
			D02	5SH4163
	Ceramic	Without inspection hole, sealable	D01	5SH4316
			D02	5SH4363
		Without inspection hole	D03	5SH4100
			With inspection hole	D01
D02	5SH4362			

NEOZED adapter sleeves

	Fuse size	I_n	Color	Article No.
	D01	2 A	Pink	5SH5002
		4 A	Brown	5SH5004
		6 A	Green	5SH5006
		10/13 A	Red	5SH5010
	D02	20 A	Blue	5SH5020
		25 A	Yellow	5SH5025
		32 A	Violet	5SH5032
		35/40 A	Black	5SH5035
		50 A	White	5SH5050
	D03	80 A	Silver	5SH5080
	D01 fuse links in D02 base or MINIZED switch disconnectors with fuses D02	2 A	Pink	5SH5402
		4 A	Brown	5SH5404
		6 A	Green	5SH5406
		10/13 A	Red	5SH5410
		16 A	Gray	5SH5416

Fuse bases made of ceramic

With clamp-type terminal, on both sides

1P



5SG1553

–

–

3P



5SG5553

–

–

With saddle terminal, on both sides

1P



–

5SG1653

–

3P



–

5SG5653

–

With screw head contact at incoming feeder,
clamp-type terminal at outgoing feeder

1P



–

5SG1693

5SG1812

3P



–

5SG5693

–

NEOZED covers



Fuse size

D03

Article No.

5SH5233

NEOZED adapter sleeve fitters



Article No.

5SH5100

NEOZED retaining springs



Use

For D01 fuse links in D02 screw caps, 2 ... 16 A

Article No.

5SH5400

Electronic fuse monitor



- For all low-voltage fuse systems
- For monitoring all types and versions of melting fuses that cannot be equipped with a fault signal contact
- Can be used in asymmetric systems afflicted with harmonics and regenerative feedback motors
- Signal also for disconnected loads

 U_e AC

230 V

 I_n

4 A




 U_c

3 AC 380 ... 415 V

Article No.

5TT3170

DIAZED fuse bases



Size	I_n	U_n AC/DC	Fuse bases made of molded plastic With box terminal		Fuse bases made of ceramic With clamp-type terminal, on both sides
			Number of poles	1P	3P
DII	25 A	500 V/500 V			
DIII	63 A	500 V/500 V			
		750 V/750 V			
			5SF1060	5SF5068	5SF1005
			5SF1260 ¹⁾	5SF5268 ¹⁾	–
			–	–	–

¹⁾ Can also be used for 690 V AC/600 V DC.

7



Accessories

DIAZED screw caps

	Material	Version	Fuse size	Rated voltage AC/DC	Article No.
	Molded plastic	With inspection hole	NDz	500 V/500 V	5SH1112
			DII	500 V/500 V	5SH1221
			DIII	500 V/500 V	5SH1231
	Ceramic	Without inspection hole	DII	500 V/500 V	5SH112
			DIII	500 V/500 V	5SH113
		With inspection hole, sealable	DII	500 V/500 V	5SH122
			DIII	500 V/500 V	5SH123
		Extended version	DIII	690 V/600 V	5SH1170
		With fine thread	DIII	750 V/750 V	5SH1161

DIAZED screw adapters

- Also for 5SF230 up to 750 V

Fuse size	I_n	Article No.	
	DII	2 A	5SH310
		4 A	5SH311
		6 A	5SH312
		10 A	5SH313
		16 A	5SH314
		20 A	5SH315
		25 A	5SH316
	DIII	32 A	5SH327
		35 A	5SH317
		50 A	5SH318
		63 A	5SH320

With clamp-type terminal
at incoming feeder, saddle
terminal at outgoing feeder

1P



-

5SF1205¹⁾

-

With screw head contact,
on both sides

1P



-

-

5SF4230

DIAZED reduction sleeves for screw caps



Use

For DII fuse links in DIII base

Article No.

5SH302

DIAZED screw adapter keys



Use

For DII/DIII screw adapters

Article No.

5SH3703

DIAZED cover rings



Fuse size

DII

Material

Molded plastic

Article No.

5SH3401

DIII

Molded plastic

5SH3411

Electronic fuse monitor



- For all low-voltage fuse systems
- For monitoring all types and versions of melting fuses that cannot be equipped with a fault signal contact
- Can be used in asymmetric systems afflicted with harmonics and regenerative feedback motors
- Signal also for disconnected loads

U_e AC

230 V

I_n

4 A

U_c







3 AC 380 ... 415 V

Article No.

5TT3170

Bus-mounting bases

For busbar systems

				60 mm compact busbar systems		60 mm busbar systems		
				NEOZED design		NEOZED design		DIAZED design
				3P		3P		3P
								
								
Size	I_n	Mounting width	U_n AC/DC	With touch protection cover	Standard	With touch protection cover	Standard	With touch protection cover
D02	63 A	1.5 MW	–	–	5SG6202 ¹⁾	5SG6206 ¹⁾	–	–
		2 MW	–	5SG6208	–	5SG6207	–	–
DII	25 A	–	500 V/500 V	–	–	–	5SF6015	5SF6020
DIII	63 A	–	500 V/500 V ²⁾	–	–	–	5SF6215	5SF6220

¹⁾ From 35 A continuous current load, mount the fuse base with spacing and use a wider cover.



²⁾ Can also be used for 690 V AC/600 V DC

Note:

NEOZED adapter sleeves and DIAZED screw adapters as well as the respective screw caps are required, [see page 7/16](#) and [7/18](#)

7

Accessories

Covers for bus-mounting base standard version for 60 mm busbar systems				
Design	Fuse size	Version	Mounting width (1 MW = 18 mm)	Article No.
	D02	Standard	1.5 MW	5SH5241
		Extra wide	2 MW	5SH5242
		Double width	3 MW	5SH5243
	DII			5SH2042
		DIII		5SH2242

Electronic fuse monitor			
U_c AC	I_n	U_c	Article No.
230 V	4 A	3 AC 380 ... 415 V	5TT3170

- For all low-voltage fuse systems
- For monitoring all types and versions of melting fuses that cannot be equipped with a fault signal contact
- Can be used in asymmetric systems afflicted with harmonics and regenerative feedback motors
- Signal also for disconnected loads

See Busbar systems, [from page 13/1 onwards](#)

LV HRC fuse bases

Ceramic					
Number of poles 1P					
Size	I_n	Flat terminals	Plug-in terminal	Saddle-type terminal	Double busbar terminal
000/00	160 A	3NH3030	3NH3031	3NH3032	–
0 ¹⁾	160 A	3NH3120	–	–	–
1	250 A	3NH3230	–	–	3NH3220
2	400 A	3NH3330	–	–	3NH3320
3	630 A	3NH3430	–	–	3NH3420
4	1250 A	3NH3530	–	–	–
4a	1250 A	–	–	–	–

¹⁾ No longer to be used for new installations!

7

Accessories

LV HRC protective covers for LV HRC fuse bases



- As touch protection for contact pieces

Size	Article No.
000/00	3NX3105
0	3NX3114
1	3NX3106
2	3NX3107
3	3NX3108

LV HRC partitions for LV HRC fuse bases



- As intermediate phase and end barrier

Size	Type	Article No.
000/00	3NH30/3NH40	3NX2023
0	3NH31	3NX2030
1	3NH32	3NX2024
2	3NH33	3NX2025
3	3NH34	3NX2026

LV HRC protective covers







Size	Number of poles	Article No.
000/00	1P and 3P	3NX3115

Grip lug cover for plugging into the LV HRC protective cover



Size	Use	Article No.
000/00	When using fuse links with non-insulated grip lugs	3NX3116

3P		Molded plastic		With swivel device	
					
Flat terminals	Saddle-type terminal	Flat terminals	Flat terminals		
3NH4030	3NH4032	3NH3051	–		
–	–	–	–		
3NH4230	–	–	–		
–	–	–	–		
–	–	–	–		
–	–	–	–		
–	–	–	–		
–	–	–	–		3NH7520

Blanking covers for LV HRC fuse bases (instead of LV HRC fuse link)



- Red color
- With inscription "Isolating point"
- Observe width 60 mm of the blank insert when using for size 1

Size	Article No.
000/00	3NX1003
1, 2, 3	3NX1004

Fuse pullers for LV HRC fuse links



Size	Version	Article No.
000 ... 3	Without sleeve	3NX1013
	With sleeve	3NX1014

Isolating blades for LV HRC fuse bases and fuse switch disconnectors



Version	Contacts	Size	Article No.
With insulated grip lugs	Silver-plated	000/00	3NG1002
		0	3NG1102
		1	3NG1202
		2	3NG1302
		3	3NG1402
With non-insulated grip lugs	Tin-coated	4	3NG1503
	Nickel-plated	4a	3NG1505

Cylindrical fuse holders

Number of poles

1P

1P+N

2P

3P

3P+N



For fuses of size	I_n	Standard	Standard	Standard	Standard	Compact	Bus-mounting fuse holders	Standard
Without LED signal detector								
8 × 32 mm	20 A	3NW7313	3NW7353	3NW7323	3NW7333	–	–	3NW7363
10 × 38 mm	30 A	–	–	–	–	–	3NW7431	–
	32 A	3NW7013	3NW7053	3NW7023	3NW7033	3NW7033-1	–	3NW7063
14 × 51 mm	50 A	3NW7111	3NW7151	3NW7121	3NW7131	–	–	3NW7161
22 × 58 mm	100 A	3NW7211	3NW7251	3NW7221	3NW7231	–	–	3NW7261
With LED signal detector								
8 × 32 mm	20 A	3NW7314	3NW7354	3NW7324	3NW7334	–	–	3NW7364
10 × 38 mm	32 A	3NW7014	3NW7054	3NW7024	3NW7034	3NW7034-1	–	3NW7064
	50 A	3NW7112	3NW7152	3NW7122	3NW7132	–	–	3NW7162
22 × 58 mm	100 A	3NW7212	3NW7252	3NW7222	3NW7232	–	–	3NW7262

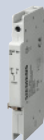
Note:

Semiconductor fuses heat up substantially more than standard fuses of operational classes gG and aM.

We therefore recommend only using SITOR cylindrical fuses in the intended SITOR fuse holders and complying with the maximum permissible current-carrying capacity.

Accessories

Auxiliary switches for cylindrical fuse holders, standard



- For retrofitting using the factory-fitted brackets

Display	Fuse link size	Article No.
Disconnection of fuse link, for striker fuse links only	14 × 51 mm	3NW7901
	22 × 58 mm	3NW7902
Switching state of fuse holder	8 × 32 mm and 10 × 38 mm	3NW7903

Auxiliary switches for cylindrical fuse holders, compact



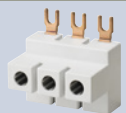
$I_n/AC-12$	U_n	Contacts	Article No.
5 A	Max. 250 V	1 NO + 1 NC	3NW7903-1

Busbars for cylindrical fuse holders, compact



Number of poles	I_n	Pin spacing	Length	Article No.
2 × 3P	63 A	15 mm	45 mm	5ST2601
3 × 3P	63 A	15 mm	90 mm	5ST2602
4 × 3P	63 A	15 mm	135 mm	5ST2603
5 × 3P	63 A	15 mm	180 mm	5ST2604

Terminals for cylindrical fuse holders, compact

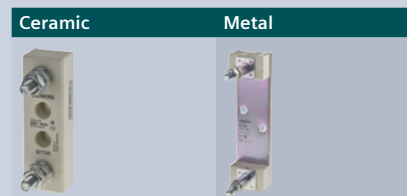


Version	Article No.
For conductor cross-sections 2.5 ... 35 mm ²	5ST2600

See Busbar systems, [from page 13/1 onwards](#)

Fuse holders and bases for SITOR semiconductor fuses

For SITOR fuses with bolt-on links or blade contacts



I_n	U_n AC/DC	For fuse series	Mounting dimensions	Ceramic	Metal
50 A	690 V	3NC18	75 mm	3NH5723	–
315 A	690 V	3NE87, 3NC26	80 mm	3NH5023	–
400 A	690 V	3NE80...3MK	80 mm	3NH5323	–
630 A	1800 V	3NE53, 3NE56	170 mm	–	3NH5473
1250 A	1250 V	3NC24, 3NC33...-1U, 3NC34...-1U, 3NC84, 3NE1...-3, NE32, 3NE33	110 mm	–	3NH5463
1600 A	690 V	3NE82...3MK	80 mm	–	3NH5423

7

For cylindrical fuses

Cylindrical fuse holders, can be used as fuse switch disconnectors

Number of poles

1P



2P



3P

For fuses of size	U_n AC/DC	With signaling switch			
10 × 38 mm	600 V/–	–	–	–	–
	690 V/800 V	3NC1091	–	3NC1092	3NC1093
14 × 51 mm	690 V/800 V	3NC1491	3NC1491-5	3NC1492	3NC1493
22 × 58 mm	690 V/800 V	3NC2291	3NC2291-5	3NC2292	3NC2293
22 × 127 mm	1500 V/1000 V	3NC2391-0MK	–	3NC2392-0MK	3NC2393-0MK

Note:

Please comply with the maximum permissible current-carrying capacity.

Accessories

Fuse tongs



For fuses of size

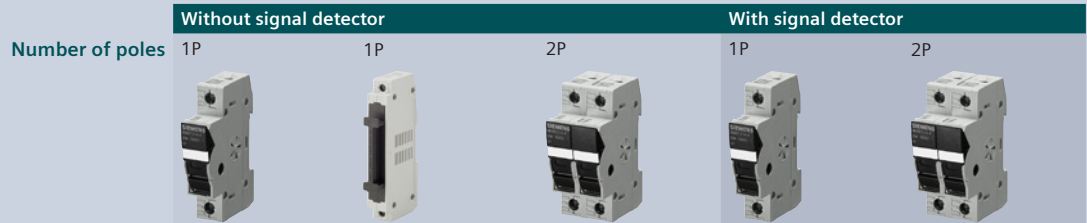
10 × 38 mm
14 × 51 mm
22 × 58 mm

Article No.

3NC1000

Fuse holders and bases for photovoltaic fuses

Cylindrical fuse holders for PV fuses



For fuses of size	I_n	U_n DC					
10 × 38 mm	30 A	1000 V	3NW7013-4	–	3NW7023-4	3NW7014-4	3NW7024-4
10 × 85 mm	32 A	1500 V	–	3NW7613-4	–	–	–








LV HRC fuse bases for PV fuses

With flat terminals, ceramic









Size	I_n	U_n DC	
1	250 A	1000 V	3NH3230


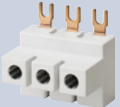
Class J fuse holders

Number of poles	For mounting on DIN mounting rail			For screwing onto mounting plate	Bus-mounting fuse holders for 8US 60 mm busbar systems			
	1P	2P	3P	3P	3P	3P	3P	
								
For fuses of size	I_n	U_n						
21 × 57 mm	30 A	600 V	3NW7511-3HG	3NW7521-3HG	3NW7531-3HG	–	–	–
27 × 60 mm	60 A	600 V	3NW7511-5HG	3NW7521-5HG	3NW7531-5HG	–	–	–
28 × 118 mm	100 A	600 V	–	–	–	3NW7531-6HG	3NW7431-6HG	–
41 × 146 mm	200 A	600 V	–	–	–	3NW7531-7HG	–	3NW7431-7HG
54 × 181 mm	400 A	600 V	–	–	–	3NW7531-8HG	–	3NW7431-8HG

Class CC fuse holders

		Standard			Compact		Bus-mounting fuse holders for 8US 60 mm busbar systems
Number of poles		1P	2P	3P	3P		3P
							
I_n	U_n			Signal detector without		with	
30 A	600 V	3NW7513-0HG	3NW7523-0HG	3NW7533-0HG	3NW7533-1HG	3NW7534-1HG	3NW7431-0HG

Accessories

Busbars for Class CC fuse holders, compact						
	Number of poles	I_n	Pin spacing	Length	Article No.	
	2 × 3P	63 A	15 mm	45 mm	5ST2601	
	3 × 3P	63 A	15 mm	90 mm	5ST2602	
	4 × 3P	63 A	15 mm	135 mm	5ST2603	
	5 × 3P	63 A	15 mm	180 mm	5ST2604	
Terminals for Class CC fuse holders, compact						
	Version	Article No.				
	For conductor cross-sections 2.5 ... 35 mm ²	5ST2600				

Quick selection guide of fuse links

IEC



NEOZED fuse links	DIAZED fuse links	SILIZED fuse links	LV HRC fuse links	3NA COM LV HRC fuse links ¹⁾
-------------------	-------------------	--------------------	-------------------	---

Basic data

Design	NEOZED	DIAZED	NEOZED, DIAZED	LV HRC	LV HRC
Size/for fuses of size	D01, D02, D03	NDz, DII, DIII	D01, D02, DII, DIII, DIV	000/00, 0, 1, 2, 3, 4, 4a	2
Operational class	gG	gG	gR	gG, aM	gG, gFF
Rated current	A	2 ... 100	10 ... 100	2 ... 1250	80 ... 315

Standards

Standard	IEC 60269-3; DIN VDE 0636-3	IEC 60269-3; DIN VDE 0635; DIN VDE 0636-3; CEE 16	IEC 60269-3/-4; DIN VDE 0636-3; EN 60269-4 (VDE 0636-4)	IEC 60269-1/-2; EN 60269-1/-2; DIN VDE 0636-1/-2	IEC 60269-1/-2; EN 60269-1/-2; DIN VDE 0636-1/-2
Approvals	VDE	VDE	–	CSA 22.2, VDE	VDE, KEMA

Technical specifications AC

Rated voltage AC	V	400	500 ... 750	400 ... 500	400 ... 690 600 (CSA)	400
Rated breaking capacity AC	kA	50	50	50	120	100

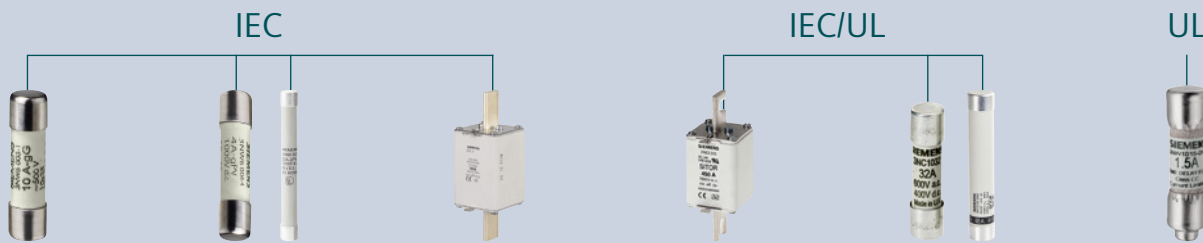
Technical specifications DC

Rated voltage DC	V	250	500 ... 750	250 ... 500	250 ... 440	–
Rated breaking capacity DC	kA	8	8	8	25	–

Further information

See page 7/32	See page 7/33	See page 7/34	See page 7/36	See page 7/50
---------------	---------------	---------------	---------------	---------------

¹⁾ With current measuring function and wireless communication



Cylindrical fuse links	Photovoltaic fuse links, cylindrical fuse design	Photovoltaic fuse links, LV HRC design	SITOR semiconductor fuse links, LV HRC design (AC/DC) and LV HRC design (DC)	SITOR semiconductor fuse links, cylindrical fuse design (AC/DC)	Class CC fuse links
Cylindrical	Cylindrical	LV HRC	LV HRC	Cylindrical	Cylindrical
8 × 32 mm, 10 × 38 mm, 14 × 51 mm, 22 × 58 mm	10 × 38 mm, 10 × 85 mm	1, 1L, 2L, 3L, 1XL, 2XL	000, 00, 1, 2, 3	10 × 38 mm, 14 × 51 mm, 22 × 58 mm	–
gG, aM	gPV	gPV	gS, gR, aR	gS, gR, aR	–
0.5 ... 100	2 ... 20	63 ... 630	6 ... 2400	1 ... 125	0.6 ... 30
IEC 60269-1/-2; NF C 60-200, NF C 63-210/-211; NBN C 63269-2; IEC 32-4/-12	IEC 60269-6	IEC 60269-6	IEC 60269-4	IEC 60269-2	–
UL 4248-1, CSA	–	–	UL 4248-1, UL 4248-13	UL 4248-1, UL 4248-13	UL 4248-1; CSA C22.2
400 ... 690 400 ... 600 (UL/CSA)	–	–	500 ... 2500	690 ... 1500 600 ... 1500 (UL/CSA)	600
20 ... 120	–	–	100 ... 150	100	200
–	1000 ... 1500	1000 ... 1500	400 ... 1500	250 ... 1000	150 ... 300
–	30	30	–	–	–
See page 7/52	See page 7/84	See page 7/84	See page 7/54	See page 7/76	See page 7/86

7

NEOZED fuse links

Operational class gG



I_n	Identification color	Contacts	U_n AC/DC			
2 A	Pink	–	400 V/250 V	5SE2302	–	–
4 A	Brown	–	400 V/250 V	5SE2304	–	–
6 A	Green	–	400 V/250 V	5SE2306	–	–
10 A	Red	–	400 V/250 V	5SE2310	–	–
13 A	Black	–	400 V/250 V	5SE2013-2A	–	–
16 A	Gray	–	400 V/250 V	5SE2316	–	–
20 A	Blue	Tin-coated	400 V/250 V	–	5SE2320	–
25 A	Yellow	Tin-coated	400 V/250 V	–	5SE2325	–
32 A	Violet	Tin-coated	400 V/250 V	–	5SE2332	–
35 A	Black	Tin-coated	400 V/250 V	–	5SE2335	–
40 A	Black	Silver-plated	400 V/250 V	–	5SE2340	–
50 A	White	Silver-plated	400 V/250 V	–	5SE2350	–
63 A	Copper	Silver-plated	400 V/250 V	–	5SE2363	–
80 A	Blue	–	400 V/250 V	–	–	5SE2280
100 A	Red	–	400 V/250 V	–	–	5SE2300

DIAZED fuse links

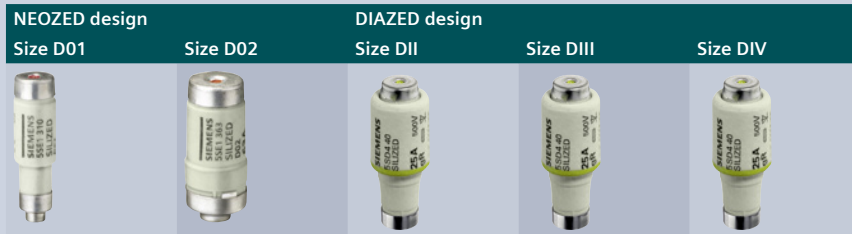
Operational class	Size DII	Size DIII ¹⁾	Size DIV	Size TNDz
	E27	E33	R 1 1/4"	E16
	gG	gG	quick	slow
				

I_n	Identification color	U_n AC/DC				
2 A	Pink	500 V/500 V	5SB211	–	–	5SA211
		690 V/600 V	–	5SD8002	–	–
		750 V/750 V	–	–	5SD601	–
4 A	Brown	500 V/500 V	5SB221	–	–	5SA221
		690 V/600 V	–	5SD8004	–	–
		750 V/750 V	–	–	5SD602	–
6 A	Green	500 V/500 V	5SB231	–	–	5SA231
		690 V/600 V	–	5SD8006	–	–
		750 V/750 V	–	–	5SD603	–
10 A	Red	500 V/500 V	5SB251	–	–	5SA251
		690 V/600 V	–	5SD8010	–	–
		750 V/750 V	–	–	5SD604	–
16 A	Gray	500 V/440 V	5SB2611	–	–	5SA2611
		690 V/600 V	–	5SD8016	–	–
		750 V/750 V	–	–	5SD605	–
20 A	Blue	500 V/440 V	5SB2711	–	–	5SA2711
		690 V/600 V	–	5SD8020	–	–
		750 V/750 V	–	–	5SD606	–
25 A	Yellow	500 V/440 V	5SB2811	–	–	5SA2811
		690 V/600 V	–	5SD8025	–	–
		750 V/750 V	–	–	5SD607	–
32 A	Violet	500 V/440 V	–	5SB4011	–	–
35 A	Black	500 V/440 V	–	5SB4111	–	–
		690 V/600 V	–	5SD8035	–	–
		750 V/750 V	–	–	5SD608	–
50 A	White	500 V/440 V	–	5SB4211	–	–
		690 V/600 V	–	5SD8050	–	–
		750 V/750 V	–	–	5SD610	–
63 A	Copper	500 V/440 V	–	5SB4311	–	–
		690 V/600 V	–	5SD8063	–	–
		750 V/750 V	–	–	5SD611	–
80 A	Silver	500 V/400 V	–	–	–	5SC211
100 A	Red	500 V/400 V	–	–	–	5SC221

¹⁾ For 2 ... 25 A use screw adaptor DII

SILIZED fuse links

Operational class gR

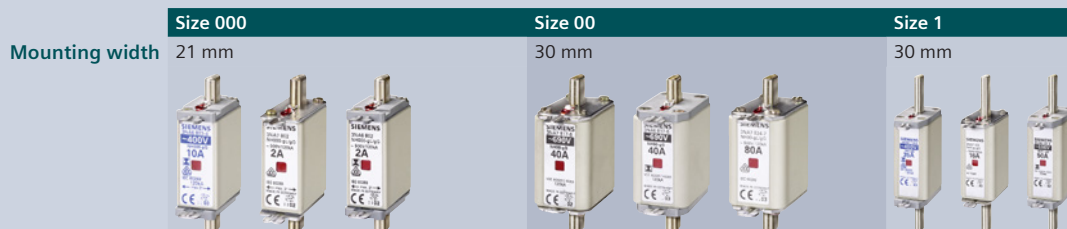


I_n	Switch-off I^2t value	Power loss P_v	U_n AC/DC	Design				
				NEOZED design Size D01	NEOZED design Size D02	DIAZED design Size DII	DIAZED design Size DIII	DIAZED design Size DIV
10 A	73 A ² s	6.9 W	400 V/250 V	5SE1310	–	–	–	–
16 A	60 A ² s	12.1 W	500 V/500 V	–	–	5SD420	–	–
	120 A ² s	6.2 W	400 V/250 V	5SE1316	–	–	–	–
20 A	139 A ² s	12.3 W	500 V/500 V	–	–	5SD430	–	–
	190 A ² s	8.1 W	400 V/250 V	–	5SE1320	–	–	–
25 A	205 A ² s	12.5 W	500 V/500 V	–	–	5SD440	–	–
	215 A ² s	8.2 W	400 V/250 V	–	5SE1325	–	–	–
30 A	310 A ² s	13.5 W	500 V/500 V	–	–	5SD480	–	–
35 A	470 A ² s	16.7 W	400 V/250 V	–	5SE1335	–	–	–
	539 A ² s	14.8 W	500 V/500 V	–	–	–	5SD450	–
50 A	1250 A ² s	18.5 W	500 V/500 V	–	–	–	5SD460	–
	1960 A ² s	12.0 W	400 V/250 V	–	5SE1350	–	–	–
63 A	1890 A ² s	28.0 W	500 V/500 V	–	–	–	5SD470	–
	4230 A ² s	15.5 W	400 V/250 V	–	5SE1363	–	–	–
80 A	4200 A ² s	34.3 W	500 V/500 V	–	–	–	–	5SD510
100 A	8450 A ² s	41.5 W	500 V/500 V	–	–	–	–	5SD520

7

LV HRC fuse links

Operational class gG, with combination alarm

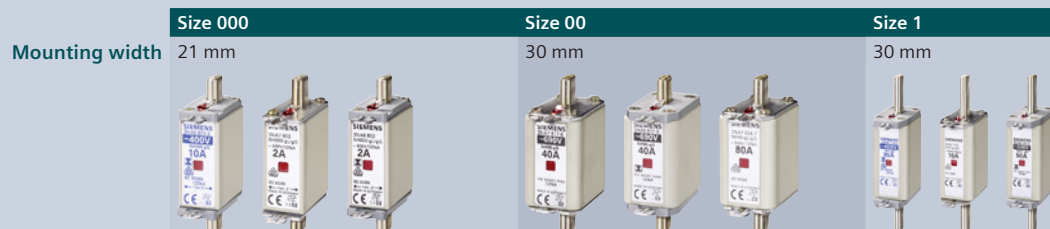


I_n	U_n AC/DC			
Insulated grip lugs				
2 A	500 V/250 V	3NA6802	–	–
	690 V ¹⁾ /250 V	3NA6802-6	–	–
4 A	500 V/250 V	3NA6804	–	–
	690 V ¹⁾ /250 V	3NA6804-6	–	–
6 A	500 V/250 V	3NA6801	–	–
	690 V ¹⁾ /250 V	3NA6801-6	–	–
10 A	400 V/–	3NA6803-4	–	–
	500 V/250 V	3NA6803	–	–
	690 V ¹⁾ /250 V	3NA6803-6	–	–
16 A	400 V/–	3NA6805-4	–	–
	500 V/250 V	3NA6805	–	–
	690 V ¹⁾ /250 V	3NA6805-6	–	–
	500 V/440 V	–	–	3NA6105
20 A	400 V/–	3NA6807-4	–	–
	500 V/250 V	3NA6807	–	–
	690 V ¹⁾ /250 V	3NA6807-6	–	–
	500 V/440 V	–	–	3NA6107
25 A	400 V/–	3NA6810-4	–	–
	500 V/250 V	3NA6810	–	–
	690 V ¹⁾ /250 V	3NA6810-6	–	–
	500 V/440 V	–	–	3NA6110
32 A	400 V/–	3NA6812-4	–	3NA6114-4
	500 V/250 V	3NA6812	–	–
	690 V ¹⁾ /250 V	3NA6812-6	–	–
35 A	400 V/–	3NA6814-4	–	–
	500 V/250 V	3NA6814	–	–
	690 V ¹⁾ /250 V	3NA6814-6	–	–
	500 V/440 V	–	–	3NA6114
40 A	400 V/–	3NA6817-4	–	3NA6117-4
	500 V/250 V	3NA6817	–	–
	690 V ¹⁾ /250 V	3NA6817-6KJ	3NA6817-6	–
	500 V/440 V	–	–	3NA6117
50 A	400 V/–	3NA6820-4	–	3NA6120-4
	500 V/250 V	3NA6820	–	–
	690 V ¹⁾ /250 V	3NA6820-6KJ	3NA6820-6	–
	500 V/440 V	–	–	3NA6120
	690 V ¹⁾ /440 V	–	–	3NA6120-6

¹⁾ Manufacturer's confirmation for 690 V +10% rated voltage available on request.

LV HRC fuse links

Operational class gG, with combination alarm (continued)



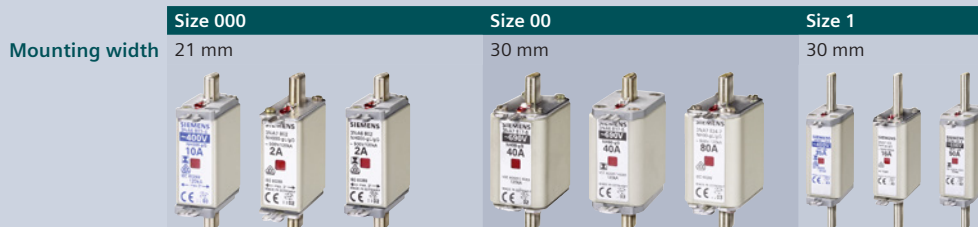
I_n	U_n AC/DC	Size 000 21 mm	Size 00 30 mm	Size 1 30 mm
Insulated grip lugs				
63 A	400 V/-	3NA6822-4	–	3NA6122-4
	500 V/250 V	3NA6822	–	–
	690 V ¹⁾ /250 V	–	3NA6822-6	–
	500 V/440 V	–	–	3NA6122
	690 V ¹⁾ /440 V	–	–	3NA6122-6
80 A	400 V/-	3NA6824-4	3NA6824-4KK	3NA6124-4
	500 V/250 V	3NA6824	3NA6824-7	–
	690 V ¹⁾ /250 V	–	3NA6824-6	–
	500 V/440 V	–	–	3NA6124
	690 V ¹⁾ /440 V	–	–	3NA6124-6
100 A	400 V/-	3NA6830-4	3NA6830-4KK	3NA6130-4
	500 V/250 V	3NA6830	3NA6830-7	–
	690 V ¹⁾ /250 V	–	3NA6830-6	–
	500 V/440 V	–	–	3NA6130
	690 V ¹⁾ /440 V	–	–	3NA6130-6
125 A	400 V/-	–	3NA6832-4	–
	500 V/250 V	–	3NA6832	–
	500 V/440 V	–	–	3NA6132
	690 V ¹⁾ /440 V	–	–	3NA6132-6
	–	–	–	–
160 A	400 V/-	–	3NA6836-4	3NA6136-4
	500 V/250 V	–	3NA6836	–
	500 V/440 V	–	–	3NA6136
	690 V ¹⁾ /440 V	–	–	3NA6136-6
	–	–	–	–
200 A	400 V/-	–	–	–
	500 V/440 V	–	–	–
	690 V ¹⁾ /440 V	–	–	–
224 A	400 V/-	–	–	–
	500 V/440 V	–	–	–
	690 V ¹⁾ /440 V	–	–	–
250 A	400 V/-	–	–	–
	500 V/440 V	–	–	–
	690 V ¹⁾ /440 V	–	–	–
300 A	400 V/-	–	–	–
	500 V/440 V	–	–	–
	690 V ¹⁾ /440 V	–	–	–
315 A	400 V/-	–	–	–
	500 V/440 V	–	–	–
	690 V ¹⁾ /440 V	–	–	–
355 A	400 V/-	–	–	–
	500 V/440 V	–	–	–
400 A	400 V/-	–	–	–
	500 V/440 V	–	–	–

¹⁾ Manufacturer's confirmation for 690 V +10% rated voltage available on request.

Size 1 47.2 mm	Size 2 47.2 mm	Size 2 57.8 mm
-	3NA6222-4	-
-	-	-
-	-	-
-	3NA6222	-
-	-	-
-	3NA6224-4	-
-	-	-
-	-	-
-	3NA6224	-
-	3NA6224-6	-
-	3NA6230-4	-
-	-	-
-	-	-
-	3NA6230	-
-	3NA6230-6	-
-	3NA6232-4	-
-	-	-
-	3NA6232	-
-	3NA6232-6	-
-	3NA6236-4	-
-	-	-
-	3NA6236	-
-	3NA6236-6	-
3NA6140-4	3NA6240-4	-
3NA6140	3NA6240	-
3NA6140-6	3NA6240-6	-
3NA6142-4	3NA6242-4	-
3NA6142	3NA6242	-
-	-	3NA6242-6
3NA6144-4	3NA6244-4	-
3NA6144	3NA6244	-
-	-	3NA6244-6
-	-	3NA6250-4
-	-	3NA6250
-	-	3NA6250-6
-	-	3NA6252-4
-	-	3NA6252
-	-	3NA6252-6
-	-	3NA6254-4
-	-	3NA6254
-	-	3NA6260-4
-	-	-

LV HRC fuse links

Operational class gG, with combination alarm

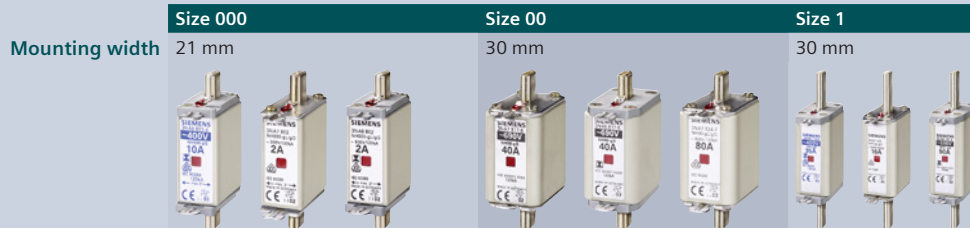


I_n	U_n AC/DC	Size 000 Mounting width 21 mm	Size 00 Mounting width 30 mm	Size 1 Mounting width 30 mm
Non-insulated grip lugs				
2 A	500 V/250 V	3NA7802	–	–
	690 V ¹⁾ /250 V	3NA7802-6	–	–
4 A	500 V/250 V	3NA7804	–	–
	690 V ¹⁾ /250 V	3NA7804-6	–	–
6 A	500 V/250 V	3NA7801	–	–
	690 V ¹⁾ /250 V	3NA7801-6	–	–
10 A	500 V/250 V	3NA7803	–	–
	690 V ¹⁾ /250 V	3NA7803-6	–	–
16 A	500 V/250 V	3NA7805	–	–
	690 V ¹⁾ /250 V	3NA7805-6	–	–
	500 V/440 V	–	–	3NA7105
20 A	500 V/250 V	3NA7807	–	–
	690 V ¹⁾ /250 V	3NA7807-6	–	–
	500 V/440 V	–	–	3NA7107
25 A	500 V/250 V	3NA7810	–	–
	690 V ¹⁾ /250 V	3NA7810-6	–	–
	500 V/440 V	–	–	3NA7110
32 A	500 V/250 V	3NA7812	–	–
	690 V ¹⁾ /250 V	3NA7812-6	–	–
35 A	500 V/250 V	3NA7814	–	–
	690 V ¹⁾ /250 V	3NA7814-6	–	–
	500 V/440 V	–	–	3NA7114
40 A	500 V/250 V	3NA7817	–	–
	690 V ¹⁾ /250 V	3NA7817-6KJ	3NA7817-6	–
	500 V/440 V	–	–	3NA7117
50 A	500 V/250 V	3NA7820	–	–
	690 V ¹⁾ /250 V	3NA7820-6KJ	3NA7820-6	–
	500 V/440 V	–	–	3NA7120
	690 V ¹⁾ /440 V	–	–	3NA7120-6
63 A	500 V/250 V	3NA7822	–	–
	690 V ¹⁾ /250 V	–	3NA7822-6	–
	500 V/440 V	–	–	3NA7122
	690 V ¹⁾ /440 V	–	–	3NA7122-6
80 A	500 V/250 V	3NA7824	3NA7824-7	–
	690 V ¹⁾ /250 V	–	3NA7824-6	–
	500 V/440 V	–	–	3NA7124
	690 V ¹⁾ /440 V	–	–	3NA7124-6
100 A	500 V/250 V	3NA7830	3NA7830-7	–
	690 V ¹⁾ /250 V	–	3NA7830-6	–
	500 V/440 V	–	–	3NA7130
	690 V ¹⁾ /440 V	–	–	3NA7130-6
125 A	500 V/250 V	–	3NA7832	–
	500 V/440 V	–	–	3NA7132
	690 V ¹⁾ /440 V	–	–	3NA7132-6

¹⁾ Manufacturer's confirmation for 690 V +10% rated voltage available on request.

LV HRC fuse links

Operational class gG, with combination alarm (continued)



I_n	U_n AC/DC		
Non-insulated grip lugs			
160 A	500 V/250 V	–	3NA7836
	500 V/440 V	–	–
	690 V ¹⁾ /440 V	–	3NA7136
200 A	500 V/440 V	–	–
	690 V ¹⁾ /440 V	–	–
224 A	500 V/440 V	–	–
	690 V ¹⁾ /440 V	–	–
250 A	500 V/440 V	–	–
	690 V ¹⁾ /440 V	–	–
300 A	500 V/440 V	–	–
	690 V ¹⁾ /440 V	–	–
315 A	500 V/440 V	–	–
	690 V ¹⁾ /440 V	–	–
355 A	–	–	–
400 A	500 V/440 V	–	–

¹⁾ Manufacturer's confirmation for 690 V +10% rated voltage available on request.

Size 1 47.2 mm	Size 2 47.2 mm	Size 2 57.8 mm
-	-	-
-	3NA7236	-
-	3NA7236-6	-
3NA7140	3NA7240	-
3NA7140-6	3NA7240-6	-
3NA7142	3NA7242	-
-	-	3NA7242-6
3NA7144	3NA7244	-
-	-	3NA7244-6
-	-	3NA7250-6
-	-	3NA7252
-	-	3NA7252-6
-	-	-
-	-	3NA7260

LV HRC fuse links

Operational class gG, with front indicator



I_n	U_n AC/DC	Size 000	Size 00	Size 0	Size 1	Size 1
Non-insulated grip lugs						
2 A	500 V/250 V	3NA3802	–	–	–	–
	690 V ¹⁾ /250 V	3NA3802-6	–	–	–	–
4 A	500 V/250 V	3NA3804	–	–	–	–
	690 V ¹⁾ /250 V	3NA3804-6	–	–	–	–
6 A	500 V/250 V	3NA3801	–	–	–	–
	690 V ¹⁾ /250 V	3NA3801-6	–	–	–	–
	500 V/440 V	–	–	3NA3001	–	–
10 A	500 V/250 V	3NA3803	–	–	–	–
	690 V ¹⁾ /250 V	3NA3803-6	–	–	–	–
	500 V/440 V	–	–	3NA3003	–	–
16 A	500 V/250 V	3NA3805	–	–	–	–
	690 V ¹⁾ /250 V	3NA3805-6	–	–	–	–
	500 V/440 V	–	–	3NA3005	3NA3105	–
20 A	500 V/250 V	3NA3807	–	–	–	–
	690 V ¹⁾ /250 V	3NA3807-6	–	–	–	–
	500 V/440 V	–	–	3NA3007	3NA3107	–
25 A	500 V/250 V	3NA3810	–	–	–	–
	690 V ¹⁾ /250 V	3NA3810-6	–	–	–	–
	500 V/440 V	–	–	3NA3010	3NA3110	–
32 A	500 V/250 V	3NA3812	–	–	–	–
	690 V ¹⁾ /250 V	3NA3812-6	–	–	–	–
	500 V/440 V	–	–	3NA3012	–	–
35 A	500 V/250 V	3NA3814	3NA3814-7	–	–	–
	690 V ¹⁾ /250 V	–	–	–	–	–
	500 V/440 V	–	–	3NA3014	3NA3114	–
40 A	500 V/250 V	3NA3817	–	–	–	–
	690 V ¹⁾ /250 V	3NA3817-6KJ	3NA3817-6	–	–	–
	500 V/440 V	–	–	3NA3017	3NA3117	–
50 A	500 V/250 V	3NA3820	3NA3820-7	–	–	–
	690 V ¹⁾ /250 V	3NA3820-6KJ	3NA3820-6	–	–	–
	500 V/440 V	–	–	3NA3020	3NA3120	–
	690 V ¹⁾ /440 V	–	–	–	3NA3120-6	–
63 A	500 V/250 V	3NA3822	3NA3822-7	–	–	–
	690 V ¹⁾ /250 V	–	3NA3822-6	–	–	–
	500 V/440 V	–	–	3NA3022	3NA3122	–
	690 V ¹⁾ /440 V	–	–	–	3NA3122-6	–
80 A	500 V/250 V	3NA3824	3NA3824-7	–	–	–
	690 V ¹⁾ /250 V	–	3NA3824-6	–	–	–
	500 V/440 V	–	–	3NA3024	3NA3124	–
	690 V ¹⁾ /440 V	–	–	–	3NA3124-6	–
100 A	500 V/250 V	3NA3830	3NA3830-7	–	–	–
	690 V ¹⁾ /250 V	–	3NA3830-6	–	–	–
	500 V/440 V	–	–	3NA3030	3NA3130	–
	690 V ¹⁾ /440 V	–	–	–	–	–

¹⁾ Manufacturer's confirmation for 690 V +10% rated voltage available on request.

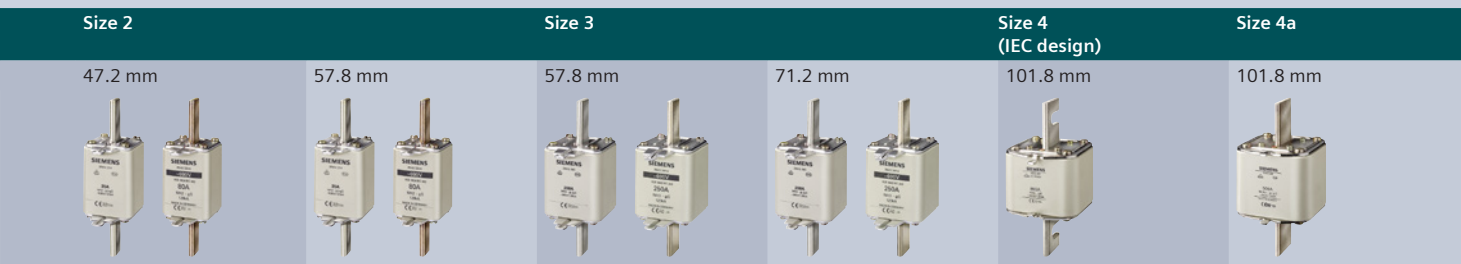
LV HRC fuse links

Operational class gG, with front indicator (continued)



I_n	U_n AC/DC					
Non-insulated grip lugs						
125 A	400 V/250 V	3NA3832-8	–	–	–	–
	500 V/250 V	–	3NA3832	–	–	–
	500 V/440 V	–	–	3NA3032	3NA3132	–
	690 V ¹⁾ /440 V	–	–	–	3NA3132-6	–
160 A	400 V/250 V	3NA3836-8	–	–	–	–
	500 V/250 V	–	3NA3836	–	–	–
	500 V/440 V	–	–	3NA3036	3NA3136	–
	690 V ¹⁾ /440 V	–	–	–	3NA3136-6	–
200 A	500 V/440 V	–	–	–	–	3NA3140
	690 V ¹⁾ /440 V	–	–	–	–	3NA3140-6
224 A	500 V/440 V	–	–	–	–	3NA3142
	690 V ¹⁾ /440 V	–	–	–	–	–
250 A	500 V/440 V	–	–	–	–	3NA3144
	690 V ¹⁾ /440 V	–	–	–	–	3NA3144-6
300 A	500 V/440 V	–	–	–	–	–
	690 V ¹⁾ /440 V	–	–	–	–	–
315 A	500 V/440 V	–	–	–	–	–
	690 V ¹⁾ /440 V	–	–	–	–	–
355 A	500 V/440 V	–	–	–	–	–
	690 V ¹⁾ /440 V	–	–	–	–	–
400 A	500 V/440 V	–	–	–	–	–
	690 V ¹⁾ /440 V	–	–	–	–	–
425 A	500 V/440 V	–	–	–	–	–
	690 V ¹⁾ /440 V	–	–	–	–	–
500 A	500 V/440 V	–	–	–	–	–
	690 V ¹⁾ /440 V	–	–	–	–	–
630 A	500 V/440 V	–	–	–	–	–
800 A	500 V/440 V	–	–	–	–	–
1000 A	500 V/440 V	–	–	–	–	–
1250 A	500 V/440 V	–	–	–	–	–









¹⁾ Manufacturer's confirmation for 690 V +10% rated voltage available on request.



-	-	-	-	-	-
-	-	-	-	-	-
3NA3232	-	-	-	-	-
3NA3232-6	-	-	-	-	-
-	-	-	-	-	-
-	-	-	-	-	-
3NA3236	-	-	-	-	-
3NA3236-6	-	-	-	-	-
3NA3240	-	3NA3340	-	-	-
3NA3240-6	-	-	-	-	-
3NA3242	-	3NA3342	-	-	-
-	3NA3242-6	-	-	-	-
3NA3244	-	3NA3344	-	-	-
-	3NA3244-6	3NA3344-6	-	-	-
-	3NA3250	3NA3350	-	-	-
-	3NA3250-6	-	-	-	-
-	3NA3252	3NA3352	-	-	-
-	3NA3252-6	3NA3352-6	-	-	-
-	3NA3254	3NA3354	-	-	-
-	-	-	3NA3354-6	-	-
-	3NA3260	3NA3360	-	-	-
-	-	-	3NA3360-6	-	-
-	-	-	3NA3362	-	-
-	-	-	3NA3362-6	-	-
-	-	-	3NA3365	-	3NA3665
-	-	-	3NA3365-6	-	-
-	-	-	3NA3372	3NA3472	3NA3672
-	-	-	-	3NA3475	3NA3675
-	-	-	-	3NA3480	3NA3680
-	-	-	-	3NA3482	3NA3682

LV HRC fuse links

Operational class aM, with front indicator

	Size 000	Size 00	Size 1	Size 2	Size 2	Size 3	Size 3	
Mounting width	21 mm	30 mm	30 mm	47.2 mm	47.2 mm	57.8 mm	57.8 mm	71.2 mm
								

I_n	U_n AC								
Non-insulated grip lugs									
6 A	500 V	3ND1801	–	–	–	–	–	–	–
10 A	500 V	3ND1803	–	–	–	–	–	–	–
16 A	500 V	3ND1805	–	–	–	–	–	–	–
20 A	500 V	3ND1807	–	–	–	–	–	–	–
25 A	500 V	3ND1810	–	–	–	–	–	–	–
32 A	500 V	3ND1812	–	–	–	–	–	–	–
35 A	500 V	3ND1814	–	–	–	–	–	–	–
40 A	500 V	3ND1817	–	–	–	–	–	–	–
50 A	500 V	3ND1820	–	–	–	–	–	–	–
63 A	500 V	3ND1822	–	–	–	–	–	–	–
	690 V	–	–	3ND2122	–	–	–	–	–
80 A	500 V	3ND1824	–	–	–	–	–	–	–
	690 V	–	–	3ND2124	–	–	–	–	–
100 A	500 V	3ND1830-8	3ND1830	–	–	–	–	–	–
	690 V	–	–	3ND2130	–	–	–	–	–
125 A	500 V	–	3ND1832	–	–	–	–	–	–
	690 V	–	–	–	3ND2132	3ND2232	–	–	–
160 A	500 V	–	3ND1836	–	–	–	–	–	–
	690 V	–	–	–	3ND2136	3ND2236	–	–	–
200 A	690 V	–	–	–	3ND2140	3ND2240	–	–	–
250 A	690 V	–	–	–	3ND2144	3ND2244	–	–	–
315 A	690 V	–	–	–	–	–	3ND2252	3ND2352	–
355 A	690 V	–	–	–	–	–	3ND2254	3ND2354	–
400 A	690 V	–	–	–	–	–	3ND2260	3ND2360	–
500 A	690 V	–	–	–	–	–	–	–	3ND1365
630 A	690 V	–	–	–	–	–	–	–	3ND1372

7

3NA COM LV HRC fuse links with communication and measuring function

With front indicator and non-insulated grip lugs

	Size 2, with electronic module ¹⁾		Size 2, without electronic module ²⁾		
	Operational class gG	Operational class gFF (for the Netherlands)	Operational class gG	Operational class gFF (for the Netherlands)	
Mounting width	59 mm	59 mm	59 mm	59 mm	
I_n	U_n AC				
80 A	400 V	–	3NA3224-4KK03	–	3NA3224-4KK04
100 A	400 V	3NA3230-4KK01	3NA3230-4KK03	3NA3230-4KK02	3NA3230-4KK04
125 A	400 V	3NA3232-4KK01	3NA3232-4KK03	3NA3232-4KK02	3NA3232-4KK04
160 A	400 V	3NA3236-4KK01	3NA3236-4KK03	3NA3236-4KK02	3NA3236-4KK04
200 A	400 V	3NA3240-4KK01	3NA3240-4KK03	3NA3240-4KK02	3NA3240-4KK04
224 A	400 V	3NA3242-4KK01	–	3NA3242-4KK02	–
250 A	400 V	3NA3244-4KK01	3NA3244-4KK03	3NA3244-4KK02	3NA3244-4KK04
315 A	400 V	3NA3252-4KK01	–	3NA3252-4KK02	–

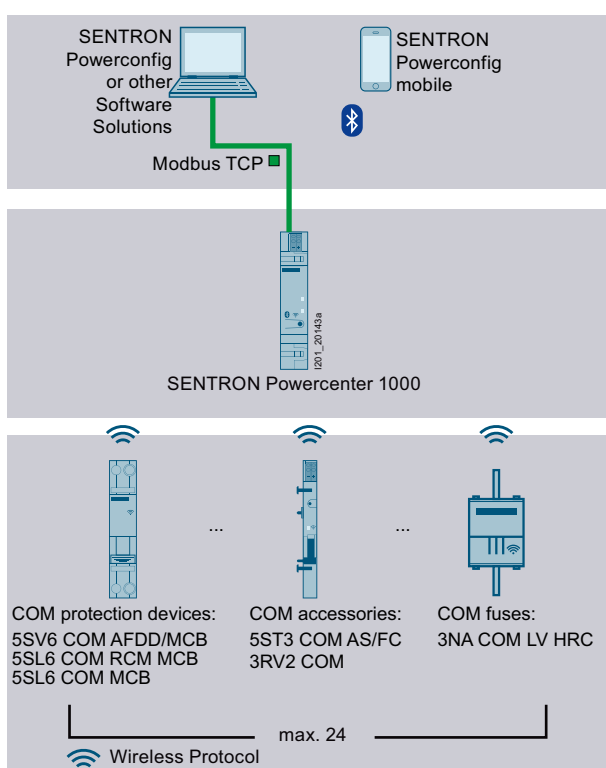
¹⁾ Electronic module is mounted by simple insertion

²⁾ For spare part purposes (electronic module can be reused after the fuse has been replaced!)

7



SENTRON Powercenter 1000 data transceiver



- Wireless radio transmission of measured values and data to the SENTRON Powercenter 1000 data transceiver
- Commissioning, parameter assignment, firmware updates and further processing of the data via the SENTRON Powercenter 1000 data transceiver



SENTRON Powercenter 1000	Article No.
	7KN1110-0MC00

See page 10/20

You will find further information at www.siemens.com/lowvoltage/manuals

Installation Manual – Circuit protection devices with communication and measuring function (109791805)

System Manual – Circuit protection devices with communication and measuring function (109791806)



Measuring functions

- Rms value of the current (average 10 s)
- Temperature (measured in electronic module)

Monitoring functions (alarm) with limit monitoring

- Limit values can be set for:
 - Current/overcurrent > Limit value 1
 - Current/overcurrent > Limit value 2
 - Overtemperature
 - Operating hours counter
 - Operating hours counter with load current > Limit value
 - Values

Technical specifications

Electronic module for 3NA COM

Rated current/current measuring range	400 A/2.5 ... 440 A (rms value)
Measuring accuracy of current measurement/5-minute average of rms value	±1 % (8 ... 440 A), ±2 % (2.5 ... 8 A)
<ul style="list-style-type: none"> • At reference temperature 25 °C • In the range –10 °C ... +70 °C 	±2.2 % (8 ... 440 A), ±3.2 % (2.5 ... 8 A)
Minimum current (to maintain the radio connection)	2 A for operation, 3.5 A for commissioning
Temperature measuring range	+10 ... +150 °C
Measuring accuracy of temperature measurement	±2.5 °C
Maximum transmit power	8 dBm
Minimum/maximum ambient temperature during operation	–25 °C/+70 °C
Minimum/maximum ambient temperature during storage	–25 °C/+85 °C
Relative humidity at 25 °C without condensation	Max. 95%
Degree of protection IP	IP20
Pollution degree	2
Reference condition for measuring accuracy	IEC 61557-12
Measuring method	TRMS
Power supply	CT Harvesting
European standards	
RED Safety	EN 60669-2-5
RED Health	EN 62479
RED EMV	EN 63044-3/-5-3, EN 301489-17, EN 300480-17
RED Radio Spec	EN 300328
International standards	
For EMC	EN 63044-5-3, IEC 61000-6-2, IEC 61000-4-2/-3/-4/-5/-6/-8/-11
For shocks, bumps, free fall, environmental tests	IEC 60068-2-1/-2/-6/-27/-30/-32
Approvals	VDE, KEMA KEUR

Measured values

Measuring interval

Storage time

Measured values		Measuring interval	Storage time
Current			
Current (rms value)	A	2 s	1 h
Average current (rms value)	A	Adjustable from 3 ... 2600 s	7 d
Minimum current	A	1 d	10 d
Maximum current	A	No limit	10 d
Temperature			
Temperature	°C	2 s	1 h
Average temperature	°C	Adjustable	7 d
Minimum temperature	°C	1 d	10 d
Maximum temperature	°C	1 d	10 d
Operating hours counter			
Operating hours counter	h	Unlimited	Unlimited
Operating hours counter with load current > Limit value	h	Unlimited	Unlimited

Cylindrical fuse links

Operational class gG



I_n	U_n AC	Size 8 x 32 mm	Size 10 x 38 mm	Size 14 x 51 mm	Size 22 x 58 mm
0.5 A	500 V	–	3NW6000-1	–	–
1 A	500 V	–	3NW6011-1	–	–
2 A	400 V	3NW6302-1	–	–	–
	500 V	–	3NW6002-1	–	–
4 A	400 V	3NW6304-1	–	–	–
	500 V	–	3NW6004-1	–	–
	690 V	–	–	3NW6104-1	–
6 A	400 V	3NW6301-1	–	–	–
	500 V	–	3NW6001-1	–	–
	690 V	–	–	3NW6101-1	–
8 A	500 V	–	3NW6008-1	–	–
	690 V	–	–	3NW6108-1	–
10 A	400 V	3NW6303-1	–	–	–
	500 V	–	3NW6003-1	–	–
	690 V	–	–	3NW6103-1	–
12 A	500 V	–	3NW6006-1	–	–
	690 V	–	–	3NW6106-1	–
16 A	400 V	3NW6305-1	–	–	–
	500 V	–	3NW6005-1	–	–
	690 V	–	–	3NW6105-1	3NW6205-1
20 A	400 V	3NW6307-1	–	–	–
	500 V	–	3NW6007-1	–	–
	690 V	–	–	3NW6107-1	3NW6207-1
25 A	500 V	–	3NW6010-1	–	–
	690 V	–	–	3NW6110-1	3NW6210-1
32 A	400 V	–	3NW6012-1	–	–
	690 V	–	–	3NW6112-1	3NW6212-1
40 A	500 V	–	–	3NW6117-1	–
	690 V	–	–	–	3NW6217-1
50 A	500 V	–	–	3NW6120-1	–
	690 V	–	–	–	3NW6220-1
63 A	500 V	–	–	–	3NW6222-1
80 A	500 V	–	–	–	3NW6224-1
100 A	500 V	–	–	–	3NW6230-1

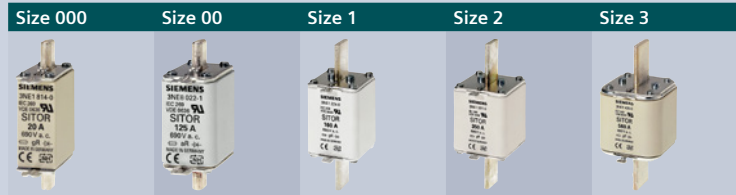
Operational class aM



I_n	U_n AC			
0.5 A	500 V	3NW8000-1	–	–
1 A	500 V	3NW8011-1	–	–
2 A	500 V	3NW8002-1	–	–
	690 V	–	3NW8102-1	–
4 A	500 V	3NW8004-1	–	–
	690 V	–	3NW8104-1	–
6 A	500 V	3NW8001-1	–	–
	690 V	–	3NW8101-1	–
8 A	500 V	3NW8008-1	–	–
	690 V	–	3NW8108-1	–
10 A	500 V	3NW8003-1	–	–
	690 V	–	3NW8103-1	–
12 A	500 V	3NW8006-1	–	–
	690 V	–	3NW8106-1	–
16 A	500 V	3NW8005-1	3NW8105-1	–
	690 V	–	–	3NW8205-1
20 A	400 V	3NW8007-1	–	–
	500 V	–	3NW8107-1	–
	690 V	–	–	3NW8207-1
25 A	400 V	3NW8010-1	–	–
	500 V	–	3NW8110-1	–
	690 V	–	–	3NW8210-1
32 A	400 V	3NW8012-1	–	–
	500 V	–	3NW8112-1	–
	690 V	–	–	3NW8212-1
40 A	500 V	–	3NW8117-1	–
	690 V	–	–	3NW8217-1
50 A	400 V	–	3NW8120-1	–
	690 V	–	–	3NW8220-1
63 A	500 V	–	–	3NW8222-1
80 A	500 V	–	–	3NW8224-1
100 A	500 V	–	–	3NW8230-1

SITOR semiconductor fuse links, LV HRC design (AC/DC)

Operational class gS, with blade contacts without slots



I_n	Switch-off I^2t value	Power loss P_v	Varying load factor WL	U_n AC					
16 A	200 A ² s	4 W	1.00	690 V ¹⁾	3NE1813-0	–	–	–	–
20 A	430 A ² s	5 W	1.00	690 V ¹⁾	3NE1814-0	–	–	–	–
25 A	780 A ² s	5 W	1.00	690 V ¹⁾	3NE1815-0	–	–	–	–
35 A	1700 A ² s	3.5 W	1.00	690 V ¹⁾	3NE1803-0	–	–	–	–
40 A	3000 A ² s	3 W	1.00	690 V ¹⁾	3NE1802-0	–	–	–	–
50 A	4400 A ² s	6 W	1.00	690 V ¹⁾	3NE1817-0	–	–	–	–
63 A	9000 A ² s	7 W	1.00	690 V ¹⁾	3NE1818-0	–	–	–	–
80 A	18000 A ² s	8 W	1.00	690 V ¹⁾	3NE1820-0	–	–	–	–
100 A	33000 A ² s	10 W	1.00	690 V ¹⁾	–	3NE1021-0	–	–	–
125 A	63000 A ² s	11 W	1.00	690 V ¹⁾	–	3NE1022-0	–	–	–
160 A	60000 A ² s	24 W	1.00	690 V ¹⁾	–	–	3NE1224-0	–	–
200 A	100000 A ² s	27 W	1.00	690 V ¹⁾	–	–	3NE1225-0	–	–
250 A	200000 A ² s	30 W	1.00	690 V ¹⁾	–	–	3NE1227-0	–	–
315 A	310000 A ² s	38 W	1.00	690 V ¹⁾	–	–	3NE1230-0	–	–
350 A	430000 A ² s	42 W	1.00	690 V ¹⁾	–	–	–	3NE1331-0	–
400 A	590000 A ² s	45 W	1.00	690 V ¹⁾	–	–	–	3NE1332-0	–
450 A	750000 A ² s	53 W	1.00	690 V ¹⁾	–	–	–	3NE1333-0	–
500 A	950000 A ² s	56 W	1.00	690 V ¹⁾	–	–	–	3NE1334-0	–
560 A	1700000 A ² s	50 W	1.00	690 V ¹⁾	–	–	–	–	3NE1435-0
630 A	2350000 A ² s	55 W	1.00	690 V ¹⁾	–	–	–	–	3NE1436-0
710 A	3400000 A ² s	58 W	1.00	690 V ¹⁾	–	–	–	–	3NE1437-0
800 A	5000000 A ² s	58 W	1.00	690 V ¹⁾	–	–	–	–	3NE1438-0

Further information									
Installation in 3NH LV HRC fuse bases	■	■	■	■	■	■	■	■	■
Installation in 3NP and 3KF fuse switching devices	■	■	■	■	■	■	■	■	■

¹⁾ For the max. DC voltage, see the Configuration Manual – Fuse systems, chapter Configuration, Use with direct current www.siemens.com/lowvoltage/manuals (45314810)

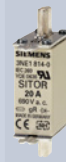
Operational class gR, with bolt-on links

						Size 000	Size 00
Screw fixing, mounting dimension						M8, 80 mm	M10, 80 mm
							
I_n	Switch-off I^2t value	Power loss P_v	Varying load factor WL	U_n AC/DC (IEC)	U_n DC (UL)		
20 A	83 A ² s	7 W	0.90	690 V/600 V	700 V	3NE8714-1	–
25 A	140 A ² s	9 W	0.90	690 V/600 V	700 V	3NE8715-1	–
32 A	285 A ² s	10 W	0.90	690 V/600 V	700 V	3NE8701-1	–
40 A	490 A ² s	12 W	0.90	690 V/600 V	700 V	3NE8702-1	–
50 A	815 A ² s	15 W	0.90	690 V/600 V	700 V	3NE8717-1	–
63 A	1550 A ² s	16 W	0.95	690 V/700 V	700 V	3NE8718-1	–
80 A	3200 A ² s	23 W	on req.	690 V/440 V	–	–	3NE8020-3MK
100 A	5200 A ² s	29 W	on req.	690 V/440 V	–	–	3NE8021-3MK
Further information							
Screw fixing						■	■
Installation in SITOR fuse bases						3NH5023	3NH5023
Further currents, operational class aR						See page 7/60	See page 7/60

SITOR semiconductor fuse links, LV HRC design (AC/DC)

Operational class gS, with blade contacts without slots

Size 000



Size 00



I_n	Switch-off I^2t value	Power loss P_V	Varying load factor WL	U_n AC/DC		
6 A	37 A ² s	2.7 W	on req.	690 V/400 V	3NE8810-OMK	–
10 A	50 A ² s	4.5 W	on req.	690 V/400 V	3NE8812-OMK	–
16 A	73 A ² s	6.7 W	on req.	690 V/400 V	3NE8813-OMK	–
20 A	90 A ² s	8 W	on req.	690 V/400 V	3NE8814-OMK	–
25 A	150 A ² s	8.1 W	on req.	690 V/400 V	3NE8815-OMK	–
	180 A ² s	7 W	0.95	690 V ¹⁾ /–	–	3NE8015-1
32 A	280 A ² s	12 W	0.90	1000 V ¹⁾ /–	–	–
	350 A ² s	10.5 W	on req.	690 V/400 V	3NE8801-OMK	–
35 A	400 A ² s	9 W	0.95	690 V ¹⁾ /–	–	3NE8003-1
40 A	480 A ² s	12 W	on req.	690 V/400 V	3NE8802-OMK	–
	500 A ² s	13 W	0.90	1000 V ¹⁾ /–	–	–
50 A	700 A ² s	14 W	0.90	690 V ¹⁾ /–	–	3NE8017-1
	800 A ² s	16 W	0.90	1000 V ¹⁾ /–	–	–
	1050 A ² s	14.5 W	on req.	690 V/400 V	3NE8817-OMK	–
63 A	1400 A ² s	16 W	0.95	690 V ¹⁾ /–	–	3NE8018-1
	1960 A ² s	23 W	on req.	690 V/400 V	3NE8818-OMK	–
80 A	5800 A ² s	10.5 W	1.00	690 V ¹⁾ /–	–	3NE1020-2
100 A	11000 A ² s	12 W	1.00	690 V ¹⁾ /–	–	3NE1021-2
125 A	23000 A ² s	13.5 W	1.00	690 V ¹⁾ /–	–	3NE1022-2
160 A	18600 A ² s	32 W	1.00	690 V ¹⁾ /–	–	–
200 A	51800 A ² s	35 W	1.00	690 V ¹⁾ /–	–	–
250 A	80900 A ² s	37 W	1.00	690 V ¹⁾ /–	–	–
315 A	168000 A ² s	40 W	1.00	690 V ¹⁾ /–	–	–
350 A	177000 A ² s	43 W	1.00	690 V ¹⁾ /–	–	–
400 A	224000 A ² s	50 W	1.00	690 V ¹⁾ /–	–	–
450 A	276500 A ² s	58 W	1.00	690 V ¹⁾ /–	–	–
500 A	398000 A ² s	64 W	1.00	690 V ¹⁾ /–	–	–
560 A	890000 A ² s	60 W	1.00	690 V ¹⁾ /–	–	–
630 A	1390000 A ² s	60 W	1.00	690 V ¹⁾ /–	–	–
670 A	1640000 A ² s	64 W	1.00	690 V ¹⁾ /–	–	–
710 A	1818000 A ² s	72 W	1.00	690 V ¹⁾ /–	–	–
	2460000 A ² s	65 W	1.00	690 V ¹⁾ /–	–	–
800 A	2475000 A ² s	84 W	1.00	690 V ¹⁾ /–	–	–
	3350000 A ² s	72 W	1.00	600 V ¹⁾ /–	–	–
850 A	3640000 A ² s	76 W	1.00	690 V ¹⁾ /–	–	–

Further information

Installation in 3NH LV HRC fuse bases



Installation in 3NP and 3KF fuse switching devices



Further currents, operational class aR

See page 7/61



¹⁾ For the max. DC voltage, see the Configuration Manual – Fuse systems, chapter Configuration, Use with direct current www.siemens.com/lowvoltage/manuals (45314810)

SITOR semiconductor fuse links, LV HRC design (AC/DC)

Operational class gR, with slotted blade contacts

Screw fixing, mounting dimension (lateral)

With 2 oblong slots

Size 3

M10, 110 mm

With oblong and transverse slots

Size 1

M10, 110 mm



I_n	Switch-off I^2t value	Power loss P_v	Varying load factor WL	U_n AC/DC				
32 A	4500 A ² s	9 W	on req.	1000 V/600 V	–	–	–	3NE3201-OMK
40 A	900 A ² s	26 W	on req.	1500 V/1000 V	–	–	–	–
	6000 A ² s	13 W	on req.	1000 V/600 V	–	–	–	3NE3202-OMK
50 A	1800 A ² s	27 W	on req.	1500 V/1000 V	–	–	–	–
	8000 A ² s	18 W	on req.	1000 V/600 V	–	–	–	3NE3217-OMK
63 A	3100 A ² s	34 W	on req.	1500 V/1000 V	–	–	–	–
	9000 A ² s	25 W	on req.	1000 V/600 V	–	–	–	3NE3218-OMK
150 A	17600 A ² s	40 W	0.85	690 V ^{1)/} –	–	3NC8423-OC	–	–
	33000 A ² s	35 W	0.85	500 V/–	3NC2423-OC	–	–	–
160 A	18600 A ² s	32 W	1.00	690 V ^{1)/} –	–	–	3NE1224-3	–
200 A	38400 A ² s	55 W	0.85	690 V ^{1)/} –	–	3NC8425-OC	–	–
	51800 A ² s	35 W	1.00	690 V ^{1)/} –	–	–	3NE1225-3	–
	64000 A ² s	40 W	0.85	500 V/–	3NC2425-OC	–	–	–
250 A	70400 A ² s	72 W	0.85	690 V ^{1)/} –	–	3NC8427-OC	–	–
	80900 A ² s	37 W	1.00	690 V ^{1)/} –	–	–	3NE1227-3	–
	99000 A ² s	50 W	0.85	500 V/–	3NC2427-OC	–	–	–
300 A	132000 A ² s	65 W	0.85	500 V/–	3NC2428-OC	–	–	–
315 A	168000 A ² s	40 W	1.00	690 V ^{1)/} –	–	–	3NE1230-3	–
350 A	176000 A ² s	95 W	0.85	690 V ^{1)/} –	–	3NC8431-OC	–	–
	177000 A ² s	43 W	1.00	690 V ^{1)/} –	–	–	–	–
	249000 A ² s	60 W	0.85	500 V/–	3NC2431-OC	–	–	–
400 A	224000 A ² s	50 W	1.00	690 V ^{1)/} –	–	–	–	–
450 A	276500 A ² s	58 W	1.00	690 V ^{1)/} –	–	–	–	–
500 A	398000 A ² s	64 W	1.00	690 V ^{1)/} –	–	–	–	–
	448000 A ² s	130 W	0.85	690 V ^{1)/} –	–	3NC8434-OC	–	–
560 A	890000 A ² s	60 W	1.00	690 V ^{1)/} –	–	–	–	–
630 A	1390000 A ² s	60 W	1.00	690 V ^{1)/} –	–	–	–	–
670 A	1640000 A ² s	64 W	1.00	690 V ^{1)/} –	–	–	–	–
710 A	1818000 A ² s	72 W	1.00	690 V ^{1)/} –	–	–	–	–
800 A	2475000 A ² s	84 W	1.00	690 V ^{1)/} –	–	–	–	–
850 A	3640000 A ² s	76 W	1.00	690 V ^{1)/} –	–	–	–	–
1000 A	1400000 A ² s	138 W	1.00	690 V ^{3)/} –	–	–	–	–
1100 A	3000000 A ² s	110 W	1.00	690 V ^{3)/} –	–	–	–	–
1250 A	4100000 A ² s	104 W	1.00	690 V ^{3)/} –	–	–	–	–
1350 A	4800000 A ² s	126 W	1.00	690 V ^{3)/} –	–	–	–	–
1400 A	5200000 A ² s	127 W	1.00	690 V ^{3)/} –	–	–	–	–
1600 A	6900000 A ² s	152 W	1.00	690 V ^{3)/} –	–	–	–	–
1700 A	6400000 A ² s	179 W	1.00	690 V ^{3)/} –	–	–	–	–
1700 A	10000000 A ² s	143 W	1.00	690 V ^{3)/} –	–	–	–	–
1900 A	8200000 A ² s	196 W	1.00	690 V ^{3)/} –	–	–	–	–








Further information

Screw fixing	■	■	■	■
Installation in SITOR fuse bases	3NH5463	3NH5463	3NH5463	3NH5463
Installation in LV HRC fuse bases	■	■	■	■
Installation in fuse switching devices	■	■	■	■
Further currents, operational class aR	See page 7/64	–	–	–

¹⁾ For the max. DC voltage, see the Configuration Manual – Fuse systems, chapter Configuration, Use with direct current www.siemens.com/lowvoltage/manuals (45314810)

²⁾ Minimum clearance 90 mm

³⁾ UL voltage 700 V AC

Size 2		Size 3		Size 2 × 3		Size 3 × 3
M10, 110 mm	M10, 170 mm	M10, 110 mm		M12, 110 mm	M12, 110 mm ²⁾	M12, 110 mm ²⁾
						
-	-	-	-	-	-	-
-	3NE5302-0MK06	-	-	-	-	-
-	3NE5317-0MK06	-	-	-	-	-
-	3NE5318-0MK06	-	-	-	-	-
-	-	-	-	-	-	-
-	-	-	3NC8423-3C	-	-	-
-	-	3NC2423-3C	-	-	-	-
-	-	-	-	-	-	-
-	-	-	3NC8425-3C	-	-	-
-	-	-	-	-	-	-
-	-	3NC2425-3C	-	-	-	-
-	-	-	3NC8427-3C	-	-	-
-	-	-	-	-	-	-
-	-	3NC2427-3C	-	-	-	-
-	-	3NC2428-3C	-	-	-	-
-	-	-	-	-	-	-
-	-	-	3NC8431-3C	-	-	-
3NE1331-3	-	-	-	-	-	-
-	-	3NC2431-3C	-	-	-	-
3NE1332-3	-	-	-	-	-	-
3NE1333-3	-	-	-	-	-	-
3NE1334-3	-	-	-	-	-	-
-	-	-	3NC8434-3C	-	-	-
-	-	-	-	3NE1435-3	-	-
-	-	-	-	3NE1436-3	-	-
-	-	-	-	3NE1447-3	-	-
-	-	-	-	3NE1437-3	-	-
-	-	-	-	3NE1438-3	-	-
-	-	-	-	3NE1448-3	-	-
-	-	-	-	-	3NB3350-1KK26	-
-	-	-	-	-	3NB3351-1KK26	-
-	-	-	-	-	3NB3352-1KK26	-
-	-	-	-	-	3NB3354-1KK26	-
-	-	-	-	-	3NB3355-1KK26	-
-	-	-	-	-	3NB3357-1KK26	-
-	-	-	-	-	-	3NB3358-1KK27
-	-	-	-	-	3NB3358-1KK26	-
-	-	-	-	-	-	3NB3362-1KK27
■	■	■	■	■	■	■
3NH5463	3NH5473	3NH5463	3NH5463	3NH5463	-	-
■	■	■	■	■	-	-
■	■	■	■	■	-	-
-	-	See page 7/64	See page 7/64	See page 7/64	-	-

SITOR semiconductor fuse links, LV HRC design (AC/DC)

Operational class aR, with bolt-on links

Screw fixing, mounting dimension

Size 000

M8, 80 mm

M10, 80 mm

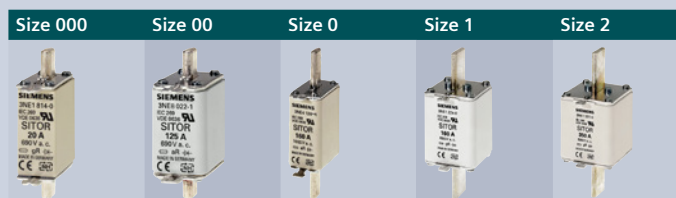


I_n	Switch-off I^2t value	Power loss P_v	Varying load factor WL	U_n AC/DC (IEC)	U_n DC (UL)		
80 A	2700 A ² s	18 W	0.90	690 V/600 V	700 V	3NE8720-1	–
100 A	4950 A ² s	19 W	0.95	690 V/600 V	700 V	3NE8721-1	–
125 A	9100 A ² s	23 W	0.95	690 V/600 V	700 V	3NE8722-1	–
160 A	17000 A ² s	31 W	0.90	690 V/600 V	700 V	3NE8724-1	–
200 A	30000 A ² s	36 W	0.90	690 V/600 V	700 V	3NE8725-1	–
250 A	55000 A ² s	42 W	0.90	690 V/600 V	700 V	3NE8727-1	–
315 A	85500 A ² s	54 W	0.85	690 V/600 V	700 V	3NE8731-1	–
350 A	135000 A ² s	58.8 W	on req.	690 V/440 V	–	–	3NE8031-3MK
400 A	170000 A ² s	74.5 W	on req.	690 V/440 V	–	–	3NE8032-3MK

Further information

Screw fixing	■	■
Installation in SITOR fuse bases	3NH5023	3NH5023
Further currents, operational class gR	See page 7/55	See page 7/55

Operational class aR, with blade contacts without slots



I_n	Switch-off I^2t value	Power loss P_v	Varying load factor WL	U_n , AC/DC	Size 000	Size 00	Size 0	Size 1	Size 2
63 A	1500 A ² s	20 W	0.90	1000 V ¹⁾ /–	–	–	3NE4118	–	–
80 A	2200 A ² s	23.3 W	on req.	690 V/440 V	3NE8820-0MK	–	–	–	–
	2400 A ² s	19 W	0.95	690 V ¹⁾ /–	–	3NE8020-1	–	–	–
	3000 A ² s	22 W	0.90	1000 V ¹⁾ /–	–	–	3NE4120	–	–
100 A	3650 A ² s	27 W	on req.	690 V/440 V	3NE8821-0MK	–	–	–	–
	6050 A ² s	25.5 W	on req.	690 V/440 V	–	–	–	3NE8221-0MK	–
	4200 A ² s	22 W	0.95	690 V ¹⁾ /–	–	3NE8021-1	–	–	–
	6000 A ² s	24 W	0.90	1000 V ¹⁾ /–	–	–	3NE4121	–	–
125 A	7800 A ² s	30 W	on req.	690 V/440 V	3NE8822-0MK	–	–	–	–
	8900 A ² s	28.5 W	on req.	690 V/440 V	–	–	–	3NE8222-0MK	–
	6500 A ² s	28 W	0.95	690 V ¹⁾ /–	–	3NE8022-1	–	–	–
	14000 A ² s	30 W	0.90	1000 V ¹⁾ /–	–	–	3NE4122	–	–
160 A	14000 A ² s	34 W	on req.	500 V/440 V	3NE8824-0MK	–	–	–	–
	16200 A ² s	37 W	on req.	690 V/440 V	–	–	–	3NE8224-0MK	–
	13000 A ² s	38 W	0.95	690 V ¹⁾ /–	–	3NE8024-1	–	–	–
	29000 A ² s	35 W	0.90	1000 V ¹⁾ /–	–	–	3NE4124	–	–
200 A	26000 A ² s	49 W	on req.	690 V/440 V	–	–	–	3NE8225-0MK	–
250 A	59000 A ² s	52 W	on req.	690 V/440 V	–	–	–	3NE8227-0MK	–
315 A	120000 A ² s	68 W	on req.	690 V/440 V	–	–	–	3NE8230-0MK	–
350 A	83500 A ² s	68.6 W	on req.	690 V/440 V	–	–	–	–	3NE8331-0MK
400 A	136000 A ² s	72.8 W	on req.	690 V/440 V	–	–	–	–	3NE8332-0MK
450 A	207000 A ² s	80.1 W	on req.	690 V/440 V	–	–	–	–	3NE8333-0MK
500 A	318000 A ² s	77.5 W	on req.	690 V/440 V	–	–	–	–	3NE8334-0MK
550 A	399000 A ² s	86.4 W	on req.	690 V/440 V	–	–	–	–	3NE8335-0MK
630 A	740000 A ² s	90.7 W	on req.	690 V/440 V	–	–	–	–	3NE8336-0MK
Further information									
Installation in 3NH LV HRC fuse bases					■	■	■	■	■
Installation in 3NP and 3KF fuse switching devices					■	■	■	■	■
Further currents, operational class gR					See page 7/56	–	See page 7/56	–	–

¹⁾ For the max. DC voltage, see the Configuration Manual – Fuse systems, chapter Configuration, Use with direct current www.siemens.com/lowvoltage/manuals (45314810)

SITOR semiconductor fuse links, LV HRC design (AC/DC)

Operational class aR, with slotted blade contacts



I_n	Switch-off I^2t value	Power loss P_v	Varying load factor WL	U_n , AC/DC			
80 A	3900 A ² s	42 W	on req.	1500 V/1000 V	–	–	–
100 A	4800 A ² s	28 W	0.95	1000 V 1/–	–	–	3NE3221
	3200 A ² s	25 W	on req.	690 V/440 V	–	3NE8221-3MK	–
	8700 A ² s	45 W	on req.	1500 V/1000 V	–	–	–
125 A	7200 A ² s	36 W	0.95	1000 V 1/–	–	–	3NE3222
	6000 A ² s	28 W	on req.	690 V/440 V	–	3NE8222-3MK	–
	11800 A ² s	59 W	on req.	1500 V/1000 V	–	–	–
160 A	13000 A ² s	42 W	1.00	1000 V 1/–	–	–	3NE3224
	10500 A ² s	35 W	on req.	690 V/440 V	–	3NE8224-3MK	–
	37000 A ² s	54 W	on req.	1500 V/1000 V	–	–	–
200 A	30000 A ² s	42 W	1.00	1000 V 1/–	–	–	3NE3225
	17500 A ² s	42 W	on req.	690 V/440 V	–	3NE8225-3MK	–
	70000 A ² s	56 W	on req.	1500 V/1000 V	–	–	–
250 A	29700 A ² s	105 W	0.85	800 V 1/1/–	–	–	–
	48000 A ² s	50 W	1.00	1000 V 1/–	–	–	3NE3227
	28500 A ² s	53.5 W	on req.	690 V/440 V	–	3NE8227-3MK	–
	165000 A ² s	59 W	on req.	1500 V/1000 V	–	–	–
315 A	60700 A ² s	120 W	0.85	800 V 1/1/–	–	–	–
	80000 A ² s	60 W	0.95	1000 V 1/–	–	–	3NE3230-0B
	300000 A ² s	245 W	on req.	–/3000 V	–	–	–
	53500 A ² s	61 W	on req.	690 V/440 V	–	3NE8230-3MK	–
	250000 A ² s	76 W	on req.	1500 V/1000 V	–	–	–
350 A	100000 A ² s	75 W	0.95	1000 V 1/–	–	–	3NE3231
	66000 A ² s	69 W	on req.	690 V/440 V	–	3NE8231-3MK	–
400 A	390000 A ² s	50 W	0.85	500 V 1/1/–	3NC2432-0C	–	–
	135000 A ² s	80 W	1.00	1000 V 1/–	–	–	–
		85 W	0.90	1000 V 1/–	–	–	3NE3232-0B
	110000 A ² s	70.5 W	on req.	690 V/440 V	–	3NE8232-3MK	–
450 A	470000 A ² s	89 W	on req.	1500 V/1000 V	–	–	–
	191000 A ² s	140 W	0.85	800 V 1/1/–	–	–	–
	175000 A ² s	90 W	1.00	1000 V 1/–	–	–	–
500 A		95 W	0.90	1000 V 1/–	–	–	3NE3233
	180000 A ² s	71 W	on req.	690 V/440 V	–	3NE8233-3MK	–
	276000 A ² s	155 W	0.85	800 V 1/1/–	–	–	–
	260000 A ² s	90 W	1.00	1000 V 1/–	–	–	–
	215000 A ² s	84 W	on req.	690 V/440 V	–	3NE8234-3MK	–
550 A	500000 A ² s	105 W	on req.	1000 V/600 V	–	–	–3NE3234-0MK08
	800000 A ² s	109 W	on req.	1500 V/1000 V	–	–	–
	290000 A ² s	87 W	on req.	690 V/440 V	–	3NE8235-3MK	–
560 A	700000 A ² s	110 W	on req.	1000 V/600 V	–	–	3NE3235-0MK08
	360000 A ² s	95 W	1.00	1000 V 1/1/–	–	–	–
630 A	600000 A ² s	100 W	1.00	1000 V 1/–	–	–	–
	440000 A ² s	96 W	on req.	690 V/440 V	–	3NE8236-3MK	–
	850000 A ² s	127 W	on req.	1000 V/600 V	–	–	3NE3236-0MK08
	1100000 A ² s	163 W	on req.	1500 V/1000 V	–	–	–
710 A	923000 A ² s	155 W	0.95	800 V 1/1/–	–	–	–
	800000 A ² s	105 W	1.00	900 V 1/1/–	–	–	–
800 A	850000 A ² s	130 W	0.95	800 V 1/1/–	–	–	–
900 A	920000 A ² s	165 W	0.95	690 V 1/1/–	–	–	–

Further information

Screw fixing	■	■	■
Installation in SITOR fuse bases	3NH5463	3NH5423	3NH5463
Installation in 3NH3 LV HRC fuse bases	■	–	■
Installation in 3NP and 3KF fuse switching devices	■	–	■
Further currents, operational class gR	See page 7/58	–	–

¹⁾ For the max. DC voltage, see the Configuration Manual – Fuse systems, chapter Configuration, Use with direct current www.siemens.com/lowvoltage/manuals (45314810)

Size 2

M10, 110 mm



M10, 170 mm



M10, 190 mm



M12, 260 mm



M10, 110 mm	M10, 170 mm	M10, 190 mm	M12, 260 mm
–	3NE5320-0MK06	–	–
–	–	–	–
–	3NE5321-0MK06	–	–
–	–	–	–
–	3NE5322-0MK06	–	–
–	–	–	–
–	3NE5324-0MK06	–	–
–	–	–	–
–	3NE5325-0MK06	–	–
3NE4327-0B	–	–	–
–	–	–	–
–	3NE5327-0MK06	–	–
3NE4330-0B	–	–	–
–	–	–	3NE9330-0MK07
–	–	–	–
–	3NE5330-0MK06	–	–
–	–	–	–
–	–	–	–
3NE3332-0B	–	–	–
–	–	–	–
–	3NE5332-0MK06	–	–
3NE4333-0B	–	–	–
3NE3333	–	–	–
–	–	–	–
–	–	–	–
3NE4334-0B	–	–	–
3NE3334-0B	–	–	–
–	–	–	–
–	3NE5334-0MK06	–	–
–	–	–	–
–	–	–	–
3NE3335	–	–	–
3NE3336	–	–	–
–	–	–	–
–	3NE5336-0MK06	3NE5336-0MK66	–
3NE4337	–	–	–
3NE3337-8	–	–	–
3NE3338-8	–	–	–
3NE3340-8	–	–	–
–	–	–	–
■ 3NH5463	■ 3NH5473	■ 3NH5473	–
■	–	–	–
■	–	–	–
–	See page 7/58	–	–

SITOR semiconductor fuse links, LV HRC design (AC/DC)

Operational class aR, with slotted blade contacts






Screw fixing, mounting dimension	With oblong and transverse slots Size 3			
	M10, 110 mm	M10, 130 mm	M10, 170 mm	M10, 210 mm
				

I_n	Switch-off I^2t value	Power loss P_V	Varying load factor WL	U_n AC ¹⁾				
100 A	13500 A ² s	25 W	1.00	1000 V	–	3NE3421-0C	–	–
125 A	34500 A ² s	78 W	1.00	2500 V	–	–	–	–
160 A	54000 A ² s	56 W	1.00	1500 V	–	–	–	3NE5424-0C
200 A	138000 A ² s	75 W	1.00	2000 V	–	–	–	3NE7425-0U
224 A	54000 A ² s	85 W	1.00	1000 V	–	3NE3626-0C	–	–
	138000 A ² s	80 W	1.00	1500 V	–	–	–	3NE5426-0C
250 A	84000 A ² s	130 W	1.00	1500 V	–	–	3NE5627-0C	–
	218000 A ² s	110 W	1.00	2000 V	–	–	–	3NE7427-0U
315 A	218000 A ² s	80 W	1.00	1000 V	–	3NE3430-0C	–	–
	72500 A ² s	80 W	0.95	1250 V	–	–	–	–
	311000 A ² s	115 W	1.00	1500 V	–	–	–	3NE5430-0C
350 A	428000 A ² s	135 W	1.00	1500 V	–	–	–	3NE5431-0C
	555000 A ² s	120 W	1.00	2000 V	–	–	–	3NE7431-0U
400 A	390000 A ² s	50 W	0.85	500 V	3NC2432-3C	–	–	–
	364000 A ² s	110 W	1.00	1000 V	–	3NE3432-0C	–	–
	163000 A ² s	95 W	0.95	1250 V	–	–	–	–
	620000 A ² s	205 W	1.00	2500 V	–	–	–	–
	870000 A ² s	150 W	1.00	2000 V	–	–	–	3NE7432-0U
450 A	488000 A ² s	110 W	1.00	1000 V	–	3NE3635-0C	–	–
	590000 A ² s	160 W	1.00	1500 V	–	–	3NE5633-0C	–
	870000 A ² s	145 W	0.95	1500 V	–	–	–	3NE5433-0C
	960000 A ² s	160 W	1.00	2000 V	–	–	–	3NE7633-0U
500 A	870000 A ² s	95 W	1.00	1000 V	–	3NE3434-0C	–	–
	290000 A ² s	115 W	0.90	1250 V	–	–	–	–
	1270000 A ² s	235 W	1.00	2500 V	–	–	–	–
525 A	1120000 A ² s	210 W	1.00	2000 V	–	–	–	–
600 A	1950000 A ² s	145 W	1.00	1500 V	–	–	3NE5643-0C	–
630 A	244000 A ² s	120 W	0.85	690 V	–	–	–	–
	418000 A ² s	145 W	0.85	1000 V	–	–	–	–
	1280000 A ² s	132 W	1.00	1000 V	–	3NE3636-0C	–	–
	650000 A ² s	120 W	0.95	1250 V	–	–	–	–
	1950000 A ² s	220 W	1.00	2000 V	–	–	–	3NE7636-0U
710 A	2800000 A ² s	275 W	1.00	2500 V	–	–	–	–
	346000 A ² s	130 W	0.85	690 V	–	–	–	–
	569000 A ² s	150 W	0.85	1000 V	–	–	–	–
	1950000 A ² s	145 W	1.00	1000 V	–	3NE3637-0C	–	–
800 A	3110000 A ² s	275 W	1.00	2000 V	–	–	–	–
	498000 A ² s	135 W	0.90	690 V	–	–	–	–
	819000 A ² s	155 W	0.85	1000 V	–	–	–	–
900 A	985000 A ² s	145 W	0.90	1100 V	–	–	–	–
	677000 A ² s	145 W	0.90	690 V	–	–	–	–
1000 A	1160000 A ² s	165 W	0.90	1000 V	–	–	–	–
	2480000 A ² s	140 W	0.85	600 V	3NC8444-3C	–	–	–
1100 A	975000 A ² s	155 W	0.95	690 V	–	–	–	–
	1670000 A ² s	170 W	0.90	1000 V	–	–	–	–
	1382000 A ² s	165 W	0.95	690 V	–	–	–	–
1250 A	1910000 A ² s	185 W	0.90	800 V	–	–	–	–
	1990000 A ² s	175 W	0.95	690 V	–	–	–	–
1400 A	2600000 A ² s	210 W	0.90	800 V	–	–	–	–
	2100000 A ² s	200 W	0.95	500 V	–	–	–	–
1600 A	2860000 A ² s	240 W	0.90	500 V	–	–	–	–

Further information

Screw fixing	■	■	■	■
Installation in SITOR fuse bases	3NH5463	–	3NH5473	–
Installation in 3NH LV HRC fuse bases	■	–	–	–
Installation in 3NP and 3KF fuse switching devices	■	–	–	–
Further currents, operational class gR	See page 7/58	–	–	–

¹⁾ For the max. DC voltage, see the Configuration Manual – Fuse systems, chapter Configuration, Use with direct current www.siemens.com/lowvoltage/manuals (45314810)

M12, 80 mm	M12, 110 mm	M12, 140 mm	M12, 210 mm	M12, 260 mm
				
-	-	-	-	-
-	-	-	-	3NE9622-1C
-	-	-	-	-
-	-	-	-	-
-	-	-	-	-
-	-	-	-	-
-	-	-	-	-
-	3NC3430-1U	-	-	-
-	-	-	-	-
-	-	-	-	-
-	-	-	-	-
-	-	-	-	-
-	3NC3432-1U	-	-	-
-	-	-	-	3NE9632-1C
-	-	-	-	-
-	-	-	-	-
-	-	-	3NE5433-1C	-
-	-	-	3NE7633-1U	-
-	-	-	-	-
-	3NC3434-1U	-	-	-
-	-	-	-	3NE9634-1C
-	-	-	3NE7648-1U	-
-	-	-	-	-
3NC3236-1U	-	-	-	-
-	3NC3336-1U	-	-	-
-	-	-	-	-
-	3NC3436-1U	-	-	-
-	-	-	3NE7636-1U	-
-	-	-	-	3NE9636-1C
3NC3237-1U	-	-	-	-
-	3NC3337-1U	-	-	-
-	-	3NE3637-1C	-	-
-	-	-	3NE7637-1U	-
3NC3238-1U	-	-	-	-
-	3NC3338-1U	-	-	-
-	3NC3438-1U	-	-	-
3NC3240-1U	-	-	-	-
-	3NC3340-1U	-	-	-
-	-	-	-	-
3NC3241-1U	-	-	-	-
-	3NC3341-1U	-	-	-
3NC3242-1U	-	-	-	-
-	3NC3342-1U	-	-	-
3NC3243-1U	-	-	-	-
-	3NC3343-1U	-	-	-
3NC3244-1U	-	-	-	-
3NC3245-1U	-	-	-	-
■	■	■	■	■
-	3NH5463	-	-	-
-	■	-	-	-
-	■	-	-	-
-	-	-	-	-

SITOR semiconductor fuse links, LV HRC design (AC/DC)

Operational class aR, with female thread at both ends

Screw fixing, flange dimension

Size 3

M10, 109 mm

M12, 52 mm



I_n	Switch-off I^2t value	Power loss P_v	Varying load factor WL	U_n AC ¹⁾		
315 A	72500 A ² s	80 W	0.95	1250 V	–	–
400 A	163000 A ² s	95 W	0.95	1250 V	–	–
450 A	488000 A ² s	110 W	1.00	1000 V	3NE3635-6	–
500 A	290000 A ² s	115 W	0.90	1250 V	–	–
630 A	244000 A ² s	125 W	0.90	690 V	–	3NC3236-6U
	418000 A ² s	130 W	0.90	1000 V	–	–
	650000 A ² s	120 W	0.95	1250 V	–	–
710 A	346000 A ² s	130 W	0.90	690 V	–	3NC3237-6U
	569000 A ² s	140 W	0.90	1000 V	–	–
800 A	498000 A ² s	135 W	0.95	690 V	–	3NC3238-6U
	819000 A ² s	150 W	0.90	1000 V	–	–
	985000 A ² s	145 W	0.95	1100 V	–	–
900 A	677000 A ² s	140 W	0.95	690 V	–	3NC3240-6U
	1160000 A ² s	160 W	0.95	1000 V	–	–
1000 A	975000 A ² s	145 W	1.00	690 V	–	3NC3241-6U
	1670000 A ² s	165 W	0.95	1000 V	–	–
1100 A	1382000 A ² s	150 W	1.00	690 V	–	3NC3242-6U
	1910000 A ² s	175 W	0.95	800 V	–	–
1250 A	1990000 A ² s	155 W	1.00	690 V	–	3NC3243-6U
	2600000 A ² s	185 W	0.95	800 V	–	–
1400 A	2100000 A ² s	175 W	1.00	500 V	–	3NC3244-6U
1600 A	2860000 A ² s	195 W	0.95	500 V	–	3NC3245-6U

Further information

Screw fixing



¹⁾ For the max. DC voltage, see the Configuration Manual – Fuse systems, chapter Configuration, Use with direct current www.siemens.com/lowvoltage/manuals/45314810

M12, 73 mm



M12, 73 mm



–	3NC3430-6U
–	3NC3432-6U
–	–
–	3NC3434-6U
–	–
3NC3336-6U	–
–	3NC3436-6U
–	–
3NC3337-6U	–
–	–
3NC3338-6U	–
–	3NC3438-6U
–	–
3NC3340-6U	–
–	–
3NC3341-6U	–
–	–
3NC3342-6U	–
–	–
3NC3343-6U	–
–	–
–	–
■	■

7

SITOR semiconductor fuse links, LV HRC design (AC/DC)

Operational class gR, special designs

					Without installation bracket	With installation bracket For SITOR 6QG11 thyristor sets
					Screw fixing, flange dimension	
					M10, 89 mm	
I_n	Switch-off I^2t value	Power loss P_v	Varying load factor WL	U_n AC		
50 A	1100 A ² s	20 W	0.85	600 V	–	3NE4117-5
850 A	2480000 A ² s	85 W	1.00	1000 V	3NE9440-6	–
Further information						
Screw fixing					■	■



Operational class aR, special designs

					Without installation bracket	For air-cooled rectifiers in electrolysis systems
					For screwing onto water-cooled busbars	
					Flange dimension	
					83 mm	89 mm
I_n	Switch-off I^2t value	Power loss P_v	Varying load factor WL	U_n AC		
100 A	7400 A ² s	35 W	0.85	1000 V	–	–
170 A	60500 A ² s	43 W	0.85	800 V	–	–
200 A	44000 A ² s	50 W	0.85	1000 V	–	–
250 A	635000 A ² s	25 W	0.90	680 V	–	–
	29700 A ² s	105 W	0.85	800 V	–	–
315 A	60700 A ² s	120 W	0.85	800 V	–	–
350 A	1430000 A ² s	32 W	0.90	680 V	–	–
	260000 A ² s	80 W	0.90	800 V	3NC5531	–
350 A	1430000 A ² s	32 W	0.90	680 V	–	–
450 A	191000 A ² s	140 W	0.85	800 V	–	–
	395000 A ² s	90 W	0.85	1000 V	–	–
500 A	276000 A ² s	155 W	0.85	800 V	–	–
600 A	888000 A ² s	150 W	0.90	1000 V	3NC5840	–
630 A	888000 A ² s	145 W	0.90	800 V	3NC5841	–
710 A	923000 A ² s	155 W	0.95	800 V	–	–
	620000 A ² s	150 W	0.90	900 V	3NE6437-7	3NE6437
800 A	1728000 A ² s	170 W	0.90	1000 V	3NC5838	–
900 A	1920000 A ² s	170 W	0.90	900 V	–	3NE6444
1250 A	2480000 A ² s	210 W	0.90	600 V	3NE9450-7	3NE9450
Further information						
Screw fixing					■	■

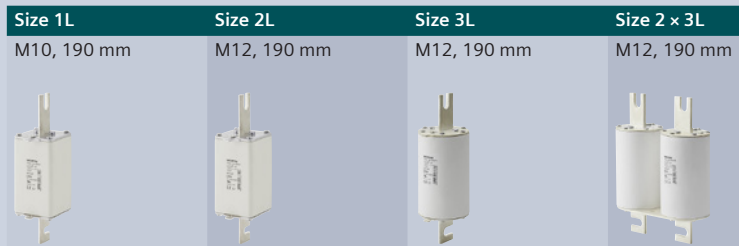


For mounting directly in the railway supply rectifier	For SITOR 6QG12 thyristor sets 77 mm	With installation bracket For SITOR 6QG10 thyristor sets	For SITOR 6QG11 thyristor sets
			
-	-	-	3NE4121-5
-	-	-	3NE4146-5
-	-	3NE3525-5	-
3NC7327-2	-	-	-
-	3NE4327-6B	-	-
-	3NE4330-6B	-	-
3NC7331-2	-	-	-
-	-	-	-
3NC7331-2	-	-	-
-	3NE4333-6B	-	-
-	-	3NE3535-5	-
-	3NE4334-6B	-	-
-	-	-	-
-	-	-	-
-	3NE4337-6	-	-
-	-	-	-
-	-	-	-
-	-	-	-
-	-	-	-
■	■	■	■

SITOR semiconductor fuse links, LV HRC design (DC)

Operational class aR, with slotted blade contacts

Screw fixing, Mounting dimensions











I_n	Switch-off I^2t value at $U_{VSI}^{1)}$	Power loss P_v	U_n DC/ U_{VSI} (IEC)	U_n DC (UL)	Size 1L M10, 190 mm	Size 2L M12, 190 mm	Size 3L M12, 190 mm	Size 2 x 3L M12, 190 mm
25 A	100 A ² s	8.2 W	440 V/700 V	500 V	–	–	–	–
32 A	220 A ² s	10.8 W	440 V/700 V	500 V	–	–	–	–
40 A	270 A ² s	12.5 W	440 V/700 V	500 V	–	–	–	–
50 A	480 A ² s	16 W	440 V/700 V	500 V	–	–	–	–
63 A	1100 A ² s	18.5	440 V/700 V	500 V	–	–	–	–
80 A	2600 A ² s	23 W	440 V/700 V	500 V	–	–	–	–
	1800 A ² s	42 W	1000 V/1250 V	1100 V	–	–	–	–
100 A	4000 A ² s	29 W	440 V/700 V	500 V	–	–	–	–
	4200 A ² s	28 W	600 V/1250 V	750 V	–	–	–	–
	3100 A ² s	45 W	1000 V/1250 V	1100 V	–	–	–	–
125 A	4800 A ² s	28.4 W	440 V/700 V	500 V	–	–	–	–
	6800 A ² s	36 W	600 V/1250 V	750 V	–	–	–	–
	6000 A ² s	59 W	1000 V/1250 V	1100 V	–	–	–	–
160 A	9800 A ² s	35.5 W	440 V/700 V	500 V	–	–	–	–
	12600 A ² s	42 W	600 V/1250 V	750 V	–	–	–	–
	13000 A ² s	54 W	1000 V/1250 V	1100 V	–	–	–	–
200 A	16000 A ² s	45.5 W	440 V/700 V	500 V	–	–	–	–
	24000 A ² s	42 W	600 V/1250 V	750 V	–	–	–	–
	28400 A ² s	56 W	1000 V/1250 V	1100 V	–	–	–	–
	100000 A ² s	75 W	1100 V/1800 V	1300 V	–	–	–	–
	39000 A ² s	50 W	1250 V/1500 V	1250 V	3NB1126-4KK11	–	–	–
250 A	34600 A ² s	50 W	600 V/1100 V	750 V	–	–	–	–
	60100 A ² s	59 W	1000 V/1250 V	1100 V	–	–	–	–
	150000 A ² s	110 W	1100 V/1800 V	1300 V	–	–	–	–
	80500 A ² s	51 W	1250 V/1500 V	1250 V	3NB1128-4KK11	–	–	–
315 A	69000 A ² s	65 W	600 V/1100 V	750 V	–	–	–	–
	75000 A ² s	80 W	900 V/1250 V	1000 V	–	–	–	–
	107000 A ² s	76 W	1000 V/1250 V	1100 V	–	–	–	–
	129000 A ² s	63 W	1250 V/1500 V	1250 V	–	3NB1231-4KK11	–	–
350 A	82000 A ² s	75 W	600 V/1100 V	750 V	–	–	–	–
	300000 A ² s	120 W	1100 V/1800 V	1300 V	–	–	–	–
400 A	109000 A ² s	85 W	600 V/1100 V	750 V	–	–	–	–
	107000 A ² s	95 W	900 V/1250 V	1000 V	–	–	–	–
	225000 A ² s	89 W	1000 V/1250 V	1100 V	–	–	–	–
	520000 A ² s	150 W	1100 V/1800 V	1300 V	–	–	–	–
	290000 A ² s	68 W	1250 V/1500 V	1250 V	–	3NB1234-4KK11	–	–

Further information

Screw fixing	■	■	■	■
Installation in SITOR fuse bases	–	–	–	–
Installation in 3NH LV HRC fuse bases	–	–	–	–
Installation in 3NP and 3KF fuse switching devices	–	–	–	–

¹⁾ For further I^2t values at U_n DC, see Configuration Manual – Fuse systems
www.siemens.com/lowvoltage/manuals (45314810)

Size 3 x 3L	Size 1	Size 2	Size 3 new	Size 3 (lang)		Size 2 (lang)	Size 00
M12, 190 mm	M10, 110 mm	M10, 110 mm	M12, 110 mm	M10, 210 mm	M12, 210 mm	M10, 170 mm	M10, 80 mm Bolt-on bracket
							
-	-	-	-	-	-	-	3NB1713-0KK13
-	-	-	-	-	-	-	3NB1715-0KK13
-	-	-	-	-	-	-	3NB1717-0KK13
-	-	-	-	-	-	-	3NB1720-0KK13
-	-	-	-	-	-	-	3NB1721-0KK13
-	-	-	-	-	-	-	3NB1722-0KK13
-	-	-	-	-	-	3NB1222-3KK15	-
-	-	-	-	-	-	-	3NB1723-0KK13
-	3NB1123-1KK15	-	-	-	-	-	-
-	-	-	-	-	-	3NB1223-3KK15	-
-	-	-	-	-	-	-	3NB1724-0KK13
-	3NB1124-1KK15	-	-	-	-	-	-
-	-	-	-	-	-	3NB1224-3KK15	-
-	-	-	-	-	-	-	3NB1725-0KK13
-	3NB1125-1KK15	-	-	-	-	-	-
-	-	-	-	-	-	3NB1225-3KK15	-
-	-	-	-	-	-	-	3NB1726-0KK13
-	3NB1126-1KK15	-	-	-	-	-	-
-	-	-	-	-	-	3NB1226-3KK15	-
-	-	-	-	3NB1326-4KK11	-	-	-
-	-	-	-	-	-	-	-
-	3NB1128-1KK15	-	-	-	-	-	-
-	-	-	-	-	-	3NB1228-3KK15	-
-	-	-	-	3NB1328-4KK11	-	-	-
-	-	-	-	-	-	-	-
-	3NB1131-1KK15	-	-	-	-	-	-
-	-	-	3NB1331-3KK11	-	-	-	-
-	-	-	-	-	-	3NB1231-3KK15	-
-	-	-	-	-	-	-	-
-	3NB1132-1KK15	-	-	-	-	-	-
-	-	-	-	3NB1332-4KK11	-	-	-
-	3NB1134-1KK15	3NB1234-1KK15	-	-	-	-	-
-	-	-	3NB1334-3KK11	-	-	-	-
-	-	-	-	-	-	3NB1234-3KK15	-
-	-	-	-	3NB1334-4KK11	-	-	-
-	-	-	-	-	-	-	-
■	■	■	■	■	■	■	■
-	3NH5463	3NH5463	3NH5463	-	-	-	-
-	■	■	■	-	-	-	-
-	■	■	■	-	-	-	-

7

SITOR semiconductor fuse links, LV HRC design (DC)

Operational class aR, with slotted blade contacts (continued)









Screw fixing, Mounting dimensions



I_n	Switch-off I^2t value at $U_{VSI}^{1)}$	Power loss P_v	$U_n DC/U_{VSI}$ (IEC)	$U_n DC$ (UL)	Size 1L M10, 190 mm	Size 2L M12, 190 mm	Size 3L M12, 190 mm	Size 2 x 3L M12, 190 mm
450 A	125000 A ² s	95 W	600 V/1100 V	750 V	–	–	–	–
	480000 A ² s	160 W	1100 V/1800 V	1300 V	–	–	–	–
500 A	178000 A ² s	105 W	600 V/700 V	700 V	–	–	–	–
	182000 A ² s	90 W	600 V/750 V	750 V	–	–	–	–
	200000 A ² s	115 W	900 V/1250 V	1000	–	–	–	–
	410000 A ² s	109 W	1000 V/1250 V	1100 V	3NB1237-3KK15	–	–	–
	600000 A ² s	89 W	1250 V/1500 V	1250 V	–	–	3NB1337-4KK11	–
525 A	620000 A ² s	210 W	1100 V/1800 V	1300 V	–	–	–	–
550 A	230000 A ² s	110 W	600 V/700 V	700 V	–	–	–	–
560 A	240000 A ² s	95 W	600 V/750 V	750 V	–	–	–	–
630 A	280000 A ² s	127 W	600 V/700 V	700 V	–	–	–	–
	350000 A ² s	100 W	600 V/750 V	750 V	–	–	–	–
	290000 A ² s	120 W	600 V/1000 V	750 V	–	–	–	–
	410000 A ² s	120 W	900 V/1250 V	1000 V	–	–	–	–
	520000 A ² s	163 W	1000 V/1250 V	1100 V	–	–	–	–
	1000000 A ² s	220 W	1100 V/1800 V	1300 V	–	–	–	–
710 A	430000 A ² s	105 W	500 V/600 V	600 V	–	–	–	–
	390000 A ² s	130 W	600 V/1000 V	750 V	–	–	–	–
	1150000 A ² s	275 W	1100 V/1800 V	1300 V	–	–	–	–
800 A	590000 A ² s	130 W	500 V/600 V	600 V	–	–	–	–
	550000 A ² s	135 W	600 V/1000 V	750 V	–	–	–	–
	620000 A ² s	145 W	800 V/1000 V	900 V	–	–	–	–
	1910000 A ² s	135 W	1250 V/1500 V	1250 V	–	–	3NB1345-4KK11	–
	1150000 A ² s	160 W	1250 V/1500 V	1250 V	–	–	–	3NB2345-4KK16
900 A	650000 A ² s	165 W	500 V/600 V	600 V	–	–	–	–
	740000 A ² s	145 W	600 V/1000 V	750 V	–	–	–	–
1000 A	2250000 A ² s	195 W	1250 V/1500 V	1250 V	–	–	–	3NB2350-4KK16
	1050000 A ² s	155 W	600 V/1000 V	750 V	–	–	–	–
1100 A	1600000 A ² s	165 W	600 V/900 V	750 V	–	–	–	–
1250 A	1800000 A ² s	175 W	500 V/900 V	600 V	–	–	–	–
1400 A	5100000 A ² s	250 W	1250 V/1500 V	1250 V	–	–	–	3NB2355-4KK16
1600 A	7450000 A ² s	275 W	1250 V/1500 V	1250 V	–	–	–	3NB2357-4KK16
2100 A	11950000 A ² s	365 W	1250 V/1500 V	1250 V	–	–	–	–
2400 A	18100000 A ² s	445 W	1250 V/1500 V	1250 V	–	–	–	–

Further information									
Screw fixing	■	■	■	■					
Installation in SITOR fuse bases	–	–	–	–					
Installation in 3NH LV HRC fuse bases	–	–	–	–					
Installation in 3NP and 3KF fuse switching devices	–	–	–	–					

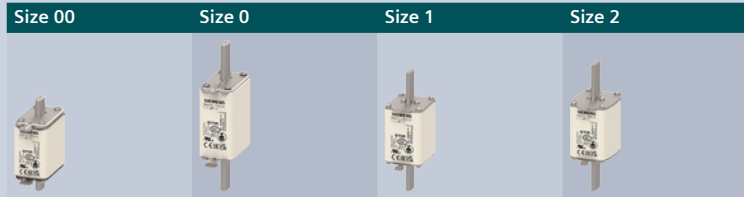
¹⁾ For further I^2t values at $U_n DC$, see Configuration Manual – Fuse systems www.siemens.com/lowvoltage/manuals (45314810)

Size 3 x 3L	Size 1	Size 2	Size 3 new	Size 3 (lang)		Size 2 (lang)	Size 00
M12, 190 mm	M10, 110 mm	M10, 110 mm	M12, 110 mm	M10, 210 mm	M12, 210 mm	M10, 170 mm	M10, 80 mm Bolt-on bracket
							
-	3NB1136-1KK15	3NB1236-1KK15	-	-	-	-	-
-	-	-	-	3NB1336-4KK11	3NB1336-4KK15	-	-
-	3NB1137-1KK11	-	-	-	-	-	-
-	-	3NB1237-1KK15	-	-	-	-	-
-	-	-	3NB1337-3KK11	-	-	-	-
-	-	-	-	-	-	3NB1237-3KK15	-
-	-	-	-	-	-	-	-
-	-	-	-	-	3NB1337-4KK15	-	-
-	3NB1138-1KK11	-	-	-	-	-	-
-	-	3NB1240-1KK15	-	-	-	-	-
-	3NB1142-1KK11	-	-	-	-	-	-
-	-	3NB1242-1KK15	-	-	-	-	-
-	-	-	3NB1342-1KK11	-	-	-	-
-	-	-	3NB1342-3KK11	-	-	-	-
-	-	-	-	-	-	3NB1242-3KK15	-
-	-	-	-	3NB1342-4KK11	3NB1342-4KK15	-	-
-	-	3NB1243-1KK15	-	-	-	-	-
-	-	-	3NB1343-1KK11	-	-	-	-
-	-	-	-	-	3NB1343-4KK15	-	-
-	-	3NB1245-1KK15	-	-	-	-	-
-	-	-	3NB1345-1KK11	-	-	-	-
-	-	-	3NB1345-3KK11	-	-	-	-
-	-	-	-	-	-	-	-
-	-	-	-	-	-	-	-
-	-	3NB1247-1KK15	-	-	-	-	-
-	-	-	3NB1347-1KK11	-	-	-	-
-	-	-	-	-	-	-	-
-	-	-	3NB1350-1KK11	-	-	-	-
-	-	-	3NB1351-1KK11	-	-	-	-
-	-	-	3NB1352-1KK11	-	-	-	-
-	-	-	-	-	-	-	-
-	-	-	-	-	-	-	-
3NB2364-4KK17	-	-	-	-	-	-	-
3NB2366-4KK17	-	-	-	-	-	-	-
■	■	■	■	■	■	■	■
-	3NH5463	3NH5463	3NH5463	-	-	-	-
-	■	■	■	-	-	-	-
-	■	■	■	-	-	-	-

7

SITOR semiconductor fuse links, LV HRC design (DC)

Operational class aR, with blade contacts without slots



I_n	Switch-off I^2t value at U_{vst} ¹⁾	Power loss P_v	U_n DC/ U_{vst} (IEC)	U_n DC (UL)	Size 00	Size 0	Size 1	Size 2
32 A	280 A ² s	12 W	600 V/900 V	750 V	–	3NB1015-1KK10	–	–
40 A	330 A ² s	13 W	600 V/900 V	750 V	–	3NB1017-1KK10	–	–
50 A	520 A ² s	16 W	600 V/900 V	750 V	–	3NB1020-1KK10	–	–
63 A	900 A ² s	20 W	600 V/900 V	750 V	–	3NB1021-1KK10	–	–
80 A	2100 A ² s	22 W	600 V/900 V	750 V	–	3NB1022-1KK10	–	–
	1100 A ² s	19 W	440 V/700 V	500 V	3NB1722-0KK10	–	–	–
100 A	3900 A ² s	24 W	600 V/900 V	750 V	–	3NB1023-1KK10	–	–
	3100 A ² s	25.5 W	440 V/600 V	500 V	–	–	3NB1123-0KK10	–
	3200 A ² s	22 W	440 V/700 V	500 V	3NB1723-0KK10	–	–	–
125 A	6800 A ² s	30 W	600 V/900 V	750 V	–	3NB1024-1KK10	–	–
	5400 A ² s	28.5 W	440 V/600 V	500 V	–	–	3NB1124-0KK10	–
	6200 A ² s	28 W	440 V/700 V	500 V	3NB1724-0KK10	–	–	–
160 A	13000 A ² s	35 W	600 V/800 V	750 V	–	3NB1025-1KK10	–	–
	8500 A ² s	37 W	440 V/600 V	500 V	–	–	3NB1125-0KK10	–
	8500 A ² s	38 W	440 V/700 V	500 V	3NB1725-0KK10	–	–	–
200 A	14500 A ² s	49 W	440 V/600 V	500 V	–	–	3NB1126-0KK10	–
250 A	30000 A ² s	52 W	440 V/600 V	500 V	–	–	3NB1128-0KK10	–
315 A	75000 A ² s	68 W	440 V/500 V	500 V	–	–	3NB1131-0KK10	–
350 A	45000 A ² s	68.6 W	440 V/500 V	500 V	–	–	–	3NB1232-0KK10
400 A	80000 A ² s	72.8 W	440 V/500 V	500 V	–	–	–	3NB1234-0KK10
450 A	100000 A ² s	80.1 W	440 V/500 V	500 V	–	–	–	3NB1236-0KK10
500 A	160000 A ² s	77.5 W	440 V/500 V	500 V	–	–	–	3NB1237-0KK10
550 A	230000 A ² s	86.4 W	440 V/500 V	500 V	–	–	–	3NB1238-0KK10
630 A	330000 A ² s	90.7 W	440 V/500 V	500 V	–	–	–	3NB1242-0KK10

Further information					Size 00	Size 0	Size 1	Size 2
Installation in 3NH LV HRC fuse bases					■	■	■	■
Installation in 3NP and 3KF fuse switching devices					■	■	■	■

¹⁾ For further I^2t values at U_n DC, see Configuration Manual – Fuse systems www.siemens.com/lowvoltage/manuals (45314810)

Operational class aR, with female thread at both ends **new**

Screw fixing, mounting dimension

Size 3

M12, 73 mm



I_n	Switch-off I^2t value at U_{VSI} ¹⁾	Power loss P_v	U_n DC/ U_{VSI} (IEC)	U_n DC (UL)	
315 A	75000 A ² s	80 W	900 V/1250 V	1000 V	3NB1331-3KK12
400 A	107000 A ² s	95 W	900 V/1250 V	1000 V	3NB1334-3KK12
500 A	200000 A ² s	115 W	900 V/1250 V	1000 V	3NB1337-3KK12
630 A	290000 A ² s	130 W	600 V/1000 V	750 V	3NB1342-1KK12
	410000 A ² s	120 W	900 V/1250 V	1000 V	3NB1342-3KK12
710 A	390000 A ² s	140 W	600 V/1000 V	750 V	3NB1343-1KK12
800 A	550000 A ² s	150 W	600 V/1000 V	750 V	3NB1345-1KK12
	620000 A ² s	145 W	800 V/1000 V	900 V	3NB1345-3KK12
900 A	740000 A ² s	160 W	600 V/1000 V	750 V	3NB1347-1KK12
1000 A	1050000 A ² s	165 W	600 V/1000 V	750 V	3NB1350-1KK12
1100 A	1600000 A ² s	175 W	600 V/900 V	750 V	3NB1351-1KK12
1250 A	1800000 A ² s	185 W	500 V/900 V	600 V	3NB1352-1KK12

Further information

Screw fixing

1) For further I^2t values at U_n DC, see Configuration Manual – Fuse systems
www.siemens.com/lowvoltage/manuals (45314810)

SITOR semiconductor fuse links, cylindrical fuse design (AC/DC)

Operational class gS

Size 22 x 127 mm



I_n	Switch-off I^2t value	Power loss P_v	U_n AC/DC	
1 A	2 A ² s	2 W	1500 V/1000 V	3NC2301-OMK
2 A	4.4 A ² s	2.5 W	1500 V/1000 V	3NC2302-OMK
4 A	55 A ² s	5.3 W	1500 V/1000 V	3NC2304-OMK
6 A	150 A ² s	6.4 W	1500 V/1000 V	3NC2306-OMK
10 A	540 A ² s	3.1 W	1500 V/1000 V	3NC2310-OMK
16 A	1120 A ² s	4.7 W	1500 V/1000 V	3NC2316-OMK
20 A	2850 A ² s	5.4 W	1500 V/1000 V	3NC2320-OMK
25 A	3300 A ² s	6.9 W	1500 V/1000 V	3NC2325-OMK
32 A	9050 A ² s	6.7 W	1500 V/1000 V	3NC2332-OMK
Further information				
Installation in SITOR fuse holders				3NC23
Further currents, operational class gR				see page 7/78
Further currents, operational class aR				see page 7/80

7

SITOR semiconductor fuse links, cylindrical fuse design (AC/DC)

Operational class gR



I_n	Switch-off I^2t value	Power loss P_v	U_n AC/DC	Size 10 x 38 mm	Size 14 x 51 mm	Size 22 x 58 mm	Size 22 x 127 mm
2 A	33 A ² s	0.5 W	-/1100 V ²⁾	3NC1202-OMK	-	-	-
4 A	99 A ² s	0.7 W	-/1100 V ²⁾	3NC1204-OMK	-	-	-
6 A	3,5 A ² s	3.1 W	690 V/700 V ¹⁾	-	3NC1406-OMK	-	-
	6,5 A ² s	2.5 W	690 V/440 V	3NC1006-OMK	-	-	-
	120 A ² s	1.4 W	-/1100 V ²⁾	3NC1206-OMK	-	-	-
8 A	210 A ² s	1.7 W	-/1100 V ²⁾	3NC1208-OMK	-	-	-
10 A	15 A ² s	4.6 W	690 V/700 V ¹⁾	-	3NC1410-OMK	-	-
	17 A ² s	4.3 W	690 V/440 V	-	-	-	-
	18 A ² s	3.3 W	690 V/440 V	3NC1010-OMK	-	-	-
	260 A ² s	2.3 W	-/1000 V ³⁾	3NC1210-OMK	-	-	-
12 A	35 A ² s	4 W	690 V/440 V	3NC1012-OMK	-	-	-
16 A	32 A ² s	6.7 W	690 V/600 V	-	3NC1416-OMK	-	-
	45 A ² s	6 W	690 V/440 V	3NC1016-OMK	-	-	-
	52 A ² s	4.4 W	690 V/440 V	-	-	-	-
20 A	68 A ² s	7.4 W	690 V/600 V	-	3NC1420-OMK	-	-
	90 A ² s	6.5 W	690 V/440 V	-	-	-	-
	110 A ² s	7.8 W	690 V/250 V	3NC1020-OMK	-	-	-
25 A	108 A ² s	8.4 W	690 V/600 V	-	3NC1425-OMK	-	-
	120 A ² s	9.5 W	690 V/440 V	-	-	-	-
	140 A ² s	8.7 W	690 V/250 V	3NC1025-OMK	-	-	-
	160 A ² s	8.5 W	690 V/440 V	-	-	-	-
	180 A ² s	8.1 W	690 V/700 V ¹⁾	-	-	3NC2225-OMK	-
32 A	175 A ² s	12.3 W	690 V/600 V	-	3NC1432-OMK	-	-
	220 A ² s	12.3 W	690 V/440 V	-	-	-	-
	400 A ² s	8.9 W	690 V/440 V	-	-	-	-
	420 A ² s	9 W	690 V/600 V	-	-	3NC2232-OMK	-
	450 A ² s	12 W	690 V/250 V	3NC1032-OMK	-	-	-
40 A	400 A ² s	14.8 W	690 V/440 V	-	-	-	-
	470 A ² s	11.7 W	690 V/440 V	-	3NC1440-OMK	-	-
	600 A ² s	11 W	690 V/440 V	-	-	-	-
	700 A ² s	12.5 W	690 V/440 V	-	-	3NC2240-OMK	-
	1850 A ² s	9.4 W	1500 V/1000 V	-	-	-	3NC2340-OMK
50 A	830 A ² s	16.3 W	690 V/250 V	-	-	-	-
	980 A ² s	17.5 W	690 V/440 V	-	-	-	-
	1250 A ² s	13.8 W	690 V/440 V	-	-	-	-
	1250 A ² s	15.2 W	690 V/250 V	-	-	-	-
63 A	2050 A ² s	18.8 W	690 V/440 V	-	-	-	-
	2400 A ² s	17.5 W	690 V/250 V	-	-	-	-
80 A	4400 A ² s	23 W	690 V/250 V	-	-	-	-
100 A	11500 A ² s	28.7 W	690 V/250 V	-	-	-	-
Further information							
Screw fixing				-	-	-	-
Installation in SITOR fuse holders				3NC109.	3NC149.	3NC229.	3NC23
Installation in SITOR fuse bases				-	-	-	-
Further currents, operational class gS				-	-	-	See page 7/76
Further currents, operational class aR				-	-	-	See page 7/80

¹⁾ Observe 600 V DC voltage according to IEC, 700 V according to UL, time constant and minimum breaking current MBC.
²⁾ DC voltage (IEC) at time constant 10 ms, VSI voltage 1150 V at time constant < 3 ms, UL voltage 1250 V at time constant 10 ms
³⁾ DC voltage (IEC) at time constant 10 ms, VSI voltage 1150 V at time constant < 3 ms, UL voltage 1100 V at time constant 10 ms

With M8 bolt-on links

Size 18 × 88 mm

Size 26 × 103 mm



-	-
-	-
-	-
-	-
-	-
-	-
-	-
3NC1810-0MK	-
-	-
-	-
-	-
-	-
3NC1816-0MK	-
-	-
3NC1820-0MK	-
-	-
-	-
-	3NC2625-0MK
-	-
3NC1825-0MK	-
-	-
-	-
-	3NC2632-0MK
3NC1832-0MK	-
-	-
-	-
-	3NC2640-0MK
-	-
3NC1840-0MK	-
-	-
-	-
-	-
-	3NC2650-0MK
3NC1850-0MK	-
-	-
-	3NC2663-0MK
-	-
-	-
-	-
■	■
-	-
3NH5723	3NH5023
-	-
-	-

SITOR semiconductor fuse links, cylindrical fuse design (AC/DC)

Operational class aR

Size 10 × 38 mm¹⁾

Size 14 × 51 mm

Standard



With striking pin



I_n	Switch-off I^2t value	Power loss P_V	U_n AC/DC			
1 A	1.2 A ² s	5 W	660 V/–	–	3NC1401	–
2 A	10 A ² s	3 W	660 V/–	–	3NC1402	–
3 A	8 A ² s	1.2 W	600/700 V ¹⁾	3NC1003	–	–
	15 A ² s	2.5 W	660 V/–	–	3NC1403	–
4 A	25 A ² s	3 W	660 V/–	–	3NC1404	–
5 A	11 A ² s	1.5 W	690/700 V ¹⁾	–	3NC1405	–
6 A	11 A ² s	1.5 W	690/700 V ¹⁾	–	3NC1406	–
	20 A ² s	1.5 W	600/700 V ¹⁾	3NC1006	–	–
8 A	30 A ² s	2 W	600/700 V ¹⁾	3NC1008	–	–
10 A	22 A ² s	4 W	690/700 V ¹⁾	–	3NC1410	–
	32 A ² s	4 W	690/600 V ¹⁾	–	–	3NC1410-5
	60 A ² s	2.5 W	600/700 V ¹⁾	3NC1010	–	–
12 A	110 A ² s	3 W	600/700 V ¹⁾	3NC1012	–	–
15 A	63 A ² s	5.5 W	690/600 V ¹⁾	–	–	3NC1415-5
	70 A ² s	5.5 W	690/700 V ¹⁾	–	3NC1415	–
16 A	150 A ² s	3.5 W	600/700 V ¹⁾	3NC1016	–	–
20 A	100 A ² s	6 W	690/700 V ¹⁾	–	3NC1420	–
	200 A ² s	4.8 W	600/700 V ¹⁾	3NC1020	–	–
	220 A ² s	4.6 W	690/700 V ¹⁾	–	–	–
	234 A ² s	6 W	690/600 V ¹⁾	–	–	3NC1420-5
	240 A ² s	5 W	690/500 V ¹⁾	–	–	–
	25 A	250 A ² s	6 W	600/700 V ¹⁾	3NC1025	–
30 A	300 A ² s	5.6 W	690/700 V ¹⁾	–	–	–
	320 A ² s	7 W	690/700 V ¹⁾	–	3NC1425	–
	350 A ² s	6 W	690/500 V ¹⁾	–	–	–
	378 A ² s	7 W	690/600 V ¹⁾	–	–	3NC1425-5
	400 A ² s	9 W	690/700 V ¹⁾	–	3NC1430	–
32 A	466 A ² s	9 W	690/600 V ¹⁾	–	–	3NC1430-5
	450 A ² s	7 W	690/700 V ¹⁾	–	–	–
	500 A ² s	7.5 W	660 V/–	3NC1032	–	–
	500 A ² s	8 W	690/500 V ¹⁾	–	–	–
	600 A ² s	7.6 W	690/700 V ¹⁾	–	3NC1432	–
	600 A ² s	7.6 W	690/600 V ¹⁾	–	–	3NC1432-5
40 A	700 A ² s	8.5 W	690/700 V ¹⁾	–	–	–
	750 A ² s	8 W	690/600 V ¹⁾	–	–	3NC1440-5
	750 A ² s	8 W	690/700 V ¹⁾	–	3NC1440	–
	800 A ² s	9 W	690/500 V ¹⁾	–	–	–
Further information						
Screw fixing				–	–	–
Installation in SITOR fuse holders				3NC109.	3NC149.	3NC149.-5
Installation in SITOR fuse bases				–	–	–
Further currents, operational class gR				–	–	–
Further currents, operational class gS				–	–	–

¹⁾ Observe DC voltage acc. to UL, time constant and minimum breaking current MBC

SITOR semiconductor fuse links, cylindrical fuse design (AC/DC)

Operational class aR (continued)

Size 10 × 38 mm¹⁾

Size 14 × 51 mm

Standard







With striking pin



I_n	Switch-off I^2t value	Power loss P_V	U_n AC/DC	Size 10 × 38 mm ¹⁾	Size 14 × 51 mm Standard	Size 14 × 51 mm With striking pin
50 A	1350 A ² s	9.5 W	690/700 V ¹⁾	–	–	–
	1500 A ² s	9.5 W	690/500 V ¹⁾	–	–	–
	1800 A ² s	9 W	690/600 V ¹⁾	–	–	–
	1800 A ² s	9 W	690/700 V ¹⁾	–	3NC1450	3NC1450-5
	26000 A ² s	11.6 W	1500/1000 V	–	–	–
63 A	2100 A ² s	16.7 W	690/250 V	–	3NC1463-0MK	–
	2600 A ² s	11 W	690/700 V ¹⁾	–	–	–
	3000 A ² s	11 W	690/500 V ¹⁾	–	–	–
80 A	3500 A ² s	22.5 W	690/440 V	–	–	–
	5500 A ² s	13.5 W	690/700 V ¹⁾	–	–	–
	6000 A ² s	13.5 W	690/500 V ¹⁾	–	–	–
100 A	5400 A ² s	31.5 W	690/440 V	–	–	–
	8000 A ² s	16 W	690/700 V ¹⁾	–	–	–
	8500 A ² s	16 W	600/500 V ¹⁾	–	–	–
125 A	11800 A ² s	39 W	690/440 V	–	–	–
	29000 A ² s	35.3 W	690/250 V	–	–	–
Further information						
Screw fixing				–	–	–
Installation in SITOR fuse holders				3NC109.	3NC149.	3NC149.-5
Installation in SITOR fuse bases				–	–	–
Further currents, operational class gR				–	–	–
Further currents, operational class gS				–	–	–

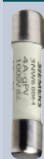
¹⁾ Observe DC voltage acc. to UL, time constant and minimum breaking current MBC

Size 22 × 58 mm		Size 22 × 127 mm		Size 26 × 103 mm
Standard	With striking pin			With M8 bolt-on links
				
3NC2250	–	–	–	–
–	3NC2250-5	–	–	–
–	–	–	–	–
–	–	3NC2350-0MK	–	–
–	–	–	–	–
3NC2263	–	–	–	–
–	3NC2263-5	–	–	–
–	–	–	–	3NC2680-0MK
3NC2280	–	–	–	–
–	3NC2280-5	–	–	–
–	–	–	–	3NC2600-0MK
3NC2200	–	–	–	–
–	3NC2200-5	–	–	–
–	–	–	–	3NC2611-0MK
3NC2211-0MK	–	–	–	–
–	–	–	–	■
3NC229.	3NC229.-5	3NC23	–	–
–	–	–	–	3NH5023
–	–	–	–	–
–	–	See page 7/78	–	–
–	–	See page 7/76	–	–

Photovoltaic fuse links

Cylindrical fuse de sign, operational class gPV

Size 10 × 38 mm









Size 10 × 85 mm



I_n DC	Power loss P_v	Power loss P_v at 70% ¹⁾	U_n DC		
2 A	1.4 W	0.6 W	1000 V	3NW6002-4	–
4 A	1.6 W	0.7 W	1000 V	3NW6004-4	–
	2.7 W	1.1 W	1500 V	–	3NW6604-4
6 A	1.7 W	0.7 W	1000 V	3NW6001-4	–
	3.0 W	1.2 W	1500 V	–	3NW6601-4
8 A	1.9 W	0.8 W	1000 V	3NW6008-4	–
	3.6 W	1.5 W	1500 V	–	3NW6608-4
10 A	2.3 W	1.0 W	1000 V	3NW6003-4	–
	3.7 W	1.6 W	1500 V	–	3NW6603-4
12 A	2.7 W	1.1 W	1000 V	3NW6006-4	–
	3.3 W	1.4 W	1500 V	–	3NW6606-4
16 A	3.2 W	1.3 W	1000 V	3NW6005-4	–
	3.7 W	1.6 W	1500 V	–	3NW6605-4
20 A	3.4 W	1.4 W	1000 V	3NW6007-4	–
	4.0 W	1.7 W	1200 V	–	3NW6607-4
Further information					
Installation in fuse holders				3NW70...-4	3NW76...-4




¹⁾ Tested in fuse holders 3NW7013-4 and 3NW7613-4.

LV HRC design, operational class gPV

			Size 1	Size 1L	Size 2L	Size 3L	Size 1XL	Size 2XL
								
I_n DC	Power loss P_v	U_n DC						
63 A	19 W	1000 V	3NE1218-4	–	–	–	–	–
	20 W	1500 V	–	–	–	–	3NE1218-5E	–
80 A	20 W	1000 V	3NE1220-4	–	–	–	–	–
	25 W	1500 V	–	–	–	–	3NE1220-5E	–
100 A	24 W	1000 V	3NE1221-4	–	–	–	–	–
	30 W	1500 V	–	–	–	–	3NE1221-5E	–
125 A	26 W	1000 V	3NE1222-4	–	–	–	–	–
	29 W	1500 V	–	–	–	–	3NE1222-5E	–
160 A	32 W	1000 V	3NE1224-4	–	–	–	–	–
	34 W	1500 V	–	–	–	–	3NE1224-5E	–
200 A	41 W	1500 V	–	–	–	–	3NE1225-5E	–
	51 W	1000 V	–	3NE1225-4D	–	–	–	–
250 A	53 W	1500 V	–	–	–	–	–	3NE1327-5E
	54 W	1000 V	–	3NE1227-4D	–	–	–	–
315 A	63 W	1500 V	–	–	–	–	–	3NE1330-5E
	73 W	1000 V	–	–	3NE1330-4D	–	–	–
400 A	82 W	1000 V	–	–	3NE1332-4D	–	–	–
500 A	100 W	1000 V	–	–	–	3NE1434-4E	–	–
630 A	110 W	1000 V	–	–	–	3NE1436-4E	–	–

Class CC fuse links

Acc. to UL

Characteristic: Slow	Characteristic: Slow, current-limiting	Characteristic: Quick
		

I_n	$I_n^{1)}$			
0.6 A	6/10 A	3NW1006-0HG	–	–
0.8 A	8/10 A	3NW1008-0HG	–	–
1 A	–	3NW1010-0HG	3NW3010-0HG	3NW2010-0HG
1.5 A	1.5 A	3NW1015-0HG	–	–
2 A	–	3NW1020-0HG	3NW3020-0HG	3NW2020-0HG
2.5 A	–	3NW1025-0HG	–	–
3 A	–	3NW1030-0HG	3NW3030-0HG	3NW2030-0HG
4 A	–	3NW1040-0HG	3NW3040-0HG	3NW2040-0HG
5 A	–	3NW1050-0HG	3NW3050-0HG	3NW2050-0HG
6 A	–	3NW1060-0HG	3NW3060-0HG	3NW2060-0HG
7.5 A	–	3NW1075-0HG	–	–
8 A	–	3NW1080-0HG	3NW3080-0HG	3NW2080-0HG
10 A	–	3NW1100-0HG	3NW3100-0HG	3NW2100-0HG
12 A	–	–	3NW3120-0HG	3NW2120-0HG
15 A	–	3NW1150-0HG	3NW3150-0HG	3NW2150-0HG
20 A	–	3NW1200-0HG	3NW3200-0HG	3NW2200-0HG
25 A	–	3NW1250-0HG	3NW3250-0HG	3NW2250-0HG
30 A	–	3NW1300-0HG	3NW3300-0HG	3NW2300-0HG

Further information

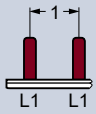
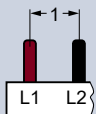
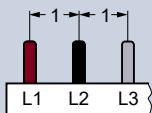
Installation in fuse holders	3NW75.3-0HG, 3NW753.-1HG, 3NW7431-0HG	3NW75.3-0HG, 3NW753.-1HG, 3NW7431-0HG	3NW75.3-0HG, 3NW753.-1HG, 3NW7431-0HG
------------------------------	--	--	--

¹⁾ American English wording

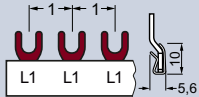
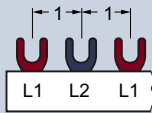
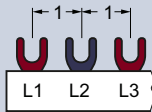
Busbars

According to IEC, can be cut

Pin spacing 1 MW

Pin spacing in MW (1 MW = 18 mm)	Application	Length	Version	Conductor cross-section	Article No.
1-phase, angled 	For cylindrical fuse holders 8 × 32 mm and 10 × 38 mm For SITOR cylindrical fuse holders 10 × 38 mm	214 mm	With end caps	16 mm ²	5ST3700
		1016 mm	Without end caps	16 mm ²	5ST3701
2-phase 	For cylindrical fuse holders 8 × 32 mm and 10 × 38 mm For SITOR cylindrical fuse holders 10 × 38 mm	214 mm	With end caps	16 mm ²	5ST3704
		1016 mm	Without end caps	16 mm ²	5ST3705
3-phase 	For cylindrical fuse holders 8 × 32 mm and 10 × 38 mm For SITOR cylindrical fuse holders 10 × 38 mm	214 mm	With end caps	16 mm ²	5ST3708
		1016 mm	Without end caps	16 mm ²	5ST3710

Fork spacing 1 MW

Fork spacing in MW (1 MW = 18 mm)	Application	Length	Version	Conductor cross-section	Article No.
1-phase 	For MINIZED D01 fuse switch disconnectors	1000 mm	Without end caps	16 mm ²	5ST2190
		1016 mm	Without end caps	16 mm ²	5ST2191
2-phase 	For MINIZED D01 fuse switch disconnectors	1000 mm	Without end caps	16 mm ²	5ST2191
		1016 mm	Without end caps	16 mm ²	5ST2192
3-phase 	For MINIZED D01 fuse switch disconnectors	1000 mm	Without end caps	16 mm ²	5ST2192
		1016 mm	Without end caps	16 mm ²	5ST2193

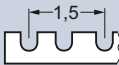
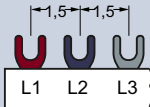
According to IEC, can be cut

Pin spacing 1.5 MW

Pin spacing in MW (1.5 MW = 27 mm)	Application	Length	Version	Conductor cross-section	Article No.
1-phase, angled					
	For 5SG71.3 MINIZED D02 switch disconnectors with fuses For NEOZED D01/D02 fuse bases made of molded plastic 5SG1301, 5SG1701, 5SG1302, 5SG1702 For NEOZED D01/D02 fuse bases made of ceramic with saddle terminals For cylindrical fuse holders 14 × 51 mm, 3NW7111 For SITOR cylindrical fuse holders 14 × 51 mm, 3NC1491	1016 mm	Without end caps	16 mm ²	5ST3703
3-phase					
	For 5SG71.3 MINIZED D02 switch disconnectors with fuses For NEOZED D01/D02 fuse bases made of molded plastic 5SG5301, 5SG5701, 5SG5302, 5SG5702 For NEOZED D01/D02 fuse bases made of ceramic with saddle terminals For cylindrical fuse holders 14 × 51 mm, 3NW7131 For SITOR cylindrical fuse holders 14 × 51 mm, 3NC1493	1016 mm	Without end caps	16 mm ²	5ST3714

7

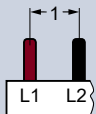
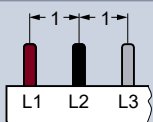
Fork spacing 1.5 MW

Fork spacing in MW (1.5 MW = 27 mm)	Application	Length	Version	Conductor cross-section	Article No.
1-phase					
	For NEOZED D01/D02 fuse bases made of ceramic with clamp-type terminal and screw head contacts	1000 mm	Without end caps, non-insulated	36 mm ²	5SH5322
3-phase					
	For NEOZED D01/D02 fuse bases made of ceramic with clamp-type terminals and screw head contacts	1000 mm	Without end caps	16 mm ²	5SH5320

Busbars

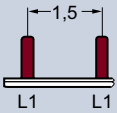
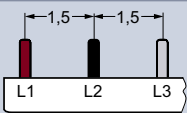
According to UL 508, can be cut

Pin spacing 1 MW

Pin spacing in MW (1 MW = 18 mm)	Application	Length	Version	Conductor cross-section	Article No.
1-phase 	For Class CC fuse holders 10 × 38 mm (3NC1091, 3NW7513-0HG)	1000 mm	Without end caps	18 mm ²	5ST3701-0HG
2-phase 	For Class CC fuse holders 10 × 38 mm (3NC1092, 3NW7523-0HG)	1000 mm	Without end caps	18 mm ²	5ST3705-0HG
3-phase 	For Class CC fuse holders 10 × 38 mm (3NC1093, 3NW7533-0HG)	1000 mm	Without end caps	18 mm ²	5ST3710-0HG

According to UL 508, can be cut







Pin spacing 1.5 MW

Pin spacing in MW (1 MW = 18 mm)	Application	Length	Version	Conductor cross-section	Article No.
1-phase 	For fuse holders 14 × 51 mm (3NC1491, 3NW7111)	1000 mm	Without end caps	18 mm ²	5ST3703-0HG
				25 mm ²	5ST3701-2HG
2-phase 	For fuse holders 14 × 51 mm (3NC1492, 3NW7121)	1000 mm	Without end caps	25 mm ²	5ST3705-2HG
3-phase 	For fuse holders 14 × 51 mm (3NC1493, 3NW7131)	1000 mm	Without end caps	18 mm ²	5ST3714-0HG
				25 mm ²	5ST3710-2HG

Busbars

Accessories

For busbars according to IEC

Terminals			
	<ul style="list-style-type: none"> For NEOZED D01/D02 fuse bases made of ceramic For DIAZED DII/DIII fuse bases made of ceramic 		
	Terminal version	Conductor cross-section	Article No.
	Terminal version S	2 ... 25 mm ²	5SH5327
	Terminal versions B and K	6 ... 25 mm ²	5SH5328
	Touch protection		
	<ul style="list-style-type: none"> For free connections, yellow (RAL 1004) 5 × 1 pin 		
			Article No.
			5ST3655
End caps			
	Version	For busbar type	Article No.
	For 1-phase busbars	5ST2190	5ST2196
		5ST37 and 5SH55	5ST3748
	For 2-phase and 3-phase busbars	5ST2191 and 5ST2192	5ST2197
		5ST37 and 5SH5320	5ST3750
			

For busbars according to UL 508

Terminals according to UL 508



Version	Infeed	Article No.
For busbars 35 mm ²	Device	5ST3770-0HG
For busbars 30 mm ²	Busbar	5ST3770-1HG

Busbar touch protection according to UL 508



- For free connections, yellow (RAL 1004) 5 × 1 pin

Article No.
5ST3655-0HG

End caps for 5ST37. ..HG



Version	Article No.
For 1-phase busbars	5ST3748-0HG
For 2 and 3-phase busbars	5ST3750-0HG

7

LV HRC signal detectors, electronic fuse monitoring

LV HRC signal detectors



- Only for SIEMENS 3NA3, 3NA7, 3ND LV HRC fuse links with non-insulated grip lugs
- Rated voltage of up to 690 V AC/600 V DC
- Contact: Microswitches 250 V AC, 6 A
- Connection: flat male tab A2.8 × 0.5 mm acc. to DIN 46244

Fuse size	Article No.
000 ... 4	3NX1021

Signal detector links



- Rated voltage of up to 690 V AC/600 V DC

Fuse size	Response value	Application	Article No.
000 ... 4	> 9 V/2.5 A	For standard applications	3NX1022
	> 2 V/7 A	Only for meshed networks	3NX1023

Signal detector tops



- Only for SIEMENS 3NA3, 3NA7, 3ND LV HRC fuse links with non-insulated grip lugs
- Rated voltage of up to 690 V AC/600 V DC
- Contact: Microswitch 230 V AC, 5 A, 1 CO
- Connection: flat connector 2.3 mm

Fuse size	Article No.
000, 00, 1, 2	3NX1024

Electronic fuse monitor



- For all low-voltage fuse systems
- For monitoring all types and versions of melting fuses that cannot be equipped with a fault signal contact
- Can be used in asymmetric systems afflicted with harmonics and regenerative feedback motors
- Signal also for disconnected loads

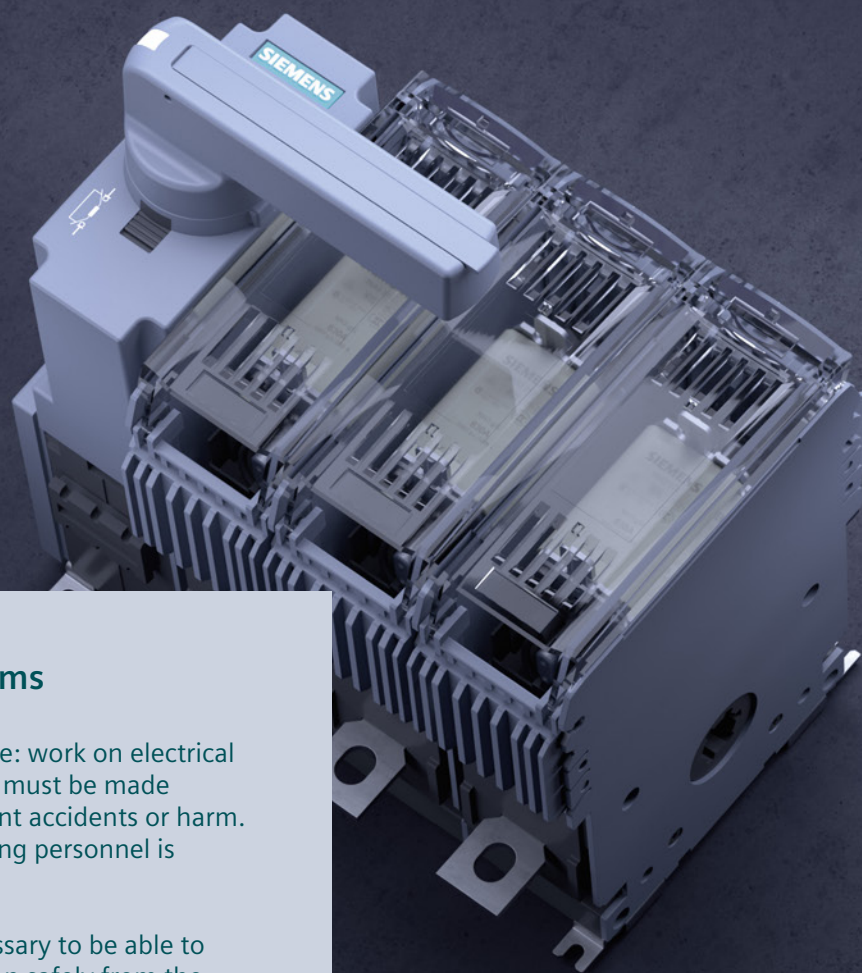
U_e AC	I_n	U_c	Article No.
230 V	4 A	3 AC 380 ... 415 V	5TT3170

Electronic fuse monitor for remote display of tripped fuses



- Remote display by auxiliary contact (1 CO)
- Local detection by integrated LED
- For all sizes
- For 3KF LV HRC and 3KF SITOR

U_e AC	I_n	U_c	Article No.
230 V	1.5 A	3 AC 690 V	3KF9010-1AA00



End-to-end safety for user and systems

Assembly or maintenance: work on electrical installations and devices must be made sufficiently safe to prevent accidents or harm. The safety of the operating personnel is paramount.

To ensure this, it is necessary to be able to disconnect the installation safely from the power supply. Siemens switch disconnectors permit permanent switch-on and switch-off under a load and thus protect the user from electric shock. They also prevent unauthorized switching on of machines.

The devices are easy to install and can be quickly put into operation. Additional functions can be retrofitted at any time – thanks to the modular design of the devices and a comprehensive range of accessories.

Convenient ordering processes and fast delivery optimize stock-keeping and save you time and money. You can also make use of our CAx data for automated, simplified planning and configuring.

Switch Disconnectors



All the information you need	8/2
Quick selection guide	8/4
Fuseless switch disconnectors	8/6
Quick selection guide	8/6
3LD switch disconnectors	8/12
3KD switch disconnectors	8/66
Fuse switch disconnectors	8/82
Quick selection guide	8/82
3NP1 fuse switch disconnectors	8/84
3NP5 fuse switch disconnectors	8/98
3NJ4 fuse switch disconnectors	8/102
5SG76 fuse switch disconnectors	8/114
Switch disconnectors with fuses	8/116
Quick selection guide	8/116
3KF switch disconnectors with fuses	8/120
3NJ63 switch disconnectors with fuses	8/136
5SG switch disconnectors with fuses	8/144

A multitude of additional information ...

Information + ordering

All the important things at a glance

For information about switch disconnectors, please visit our website www.siemens.com/switching-devices

Your product in detail

The relevant tender specifications can be found at www.siemens.com/tenderspecifications

Use our conversion tool for quick and easy conversion to Siemens products www.siemens.com/conversion-tool

Configurators

The configurator reduces the time and effort required in the planning and ordering process, and allows for individual adaptations.

Configure your switch disconnector at www.siemens.com/lowvoltage/3nj63-configurator
www.siemens.com/lowvoltage/3ld-configurator
www.siemens.de/lowvoltage/3kd-konfigurator
 your switch disconnector with fuses at www.siemens.com/lowvoltage/3kf-configurator
 and your 3NP1 fuse switch disconnector at www.siemens.com/lowvoltage/3np1-configurator

Choose the right SITOR semiconductor fuse for your application www.siemens.com/lowvoltage/sitor-configurator

Everything you need for your order

Refer to SiePortal to find an overview of your products (product catalog)

- Switch disconnectors sie.ag/36HDiZp

Direct forwarding to the individual products in SiePortal by clicking on the article number in the catalog or entering this web address incl. article number www.siemens.com/product_catalog_SIEP?Article No.

You will find order support for the electrical wholesale trade carrying fast-selling items in SiePortal at www.siemens.com/lowvoltage/product-support

- Order Support
 - 3KD switch disconnectors – End-to-end safety for user and systems (109750228)
 - 3LD2 main control and EMERGENCY-STOP-switching equipment – End-to-end safety for user and systems (109755626)
 - 3NP1 fuse switch disconnectors – End-to-end safety for user and systems (109755624)
 - 3KF switch disconnectors with fuses – End-to-end safety for user and systems (109750229)
 - 3NJ63 switch disconnectors with fuses – End-to-end safety for user and systems (109755619)

8

The fast track to the experts

Contact persons in your region

We offer a comprehensive portfolio of services. You can find your local contacts at www.siemens.com/lowvoltage/components/contact

You will find further information on services at www.siemens.com/service-offers

Competent expert advice on technical questions with a wide range of demand-optimized services for all our products and systems.

Assistance with technical queries is provided at www.siemens.com/support-request

... can be found in our online services

Commissioning + operation

Your product in detail

The SiePortal platform (knowledge base) provides detailed technical information

www.siemens.com/lowvoltage/product-support

- Operating instructions
- Certificates

Online Support app available for download from the [App Store](#) and [Play Store](#)

You will find further information at <http://www.siemens.com/support-app>

Provision of 3D data (step and u3d data formats)

- SiePortal (product catalog)
www.siemens.com/lowvoltage/product-catalog
- Image database
www.siemens.com/lowvoltage/picturedb

Engineering data for CAD or CAE systems are available in the CAx Download Manager at

www.siemens.com/cax

Manuals

Manuals can be found in SiePortal at

www.siemens.com/lowvoltage/manuals

- Configuration Manual
 - Switch disconnectors (**109769744**)
 - Fuse systems (**45314810**)
 - Transfer switching equipment and load transfer switches (**109769745**)
 - 8US busbar systems (**109769746**)
- System Manual
 - SENTRON 3NJ62 in-line plug-in switch disconnectors with fuses (**31753460**)
 - SENTRON 3NP1 fuse switch disconnectors (**33515690**)
- Equipment Manual
 - 3KD switch disconnectors (**109758120**)

Technical overview – Switch disconnectors



The fast way to get you to our online services

This page provides you with comprehensive information and links on switch disconnectors

www.siemens.com/lowvoltage/product-support (**109764946**)

Quick selection guide

Load switching devices for all applications

Fuseless switch disconnectors³⁾



Functional switching¹⁾



Type	3LD3	3LD2	3LD5 UL	3KD	3VA
Uninterrupted current I_u	16 ... 63 A	16 ... 250 A	30 ... 160 A	16 ... 2000 A	63 ... 630 A
Short-circuit current max.	10 kA	50 kA	50 kA	100 kA	110 kA ⁵⁾
Selection acc. to utilization category	AC max.	AC-3	AC-3	AC-3	AC-23A
	DC max.	–	DC-22A	–	DC-23A (up to 250 A)

Suitable fuses	3LD3	3LD2	3LD5 UL	3KD	3VA
	–	–	–	–	–

Types of mounting	Floor mounting	■	■	■	■	■
	Mounting on a DIN rail	■	■ (up to 125 A)	■ (up to 63 A)	■ (up to 250 A)	■ (up to 160 A)
	Front mounting	■	■	■	–	–
	Mounting on busbar systems (spacing of the busbars)	–	–	–	–	■
	Draw-out technology	–	–	–	–	■

Methods of operation	Manual from the front	■	■	■	■	■
	Manual from the side	–	–	–	■	■
	Remote-controllable	–	–	–	–	■

Number of poles	1-pole	–	–	–	–	–
	2-pole	–	–	–	–	–
	3-pole	■	■	■	■	■
	4-pole	■	■	■	■	■
	6-pole	–	■	–	■	–

Switching function	All poles	■	■	■	■	■
	Individual poles switchable	–	–	–	–	–

Further information

From page 8/6

From page 2/1

¹⁾ According to DIN VDE 0100-200, functional switching is an operation intended to switch on or off or vary the supply of electric energy to an electrical installation or parts of it for normal operating purposes.

²⁾ Devices for occasional switching usually have a substantially lower electrical endurance and are switched no more than 1× per minute in the tests.

³⁾ Pure switching without protection function

Fuse switch disconnectors ⁴⁾



Occasional switching ²⁾

Switch disconnectors with fuses ⁴⁾



Functional switching ¹⁾



Occasional switching ²⁾

3NP1	3NP5	3NJ4	5SG76
160 ... 630 A	160 ... 630 A	160 ... 1600 A	16 A
120 kA	100 kA	120 kA	50 kA
AC-23B	AC-23B	AC-23B	AC-22A
DC-23B	DC-23B	-	-
IEC NH	IEC NH	IEC NH	NEOZED
■	■	-	-
■	-	-	■
-	-	-	-
40/60 mm	40/60 mm	60/100/185 mm	-
-	-	-	-
■	■	■	■
-	-	-	-
-	-	-	-
■	-	-	■
■	-	-	■
■	■	■	■
■	-	-	■
-	-	-	-
■	■	■	■
-	-	■	-

From page 8/82

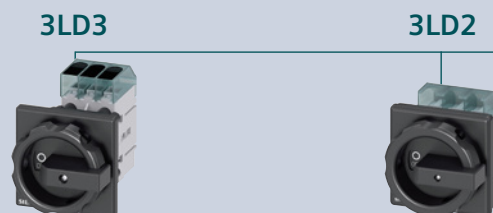
3KF NH	3KF SITOR	3NJ62	5SG71/72
32 ... 800 A	32 ... 800 A	63 ... 630 A	63 A
100 kA	100 kA	100 kA	50 kA
AC-23A	AC-23A	AC-23B	AC-23A
DC-23A	DC-23A	DC-23B	DC-22B
IEC NH	IEC LV HRC, optimized for semiconductor protection	IEC NH	NEOZED
■	■	-	-
■	■	-	-
-	-	-	-
-	-	185 mm	60 mm
-	-	■	-
■	■	■	■
■	■	-	-
-	-	■	-
-	-	-	■
■	■	■	■
■	■	■	■
-	-	-	-
■	■	■	■
-	-	-	-

From page 8/116

⁴⁾ The suitable fuses protect persons, motors, installations and generators against short circuit and overload
⁵⁾ With a line-side fuse for 415 V

Fuseless switch disconnectors

Quick selection guide



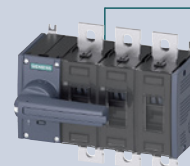
Type		3LD30	3LD31	3LD32	3LD33	3LD34	3LD20	3LD21	3LD22	
General technical specifications acc. to IEC 60947-3										
General technical specifications										
Rated uninterrupted current I_u	A	16	25	32	40	63	16	25	32	
Rated operational voltage U_e	At 50/60 Hz AC	V					690			
	At DC – 2 conducting paths in series	V					–			
	At DC – 3 conducting paths in series	V					–			
	At DC – 4 conducting paths in series	V					–			
Operating and short-circuit behavior										
Rated operational current $I_e^{1)}$	At AC-20A AC-20B at 1000 V	A	–	–	–	–	–	–	–	
	At AC-21A AC-21B at 400 V	A	16	25	32	40	63	16	25	32
	At AC-21A AC-21B at 690 V	A	16	25	32	40	63	16	25	32
	At AC-22A AC-22B at 400 V	A	16	20	22	36	43	16	25	32
	At AC-22A AC-22B at 690 V	A	9	11	13	17	22	16	25	32
	At AC-22A AC-22B at 1000 V	A	–	–	–	–	–	–	–	–
	At AC-23A AC-23B at 400 V	A	16	20	22	36	43	16	20	22
	At AC-23A AC-23B at 690 V	A	9	11	13	17	22	9	11	13
	At DC-20A DC-20B at 1000 V	A	–	–	–	–	–	–	–	–
	At DC-21A DC-21B at 110 V	A	–	–	–	–	–	–	–	–
	At DC-21A DC-21B at 220 V	A	–	–	–	–	–	–	–	–
	At DC-21A DC-21B at 440 V	A	–	–	–	–	–	–	–	–
	At DC-22A DC-22B at 220 V	A	–	–	–	–	–	–	–	–
	At DC-22A DC-22B at 440 V	A	–	–	–	–	–	–	–	–
	At DC-23A DC-23B at 220 V	A	–	–	–	–	–	–	–	–
	At DC-23A DC-23B at 440 V	A	–	–	–	–	–	–	–	–
Motor switching capacity	At AC-23A AC-23B at 400 V	kW	7.5	9.5	11.5	18.5	22	7.5	9.5	11.5
	At AC-23A AC-23B at 690 V	kW	7.5	9	11.5	15	18.5	7.5	9.5	11.5
	At AC-3 at 400 V	kW	5.5	7.5	9.5	11.5	18.5	5.5	7.5	9.5
	At AC-3 at 690 V	kW	5.5	7.5	9.5	11.5	15	5.5	7.5	9.5
Rated short-time withstand current I_{cw}	At 690 V AC (t = 1 s)	kA	0.5	0.5	0.5	1	1	0.34	0.64	0.64
	At 1000 V AC (t = 1 s)	kA	–	–	–	–	–	–	–	–
Rated conditional short-circuit current with upstream fuse	At 400/415 V AC	kA	10	10	10	10	10	50	50	50
	At 690 V AC	kA	6	6	6	6	6	50	50	50
Degree of protection										
Maximum achievable IP degree of protection (with a rotary operating mechanism)		IP65					IP65			
General technical specifications acc. to UL										
General technical specifications										
Certification according to UL standard		UL 508					UL 508			
I_n acc. to UL 508/UL 60947-4-1 UL 489	A	16 –	25 –	32 –	40 –	63 –	16 –	25 –	32 –	
U_e acc. to UL 508/UL 60947-4-1 UL 489	V AC	600 –					600 –			
Operating and short-circuit behavior										
Operational power, 3-phase	At 480 V	hp	7.5	10	20	20	25	7.5	10	20
	At 600 V	hp	10	15	20	20	30	10	15	20
Short circuit current rating (SCCR)	At 480 V at 600 V	kA	5 5				5 5	5 5	5 5	
Upstream fuse according to UL			RK5				RK5			
Further information										
		See page 8/12					See page 8/24			

Fuseless switch disconnectors

Quick selection guide for AC and AC/DC applications



3KD



Type	3KD 01..-K	3KD 02..-K	3KD 03..-K	3KD 03..-L	3KD 04..-L	3KD 05..-L	3KD 06..-L	3KD 16	3KD 22	3KD 26	3KD 28..-M
------	---------------	---------------	---------------	---------------	---------------	---------------	---------------	-----------	-----------	-----------	---------------

General technical specifications acc. to IEC 60947-3

General technical specifications

Rated uninterrupted current I_u	A	16	32	63	63	80	100	125	16	32	63	80
Rated operational voltage U_e	At 50/60 Hz AC	V	690	690	415	690	690	690	1000	1000	1000	1000
	At DC – 2 conducting paths in series	V	–	–	–	–	–	–	220	220	220	220
	At DC – 3 conducting paths in series	V	–	–	–	–	–	–	440	440	440	440
	At DC – 4 conducting paths in series	V	–	–	–	–	–	–	–	–	–	–

Operating and short-circuit behavior

Rated operational current $I_e^{1)}$	At AC-20A AC-20B at 1000 V	A	–	–	–	–	–	–	16	32	63	80	
	At AC-21A AC-21B at 400 V	A	16	32	63	63	80	100	125	16	32	63	80
	At AC-21A AC-21B at 690 V	A	16	32	–	63	80	100	125	16	32	63	80
	At AC-22A AC-22B at 400 V	A	16	32	63	63	80	100	125	16	32	63	80
	At AC-22A AC-22B at 690 V	A	16	32	–	63	80	100	125	16	32	63	80
	At AC-22A AC-22B at 1000 V	A	–	–	–	–	–	–	–	16	32	63	80
	At AC-23A AC-23B at 400 V	A	16	32	63	63	75	80	90	16	32	63	80
	At AC-23A AC-23B at 690 V	A	14	17	–	22	30	35	39	16	32	63	80
	At DC-20A DC-20B at 1000 V	A	–	–	–	–	–	–	–	16	32	63	80
	At DC-21A DC-21B at 110 V	A	–	–	–	–	–	–	–	16	32	63	80
	At DC-21A DC-21B at 220 V	A	–	–	–	–	–	–	–	16	32	63	80
	At DC-21A DC-21B at 440 V	A	–	–	–	–	–	–	–	16	32	63	80
	At DC-22A DC-22B at 220 V	A	–	–	–	–	–	–	–	16	32	63	80
	At DC-22A DC-22B at 440 V	A	–	–	–	–	–	–	–	16	32	63	80
	At DC-23A DC-23B at 220 V	A	–	–	–	–	–	–	–	16	32	63	80
	At DC-23A DC-23B at 440 V	A	–	–	–	–	–	–	–	16	32	63	80
Motor switching capacity	At AC-23A AC-23B at 400 V	kW	7.5	15	30	30	37	45	45	7.5	15	30	45
	At AC-23A AC-23B at 690 V	kW	11	15	–	18.5	22	30	30	11	30	55	75
	At AC-3 at 400 V	kW	–	–	–	–	–	–	–	–	–	–	–
Rated short-time withstand current I_{cw}	At 690 V AC (t = 1 s)	kA	1.26	1.26	1.26 ¹⁾	2.5	2.5	2.5	2.5	3	3	3	3
	At 1000 V AC (t = 1 s)	kA	–	–	–	–	–	–	–	3	3	3	3
Rated conditional short-circuit current with upstream fuse	At 400/415 V AC	kA	50	50	50	50	50	50	50	100	100	100	100
	At 690 V AC	kA	50	50	–	50	50	50	20	100	100	100	100

Degree of protection

Maximum achievable IP degree of protection (with a rotary operating mechanism)

IP65

General technical specifications acc. to UL

General technical specifications

Certification according to UL standard

I_n acc. to UL 508/UL 60947-4-1 | UL 489

U_e acc. to UL 508/UL 60947-4-1 | UL 489

Operating and short-circuit behavior

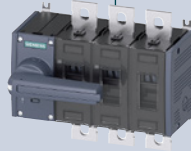
Operational power, 3-phase	At 480 V	hp	–
	At 600 V	hp	–
Short circuit current rating (SCCR)	At 480 V at 600 V	kA	–
Fuse type			–

Further information

See page 8/66

¹⁾ Applies to 415 V AC

3KD



3KD 28..-N	3KD 30..-M.	3KD 30..-N.	3KD 32	3KD 34	3KD 36..-N	3KD 36..-P	3KD 38..-N.	3KD 38..-P.	3KD 40	3KD 42	3KD 44..-P.	3KD 44..-Q.	3KD 46	3KD 48	3KD 50..-Q.	3KD 50..-R.	3KD 52	3KD 54	3KD 56
80	100	100	125	160	200	200	250	250	315	400	500	500	630	800	1000	1000	1250	1600	2000
1000	1000	1000	1000	1000	1000	1000	1000	1000	1000	1000	1000	1000	1000	1000	1000	1000	1000	1000	1000
220	220	220	220	220	220	220	220	220	220	220	220	220	220	220	220	220	220	220	220
440	440	440	440	440	440	440	440	440	440	440	440	440	440	440	440	440	440	440	440
-	-	-	-	-	-	-	-	-	-	-	-	-	-	-	-	-	-	-	-
80	100	100	125	160	200	200	250	250	315	400	500	500	630	800	1000	1000	1250	1600	2000
80	100	100	125	160	200	200	250	250	315	400	500	500	630	800	1000	1000	1250	1600	2000
80	100	100	125	160	200	200	250	250	315	400	400	500	630	800	1000	1000	1250	1600	2000
80	100	100	125	160	200	200	250	250	315	400	500	500	630	800	1000	1000	1250	1600	2000
80	80	100	125	160	160	200	200	250	315	400	400	500	630	800	800	1000	1250	1600	1600
80	80	100	125	160	160	200	160	250	315	400	400	500	630	800	1000	1000	1250	1600	2000
80	80	100	125	160	160	200	160	250	315	400	400	500	630	800	1000	1000	1250	1600	2000
80	100	100	125	160	200	200	250	250	315	400	500	500	630	800	1000	1000	1250	1600	2000
80	80	100	125	160	160	200	160	250	315	400	400	500	630	800	800	1000	1250	1600	1600
80	80	100	125	160	160	200	160	250	315	400	400	500	630	800	800	1000	1250	1600	1600
80	80	100	125	160	160	200	160	250	315	400	400	500	630	800	800	1000	1250	1600	1600
80	80	100	125	160	160	200	160	250	315	400	400	500	630	800	800	-	-	-	-
80	80	100	125	160	160	200	160	250	315	400	400	500	630	800	800	-	-	-	-
80	80	100	125	160	160	200	160	250	315	400	400	500	630	800	800	-	-	-	-
45	45	55	55	90	90	110	90	132	160	200	200	250	355	400	560	560	710	900	1000
75	75	90	110	110	110	185	110	250	315	315	315	500	630	800	1000	1000	1000	1000	1000
-	-	-	-	-	-	-	-	-	-	-	-	-	-	-	-	-	-	-	-
-	-	-	-	-	-	-	-	-	-	-	-	-	-	-	-	-	-	-	-
4	3	4	4	4	4	13	4	13	13	13	13	30	30	30	30	55	55	55	55
4	3	4	4	4	4	13	4	13	13	13	13	30	30	30	30	55	55	55	55
100	100	100	100	100	100	100	100	100	100	100	100	100	100	100	100	100	80	80	80
80	100	80	80	80	80	80	80	80	80	80	80	80	80	80	80	80	100	100	65

IP65

-

-

-

-

-

-

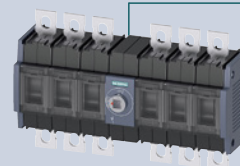
See page 8/66

Fuseless switch disconnectors

Quick selection guide for DC applications



3KD



Type		3KD 16	3KD 22	3KD 26	3KD 28	3KD 30	3KD 32	3KD 34	3KD 36	3KD 38
General technical specifications acc. to IEC 60947-3										
General technical specifications										
Rated uninterrupted current I_u	A	16	32	63	80	100	125	160	200	250
Rated operational voltage U_e	At DC - at degree of pollution 2	V	1200	1200	1200	1200	1200	1200	1200	1200
	At DC - at degree of pollution 3	V	1000	1000	1000	1000 ¹⁾	1000 ¹⁾	1000 ¹⁾	1000 ¹⁾	1200
Operating and short-circuit behavior										
Rated operational current I_e	At DC-21A at 1200 V	A	16	32	63	80	100	125	160	–
	At DC-21B at 1200 V	A	16	32	63	80	100	125	160	200
Rated short-time withstand current I_{cw}	At DC 1200 V (t = 1 s)	kA	3	3	3	4	4	4	4	10
Degree of protection										
Maximum achievable IP degree of protection (with a rotary operating mechanism)										IP20
General technical specifications acc. to UL										
General technical specifications										
Certification according to UL standard										–
I_n acc. to UL 508/UL 60947-4-1 UL 489	A									–
U_e acc. to UL 508/UL 60947-4-1 UL 489	AC V									–
Operating and short-circuit behavior										
Operational power, 3-phase	At 480 V	hp								–
	At 600 V	hp								–
Short circuit current rating (SCCR)	At 480 V at 600 V	kA								–
Fuse type										–
Further information										

See page 8/66

¹⁾ Valid for version with box terminal, version with flat terminal max. 1200 V

3LD switch disconnectors

System overview of 3LD3 main control and EMERGENCY-STOP switches

Basic units for front mounting



3P rotary operating mechanisms



3P knob-operated mechanisms



3P+N rotary operating mechanisms



3P+N knob-operated mechanisms

Basic units for floor mounting



3P rotary operating mechanisms



3P knob-operated mechanisms



3P+N rotary operating mechanisms



3P+N knob-operated mechanisms

Basic units for installation in distribution boards and basic switches without knob-operated mechanism

3P knob-operated mechanisms
(installation in distribution boards)3P basic switches without
knob-operated mechanism3P+N knob-operated mechanisms
(installation in distribution boards)3P+N basic switches without
knob-operated mechanism

Additional poles and auxiliary switches



N switching contacts



N/PE terminals



Auxiliary switches

Operating mechanisms

Rotary operating mechanisms for
front or floor mounting (center hole)Knob-operated mechanisms for
front or floor mountingDoor-coupling rotary
operating mechanismsDoor-coupling knob-
operated mechanismsDoor-coupling knob-
operated mechanisms,
defeatable

Further accessories



Terminal covers, 1 and 3-pole



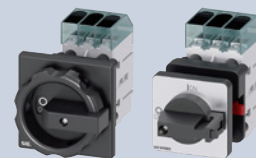
Inscription labels

Note:

You will find a detailed range of accessories with the basic units.

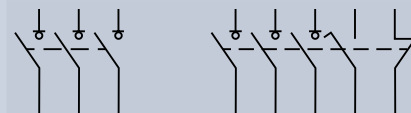
3LD switch disconnectors

3LD3 main control and EMERGENCY-STOP switches,
front mounting, 10 kA_{rms}



Operating mechanisms, black

Number of poles 3P



Uninterrupted current I_u At AC-21A, 380 ... 440 V	Operational power P At AC-23A, 380 ... 440 V	Operational power P At AC-3, 380 ... 440 V	Without auxiliary switch	1 NO + 1 NC
Rotary operating mechanisms				
16 A	7.5 kW	5.5 kW	3LD3054-0TK51	3LD3054-1TK51
25 A	9 kW	7.5 kW	3LD3154-0TK51	3LD3154-1TK51
32 A	11.5 kW	9.5 kW	3LD3254-0TK51	3LD3254-1TK51
40 A	18.5 kW	11.5 kW	3LD3354-0TK51	3LD3354-1TK51
63 A	22 kW	18.5 kW	3LD3454-0TK51	3LD3454-1TK51
Knob-operated mechanisms				
16 A	7.5 kW	5.5 kW	3LD3050-0TK11	3LD3050-1TK11
25 A	9 kW	7.5 kW	3LD3150-0TK11	3LD3150-1TK11
32 A	11.5 kW	9.5 kW	3LD3250-0TK11	3LD3250-1TK11
40 A	18.5 kW	11.5 kW	3LD3350-0TK11	3LD3350-1TK11
63 A	22 kW	18.5 kW	3LD3450-0TK11	3LD3450-1TK11


Scope of supply:

- Including terminal covers for the infeed side


Accessories

3LD30 (16 A) 3LD31 (25 A) 3LD32 (32 A) 3LD33 (40 A) 3LD34 (63 A)


Additional poles

Type	Contacts	Article No.	3LD30 (16 A)	3LD31 (25 A)	3LD32 (32 A)	3LD33 (40 A)	3LD34 (63 A)
	N switching contact (4th contact element)	Leading switch-on, lagging switch-off	3LD9340-0B	■	■	■	■
	N terminal	Through-type	3LD9340-2B	■	■	■	■
	PE terminal	Through-type	3LD9340-3B	■	■	■	■


Auxiliary switches

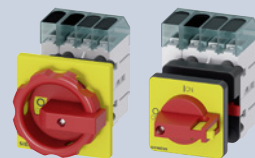
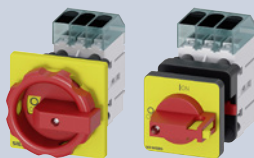
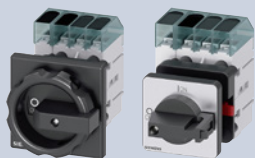
Contacts	Article No.	3LD30 (16 A)	3LD31 (25 A)	3LD32 (32 A)	3LD33 (40 A)	3LD34 (63 A)
 1 NO + 1 NC	3LD9340-6B	■	■	■	■	■

Rotary operating mechanisms

Version	Color	Article No.	3LD30 (16 A)	3LD31 (25 A)	3LD32 (32 A)	3LD33 (40 A)	3LD34 (63 A)
 Lockable in 0 position with max. 3 padlocks	Black	3LD9344-4C	■	■	■	■	■
	Red/yellow	3LD9344-5C	■	■	■	■	■

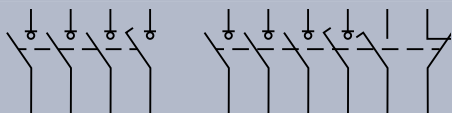
Knob-operated mechanisms

Version	Color	Article No.	3LD30 (16 A)	3LD31 (25 A)	3LD32 (32 A)	3LD33 (40 A)	3LD34 (63 A)
 Lockable in 0 position with max. 2 padlocks	Black	3LD9343-6C	■	■	■	■	■
	Red/yellow	3LD9343-7C	■	■	■	■	■



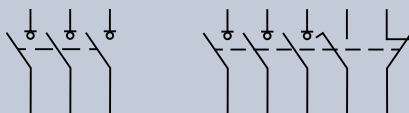
Operating mechanisms, red/yellow

3P+N

Without
auxiliary switch

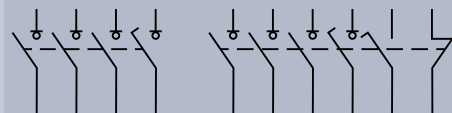
1 NO + 1 NC

3P

Without
auxiliary switch

1 NO + 1 NC

3P+N

Without
auxiliary switch

1 NO + 1 NC

3LD3054-OTL51	3LD3054-1TL51	3LD3054-OTK53	3LD3054-1TK53	3LD3054-OTL53	3LD3054-1TL53
3LD3154-OTL51	3LD3154-1TL51	3LD3154-OTK53	3LD3154-1TK53	3LD3154-OTL53	3LD3154-1TL53
3LD3254-OTL51	3LD3254-1TL51	3LD3254-OTK53	3LD3254-1TK53	3LD3254-OTL53	3LD3254-1TL53
3LD3354-OTL51	3LD3354-1TL51	3LD3354-OTK53	3LD3354-1TK53	3LD3354-OTL53	3LD3354-1TL53
3LD3454-OTL51	3LD3454-1TL51	3LD3454-OTK53	3LD3454-1TK53	3LD3454-OTL53	3LD3454-1TL53
3LD3050-OTL11	3LD3050-1TL11	3LD3050-OTK13	3LD3050-1TK13	3LD3050-OTL13	3LD3050-1TL13
3LD3150-OTL11	3LD3150-1TL11	3LD3150-OTK13	3LD3150-1TK13	3LD3150-OTL13	3LD3150-1TL13
3LD3250-OTL11	3LD3250-1TL11	3LD3250-OTK13	3LD3250-1TK13	3LD3250-OTL13	3LD3250-1TL13
3LD3350-OTL11	3LD3350-1TL11	3LD3350-OTK13	3LD3350-1TK13	3LD3350-OTL13	3LD3350-1TL13
3LD3450-OTL11	3LD3450-1TL11	3LD3450-OTK13	3LD3450-1TK13	3LD3450-OTL13	3LD3450-1TL13

8

3LD30 (16 A)	3LD31 (25 A)	3LD32 (32 A)	3LD33 (40 A)	3LD34 (63 A)
-----------------	-----------------	-----------------	-----------------	-----------------

Terminal covers

- Pack of 4 units

Version

Article No.

For N switching contacts, N terminals or PE terminals

3LD9341-2A

■	■	■	■	■
---	---	---	---	---



For 3-pole 3LD3 switch disconnectors

3LD9341-0A

■	■	■	■	■
---	---	---	---	---



Inscription labels

- Pack of 10 units

Inscription

Article No.

German/English (Hauptschalter/Main Switch)

3LD9346-1A

■	■	■	■	■
---	---	---	---	---

French/Spanish (Interrupteur Principal/Interruptor Principal)

3LD9346-2A

■	■	■	■	■
---	---	---	---	---

Without inscription

3LD9346-3A

■	■	■	■	■
---	---	---	---	---



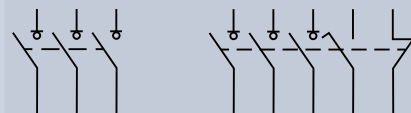
3LD switch disconnectors

3LD3 main control and EMERGENCY-STOP switches, floor mounting, 10 kA_{rms}



Operating mechanisms, black

Number of poles 3P



Uninterrupted current I_u At AC-21A, 380 ... 440 V	Operational power P At AC-23A, 380 ... 440 V	Operational power P At AC-3, 380 ... 440 V	Without auxiliary switch	1 NO + 1 NC
Door-coupling rotary operating mechanisms, center-hole mounting \varnothing 22.5 mm				
16 A	7.5 kW	5.5 kW	3LD3048-OTK51	3LD3048-1TK51
25 A	9 kW	7.5 kW	3LD3148-OTK51	3LD3148-1TK51
32 A	11.5 kW	9.5 kW	3LD3248-OTK51	3LD3248-1TK51
40 A	18.5 kW	11.5 kW	3LD3348-OTK51	3LD3348-1TK51
63 A	22 kW	18.5 kW	3LD3448-OTK51	3LD3448-1TK51
Door-coupling knob-operated mechanisms, center-hole mounting \varnothing 22.5 mm				
16 A	7.5 kW	5.5 kW	3LD3040-OTK11	3LD3040-1TK11
25 A	9 kW	7.5 kW	3LD3140-OTK11	3LD3140-1TK11
32 A	11.5 kW	9.5 kW	3LD3240-OTK11	3LD3240-1TK11
40 A	18.5 kW	11.5 kW	3LD3340-OTK11	3LD3340-1TK11
63 A	22 kW	18.5 kW	3LD3440-OTK11	3LD3440-1TK11

Scope of supply:

- Including terminal covers for the infeed side


Mounting:

- Using screws- or snap-on mounting on 35 mm mounting rails


Accessories

3LD30 (16 A)	3LD31 (25 A)	3LD32 (32 A)	3LD33 (40 A)	3LD34 (63 A)
-----------------	-----------------	-----------------	-----------------	-----------------


Additional poles

Type	Contacts	Article No.	3LD30 (16 A)	3LD31 (25 A)	3LD32 (32 A)	3LD33 (40 A)	3LD34 (63 A)
 N switching contact (4th contact element)	Leading switch-on, lagging switch-off	3LD9340-0C	■	■	■	■	■
N terminal	Through-type	3LD9340-2C	■	■	■	■	■
PE terminal	Through-type	3LD9340-3C	■	■	■	■	■


Auxiliary switches

Contacts	Article No.	3LD30 (16 A)	3LD31 (25 A)	3LD32 (32 A)	3LD33 (40 A)	3LD34 (63 A)
 1 NO + 1 NC	3LD9340-6C	■	■	■	■	■


Rotary operating mechanisms

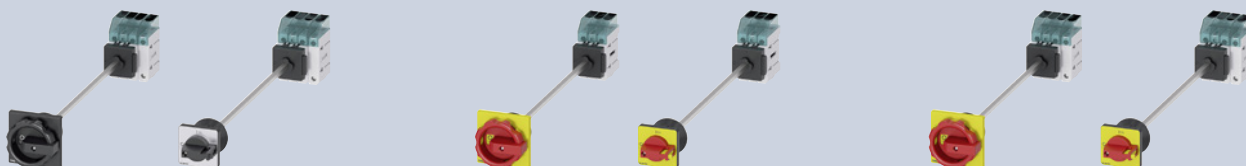
Version	Color	Article No.	3LD30 (16 A)	3LD31 (25 A)	3LD32 (32 A)	3LD33 (40 A)	3LD34 (63 A)
 • Lockable in 0 position with max. 3 padlocks • Incl. funnel	Black	3LD9344-2C	■	■	■	■	■
	Red/yellow	3LD9344-3C	■	■	■	■	■

Knob-operated mechanisms

Version	Color	Article No.	3LD30 (16 A)	3LD31 (25 A)	3LD32 (32 A)	3LD33 (40 A)	3LD34 (63 A)
 • Lockable in 0 position with max. 2 padlocks • Incl. funnel	Black	3LD9343-4C	■	■	■	■	■
	Red/yellow	3LD9343-5C	■	■	■	■	■

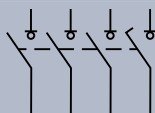
Switch shafts

Cross-section	Length	Article No.	3LD30 (16 A)	3LD31 (25 A)	3LD32 (32 A)	3LD33 (40 A)	3LD34 (63 A)
 6 × 6 mm	600 mm	3LD9345-1C	■	■	■	■	■

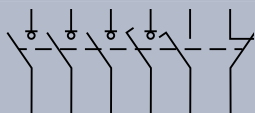


Operating mechanisms, red/yellow

3P+N

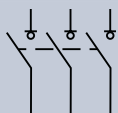


Without auxiliary switch

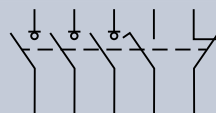


1 NO + 1 NC

3P

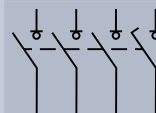


Without auxiliary switch

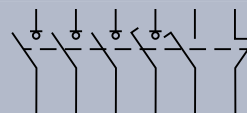


1 NO + 1 NC

3P+N



Without auxiliary switch



1 NO + 1 NC

3LD3048-OTL51	3LD3048-1TL51	3LD3048-OTK53	3LD3048-1TK53	3LD3048-OTL53	3LD3048-1TL53
3LD3148-OTL51	3LD3148-1TL51	3LD3148-OTK53	3LD3148-1TK53	3LD3148-OTL53	3LD3148-1TL53
3LD3248-OTL51	3LD3248-1TL51	3LD3248-OTK53	3LD3248-1TK53	3LD3248-OTL53	3LD3248-1TL53
3LD3348-OTL51	3LD3348-1TL51	3LD3348-OTK53	3LD3348-1TK53	3LD3348-OTL53	3LD3348-1TL53
3LD3448-OTL51	3LD3448-1TL51	3LD3448-OTK53	3LD3448-1TK53	3LD3448-OTL53	3LD3448-1TL53
3LD3040-OTL11	3LD3040-1TL11	3LD3040-OTK13	3LD3040-1TK13	3LD3040-OTL13	3LD3040-1TL13
3LD3140-OTL11	3LD3140-1TL11	3LD3140-OTK13	3LD3140-1TK13	3LD3140-OTL13	3LD3140-1TL13
3LD3240-OTL11	3LD3240-1TL11	3LD3240-OTK13	3LD3240-1TK13	3LD3240-OTL13	3LD3240-1TL13
3LD3340-OTL11	3LD3340-1TL11	3LD3340-OTK13	3LD3340-1TK13	3LD3340-OTL13	3LD3340-1TL13
3LD3440-OTL11	3LD3440-1TL11	3LD3440-OTK13	3LD3440-1TK13	3LD3440-OTL13	3LD3440-1TL13

8

	3LD30 (16 A)	3LD31 (25 A)	3LD32 (32 A)	3LD33 (40 A)	3LD34 (63 A)
--	-----------------	-----------------	-----------------	-----------------	-----------------

Door-coupling rotary operating mechanisms



Type	Color	Article No.	3LD30 (16 A)	3LD31 (25 A)	3LD32 (32 A)	3LD33 (40 A)	3LD34 (63 A)
Rotary operating mechanisms 66 × 66 mm	Black	3LD9344-2CA	■	■	■	■	■
	Red/yellow	3LD9344-3CA	■	■	■	■	■
Knob-operated mechanisms 48 × 48 mm	Black	3LD9343-4CA	■	■	■	■	■
	Red/yellow	3LD9343-5CA	■	■	■	■	■

Terminal covers



Version	Article No.	3LD30 (16 A)	3LD31 (25 A)	3LD32 (32 A)	3LD33 (40 A)	3LD34 (63 A)
• Pack of 4 units For N switching contacts, N terminals or PE terminals	3LD9341-2A	■	■	■	■	■
For 3LD3 3-pole switch disconnectors	3LD9341-0A	■	■	■	■	■

Inscription labels



Inscription	Article No.	3LD30 (16 A)	3LD31 (25 A)	3LD32 (32 A)	3LD33 (40 A)	3LD34 (63 A)
• Pack of 10 units German/English (Hauptschalter/Main Switch)	3LD9346-1A	■	■	■	■	■
French/Spanish (Interrupteur Principal/Interruptor Principal)	3LD9346-2A	■	■	■	■	■
Without inscription	3LD9346-3A	■	■	■	■	■

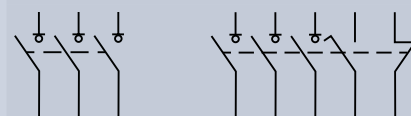
3LD switch disconnectors

3LD3 main control and EMERGENCY-STOP switches, installation in distribution boards and basic switches without knob-operated mechanism, 10 kA_{rms}



Operating mechanisms, black

Number of poles 3P



Uninterrupted current I_n At AC-21A, 380 ... 440 V	Operational power P At AC-23A, 380 ... 440 V	Operational power P At AC-3, 380 ... 440 V	Without auxiliary switch	1 NO + 1 NC
Switches for installation in distribution boards with masking plate and selector knob, DIN-rail mounting				
16 A	7.5 kW	5.5 kW	3LD3030-0TK11	3LD3030-1TK11
25 A	9 kW	7.5 kW	3LD3130-0TK11	3LD3130-1TK11
32 A	11.5 kW	9.5 kW	3LD3230-0TK11	3LD3230-1TK11
40 A	18.5 kW	11.5 kW	3LD3330-0TK11	3LD3330-1TK11
63 A	22 kW	18.5 kW	3LD3430-0TK11	3LD3430-1TK11
Basic switches without knob-operated mechanism				
16 A	7.5 kW	5.5 kW	3LD3010-0TK05	3LD3010-1TK05
25 A	9 kW	7.5 kW	3LD3110-0TK05	3LD3110-1TK05
32 A	11.5 kW	9.5 kW	3LD3210-0TK05	3LD3210-1TK05
40 A	18.5 kW	11.5 kW	3LD3310-0TK05	3LD3310-1TK05
63 A	22 kW	18.5 kW	3LD3410-0TK05	3LD3410-1TK05

Scope of supply:

- Basic switches without direct operating mechanism, incl. terminal covers for the infeed side

Mounting:

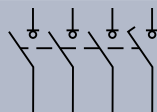
- Using screws or snap-on mounting on 35 mm mounting rails

Accessories see page 8/20

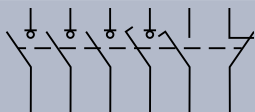


Operating mechanisms, red/yellow

3P+N

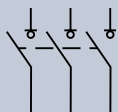


Without auxiliary switch

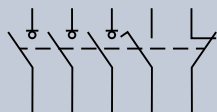


1 NO + 1 NC

3P

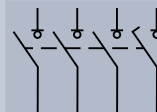


Without auxiliary switch

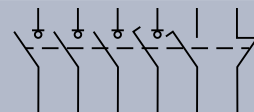


1 NO + 1 NC

3P+N



Without auxiliary switch



1 NO + 1 NC

3LD3030-OTL11

3LD3030-1TL11

3LD3030-OTK13

3LD3030-1TK13

3LD3030-OTL13

3LD3030-1TL13

3LD3130-OTL11

3LD3130-1TL11

3LD3130-OTK13

3LD3130-1TK13

3LD3130-OTL13

3LD3130-1TL13

3LD3230-OTL11

3LD3230-1TL11

3LD3230-OTK13

3LD3230-1TK13

3LD3230-OTL13

3LD3230-1TL13

3LD3330-OTL11

3LD3330-1TL11

3LD3330-OTK13

3LD3330-1TK13

3LD3330-OTL13

3LD3330-1TL13

3LD3430-OTL11

3LD3430-1TL11

3LD3430-OTK13

3LD3430-1TK13

3LD3430-OTL13

3LD3430-1TL13

3LD3010-OTL05

3LD3010-1TL05

-

-

-

-

3LD3110-OTL05

3LD3110-1TL05

-

-

-

-

3LD3210-OTL05

3LD3210-1TL05

-

-

-

-

3LD3310-OTL05

3LD3310-1TL05

-

-

-

-

3LD3410-OTL05

3LD3410-1TL05

-

-




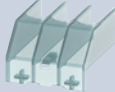
-






-

3LD switch disconnectors

3LD3 main control and EMERGENCY-STOP switches, installation in distribution boards and basic switches without knob-operated mechanism, 10 kA_{rms}








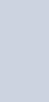
Accessories for switches for installation in distribution boards and basic switches without knob-operated mechanism

				3LD30 (16 A)	3LD31 (25 A)	3LD32 (32 A)	3LD33 (40 A)	3LD34 (63 A)
Additional poles								
	Type	Contacts	Article No.					
	N switching contact (4th contact element)	Leading switch-on, lagging switch-off	3LD9340-0C	■	■	■	■	■
	N terminal	Through-type	3LD9340-2C	■	■	■	■	■
	PE terminal	Through-type	3LD9340-3C	■	■	■	■	■
Auxiliary switches								
		Contacts	Article No.					
		1 NO + 1 NC	3LD9340-6C	■	■	■	■	■
Terminal covers								
	• Pack of 4 units							
	Version		Article No.					
	For N switching contacts, N terminals or PE terminals		3LD9341-2A	■	■	■	■	■
								
	For 3LD3 3-pole switch disconnectors		3LD9341-0A	■	■	■	■	■

Accessories for basic switches without knob-operated mechanism					3LD30 (16 A)	3LD31 (25 A)	3LD32 (32 A)	3LD33 (40 A)	3LD34 (63 A)
Door-coupling rotary operating mechanisms									
	Type	Color	Article No.						
	Rotary operating mechanisms 66 × 66 mm	Black	3LD9344-2CA	■	■	■	■	■	
		Red/yellow	3LD9344-3CA	■	■	■	■	■	
	Knob-operated mechanisms 48 × 48 mm	Black	3LD9343-4CA	■	■	■	■	■	
		Red/yellow	3LD9343-5CA	■	■	■	■	■	
	Knob-operated mechanisms, defeatable, 66 × 66 mm	Black	3LD9343-2CA	■	■	■	■	■	
Red/yellow		3LD9343-3CA	■	■	■	■	■		
Rotary operating mechanisms									
	Version	Color	Article No.						
	<ul style="list-style-type: none"> Lockable in 0 position with max. 3 padlocks Incl. funnel 	Black	3LD9344-2C	■	■	■	■	■	
		Red/yellow	3LD9344-3C	■	■	■	■	■	
Knob-operated mechanisms									
	Version	Color	Article No.						
	Knob-operated mechanisms	<ul style="list-style-type: none"> Lockable in 0 position with max. 2 padlocks Incl. funnel 	Black	3LD9343-4C	■	■	■	■	■
			Red/yellow	3LD9343-5C	■	■	■	■	■
	Knob-operated mechanisms, defeatable	<ul style="list-style-type: none"> Lockable in 0 position with max. 3 padlocks Incl. funnel 	Black	3LD9343-2C	■	■	■	■	■
Red/yellow			3LD9343-3C	■	■	■	■	■	
Switch shafts									
	Cross-section	Length	Article No.						
	6 × 6 mm	600 mm	3LD9345-1C	■	■	■	■	■	
Inscription labels									
	• Pack of 10 units								
	Inscription	Article No.							
	German/English (Hauptschalter/Main Switch)	3LD9346-1A			■	■	■	■	■
	French/Spanish (Interrupteur Principal/Interruptor Principal)	3LD9346-2A			■	■	■	■	■
Without inscription	3LD9346-3A			■	■	■	■	■	

3LD switch disconnectors

3LD3 main control and EMERGENCY-STOP switches, accessories

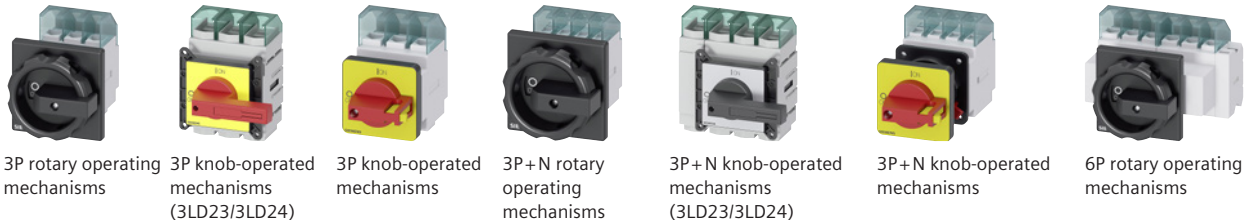
					3LD30 (16 A)	3LD31 (25 A)	3LD32 (32 A)	3LD33 (40 A)	3LD34 (63 A)
N switching contacts (4th contact element)									
	Version	Contacts	Article No.						
	For front mounting	Leading switch-on, lagging switch-off	3LD9340-0B		■	■	■	■	■
	Version	Contacts	Article No.						
	For floor mounting, installation in distribution boards and basic switches without knob-operated mechanism	Leading switch-on, lagging switch-off	3LD9340-0C		■	■	■	■	■
N terminals									
	Version	Contacts	Article No.						
	For front mounting	Through-type	3LD9340-2B		■	■	■	■	■
	Version	Contacts	Article No.						
	For floor mounting, installation in distribution boards and basic switches without knob-operated mechanism	Through-type	3LD9340-2C		■	■	■	■	■
PE terminals									
	Version	Contacts	Article No.						
	For front mounting	Through-type	3LD9340-3B		■	■	■	■	■
	Version	Contacts	Article No.						
	For floor mounting, installation in distribution boards and basic switches without knob-operated mechanism	Through-type	3LD9340-3C		■	■	■	■	■
Auxiliary switches									
	Version	Contacts	Article No.						
	For front mounting	1 NO + 1 NC	3LD9340-6B		■	■	■	■	■
	Version	Contacts	Article No.						
	For floor mounting, installation in distribution boards and basic switches without knob-operated mechanism	1 NO + 1 NC	3LD9340-6C		■	■	■	■	■

						3LD30 (16 A)	3LD31 (25 A)	3LD32 (32 A)	3LD33 (40 A)	3LD34 (63 A)
Door-coupling rotary operating mechanisms										
	Version	Type	Color	Article No.						
	For floor mounting and basic switches without knob-operated mechanism	Rotary operating mechanisms 66 × 66 mm	Black	3LD9344-2CA	■	■	■	■	■	
			Red/yellow	3LD9344-3CA	■	■	■	■	■	
		Knob-operated mechanisms 48 × 48 mm	Black	3LD9343-4CA	■	■	■	■	■	
			Red/yellow	3LD9343-5CA	■	■	■	■	■	
	Knob-operated mechanisms, defeatable	Knob-operated mechanisms, defeatable, 66 × 66 mm	Black	3LD9343-2CA	■	■	■	■	■	
Red/yellow			3LD9343-3CA	■	■	■	■	■		
Rotary operating mechanisms										
<ul style="list-style-type: none"> Lockable in 0 position with max. 3 padlocks 										
	Version	Color	Article No.							
	For front mounting, without funnel	Black	3LD9344-4C	■	■	■	■	■		
		Red/yellow	3LD9344-5C	■	■	■	■	■		
	For floor mounting and basic switches without knob-operated mechanism, with funnel	Black	3LD9344-2C	■	■	■	■	■		
		Red/yellow	3LD9344-3C	■	■	■	■	■		
Knob-operated mechanisms										
	Version	Color	Article No.							
	For front mounting	<ul style="list-style-type: none"> Lockable in 0 position with max. 2 padlocks Without funnel 	Black	3LD9343-6C	■	■	■	■		
		Red/yellow	3LD9343-7C	■	■	■	■	■		
	For floor mounting and basic switches without knob-operated mechanism	Black	3LD9343-4C	■	■	■	■	■		
		Red/yellow	3LD9343-5C	■	■	■	■	■		
	Knob-operated mechanisms, defeatable	Black	3LD9343-2C	■	■	■	■	■		
		Red/yellow	3LD9343-3C	■	■	■	■	■		
Terminal covers										
<ul style="list-style-type: none"> For front mounting, floor mounting, installation in distribution boards and basic switches without knob-operated mechanism Pack of 4 units 										
	Number of poles	Article No.								
	1-pole	3LD9341-2A	■	■	■	■	■			
	3-pole	3LD9341-0A	■	■	■	■	■			
Switch shafts										
	Cross-section	Length	Article No.							
	6 × 6 mm	600 mm	3LD9345-1C	■	■	■	■	■		
Inscription labels										
<ul style="list-style-type: none"> Pack of 10 units Not for installation in distribution boards 										
	Inscription	Article No.								
	German/English (Hauptschalter/Main Switch)	3LD9346-1A	■	■	■	■	■			
	French/Spanish (Interrupteur Principal/Interruptor Principal)	3LD9346-2A	■	■	■	■	■			
	Without inscription	3LD9346-3A	■	■	■	■	■			

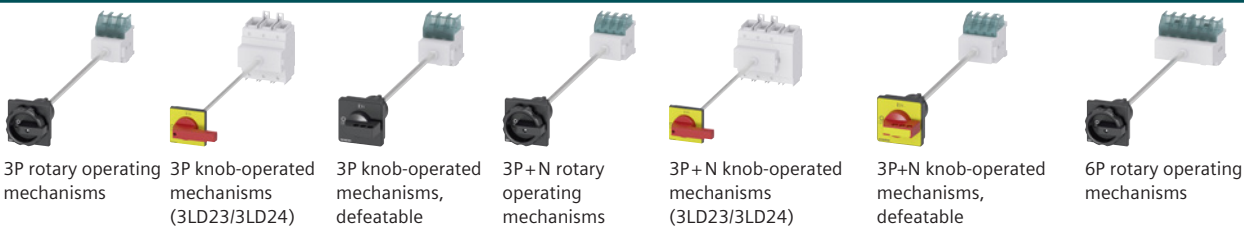
3LD switch disconnectors

System overview of 3LD2 switch disconnectors

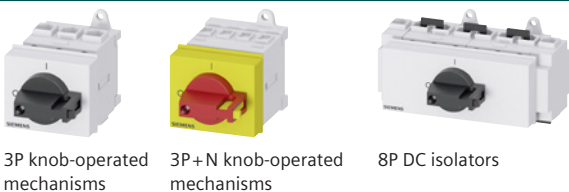
Basic units for front mounting



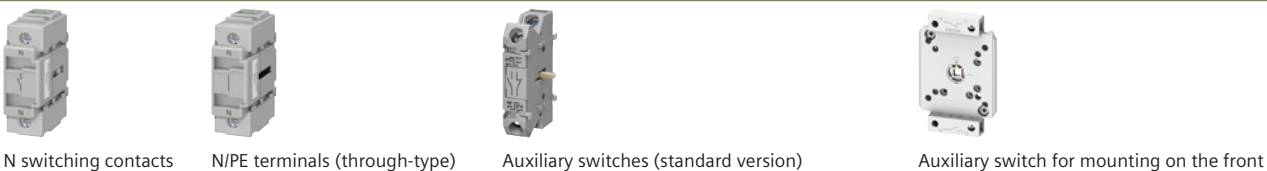
Basic units for floor mounting



Basic units for installation in distribution boards/enclosures, DC



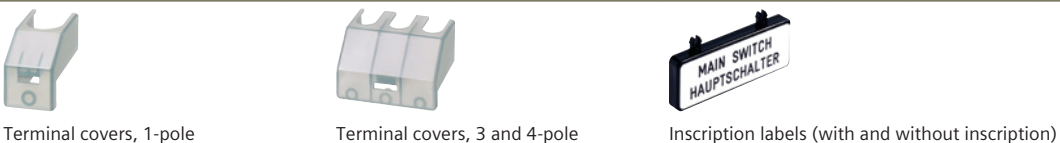
Additional poles and auxiliary switches



Operating mechanisms



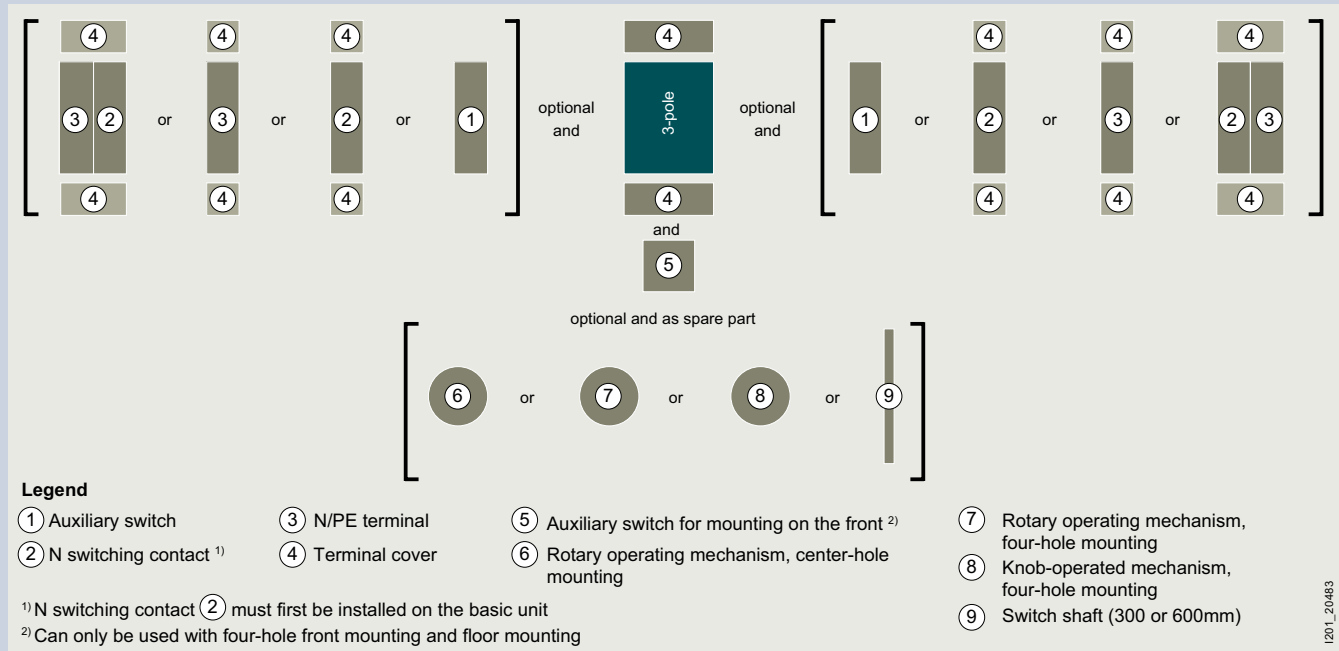
Further accessories



Note:

You will find a detailed range of accessories with the basic units.

Mounting concept and accessories



Mounting types

Front mounting



The switches for front mounting are mounted on the inside of covers, side panels or, if applicable, control cabinet doors (depending on the applicable standard and switching function). In addition to the 4-hole fastening of the handle, up to 63 A (3LD25) fastening with the 22.5 mm diameter center hole can also be chosen.

You will find further information under:
sie.ag/2UlrAvy



Floor mounting



The switches for floor mounting up to 125 A (3LD28) are snapped onto 35 mm DIN rails according to EN 60715 or screw-mounted on mounting panels. The switches for 160 and 250 A (3LD23/3LD24) are exclusively screwed onto mounting panels. The actuators are connected to the lower section of the switch through a door coupling, which can be released in the 0 position, and a 300 mm long switch shaft. When the control cabinet door is open, the switch can be protected against inadvertent operation by removing the switch shaft from the lower section of the switch. The overall depth can be adapted to individual requirements by adjusting the switch shaft length.

Distribution board mounting



The switches for distribution board mounting are suited for operation in distribution boards and for switching inside control cabinets or distributors. Up to 125 A (3LD28), they have cap and mounting dimensions according to DIN 43880 and can be fitted under the same cover together with miniature circuit breakers.

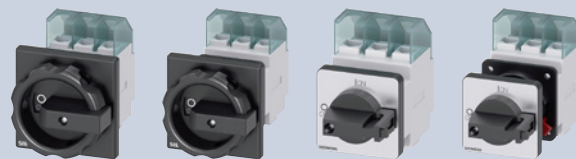
DC isolators



The DC isolators in the enclosure are suitable for disconnecting loads of up to 800 V DC due to their 8-pole design. To provide additional safety, the isolators can be locked in the 0 position.

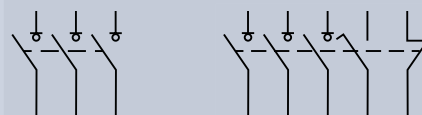
3LD switch disconnectors

3LD2 main control switches, front mounting, 25 ... 50 kA_{rms}



Operating mechanisms, black

Number of poles 3P

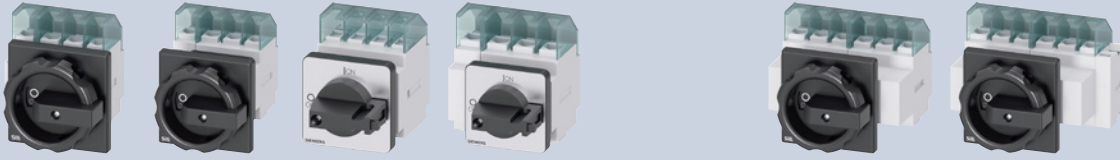


Uninterrupted current I_n At AC-21A, 380 ... 440 V	Operational power P At AC-23A, 380 ... 440 V	Operational power P At AC-3A, 380 ... 440 V	Without auxiliary switch	1 NO + 1 NC (standard version)
Rotary operating mechanism, four-hole mounting				
16 A	7.5 kW	5.5 kW	3LD2003-OTK51	3LD2003-1TP51
25 A	9.5 kW	7.5 kW	3LD2103-OTK51	3LD2103-1TP51
32 A	11.5 kW	9.5 kW	3LD2203-OTK51	3LD2203-1TP51
63 A	22 kW	18.5 kW	3LD2504-OTK51	3LD2504-1TP51
100 A	37 kW	30 kW	3LD2704-OTK51	3LD2704-1TP51
125 A	45 kW	37 kW	3LD2804-OTK51	3LD2804-1TP51
160 A	75 kW	50 kW	3LD2305-OTK11	3LD2305-OTK11 + 3LD9200-5B
250 A	132 kW	110 kW	3LD2405-OTK11	3LD2405-OTK11 + 3LD9200-5B
Rotary operating mechanism, center-hole mounting \varnothing 22.5 mm				
16 A	7.5 kW	5.5 kW	3LD2054-OTK51	3LD2054-1TP51
25 A	9.5 kW	7.5 kW	3LD2154-OTK51	3LD2154-1TP51
32 A	11.5 kW	9.5 kW	3LD2254-OTK51	3LD2254-OTK51 + 3LD9200-5B
63 A	22 kW	18.5 kW	3LD2555-OTK51	3LD2555-OTK51 + 3LD9200-5B
Knob-operated mechanism, four-hole mounting				
16 A	7.5 kW	5.5 kW	3LD2022-OTK11	3LD2022-OTK11 + 3LD9200-5B
25 A	9.5 kW	7.5 kW	3LD2122-OTK11	3LD2122-OTK11 + 3LD9200-5B
32 A	11.5 kW	9.5 kW	3LD2222-OTK11	3LD2222-OTK11 + 3LD9200-5B
Knob-operated mechanism, center-hole mounting \varnothing 22.5 mm				
16 A	7.5 kW	5.5 kW	3LD2050-OTK11	3LD2050-OTK11 + 3LD9200-5B
25 A	9.5 kW	7.5 kW	3LD2150-OTK11	3LD2150-OTK11 + 3LD9200-5B
32 A	11.5 kW	9.5 kW	3LD2250-OTK11	3LD2250-OTK11 + 3LD9200-5B

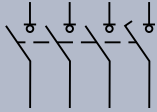
Scope of supply:

- Including terminal covers for the infeed side

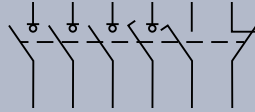
Accessories, see page 8/30



3P+N

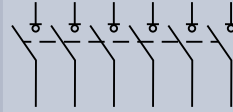


Without
auxiliary switch

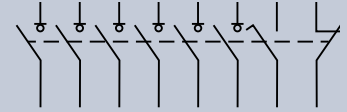


1 NO + 1 NC
(standard version)

6P



Without
auxiliary switch

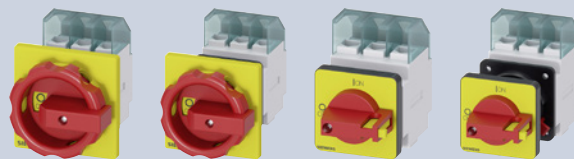


1 NO + 1 NC
(standard version)

3LD2003-1TL51	3LD2003-2EP51	–	–
3LD2103-1TL51	3LD2103-2EP51	3LD2103-3VK51	3LD2103-4VP51
3LD2203-1TL51	3LD2203-1TL51 + 3LD9200-5B	3LD2203-3VK51	3LD2203-3VK51 + 3LD9200-5B
3LD2504-1TL51	3LD2504-1TP51 + 3LD9250-0BA	3LD2504-3VK51	3LD2504-3VK51 + 3LD9200-5B
3LD2704-0TK51 + 3LD9280-0B	3LD2704-0TK51 + 3LD9280-0B + 3LD9200-5B	–	–
3LD2804-0TK51 + 3LD9280-0B	3LD2804-0TK51 + 3LD9280-0B + 3LD9200-5B	–	–
3LD2305-1TL11	3LD2305-1TL11 + 3LD9200-5B	3LD2305-3VK11	3LD2305-3VK11 + 3LD9200-5B
3LD2405-1TL11	3LD2405-1TL11 + 3LD9200-5B	3LD2405-3VK11	3LD2405-3VK11 + 3LD9200-5B
3LD2054-1TL51	3LD2054-2EP51	–	–
3LD2154-1TL51	3LD2154-2EP51	–	–
3LD2254-1TL51	3LD2254-1TL51 + 3LD9200-5B	–	–
3LD2555-0TK51 + 3LD9250-0BA	3LD2555-0TK51 + 3LD9250-0BA + 3LD9200-5B	–	–
3LD2022-1TL11	3LD2022-1TL11 + 3LD9200-5B	–	–
3LD2122-1TL11	3LD2122-1TL11 + 3LD9200-5B	3LD2122-3VK11	–
3LD2222-0TK11 + 3LD9220-0B	3LD2222-0TK11 + 3LD9220-0B + 3LD9200-5B	–	–
3LD2050-1TL11	3LD2050-1TL11 + 3LD9200-5B	–	–
3LD2150-0TK11 + 3LD9220-0B	3LD2150-0TK11 + 3LD9220-0B + 3LD9200-5B	–	–
3LD2250-0TK11 + 3LD9220-0B	3LD2250-0TK11 + 3LD9220-0B + 3LD9200-5B	–	–

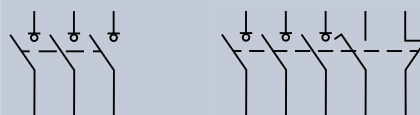
3LD switch disconnectors

3LD2 EMERGENCY-STOP switches, front mounting, 25 ... 50 kA_{rms}



Operating mechanisms, red/yellow

Number of poles 3P

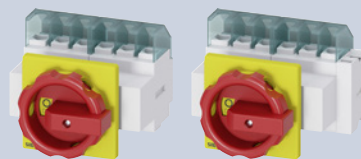
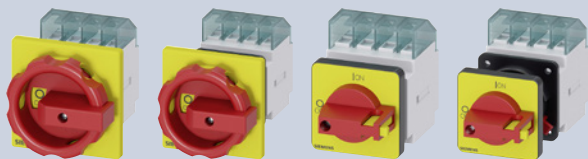


Uninterrupted current I_n At AC-21A, 380 ... 440 V	Operational power P At AC-23A, 380 ... 440 V	Operational power P At AC-3A, 380 ... 440 V	Without auxiliary switch	1 NO + 1 NC (standard version)
Rotary operating mechanism, four-hole mounting				
16 A	7.5 kW	5.5 kW	3LD2003-OTK53	3LD2003-1TP53
25 A	9.5 kW	7.5 kW	3LD2103-OTK53	3LD2103-1TP53
32 A	11.5 kW	9.5 kW	3LD2203-OTK53	3LD2203-1TP53
63 A	22 kW	18.5 kW	3LD2504-OTK53	3LD2504-1TP53
100 A	37 kW	30 kW	3LD2704-OTK53	3LD2704-1TP53
125 A	45 kW	37 kW	3LD2804-OTK53	3LD2804-1TP53
160 A	75 kW	50 kW	3LD2305-OTK13	3LD2305-OTK13 + 3LD9200-5B
250 A	132 kW	110 kW	3LD2405-OTK13	3LD2405-OTK13 + 3LD9200-5B
Rotary operating mechanism, center-hole mounting \varnothing 22.5 mm				
16 A	7.5 kW	5.5 kW	3LD2054-OTK53	3LD2054-1TP53
25 A	9.5 kW	7.5 kW	3LD2154-OTK53	3LD2154-1TP53
32 A	11.5 kW	9.5 kW	3LD2254-OTK53	3LD2254-OTK53 + 3LD9200-5B
63 A	22 kW	18.5 kW	3LD2555-OTK53	3LD2555-OTK53 + 3LD9200-5B
Knob-operated mechanism, four-hole mounting				
16 A	7.5 kW	5.5 kW	3LD2022-OTK13	3LD2022-OTK13 + 3LD9200-5B
25 A	9.5 kW	7.5 kW	3LD2122-OTK13	3LD2122-OTK13 + 3LD9200-5B
32 A	11.5 kW	9.5 kW	3LD2222-OTK13	3LD2222-OTK13 + 3LD9200-5B
Knob-operated mechanism, center-hole mounting \varnothing 22.5 mm				
16 A	7.5 kW	5.5 kW	3LD2050-OTK13	3LD2050-OTK13 + 3LD9200-5B
25 A	9.5 kW	7.5 kW	3LD2150-OTK13	3LD2150-OTK13 + 3LD9200-5B
32 A	11.5 kW	9.5 kW	3LD2250-OTK13	3LD2250-OTK13 + 3LD9200-5B

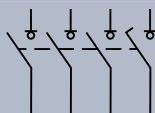
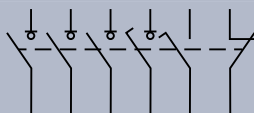
Scope of supply:

- Including terminal covers for the infeed side

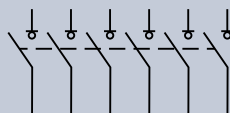
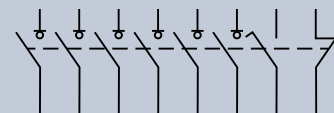
Accessories, see page 8/30



3P+N

Without
auxiliary switch1 NO + 1 NC
(standard version)

6P

Without
auxiliary switch1 NO + 1 NC
(standard version)

3LD2003-1TL53

3LD2003-2EP53

-

-

3LD2103-1TL53

3LD2103-2EP53

3LD2103-3VK53

3LD2103-4VP53

3LD2203-1TL53

3LD2203-1TL53 + 3LD9200-5B

3LD2203-3VK53

3LD2203-3VK53 + 3LD9200-5B

3LD2504-1TL53

3LD2504-1TP53 + 3LD9250-0BA

3LD2504-3VK53

3LD2504-3VK53 + 3LD9200-5B

3LD2704-0TK53 + 3LD9280-0B

3LD2704-0TK53 + 3LD9280-0B + 3LD9200-5B

-

-

3LD2804-0TK53 + 3LD9280-0B

3LD2804-0TK53 + 3LD9280-0B + 3LD9200-5B

-

-

3LD2305-1TL13

3LD2305-1TL13 + 3LD9200-5B

3LD2305-3VK13

3LD2305-3VK13 + 3LD9200-5B

3LD2405-1TL13

3LD2405-1TL13 + 3LD9200-5B

3LD2405-3VK13

3LD2405-3VK13 + 3LD9200-5B

3LD2054-1TL53

3LD2054-2EP53

-

-

3LD2154-1TL53

3LD2154-2EP53

-

-

3LD2254-1TL53

3LD2254-1TL53 + 3LD9200-5B

-

-

3LD2555-0TK53 + 3LD9250-0BA

3LD2555-0TK53 + 3LD9250-0BA + 3LD9200-5B

-

-

3LD2022-1TL13

3LD2022-1TL13 + 3LD9200-5B

-

-

3LD2122-1TL13

3LD2122-1TL13 + 3LD9200-5B

3LD2122-3VK13

-

3LD2222-0TK13 + 3LD9220-0B

3LD2222-0TK13 + 3LD9220-0B + 3LD9200-5B

-

-

3LD2050-1TL13

3LD2050-1TL13 + 3LD9200-5B

-

-

3LD2150-0TK13 + 3LD9220-0B

3LD2150-0TK13 + 3LD9220-0B + 3LD9200-5B

-

-

3LD2250-0TK13 + 3LD9220-0B







3LD2250-0TK13 + 3LD9220-0B + 3LD9200-5B



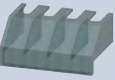

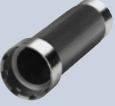
-

-

3LD switch disconnectors

Accessories for front mounting

			3LD20 (16 A)	3LD21 (25 A)	3LD22 (32 A)	3LD25 (63 A)	3LD27 (100 A)	3LD28 (125 A)	3LD23 (160 A)	3LD24 (250 A)	
N switching contacts (4th contact element)											
	Contacts	Article No.									
	Leading switch-on, lagging switch-off	3LD9220-0B		■	■						
		3LD9250-0BA				■					
		3LD9280-0B					■	■			
		3LD9240-0B							■	■	
N/PE terminals											
	Contacts	Article No.									
	Through-type	3LD9200-2B		■							
		3LD9220-2B			■	■					
		3LD9250-2BA					■				
		3LD9280-2B						■	■		
3LD9240-2B								■	■		
Auxiliary switches (standard version)											
	<ul style="list-style-type: none"> For mounting on the left and/or right Lagging switch-on, leading switch-off 										
	Contacts	Contact surface	Article No.								
	1 NO + 1 NC	Standard	3LD9200-5B	■	■	■	■	■	■	■	■
Gold-plated		3LD9200-5BF	■	■	■	■	■	■	■	■	
Auxiliary switches for mounting on the front											
	<ul style="list-style-type: none"> Mounted on the switch shaft For four-hole front mounting and floor mounting only For long leading times (20 ... 150 m) Not for 6-pole 3LD23 (160 A) and 3LD24 (250 A) 										
	Contacts	Contact surface	Article No.								
	1 NO + 1 NC	Standard	3LD9280-5D	■	■	■	■	■	■	■	■
			3LD9240-5D							■	■
		Gold-plated	3LD9280-5DF	■	■	■	■	■	■	■	■
3LD9240-5DF									■	■	
Rotary operating mechanisms											
	<ul style="list-style-type: none"> Lockable in 0 position with up to 3 padlocks 										
	Version	Mounting	Article No.								
	For main control switches	Center-hole mounting	3LD9224-1D	■	■	■					
			3LD9284-1D				■				
		Four-hole mounting	3LD9224-1B	■	■	■					
			3LD9284-1B				■	■	■		
	For EMERGENCY-STOP switches	Center-hole mounting	3LD9224-3D	■	■	■					
			3LD9284-3D				■				
		Four-hole mounting	3LD9224-3B	■	■	■					
			3LD9284-3B				■	■	■		
Knob-operated mechanisms											
	<ul style="list-style-type: none"> Lockable in 0 position with up to 3 padlocks 										
	Version	Mounting	Article No.								
	For main control switches	Four-hole mounting	3LD9243-1B							■	■
			3LD9243-3B							■	■

		3LD20 (16 A)	3LD21 (25 A)	3LD22 (32 A)	3LD25 (63 A)	3LD27 (100 A)	3LD28 (125 A)	3LD23 (160 A)	3LD24 (250 A)
Terminal covers									
• Pack of 4 units									
Number of poles		Article No.							
	1-pole	3LD9201-2A	■						
		3LD9221-2A		■	■				
		3LD9251-2A				■			
		3LD9281-2A					■	■	
		3LD9241-2A							■
	3-pole	3LD9221-0A		■	■				
		3LD9251-0A				■			
	4-pole	3LD9201-1A	■						
Inscription labels									
• Pack of 10 units									
Inscription		Article No.							
	German/English (Hauptschalter/Main Switch)	3LD9286-1A	■	■	■	■	■	■	
	Without inscription	3LD9286-4A	■	■	■	■	■	■	
Assembly tools									
• For center-hole mounting with nut • Pack of 5 units									
Version		Article No.							
	For main control switches and EMERGENCY-STOP switches	3LD9256-0A	■	■	■	■			

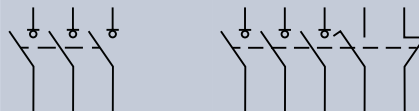
3LD switch disconnectors

3LD2 main control switches, floor mounting, 25 ... 50 kA_{rms}



Operating mechanisms, black

Number of poles 3P



Uninterrupted current I_u At AC-21A, 380 ... 440 V	Operational power P At AC-23A, 380 ... 440 V	Operational power P At AC-3A, 380 ... 440 V	Without auxiliary switch	1 NO + 1 NC (standard version)
Door-coupling rotary operating mechanism, four-hole mounting				
16 A	7.5 kW	5.5 kW	3LD2013-OTK51	3LD2013-OTK51 + 3LD9200-5C
25 A	9.5 kW	7.5 kW	3LD2113-OTK51	3LD2113-OTK51 + 3LD9200-5C
32 A	11.5 kW	9.5 kW	3LD2213-OTK51	3LD2213-OTK51 + 3LD9200-5C
63 A	22 kW	18.5 kW	3LD2514-OTK51	3LD2514-OTK51 + 3LD9200-5C
100 A	37 kW	30 kW	3LD2714-OTK51	3LD2714-OTK51 + 3LD9200-5C
125 A	45 kW	37 kW	3LD2814-OTK51	3LD2814-OTK51 + 3LD9200-5C
160 A	75 kW	50 kW	3LD2318-OTK11	3LD2318-OTK11 + 3LD9200-5C
250 A	132 kW	110 kW	3LD2418-OTK11	3LD2418-OTK11 + 3LD9200-5C
Door-coupling rotary operating mechanism, center-hole mounting \varnothing 22.5 mm				
16 A	7.5 kW	5.5 kW	3LD2044-OTK51	3LD2044-OTK51 + 3LD9200-5C
25 A	9.5 kW	7.5 kW	3LD2144-OTK51	3LD2144-OTK51 + 3LD9200-5C
32 A	11.5 kW	9.5 kW	3LD2244-OTK51	3LD2244-OTK51 + 3LD9200-5C
63 A	22 kW	18.5 kW	3LD2545-OTK51	3LD2545-OTK51 + 3LD9200-5C
Defeatable door-coupling knob-operated mechanism, four-hole mounting				
16 A	7.5 kW	5.5 kW	3LD2017-OTK11	3LD2017-OTK11 + 3LD9200-5C
32 A	11.5 kW	9.5 kW	3LD2217-OTK11	3LD2217-OTK11 + 3LD9200-5C
63 A	22 kW	18.5 kW	3LD2517-OTK11	3LD2517-OTK11 + 3LD9200-5C

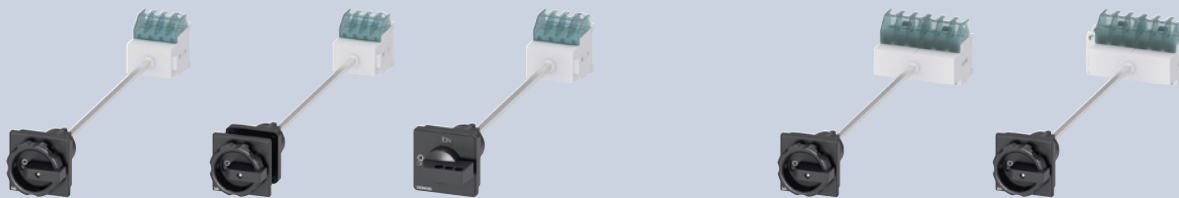
Scope of supply:

- Including terminal covers for the infeed side
- Up to 125 A with integrated tolerance compensation

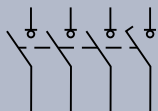
Mounting:

- Up to 125 A using screws or snap-on mounting on 35 mm mounting rails

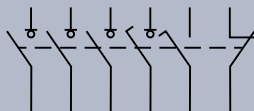
Accessories, see page 8/36



3P+N

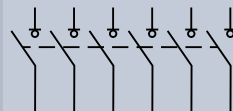


Without auxiliary switch

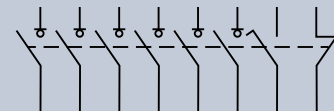


1 NO + 1 NC (standard version)

6P



Without auxiliary switch



1 NO + 1 NC (standard version)

3LD2013-1TL51	3LD2013-1TL51	+ 3LD9200-5C	–	–
3LD2113-1TL51	3LD2113-1TL51	+ 3LD9200-5C	3LD2113-3VK51	3LD2113-4VP51
3LD2213-1TL51	3LD2213-1TL51	+ 3LD9200-5C	–	–
3LD2514-1TL51	3LD2514-1TL51	+ 3LD9200-5C	–	–
3LD2714-0TK51 + 3LD9280-0C	3LD2714-0TK51 + 3LD9280-0C	+ 3LD9200-5C	–	–
3LD2814-0TK51 + 3LD9280-0C	3LD2814-0TK51 + 3LD9280-0C	+ 3LD9200-5C	–	–
3LD2318-1TL11	3LD2318-1TL11	+ 3LD9200-5C	3LD2318-3VK11	3LD2318-3VK11 + 3LD9200-5C
3LD2418-1TL11	3LD2418-1TL11	+ 3LD9200-5C	3LD2418-3VK11	3LD2418-3VK11 + 3LD9200-5C
3LD2044-1TL51	3LD2044-1TL51	+ 3LD9200-5C	–	–
3LD2144-1TL51	3LD2144-1TL51	+ 3LD9200-5C	–	–
3LD2244-1TL51	3LD2244-1TL51	+ 3LD9200-5C	–	–
3LD2545-0TK51 + 3LD9250-0CA	3LD2545-0TK51 + 3LD9250-0CA	+ 3LD9200-5C	–	–
3LD2017-1TL11	3LD2017-1TL11 + 3LD9200-5C		–	–
3LD2217-1TL11	3LD2217-1TL11 + 3LD9200-5C		–	–
3LD2517-1TL11	3LD2517-1TL11 + 3LD9200-5C		–	–

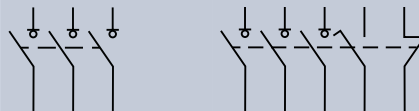
3LD switch disconnectors

3LD2 EMERGENCY-STOP switches, floor mounting, 25 ... 50 kA_{rms}



Operating mechanisms, red/yellow

Number of poles 3P



Uninterrupted current I_u At AC-21A, 380 ... 440 V	Operational power P At AC-23A, 380 ... 440 V	Operational power P At AC-3A, 380 ... 440 V	Without auxiliary switch	1 NO + 1 NC (standard version)
Door-coupling rotary operating mechanism, four-hole mounting				
16 A	7.5 kW	5.5 kW	3LD2013-OTK53	3LD2013-OTK53 + 3LD9200-5C
25 A	9.5 kW	7.5 kW	3LD2113-OTK53	3LD2113-OTK53 + 3LD9200-5C
32 A	11.5 kW	9.5 kW	3LD2213-OTK53	3LD2213-OTK53 + 3LD9200-5C
63 A	22 kW	18.5 kW	3LD2514-OTK53	3LD2514-OTK53 + 3LD9200-5C
100 A	37 kW	30 kW	3LD2714-OTK53	3LD2714-OTK53 + 3LD9200-5C
125 A	45 kW	37 kW	3LD2814-OTK53	3LD2814-OTK53 + 3LD9200-5C
160 A	75 kW	50 kW	3LD2318-OTK13	3LD2318-OTK13 + 3LD9200-5C
250 A	132 kW	110 kW	3LD2418-OTK13	3LD2418-OTK13 + 3LD9200-5C
Door-coupling rotary operating mechanism, center-hole mounting Ø 22.5 mm				
16 A	7.5 kW	5.5 kW	3LD2044-OTK53	3LD2044-OTK53 + 3LD9200-5C
25 A	9.5 kW	7.5 kW	3LD2144-OTK53	3LD2144-OTK53 + 3LD9200-5C
32 A	11.5 kW	9.5 kW	3LD2244-OTK53	3LD2244-OTK53 + 3LD9200-5C
63 A	22 kW	18.5 kW	3LD2545-OTK53	3LD2545-OTK53 + 3LD9200-5C
Defeatable door-coupling knob-operated mechanism, four-hole mounting				
16 A	7.5 kW	5.5 kW	3LD2017-OTK13	3LD2017-OTK13 + 3LD9200-5C
32 A	11.5 kW	9.5 kW	3LD2217-OTK13	3LD2217-OTK13 + 3LD9200-5C
63 A	22 kW	18.5 kW	3LD2517-OTK13	3LD2517-1TL13 + 3LD9200-5C

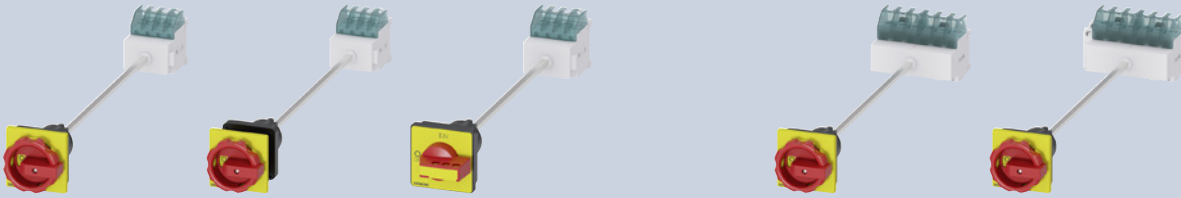
Scope of supply:

- Including terminal covers for the infeed side
- Up to 125 A with integrated tolerance compensation

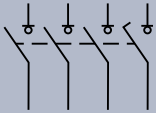
Mounting:

- Up to 125 A using screws or snap-on mounting on 35 mm mounting rails

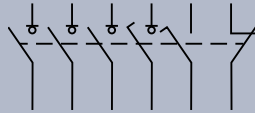
Accessories, see page 8/36



3P+N

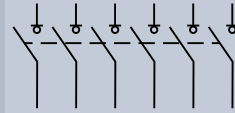


Without
auxiliary switch

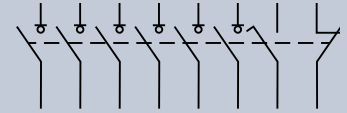


1 NO + 1 NC
(standard version)

6P



Without
auxiliary switch



1 NO + 1 NC
(standard version)

3LD2013-1TL53	3LD2013-1TL53	+ 3LD9200-5C	–	–
3LD2113-1TL53	3LD2113-1TL53	+ 3LD9200-5C	3LD2113-3VK53	3LD2113-4VP53
3LD2213-1TL53	3LD2213-1TL53	+ 3LD9200-5C	–	–
3LD2514-1TL53	3LD2514-1TL53	+ 3LD9200-5C	–	–
3LD2714-0TK53 + 3LD9280-0C	3LD2714-0TK53 + 3LD9280-0C	+ 3LD9200-5C	–	–
3LD2814-0TK53 + 3LD9280-0C	3LD2814-0TK53 + 3LD9280-0C	+ 3LD9200-5C	–	–
3LD2318-1TL13	3LD2318-1TL13	+ 3LD9200-5C	3LD2318-3VK13	3LD2318-3VK13 + 3LD9200-5C
3LD2418-1TL13	3LD2418-1TL13	+ 3LD9200-5C	3LD2418-3VK13	3LD2418-3VK13 + 3LD9200-5C
3LD2044-1TL53	3LD2044-1TL53	+ 3LD9200-5C	–	–
3LD2144-1TL53	3LD2144-1TL53	+ 3LD9200-5C	–	–
3LD2244-1TL53	3LD2244-1TL53	+ 3LD9200-5C	–	–
3LD2545-0TK53 + 3LD9250-0CA	3LD2545-0TK53 + 3LD9250-0CA	+ 3LD9200-5C	–	–
3LD2017-1TL13	3LD2017-1TL13 + 3LD9200-5C		–	–
3LD2217-1TL13	3LD2217-0TK13 + 3LD9200-5C		–	–
3LD2517-1TL13	3LD2517-1TL13 + 3LD9200-5C		–	–

3LD switch disconnectors

Accessories for floor mounting

3LD20 (16 A) 3LD21 (25 A) 3LD22 (32 A) 3LD25 (63 A) 3LD27 (100 A) 3LD28 (125 A) 3LD23 (160 A) 3LD24 (250 A)

N switching contacts (4th contact element)



Contacts	Article No.	3LD20 (16 A)	3LD21 (25 A)	3LD22 (32 A)	3LD25 (63 A)	3LD27 (100 A)	3LD28 (125 A)	3LD23 (160 A)	3LD24 (250 A)
Leading switch-on, lagging switch-off	3LD9220-0C		■	■					
	3LD9250-0CA				■				
	3LD9280-0C					■	■		
	3LD9240-0C							■	■

N/PE terminals



Contacts	Article No.	3LD20 (16 A)	3LD21 (25 A)	3LD22 (32 A)	3LD25 (63 A)	3LD27 (100 A)	3LD28 (125 A)	3LD23 (160 A)	3LD24 (250 A)
Through-type	3LD9200-2C	■							
	3LD9220-2C		■	■					
	3LD9250-2CA				■				
	3LD9280-2C					■	■		
	3LD9240-2C							■	■

Auxiliary switches (standard version)



- For mounting on the left and/or right
- Lagging switch-on, leading switch-off

Contacts	Contact surface	Article No.	3LD20 (16 A)	3LD21 (25 A)	3LD22 (32 A)	3LD25 (63 A)	3LD27 (100 A)	3LD28 (125 A)	3LD23 (160 A)	3LD24 (250 A)
1 NO + 1 NC	Standard	3LD9200-5C	■	■	■	■	■	■	■	■
	Gold-plated	3LD9200-5CF	■	■	■	■	■	■	■	■
2 NO	Standard	3LD9200-6C	■	■	■	■	■	■	■	■

Auxiliary switches for mounting on the front



- Mounted on the switch shaft
- For long leading times (20 ... 150 ms)

Contacts	Contact surface	Article No.	3LD20 (16 A)	3LD21 (25 A)	3LD22 (32 A)	3LD25 (63 A)	3LD27 (100 A)	3LD28 (125 A)	3LD23 (160 A)	3LD24 (250 A)
1 NO + 1 NC	Standard	3LD9280-5D	■	■	■	■	■	■		
		3LD9240-5D							■	■
	Gold-plated	3LD9280-5DF	■	■	■	■	■	■		
		3LD9240-5DF							■	■

Rotary operating mechanisms

- Lockable in 0 position with up to 3 padlocks



Version	Mounting	Article No.	3LD20 (16 A)	3LD21 (25 A)	3LD22 (32 A)	3LD25 (63 A)	3LD27 (100 A)	3LD28 (125 A)	3LD23 (160 A)	3LD24 (250 A)
For main control switches	Center-hole mounting	3LD9224-1D	■	■	■					
		3LD9284-1D				■				
	Four-hole mounting	3LD9224-1B	■	■	■					
		3LD9284-1B				■	■	■		



For EMERGENCY-STOP switches	Center-hole mounting	3LD9224-3D	■	■	■					
		3LD9284-3D				■				
	Four-hole mounting	3LD9224-3B	■	■	■					
		3LD9284-3B				■	■	■		

Knob-operated mechanisms



- Lockable in 0 position with up to 3 padlocks




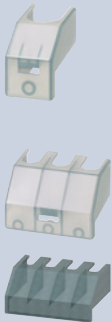


Version	Mounting	Article No.	3LD20 (16 A)	3LD21 (25 A)	3LD22 (32 A)	3LD25 (63 A)	3LD27 (100 A)	3LD28 (125 A)	3LD23 (160 A)	3LD24 (250 A)
For main control switches	Four-hole mounting	3LD9243-1B							■	■
For EMERGENCY-STOP switches	Four-hole mounting	3LD9243-3B							■	■

8UC7.. door-coupling rotary operating mechanisms



- To achieve defeatability from 3LD27 (100 A) to 3LD24 (250 A)

Type	Version	Article No.	3LD20 (16 A)	3LD21 (25 A)	3LD22 (32 A)	3LD25 (63 A)	3LD27 (100 A)	3LD28 (125 A)	3LD23 (160 A)	3LD24 (250 A)
8UC71	Standard	8UC7110-1BB					■	■		
	EMERGENCY-STOP	8UC7120-3BB					■	■		
8UC72	Standard	8UC7210-1BB							■	■
	EMERGENCY-STOP	8UC7220-3BB							■	■

				3LD20 (16 A)	3LD21 (25 A)	3LD22 (32 A)	3LD25 (63 A)	3LD27 (100 A)	3LD28 (125 A)	3LD23 (160 A)	3LD24 (250 A)	
Coupling drivers												
	Version			Article No.								
	For 8UC71 door-coupling rotary operating mechanisms			8UC6011								
	For 8UC72 door-coupling rotary operating mechanisms			8UC6012								
Switch shafts												
	Cross-section	Length	Article No.									
	6 × 6 mm	300 mm	3LD9205-0C									
		600 mm	3LD9205-2C									
	8 × 8 mm	300 mm	3LD9245-0C									
		600 mm	3LD9245-2C									
Coupling pieces												
	• Without ON-lock			Article No.								
				3LD9242-4F								
Terminal covers												
	• Pack of 4 units			Article No.								
	Number of poles											
	1-pole			3LD9201-2A								
				3LD9221-2A								
				3LD9251-2A								
				3LD9281-2A								
				3LD9241-2A								
	3-pole			3LD9221-0A								
				3LD9251-0A								
	4-pole			3LD9201-1A								
Inscription labels												
	• Pack of 10 units											
	• Cannot be used with defeatable 3LD2.17 door-coupling rotary operating mechanisms											
	Inscription			Article No.								
	German/English (Hauptschalter/Main Switch)			3LD9286-1A								
Without inscription			3LD9286-4A									
Assembly tools												
	• For center-hole mounting with nut											
	• Pack of 5 units											
	Version			Article No.								
For main control switches and EMERGENCY-STOP switches			3LD9256-0A									

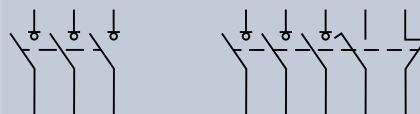
3LD switch disconnectors

3LD2 main control switches, installation in distribution boards, 25 ... 50 kA_{rms}



Operating mechanisms, black

Number of poles 3P



Uninterrupted current I_u At AC-21A, 380 ... 440 V	Operational power P At AC-23A, 380 ... 440 V	Operational power P At AC-3A, 380 ... 440 V	Without auxiliary switch	1 NO + 1 NC (standard version)
Knob-operated mechanisms with masking plate				
16 A	7.5 kW	5.5 kW	3LD2030-OTK11	3LD2030-OTK11 + 3LD9200-5C
25 A	9.5 kW	7.5 kW	3LD2130-OTK11	3LD2130-OTK11 + 3LD9200-5C
32 A	11.5 kW	9.5 kW	3LD2230-OTK11	3LD2230-OTK11 + 3LD9200-5C
63 A	22 kW	18.5 kW	3LD2530-OTK11	3LD2530-OTK11 + 3LD9200-5C
100 A	37 kW	30 kW	3LD2730-OTK11	3LD2730-OTK11 + 3LD9200-5C
125 A	45 kW	37 kW	3LD2830-OTK11	3LD2830-OTK11 + 3LD9200-5C
160 A	75 kW	50 kW	3LD2330-OTK11	3LD2330-OTK11 + 3LD9200-5C
250 A	132 kW	110 kW	3LD2430-OTK11	3LD2430-OTK11 + 3LD9200-5C

Scope of supply:

- 3LD23/3LD24 including terminal covers for the infeed side

Mounting:

- Up to 125 A using screws or snap-on mounting on 35 mm mounting rails
- Up to 125 A cap and mounting dimensions acc. to DIN 43880

Accessories

3LD20 (16 A) 3LD21 (25 A) 3LD22 (32 A) 3LD25 (63 A) 3LD27 (100 A) 3LD28 (125 A) 3LD23 (160 A) 3LD24 (250 A)


N switching contacts (4th contact element)

Contacts	Article No.	3LD20 (16 A)	3LD21 (25 A)	3LD22 (32 A)	3LD25 (63 A)	3LD27 (100 A)	3LD28 (125 A)	3LD23 (160 A)	3LD24 (250 A)
Leading switch-on, lagging switch-off	3LD9220-0C		■	■					
	3LD9250-0CA				■				
	3LD9280-0C					■	■		
	3LD9240-0C							■	■

N/PE terminals

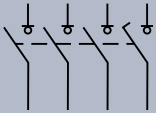
Contacts	Article No.	3LD20 (16 A)	3LD21 (25 A)	3LD22 (32 A)	3LD25 (63 A)	3LD27 (100 A)	3LD28 (125 A)	3LD23 (160 A)	3LD24 (250 A)
Through-type	3LD9200-2C	■							
	3LD9220-2C		■	■					
	3LD9250-2CA				■				
	3LD9280-2C					■	■		
	3LD9240-2C							■	■

Auxiliary switches (standard version)

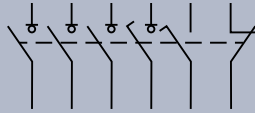
 <ul style="list-style-type: none"> • For mounting on the left and/or right • Lagging switch-on, leading switch-off 	Contacts	Contact surface	Article No.	3LD20 (16 A)	3LD21 (25 A)	3LD22 (32 A)	3LD25 (63 A)	3LD27 (100 A)	3LD28 (125 A)	3LD23 (160 A)	3LD24 (250 A)	
	1 NO + 1 NC	Standard	3LD9200-5C	■	■	■	■	■	■	■	■	■
		Gold-plated	3LD9200-5CF	■	■	■	■	■	■	■	■	■
2 NO	Standard	3LD9200-6C	■	■	■	■	■	■	■	■	■	



3P+N


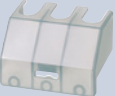
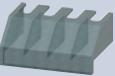


Without auxiliary switch



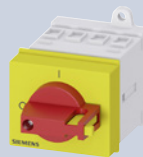
1 NO + 1 NC (standard version)

3LD2030-1TL11	3LD2030-1TL11 + 3LD9200-5C
3LD2130-0TK11 + 3LD9220-0C	3LD2130-0TK11 + 3LD9220-0C + 3LD9200-5C
3LD2230-0TK11 + 3LD9220-0C	3LD2230-0TK11 + 3LD9220-0C + 3LD9200-5C
3LD2530-0TK11 + 3LD9250-OCA	3LD2530-0TK11 + 3LD9250-OCA + 3LD9200-5C
3LD2730-0TK11 + 3LD9280-0C	3LD2730-0TK11 + 3LD9280-0C + 3LD9200-5C
3LD2830-0TK11 + 3LD9280-0C	3LD2830-0TK11 + 3LD9280-0C + 3LD9200-5C
3LD2330-0TK11 + 3LD9240-0C	3LD2330-0TK11 + 3LD9240-0C + 3LD9200-5C
3LD2430-0TK11 + 3LD9240-0C	3LD2430-0TK11 + 3LD9240-0C + 3LD9200-5C

		3LD20 (16 A)	3LD21 (25 A)	3LD22 (32 A)	3LD25 (63 A)	3LD27 (100 A)	3LD28 (125 A)	3LD23 (160 A)	3LD24 (250 A)
Terminal covers									
• Pack of 4 units									
Number of poles		Article No.							
	1-pole	3LD9201-2A	■						
		3LD9221-2A		■	■				
		3LD9251-2A				■			
		3LD9281-2A					■	■	
		3LD9241-2A							■
	3-pole	3LD9221-0A		■	■				
		3LD9251-0A				■			
	4-pole	3LD9201-1A	■						

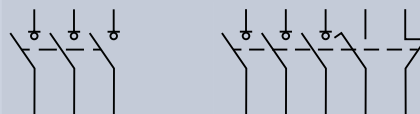
3LD switch disconnectors

3LD2 EMERGENCY-STOP switches, installation in distribution boards, 25 ... 50 kA_{rms}



Operating mechanisms, red/yellow

Number of poles 3P



Uninterrupted current I_u At AC-21A, 380 ... 440 V	Operational power P At AC-23A, 380 ... 440 V	Operational power P At AC-3A, 380 ... 440 V	Without auxiliary switch	1 NO + 1 NC (standard version)
Knob-operated mechanisms with masking plate				
16 A	7.5 kW	5.5 kW	3LD2030-0TK13	3LD2030-0TK13 + 3LD9200-5C
25 A	9.5 kW	7.5 kW	3LD2130-0TK13	3LD2130-0TK13 + 3LD9200-5C
32 A	11.5 kW	9.5 kW	3LD2230-0TK13	3LD2230-0TK13 + 3LD9200-5C
63 A	22 kW	18.5 kW	3LD2530-0TK13	3LD2530-0TK13 + 3LD9200-5C
100 A	37 kW	30 kW	3LD2730-0TK13	3LD2730-0TK13 + 3LD9200-5C
125 A	45 kW	37 kW	3LD2830-0TK13	3LD2830-0TK13 + 3LD9200-5C
160 A	75 kW	50 kW	3LD2330-0TK13	3LD2330-0TK13 + 3LD9200-5C
250 A	132 kW	110 kW	3LD2430-0TK13	3LD2430-0TK13 + 3LD9200-5C

Scope of supply:

- 3LD23/3LD24 including terminal covers for the infeed side


Mounting:

- Up to 125 A using screws or snap-on mounting on 35 mm mounting rails
- Up to 125 A cap and mounting dimensions acc. to DIN 43880

Accessories

3LD20 (16 A) 3LD21 (25 A) 3LD22 (32 A) 3LD25 (63 A) 3LD27 (100 A) 3LD28 (125 A) 3LD23 (160 A) 3LD24 (250 A)


N switching contacts (4th contact element)

Contacts	Article No.	3LD20 (16 A)	3LD21 (25 A)	3LD22 (32 A)	3LD25 (63 A)	3LD27 (100 A)	3LD28 (125 A)	3LD23 (160 A)	3LD24 (250 A)
 Leading switch-on, lagging switch-off	3LD9220-0C		■	■					
	3LD9250-0CA				■				
	3LD9280-0C					■	■		
	3LD9240-0C							■	■

N/PE terminals

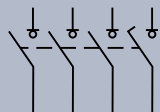
Contacts	Article No.	3LD20 (16 A)	3LD21 (25 A)	3LD22 (32 A)	3LD25 (63 A)	3LD27 (100 A)	3LD28 (125 A)	3LD23 (160 A)	3LD24 (250 A)
 Through-type	3LD9200-2C	■							
	3LD9220-2C		■	■					
	3LD9250-2CA				■				
	3LD9280-2C					■	■		
	3LD9240-2C							■	■

Auxiliary switches (standard version)

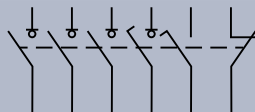
 <ul style="list-style-type: none"> • For mounting on the left and/or right • Lagging switch-on, leading switch-off 											
	Contacts	Contact surface	Article No.	3LD20 (16 A)	3LD21 (25 A)	3LD22 (32 A)	3LD25 (63 A)	3LD27 (100 A)	3LD28 (125 A)	3LD23 (160 A)	3LD24 (250 A)
	1 NO + 1 NC	Standard	3LD9200-5C	■	■	■	■	■	■	■	■
	Gold-plated	3LD9200-5CF	■	■	■	■	■	■	■	■	
2 NO	Standard	3LD9200-6C	■	■	■	■	■	■	■	■	



3P+N


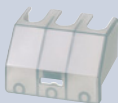
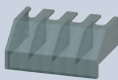


Without auxiliary switch



1 NO + 1 NC (standard version)

3LD2030-1TL13	3LD2030-1TL13 + 3LD9200-5C
3LD2130-0TK13 + 3LD9220-0C	3LD2130-0TK13 + 3LD9220-0C + 3LD9200-5C
3LD2230-0TK13 + 3LD9220-0C	3LD2230-0TK13 + 3LD9220-0C + 3LD9200-5C
3LD2530-0TK13 + 3LD9250-OCA	3LD2530-0TK13 + 3LD9250-OCA + 3LD9200-5C
3LD2730-0TK13 + 3LD9280-0C	3LD2730-0TK13 + 3LD9280-0C + 3LD9200-5C
3LD2830-0TK13 + 3LD9280-0C	3LD2830-0TK13 + 3LD9280-0C + 3LD9200-5C
3LD2330-0TK13 + 3LD9240-0C	3LD2330-0TK13 + 3LD9240-0C + 3LD9200-5C
3LD2430-0TK13 + 3LD9240-0C	3LD2430-0TK13 + 3LD9240-0C + 3LD9200-5C

		3LD20 (16 A)	3LD21 (25 A)	3LD22 (32 A)	3LD25 (63 A)	3LD27 (100 A)	3LD28 (125 A)	3LD23 (160 A)	3LD24 (250 A)
Terminal covers									
• Pack of 4 units									
Number of poles		Article No.							
	1-pole	3LD9201-2A	■						
		3LD9221-2A		■	■				
		3LD9251-2A				■			
		3LD9281-2A					■	■	
		3LD9241-2A							■
	3-pole	3LD9221-0A		■	■				
		3LD9251-0A				■			
	4-pole	3LD9201-1A	■						








3LD switch disconnectors

DC isolators, 50 kA_{rms}






Operating mechanisms, black			
Number of poles	8P		
Mains voltage	Rated operational current I_e At DC-21A, 800 V DC	Rated operational current I_e At DC-22A, 800 V DC	Without auxiliary switch
Knob-operated mechanisms			
800 V DC	32 A	16 A	3LD2230-8VQ11-0AF6

Accessories for 3LD2 main control and EMERGENCY-STOP switches


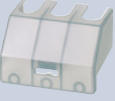
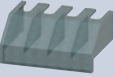

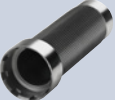
				3LD20 (16 A)	3LD21 (25 A)	3LD22 (32 A)	3LD25 (63 A)	3LD27 (100 A)	3LD28 (125 A)	3LD23 (160 A)	3LD24 (250 A)	
Additional poles												
N switching contacts (4th contact element)												
	Version	Contacts	Article No.									
	For front mounting	Leading switch-on, lagging switch-off	3LD9220-0B		■	■						
			3LD9250-0BA			■						
			3LD9280-0B				■	■				
3LD9240-0B								■	■			
	Version	Contacts	Article No.									
	For floor mounting, installation in distribution boards	Leading switch-on, lagging switch-off	3LD9220-0C		■	■						
			3LD9250-0CA			■						
			3LD9280-0C				■	■				
3LD9240-0C								■	■			
N/PE terminals												
	Version	Contacts	Article No.									
	For front mounting	Through-type	3LD9200-2B	■								
			3LD9220-2B		■	■						
			3LD9250-2BA			■						
3LD9280-2B				■	■							
3LD9240-2B									■	■		
	Version	Contacts	Article No.									
	For floor mounting, installation in distribution boards	Through-type	3LD9200-2C	■								
			3LD9220-2C		■	■						
			3LD9250-2CA			■						
3LD9280-2C				■	■							
3LD9240-2C									■	■		
Auxiliary switches (standard version)												
<ul style="list-style-type: none"> For mounting on the left and/or right Lagging switch-on, leading switch-off 												
	Version	Contacts	Article No.									
	For front mounting	1 NO + 1 NC, standard	3LD9200-5B	■	■	■	■	■	■	■	■	■
		1 NO + 1 NC, gold-plated	3LD9200-5BF	■	■	■	■	■	■	■	■	■
		For floor mounting, installation in distribution boards	1 NO + 1 NC, standard	3LD9200-5C	■	■	■	■	■	■	■	■
1 NO + 1 NC, gold-plated			3LD9200-5CF	■	■	■	■	■	■	■	■	
2 NO, standard		3LD9200-6C	■	■	■	■	■	■	■	■	■	
Auxiliary switches for mounting on the front												
<ul style="list-style-type: none"> Mounted on the front of the switch shaft For four-hole front mounting and floor mounting only For long leading times (20 ... 150 ms) 												
	Contacts	Contact surface	Article No.									
	1 NO + 1 NC	Standard	3LD9280-5D	■	■	■	■	■	■			
			3LD9240-5D							■	■	
		Gold-plated	3LD9280-5DF	■	■	■	■	■	■			
3LD9240-5DF									■	■		

3LD switch disconnectors

Accessories for 3LD2 main control and EMERGENCY-STOP switches

Operating mechanisms				3LD20 (16 A)	3LD21 (25 A)	3LD22 (32 A)	3LD25 (63 A)	3LD27 (100 A)	3LD28 (125 A)	3LD23 (160 A)	3LD24 (250 A)	
Rotary operating mechanisms												
<ul style="list-style-type: none"> Lockable in 0 position with up to 3 padlocks Center-hole mounting, including seal and nut Four-hole mounting, including seal 												
	Switch	Mounting	Article No.									
	For main control switches	Center-hole mounting	3LD9224-1D	■	■	■						
		Four-hole mounting	3LD9224-1B	■	■	■	■	■	■			
		For EMERGENCY-STOP switches	Center-hole mounting	3LD9224-3D	■	■	■					
			Four-hole mounting	3LD9224-3B	■	■	■	■	■	■		
Knob-operated mechanisms												
<ul style="list-style-type: none"> Lockable in 0 position with up to 3 padlocks Including seal 												
	Switch	Mounting	Article No.									
	For main control switches	Four-hole mounting	3LD9243-1B							■	■	
	For EMERGENCY-STOP switches	Four-hole mounting	3LD9243-3B							■	■	
Supplementary handles for door-coupling rotary operating mechanism												
<ul style="list-style-type: none"> For requirements according to UL 508A/NFPA 79 Can be locked with up to 1 padlocks in 0 position Can only be switched on by deliberate action 												
	Inscription	Color	Article No.									
	O-I	Gray	3LD9287-1C	■	■	■	■	■	■			
		Red/yellow	3LD9287-3C	■	■	■	■	■	■	■	■	
Switch shafts												
	Version	Cross-section	Length	Article No.								
	For floor mounting	6 × 6 mm	300 mm	3LD9205-0C	■	■	■	■	■	■		
			600 mm	3LD9205-2C	■	■	■	■	■	■		
		8 × 8 mm	300 mm	3LD9245-0C							■	■
600 mm			3LD9245-2C							■	■	
Coupling pieces												
<ul style="list-style-type: none"> Without ON-lock 												
	Version	Article No.										
	For floor mounting	3LD9242-4F								■	■	

Further accessories

		3LD20 (16 A)	3LD21 (25 A)	3LD22 (32 A)	3LD25 (63 A)	3LD27 (100 A)	3LD28 (125 A)	3LD23 (160 A)	3LD24 (250 A)
Terminal covers									
• Pack of 4 units									
	Number of poles	Article No.							
	1-pole	3LD9201-2A	■						
		3LD9221-2A		■	■				
		3LD9251-2A				■			
		3LD9281-2A					■	■	
	3LD9241-2A							■	■
	3-pole	3LD9221-0A	■	■					
		3LD9251-0A			■				
	4-pole	3LD9201-1A	■						
Inscription labels									
• Pack of 10 units									
	Inscription	Article No.							
	German/English (Hauptschalter/Main Switch)	3LD9286-1A	■	■	■	■	■	■	
	Without inscription	3LD9286-4A	■	■	■	■	■	■	
Assembly tools									
• For center-hole mounting with nut									
• Pack of 5 units									
	Switch	Article No.							
	For main control switches and EMERGENCY-STOP switches	3LD9256-0A	■	■	■	■			

3LD switch disconnectors

System overview of 3LD2 switch disconnectors in enclosure

3LD2 main control and EMERGENCY-STOP switches in enclosure



3P/3P+N
molded-plastic enclosures



3P/6P
molded-plastic enclosures



3P/3P+N/6P
molded-plastic enclosures

3LD2 maintenance and repair switches with EMC shield plate



3P
molded-plastic enclosures



3P/6P
molded-plastic enclosures



3P/6P
molded-plastic enclosures

8

DC isolators in enclosure



8P DC isolators in a molded-plastic enclosure

Additional poles and auxiliary switch modules



N switching
contact



N/PE terminals
(through-type)



Auxiliary switches
(standard version)



Auxiliary switch for mounting on
the front

Operating mechanisms



Rotary operating mechanisms for center-hole mounting

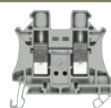


Knob-operated mechanisms for 3LD2 with EMC shield plate

Further accessories



Shield terminal

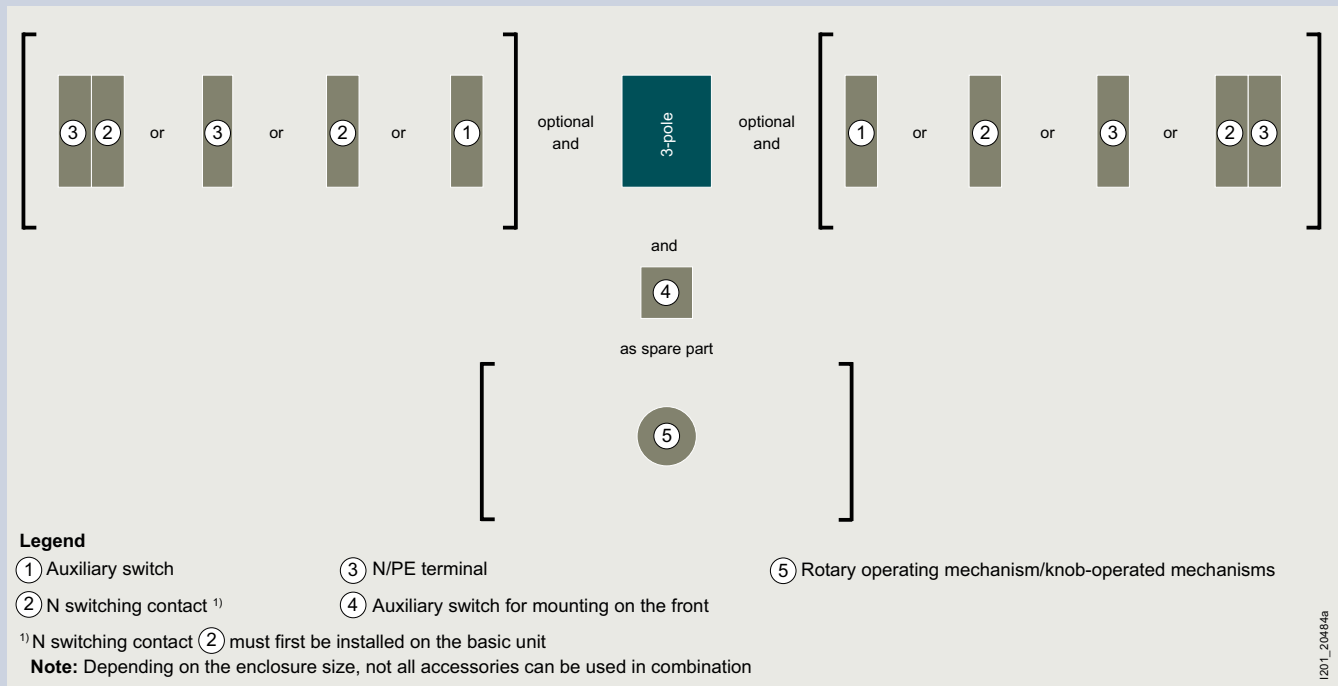


Through-type terminal

Note:

You will find a detailed range of accessories with the basic units.

Mounting concept and accessories



Mounting types

3LD2 main control and EMERGENCY-STOP switches in enclosure



For surface mounting of individual main control and EMERGENCY-STOP switches, molded plastic-enclosed switches with degree of protection IP65 are used. The molded-plastic enclosures each contain an N and/or a PE terminal. As the switches can be locked in the 0 position, they can also be used as maintenance and repair switches.

DC isolators in enclosure



The DC isolators in the enclosure are suitable for disconnecting loads of up to 800 V DC due to their 8-pole design. To provide additional safety, the isolators can be locked in the 0 position.

3LD2 maintenance and repair switches with EMC shield plate



The 3LD2 maintenance and repair switch with EMC shield plate is ideal for use between converter and motor. A long leading (20 ... 150 ms) NO contact switches the converter group off before the main contacts of the switch open. This produces an AC20 state. The cable shield can be contacted over a large area inside the enclosure using the shield clamps or hose clips included in the scope of delivery.

The switch series provides the greatest possible safety for the user and can be locked in the 0 or I position. Tests have been performed in connection with SINAMICS converters and ratings are available for use at frequencies 0 ... 550 Hz.

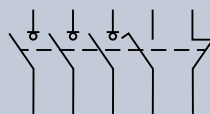
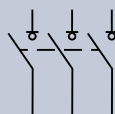
3LD switch disconnectors

3LD2 main control switches in enclosure, 25 ... 50 kA_{rms}

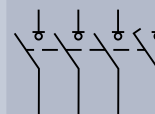


Operating mechanisms, black

Number of poles 3P



3P+N



Uninterrupted current I_u At AC-21A, 380 ... 440 V	Operational power P At AC-23A, 380 ... 440 V	Operational power P At AC-3A, 380 ... 440 V	Without auxiliary switch		1 NO + 1 NC (standard version)		Without auxiliary switch	
Rotary operating mechanisms with masking plate			Base terminal		Base terminal		Base terminal	
16 A	7.5 kW	5.5 kW	PE+N	3LD2064-0TB51	N	3LD2064-1GP51	PE	3LD2064-1TC51
25 A	9.5 kW	7.5 kW	PE+N	3LD2164-0TB51	N	3LD2164-1GP51	PE	3LD2164-1TC51
32 A	11.5 kW	9.5 kW	PE+N	3LD2264-0TB51	N	3LD2264-1GP51	PE	3LD2264-1TC51
63 A	22 kW	18.5 kW	PE+N	3LD2565-0TB51	N	3LD2565-1GP51	PE	3LD2565-1TC51
100 A	37 kW	30 kW	PE+N	3LD2766-0TB51	N	3LD2766-1GP51	PE+N	3LD2766-0TB51 + 3LD9280-0C
125 A	45 kW	37 kW	PE+N	3LD2866-0TB51	N	3LD2866-1GP51	PE+N	3LD2866-0TB51 + 3LD9280-0C

Accessories

3LD20 (16 A) 3LD21 (25 A) 3LD22 (32 A) 3LD25 (63 A) 3LD27 (100 A) 3LD28 (125 A)

N switching contacts (4th contact element)



Contacts	Article No.	3LD20 (16 A)	3LD21 (25 A)	3LD22 (32 A)	3LD25 (63 A)	3LD27 (100 A)	3LD28 (125 A)
Leading switch-on, lagging switch-off	3LD9220-0C		■	■			
	3LD9250-0CA				■		
	3LD9280-0C					■	■

N/PE terminals



Contacts	Article No.	3LD20 (16 A)	3LD21 (25 A)	3LD22 (32 A)	3LD25 (63 A)	3LD27 (100 A)	3LD28 (125 A)
Through-type	3LD9200-2C	■					
	3LD9220-2C		■	■			
	3LD9250-2CA				■		
	3LD9280-2C					■	■

Auxiliary switches (standard version)



Contacts	Contact surface	Article No.	3LD20 (16 A)	3LD21 (25 A)	3LD22 (32 A)	3LD25 (63 A)	3LD27 (100 A)	3LD28 (125 A)
1 NO + 1 NC	Standard	3LD9200-5C	■	■	■	■	■	■
	Gold-plated	3LD9200-5CF	■	■	■	■	■	■
2 NO	Standard	3LD9200-6C	■	■	■	■	■	

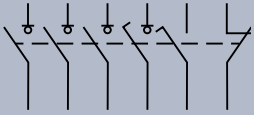
Auxiliary switches for mounting on the front



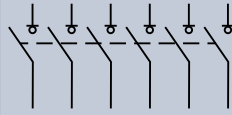
Contacts	Contact surface	Article No.	3LD20 (16 A)	3LD21 (25 A)	3LD22 (32 A)	3LD25 (63 A)	3LD27 (100 A)	3LD28 (125 A)
1 NO + 1 NC	Standard	3LD9280-5D	■	■	■	■	■	■
	Gold-plated	3LD9280-5DF	■	■	■	■	■	■



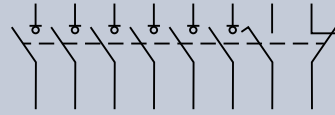
6P



1 NO + 1 NC
(standard version)



Without auxiliary switch



1 NO + 1 NC
(standard version)

Base terminal		Base terminal		Base terminal		
PE	3LD2064-1TC51	+ 3LD9200-5C	–	–	–	
PE	3LD2164-1TC51	+ 3LD9200-5C	PE+N	3LD2165-3VB51	N	3LD2165-4VD51
PE	3LD2264-1TC51	+ 3LD9200-5C	PE+N	3LD2265-3VB51	N	3LD2265-4VD51
PE	3LD2565-1TC51	+ 3LD9200-5C	PE+N	3LD2566-3VB51	PE+N	3LD2566-4VD51
N	3LD2766-1GP51 + 3LD9280-0C		–	–	–	–
N	3LD2866-1GP51 + 3LD9280-0C		–	–	–	–

8

Accessories

Rotary operating mechanisms		3LD20 (16 A)	3LD21 (25 A)	3LD22 (32 A)	3LD25 (63 A)	3LD27 (100 A)	3LD28 (125 A)
<ul style="list-style-type: none"> Lockable in 0 position with up to 3 padlocks 							
Version	Article No.						
3P, 3P+N	3LD9224-1GH ¹⁾	■	■	■			
	3LD9284-1G				■	■	■
6P	3LD9284-1G		■	■	■		



¹⁾ Incl. enclosure cover

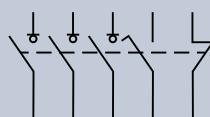
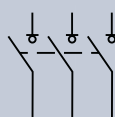
3LD switch disconnectors

3LD2 EMERGENCY-STOP switches in enclosure, 25 ... 50 kA_{rms}

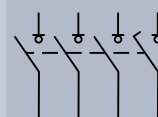


Operating mechanisms, red/yellow

Number of poles 3P



3P+N



Uninterrupted current I_u At AC-21A, 380 ... 440 V	Operational power P At AC-23A, 380 ... 440 V	Operational power P At AC-3A, 380 ... 440 V	Without auxiliary switch		1 NO + 1 NC (standard version)		Without auxiliary switch	
Rotary operating mechanisms with masking plate			Base terminal		Base terminal		Base terminal	
16 A	7.5 kW	5.5 kW	PE+N	3LD2064-0TB53	N	3LD2064-1GP53	PE	3LD2064-1TC53
25 A	9.5 kW	7.5 kW	PE+N	3LD2164-0TB53	N	3LD2164-1GP53	PE	3LD2164-1TC53
32 A	11.5 kW	9.5 kW	PE+N	3LD2264-0TB53	N	3LD2264-1GP53	PE	3LD2264-1TC53
63 A	22 kW	18.5 kW	PE+N	3LD2565-0TB53	N	3LD2565-1GP53	PE	3LD2565-1TC53
100 A	37 kW	30 kW	PE+N	3LD2766-0TB53	N	3LD2766-1GP53	PE+N	3LD2766-0TB53 + 3LD9280-0C
125 A	45 kW	37 kW	PE+N	3LD2866-0TB53	N	3LD2866-1GP53	PE+N	3LD2866-0TB53 + 3LD9280-0C

Accessories

3LD20 (16 A) 3LD21 (25 A) 3LD22 (32 A) 3LD25 (63 A) 3LD27 (100 A) 3LD28 (125 A)

N switching contacts (4th contact element)



Contacts	Article No.	3LD20 (16 A)	3LD21 (25 A)	3LD22 (32 A)	3LD25 (63 A)	3LD27 (100 A)	3LD28 (125 A)
Leading switch-on, lagging switch-off	3LD9220-0C		■	■			
	3LD9250-0CA				■		
	3LD9280-0C					■	■

N/PE terminals



Contacts	Article No.	3LD20 (16 A)	3LD21 (25 A)	3LD22 (32 A)	3LD25 (63 A)	3LD27 (100 A)	3LD28 (125 A)
Through-type	3LD9200-2C	■					
	3LD9220-2C		■	■			
	3LD9250-2CA				■		
	3LD9280-2C					■	■

Auxiliary switches (standard version)



- For mounting on the left and/or right
- Lagging switch-on, leading switch-off

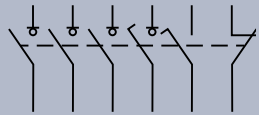
Contacts	Contact surface	Article No.	3LD20 (16 A)	3LD21 (25 A)	3LD22 (32 A)	3LD25 (63 A)	3LD27 (100 A)	3LD28 (125 A)
1 NO + 1 NC	Standard	3LD9200-5C	■	■	■	■	■	■
	Gold-plated	3LD9200-5CF	■	■	■	■	■	■
2 NO	Standard	3LD9200-6C	■	■	■	■	■	

Auxiliary switches for mounting on the front



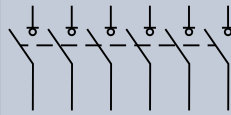
- Mounted on the front of the switch shaft
- For long leading times (20 ... 150 ms)

Contacts	Contact surface	Article No.	3LD20 (16 A)	3LD21 (25 A)	3LD22 (32 A)	3LD25 (63 A)	3LD27 (100 A)	3LD28 (125 A)
1 NO + 1 NC	Standard	3LD9280-5D	■	■	■	■	■	■
	Gold-plated	3LD9280-5DF	■	■	■	■	■	■

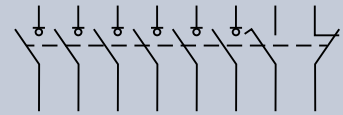


1 NO + 1 NC
(standard version)

6P



Without auxiliary switch



1 NO + 1 NC
(standard version)

Base terminal		Base terminal		Base terminal		
PE	3LD2064-1TC53	+ 3LD9200-5C	–	–	–	
PE	3LD2164-1TC53	+ 3LD9200-5C	PE+N	3LD2165-3VB53	N	3LD2165-4VD53
PE	3LD2264-1TC53	+ 3LD9200-5C	PE+N	3LD2265-3VB53	N	3LD2265-4VD53
PE	3LD2565-1TC53	+ 3LD9200-5C	PE+N	3LD2566-3VB53	PE+N	3LD2566-4VD53
N	3LD2766-1GP53 + 3LD9280-0C		–	–	–	–
N	3LD2866-1GP53 + 3LD9280-0C		–	–	–	–

Accessories

	3LD20 (16 A)	3LD21 (25 A)	3LD22 (32 A)	3LD25 (63 A)	3LD27 (100 A)	3LD28 (125 A)
--	-----------------	-----------------	-----------------	-----------------	------------------	------------------

Rotary operating mechanisms

- Lockable in 0 position with up to 3 padlocks



Version	Article No.	3LD20 (16 A)	3LD21 (25 A)	3LD22 (32 A)	3LD25 (63 A)	3LD27 (100 A)	3LD28 (125 A)
3P, 3P+N	3LD9224-3GH ¹⁾	■	■	■			
	3LD9284-3G				■	■	■



6P	3LD9284-3G		■	■	■		
----	------------	--	---	---	---	--	--

¹⁾ Incl. enclosure cover

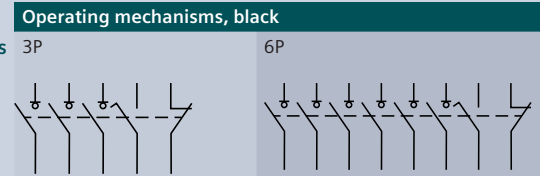
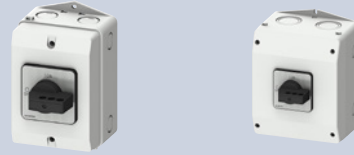
3LD switch disconnectors

3LD2 DC isolators in a molded-plastic enclosure



		Operating mechanisms, black		Operating mechanisms, red/yellow	
Number of poles		8P		8P	
Mains voltage	Rated operational current I_e At DC-21A, 800 V DC	Rated operational current I_e At DC-22A, 800 V DC	Without auxiliary switch		
Rotary operating mechanisms					
800 V DC	32 A	16 A	3LD2265-8VQ51-0AF6	3LD2265-8VQ53-0AF6	

3LD2 maintenance and repair switches with EMC shield plate, 25 ... 50 kA_{rms}

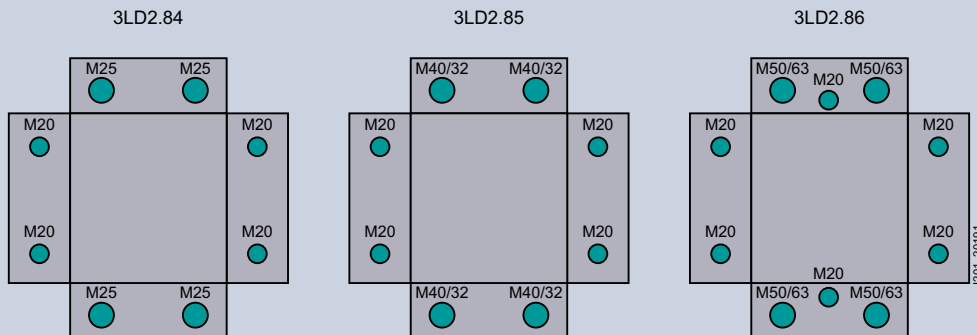


Uninterrupted current I_u At AC-20, 0 ... 550 Hz, 380 ... 440 V	Operational power P At AC-20, 0 ... 550 Hz, 380 ... 440 V	Uninterrupted current I_u At AC-21, 50/60 Hz, 380 ... 440 V	Operational power AC-23A, 50/60 Hz, 380 ... 440 V	1 NO + 1 NC (Auxiliary switch for mounting on the front)	1 NO + 1 NC (Auxiliary switch for mounting on the front)		
Knob-operated mechanisms with masking plate				Base terminal	Base terminal		
10.2 A	4 kW	16 A	7.5 kW	PE	3LD2084-2GP21	2× PE	–
13.2 A	5.5 kW	25 A	9 kW	PE	3LD2184-2GP21	2× PE	3LD2185-5VD21
18 A	7.5 kW	32 A	11.5 kW	PE	3LD2284-2GP21	2× PE	3LD2285-5VD21
38 A	18.5 kW	63 A	22 kW	PE	3LD2585-2GP21	2× PE	3LD2586-5VD21
75 A	37 kW	100 A	37 kW	PE	3LD2786-2GP21	2× PE	–
90 A	45 kW	125 A	45 kW	PE	3LD2886-2GP21	2× PE	–

Scope of supply:

- Incl. shield clamps or hose clips for contacting the cable shield
- The PE terminal as a through-type terminal is insulated from the cable shield

3LD2 cable entries with EMC shield plate







3LD switch disconnectors

3LD2 maintenance and repair switches with EMC shield plate, 25 ... 50 kA_{rms}


Accessories

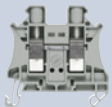

			3LD20 (16 A)	3LD21 (25 A)	3LD22 (32 A)	3LD25 (63 A)	3LD27 (100 A)	3LD28 (125 A)
N switching contacts (4th contact element)								
	Contacts	Article No.						
	Leading switch-on, lagging switch-off	3LD9220-0C		■	■			
		3LD9250-0CA				■		
		3LD9280-0C					■	■
N/PE terminals								
	Contacts	Article No.						
	Through-type	3LD9200-2C	■					
		3LD9220-2C		■	■			
		3LD9250-2CA				■		
		3LD9280-2C					■	■
Auxiliary switches (standard version)								
	<ul style="list-style-type: none"> For mounting on the left and/or right Lagging switch-on, leading switch-off 							
	Contacts	Contact surface	Article No.					
	1 NO + 1 NC	Standard	3LD9200-5C	■	■	■	■	■
		Gold-plated	3LD9200-5CF	■	■	■	■	■
	2 NO	Standard	3LD9200-6C	■	■	■	■	■
Auxiliary switches for mounting on the front								
	<ul style="list-style-type: none"> Mounted on the front of the switch shaft For long leading times (20 ... 150 ms) 							
	Contacts	Contact surface	Article No.					
	1 NO + 1 NC	Standard	3LD9280-5D	■	■	■	■	■
	Gold-plated	3LD9280-5DF	■	■	■	■	■	
Knob-operated mechanisms								
	<ul style="list-style-type: none"> Can be used as a replacement Lockable in 0 and 1 position with up to 3 padlocks 							
	Version	Article No.						
	Main control switches	3LD9283-2G	■	■	■	■	■	■
	EMERGENCY-STOP switches	3LD9283-4G	■	■	■	■	■	
Rotary operating mechanisms								
	<ul style="list-style-type: none"> Lockable in 0 position with up to 3 padlocks Only for 50/60 Hz applications 							
	Type	Version	Article No.					
	Main control switches	3P	3LD9224-1G	■	■	■		
			3LD9284-1G				■	■
		6P	3LD9284-1G		■	■	■	
	EMERGENCY-STOP switches	3P	3LD9224-3G	■	■	■		
		3LD9284-3G				■	■	
	6P	3LD9284-3G		■	■	■		
Terminal blocks								
	Version	Article No.						
	Through-type terminal with screw connection	8WH1000-0AF00	■	■	■	■	■	
Shield terminals								
	Terminal area	Article No.						
	3 ... 12 mm	3LD9228-1G	■	■	■	■	■	

Accessories for 3LD2 switch disconnectors in enclosure

				3LD20 (16 A)	3LD21 (25 A)	3LD22 (32 A)	3LD25 (63 A)	3LD27 (100 A)	3LD28 (125 A)		
Additional poles											
N switching contacts (4th contact element)											
	Contacts		Article No.								
	Leading switch-on, lagging switch-off		3LD9220-0C		■	■					
			3LD9250-0CA				■				
			3LD9280-0C					■		■	
N/PE terminals											
	Contacts		Article No.								
	Through-type		3LD9200-2C	■							
			3LD9220-2C		■	■					
			3LD9250-2CA				■				
			3LD9280-2C					■		■	
Auxiliary switches (standard version)											
											
	<ul style="list-style-type: none"> For mounting on the left and/or right Lagging switch-on, leading switch-off 										
	Contacts		Contact surface	Article No.							
	1 NO + 1 NC		Standard	3LD9200-5C	■	■	■	■	■	■	
			Gold-plated	3LD9200-5CF	■	■	■	■	■	■	
2 NO		Standard	3LD9200-6C	■	■	■	■	■	■		
Auxiliary switches for mounting on the front											
											
	<ul style="list-style-type: none"> Mounted on the front of the switch shaft For long leading times (20 ... 150 ms) 										
	Contacts		Contact surface	Article No.							
	1 NO + 1 NC		Standard	3LD9280-5D	■	■	■	■	■	■	
			Gold-plated	3LD9280-5DF	■	■	■	■	■	■	

8

				3LD20 (16 A)	3LD21 (25 A)	3LD22 (32 A)	3LD25 (63 A)	3LD27 (100 A)	3LD28 (125 A)	
Operating mechanisms										
Rotary operating mechanisms										
		<ul style="list-style-type: none"> Lockable in 0 position with up to 3 padlocks 								
	Type	Version	Article No.							
	Main control switches	3P, 3P+N	3LD9224-1GH ¹⁾	■	■	■				
			3LD9284-1G				■	■	■	
		6P	3LD9284-1G		■	■	■			
	EMERGENCY-STOP switches	3P, 3P+N	3LD9224-3GH ¹⁾	■	■	■				
			3LD9284-3G				■	■	■	
	6P	3LD9284-3G		■	■	■				

				3LD20 (16 A)	3LD21 (25 A)	3LD22 (32 A)	3LD25 (63 A)	3LD27 (100 A)	3LD28 (125 A)	
Connection technology										
Terminal blocks										
	Version	Article No.								
	Through-type terminal with screw connection	8WH1000-0AF00		■	■	■	■	■	■	
Shield terminals										
	Terminal area	Article No.								
	3 ...12 mm	3LD9228-1G		■	■	■	■	■	■	

¹⁾ Incl. enclosure cover

3LD switch disconnectors

System overview of 3LD5 UL main control and EMERGENCY-STOP switches

Basic units for front mounting



3LD5020 (3-pole)



3LD5020 (4-pole)



3LD5420 (3-pole)



3LD5420 (4-pole)

Basic units, floor mounting with direct operating mechanism



3LD5000 (3-pole)



3LD5000 (4-pole)



3LD5400 (3-pole)



3LD5400 (4-pole)

Basic units, floor mounting with door-coupling rotary operating mechanism



3LD5010 (3-pole)



3LD5010 (4-pole)



3LD5410 (3-pole)



3LD5410 (4-pole)

Additional poles and auxiliary switches



N switching contact



N/PE terminals (through-type)



Auxiliary switches (standard version)

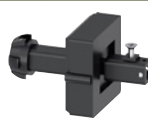


Auxiliary switch for mounting on the front

Operating mechanisms



Rotary operating mechanisms for four-hole mounting



Coupling heads with and without tolerance compensation



Supplementary handles for UL 508A/NFPA 79



Switch shafts

Further accessories



Terminal covers, 1-pole



Terminal covers, 3 and 4-pole

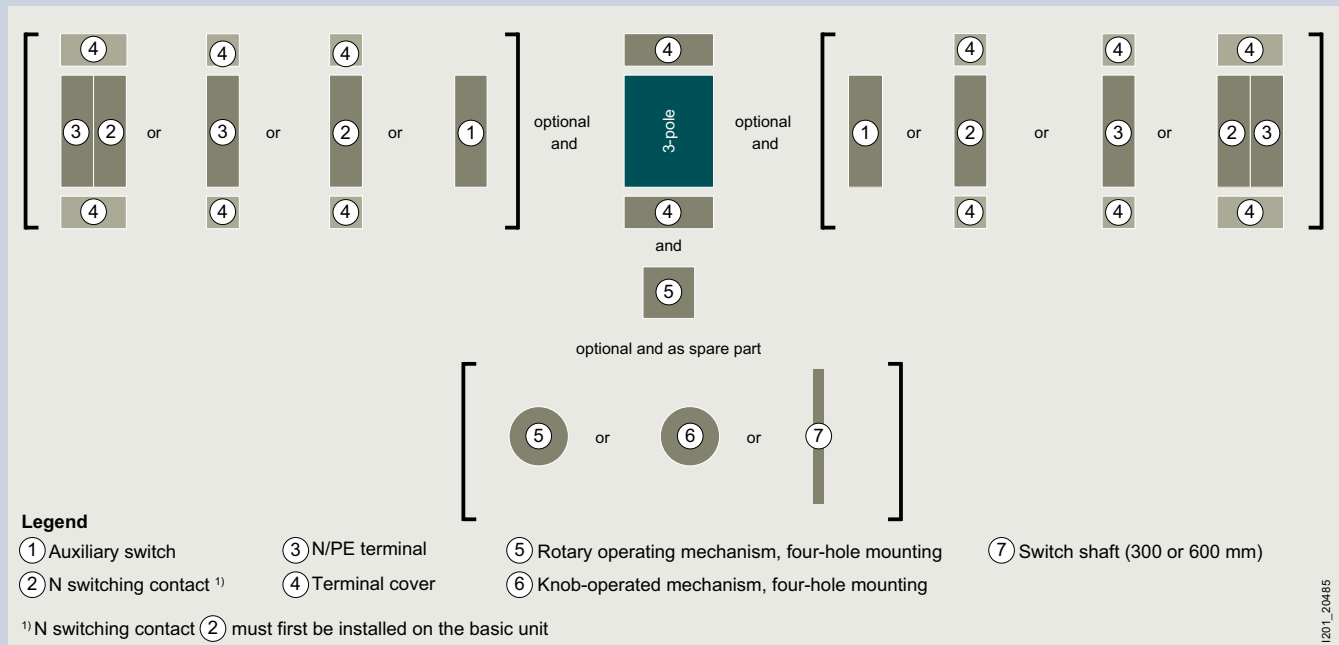


Inscription labels (with and without inscription)

Note:

You will find a detailed range of accessories with the basic units.

Mounting concept and accessories



Main control switches acc. to UL

The certification according to UL 489 makes the 3LD5 UL ideal for use as a main control switch for machinery and plants for export to the NAFTA states. The variety of accessories makes it especially suitable as a main disconnect switch for industrial machinery. The switch is also certified according to UL508 and can also be used as a manual motor controller.

Mounting types

Front mounting of basic units



The switches for front mounting are mounted on the inside of covers, side panels or, if applicable, control cabinet doors (depending on the applicable standard and switching function). Installation is achieved by 4-hole mounting of the handle. This switch is especially suitable when door interlocking is not required or is implemented in a different way.

Floor mounting with direct operating mechanism



The switches for floor mounting with direct operating mechanism up to 60 A are snapped onto 35 mm DIN rails according to EN 60715 or screw-mounted on mounting panels. The switches for 100 ... 160 A (3LD54 ... 3LD58) are exclusively screwed onto mounting panels.

Basic units, floor mounting with door-coupling rotary operating mechanism



The switches for floor mounting up to 30 A (3LD50) are snapped onto 35 mm DIN rails according to EN 60715 or screw-mounted on mounting panels. The switches for 100 to 160 A (3LD54 ... 3LD58) are exclusively screwed onto mounting panels. The actuators are connected to the lower section of the switch through a door coupling, which can be released in the 0 position, and a 300 mm long switch shaft. The rotary operating mechanisms are also defeatable, i.e. it is possible to open the control cabinet door with a deliberate action while the switch is in the ON position. To meet the requirement acc. to UL 508A/NFPA 79, a supplementary handle can be mounted on the switch. Combined with the intermediate handle, the shaft can no longer be removed.

3LD switch disconnectors

3LD5 UL main control and EMERGENCY-STOP switches,
front mounting, SCCR 50 - 65 kA

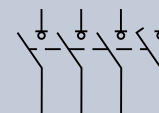
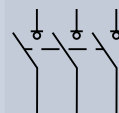


Operating mechanisms, black

Number of poles

3P

3P+N



Uninterrupted current I_u At AC-21A, 380 ... 440 V	General use acc. to UL 489/60947-4-1	Operational power P At AC-23A, 380 ... 440 V		
Rotary operating mechanism, four-hole mounting				
32	30	15	3LD5020-OTK11	3LD5020-OTL11
63	60	30	3LD5220-OTK11	3LD5220-OTL11
100	100	45	3LD5420-OTK11	3LD5420-OTL11
125	125	55	3LD5620-OTK11	3LD5620-OTL11
160	150	75	3LD5820-OTK11	3LD5820-OTL11

Scope of supply:

- Including terminal covers for the infeed side

Accessories for front mounting

3LD50 3LD52 3LD54 3LD56 3LD58

N switching contacts (4th contact element)

Contacts	Article No.					
		3LD50	3LD52	3LD54	3LD56	3LD58
Leading switch-on, lagging switch-off	3LD9250-0BA	■				
	3LD9280-0B		■			
	3LD9240-0B			■	■	■

N/PE terminals

Contacts	Article No.					
		3LD50	3LD52	3LD54	3LD56	3LD58
Through-type	3LD9250-2BA	■				
	3LD9280-2B		■			
	3LD9240-2B			■	■	■

Auxiliary switches (standard version)

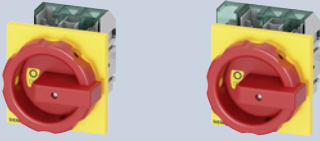
Contacts	Contact surface	Article No.					
			3LD50	3LD52	3LD54	3LD56	3LD58
1 NO + 1 NC	Standard	3LD9200-5B	■	■	■	■	■
	Gold-plated	3LD9200-5BF	■	■	■	■	■

Auxiliary switch for mounting on the front

Contacts	Contact surface	Article No.					
			3LD50	3LD52	3LD54	3LD56	3LD58
1 NO + 1 NC	Standard	3LD9280-5D	■	■			
		3LD9240-5D			■	■	■
	Gold-plated	3LD9280-5DF	■	■			
		3LD9240-5DF			■	■	■

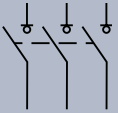
Rotary operating mechanisms

Version	Article No.					
		3LD50	3LD52	3LD54	3LD56	3LD58
For main control switches	3LD9284-1B	■	■			
For EMERGENCY-STOP switches	3LD9284-3B	■	■			

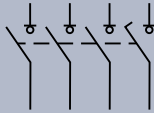


Operating mechanisms, red/yellow

3P



3P+N



3LD5020-OTK13	3LD5020-OTL13
3LD5220-OTK13	3LD5220-OTL13
3LD5420-OTK13	3LD5420-OTL13
3LD5620-OTK13	3LD5620-OTL13
3LD5820-OTK13	3LD5820-OTL13

3LD50 3LD52 3LD54 3LD56 3LD58

Knob-operated mechanisms



- Lockable in 0 position with up to 3 padlocks

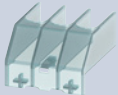
Version	Article No.	3LD50	3LD52	3LD54	3LD56	3LD58
For main control switches	3LD9243-1B			■	■	■
For EMERGENCY-STOP switches	3LD9243-3B			■	■	■

Terminal covers

- Pack of 4 units



Number of poles	Article No.	3LD50	3LD52	3LD54	3LD56	3LD58
1-pole	3LD9251-2A	■				
	3LD9281-2A		■			
	3LD9241-2A			■	■	■



3-pole	3LD9251-0A	■				
--------	------------	---	--	--	--	--

Inscription labels

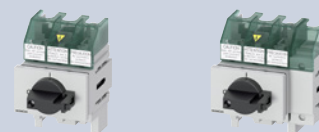


- Pack of 10 units

Inscription	Article No.	3LD50	3LD52	3LD54	3LD56	3LD58
German/English (Hauptschalter/Main Switch)	3LD9286-1A	■	■	■	■	■
Without inscription	3LD9286-4A	■	■	■	■	■

3LD switch disconnectors

3LD5 UL main control and EMERGENCY-STOP switches,
floor mounting with direct operating mechanism, SCCR 50 ... 65 kA

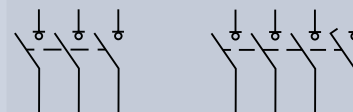


Operating mechanisms, black

Number of poles

3P

3P+N



Uninterrupted current I_u At AC-21A, 380 ... 440 V	General use acc. to UL 489/508	Operational power P At AC-23A, 380 ... 440 V		
Rotary operating mechanism, four-hole mounting				
32	30	15	3LD5000-0TK11	3LD5000-0TL11
63	60	30	3LD5200-0TK11	3LD5200-0TL11
100	100	45	3LD5400-0TK11	3LD5400-0TL11
125	125	55	3LD5600-0TK11	3LD5600-0TL11
160	150	75	3LD5800-0TK11	3LD5800-0TL11

Scope of supply:

- Including terminal covers for the infeed side

Accessories for floor mounting with direct operating mechanisms

3LD50 3LD52 3LD54 3LD56 3LD58

N switching contacts (4th contact element)



Contacts	Article No.	3LD50	3LD52	3LD54	3LD56	3LD58
Leading switch-on, lagging switch-off	3LD9250-0CA	■				
	3LD9280-0C		■			
	3LD9240-0C			■	■	■

N/PE terminals



Contacts	Article No.	3LD50	3LD52	3LD54	3LD56	3LD58
Through-type	3LD9250-2CA	■				
	3LD9280-2C		■			
	3LD9240-2C			■	■	■

Auxiliary switches

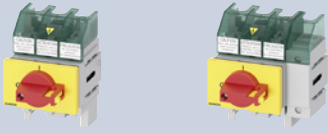


Contacts	Contact surface	Article No.	3LD50	3LD52	3LD54	3LD56	3LD58
1 NO + 1 NC	Standard	3LD9200-5C	■	■	■	■	■
	Gold-plated	3LD9200-5CF	■	■	■	■	■

Terminal covers

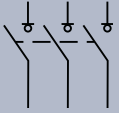
Number of poles	Article No.	3LD50	3LD52	3LD54	3LD56	3LD58
1-pole	3LD9251-2A	■				
	3LD9281-2A		■			
	3LD9241-2A			■	■	■
3-pole	3LD9251-0A	■				



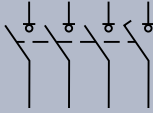


Operating mechanisms, red/yellow

3P



3P+N



3LD5000-0TK13

3LD5000-0TL13

3LD5200-0TK13

3LD5200-0TL13

3LD5400-0TK13

3LD5400-0TL13

3LD5600-0TK13

3LD5600-0TL13

3LD5800-0TK13

3LD5800-0TL13

3LD switch disconnectors

3LD5 UL main control and EMERGENCY-STOP switches,
floor mounting with door-coupling rotary operating mechanism, SCCR 50 ... 65 kA

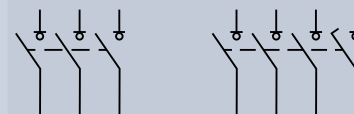


Operating mechanisms, black

Number of poles

3P

3P+N



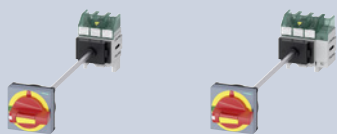
Uninterrupted current I_u At AC-21A, 380 ... 440 V	General use acc. to UL 489/508	Operational power P At AC-23A, 380 ... 440 V		
Rotary operating mechanism, four-hole mounting				
32	30	15	3LD5010-OTK11	3LD5010-OTL11
63	60	30	3LD5210-OTK11	3LD5210-OTL11
100	100	45	3LD5410-OTK11	3LD5410-OTL11
125	125	55	3LD5610-OTK11	3LD5610-OTL11
160	150	75	3LD5810-OTK11	3LD5810-OTL11

Scope of supply:

- Including terminal covers for the infeed side
- Defeatable door-coupling rotary operating mechanisms with shaft 300 mm
- Without tolerance compensation

Accessories for floor mounting with door-coupling rotary operating mechanism

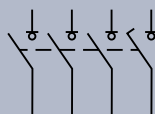
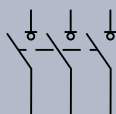
			3LD50	3LD52	3LD54	3LD56	3LD58
N switching contacts (4th contact element)							
	Contacts	Article No.					
	Leading switch-on, lagging switch-off	3LD9250-0CA	■				
		3LD9280-0C		■			
		3LD9240-0C			■	■	■
N/PE terminals							
	Contacts	Article No.					
	Through-type	3LD9250-2CA	■				
		3LD9280-2C		■			
		3LD9240-2C			■	■	■
Auxiliary switches (standard version)							
	<ul style="list-style-type: none"> • For mounting on the left and/or right • Lagging switch-on, leading switch-off 						
	Contacts	Contact surface	Article No.				
	1 NO + 1 NC	Standard	3LD9200-5C	■	■	■	■
		Gold-plated	3LD9200-5CF	■	■	■	■
Auxiliary switch for mounting on the front							
	<ul style="list-style-type: none"> • Mounted on the front of the switch shaft • For long leading times (20 ... 150 ms) 						
	Contacts	Contact surface	Article No.				
	1 NO + 1 NC	Standard	3LD9280-5D	■	■		
			3LD9240-5D			■	■
		Gold-plated	3LD9280-5DF	■	■		
			3LD9240-5DF			■	■
Handles							
	<ul style="list-style-type: none"> • Supplied with a masking plate, but without an extension shaft or coupling driver • Can be locked with up to max. 3 padlocks 						
	Inscription	Color	Article No.				
	O-I	Gray	8UD1771-2AD01	■	■		
			8UD1731-2AD01			■	■
		Red/yellow	8UD1771-2AD05	■	■		
			8UD1731-2AD05			■	■




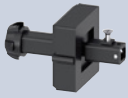
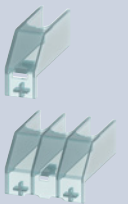


Operating mechanisms, red/yellow

3P

3P+N



3LD5010-OTK13	3LD5010-OTL13
3LD5210-OTK13	3LD5210-OTL13
3LD5410-OTK13	3LD5410-OTL13
3LD5610-OTK13	3LD5610-OTL13
3LD5810-OTK13	3LD5810-OTL13

		3LD50	3LD52	3LD54	3LD56	3LD58	
Supplementary handles for door-coupling rotary operating mechanism							
 <ul style="list-style-type: none"> For requirements according to UL 508A/NFPA 79 Can be locked with up to 1 padlocks in 0 position Can only be switched on by deliberate action 	Inscription	Color	Article No.				
	O-I	Gray	3LD9287-1C	■	■		
		Red/yellow	3LD9247-1C			■	■
			3LD9287-3C	■	■		
		3LD9247-3C			■	■	
Coupling drivers							
	Version	Article No.					
	With tolerance compensation	8UD1900-1GA00	■	■			
		8UD1900-2GA00			■	■	
	Without tolerance compensation	8UD1900-1HA00	■	■			
		8UD1900-2HA00			■	■	
Terminal covers							
 <ul style="list-style-type: none"> Pack of 4 units 	Number of poles	Article No.					
	1-pole	3LD9251-2A	■				
		3LD9281-2A		■			
		3LD9241-2A			■	■	
	3-pole	3LD9251-0A	■				
Inscription labels							
 <ul style="list-style-type: none"> Pack of 10 units 	Inscription	Article No.					
	German/English (Hauptschalter/Main Switch)	3LD9286-1A	■	■	■	■	
	Without inscription	3LD9286-4A	■	■	■	■	
Switch shafts							
	Cross-section	Length	Article No.				
	6 × 6 mm	300 mm	3LD9205-0C	■	■		
		600 mm	3LD9205-2C	■	■		
	8 × 8 mm	300 mm	3LD9245-0C			■	
		600 mm	3LD9245-2C			■	

3LD switch disconnectors

Accessories for 3LD5 UL main control and EMERGENCY-STOP switches

Additional poles

3LD50 3LD52 3LD54 3LD56 3LD58

N switching contacts (4th contact element) for front mounting



Contacts	Article No.	3LD50	3LD52	3LD54	3LD56	3LD58
Leading switch-on, lagging switch-off	3LD9250-0BA	■				
	3LD9280-0B		■			
	3LD9240-0B			■	■	■

N switching contacts (4th contact element) for floor mounting



Contacts	Article No.	3LD50	3LD52	3LD54	3LD56	3LD58
Leading switch-on, lagging switch-off	3LD9250-0CA	■				
	3LD9280-0C		■			
	3LD9240-0C			■	■	■

N/PE terminals for front mounting



Contacts	Article No.	3LD50	3LD52	3LD54	3LD56	3LD58
Through-type	3LD9250-2BA	■				
	3LD9280-2B		■			
	3LD9240-2B			■	■	■

N/PE terminals for floor mounting



Contacts	Article No.	3LD50	3LD52	3LD54	3LD56	3LD58
Through-type	3LD9250-2CA	■				
	3LD9280-2C		■			
	3LD9240-2C			■	■	■

Auxiliary switches (standard version) for front mounting



Contacts	Contact surface	Article No.	3LD50	3LD52	3LD54	3LD56	3LD58
1 NO + 1 NC	Standard	3LD9200-5B	■	■	■	■	■
	Gold-plated	3LD9200-5BF	■	■	■	■	■

Auxiliary switches (standard version) for floor mounting







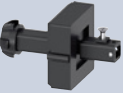
Contacts	Contact surface	Article No.	3LD50	3LD52	3LD54	3LD56	3LD58
1 NO + 1 NC	Standard	3LD9200-5C	■	■	■	■	■
	Gold-plated	3LD9200-5CF	■	■	■	■	■

Auxiliary switch for mounting on the front



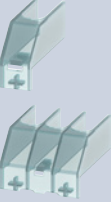


Contacts	Contact surface	Article No.	3LD50	3LD52	3LD54	3LD56	3LD58
1 NO + 1 NC	Standard	3LD9280-5D	■	■			
		3LD9240-5D			■	■	■
	Gold-plated	3LD9280-5DF	■	■			
		3LD9240-5DF			■	■	■

Operating mechanisms

			3LD50	3LD52	3LD54	3LD56	3LD58
Rotary operating mechanism for front mounting							
	• Lockable in 0 position with up to 3 padlocks						
	Version	Article No.					
	For main control switches	3LD9284-1B	■	■			
	For EMERGENCY-STOP switches	3LD9284-3B	■	■			
Knob-operated mechanism for front mounting							
	• Lockable in 0 position with up to 3 padlocks						
	Version	Article No.					
	For main control switches	3LD9243-1B			■	■	■
	For EMERGENCY-STOP switches	3LD9243-3B			■	■	■
Handles for floor mounting							
	• Supplied with a masking plate, but without an extension shaft or coupling driver						
	• Can be locked with up to max. 3 padlocks						
	Inscription	Color	Article No.				
	O-I	Gray	8UD1771-2AD01	■	■		
			8UD1731-2AD01			■	■
		Red/yellow	8UD1771-2AD05	■	■		
			8UD1731-2AD05			■	■
Supplementary handles for floor mounting for door-coupling rotary operating mechanism							
	• For requirements according to UL 508A/NFPA 79						
	• Can be locked with up to 1 padlock in 0 position						
	• Can only be switched on by deliberate action						
	Inscription	Color	Article No.				
	O-I	Gray	3LD9287-1C	■	■		
			3LD9247-1C			■	■
		Red/yellow	3LD9287-3C	■	■		
			3LD9247-3C			■	■
Coupling drivers for floor mounting with door-coupling rotary operating mechanism							
	Version	Article No.					
	With tolerance compensation	8UD1900-1GA00	■	■			
		8UD1900-2GA00			■	■	■
	Without tolerance compensation	8UD1900-1HA00	■	■			
		8UD1900-2HA00			■	■	■

8

Further accessories

			3LD50	3LD52	3LD54	3LD56	3LD58
Terminal covers							
	• Pack of 4 units						
	Number of poles	Article No.					
	1-pole	3LD9251-2A	■				
		3LD9281-2A		■			
		3LD9241-2A			■	■	■
	3-pole	3LD9251-0A	■				
Inscription labels							
	• Pack of 10 units						
	Inscription	Article No.					
	German/English (Hauptschalter/Main Switch)	3LD9286-1A	■	■	■	■	■
	Without inscription	3LD9286-4A	■	■	■	■	■
Switch shafts							
	Cross-section	Length	Article No.				
	6 × 6 mm	300 mm	3LD9205-0C	■	■		
		600 mm	3LD9205-2C	■	■		
	8 × 8 mm	300 mm	3LD9245-0C			■	■
		600 mm	3LD9245-2C			■	■

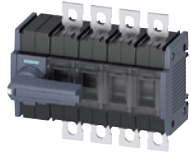
3KD switch disconnectors

System overview

Complete units with direct operating mechanisms



Front operating mechanisms, 3-pole



Front operating mechanisms, 4-pole



Front operating mechanisms, 3-pole



Front operating mechanisms, 4-pole

Basic units



Front operating mechanisms, 3-pole



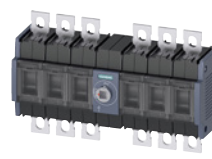
Front operating mechanisms, 4-pole



Lateral operating mechanisms, 3-pole



Lateral operating mechanisms, 4-pole



Front-mounted devices, 6-pole for DC applications



Front operating mechanisms, 3-pole

8

Additional poles and auxiliary switch modules



4th contact elements



N terminals



N/PE terminals



Auxiliary switch modules

Operating mechanisms



Direct operating mechanisms



Door-coupling rotary operating mechanisms



Handles for door-coupling rotary operating mechanisms



Further accessories for door-coupling rotary operating mechanisms

Further accessories and spare parts



Auxiliary switches



Terminal covers



Phase barriers



Blocking pin test function



Mounting elements



Accessories for DC applications

Note:

You will find a detailed range of accessories with the basic units.

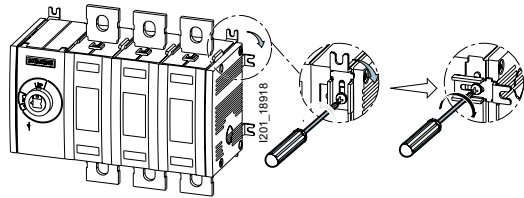


Types of mounting



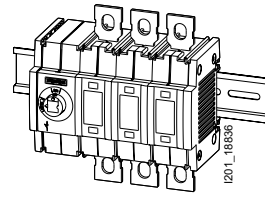
You will find further information under:
sie.ag/2UlrAvy

Floor mounting



All 3KD switch disconnectors are designed for floor mounting. To ensure that the switch can be flexibly adapted to the relevant installation conditions, the mounting bracket can be rotated through 90° with size 3 or larger.

DIN rail

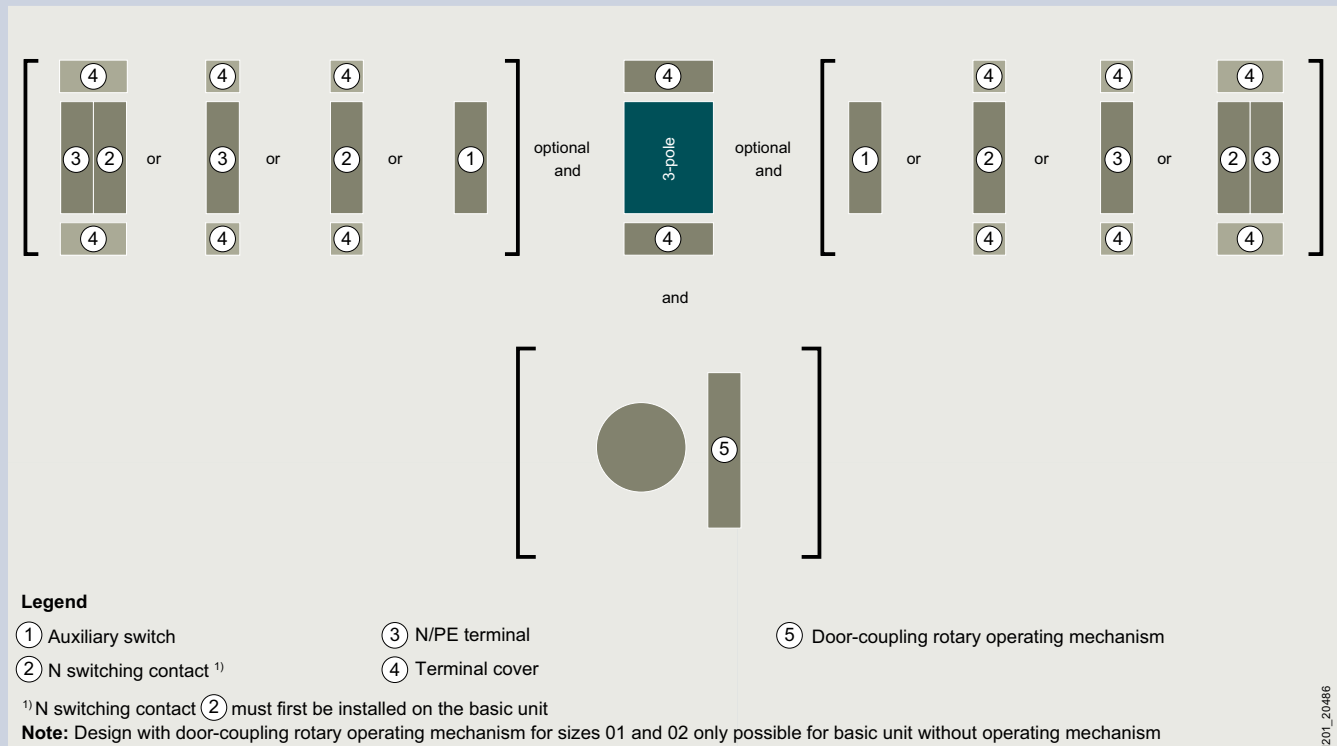


Sizes 01 and 02 of the 3KD0 and sizes 1 and 2 of the 3KD can be snapped onto a DIN rail (TH35 according to EN 60715) as an alternative mounting method.

3KD switch disconnectors

Mounting concept and accessories

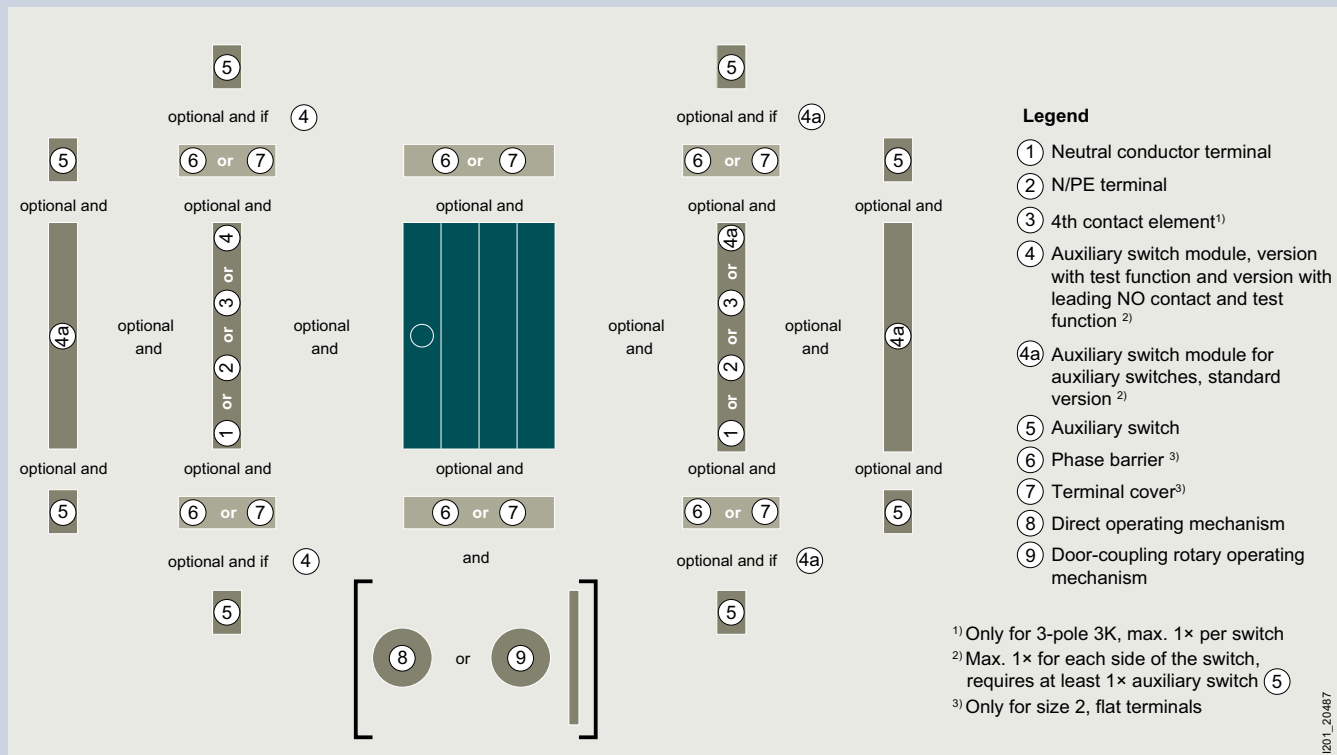
Front operating mechanism center, sizes 01 and 02



I201_20486

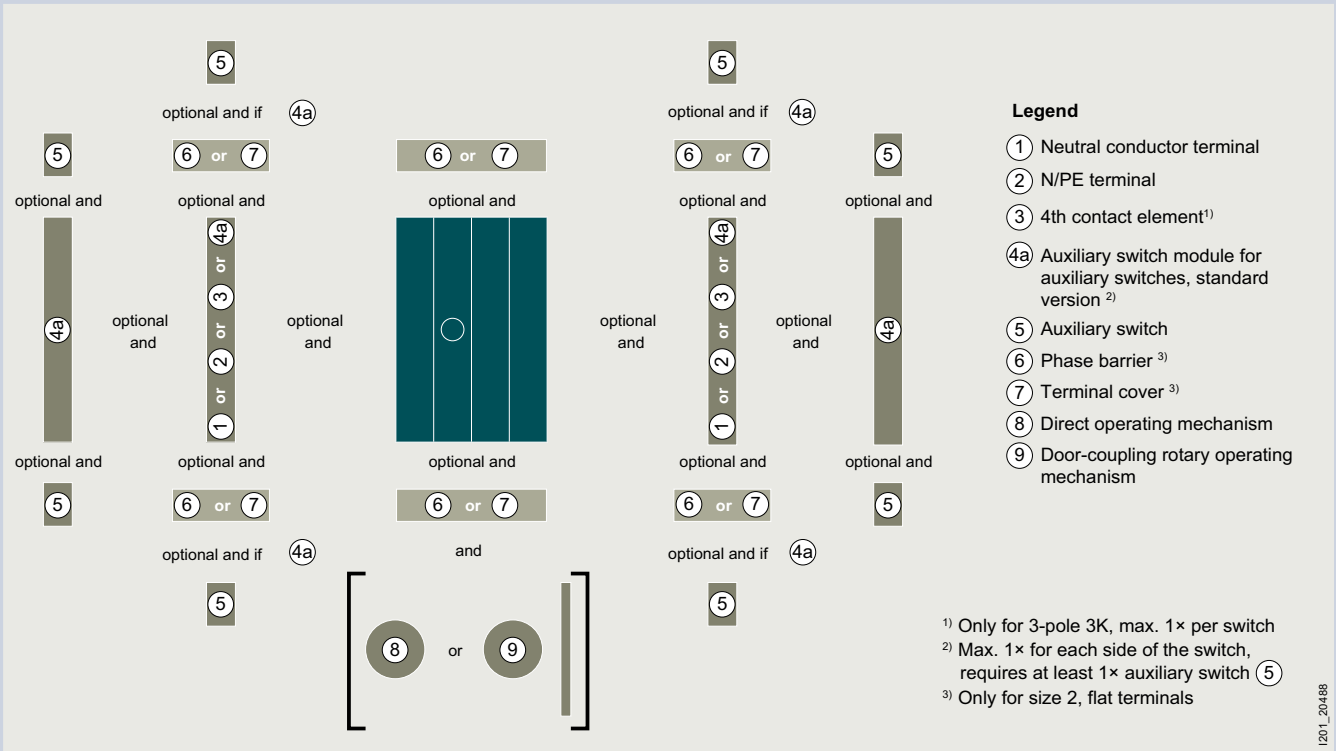
8

Front operating mechanism left, sizes 1 and 2, 3/4-pole

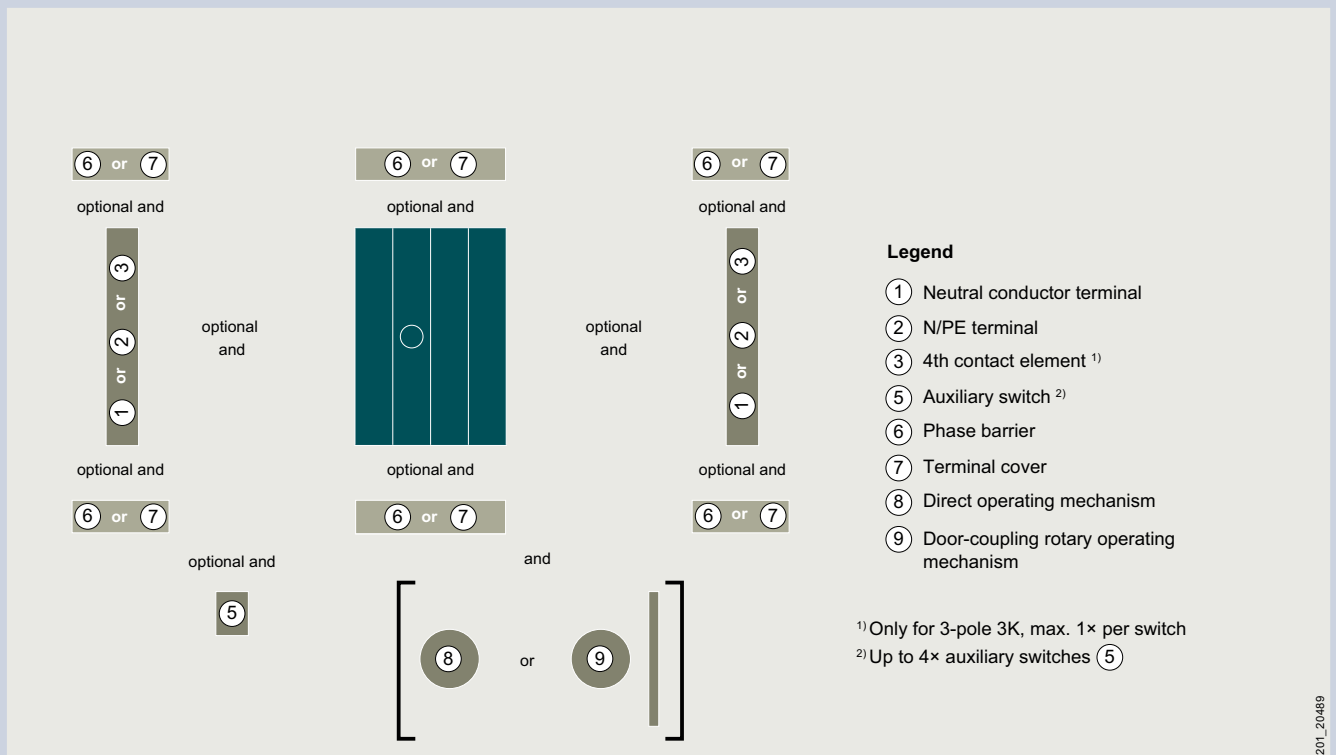


I201_20487

Front operating mechanism center, sizes 1 and 2, 3/4-pole



Front operating mechanism center or left, sizes 3 to 5, 3/4-pole



3KD switch disconnectors

Mounting concept and accessories

Lateral operating mechanism left, sizes 1 and 2, 3/4-pole

Legend

- ① Neutral conductor terminal
- ② N/PE terminal
- ③ 4th contact element ¹⁾
- ④a Auxiliary switch module for auxiliary switches, standard version ²⁾
- ⑤ Auxiliary switch
- ⑥ Phase barrier ³⁾
- ⑦ Terminal cover ³⁾
- ⑨ Door-coupling rotary operating mechanism

¹⁾ Only for 3-pole 3K
²⁾ Max. 1× per switch, Requires at least 1× auxiliary switch ⑤
³⁾ Only for size 2, flat terminals

I201_20490

Lateral operating mechanism left, sizes 3 to 5, 3/4-pole

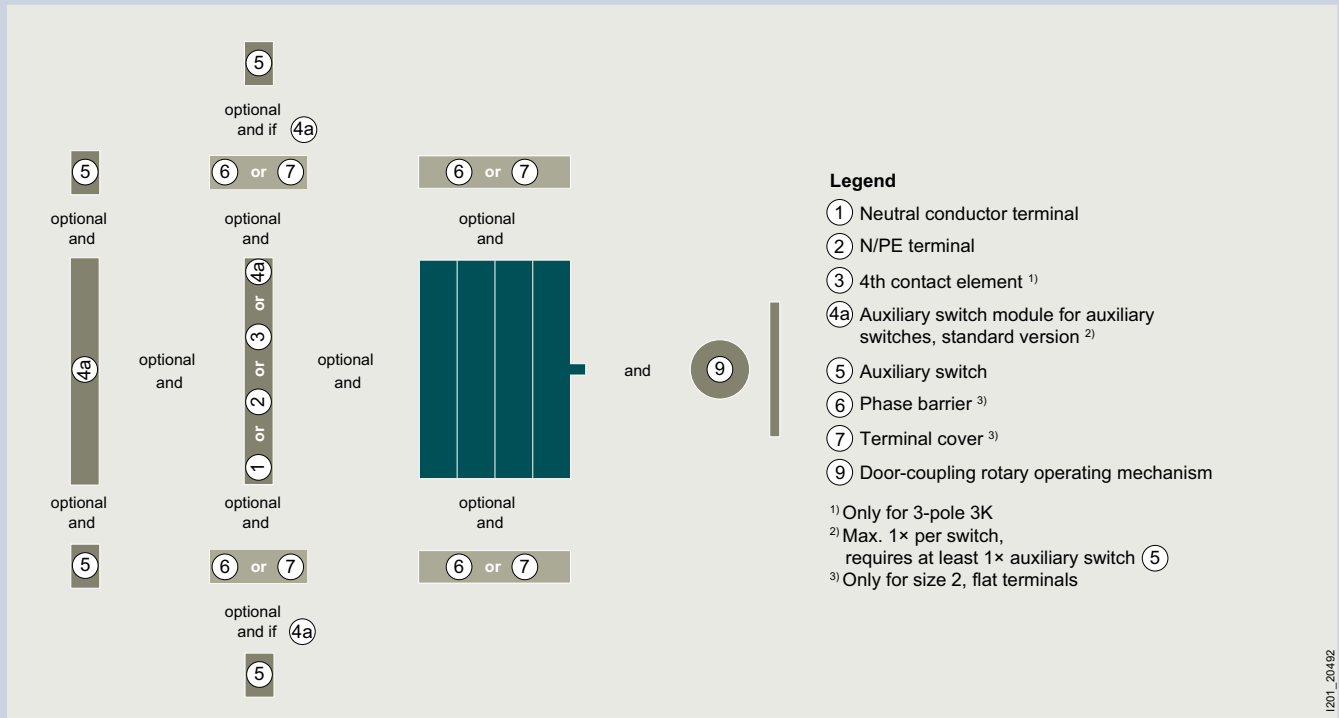
Legend

- ① Neutral conductor terminal
- ② N/PE terminal
- ③ 4th contact element ¹⁾
- ⑤ Auxiliary switch ²⁾
- ⑥ Phase barrier
- ⑦ Terminal cover
- ⑨ Door-coupling rotary operating mechanism

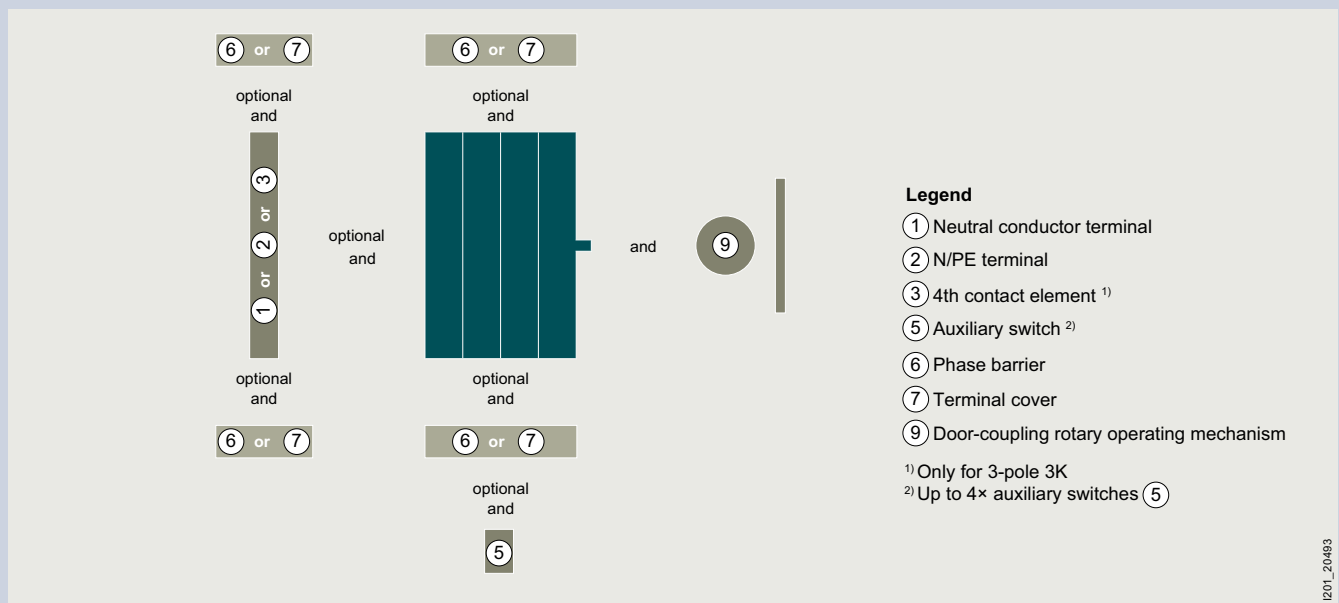
¹⁾ Only for 3-pole 3K
²⁾ Up to 4× auxiliary switches

I201_20491

Lateral operating mechanism right, sizes 1 and 2, 3/4-pole

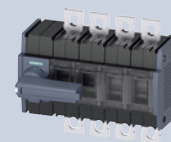
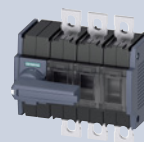
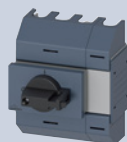


Lateral operating mechanism right, sizes 3 to 5, 3/4-pole



3KD switch disconnectors

Complete units with direct operating mechanisms



Application	Operating mechanism, gray Front operating mechanism center		Operating mechanism, gray Front operating mechanism left	
	AC	AC	AC/DC	AC/DC
Number of poles	3P	4P	3P	4P

Size	Uninterrupted current I_u				
Box terminals					
01	16 A	3KD0132-2KG20-3	3KD0142-2KG20-3	–	–
	32 A	3KD0232-2KG20-3	3KD0242-2KG20-3	–	–
	63 A	3KD0332-2KG20-3	–	–	–
02	63 A	3KD0332-2LG20-3	3KD0342-2LG20-3	–	–
	80 A	3KD0432-2LG20-3	3KD0442-2LG20-3	–	–
	100 A	3KD0532-2LG20-3	3KD0542-2LG20-3	–	–
	125 A	3KD0632-2LG20-3	3KD0642-2LG20-3	–	–
1	16 A	–	–	3KD1632-2ME10-0	3KD1642-2ME10-0
	32 A	–	–	3KD2232-2ME10-0	3KD2242-2ME10-0
	63 A	–	–	3KD2632-2ME10-0	3KD2642-2ME10-0
	80 A	–	–	3KD2832-2ME10-0	3KD2842-2ME10-0
	100 A	–	–	3KD3032-2ME10-0	3KD3042-2ME10-0
2	80 A	–	–	3KD2832-2NE10-0	3KD2842-2NE10-0
	100 A	–	–	3KD3032-2NE10-0	3KD3042-2NE10-0
	125 A	–	–	3KD3232-2NE10-0	3KD3242-2NE10-0
	160 A	–	–	3KD3432-2NE10-0	3KD3442-2NE10-0
Flat terminals					
2	80 A	–	–	3KD2832-0NE10-0	3KD2842-0NE10-0
	100 A	–	–	3KD3032-0NE10-0	3KD3042-0NE10-0
	125 A	–	–	3KD3232-0NE10-0	3KD3242-0NE10-0
	160 A	–	–	3KD3432-0NE10-0	3KD3442-0NE10-0
	200 A	–	–	3KD3632-0NE10-0	3KD3642-0NE10-0
	250 A	–	–	3KD3832-0NE10-0	3KD3842-0NE10-0
3	200 A	–	–	3KD3632-0PE10-0	3KD3642-0PE10-0
	250 A	–	–	3KD3832-0PE10-0	3KD3842-0PE10-0
	315 A	–	–	3KD4032-0PE10-0	3KD4042-0PE10-0
	400 A	–	–	3KD4232-0PE10-0	3KD4242-0PE10-0
	500 A	–	–	3KD4432-0PE10-0	3KD4442-0PE10-0
4	500 A	–	–	3KD4432-0QE10-0	3KD4442-0QE10-0
	630 A	–	–	3KD4632-0QE10-0	3KD4642-0QE10-0
	800 A	–	–	3KD4832-0QE10-0	3KD4842-0QE10-0
	1000 A	–	–	3KD5032-0QE10-0	3KD5042-0QE10-0
5	1000 A	–	–	3KD5032-0RE10-0	3KD5042-0RE10-0
	1250 A	–	–	3KD5232-0RE10-0	3KD5242-0RE10-0
	1600 A	–	–	3KD5432-0RE10-0	3KD5442-0RE10-0
	2000 A	–	–	3KD5632-0RE10-0	3KD5642-0RE10-0

Scope of supply:

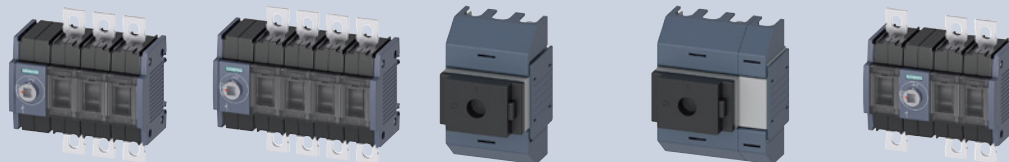
- Incl. terminal covers on input and output side for 3KD0 sizes 01 and 02
- Incl. phase barriers on the input and output side for size 2 with flat terminals
- Terminal covers must be ordered separately for switch disconnectors with flat terminals and direct operating mechanisms

Mounting:

- The switch disconnectors are designed for floor mounting and the sizes 01, 02, 1 and 2 can optionally also be mounted on DIN rails

3KD switch disconnectors

Basic units without handles



Application	Front operating mechanism Left		Front operating mechanism Center			
	AC/DC	AC/DC	AC	AC	AC/DC	
Number of poles	3P	4P	3P	4P	3P	
Size	Uninterrupted current I_u					
Box terminals						
01	16 A	–	–	3KD0130-2KG20-3	3KD0140-2KG20-3	–
	32 A	–	–	3KD0230-2KG20-3	3KD0240-2KG20-3	–
	63 A	–	–	3KD0330-2KG20-3	–	–
02	63 A	–	–	3KD0330-2LG20-3	3KD0340-2LG20-3	–
	80 A	–	–	3KD0430-2LG20-3	3KD0440-2LG20-3	–
	100 A	–	–	3KD0530-2LG20-3	3KD0540-2LG20-3	–
	125 A	–	–	3KD0630-2LG20-3	3KD0640-2LG20-3	–
1	16 A	3KD1630-2ME10-0	3KD1640-2ME10-0	–	–	3KD1630-2ME20-0
	32 A	3KD2230-2ME10-0	3KD2240-2ME10-0	–	–	3KD2230-2ME20-0
	63 A	3KD2630-2ME10-0	3KD2640-2ME10-0	–	–	3KD2630-2ME20-0
	80 A	3KD2830-2ME10-0	3KD2840-2ME10-0	–	–	3KD2830-2ME20-0
	100 A	3KD3030-2ME10-0	3KD3040-2ME10-0	–	–	3KD3030-2ME20-0
2	80 A	3KD2830-2NE10-0	3KD2840-2NE10-0	–	–	3KD2830-2NE20-0
	100 A	3KD3030-2NE10-0	3KD3040-2NE10-0	–	–	3KD3030-2NE20-0
	125 A	3KD3230-2NE10-0	3KD3240-2NE10-0	–	–	3KD3230-2NE20-0
	160 A	3KD3430-2NE10-0	3KD3440-2NE10-0	–	–	3KD3430-2NE20-0
Flat terminals						
2	80 A	3KD2830-0NE10-0	3KD2840-0NE10-0	–	–	3KD2830-0NE20-0
	100 A	3KD3030-0NE10-0	3KD3040-0NE10-0	–	–	3KD3030-0NE20-0
	125 A	3KD3230-0NE10-0	3KD3240-0NE10-0	–	–	3KD3230-0NE20-0
	160 A	3KD3430-0NE10-0	3KD3440-0NE10-0	–	–	3KD3430-0NE20-0
	200 A	3KD3630-0NE10-0	3KD3640-0NE10-0	–	–	3KD3630-0NE20-0
	250 A	3KD3830-0NE10-0	3KD3840-0NE10-0	–	–	3KD3830-0NE20-0
3	200 A	3KD3630-0PE10-0	3KD3640-0PE10-0	–	–	3KD3630-0PE20-0
	250 A	3KD3830-0PE10-0	3KD3840-0PE10-0	–	–	3KD3830-0PE20-0
	315 A	3KD4030-0PE10-0	3KD4040-0PE10-0	–	–	3KD4030-0PE20-0
	400 A	3KD4230-0PE10-0	3KD4240-0PE10-0	–	–	3KD4230-0PE20-0
	500 A	3KD4430-0PE10-0	3KD4440-0PE10-0	–	–	3KD4430-0PE20-0
4	500 A	3KD4430-0QE10-0	3KD4440-0QE10-0	–	–	3KD4430-0QE20-0
	630 A	3KD4630-0QE10-0	3KD4640-0QE10-0	–	–	3KD4630-0QE20-0
	800 A	3KD4830-0QE10-0	3KD4840-0QE10-0	–	–	3KD4830-0QE20-0
	1000 A	3KD5030-0QE10-0	3KD5040-0QE10-0	–	–	3KD5030-0QE20-0
5	1000 A	3KD5030-0RE10-0	3KD5040-0RE10-0	–	–	3KD5030-0RE20-0
	1250 A	3KD5230-0RE10-0	3KD5240-0RE10-0	–	–	3KD5230-0RE20-0
	1600 A	3KD5430-0RE10-0	3KD5440-0RE10-0	–	–	3KD5430-0RE20-0
	2000 A	3KD5630-0RE10-0	3KD5640-0RE10-0	–	–	3KD5630-0RE20-0

Scope of supply:

- Incl. terminal covers on input and output side for 3KD0 sizes 01 and 02
- Incl. phase barriers on the input and output side for size 2 with flat terminals
- Terminal covers must be ordered separately for switch disconnectors with flat terminals and direct operating mechanisms

Mounting:

- The switch disconnectors are designed for floor mounting and the sizes 01, 02, 1 and 2 can optionally also be mounted on DIN rails



Front operating mechanism Center		Lateral operating mechanism Left		Right	
AC/DC	DC	AC/DC	AC/DC	AC/DC	AC/DC
4P	6P	3P	4P	3P	4P
–	–	–	–	–	–
–	–	–	–	–	–
–	–	–	–	–	–
–	–	–	–	–	–
–	–	–	–	–	–
–	–	–	–	–	–
3KD1640-2ME20-0	3KD1660-2ME20-0	3KD1634-2ME10-0	3KD1644-2ME10-0	3KD1634-2ME40-0	3KD1644-2ME40-0
3KD2240-2ME20-0	3KD2260-2ME20-0	3KD2234-2ME10-0	3KD2244-2ME10-0	3KD2234-2ME40-0	3KD2244-2ME40-0
3KD2640-2ME20-0	3KD2660-2ME20-0	3KD2634-2ME10-0	3KD2644-2ME10-0	3KD2634-2ME40-0	3KD2644-2ME40-0
3KD2840-2ME20-0	–	3KD2834-2ME10-0	3KD2844-2ME10-0	3KD2834-2ME40-0	3KD2844-2ME40-0
3KD3040-2ME20-0	–	3KD3034-2ME10-0	3KD3044-2ME10-0	3KD3034-2ME40-0	3KD3044-2ME40-0
3KD2840-2NE20-0	3KD2860-2NE20-0	3KD2834-2NE10-0	3KD2844-2NE10-0	3KD2834-2NE40-0	3KD2844-2NE40-0
3KD3040-2NE20-0	3KD3060-2NE20-0	3KD3034-2NE10-0	3KD3044-2NE10-0	3KD3034-2NE40-0	3KD3044-2NE40-0
3KD3240-2NE20-0	3KD3260-2NE20-0	3KD3234-2NE10-0	3KD3244-2NE10-0	3KD3234-2NE40-0	3KD3244-2NE40-0
3KD3440-2NE20-0	3KD3460-2NE20-0	3KD3434-2NE10-0	3KD3444-2NE10-0	3KD3434-2NE40-0	3KD3444-2NE40-0
3KD2840-0NE20-0	3KD2860-0NE20-0	3KD2834-0NE10-0	3KD2844-0NE10-0	3KD2834-0NE40-0	3KD2844-0NE40-0
3KD3040-0NE20-0	3KD3060-0NE20-0	3KD3034-0NE10-0	3KD3044-0NE10-0	3KD3034-0NE40-0	3KD3044-0NE40-0
3KD3240-0NE20-0	3KD3260-0NE20-0	3KD3234-0NE10-0	3KD3244-0NE10-0	3KD3234-0NE40-0	3KD3244-0NE40-0
3KD3440-0NE20-0	3KD3460-0NE20-0	3KD3434-0NE10-0	3KD3444-0NE10-0	3KD3434-0NE40-0	3KD3444-0NE40-0
3KD3640-0NE20-0	–	3KD3634-0NE10-0	3KD3644-0NE10-0	3KD3634-0NE40-0	3KD3644-0NE40-0
3KD3840-0NE20-0	–	3KD3834-0NE10-0	3KD3844-0NE10-0	3KD3834-0NE40-0	3KD3844-0NE40-0
3KD3640-0PE20-0	3KD3660-0PE20-0	3KD3634-0PE10-0	3KD3644-0PE10-0	3KD3634-0PE40-0	3KD3644-0PE40-0
3KD3840-0PE20-0	3KD3860-0PE20-0	3KD3834-0PE10-0	3KD3844-0PE10-0	3KD3834-0PE40-0	3KD3844-0PE40-0
3KD4040-0PE20-0	3KD4060-0PE20-0	3KD4034-0PE10-0	3KD4044-0PE10-0	3KD4034-0PE40-0	3KD4044-0PE40-0
3KD4240-0PE20-0	3KD4260-0PE20-0	3KD4234-0PE10-0	3KD4244-0PE10-0	3KD4234-0PE40-0	3KD4244-0PE40-0
3KD4440-0PE20-0	–	3KD4434-0PE10-0	3KD4444-0PE10-0	3KD4434-0PE40-0	3KD4444-0PE40-0
3KD4440-0QE20-0	3KD4460-0QE20-0	3KD4434-0QE10-0	3KD4444-0QE10-0	3KD4434-0QE40-0	3KD4444-0QE40-0
3KD4640-0QE20-0	3KD4660-0QE20-0	3KD4634-0QE10-0	3KD4644-0QE10-0	3KD4634-0QE40-0	3KD4644-0QE40-0
3KD4840-0QE20-0	3KD4860-0QE20-0	3KD4834-0QE10-0	3KD4844-0QE10-0	3KD4834-0QE40-0	3KD4844-0QE40-0
3KD5040-0QE20-0	–	3KD5034-0QE10-0	3KD5044-0QE10-0	3KD5034-0QE40-0	3KD5044-0QE40-0
3KD5040-0RE20-0	3KD5060-0RE20-0	3KD5034-0RE10-0	3KD5044-0RE10-0	3KD5034-0RE40-0	3KD5044-0RE40-0
3KD5240-0RE20-0	3KD5260-0RE20-0	3KD5234-0RE10-0	3KD5244-0RE10-0	3KD5234-0RE40-0	3KD5244-0RE40-0
3KD5440-0RE20-0	3KD5460-0RE20-0	3KD5434-0RE10-0	3KD5444-0RE10-0	3KD5434-0RE40-0	3KD5444-0RE40-0
3KD5640-0RE20-0	–	3KD5634-0RE10-0	3KD5644-0RE10-0	3KD5634-0RE40-0	3KD5644-0RE40-0

Note:

- The complete units with a direct operating mechanism are not suitable for conversion to door-coupling rotary operating mechanisms; the basic units are to be used for this purpose
- All basic units without handles are suitable for use with door-coupling rotary operating mechanisms, from size 1 to size 5 these can also be equipped with direct operating mechanisms
- The switch disconnectors with lateral operating mechanism are suitable for door-coupling rotary operating mechanisms
- For 3KD switch disconnectors and lateral operating mechanism (left or right), only 8UD door-coupling rotary operating mechanisms without the test function can be used







3KD switch disconnectors

Accessories





Additional poles

Note:

- Additional poles (4th contact element, N or N/PE terminal) must always be mounted directly adjacent to the switch disconnector on the left or right. Accordingly, an auxiliary switch module must not be mounted between the basic unit and an additional pole on sizes 1 and 2.
- For installation, it is important to note that only a 3-pole 3KD switch disconnector may be retrofitted with an additional switching pole with contact system (4th contact element).

		Size 01	Size 02	Size 1	Size 2	Size 3	Size 4	Size 5
4th contact elements (switching pole)								
<ul style="list-style-type: none"> For upgrading a 3-pole to a 4-pole switch disconnector For sizes 1 to 5, identical to the factory-fitted poles For sizes 01 and 02, leading switch-on, lagging switch-off Sizes 01 and 02 equipped at the factory with terminal covers for the input and output side. 								
Connection		Article No.						
 Box terminals N ———— α ———— N	3KD9015-2	■						
	3KD9025-2		■					
	3KD9105-2			■				
	3KD9205-2				■			
 Flat terminals N ———— α ———— N	3KD9205-0				■			
	3KD9305-0					■		
	3KD9405-0						■	
	3KD9505-0							■
N terminals (neutral conductor terminal) with removable jumper								
<ul style="list-style-type: none"> A jumper can be removed in order to interrupt the electrical connection between the terminals 								
Connection		Article No.						
 Box terminals ———— ● ———— ● ————	3KD9106-2			■				
	3KD9206-2				■			
 Flat terminals ———— ● ———— ● ————	3KD9206-0				■			
	3KD9306-0					■		
	3KD9406-0						■	
	3KD9506-0							■
N/PE terminals with permanent jumper								
<ul style="list-style-type: none"> Permanent electrical connection between the terminals, cannot be broken 								
Connection		Article No.						
 Box terminals ———— ————	3KD9016-8	■						
	3KD9026-8		■					
	3KD9106-8			■				
	3KD9206-8				■			
 Flat terminals ———— ————	3KD9206-7				■			
	3KD9306-7					■		
	3KD9406-7						■	
	3KD9506-7							■

Operating mechanisms

					Size 01	Size 02	Size 1	Size 2	Size 3	Size 4	Size 5		
Direct operating mechanisms, standard version													
<ul style="list-style-type: none"> Can be locked with up to max. 3 padlocks Requires additional mounting depth in locked state Not suitable for basic units with a lateral operating mechanism 													
	Inscription	Color	Article No.										
	Test-O-I	Gray	3KD9101-1				■						
			3KD9201-1					■					
			3KD9301-1							■			
			3KD9401-1									■	
			3KD9501-1										■
	Red/yellow	Red/yellow	3KD9101-2				■						
			3KD9201-2					■					
			3KD9301-2							■			
			3KD9401-2									■	
3KD9501-2											■		
Direct operating mechanisms, flat version													
<ul style="list-style-type: none"> Suitable for distribution boards and only basic units with a front operating mechanism Can be locked with one padlock No additional mounting depth in locked state 													
	Inscription	Color	Article No.										
	Test-O-I	Gray	3KD9101-0				■						
			3KD9201-0					■					
	Red/yellow	Red/yellow	3KD9101-8				■						
3KD9201-8						■							
Direct operating mechanisms, distribution boards													
<ul style="list-style-type: none"> Not suitable for basic units without handle 													
	Number of poles	Color	Article No.										
	3-pole	Gray	3KD9011-0C		■								
		Red/yellow	3KD9011-8C		■								
	4-pole	Gray	3KD9011-0D		■								
Red/yellow		3KD9011-8D		■									
Door-coupling rotary operating mechanisms, complete													
<ul style="list-style-type: none"> Scope of supply: <ul style="list-style-type: none"> Handle with masking plate (sizes 01 and 02 without test function) Coupling driver Shaft 300 mm Can be locked with up to max. 3 padlocks 													
	Inscription	Tolerance compensation	Defeat function	Color	Article No.								
	O-I	With	With	Gray	8UD1171-1AD21	■	■						
				Red/yellow	8UD1171-1AD25	■	■						
				Gray	3KD9001-5	■	■						
		Without	Without	Gray	3KD9001-6	■	■						
				Red/yellow	8UD1171-2AD11			■	■				
				Red/yellow	8UD1171-2AD15			■	■				
	Test-O-I	With	With	Gray	8UD1171-2AF21			■	■				
				Gray	8UD1141-2AF21					■			
				Gray	8UD1151-3AF21						■		
				Gray	8UD1161-4AF21							■	
		Red/yellow	Without	Without	Red/yellow	8UD1171-2AF25			■	■			
					Red/yellow	8UD1141-2AF25					■		
					Red/yellow	8UD1151-3AF25						■	
Red/yellow					8UD1161-4AF25							■	

Note:






- For 3KD switch disconnectors and lateral operating mechanism (left or right), only 8UD door-coupling rotary operating mechanisms without the test function can be used
- The door-coupling rotary operating mechanisms of the 3KD90 type are mounted on the inside of the door by means of center-hole mounting

3KD switch disconnectors

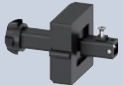


Accessories

Accessories for door-coupling rotary operating mechanisms



Size 01 Size 02 Size 1 Size 2 Size 3 Size 4 Size 5

Handles					Size 01	Size 02	Size 1	Size 2	Size 3	Size 4	Size 5	
<ul style="list-style-type: none"> Supplied with a masking plate, but without an extension shaft and without coupling driver Can be locked with up to max. 3 padlocks 												
Inscription					Article No.							
 	O-I	Without	Gray	8UD1771-2AD01	■	■	■	■				
				8UD1841-2AD01				■				
				8UD1851-3AD01							■	
		8UD1861-4AD01									■	
		Red/yellow	8UD1771-2AD05	■	■	■	■					
			8UD1841-2AD05							■		
	8UD1851-3AD05									■		
	With	Gray	8UD1861-4AD05									■
			8UD1771-2CD01			■	■					
			8UD1841-2CD01							■		
		Red/yellow	8UD1851-3CD01								■	
			8UD1861-4CD01									■
8UD1771-2CD05					■	■						
Test-O-I	Without	Gray	8UD1841-2CD05					■				
			8UD1851-3CD05							■		
			8UD1861-4CD05									■
		Red/yellow	8UD1771-2AF01				■	■				
			8UD1841-2AF01							■		
			8UD1851-3AF01								■	
	With	Gray	8UD1861-4AF01									■
			8UD1771-2AF05			■	■					
			8UD1841-2AF05							■		
		Red/yellow	8UD1851-3AF05								■	
			8UD1861-4AF05									■
			8UD1771-2CF01			■	■					
Red/yellow	8UD1841-2CF01							■				
	8UD1851-3CF01								■			
	8UD1861-4CF01									■		
	8UD1771-2CF05			■	■							
	8UD1841-2CF05							■				
	8UD1851-3CF05								■			
8UD1861-4CF05										■		
Extension shafts												
<ul style="list-style-type: none"> A shaft jack is required for the 8UD1 handle when the 600 mm long shaft is used and for sizes 01, 02, 1 and 2 												
Length					Article No.							
	300 mm				3KD9002-0	■	■					
					8UC6032			■	■	■		
					8UC6033						■	
					8UC6034							■
	600 mm				3KD9002-1	■	■					
					8UC6082			■	■	■		
					8UC6083						■	
					8UC6084							■
Shaft jack for 8UD1 handle												
	Version		Article No.									
	For shaft 600 mm		8UD1900-0FA00		■	■	■	■				

Accessories for door-coupling rotary operating mechanisms

			Size 01	Size 02	Size 1	Size 2	Size 3	Size 4	Size 5
Coupling drivers									
	Version	Article No.							
	With tolerance compensation	8UD1900-1GA00	■	■					
		8UD1900-2GA00			■	■			
		8UD1900-6GA00					■		
		8UD1900-3GA00						■	
	8UD1900-4GA00							■	
	Version	Article No.							
	Without tolerance compensation	8UD1900-1HA00	■	■					
		8UD1900-2HA00			■	■			
		8UD1900-6HA00					■		
		8UD1900-3HA00						■	
	8UD1900-4HA00							■	
Adapters for shafts									
	Version	Article No.							
		8UC6022			■	■	■		
		8UC6023						■	
	8UC6024							■	

Further accessories and spare parts

				Size 01	Size 02	Size 1	Size 2	Size 3	Size 4	Size 5
Auxiliary switch modules										
	<ul style="list-style-type: none"> Auxiliary switch modules are supplied without auxiliary switches. A maximum of 2 auxiliary switches can be installed per auxiliary module The 3KD9103-6 and 3KD9103-7 auxiliary switch modules can only be used with 3KD directly on the operating mechanism if the operating mechanism is on the front or on the left 									
	Type	Article No.								
	Standard version	3KD9103-5								
	With test function	3KD9103-6								
	With leading NO contact and test function	3KD9103-7								
Auxiliary switches										
<ul style="list-style-type: none"> Auxiliary switches for sizes 01 and 02 are snapped onto the side of the switches Auxiliary switches for sizes 3 to 5 have a screw terminal and are mounted on the 3KD operating mechanism module. Auxiliary switches with spring-type terminals from the 3SU1 program can also be used. All auxiliary switches for sizes 3 to 5 can be used as leading auxiliary switches, depending on the mounting position of the auxiliary switch (see operating instructions). 										
	Type	Contacts	Contact surface	Article No.						
	With connecting cables	1 CO	Standard	3KD9103-1						
			Solid-state compatible	3KD9103-3						
	Without connecting cables	1 NO + 1 NC	Standard	3KD9003-2						
			Solid-state compatible	3KD9003-4						
		1 CO	Standard	3KD9103-2						
			Solid-state compatible	3KD9103-4						
	1 NO		Standard	3SU1400-1AA10-1BA0						
			Gold-plated	3SU1400-1AA10-1LA0						
	1 NC		Standard	3SU1400-1AA10-1CA0						
			Gold-plated	3SU1400-1AA10-1MA0						
	1 NO + 1 NC		Standard	3SU1400-1AA10-1FA0						
			Gold-plated	3SU1400-1AA10-1QA0						
	2 NO		Standard	3SU1400-1AA10-1DA0						
			Gold-plated	3SU1400-1AA10-1NA0						
2 NC		Standard	3SU1400-1AA10-1EA0							
		Gold-plated	3SU1400-1AA10-1PA0							

3KD switch disconnectors

Accessories

Further accessories and spare parts

Size 01 Size 02 Size 1 Size 2 Size 3 Size 4 Size 5

Phase barriers



- For 3KD with flat terminals
- For 3KD size 2 with flat terminals, phase barriers are already contained in the scope of supply

Version	Scope of supply	Article No.	Size 01	Size 02	Size 1	Size 2	Size 3	Size 4	Size 5
For 3-pole devices	6 units	3KD9108-6				■			
		3KD9308-6					■		
		3KD9408-6							■
		3KD9508-6							■
For 4-pole devices	8 units	3KD9108-8				■			
		3KD9308-8					■		
		3KD9408-8							■
		3KD9508-8							■

Terminal covers



- For sizes 01 and 02, terminal covers are already part of the scope of supply and must therefore only be used as spare parts
- For 3KD with flat terminals
- Not permissible for 2000 A devices

Version	Scope of supply	Type	Article No.	Size 01	Size 02	Size 1	Size 2	Size 3	Size 4	Size 5
For 1-pole devices	4 units		3KD9014-1B	■						
			3KD9024-1B		■					
For 3-pole devices	4 units		3KD9014-3B	■						
		6 units	Standard version	3KD9504-6						
			3KD9204-6				■			
	Short version		3KD9204-7				■			
	8 units		Standard version	3KD9304-6					■	
			3KD9404-6							■
	Short version	3KD9304-7					■			
		3KD9404-7							■	
For 4-pole devices	8 units	Standard version	3KD9504-8							■
			3KD9204-8				■			
		3KD9204-5				■				
	10 units	Standard version	3KD9304-8					■		
			3KD9404-8							■
		Short version	3KD9304-5					■		
		3KD9404-5							■	

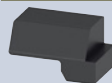
Spare part for terminal covers



- Not permissible for 2000 A devices

Scope of supply	Type	Article No.	Size 01	Size 02	Size 1	Size 2	Size 3	Size 4	Size 5
1 unit	Standard version	3KD9504-1							■
	Short version	3KD9204-1				■			
		3KD9304-1					■		
		3KD9404-1							■

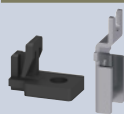
Blocking pin test function



- Enables permanent deactivation of the test function for auxiliary switches
- It is installed in the operating mechanism module of the 3KD switch disconnector

Scope of supply	Article No.	Size 01	Size 02	Size 1	Size 2	Size 3	Size 4	Size 5
10 units	3KF9112-1AA00			■	■			
	3KF9412-1AA00					■	■	
	3KF9512-1AA00							■

Mounting brackets



- Spare part, included in the scope of supply of the 3KD

Scope of supply	Article No.	Size 01	Size 02	Size 1	Size 2	Size 3	Size 4	Size 5
4 units	3KD9120-1			■	■			
	3KF9212-0AA00					■		
	3KF9412-0AA00							■
	3KF9512-0AA00							■

Further accessories and spare parts

Size 01 Size 02 Size 1 Size 2 Size 3 Size 4 Size 5

Slide for mounting on a DIN rail



- Spare part, included in the scope of supply of the 3KD

Scope of supply	Article No.	Size 01	Size 02	Size 1	Size 2	Size 3	Size 4	Size 5
5 units	3KF9112-0BA00			■	■			

Accessories for DC applications

Size 01 Size 02 Size 1 Size 2 Size 3 Size 4 Size 5

Connecting bridges



- Suitable for connecting 2 poles
- For 3KD switch disconnectors with 400 A, 800 A, 1250 A and 1600 A, two units are required.

Connection	Article No.	Size 01	Size 02	Size 1	Size 2	Size 3	Size 4	Size 5
Box terminals	3KD9118-1			■				
	3KD9218-1				■			
Flat terminals	3KD9218-0				■			
	3KD9318-0					■		
	3KD9418-0						■	
	3KD9518-0							■

Terminal covers for connecting bridges



- For 3KD with flat terminals

Article No.	Size 01	Size 02	Size 1	Size 2	Size 3	Size 4	Size 5
3KD9204-0				■			
3KD9304-0					■		
3KD9404-0						■	
3KD9504-0							■


Fuse switch disconnectors

Quick selection guide



3NP1



Size		000 narrow	000	00	1	2	3	
General technical specifications acc. to IEC 60947-3								
Basic data								
Rated uninterrupted current I_u	A	125	125 ²⁾	160	250	400	630	
For fuse links acc. to IEC 60269-2	Size	000	000	00 and 000	1 and 0	2 and 1	3 and 2	
Rated operational voltage U_e	At 50/60 Hz AC	V	690	690	690			
	At DC (3 conducting paths in series)	V	–	440	440			
	At DC (2 conducting paths in series)	V	–	240	240			
	At DC	V	–	–	–			
	For utilization category AC-20B or DC-20B	V	–	690 ¹⁾	690 ¹⁾			
Operating and short-circuit behavior								
Rated operational current I_e	At AC-21B, 400 V AC	A	125	125 ²⁾	160	250	400	630
	At AC-22A, 400 V AC	A	–	–	–	–	–	–
	At AC-22B, 400 V AC	A	125	125 ²⁾	160	250	400	630
	At AC-23B, 400 V AC	A	63	125 ²⁾	160	250	400	630
	At AC-21B, 500 V AC	A	125	125 ²⁾	160	250	400	630
	At AC-22B, 500 V AC	A	125	125	160	250	400	630
	At AC-23B, 500 V AC	A	–	40	63	200	315	500
	At AC-21B, 690 V AC	A	80	125 ²⁾	160	250	400	630
	At AC-22B, 690 V AC	A	–	50	125	250	400	500
	At AC-23B, 690 V AC	A	–	25	35	100	125	200
	At DC-21B (2 conducting paths in series), 240 V DC	A	–	125 ²⁾	160	250	400	630
	At DC-22B (2 conducting paths in series), 240 V DC	A	–	100	160	250	400	630
	At DC-23B (2 conducting paths in series), 240 V DC	A	–	80	100	200	250	400
	At DC-21B (3 conducting paths in series), 440 V DC	A	–	100	160	250	400	630
	At DC-22B (3 conducting paths in series), 440 V DC	A	–	50	125	200	315	500
At DC-23B (3 conducting paths in series), 440 V DC	A	–	25	63	100	160	250	
Rated conditional short-circuit current with fuses (by fast switch on)	Rated current at 400 V/500 V/690 V	kA	80/80/80	80/80/80	80/80/80	80/80/50	80/80/50	50/50/50
	Permissible let-through current of the fuses, peak value	kA	10	10	15	25	40	50
Short-circuit strength with fuses (with closed disconnector)	Rated current at 500 V/690 V	kA	80/80	120/100	120/100	120/100	100/100	100/100
	Permissible let-through I^2t value of the fuses	kA ² s	59	223	223	780	2150	5400
	Permissible let-through current of the fuses, peak value	kA	10	15	23	32	40	60
Rated making capacity	With isolating blades at 500 V AC	kA	–	2	6	17	17	17
Rated short-time withstand current I_{cw}		kA	–	–	–	–	–	–
Rated insulation voltage U_i		V	690	690 ¹⁾	690 ¹⁾	690 ¹⁾	690 ¹⁾	690 ¹⁾
Rated impulse withstand voltage U_{imp}		kV	6	8	8	8	8	8
Power loss per pole of the switch at I_{th} (without fuses)		W	4.6	5	5	8	14	30
Maximum power loss of the usable fuses (per fuse)		W	9	7.5 ³⁾	12	23	34	48
Mechanical endurance, operating cycles			2000	2000	2000	1600	1000	1000
Degree of protection, on the front								
Without masking plate or terminal cover – switch closed/open		IP30/IP10	IP30/IP20	IP30/IP20	IP30/IP20	IP30/IP20	IP30/IP20	
With masking plate or terminal cover – switch closed/open		IP30/IP10	IP40/IP20	IP40/IP20	IP40/IP20	IP40/IP20	IP40/IP20	
Certifications and approvals								
VDE, CCC, LR,  us ⁴⁾								

Further information

The technical specifications apply to the standard types stated below.
 For the complete specifications for all versions, see the Online Support
 3NP1: 3-pole and 4-pole devices without fuse monitoring
 3NP5: Devices without fuse monitoring

3NJ4/5: Disconnectors for cable and line protection without fuse monitoring, not for transformer protection

See page 8/84

3NP5



3NJ4/3NJ5



5SG76



3NP5				3NJ4/3NJ5				5SG76	
00	1	2	3	00	1	2	3	4a	D01
160	250	400	630	160	250	400	630	1250	16
00	1 and 0	2 and 1	3 and 2	00 and 000	1 and 0	2 and 1	3 and 2	4a	D01
	690					690			400, 415
	440					-			-
	220					-			110
	-					-			48
	690					-			-
160	250	400	630	160	250	400	630	1250	16
-	-	-	-	-	-	-	-	-	16
160	250	400	630	160	250	400	630	1250	-
160	250	400	630	-	250	400	-	-	-
160	250	400	630	160	250	400	630	1250	-
160	250	400	630	160	250	400	630	1250	-
160	250	400	630	-	-	-	-	-	-
160	250	400	630	100	250	400	630	1250	-
160	250	400	630	100	250	-	-	-	-
100	160	315	400	-	-	-	-	-	-
160	250	400	630	-	-	-	-	-	-
160	250	400	630	-	-	-	-	-	-
160	250	400	630	-	-	-	-	-	-
160	250	400	630	-	-	-	-	-	-
160	250	400	630	-	-	-	-	-	-
50/50/-	50/50/-	50/50/-	50/50/-	-	-	-	-	-	50/-/-
15	25	40	50	-	-	-	-	-	-
100/-	100/-	50/-	50/-	80	120	120	120	80	-
223	780	2150	5400	-	-	-	-	-	-
23	32	40	60	-	-	-	-	-	-
6	17	17	17	-	-	-	-	-	-
-	-	-	-	-	14.5	14.5	14.5	35	-
690 ¹⁾	690 ¹⁾	690 ¹⁾	690 ¹⁾	800	1000	1000	1000	1000	400
6	6	6	6	8	12	12	12	12	2.5
7.8	7.5	15	39	18	23	54	115	190	-
12	23	34	48	12	32	45	48	110	2.5
1600	1600	1600	1600	1400	1400	800	800	500	-
IP00/IP00	IP00/IP00	IP00/IP00	IP00/IP00	IP00/IP00	IP00/IP00	IP00/IP00	IP00/IP00	IP00/IP00	IP20/IP20
IP30/IP10	IP30/IP10	IP30/IP10	IP30/IP10	IP30/IP10	IP30/IP10	IP30/IP10	IP30/IP10	IP10/IP00	IP20/IP20
CCC									

See page 8/98

See page 8/102

See page 8/114

¹⁾ Applies to degree of pollution 3
(for degree of pollution 2, use up to U_i 1000 V possible)

²⁾ If optional infeed terminal is used max. 160 A

³⁾ Max. 9 W for operation up to 160 A

⁴⁾ 3NP1 NH000 in narrow design only has IEC approval

3NP1 fuse switch disconnectors

System overview

Basic units



1, 3, 4-pole for floor mounting



3 and 4-pole mounting on busbar systems

Connection parts



Terminals for retrofitting to 3NP1



Auxiliary conductor connections



3-phase busbars

Assembly kits



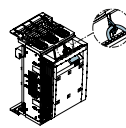
DIN-rail mounting



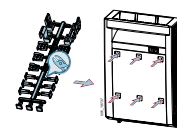
Mechanical connection



1/4-pole busbar mounting



Locking function



Protection against power theft

Masking frames and covers



Masking frames and supports



Cable connection covers



Reach-around protection for busbar

Further accessories



Auxiliary switches



Isolating blades



Fuse carriers with and without fuse monitoring

Note:

You will find a detailed range of accessories with the basic units.

General information



3NA COM LV HRC fuse links



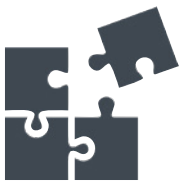
The new 3NA COM LV HRC fuse links with communication and measuring function make your products communication-capable.

See [Fuse Systems](#), page 7/50



Modular design

Directly to 3NP1 configurator under: sie.ag/3IIXQZH



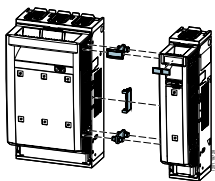
The 3NP1 fuse switch disconnector has a modular design. A wide variety of switch combinations can be created by connecting two devices or by subsequently fitting accessories. All common switch combinations are available from the factory ready for installation and can be found on the following ordering overviews. An overview of the possibilities offered by the modular design is provided on these information pages.

The fastest and simplest way to find the right switch combination is to use our 3NP1 configurator at sie.ag/3IIXQZH.



Number of poles

You will find further information under: sie.ag/2UlrAvy



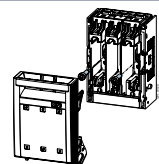
3NP1 fuse switch disconnectors are available from the factory in 1, 3 and 4-pole device versions. 4-pole types are available in all common versions from the factory ready for installation (without fuse monitoring, N-pole on the right-hand side).

All other conceivable device combinations, such as 2-pole 3NP1s, 4-pole with fuse monitoring or with a neutral conductor on the left-hand side can simply be put together on site by combining two 3NP1s. All that is needed for this in addition to the two 3NP1 basic units is the matching connection assembly kit (see accessories).



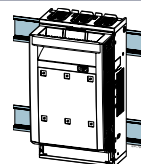
Floor mounting and DIN rail

You will find further information under: sie.ag/2UlrAvy



All sizes of the 3NP1 fuse switch disconnectors are available in floor mounting versions.

The 3NP1 is mounted on a mounting panel with screws.



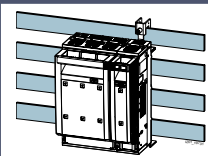
The devices for floor mounting of sizes 000, 00 and 1 can also be mounted on a DIN rail using accessories. For this purpose, the assembly kit for mounting on a DIN rail is simply mounted on the rear panel of the 3NP1.

3NP1 fuse switch disconnectors

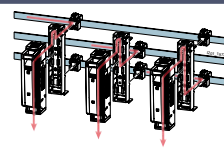
General information



Mounting on busbar systems



3-pole and 4-pole 3NP1 are available for mounting on busbar systems. In the case of 4-pole devices, the infeed for the fourth pole is supplied by the neutral conductor bar located above the 3 phases.



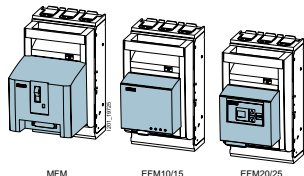
1-pole 3NP1 devices for wall mounting in sizes 000 and 00 can be adapted to the 8US 60 mm busbar system using the assembly kit for 1-pole busbar mounting. Due to the modular design of the assembly kit, any phase can be selected for the infeed.

You will find further information under:
sie.ag/2UlrAvy



Fuse monitoring

You will find further information under:
sie.ag/2UlrAvy



The fuse monitoring is used to detect, indicate and signal that a fuse has tripped.

The fuse monitors are permanently installed on the handle of the 3NP1. They have floating contacts for remote signaling of a tripped fuse and also indicate this locally.

Various versions of fuse monitors are available, which can be selected to suit the requirements of the application (functionality, see table).

MFM electromechanical fuse monitoring with an installed SIRIUS circuit breaker

EFM electronic fuse monitoring with evaluation electronics

The EFM15 series is a cost-optimized version of the EFM10. EFM20/25 are versions with additional functions (display indication, detection and signaling of overvoltage/undervoltage with adjustable limits, phase failure detection).

Common combinations of the 3NP1 basic unit and fuse monitoring are available from the factory ready for installation. A fuse monitor can also be easily retrofitted by replacing the fuse carrier. (Fuse carriers for all fuse monitoring versions are available as accessories.)

Note:

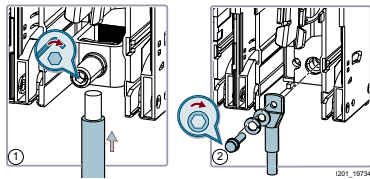
Fuses with insulated grip lugs cannot be used for 3NP1 with fuse monitoring.

		MFM 3-pole	EFM10 3-pole	EFM15				EFM20 3-pole	EFM25 3-pole	
				1-pole		3-pole				
				AC/DC	AC	DC	AC			DC
Local indication	Toggle switch position	■	–	–	–	–	–	–	–	
	Indication via LEDs for each phase	–	■	■	■	■	■	■	■	
	Indication via display for each phase	–	–	–	–	–	–	■	■	
External power supply required	–	–	24 V DC	24 V DC	24 V DC	24 V DC	24 V DC	–	–	
Permissible operational voltage	AC	Max. 690 V	230 ... 690 V	24 ... 230 V	110 ... 690 V	–	190 ... 690 V	–	230 ... 690 V	–
	DC	Max. 440 V	–	24 ... 250 V	–	120 ... 440 V	–	220 ... 440 V	–	220 ... 440 V
Detection and indication of	Overvoltage	–	–	–	–	–	–	■	■	
	Undervoltage	–	–	–	–	–	–	■	■	
	Phase failure	–	–	–	–	–	–	■	–	



Electrical connection

You will find further information under:
sie.ag/2UlrAvy



3NP1 are available in versions with box terminals (all sizes) or flat terminals (sizes 00 and larger).

Various additional types of terminal are available as accessories for adaptation to the respective wiring situation, e.g. prism, saddle or three-tier terminals.

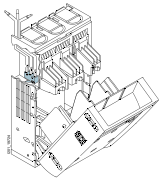


Further accessories

You will find further information under:
sie.ag/2UlrAvy

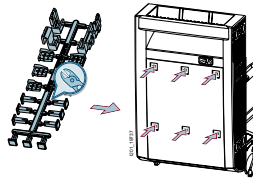


Auxiliary switches



Auxiliary switches enable remote querying of the switch position of the 3NP1. Up to two auxiliary switches can be installed.

Power theft



The assembly kit for protection from power theft seals the holes on the front of the 3NP1 (for voltage testing) permanently, which reliably prevents unauthorized access to live parts.

Isolating blades

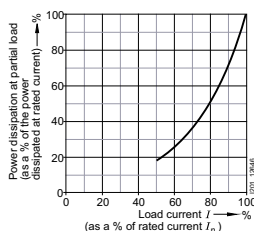


4-pole 3NP1s are used in 3-phase AC systems with switched neutral conductors. They are supplied without an isolating blade for the N pole. The switching instant is selected by choosing the appropriate isolating blade.



Suitable fuses

You will find further information under:
sie.ag/2UlrAvy



The 3NP5 fuse switch disconnector is suitable for all fuses with LV HRC design in sizes 000 to 3 that comply with IEC 60269-2, including fuses for cable and line protection and motor protection.

Fuses for semiconductor protection (Siemens trademark SITOR) can also be used. However, some of these fuses have substantially higher power losses than fuses according to IEC 60269-2. This means that the load current has to be reduced until the value that is permissible in the fuse switch disconnector is not exceeded. For use of SITOR semiconductor fuses, ready-made derating tables are available in the linked document.

3NP1 fuse switch disconnectors

For a complete and valid configuration of your fuse switch disconnectors, please use our online configurator at www.siemens.com/lowvoltage/3np1-configurator

Flat terminals

NH00



NH1



NH2









NH3



Fuse monitoring	Number of poles	$I_u = 160 \text{ A}$	$I_u = 250 \text{ A}$	$I_u = 400 \text{ A}$	$I_u = 630 \text{ A}$
Floor mounting					
Without	1-pole	3NP1131-1CA10	3NP1141-1DA10	3NP1151-1DA10	3NP1161-1DA10
	3-pole	3NP1133-1CA10	3NP1143-1DA10	3NP1153-1DA10	3NP1163-1DA10
	4-pole	3NP1134-1CA10	3NP1144-1DA10	3NP1154-1DA10	3NP1164-1DA10
MFM	3-pole	3NP1133-1CA11	3NP1143-1DA11	3NP1153-1DA11	3NP1163-1DA11
EFM10	3-pole	3NP1133-1CA12	3NP1143-1DA12	3NP1153-1DA12	3NP1163-1DA12
EFM15	1-pole	3NP1131-1CA14	3NP1141-1DA14	3NP1151-1DA14	3NP1161-1DA14
	3-pole	3NP1133-1CA14	3NP1143-1DA14	3NP1153-1DA14	3NP1163-1DA14
EFM20	3-pole	3NP1133-1CA13	3NP1143-1DA13	3NP1153-1DA13	3NP1163-1DA13
Mounting on 60 mm busbar systems with reach-around protection for Siemens 8US					
Without FM	3-pole	3NP1133-1BC10	3NP1143-1BC10	3NP1153-1BC10	3NP1163-1BC10
	4-pole	3NP1134-1BC10	3NP1144-1BC10	3NP1154-1BC10	3NP1164-1BC10
MFM	3-pole	3NP1133-1BC11	3NP1143-1BC11	3NP1153-1BC11	3NP1163-1BC11
EFM10	3-pole	3NP1133-1BC12	3NP1143-1BC12	3NP1153-1BC12	3NP1163-1BC12
EFM15	3-pole	3NP1133-1BC14	3NP1143-1BC14	3NP1153-1BC14	3NP1163-1BC14
	3-pole	3NP1133-1BC13	3NP1143-1BC13	3NP1153-1BC13	3NP1163-1BC13
Mounting on 60 mm busbar systems with reach-around protection for Rittal					
Without FM	3-pole	3NP1133-1JC10	3NP1143-1JC10	3NP1153-1JC10	3NP1163-1JC10
MFM	3-pole	3NP1133-1JC11	3NP1143-1JC11	3NP1153-1JC11	3NP1163-1JC11
EFM10	3-pole	3NP1133-1JC12	3NP1143-1JC12	3NP1153-1JC12	3NP1163-1JC12
EFM20	3-pole	3NP1133-1JC13	3NP1143-1JC13	3NP1153-1JC13	3NP1163-1JC13
Mounting on 40 mm busbar systems with reach-around protection for Siemens 8US					
Without FM	3-pole	3NP1133-1BB10	–	–	–
MFM	3-pole	3NP1133-1BB11	–	–	–
EFM10	3-pole	3NP1133-1BB12	–	–	–
EFM20	3-pole	3NP1133-1BB13	–	–	–
Mounting on 40 mm busbar systems with reach-around protection for Rittal					
Without FM	3-pole	3NP1133-1JB10	–	–	–
MFM	3-pole	3NP1133-1JB11	–	–	–
EFM10	3-pole	3NP1133-1JB12	–	–	–
EFM20	3-pole	3NP1133-1JB13	–	–	–

Notes:

- On the 3NP1 with fuse monitoring, the permissible operational voltage is limited by the fuse monitoring
- Permissible operational voltage with fuse monitoring:
 - MFM AC max. 690 V (L – L)/max. 440 V (L+ – L–)
 - EFM10 230 ... 690 V AC (L – L)
 - EFM15 3-pole 190 ... 690 V AC (L – L)
 - EFM15 1-pole 24 ... 240 V AC (L – N)/24 ... 250 V DC (L+ – L–)
 - EFM20 230 ... 690 V AC (L – L)
- Additional variants are available as accessories:
 - EFM15 with further operational voltage ranges
 - EFM25 – DC version of the EFM20
- Devices for busbar mounting with reach-around protection
 - For Siemens 8US, mounting is possible on the Wöhner Classic and Rittal RiLine systems without a floor pan
 - For Rittal, mounting is possible on the RiLine60 system with a floor pan

Box terminals					
NH000 narrow	NH000	NH00	NH1	NH2	NH3
					
$I_u = 125 \text{ A}$	$I_u = 125 \text{ A}^{2)}$	$I_u = 160 \text{ A}$	$I_u = 250 \text{ A}$	$I_u = 400 \text{ A}$	$I_u = 630 \text{ A}$
–	3NP1121-1CA20	3NP1131-1CA20	3NP1141-1DA20	3NP1151-1DA20	3NP1161-1DA20
3NP1113-1CA20	3NP1123-1CA20	3NP1133-1CA20	3NP1143-1DA20	3NP1153-1DA20	3NP1163-1DA20
–	3NP1124-1CA20	3NP1134-1CA20	3NP1144-1DA20	3NP1154-1DA20	3NP1164-1DA20
–	–	3NP1133-1CA21	3NP1143-1DA21	3NP1153-1DA21	3NP1163-1DA21
–	3NP1123-1CA22	3NP1133-1CA22	3NP1143-1DA22	3NP1153-1DA22	3NP1163-1DA22
–	3NP1121-1CA24	3NP1131-1CA24	3NP1141-1DA24	3NP1151-1DA24	3NP1161-1DA24
–	3NP1123-1CA24	3NP1133-1CA24	3NP1143-1DA24	3NP1153-1DA24	3NP1163-1DA24
–	3NP1123-1CA23	3NP1133-1CA23	3NP1143-1DA23	3NP1153-1DA23	3NP1163-1DA23
3NP1113-1BC20 ¹⁾	3NP1123-1BC20	3NP1133-1BC20	3NP1143-1BC20	3NP1153-1BC20	3NP1163-1BC20
–	3NP1124-1BC20	3NP1134-1BC20	3NP1144-1BC20	3NP1154-1BC20	3NP1164-1BC20
–	–	3NP1133-1BC21	3NP1143-1BC21	3NP1153-1BC21	3NP1163-1BC21
–	3NP1123-1BC22	3NP1133-1BC22	3NP1143-1BC22	3NP1153-1BC22	3NP1163-1BC22
–	3NP1123-1BC24	3NP1133-1BC24	3NP1143-1BC24	3NP1153-1BC24	3NP1163-1BC24
–	3NP1123-1BC23	3NP1133-1BC23	3NP1143-1BC23	3NP1153-1BC23	3NP1163-1BC23
3NP1113-1BC20 ¹⁾	3NP1123-1JC20	3NP1133-1JC20	3NP1143-1JC20	3NP1153-1JC20	3NP1163-1JC20
–	–	3NP1133-1JC21	3NP1143-1JC21	3NP1153-1JC21	3NP1163-1JC21
–	3NP1123-1JC22	3NP1133-1JC22	3NP1143-1JC22	3NP1153-1JC22	3NP1163-1JC22
–	3NP1123-1JC23	3NP1133-1JC23	3NP1143-1JC23	3NP1153-1JC23	3NP1163-1JC23
–	3NP1123-1BB20	3NP1133-1BB20	–	–	–
–	–	3NP1133-1BB21	–	–	–
–	3NP1123-1BB22	3NP1133-1BB22	–	–	–
–	3NP1123-1BB23	3NP1133-1BB23	–	–	–
–	3NP1123-1JB20	3NP1133-1JB20	–	–	–
–	–	3NP1133-1JB21	–	–	–
–	3NP1123-1JB22	3NP1133-1JB22	–	–	–
–	3NP1123-1JB23	3NP1133-1JB23	–	–	–

¹⁾ The direction of the cable outlet for the load side cannot be changed on size NH000, narrow design
 3NP1113-1BC20 → Cable outlet at the bottom
 3NP1113-2BC20 → Cable outlet at the top

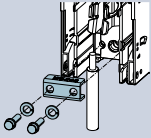
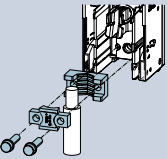
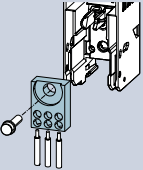
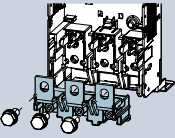
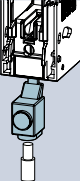
²⁾ If optional infeed terminal is used max. 160 A

3NP1 fuse switch disconnectors

Accessories

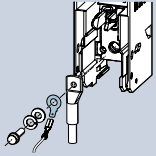
Connection technology – Terminals

- For adaptation to the respective wiring situation
- Contain enough parts to retrofit one side of a 3NP1 accordingly (three terminals for 3-pole 3NP1, one terminal for 1-pole unit)
- If the incoming cable and cable outlet are retrofitted, two packages must be ordered

		1-pole	3-pole	NH000 narrow	NH000	NH00	NH1	NH2	NH3
Saddle terminals									
 <ul style="list-style-type: none"> • Allows connection of stripped circular conductors to 3NP1 with flat terminals 	Connection	Conductor cross-section	Article No.	Article No.					
		1.5 ... 70 mm ²	3NP1931-1BA00	3NP1933-1BA00		■			
		70 ... 120 mm ²	3NP1941-1BA00	3NP1943-1BA00			■		
		120 ... 240 mm ²	3NP1951-1BA00	3NP1953-1BA00				■	
		150 ... 300 mm ²	3NP1961-1BA00	3NP1963-1BA00					■
Prism terminals									
 <ul style="list-style-type: none"> • Allows connection of stripped circular conductors to 3NP1 with flat terminals • Also approved for connection of aluminum conductors, available for one or two conductors 	Type	Conductor cross-section	Article No.	Article No.					
	Single	35 ... 95 mm ²	3NP1931-1BB10	3NP1933-1BB10		■			
		70 ... 150 mm ²	3NP1941-1BB10	3NP1943-1BB10			■		
		120 ... 240 mm ²	3NP1951-1BB10	3NP1953-1BB10				■	
		150 ... 300 mm ²	3NP1961-1BB10	3NP1963-1BB10					■
	Double	2 × 35 ... 70 mm ²	3NP1941-1BB20	3NP1943-1BB20			■		
		2 × 70 ... 120 mm ²	3NP1951-1BB20	3NP1953-1BB20				■	
2 × 150 ... 185 mm ²		3NP1961-1BB20	3NP1963-1BB20					■	
Three-tier terminals									
 <ul style="list-style-type: none"> • Distributes one outgoing feeder directly to three smaller loads 	Type	Conductor cross-section	Article No.	Article No.					
	For 3NP1 with flat terminals	3 × 1.5 ... 16 mm ²	3NP1931-1BE10	3NP1933-1BE10		■			
	For 3NP1 with box terminals	3 × 1.5 ... 16 mm ²	3NP1921-1BE20	3NP1923-1BE20		■	■		
Connection module									
 <ul style="list-style-type: none"> • Used with a 3NP1 for busbar mounting if a masking frame is to be supported on the 32 mm cover plane (installation of the terminals under the masking frame) • For 3NP1 with flat terminals 	Type	Conductor cross-section	Article No.	Article No.					
	Connection module	3 × 6 ... 70 mm ²	3NP1931-1BC00	3NP1933-1BC00		■			
Infeed terminal									
 <ul style="list-style-type: none"> • Extends the conductor cross-section of a 000 with box terminal to up to 95 mm² 	Version	Conductor cross-section	Article No.	Article No.					
	Infeed terminal	16 ... 95 mm ²	3NP1921-1BD00	3NP1923-1BD00		■			

Connection technology

Auxiliary conductor connections



- For connecting small loads directly to the terminals of the 3NP1
- Connection via commercially available flat tab sleeves 6.3 × 0.8 mm, max. 5 A load
- Scope of supply: 3 units

3NP1 connection

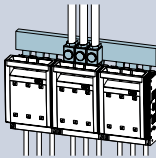
With flat terminals

With box terminals

With retrofitted prism and saddle terminals

3-pole	NH000 narrow	NH000	NH00	NH1	NH2	NH3
Article No.						
			■			
				■		
					■	
						■
	■	■				
			■			
				■		
					■	
						■
			■			
				■		
					■	
						■

3-phase busbar system



- For connection of up to 4 3NP1 NH000 for floor mounting on the infeed side
- Infeed is routed through infeed terminals
- With the connection bar, two blocks of bridged 3NP1 can be connected
- Using the cover cap, the connection tags of the busbar are covered on unused feeders to ensure they are safe to touch
- The maximum current-carrying capacity of the interconnected 3NP1 is 225 A in total for the 3-phase busbar system

Version

Scope of supply

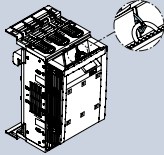
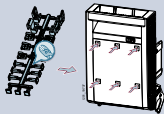
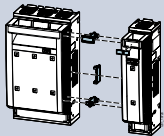
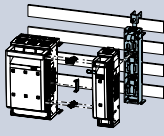
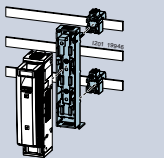
Article No.

For 2 × 3NP1	1 pack = 5 units	3NP1923-1BF20		■		
For 3 × 3NP1	1 pack = 5 units	3NP1923-1BF30		■		
For 4 × 3NP1	1 pack = 3 units	3NP1923-1BF40		■		
Connection bars	1 pack = 3 units	3NP1923-1BF50		■		
Covering caps	1 pack = 20 units	3NP1923-1BF10		■		
Infeed terminal	1 pack = 3 units	3NP1923-1BD00		■		

3NP1 fuse switch disconnectors

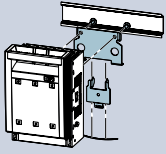
Accessories

Assembly kits

	NH000 narrow	NH000	NH00	NH1	NH2	NH3	
Retrofitting of locking function							
 <ul style="list-style-type: none"> For all versions of the 3NP1 If required for locking with a padlock (not necessary for the 1-pole 3NP1 and NH000, narrow design) 	Article No.						
	Scope of supply 1 pack = 10 units	3NP1900-1HA00	■	■	■	■	■
Protection against power theft							
 <ul style="list-style-type: none"> Closes the holes on the front of the 3NP1 (holes for voltage testing) and secures the front window such that power theft is not possible without visible damage to the 3NP1 (when the 3NP1 is locked or sealed) 	Article No.						
	Scope of supply 1 pack is sufficient to equip 5 3NP1 units, 2.5 units for NH000, narrow design	3NP1900-1EF00	■	■	■	■	■
Mechanical connection of 1-pole and 3-pole 3NP1 devices							
 <ul style="list-style-type: none"> For 3NP1 with floor mounting By combining two 3NP1s for floor mounting, any 2-pole and 4-pole devices can be created 	Article No.						
		3NP1921-1EC00	■				
		3NP1931-1EC00		■			
		3NP1941-1EC00			■	■	■
4-pole connection assembly kit for mounting on a 8US 60-mm busbar							
 <ul style="list-style-type: none"> Connects a 3-pole 3NP1 for busbar mounting 60 mm 8US to a 1-pole 3NP1 for floor mounting The 1-pole 3NP1 switches the neutral conductor of a 3P+N system in this combination 	Article No.						
	3NP1 connection						
	With flat terminals	3NP1934-1ED20		■			
	With box terminals	3NP1924-1ED10	■				
		3NP1934-1ED10		■			
	With flat terminals or box terminals	3NP1944-1ED00			■		
	3NP1954-1ED00				■	■	
1-pole connection assembly kit for mounting on a 8US 60-mm busbar							
 <ul style="list-style-type: none"> Permits adaptation of a 1-pole 3NP1 for floor mounting to a 3-pole busbar system The feeding busbar (L1, L2 or L3) can be chosen freely If two such 3NP1 are combined by mechanical connection using the assembly kit, 2-pole 3NP1 for busbar mounting can also be assembled 	Article No.						
	3NP1 connection						
	With box terminals	3NP1921-1EE10	■				
	3NP1931-1EE10		■				

Assembly kits

Assembly kits for mounting on DIN rail

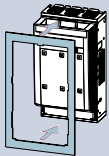
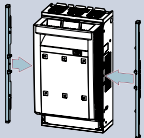
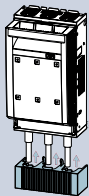
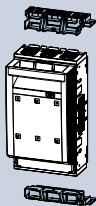


- Must be mounted on the rear of a 3NP1 for floor mounting
- Mounting of the 3NP1 on a DIN rail is achieved for size NH000 by mounting on a DIN rail, and for sizes NH00 and NH1 between two DIN rails that are 125 or 150 mm apart

	1/2-pole	3-pole	4-pole	NH000 narrow	NH000	NH00	NH1	NH2	NH3
Article No.	Article No.	Article No.							
3NP1921-1EA00	3NP1923-1EA00	3NP1924-1EA00		■					
–	3NP1913-1EB00 new	–	■						
3NP1931-1EB00	3NP1933-1EB00	3NP1933-1EB00				■			
3NP1943-1EB00	3NP1943-1EB00	3NP1943-1EB00					■		

3NP1 fuse switch disconnectors

Accessories

	1-pole	3-pole	NH000 narrow	NH000	NH00	NH1	NH2	NH3	
Masking frames and covers									
Masking frames									
 <ul style="list-style-type: none"> Used to cover an existing gap for a masking frame mounted on the application side 	Outer dimensions (H×W)	Article No.	Article No.						
	215 × 130 mm	–	3NP1923-1DA00		■				
	215 × 130 mm	–	3NP1933-1DA00			■			
	375 × 220 mm	–	3NP1943-1DA00				■		
	375 × 245 mm	–	3NP1953-1DA00					■	
	375 × 290 mm	–	3NP1963-1DA00						■
Masking frame supports									
 <ul style="list-style-type: none"> Are mounted on the side of the 3NP1 and prevent the supported masking frame from sagging (pack of 2 units) 	Article No.	Article No.							
	3NP1923-1CF00	3NP1923-1CF00			■				
	–	3NP1913-1CF00 ¹⁾	■						
	3NP1933-1CF00	3NP1933-1CF00			■				
	3NP1943-1CF00	3NP1943-1CF00				■	■	■	
Cable connection covers									
 <ul style="list-style-type: none"> Extends the terminal covers integrated in the 3NP1 In the version with rear reach-around protection, the underside is also covered 	Version	Article No.	Article No.						
	Without rear reach-around protection	3NP1921-1CB00	3NP1923-1CB00 ¹⁾			■			
		–	3NP1913-1CB00	■					
		3NP1931-1CB00	3NP1933-1CB00 ²⁾			■			
		3NP1941-1CB00	3NP1943-1CB00				■		
		3NP1951-1CB00	3NP1953-1CB00					■	
		3NP1961-1CB00	3NP1963-1CB00						■
	With rear reach-around protection	–	3NP1933-1CC00 ¹⁾			■			
		3NP1931-1CD00	3NP1933-1CD00 ³⁾			■			
		3NP1941-1CD00	3NP1943-1CD00				■		
		3NP1951-1CD00	3NP1953-1CD00					■	
		3NP1961-1CD00	3NP1963-1CD00						■
		Reach-around protection for busbar (spare part)							
 <ul style="list-style-type: none"> Covers the busbar For conversion of a 3NP1 to another busbar system 		For busbar systems	Article No.	Article No.					
	Siemens 8US	–	3NP1923-1CA10			■			
		–	3NP1913-1CA10	■					
		–	3NP1933-1CA10			■			
		3NP1941-1CA10	–				■	■	■
		–	3NP1943-1CA10					■	
		–	3NP1953-1CA10						■
	Siemens 8US compact	–	3NP1963-1CA10						■
		–	3NP1923-1CA30			■			
		Rittal	–	3NP1923-1CA20			■		
	Rittal	–	3NP1913-1CA10						
		–	3NP1933-1CA20			■			
		–	3NP1943-1CA20					■	
		–	3NP1953-1CA20						■
		–	3NP1963-1CA20						■
–		3NP1923-1CA20			■				

¹⁾ Only for 3NP1 for mounting on busbar systems

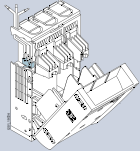
²⁾ Only for 3NP1 with flat terminals

³⁾ Only for 3NP1 with flat terminals for floor mounting

Further accessories

Auxiliary switches

- Up to 2 auxiliary switches can be mounted
- From size NH00, it is possible to choose whether the auxiliary switch will switch simultaneously with the fuses or leading on switch-on. (only leading possible for size NH000)



Contacts

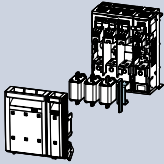
1 CO

Article No.

	NH000 narrow	NH000	NH00	NH1	NH2	NH3
3NP1920-1FA00		■				
3NP1910-1FA00	■					
3NP1930-1FA00			■			
3NP1940-1FA00				■	■	■
3NP1920-1FB00		■				
3NP1930-1FB00			■			
3NP1940-1FB00				■	■	■

1 CO, solid-state compatible

Isolating blades



- Are used in a 3NP1 if only the isolating function of a 3NP1 is required and not protection with fuses or in the neutral conductor of a 4-pole 3NP1.
- The isolating blade, which is leading switch-on and lagging switch-off, is used in the neutral conductor of a 4-pole 3NP1 if shifting of the neutral point of the 3P+N system has to be avoided during switching.

Version

Switching simultaneously with fuses

Article No.

	NH000 narrow	NH000	NH00	NH1	NH2	NH3
3NG1002		■	■			
3NG1202				■		
3NG1302					■	
3NG1402						■
3NP1924-1MA20		■				
3NP1934-1MA20			■			
3NP1944-1MA20				■		
3NP1954-1MA20					■	
3NP1964-1MA20						■

Leading switch-on, lagging switch-off

3NP1 fuse switch disconnectors

Further accessories

Fuse carriers (spare part)

- For retrofitting fuse monitoring on an existing 3NP1



	1-pole	3-pole	NH000 narrow	NH000	NH00	NH1	NH2	NH3
Version	Article No.	Article No.						
Standard – without fuse monitoring	3NP1921-1GA00	3NP1923-1GA00		■				
	–	3NP1913-1GA00	■					
	3NP1931-1GA00	3NP1933-1GA00			■			
	3NP1941-1GA00	3NP1943-1GA00				■		
	3NP1951-1GA00	3NP1953-1GA00					■	
	3NP1961-1GA00	3NP1963-1GA00						■
MFM - for operational voltage 24 ... 690 V AC (L-L)/ 24 ... 240 V DC (L+ - L-)	–	3NP1923-1GB10		■				
	–	3NP1933-1GB10			■			
	–	3NP1943-1GB10				■		
	–	3NP1953-1GB10					■	
	–	3NP1963-1GB10						■
EFM10 - for operational voltage 230 ... 690 V AC (L-L)	–	3NP1923-1GB20		■				
	–	3NP1933-1GB20			■			
	–	3NP1943-1GB20				■		
	–	3NP1953-1GB20					■	
	–	3NP1963-1GB20						■
EFM15 - for operational voltage 24 ... 240 V AC (L - N)/ 24 ... 250 V DC (L+ - L-)	3NP1921-1GB43	–		■				
	3NP1931-1GB43	–			■			
	3NP1941-1GB43	–				■		
	3NP1951-1GB43	–					■	
	3NP1961-1GB43	–						■
EFM15 - for operational voltage 110 ... 690 V AC (L - N)	3NP1921-1GB41	–		■				
	3NP1931-1GB41	–			■			
	3NP1941-1GB41	–				■		
	3NP1951-1GB41	–					■	
	3NP1961-1GB41	–						■
EFM15 - for operational voltage 120 ... 440 V DC (L - N)	3NP1921-1GB44	–		■				
	3NP1931-1GB44	–			■			
	3NP1941-1GB44	–				■		
	3NP1951-1GB44	–					■	
	3NP1961-1GB44	–						■
EFM15 - for operational voltage 190 ... 690 V AC (L - L)	–	3NP1923-1GB42		■				
	–	3NP1933-1GB42			■			
	–	3NP1943-1GB42				■		
	–	3NP1953-1GB42					■	
	–	3NP1963-1GB42						■
EFM15 - for operational voltage 220 ... 440 V DC (L+ - L-)	–	3NP1923-1GB45		■				
	–	3NP1933-1GB45			■			
	–	3NP1943-1GB45				■		
	–	3NP1953-1GB45					■	
	–	3NP1963-1GB45						■
EFM20 - for operational voltage 230 ... 690 V AC (L - L)	–	3NP1923-1GB30		■				
	–	3NP1933-1GB30			■			
	–	3NP1943-1GB30				■		
	–	3NP1953-1GB30					■	
	–	3NP1963-1GB30						■
EFM25 - for operational voltage 220 ... 440 V DC (L+ - L-)	–	3NP1923-1GB50		■				
	–	3NP1933-1GB50			■			
	–	3NP1943-1GB50				■		
	–	3NP1953-1GB50					■	
	–	3NP1963-1GB50						■

3NP5 fuse switch disconnectors

System overview

Basic units



Floor mounting



For 40 mm busbar system

Connection parts



Clamp terminals



Busbar adapters for 60 mm systems

Masking frames and covers

Molded-plastic
masking frames

Cable connection covers

Further accessories



Auxiliary switches



Arc chutes

Assembly kits for
flush mounting

Fuse carriers

Note:

You will find a detailed range of accessories with the basic units.

General information



3NA COM LV HRC fuse links



The new 3NA COM LV HRC fuse links with communication and measuring function make your products communication-capable.

See [Fuse Systems](#), page 7/50



System description

You will find further information under:
sie.ag/2UlrAvy



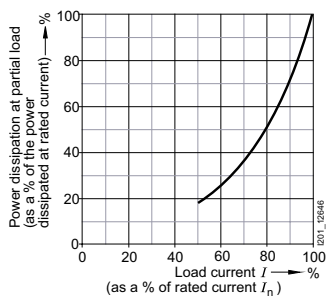
The 3NP5 fuse switch disconnector is an extremely robust device for extreme operating conditions. The fuse carrier has a pretensioned spring that prevents accidental, slow closure. All 3NP5 are designed for mounting on a mounting plate. Size NH00 is also available in versions for 40 mm busbar systems. All sizes can also be mounted using adapters on 60 mm busbar systems.

8



Suitable fuses

You will find further information under:
sie.ag/2UlrAvy



The 3NP5 fuse switch disconnector is suitable for all fuses with LV HRC design in sizes 000 to 3 that comply with IEC 60269-2, including fuses for cable and line protection and motor protection. Fuses for semiconductor protection (Siemens trademark SITOR) can also be used. However, some of these fuses have substantially higher power losses than fuses according to IEC 60269-2. This means that the load current has to be reduced until the value that is permissible in the fuse switch disconnector is not exceeded. For use of Siemens SITOR semiconductor fuses, ready-made derating tables are available in the linked document.

3NP5 fuse switch disconnectors







Type of mounting	Auxiliary switches	$I_u = 160 \text{ A}$	$I_u = 250 \text{ A}$	$I_u = 400 \text{ A}$	$I_u = 630 \text{ A}$
Without fuse monitoring					
Floor mounting	Without	3NP5060-0CA00	3NP5260-0CA00	3NP5360-0CA00	3NP5460-0CA00
	1 NO + 1 NC	3NP5060-0CA10	3NP5260-0CA10	3NP5360-0CA10	3NP5460-0CA10
Mounting on 40 mm busbar systems	Without	3NP5065-1CF00	–	–	–
	1 NO + 1 NC	3NP5065-1CF10	–	–	–
Electromechanical fuse monitoring with 1 NO + 1 NC as a signaling contact					
Floor mounting	1 NO + 1 NC	3NP5060-0EA86	3NP5260-0EA86	3NP5360-0EA86	3NP5460-0EA86
Mounting on 40 mm busbar systems	1 NO + 1 NC	3NP5065-1EF86	–	–	–
Electromechanical fuse monitoring with 2 NO as a signaling contact					
Floor mounting	1 NO + 1 NC	3NP5060-0EA26	3NP5260-0EA26	3NP5360-0EA26	3NP5460-0EA26
Mounting on 40 mm busbar systems	1 NO + 1 NC	3NP5065-1EF26	–	–	–

8

Accessories

				NH00	NH1	NH 2	NH3
Clamp terminals							
	Version	Scope of supply	Article No.				
	For retrofitting to 3NP5 with flat terminals	3 units	3NY1903 3NY1907	■	■		
Busbar adapters							
	• For 60 mm busbar system						
	Version		Article No.				
	For adaptation of a 3NP5, for floor mounting on a 60-mm busbar system		8US1291-4SB00 8US1210-4AG00	■		■	■
Covers for cable lug connections							
	Version	Scope of supply	Article No.				
	Can be screwed onto the free end of the screw	6 units	3NY1241 3NY1245		■		■
Covers for 3NP5, with auxiliary switch mounted							
	• With punched cutouts for auxiliary switches						
	Color	Version	Dimensions	Article No.			
	Gray	Flat	215 × 135 mm	3NY1115	■		
	Black	Flat, with additional bending edges	290 × 135 mm	3NY1116	■		
Covers for 3NP5, without auxiliary switches mounted							
	• With prepunched cutouts for retrofitting an auxiliary switch						
	Color	Version	Dimensions	Article No.			
	Gray	Flat	215 × 135 mm	3NY1105	■		
	Black	Flat	290 × 135 mm	3NY1106	■		
		Angled	265 × 135 mm	3NY1107	■		
	Flat, with additional bending edges	290 × 135 mm	3NY1108	■			
Auxiliary switches							
	Version		Article No.				
	1 NO + 1 NC, including mounting kit		3NY3033 3NY3034	■		■	■

Accessories

			NH00	NH1	NH 2	NH3			
Arc chutes									
	• Spare part for arc chutes installed in the factory, one unit per switch is required for NH00, three units for NH1 to NH3								
			Article No.						
			3NY4031	■					
			3NY4011		■				
		3NY4012			■	■			
Assembly kits for flush mounting in front panel									
	Version		Article No.						
	Assembly kit with cover and mounting accessories		3NY1208	■					
			3NY1210		■				
			3NY1211			■			
			3NY1212				■		
	Covers (spare part for assembly kit)		3NY1102		■				
		3NY1103			■				
Fuse carriers									
	Version		Article No.						
	Without fuse monitoring		3NY1074	■					
			3NY1371		■				
			3NY1372			■			
			3NY1373				■		
	With electromechanical fuse monitoring by circuit breakers, signaling contact 1 NO + 1 NC, without connecting cable		3NY1420	■					
			3NY1421		■				
		3NY1422			■				
		3NY1423				■			
Connectors and connecting cables									
	Version		Length		Article No.				
	For electromechanical fuse monitoring		1 m		3NY1910	■	■	■	■
			3 m		3NY1911	■	■	■	■

3NJ4 fuse switch disconnectors

System overview

1-pole switchable



NH00/NH000 ... NH3
(690 V)



NH4a
(690 V)



NH1 ... NH3 (690 V) for
integratable current transformers

3-pole switchable



NH00/NH000 ... NH3
(690 V)



NH00/NH000 ... NH3
(690 V) for integratable
current transformers



NH00/NH000 ... NH3
(690 V) with electronic
fuse monitoring EFM



NH00/NH000 ... NH3
(690 V) for integratable
current transformers with
electronic fuse monitoring
EFM



NH3 (400 V) for
secondary-side fusing
of transformers and
incoming block



NH00/NH000,
NH1 and NH3
(800 V)

8

Accessories



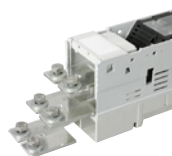
Covers



Adapters on
busbar systems



Mounting and
assembly elements



Busbar connection
assembly kits



Fuses



Current
transformers

Note:

You will find a detailed range of accessories with the basic units.

General information



3NA COM LV HRC fuse links



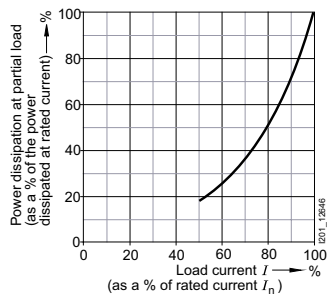
The new the 3NA COM LV HRC fuse links with communication and measuring function make your products communication-capable.

See [Fuse Systems](#), page 7/50



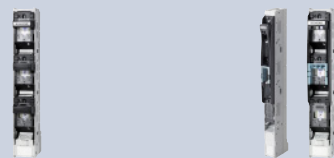
Suitable fuses

You will find further information under:
sie.ag/2UlrAvy



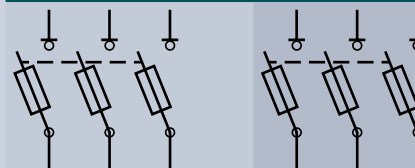
The 3NJ4 fuse switch disconnector is suitable for all fuses with LV HRC design in sizes 000 to 3 that comply with IEC 60269-2, including fuses for cable and line protection.

3NJ4 fuse switch disconnectors



1-pole switchable

3-pole switchable

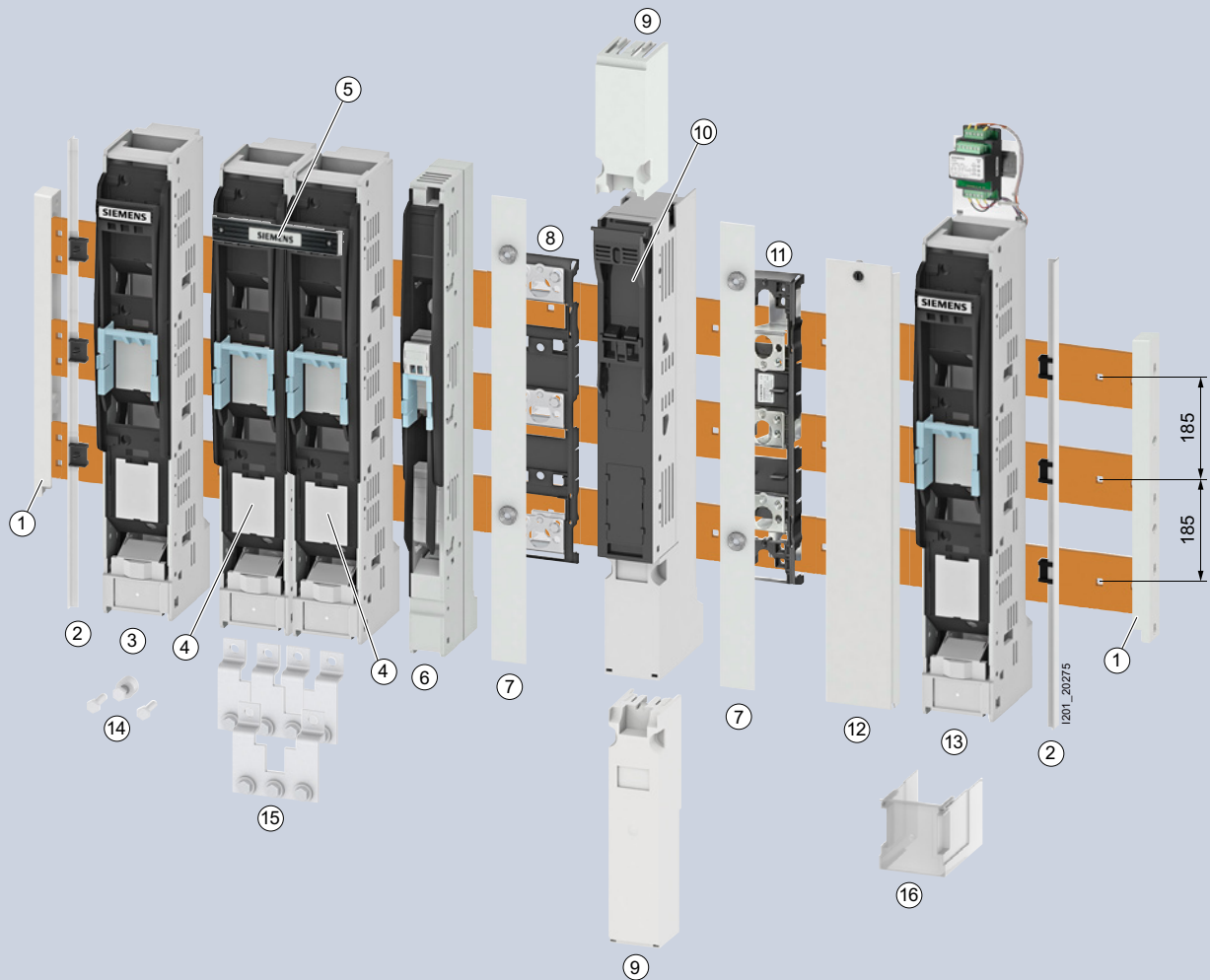


Rated operational current I_e	Busbar center-to-center spacing	Fuse size	Connection		
NH00/NH000 ... NH3 (690 V)					
160 A	100 mm	NH00/NH000	M8 flat terminal	–	3NJ4103-3BF02
			F70 box terminal	–	3NJ4103-3BR02
250 A	185 mm	NH00/NH000 ¹⁾	M8 flat terminal	3NJ4101-3BF01	3NJ4103-3BF01
			M10 flat terminal	3NJ4121-3BF01	3NJ4123-3BF01
			M12 stud terminal	–	3NJ4123-3BJ01
400 A	185 mm	NH1	V terminal	–	3NJ4123-3BT01
			M12 flat terminal	3NJ4131-3BF01	3NJ4133-3BF01
			M12 stud terminal	–	3NJ4133-3BJ01
630 A	185 mm	NH2	V terminal	–	3NJ4133-3BT01
			M12 flat terminal	3NJ4141-3BF01	3NJ4143-3BF01
			M12 stud terminal	–	3NJ4143-3BJ01
630 A	185 mm	NH3	V terminal	–	3NJ4143-3BT01
			M12 flat terminal	3NJ4141-3BF01	3NJ4143-3BF01
			M12 stud terminal	–	3NJ4143-3BJ01
NH00/NH000 ... NH4a (690 V)					
1250 A	185 mm	NH4a	M16 × 60 stud terminal	3NJ5643-0BB00	–
NH00/NH000 ... NH3 (690 V) for integratable current transformers					
160 A	100 mm	NH00/NH000	M8 flat terminal	–	3NJ4103-3BF12
250 A	185 mm	NH1	M10 flat terminal	3NJ4121-3BF11	3NJ4123-3BF11
400 A	185 mm	NH2	M12 flat terminal	3NJ4131-3BF11	3NJ4133-3BF11
630 A	185 mm	NH3	M12 flat terminal	3NJ4141-3BF11	3NJ4143-3BF11
NH00/NH000 ... NH3 (690 V) with electronic fuse monitoring EFM					
160 A	100 mm	NH00/NH000	M8 flat terminal	–	3NJ4103-3CF02
250 A	185 mm	NH1	M10 flat terminal	–	3NJ4123-3CF01
400 A	185 mm	NH2/NH1	M12 flat terminal	–	3NJ4133-3CF01
630 A	185 mm	NH3/NH2	M12 flat terminal	–	3NJ4143-3CF01
NH00/NH000 ... NH3 (690 V) for integratable current transformers, with electronic fuse monitoring EFM					
160 A	100 mm	NH00/NH000	M8 flat terminal	–	3NJ4103-3CF12
250 A	185 mm	NH1	M10 flat terminal	–	3NJ4123-3CF11
400 A	185 mm	NH2/NH1	M12 flat terminal	–	3NJ4133-3CF11
630 A	185 mm	NH3/NH2	M12 flat terminal	–	3NJ4143-3CF11
NH3 (400 V) for secondary-side fusing of transformers and incoming block					
1000 A	185 mm	NH3	2 × M12 flat terminal	–	3NJ4153-3BF01
1250 A	185 mm	NH3	2 × M12 flat terminal	–	3NJ4183-3BF01
1600 A	185 mm	NH3	3 × M12 flat terminal	–	3NJ4163-3BF01
2000 A	185 mm	NH3	4 × M12 flat terminal	–	3NJ4173-3BF01
NH00/NH000, NH1 and NH3 (800 V)					
63 A	100 mm	NH00/NH000 ¹⁾	M8 flat terminal	–	3NJ4103-3DF02
	185 mm	NH00/NH000	M8 flat terminal	–	3NJ4103-3DF01
160 A	185 mm	NH1	M10 flat terminal	–	3NJ4123-3DF01
315 A	185 mm	NH3	M12 flat terminal	–	3NJ4143-3DF01

¹⁾ If mounted together with device sizes NH1 to NH3, a 3NJ5930-3BB adapter is required as an accessory to compensate for differences in height.

Note:

- Fixing screws for mounting on busbars must be ordered separately.



- | | | |
|-------------------------------------|-------------------------------------|---|
| ① Busbar support | ⑦ Unequipped section cover, 50 mm | ⑬ Switch disconnector, NH3, with EFM |
| ② Lateral masking frame support | ⑧ Adapter, 185 mm to 185 mm | ⑭ Assembly kit, 2 x 240 mm ² |
| ③ Switch disconnector, NH1 | ⑨ Cover, spacer | ⑮ Busbar connection assembly kit, 4 x 185 mm ² |
| ④ Switch disconnector, NH2 | ⑩ Switch disconnector, NH00, 100 mm | ⑯ Cover, NH1-3 |
| ⑤ Coupling of operating handle | ⑪ Adapter, 100 mm to 185 mm | |
| ⑥ Switch disconnector, NH00, 185 mm | ⑫ Blanking cover, 633 x 100 mm | |

3NJ4 fuse switch disconnectors

Accessories

⑧ Covers



- Additional touch protection when using cable lugs and as spacer

Size	Busbar center-to-center spacing	Version	Article No.
NH00	100 mm	Top and bottom	3NJ4912-1DA02
	185 mm	100 mm for bottom	3NJ4912-1FA01
		132 mm for top	3NJ4912-1FA00
⑩ NH1 ... NH3	Connection for top and bottom		3NJ4912-1AA01
NH3	For double in-line disconnectors		3NJ4912-1EA00

⑨ Blanking covers



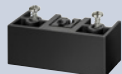
Version	Length	Width	Busbar center-to-center spacing	Article No.
For switchboard cutout	299 mm	50 mm	100 mm only	3NJ4912-2CA00
	633 mm	50 mm		3NJ4912-2AA00
	633 mm	100 mm		3NJ4912-2BA00

⑩ Lateral masking frame supports

- 3 clips with T profile

Size	Article No.
NH00 ... NH3	3NJ4912-2DA00

Fixing clips



Scope of supply	Article No.
1 set = 4 units, including fixing accessories	3NJ4918-0AA00

⑪ Unequipped section covers



Busbar center-to-center spacing	Width	Article No.
185 mm	50 mm	3NJ4912-3AA00
	100 mm	3NJ4912-3BA01
100 mm	50 mm	3NJ4912-3CA00

Adapters for screw fixing on busbar systems



- Adapters for screw fixing on busbar systems with 185 mm busbar center-to-center spacing
- For mounting 2 fuse switch disconnectors

Version	Fuse switch disconnectors	Article No.
Adaptation to sizes 1 ... 3	⑧ From 100 mm to 185 mm	3NJ4918-0DA02
	⑩ From 185 mm to 185 mm	3NJ5930-3BB
Adaptation to sizes 1 ... 3, with busbar terminal	From 100 mm to 185 mm	3NJ4918-0DB02

Adapters for screw fixing on busbar systems



- For fitting one fuse switch disconnector (= 3 separate brackets)

Version	Article No.
Adaptation of 100 mm to busbar system with 60 mm busbar center-to-center spacing	3NJ4918-0EA00

Fixing screws

- For fitting 3NJ4103 switch disconnectors with integratable current transformers onto adapters

Scope of supply	Article No.
1 set = 3 units	3NJ4918-0DC02

¹⁾ Touch protection only suitable for 3NJ4103-3BF02

²⁾ Touch protection only suitable for 3NJ4101-3BF01 and 3NJ4103-3BF01

3NJ4101	3NJ4103	3NJ412	3NJ413	3NJ414	3NJ415	3NJ416	3NJ417	3NJ418
■	■	■	■	■	■	■	■	■
		■	■	■	■	■	■	■
■	■	■	■	■				
	■ ¹⁾							
■	■ ¹⁾							
		■	■	■				
■	■	■	■	■	■	■	■	■
		■	■	■				
	■	■	■	■				
	■							

3NJ4 fuse switch disconnectors

Accessories

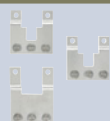
Busbar connection assembly kits for NH2 and NH3



- With flat terminals

Screws	Conductor cross-section	Article No.
M12	2× 240 mm ²	3NJ4911-5AA00
	2× 300 mm ² /3× 120 mm ²	3NJ4911-5BA00
M16	1× 400 mm ²	3NJ4911-5CA00

Busbar connection assembly kits for NH3



Version	Conductor cross-section	Article No.
For NH3 as double in-line disconnectors	3× 300 mm ² / ④ 4× 185 mm ²	3NJ4911-6AA00
	4× 240 mm ²	3NJ4911-6BA00

⑤ Mechanical coupling of operating handles	3NJ4911-6CA00
--	---------------

Fuses NH3



- Minimum order quantity 3 units

Version	Article No.
For protection of transformers, 630 kVA, 909 A	3NJ4914-8AA00

Isolating blades NH3

Rated operational current I_e	Article No.
1250 A	3NJ4914-8BA00

Current transformers .../1 A



Rated primary current I_{pr}	Accuracy class	Rated power P_n	Article No.
100/1 A	0.5	1.5 VA	3NJ4915-1EA10
	1	2.0 VA	3NJ4915-1EA20
	0.5 calibrated	2.5 VA	3NJ4915-1FA10
150/1 A	0.5	2.5 VA	3NJ4915-1FA10
	0.5 calibrated	2.5 VA	3NJ4915-1FA11
	1	3.0 VA	3NJ4915-1FA20
75/1 A	1	1.5 VA	3NJ4915-2DA20
100/1 A	0.5	1.5 VA	3NJ4915-2EA10
	1	2.0 VA	3NJ4915-2EA20
150/1 A	1	2.5 VA	3NJ4915-2FA20
250/1 A	0.5	2.5 VA	3NJ4915-2GA10
	0.5 calibrated	2.5 VA	3NJ4915-2GA11
	1	5.0 VA	3NJ4915-2GA20
400/1 A	0.5	2.5 VA	3NJ4915-2HA10
	0.5 calibrated	2.5 VA	3NJ4915-2HA11
	1	5.0 VA	3NJ4915-2HA20
500/1 A	0.5	2.5 VA	3NJ4915-2JA10
	1	5.0 VA	3NJ4915-2JA20
600/1 A	0.5	2.5 VA	3NJ4915-2KA10
	0.5 calibrated	2.5 VA	3NJ4915-2KA11
	1	5.0 VA	3NJ4915-2KA20



3NJ4 fuse switch disconnectors

Accessories

Current transformers .../5 A



Rated primary current I_{pr}	Accuracy class	Rated power P_n	Article No.
100/5 A	0.5	1.0 VA	3NJ4915-1EB10
	1	1.5 VA	3NJ4915-1EB20
150/5 A	0.5	1.5 VA	3NJ4915-1FB10
	0.5 calibrated	1.5 VA	3NJ4915-1FB11
	1	2.5 VA	3NJ4915-1FB20
75/5 A	1	1.5 VA	3NJ4915-2DB20
100/5 A	0.5	1.0 VA	3NJ4915-2EB10
	1	2.0 VA	3NJ4915-2EB20
150/5 A	0.5	1.5 VA	3NJ4915-2FB10
	1	2.5 VA	3NJ4915-2FB20
250/5 A	0.5	2.5 VA	3NJ4915-2GB10
	0.5 calibrated	2.5 VA	3NJ4915-2GB11
	1	3.75 VA	3NJ4915-2GB20
400/5 A	0.5	2.5 VA	3NJ4915-2HB10
	0.5 calibrated	2.5 VA	3NJ4915-2HB11
	1	3.75 VA	3NJ4915-2HB20
500/5 A	0.5	2.5 VA	3NJ4915-2JB10
	1	5.0 VA	3NJ4915-2JB20
600/5 A	0.5	2.5 VA	3NJ4915-2KB10
	0.5 calibrated	2.5 VA	3NJ4915-2KB11
	1	5.0 VA	3NJ4915-2KB20

5SG76 fuse switch disconnectors

System overview

MINIZED fuse switch disconnectors



1P

1P+N

2P

3P

3P+N



Number of poles	1P	1P+N	2P	3P	3P+N	
Fuse size	Rated current I_n	Mounting width 1 MW	Mounting width 2 MW	Mounting width 2 MW	Mounting width 3 MW	Mounting width 4 MW

MINIZED fuse switch disconnectors						
D01	6 A ¹⁾	5SG7611-0KK06	–	–	5SG7631-0KK06	–
	10 A	5SG7611-0KK10	–	–	5SG7631-0KK10	–
	16 A	5SG7611-0KK16	5SG7651-0KK16	5SG7621-0KK16	5SG7631-0KK16	5SG7661-0KK16

¹⁾ For 2 A, 4 A, 6 A fuses

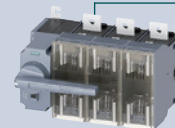
Note:
No NEOZED adapter sleeves are required for this type series

Switch disconnectors with fuses

Quick selection guide



3KF LV HRC



Size		1	1	1	2	2	3	4	5	5	
General technical specifications acc. to IEC 60947-3											
Basic data											
Rated uninterrupted current I_u	A	32	63	80	125	160	250	400	630	800	
For fuse links acc. to IEC 60269-2		000 and 00					0 and 1	1 and 2	2 and 3		
Rated operational voltage U_e	At 50/60 Hz AC	V AC					690				
	At DC – 2 conducting paths in series	V DC					220				
	At DC – 3 conducting paths in series	V DC					440				
	At DC	V DC					–				
Operating and short-circuit behavior											
Rated operational current I_e ¹⁾	At AC-21A AC-21B at 400 V	A	32	63	80	125	160	250	400	630	800
	At AC-21A AC-21B at 500 V	A	–	–	–	–	–	–	–	–	–
	At AC-21A AC-21B at 690 V	A	32	63	80	125	160	250	400	630	800
	At AC-22A AC-22B at 400 V	A	32	63	80	125	160	250	400	630	800
	At AC-22A AC-22B at 500 V	A	–	–	–	–	–	–	–	–	–
	At AC-22A AC-22B at 690 V	A	32	63	80	125	160	250	400	630	800
	At AC-23A AC-23B at 400 V	A	32	63	80	125	160	250	400	630	800
	At AC-23A AC-23B at 500 V	A	–	–	–	–	–	–	–	–	–
	At AC-23A AC-23B at 690 V	A	32	63	80	125	160	250	400	630	800
	At DC-21A DC-21B at 48 V	A	–	–	–	–	–	–	–	–	–
	At DC-21A DC-21B at 65 V	A	–	–	–	–	–	–	–	–	–
	At DC-21A DC-21B at 110 V	A	–	–	–	–	–	–	–	–	–
	At DC-21A DC-21B at 130 V	A	–	–	–	–	–	–	–	–	–
	At DC-21A DC-21B at 220 V	A	32	63	80	125	160	250	400	630	800
	At DC-21A DC-21B at 400 V	A	–	–	–	–	–	–	–	–	–
	At DC-21A DC-21B at 440 V	A	32	63	80	125	160	250	400	630	800
	At DC-22A DC-22B at 48 V	A	–	–	–	–	–	–	–	–	–
	At DC-22A DC-22B at 65 V	A	–	–	–	–	–	–	–	–	–
	At DC-22A DC-22B at 110 V	A	–	–	–	–	–	–	–	–	–
	At DC-22A DC-22B at 130 V	A	–	–	–	–	–	–	–	–	–
	At DC-22A DC-22B at 220 V	A	32	63	80	125	160	250	400	630	800
	At DC-22A DC-22B at 400 V	A	–	–	–	–	–	–	–	–	–
	At DC-22A DC-22B at 440 V	A	32	63	80	125	160	250	400	630	800
	At DC-23A DC-23B at 48 V	A	–	–	–	–	–	–	–	–	–
	At DC-23A DC-23B at 110 V	A	–	–	–	–	–	–	–	–	–
	At DC-23A DC-23B at 220 V	A	32	63	80	125	160	250	400	630	800
	At DC-23A DC-23B at 400 V	A	–	–	–	–	–	–	–	–	–
At DC-23A DC-23B at 440 V	A	32	63	80	125	160	250	400	630	800	
Motor switching capacity ²⁾	At AC-23A at 400 V	kW	15	30	37	55	90	132	220	355	400
	At AC-23A at 500 V	kW	18.5	37	55	75	110	160	280	400	560
	At AC-23A at 690 V	kW	30	55	75	110	132	250	400	630	800
Rated conditional short-circuit current with upstream fuse ³⁾	At 400/500 V AC	kA	100	100	100	100	100	100	100	100	
	At 690 V AC	kA	100	100	100	100	100	100	100	80	
Let-through current I_c of usable fuses, max. ³⁾	At 400/500 V AC	kA	11.8	11.8	11.8	18	18	33.7	37.1	77.4	
	At 690 V AC	kA	11.5	11.5	11.5	25.5	25.5	37.7	47	65	
Let-through current I^2t value of usable fuses, max. ³⁾	At 400/500 V AC	kA ² s	34	34	34	223	223	1500	2150	10400	
	At 690 V AC	kA ² s	55	55	55	360	360	940	2600	7000	
Maximum power loss of the usable fuses (per fuse)	W	6.5	7.5	8.5	11	12	25.5	34	48	60	
Degree of protection											
Maximum IP degree of protection (with a rotary operating mechanism)		IP65									
Maximum IP degree of protection		–									

¹⁾ Values valid even at +10% line voltage tolerance in case of AC

²⁾ Values are provided as a guide only and may vary depending on the make of motor

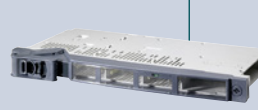
³⁾ Valid for combination of 3KF and fuse type 3NA/3ND, characteristic gG/aM



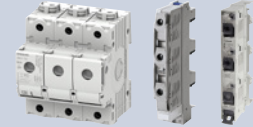
3KF SITOR



3NJ63



5SG7



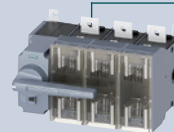
3KF SITOR									3NJ63				5SG7						
1	1	1	2	2	3	4	5	5	00	00	00	00	1	2	3	3	5SG71.	5SG7230	5SG7234.
32	63	80	125	160	250	400	630	800	-	-	-	-	-	-	-	-	63	63	63
000 and 00					0 and 1	1 and 2	2 and 3	000 and 00				1	1 and 2	2 and 3	D02	D02	D02		
690					500 ... 690				690		230 ... 690		400, 415	400	400				
220					230 ... 440				230 ... 440		-		130	110	-				
440					-				-		-		-	-	-				
-					-				-		-		65	-	-				
32	63	80	125	160	250	400	630	800	-	-	-	-	-	-	-	-	-	-	-
-	-	-	-	-	-	-	-	-	-	-	-	-	-	-	-	-	-	-	-
32	63	80	125	160	250	400	630	800	-	-	-	-	-	-	-	-	-	-	-
32	63	80	125	160	250	400	630	800	-	-	-	-	-	-	-	-	-	-	-
-	-	-	-	-	-	-	-	-	-	-	-	160	-	-	-	630	-	-	-
32	63	80	125	160	250	400	630	800	-	-	125	-	250	400	500	-	- 35	-	- 63
32	63	80	125	160	250	400	630	800	-	-	-	-	-	-	-	-	-	63 -	-
-	-	-	-	-	-	-	-	-	-	-	-	160	-	-	-	630	-	-	-
32	63	80	125	160	250	400	630	800	63	100	125	-	250	400	500	-	-	-	-
-	-	-	-	-	-	-	-	-	-	-	-	-	-	-	-	-	-	- 63	-
-	-	-	-	-	-	-	-	-	-	-	-	-	-	-	-	-	63	-	-
-	-	-	-	-	-	-	-	-	-	-	-	-	-	-	-	-	63	-	-
32	63	80	125	160	250	400	630	800	-	-	-	-	-	-	-	-	-	-	-
-	-	-	-	-	-	-	-	-	-	-	-	-	-	-	-	-	-	-	-
32	63	80	125	160	250	400	630	800	-	-	-	-	250	400	-	630	-	- 63	-
-	-	-	-	-	-	-	-	-	-	-	-	-	-	-	-	-	- 63	-	-
-	-	-	-	-	-	-	-	-	-	-	-	-	-	-	-	-	- 63	-	-
-	-	-	-	-	-	-	-	-	-	-	-	-	-	-	-	-	- 63	-	-
32	63	80	125	160	250	400	630	800	-	-	-	-	-	-	-	-	-	-	-
-	-	-	-	-	-	-	-	-	-	-	-	-	-	-	-	-	-	-	-
32	63	80	125	160	250	400	630	800	-	-	-	-	-	-	-	-	- 63	-	-
-	-	-	-	-	-	-	-	-	-	-	-	-	-	-	-	-	-	-	-
-	-	-	-	-	-	-	-	-	-	-	-	-	-	-	-	-	-	-	-
32	63	80	125	160	250	400	630	800	-	-	-	160	250	400	-	630	-	-	-
-	-	-	-	-	-	-	-	-	-	-	-	-	-	-	-	-	-	-	-
32	63	80	125	160	250	400	630	800	-	-	-	-	-	-	-	-	-	-	-
15	30	37	55	90	132	220	355	400	-	-	-	-	-	-	-	-	-	-	-
18.5	37	55	75	110	160	280	400	560	-	-	-	-	-	-	-	-	-	-	-
30	55	75	110	132	250	400	630	800	-	-	-	-	-	-	-	-	-	-	-
100	100	100	100	100	100	100	100	100	-							50/-	50/-	50/-	
100	100	100	100	100	100	100	80	80	60 ... 100 kA _{rms}							-	-	-	
11.8	11.8	11.8	18	18	33.7	37.1	77.4	77.4	-							-	-	-	
11.5	11.5	11.5	25.5	25.5	37.7	47	65	65	-							-	-	-	
34	34	34	223	223	1500	2150	10400	10400	-							-	-	-	
55	55	55	360	360	940	2600	7000	7000	-							-	-	-	
7	8	12	20	26	36	55	68	85	-							5.5	5.5	5.5	
IP65									IP41							-	-	-	
-									-							IP20	-	-	

Switch disconnectors with fuses

Quick selection guide (continued)



3KF LV HRC



Size		1	1	1	2	2	3	4	5	5
General technical specifications acc. to UL										
Basic data										
Certification according to UL standard		–	–	–	–	–	–	–	–	–
I_n acc. to UL 508	A	–	–	–	–	–	–	–	–	–
U_e acc. to UL 508		–	–	–	–	–	–	–	–	–
Operating and short-circuit behavior										
Operational power, 3-phase	At 240 V	kA	–	–	–	–	–	–	–	–
	At 480 V	kA	–	–	–	–	–	–	–	–
	At 600 V	kA	–	–	–	–	–	–	–	–
Short circuit current rating (SCCR)		–	–	–	–	–	–	–	–	–
Fuse type		–	–	–	–	–	–	–	–	–

Further information

Technical specifications

[See page 8/128](#)

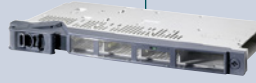
Configuration in SIMARIS



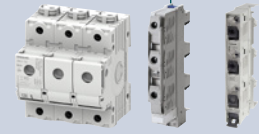
3KF SITOR



3NJ63



5SG7



1	1	1	2	2	3	4	5	5	00	00	00	00	1	2	3	3	5SG71.	5SG7230	5SG7234.	
UL 508									-	-	-	-	-	-	-	-	-	-	-	
32	56	56	125	125	500	320	530	530	-	-	-	-	-	-	-	-	-	-	-	
600									-	-	-	-	-	-	-	-	-	-	-	
10	15	15	25	30	60	100	125	150	-	-	-	-	-	-	-	-	-	-	-	
25	30	40	60	75	150	250	300	300	-	-	-	-	-	-	-	-	-	-	-	
30	40	40	50	50	1255	250	300	350	-	-	-	-	-	-	-	-	-	-	-	
100	100	100	100	100	100	100	100	100	-	-	-	-	-	-	-	-	-	-	-	
K-1, RK1, CC, J, T	K-1, RK1, CC, J, T	K-1, RK1, CC, J, T	K-1, RK1, J, T	K-1, RK1, J, T	K-1, RK1, J, T	K-1, RK1, CC, J, T	K-1, RK1, J, T	K-1, RK1, J, T	-	-	-	-	-	-	-	-	-	-	-	
See page 8/120									See page 8/136									See page 8/144		
Configuration in SIMARIS									Configuration in SIMARIS									Configuration in SIMARIS		

3KF switch disconnectors with fuses

System overview

Complete units with direct operating mechanisms



Front operating mechanisms, 3-pole



Front operating mechanisms, 4-pole

Basic units



Front operating mechanisms, 3-pole



Front operating mechanisms, 4-pole



Lateral operating mechanisms, 3-pole



Lateral operating mechanisms, 4-pole



3KF SITOR

8

Additional poles



4th contact elements



N terminals



N/PE terminals



Auxiliary switch modules

Operating mechanisms



Direct operating mechanisms



Door-coupling rotary operating mechanisms



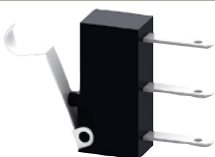
Handles for door-coupling rotary operating mechanisms



Further accessories for door-coupling rotary operating mechanisms



Further accessories and spare parts



Auxiliary switches



Fuse monitoring



Terminal covers



Mounting elements



Fuse covers

Note:

You will find a detailed range of accessories with the basic units.

General information



3NA COM LV HRC fuse links



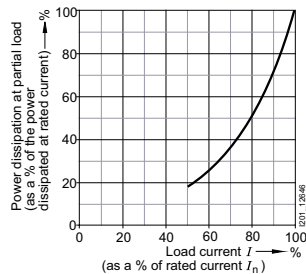
The new the 3NA COM LV HRC fuse links with communication and measuring function make your products communication-capable.

See [Fuse Systems](#), page 7/30



Suitable fuses

You will find further information under:
sie.ag/2UlrAvy



The 3KF switch disconnector with fuses is suitable for all fuses with LV HRC design in sizes 000 to 3 that comply with IEC 60269-2. These include fuses for cable and line protection and motor protection. Fuses for semiconductor protection (Siemens trademark SITOR) can also be used. However, some of these fuses have substantially higher power losses than fuses according to IEC 60269-2. This means that the load current has to be reduced until the value that is permissible in the switch disconnector with fuses is not exceeded. For use of Siemens semiconductor fuses (SITOR), ready-made derating tables are available in the linked document.

8

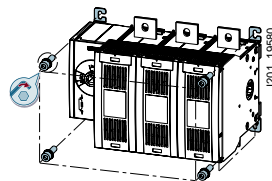


Types of mounting

You will find further information under:
sie.ag/2UlrAvy

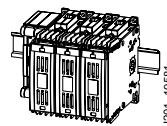


Floor mounting



All 3KF switch disconnectors with fuses are designed for floor mounting.

DIN rail



Size 1 can be snapped onto a DIN rail (TH35 according to EN 60715) as an alternative mounting method.

3KF switch disconnectors with fuses

General information

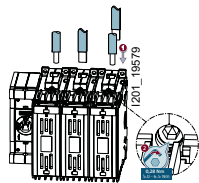


Electrical connection

You will find further information under:
sie.ag/2UlrAvy

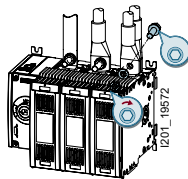


Box terminals



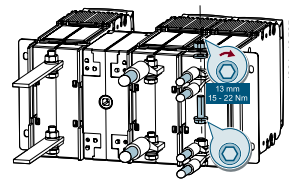
The box terminals for size 1 (32 A ... 80 A) are designed to allow the rapid connection of stripped conductors.

Flat terminals



Sizes 2 ... 5 are available with flat terminals, for the connection of cable lugs or busbar systems.

Flat terminals at rear



Sizes 1 and 2 (32 A, 63 A and 125 A) are available with rear flat terminals, for the connection of cable lugs or busbar systems.

8

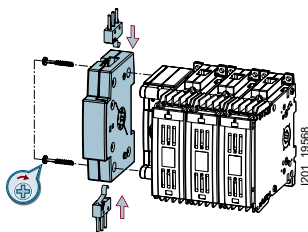


Auxiliary switch modules and auxiliary switches

You will find further information under:
sie.ag/2UlrAvy

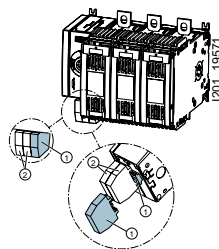


Size 1



The auxiliary switches used for size 1 are microswitches (changeover contacts), which can be snapped into an auxiliary switch module. This auxiliary switch module is mounted on the side of the switch disconnector with fuses in the same way as an additional pole. A maximum of two microswitches can be installed in each auxiliary switch module.

Sizes 2 ... 5



- ① Auxiliary switch, leading
- ② Auxiliary switch, simultaneous

For sizes 2 ... 5, the auxiliary switches are directly attached to the operating mechanism module. The auxiliary switch with the leading switching function is always installed in the right-hand mounting location. The other locations are provided for simultaneously switching with the main contacts. Auxiliary switches with spring-type terminals from the 3SU1 program can also be used.



Differentiation 3KF SITOR and derating tables for SITOR fuses

You will find further information under: sie.ag/2UlrAvy



Size 1



3KF SITOR is a variation of the proven switch disconnector with 3KF LV HRC fuses and provides optimized heat dissipation and permits the use of fuses with substantially higher power losses. All 3KF SITOR types are approved according to UL508.

Sizes 2 ... 5

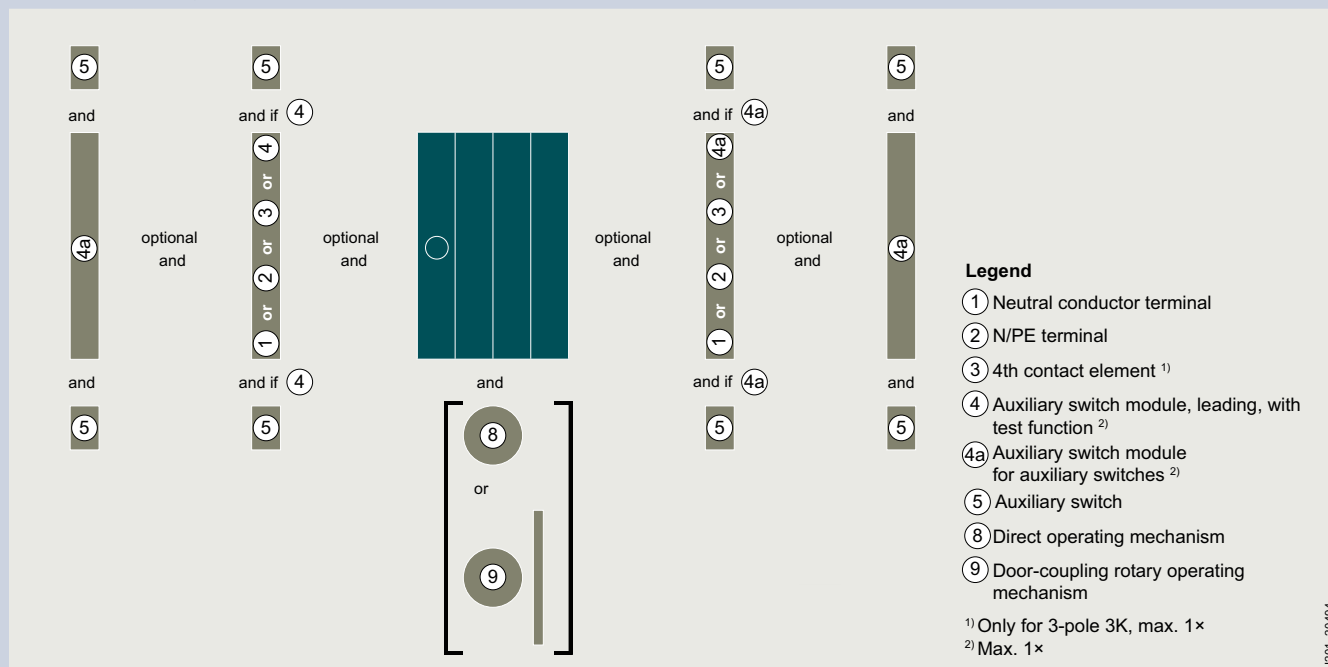
Type	Rated Current	Rated Voltage	Rated Power	Type	Permissible load currents of fuses when installed in									
					Type HRC 50					Type HRC 100				
IEC	UL	IEC	UL	IEC	UL	IEC	UL	IEC	UL	IEC	UL	IEC	UL	
3KF1000-1	100	690V	100	100	7.5	20.0	20.0	20.0	20.0	20.0	20.0	20.0	20.0	20.0
3KF1000-2	100	690V	100	100	7.5	20.0	20.0	20.0	20.0	20.0	20.0	20.0	20.0	
3KF1000-3	100	690V	100	100	7.5	20.0	20.0	20.0	20.0	20.0	20.0	20.0	20.0	
3KF1000-4	100	690V	100	100	7.5	20.0	20.0	20.0	20.0	20.0	20.0	20.0	20.0	
3KF1000-5	100	690V	100	100	7.5	20.0	20.0	20.0	20.0	20.0	20.0	20.0	20.0	
3KF1000-6	100	690V	100	100	7.5	20.0	20.0	20.0	20.0	20.0	20.0	20.0	20.0	
3KF1000-7	100	690V	100	100	7.5	20.0	20.0	20.0	20.0	20.0	20.0	20.0	20.0	
3KF1000-8	100	690V	100	100	7.5	20.0	20.0	20.0	20.0	20.0	20.0	20.0	20.0	
3KF1000-9	100	690V	100	100	7.5	20.0	20.0	20.0	20.0	20.0	20.0	20.0	20.0	
3KF1000-10	100	690V	100	100	7.5	20.0	20.0	20.0	20.0	20.0	20.0	20.0	20.0	
3KF1000-11	100	690V	100	100	7.5	20.0	20.0	20.0	20.0	20.0	20.0	20.0	20.0	
3KF1000-12	100	690V	100	100	7.5	20.0	20.0	20.0	20.0	20.0	20.0	20.0	20.0	
3KF1000-13	100	690V	100	100	7.5	20.0	20.0	20.0	20.0	20.0	20.0	20.0	20.0	
3KF1000-14	100	690V	100	100	7.5	20.0	20.0	20.0	20.0	20.0	20.0	20.0	20.0	
3KF1000-15	100	690V	100	100	7.5	20.0	20.0	20.0	20.0	20.0	20.0	20.0	20.0	
3KF1000-16	100	690V	100	100	7.5	20.0	20.0	20.0	20.0	20.0	20.0	20.0	20.0	
3KF1000-17	100	690V	100	100	7.5	20.0	20.0	20.0	20.0	20.0	20.0	20.0	20.0	
3KF1000-18	100	690V	100	100	7.5	20.0	20.0	20.0	20.0	20.0	20.0	20.0	20.0	
3KF1000-19	100	690V	100	100	7.5	20.0	20.0	20.0	20.0	20.0	20.0	20.0	20.0	
3KF1000-20	100	690V	100	100	7.5	20.0	20.0	20.0	20.0	20.0	20.0	20.0	20.0	
3KF1000-21	100	690V	100	100	7.5	20.0	20.0	20.0	20.0	20.0	20.0	20.0	20.0	
3KF1000-22	100	690V	100	100	7.5	20.0	20.0	20.0	20.0	20.0	20.0	20.0	20.0	
3KF1000-23	100	690V	100	100	7.5	20.0	20.0	20.0	20.0	20.0	20.0	20.0	20.0	
3KF1000-24	100	690V	100	100	7.5	20.0	20.0	20.0	20.0	20.0	20.0	20.0	20.0	
3KF1000-25	100	690V	100	100	7.5	20.0	20.0	20.0	20.0	20.0	20.0	20.0	20.0	
3KF1000-26	100	690V	100	100	7.5	20.0	20.0	20.0	20.0	20.0	20.0	20.0	20.0	
3KF1000-27	100	690V	100	100	7.5	20.0	20.0	20.0	20.0	20.0	20.0	20.0	20.0	
3KF1000-28	100	690V	100	100	7.5	20.0	20.0	20.0	20.0	20.0	20.0	20.0	20.0	
3KF1000-29	100	690V	100	100	7.5	20.0	20.0	20.0	20.0	20.0	20.0	20.0	20.0	
3KF1000-30	100	690V	100	100	7.5	20.0	20.0	20.0	20.0	20.0	20.0	20.0	20.0	

Siemens provides you with pretested load currents of the SITOR semiconductor fuses for installation in the 3KF SITOR. The derating tables are provided both for IEC constraints and for UL constraints and are intended to help you with selection. The permissible load faults for the 3KF LV HRC were calculated from the test results of the 3KF SITOR.

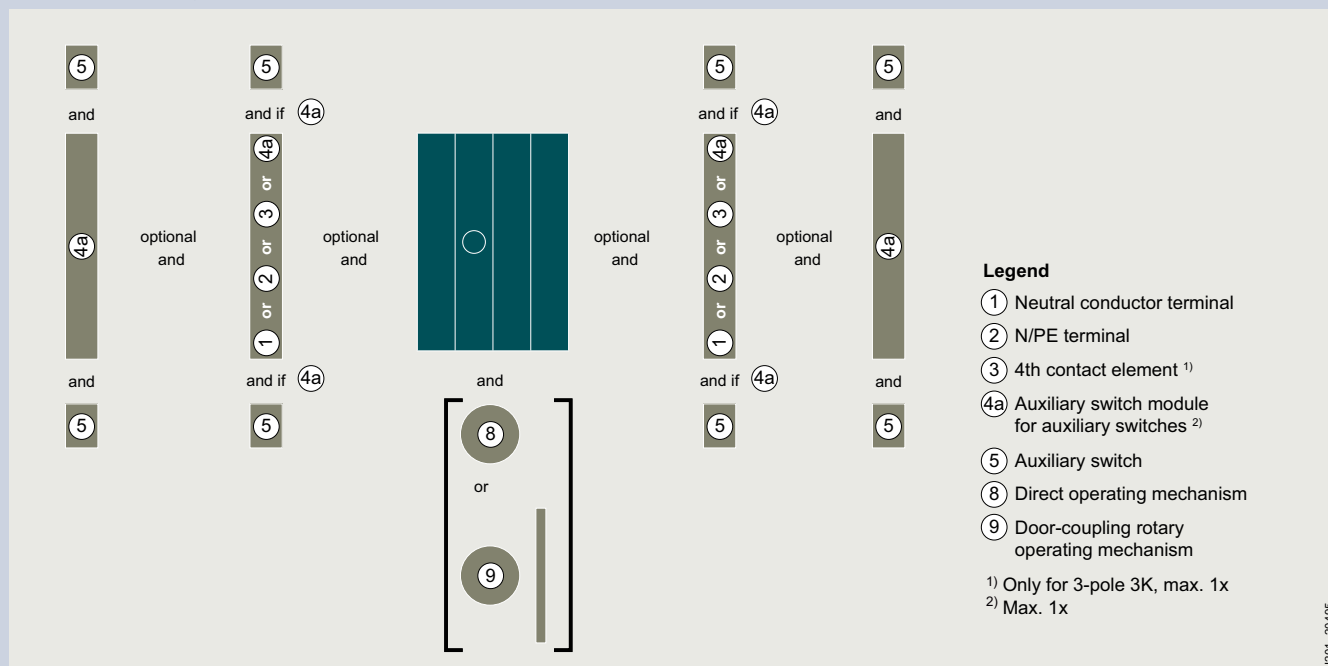
3KF switch disconnectors with fuses

Mounting concept and accessories 3KF

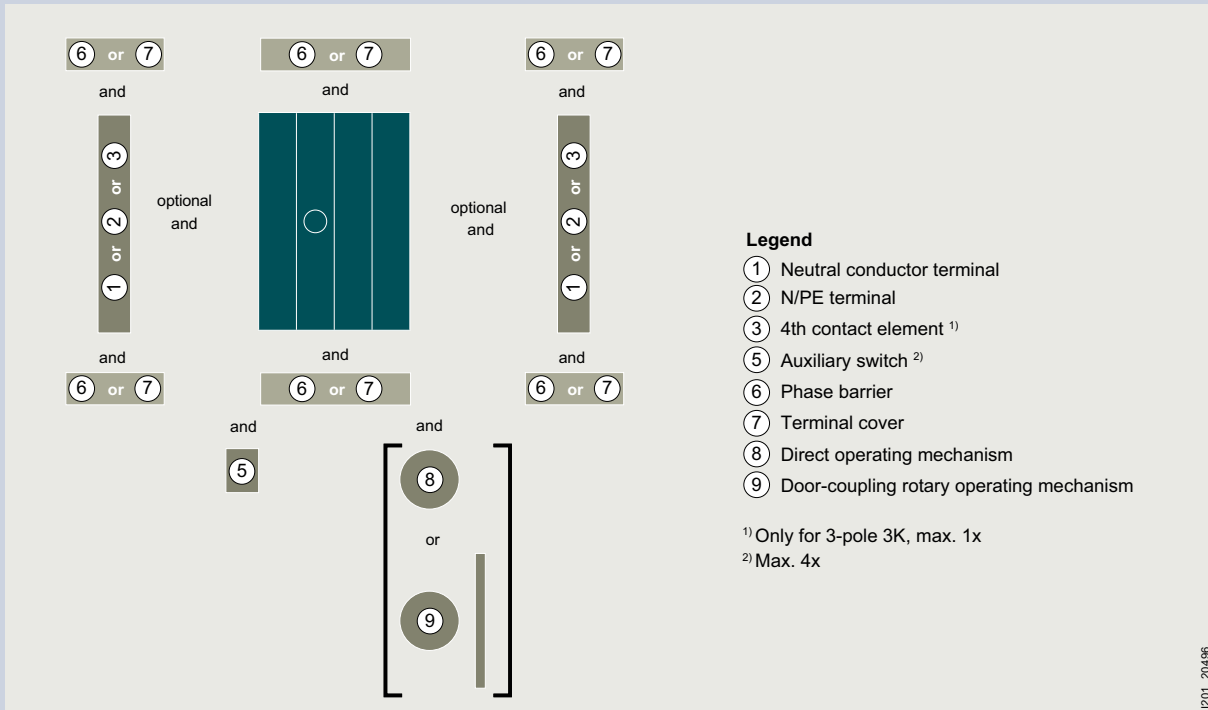
Front operating mechanism left, size 1, 3/4-pole



Front operating mechanism center, size 1, 3/4-pole



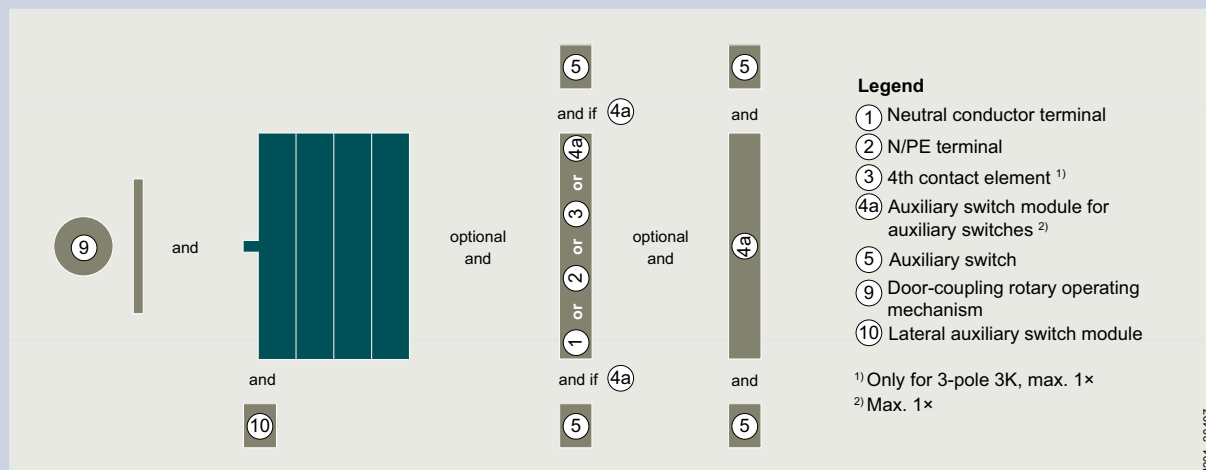
Front operating mechanism center or left, sizes 2 to 5, 3/4-pole



3KF switch disconnectors with fuses

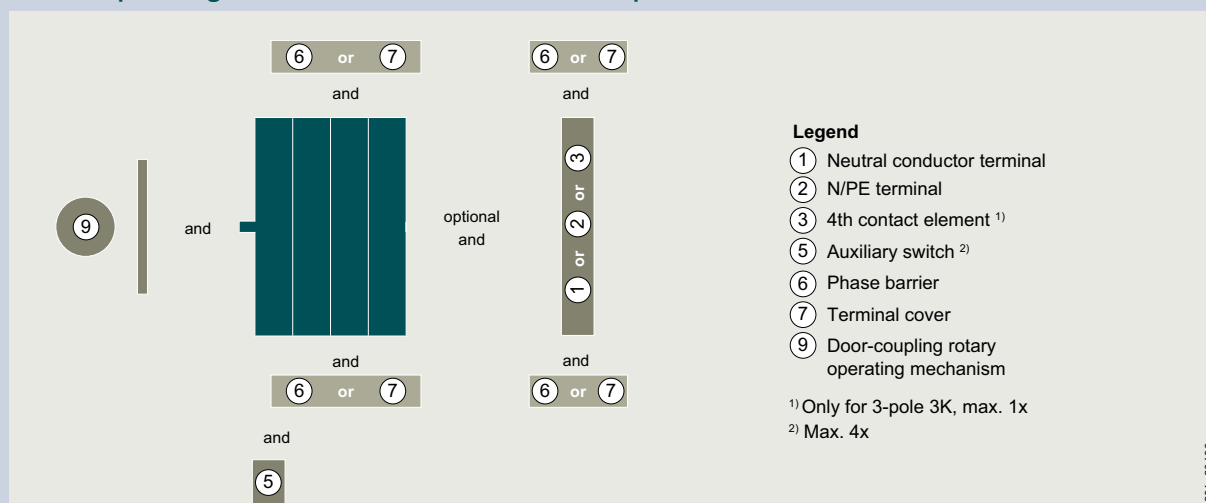
Mounting concept and accessories 3KF

Lateral operating mechanism left, size 1, 3/4-pole

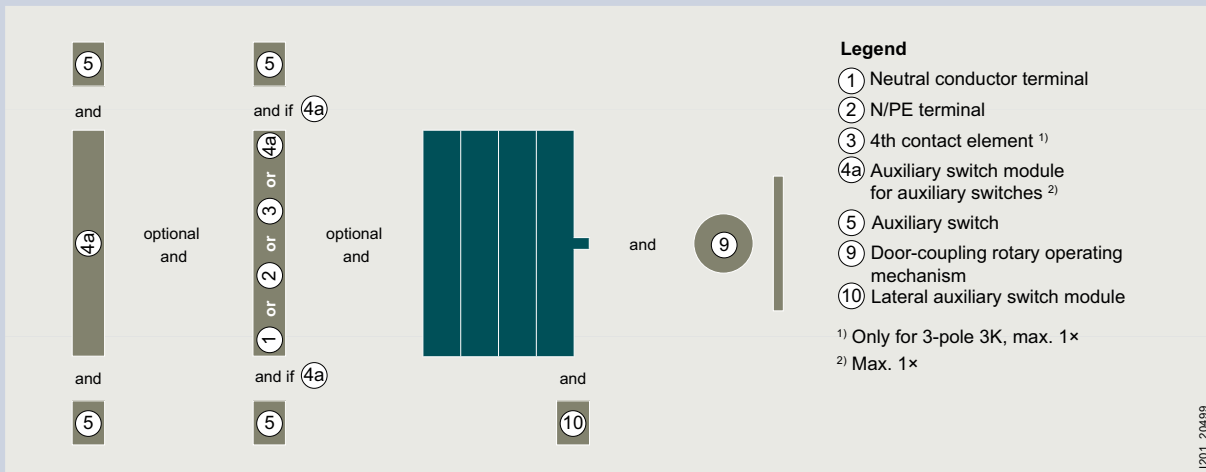


8

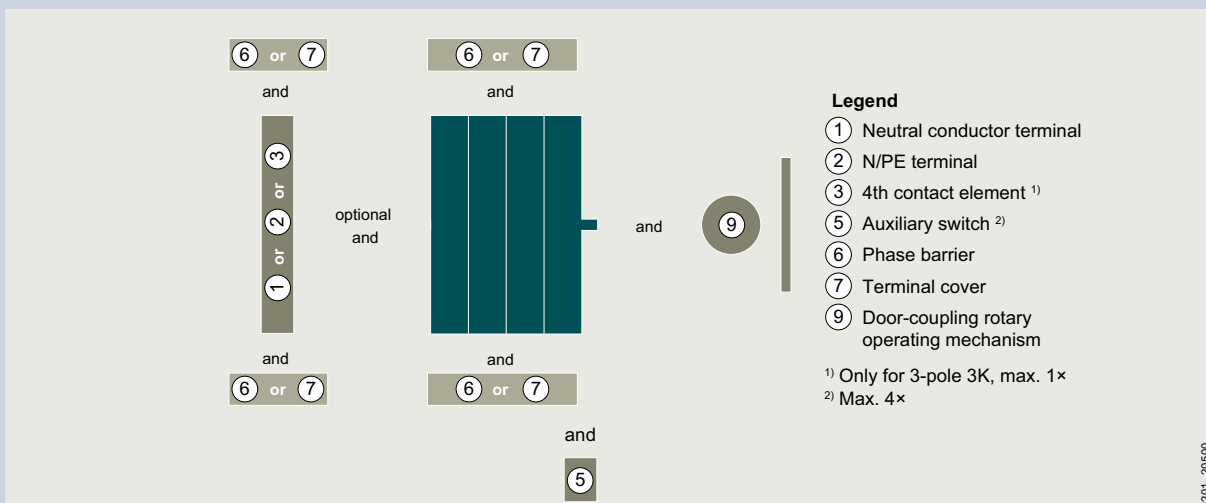
Lateral operating mechanism left, sizes 2 to 5, 3/4-pole



Lateral operating mechanism right, size 1, 3/4-pole



Lateral operating mechanism right, sizes 2 to 5, 3/4-pole



3KF switch disconnectors with fuses

3KF LV HRC switch disconnectors



Number of poles	Complete units with direct operating mechanisms Front operating mechanisms, left		Basic units without handle Front operating mechanisms, left		Front operating mechanism, center
	3P	4P	3P	4P	3P

Size	Uninterrupted current I_u					
Box terminals						
1	32 A	3KF1303-2LB11	3KF1403-2LB11	3KF1303-0LB11	3KF1403-0LB11	3KF1303-0MB11
	63 A	3KF1306-2LB11	3KF1406-2LB11	3KF1306-0LB11	3KF1406-0LB11	3KF1306-0MB11
	80 A	3KF1308-2LB11	3KF1408-2LB11	3KF1308-0LB11	3KF1408-0LB11	3KF1308-0MB11
Flat terminals at rear						
1	32 A	–	–	–	–	3KF1303-0MR11
	63 A	–	–	–	–	3KF1306-0MR11
2	125 A	–	–	–	–	3KF2312-0MR11
Flat terminals						
2	125 A	3KF2312-2LF11	3KF2412-2LF11	3KF2312-0LF11	3KF2412-0LF11	3KF2312-0MF11
	160 A	3KF2316-2LF11	3KF2416-2LF11	3KF2316-0LF11	3KF2416-0LF11	3KF2316-0MF11
3	250 A	3KF3325-2LF11	3KF3425-2LF11	3KF3325-0LF11	3KF3425-0LF11	3KF3325-0MF11
4	400 A	3KF4340-2LF11	3KF4440-2LF11	3KF4340-0LF11	3KF4440-0LF11	3KF4340-0MF11
5	630 A	3KF5363-2LF11	3KF5463-2LF11	3KF5363-0LF11	3KF5463-0LF11	3KF5363-0MF11
	800 A	3KF5380-2LF11	3KF5480-2LF11	3KF5380-0LF11	3KF5480-0LF11	3KF5380-0MF11

Note:

- NH00 and NH000: For 3KF sizes 1 and 2
- NH1 and NH0: For 3KF size 3
- NH2 and NH1: For 3KF size 4
- NH3 and NH2: For 3KF size 5
- For 3KF with lateral operating mechanism (left or right), only door-coupling rotary operating mechanisms without "Test" can be used.
- The complete units with a direct operating mechanism are not suitable for conversion to door-coupling rotary operating mechanisms; the basic units are to be used for this purpose.



Lateral operating mechanism, left		Lateral operating mechanism, right		
4P	3P	4P	3P	4P
3KF1403-0MB11	3KF1303-4LB11	3KF1403-4LB11	3KF1303-4RB11	3KF1403-4RB11
3KF1406-0MB11	3KF1306-4LB11	3KF1406-4LB11	3KF1306-4RB11	3KF1406-4RB11
3KF1408-0MB11	3KF1308-4LB11	3KF1408-4LB11	3KF1308-4RB11	3KF1408-4RB11
-	-	-	-	-
-	-	-	-	-
-	-	-	-	-
3KF2412-0MF11	3KF2312-4LF11	3KF2412-4LF11	3KF2312-4RF11	3KF2412-4RF11
3KF2416-0MF11	3KF2316-4LF11	3KF2416-4LF11	3KF2316-4RF11	3KF2416-4RF11
3KF3425-0MF11	3KF3325-4LF11	3KF3425-4LF11	3KF3325-4RF11	3KF3425-4RF11
3KF4440-0MF11	3KF4340-4LF11	3KF4440-4LF11	3KF4340-4RF11	3KF4440-4RF11
3KF5463-0MF11	3KF5363-4LF11	3KF5463-4LF11	3KF5363-4RF11	3KF5463-4RF11
3KF5480-0MF11	3KF5380-4LF11	3KF5480-4LF11	3KF5380-4RF11	3KF5480-4RF11

3KF switch disconnectors with fuses

3KF SITOR switch disconnectors



Basic units without handle

Front operating mechanism

Left

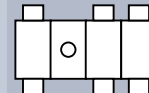
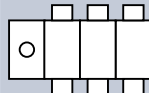
Front operating mechanism

Center

Number of poles

3P

3P



Size	Uninterrupted current I_u		
Box terminals			
1	32 A	3KF1303-0LB51	–
	63 A	3KF1306-0LB51	–
	80 A	3KF1308-0LB51	–
Flat terminals			
2	125 A	–	3KF2312-0MF51
	160 A	–	3KF2316-0MF51
3	250 A	–	3KF3325-0MF51
4	400 A	–	3KF4340-0MF51
5	630 A	–	3KF5363-0MF51
	800 A	–	3KF5380-0MF51

Note:


- Use of standard LV HRC fuses gG, gL, aM in 3KF SITOR is possible without restriction


Accessories for 3KF LV HRC and 3KF SITOR switch disconnectors


Additional poles


Note:

- Additional poles (4th contact element, N or N/PE terminal) must always be mounted directly adjacent to the switch disconnector on the left or right. Accordingly, an auxiliary switch module must not be mounted between the basic unit and an additional pole on size 1.
- For installation, it is important to note that only a 3-pole 3KF switch disconnector may be retrofitted with an additional switching pole with contact system (4th contact element).


				Size 1	Size 2	Size 3	Size 4	Size 5
4th contact element (switching pole) for 3KF LV HRC								
	Connection	Article No.						
	Box terminals	3KF9105-2AA00		■				
	Flat terminals at rear	3KF9105-1AA00		■				
	Flat terminals	3KF9205-1AA00			■			
		3KF9205-0AA00			■			
		3KF9305-0AA00				■		
		3KF9405-0AA00					■	
3KF9505-0AA00						■		

				Size 1	Size 2	Size 3	Size 4	Size 5
4th contact element (switching pole) for 3KF SITOR								
	Connection	Article No.						
	Box terminals	3KF9105-2BA00		■				
	Flat terminals	3KF9205-0BA00			■			
	Flat terminals	3KF9305-0BA00				■		
		3KF9405-0BA00					■	
		3KF9505-0BA00						■

				Size 1	Size 2	Size 3	Size 4	Size 5
Neutral conductor terminals with removable jumper, for 3KF LV HRC and 3KF SITOR								
	Connection	Article No.						
	Box terminals	3KF9106-2AA00		■				
	Flat terminals at rear	3KF9106-1AA00		■				
	Flat terminals	3KF9206-1AA00			■			
		3KF9206-0AA00			■			
		3KF9306-0AA00				■		
		3KF9406-0AA00					■	
3KF9506-0AA00						■		

				Size 1	Size 2	Size 3	Size 4	Size 5
N/PE terminals with permanent jumper, for 3KF LV HRC and 3KF SITOR								
	Connection	Article No.						
	Box terminals	3KF9106-8AA00		■				
	Flat terminals at rear	3KF9106-6AA00		■				
	Flat terminals	3KF9206-6AA00			■			
		3KF9206-7AA00			■			
		3KF9306-7AA00				■		
		3KF9406-7AA00					■	
3KF9506-7AA00						■		

Operating mechanisms

				Size 1	Size 2	Size 3	Size 4	Size 5
Direct operating mechanisms, for 3KF LV HRC								
	Version	Color	Article No.					
	Can be locked with up to 3 padlocks	Gray	3KF9101-1AA00	■				
			3KF9201-1AA00		■			
			3KF9301-1AA00			■		
			3KF9401-1AA00				■	
			3KF9501-1AA00					■
			Red/yellow		3KF9101-2AA00	■		
	3KF9201-2AA00				■			
	3KF9301-2AA00					■		
	3KF9401-2AA00						■	
	3KF9501-2AA00							■

3KF switch disconnectors with fuses

Accessories for 3KF LV HRC and 3KF SITOR switch disconnectors

Operating mechanisms

Size 1 Size 2 Size 3 Size 4 Size 5

Door-coupling rotary operating mechanisms, for 3KF LV HRC and 3KF SITOR



- **Scope of supply:**
 - Handle with masking plate
 - Coupling driver with tolerance compensation
 - Shaft 300 mm
- Can be locked with up to max. 3 padlocks


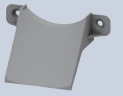
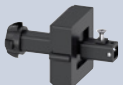


Inscription	Color	Article No.	Size 1	Size 2	Size 3	Size 4	Size 5
Test – O – I	Gray	8UD1171-2AF21	■				
		8UD1141-2AF21		■			
		8UD1141-3AF21			■		
		8UD1151-3AF21				■	
		8UD1161-4AF21					■
	Red/yellow	8UD1171-2AF25	■				
		8UD1141-2AF25		■			
		8UD1141-3AF25			■		
		8UD1151-3AF25				■	
		8UD1161-4AF25					■

Handles, for 3KF LV HRC and 3KF SITOR

- With masking plate
- Can be locked with up to max. 3 padlocks



Inscription	Lighting	Color	Article No.	Size 1	Size 2	Size 3	Size 4	Size 5
O – I	Without	Gray	8UD1771-2AD01	■				
			8UD1841-2AD01		■	■		
			8UD1851-3AD01				■	
			8UD1861-4AD01					■
		Red/yellow	8UD1771-2AD05	■				
			8UD1841-2AD05		■	■		
			8UD1851-3AD05				■	
			8UD1861-4AD05					■
	With	Gray	8UD1771-2CD01	■				
			8UD1841-2CD01		■	■		
			8UD1851-3CD01				■	
			8UD1861-4CD01					■
		Red/yellow	8UD1771-2CD05	■				
			8UD1841-2CD05		■	■		
			8UD1851-3CD05				■	
			8UD1861-4CD05					■
Test – O – I	Without	Gray	8UD1771-2AF01	■				
			8UD1841-2AF01		■	■		
			8UD1851-3AF01				■	
			8UD1861-4AF01					■
		Red/yellow	8UD1771-2AF05	■				
			8UD1841-2AF05		■	■		
			8UD1851-3AF05				■	
			8UD1861-4AF05					■
	With	Gray	8UD1771-2CF01	■				
			8UD1841-2CF01		■	■		
			8UD1851-3CF01				■	
			8UD1861-4CF01					■
		Red/yellow	8UD1771-2CF05	■				
			8UD1841-2CF05		■	■		
			8UD1851-3CF05				■	
			8UD1861-4CF05					■

Operating mechanisms

		Size 1	Size 2	Size 3	Size 4	Size 5	
Extension shaft, for 3KF LV HRC and 3KF SITOR							
	<ul style="list-style-type: none"> A shaft jack is required for the 8UD1 handle when the 600 mm long shaft is used and for sizes 1 and 2 						
	Length	Article No.					
	300 mm	8UC6032	■	■			
		8UC6033			■	■	
		8UC6034					■
	600 mm	8UC6082	■	■			
		8UC6083			■	■	
	8UC6084					■	
Shaft jack for 8UD1 handle, for 3KF LV HRC and 3KF SITOR							
	Version	Article No.					
	For shaft 600 mm	8UD1900-0FA00	■	■			
Coupling drivers, for 3KF LV HRC and 3KF SITOR							
	Version	Article No.					
	With tolerance compensation	8UD1900-2GA00	■				
		8UD1900-6GA00		■			
		8UD1900-3GA00			■	■	
		8UD1900-4GA00					■
	Without tolerance compensation	8UD1900-2HA00	■				
		8UD1900-6HA00		■			
		8UD1900-3HA00			■	■	
		8UD1900-4HA00					■
Adapters for shafts, for 3KF LV HRC and 3KF SITOR							
	Shaft size	Article No.					
	8 × 8 mm	8UC6022	■	■			
	10 × 10 mm	8UC6023			■	■	
	12 × 12 mm	8UC6024					■

8

Further accessories and spare parts

		Size 1	Size 2	Size 3	Size 4	Size 5	
Auxiliary switch modules, for 3KF LV HRC and 3KF SITOR							
	<ul style="list-style-type: none"> Auxiliary switch modules are supplied without auxiliary switches The 3KF9112-0AB00 mounting bracket is additionally required for mounting the auxiliary switch modules with the rear terminal The 3KD9103-6 and 3KD9103-7 auxiliary switch modules and those with a leading NO contact can only be used with 3KF if they have the operating mechanism on the front or on the left 						
	Type	Article No.					
	Standard version	3KD9103-5	■				
	With test function	3KD9103-6	■				
	With leading NO and test function	3KD9103-7	■				
Mounting brackets for auxiliary switch modules, for 3KF size 1 with rear terminals							
	<ul style="list-style-type: none"> For mounting auxiliary switch modules on 3KF switch disconnectors with rear terminal 						
		Article No.					
	3KF9112-0AB00	■					

3KF switch disconnectors with fuses

Accessories for 3KF LV HRC and 3KF SITOR switch disconnectors

Further accessories and spare parts

Size 1 Size 2 Size 3 Size 4 Size 5

Auxiliary switches, for 3KF LV HRC and 3KF SITOR

- Auxiliary switches for sizes 2 to 5 have a screw terminal and are mounted on the 3KF operating mechanism module. Auxiliary switches with spring-type terminals from the 3SU1 program can also be used.
- All auxiliary switches for sizes 2 to 5 can be used as leading auxiliary switches, depending on the mounting position of the auxiliary switch (see operating instructions).



Type	Contacts	Contact surface	Article No.	Size 1	Size 2	Size 3	Size 4	Size 5
With connecting cables	1 CO	Standard	3KD9103-1	■				
		Solid-state compatible	3KD9103-3	■				
Without connecting cables	1 CO	Standard	3KD9103-2	■				
		Solid-state compatible	3KD9103-4	■				
	1 NO	Standard	3SU1400-1AA10-1BA0		■	■	■	■
		Gold-plated	3SU1400-1AA10-1LA0		■	■	■	■
	1 NC	Standard	3SU1400-1AA10-1CA0		■	■	■	■
		Gold-plated	3SU1400-1AA10-1MA0		■	■	■	■
	1 NO + 1 NC	Standard	3SU1400-1AA10-1FA0		■	■	■	■
		Gold-plated	3SU1400-1AA10-1QA0		■	■	■	■
	2 NO	Standard	3SU1400-1AA10-1DA0		■	■	■	■
		Gold-plated	3SU1400-1AA10-1NA0		■	■	■	■
2 NC	Standard	3SU1400-1AA10-1EA0		■	■	■	■	
	Gold-plated	3SU1400-1AA10-1PA0		■	■	■	■	

Electronic fuse monitoring, for 3KF LV HRC and 3KF SITOR



Version	Article No.	Size 1	Size 2	Size 3	Size 4	Size 5
For remote display of tripped fuses	3KF9010-1AA00	■	■	■	■	■

Phase barriers, for 3KF LV HRC and 3KF SITOR



Version	Scope of supply	Article No.	Size 1	Size 2	Size 3	Size 4	Size 5
For 3-pole devices	6 units	3KD9308-6		■			
		3KD9408-6			■	■	
		3KD9508-6					■
For 4-pole devices	8 units	3KD9308-8		■			
		3KD9408-8			■	■	
		3KD9508-8					■

Terminal covers, for 3KF LV HRC



Version	Scope of supply	Type	Article No.	Size 1	Size 2	Size 3	Size 4	Size 5
For 3-pole devices	6 units	Standard version	3KF9204-6		■			
			3KF9304-6			■		
			3KF9404-6				■	
		Short version	3KD9504-6					■
			3KF9204-7		■			
			3KF9304-7			■		
For 4-pole devices	8 units	Standard version	3KF9204-8		■			
			3KF9304-8			■		
			3KF9404-8				■	
		Short version	3KD9504-8					■
			3KF9204-5		■			
			3KF9304-5			■		
			3KF9404-5				■	

Spare part for terminal covers (4th contact element), for 3KF LV HRC



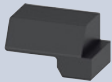






Scope of supply	Type	Article No.	Size 1	Size 2	Size 3	Size 4	Size 5
1 unit	Standard version	3KD9504-1					■
		3KF9204-1		■			
	Short version	3KF9304-1			■		
		3KF9404-1				■	
6 units	Standard version	3KF9204-6		■			
		3KF9304-6			■		
	Short version	3KF9404-6				■	

Spare part for terminal covers (N and N/PE terminal), for 3KF LV HRC



Scope of supply	Type	Article No.	Size 1	Size 2	Size 3	Size 4	Size 5
1 unit	Standard version	3KD9504-1					■
		3KD9304-1		■			
	Short version	3KD9404-1			■	■	
6 units	Standard version	3KD9304-6		■			
		3KD9404-6			■	■	

Further accessories and spare parts

				Size 1	Size 2	Size 3	Size 4	Size 5
Blocking pin test function, for 3KF LV HRC and 3KF SITOR								
	<ul style="list-style-type: none"> Enables permanent deactivation of the test function for auxiliary switches It is installed in the operating mechanism module of the 3KF switch disconnector 		Article No.					
	Scope of supply		10 units	3KF9112-1AA00	■			
				3KF9412-1AA00		■		■
				3KF9512-1AA00				■
Mounting brackets, for 3KF LV HRC								
	<ul style="list-style-type: none"> The 3KF9112-0AB00 mounting bracket is needed if an auxiliary switch module is mounted on a 3KF1 with rear terminals 		Article No.					
	Connection		Box terminals, flat terminals	3KF9112-0AA00	■			
				3KF9212-0AA00		■		
			Flat terminals at rear	3KF9212-0AB00	■	■		
Mounting brackets, for 3KF SITOR								
	Connection		Article No.					
			Box terminals, flat terminals	3KF9112-0AA10	■			
				3KF9212-0AA10		■		
Mounting brackets, for 3KF LV HRC and 3KF SITOR								
	Connection		Article No.					
			Flat terminals	3KF9412-0AA00			■	■
				3KF9512-0AA00				■
Slides, for 3KF LV HRC and 3KF SITOR								
	Version	Scope of supply	Article No.					
	For mounting on DIN rail	5 units	3KF9112-0BA00	■				
Fuse covers, for 3KF LV HRC								
	Connection		Article No.					
			Box terminals, flat terminals	3KF9112-0CA00	■			
				3KF9212-0CA00		■		
				3KF9312-0CA00			■	
				3KF9412-0CA00				■
			3KF9512-0CA00					■
		Flat terminals at rear	3KF9212-0CB00		■			
				NH 000	NH 00	NH 1	NH 2	NH 3
LV HRC isolating blades, for 3KF LV HRC and 3KF SITOR								
	Version		Article No.					
			With insulated grip lugs	3NG1002	■	■		
				3NG1202			■	
				3NG1302				■
				3NG1402				

3NJ63 switch disconnectors with fuses

System overview

Fuse links



For LV HRC fuses

Accessories



Connection terminals and covers



Auxiliary switches



Current transformers



Ammeters



Guide rails

Note:

You will find a detailed range of accessories with the basic units.

General information



3NA COM LV HRC fuse links



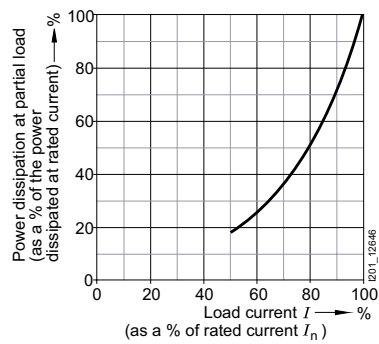
The new the 3NA COM LV HRC fuse links with communication and measuring function make your products communication-capable.

See Fuse Systems, page 7/50



Suitable fuses

You will find further information under:
sie.ag/2UlrAvy



The 3NJ63 switch disconnector with fuses is suitable for all fuses with LV HRC design in sizes 000 to 3 that comply with IEC 60269-2, including fuses for cable and line protection.

3NJ63 switch disconnectors with fuses

Configuration

For a complete and valid configuration of your switch disconnectors with fuses, please use our online configurator at www.siemens.com/lowvoltage/3nj63-configurator

		6	7	8	9	10	11	12	13	14	15	16
3NJ63												
Size and type of fuse	LV HRC fuse	00	160 A	0								
		1	250 A	1								
		2	400 A	2								
		3	630 A	3								
Number of poles	2-pole		2									
	3-pole		3									
	4-pole ¹⁾		4									
Breaking capacity	AC-22B ¹⁾	Manually operated		1								
		Motorized operating mechanism		2								
	AC-23A, DC-23B	Manually operated		3								
		Motorized operating mechanism		4								
Electronic fuse monitoring	Without					A						
	≤ 690 V AC	Operate voltage < 20 V	EFM10			B						
	≤ 690 V AC with line monitoring	Operate voltage < 13 V	EFM20			C						
	≤ 440 V DC	Operate voltage < 20 V	EFM25			E						
Auxiliary switches	Without							0				
	1 NC							1				
	1 NO							2				
	1 NO + 1 NC							3				

¹⁾ 4-pole only in AC-22B

		6	7	8	9	10	11	12	13	14	15	16	
				-									
		3NJ63											
Type of ammeter	Without										0		
	Moving iron										1		
	Bi-metal										2		
Wiring version of the current transformer	Without										A		
	1 current transformer to multi-function plug										B		
	3 current transformers to multi-function plug										C		
	1 current transformer to 1 ammeter										D		
	1 current transformer to 1 ammeter and multi-function plug										E		
	3 current transformers to 1 ammeter and multi-function plug										F		
Current transformer primary current	Without										A		
	50 A										B		
	100 A										D		
	150 A										E		
	200 A										F		
	250 A										G		
	300 A										H		
	400 A										J		
	500 A										K		
	600 A										L		
Current transformer secondary current	Without	Without accuracy class										0	
	1 A	Accuracy class 1										1	
	1 A	Accuracy class 0.5										2	
	1 A	Accuracy class 0.5 calibrated										3	
	5 A	Accuracy class 1										4	
	5 A	Accuracy class 0.5										5	
	5 A	Accuracy class 0.5 calibrated										6	

3NJ63 switch disconnectors with fuses

Accessories

				NH00	NH1	NH2	NH3
Terminals							
	Type	Article No.					
	For 2/3-pole devices	3NJ6923-1BA00		■			
		3NJ6933-1BA00			■		
		3NJ6943-1CA00				■	■
	For 4-pole devices	3NJ6924-1BA00		■			
		3NJ6934-1BA00			■		
3NJ6944-1CA00				■	■		
Terminal covers							
	Type	Version	Article No.				
	For 2/3-pole devices	–	3NJ6923-1DA00		■		
			3NJ6933-1DA01			■	
			3NJ6943-1DA00				■
		As an internal terminal cover	3NJ6933-1DB00			■	
For 4-pole devices		3NJ6904-1DA00		■	■	■	
Contact extensions							
	Number of poles	Article No.					
	3-pole	3NJ6923-1EB00		■			
		3NJ6933-1EB00			■		
		3NJ6943-1EB00				■	■
	4-pole	3NJ6924-1EB00		■			
		3NJ6934-1EB00			■		
3NJ6944-1EB00				■	■		
Electronic fuse monitoring and line monitoring devices							
	Type	Version	Article No.				
	EFM 10	With line monitoring for AC networks	3NJ6920-3FB00		■		
			3NJ6930-3FB00			■	
			3NJ6940-3FB00				■
	EFM 20	With line monitoring for AC networks	3NJ6920-3FC00		■		
			3NJ6930-3FC00			■	
			3NJ6940-3FC00				■
	EFM 25	With line monitoring for AC networks	3NJ6920-3FE00		■		
			3NJ6930-3FE00			■	
3NJ6940-3FE00					■	■	
Auxiliary switches							
	Contacts	Version	Article No.				
	1 NO	With cover	3NJ6920-2BB00		■		
			3NJ6930-2BB00			■	
			3NJ6940-2BB00				■
		Without cover	3NJ6900-2BC00		■	■	■
	1 NC	With cover	3NJ6920-2CB00		■		
			3NJ6930-2CB00			■	
			3NJ6940-2CB00				■
		Without cover	3NJ6900-2CC00		■	■	■

NH00 NH1 NH2 NH3

Current transformers for main devices and contact extensions




Rated current I_{pr}	Class	Apparent power consumption	Feed-through opening diameter	Article No.	NH00	NH1	NH2	NH3
50 A/1 A	1	1 VA	Ø 21 mm	3NJ6920-3BB11	■	■		
50 A/5 A	1	1 VA	Ø 21 mm	3NJ6920-3BB21	■	■		
100 A/1 A	1	2.5 VA	Ø 21 mm	3NJ6920-3BD11	■	■		
	0.5	1.5 VA	Ø 21 mm	3NJ6920-3BD12	■	■		
	0.5 calibrated	1.5 VA	Ø 14 mm	3NJ6920-3BD13	■			
100 A/5 A	1	2.5 VA	Ø 21 mm	3NJ6920-3BD21	■	■		
	0.5	1.5 VA	Ø 21 mm	3NJ6920-3BD22	■	■		
	0.5 calibrated	1.5 VA	Ø 14 mm	3NJ6920-3BD23	■			
150 A/1 A	1	2.5 VA	Ø 21 mm	3NJ6920-3BE11	■	■		
	0.5	1.5 VA	Ø 21 mm	3NJ6920-3BE12	■	■		
	0.5 calibrated	1.5 VA	Ø 14 mm	3NJ6920-3BE13	■			
		2.5 VA	Ø 15.2 mm	3NJ6930-3BE13		■		
150 A/5 A	1	2.5 VA	Ø 21 mm	3NJ6920-3BE21	■	■		
	0.5	1.5 VA	Ø 21 mm	3NJ6920-3BE22	■	■		
	0.5 calibrated	1.5 VA	Ø 14 mm	3NJ6920-3BE23	■			
		2.5 VA	Ø 15.2 mm	3NJ6930-3BE23		■		
200 A/1 A	1	2.5 VA	Ø 21 mm	3NJ6930-3BF11		■		
	0.5	3.75 VA	Ø 21 mm	3NJ6930-3BF12		■		
	0.5 calibrated	2.5 VA	Ø 14 mm	3NJ6930-3BF13		■		
200 A/5 A	1	2.5 VA	Ø 21 mm	3NJ6930-3BF21		■		
	0.5	5 VA	Ø 21 mm	3NJ6930-3BF22		■		
	0.5 calibrated	2.5 VA	Ø 14 mm	3NJ6930-3BF23		■		
250 A/1 A	1	5 VA	Ø 21 mm	3NJ6930-3BG11		■		
	0.5	5 VA	Ø 21 mm	3NJ6930-3BG12		■		
	0.5 calibrated	2.5 VA	Ø 14 mm	3NJ6930-3BG13		■		
250 A/5 A	1	2.5 VA	Ø 21 mm	3NJ6930-3BG21		■		
	0.5	2.5 VA	Ø 21 mm	3NJ6930-3BG22		■		
	0.5 calibrated	2.5 VA	Ø 14 mm	3NJ6930-3BG23		■		
300 A/1 A	1	5 VA	–	3NJ6940-3BH11			■	■
	0.5	5 VA	–	3NJ6940-3BH12			■	■
	0.5 calibrated	5 VA	–	3NJ6940-3BH13			■	■
300 A/5 A	1	5 VA	–	3NJ6940-3BH21			■	■
	0.5	5 VA	–	3NJ6940-3BH22			■	■
	0.5 calibrated	5 VA	–	3NJ6940-3BH23			■	■
400 A/1 A	1	5 VA	–	3NJ6940-3BJ11			■	■
	0.5	5 VA	–	3NJ6940-3BJ12			■	■
	0.5 calibrated	5 VA	–	3NJ6940-3BJ13			■	■
400 A/5 A	1	5 VA	–	3NJ6940-3BJ21			■	■
	0.5	5 VA	–	3NJ6940-3BJ22			■	■
	0.5 calibrated	5 VA	–	3NJ6940-3BJ23			■	■
500 A/1 A	1	5 VA	–	3NJ6940-3BK11			■	■
	0.5	5 VA	–	3NJ6940-3BK12			■	■
	0.5 calibrated	5 VA	–	3NJ6940-3BK13			■	■
500 A/5 A	1	5 VA	–	3NJ6940-3BK21			■	■
	0.5	5 VA	–	3NJ6940-3BK22			■	■
	0.5 calibrated	5 VA	–	3NJ6940-3BK23			■	■
600 A/1 A	1	5 VA	–	3NJ6940-3BL11			■	■
	0.5	5 VA	–	3NJ6940-3BL12			■	■
	0.5 calibrated	5 VA	–	3NJ6940-3BL13			■	■
600 A/5 A	1	5 VA	–	3NJ6940-3BL21			■	■
	0.5	5 VA	–	3NJ6940-3BL22			■	■
	0.5 calibrated	5 VA	–	3NJ6940-3BL23			■	■

3NJ63 switch disconnectors with fuses

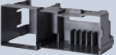
Accessories

NH00 NH1 NH2 NH3


Current transformer busbars



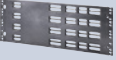




Type	Version	Article No.	NH00	NH1	NH2	NH3
 For current transformers with feed-through opening diameter 21 mm	For 1 current transformer	3NJ6920-3DB00	■			
		3NJ6930-3DB00		■		
	For 3 current transformers	3NJ6920-3DC00	■			
		3NJ6930-3DC00		■		
	For 4 current transformers	3NJ6920-3DD00	■			
		3NJ6930-3DD00			■	
For current transformers with feed-through opening diameter 14 mm	For 1 current transformer	3NJ6920-3DE00	■			
		3NJ6930-3DE00		■		
	For 3 current transformers	3NJ6920-3DF00	■			
		3NJ6930-3DF00			■	
	For 4 current transformers	3NJ6920-3DG00	■			

Holders

Version	Article No.	NH00	NH1	NH2	NH3
 For ammeters	3NJ6900-4GA00	■	■		■

Amperemeter

Type	Version	Rated current I_c	Article No.	NH00	NH1	NH2	NH3	
 Moving-iron measuring instruments	For measurements on transformer x/1 A with double overload	50 A/1 A	3NJ6900-4HB11	■	■			
		100 A/1 A	3NJ6900-4HD11	■	■			
		150 A/1 A	3NJ6900-4HE11	■	■			
		200 A/1 A	3NJ6900-4HF11		■			
		250 A/1 A	3NJ6900-4HG11			■		
		300 A/1 A	3NJ6900-4HH11				■	■
	For measurements on transformer x/5 A with double overload	400 A/1 A	3NJ6900-4HJ11				■	■
		500 A/1 A	3NJ6900-4HK11				■	■
		600 A/1 A	3NJ6900-4HL11				■	■
		50 A/5 A	3NJ6900-4HB21	■	■			
		100 A/5 A	3NJ6900-4HD21	■	■			
		150 A/5 A	3NJ6900-4HE21	■	■			
	Bi-metal measuring instruments	For measurements on transformer x/1 A with 1.2-times overload	200 A/1 A	3NJ6900-4HF12		■		
			250 A/1 A	3NJ6900-4HG12			■	
300 A/1 A			3NJ6900-4HH12				■	■
400 A/1 A			3NJ6900-4HJ12				■	■
500 A/1 A			3NJ6900-4HK12				■	■
600 A/1 A			3NJ6900-4HL12				■	■
For measurements on transformer x/5 A with 1.2-times overload		50 A/5 A	3NJ6900-4HB22	■	■			
		100 A/5 A	3NJ6900-4HD22	■	■			
		150 A/5 A	3NJ6900-4HE22	■	■			
		200 A/5 A	3NJ6900-4HF22		■			
		250 A/5 A	3NJ6900-4HG22			■		
		300 A/5 A	3NJ6900-4HH22				■	■
	400 A/5 A	3NJ6900-4HJ22				■	■	
	500 A/5 A	3NJ6900-4HK22				■	■	
	600 A/5 A	3NJ6900-4HL22				■	■	

				NH00	NH1	NH2	NH3
Multi-function plugs							
	Version	Dimensions	Article No.				
	With fixing screws	6 × 2.5 mm ²	3NJ6920-3EB01	■	■		
		8 × 2.5 mm ²	3NJ6920-3ED01	■	■		
			3NJ6940-3EC00			■	■
	Without fixing screws	8 × 2.5 mm ²	3NJ6940-3ED00			■	■
		10 × 1.5 mm ² and 8 × 2.5 mm ²	3NJ6920-3EE01	■	■		
12 × 1.5 mm ² and 8 × 2.5 mm ²		3NJ6940-3EF00			■	■	
Front panels							
	Use	Version	Article No.				
	3NJ6303-.....	With LV HRC fuse	3NJ6923-4BB00	■			
	3NJ6313-.....	With LV HRC fuse	3NJ6933-4BB00		■		
	3NJ6323-.....	With LV HRC fuse	3NJ6943-4BB00			■	■
	3NJ6333-.....	With LV HRC fuse	3NJ6953-4BB00			■	■
Busbar covers							
			Article No.				
			3NJ6916-4EA00	■	■	■	■
Blanking covers							
			Article No.				
			3NJ6900-4CB00	■	■	■	■
Connection modules							
			Article No.				
			3NJ6915-3BA00	■	■	■	■
Guide rails							
	Overall depth		Article No.				
	200 mm		3NJ6900-4FB00	■	■	■	■
	400 mm		3NJ6900-4FC00	■	■	■	■
LV HRC fuse puller tongs							
	Version		Article No.				
	For NH00		8PQ9400-1AA50	■			
	For NH1, NH2, NH3		8PQ9400-1AA51		■	■	■
Locking devices for padlocks							
			Article No.				
			3NJ6900-4LL	■	■	■	■

5SG switch disconnectors with fuses

System overview

MINIZED switch disconnectors with fuses



1P



3P

NEOZED bus-mounting switch disconnectors



3P



3P, with terminals

Accessories



Auxiliary switches



Lateral modules



Reducers

Note:

You will find a detailed range of accessories with the basic units.



Number of poles		1P	1P+N	2P	3P	3P+N	
Fuse size	Rated current I_n	Mounting width	Mounting width	Mounting width	Mounting width	Mounting width	Mounting width
		1.5 MW	3 MW	3 MW	1.5 MW	4.5 MW	6 MW
MINIZED switch disconnectors with fuses ^{1) 3)}							
D02	63 A	5SG7113	5SG7153	5SG7123	–	5SG7133	5SG7163
MINIZED switch disconnectors with fuses – version for Austria only ^{2) 3)}							
D02	25 A	–	–	–	–	5SG7133-8BA25	–
	35 A	–	–	–	–	5SG7133-8BA35	–
	50 A	–	–	–	–	5SG7133-8BA50	–
NEOZED bus-mounting switch disconnectors							
D02	63 A	–	–	–	5SG7230 ⁴⁾	–	–
NEOZED bus-mounting switch disconnectors, without LED signal detector							
D02	63 A	–	–	–	5SG7234-1 ⁵⁾	–	–
NEOZED bus-mounting switch disconnectors, with LED signal detector							
D02	63 A	–	–	–	5SG7234-2 ⁵⁾	–	–

¹⁾ Using withdrawable design with touch protection according to BGV A3, adapter sleeves not included in the scope of delivery

²⁾ With permanently fitted adapter sleeves, incl. fuse link

³⁾ Do not use fuse links with nickel-plated contact caps

⁴⁾ In the case of permanent load over 35 A, we recommend the use of 5SH5526 lateral modules. Please observe EN 60439-1, Table 1

⁵⁾ In the case of permanent load over 35 A, we recommend the use of 5SH5533 lateral modules. Please observe EN 60439-1, Table 1

Note:

NEOZED adapter sleeves are required for these devices

Accessories

Auxiliary switches

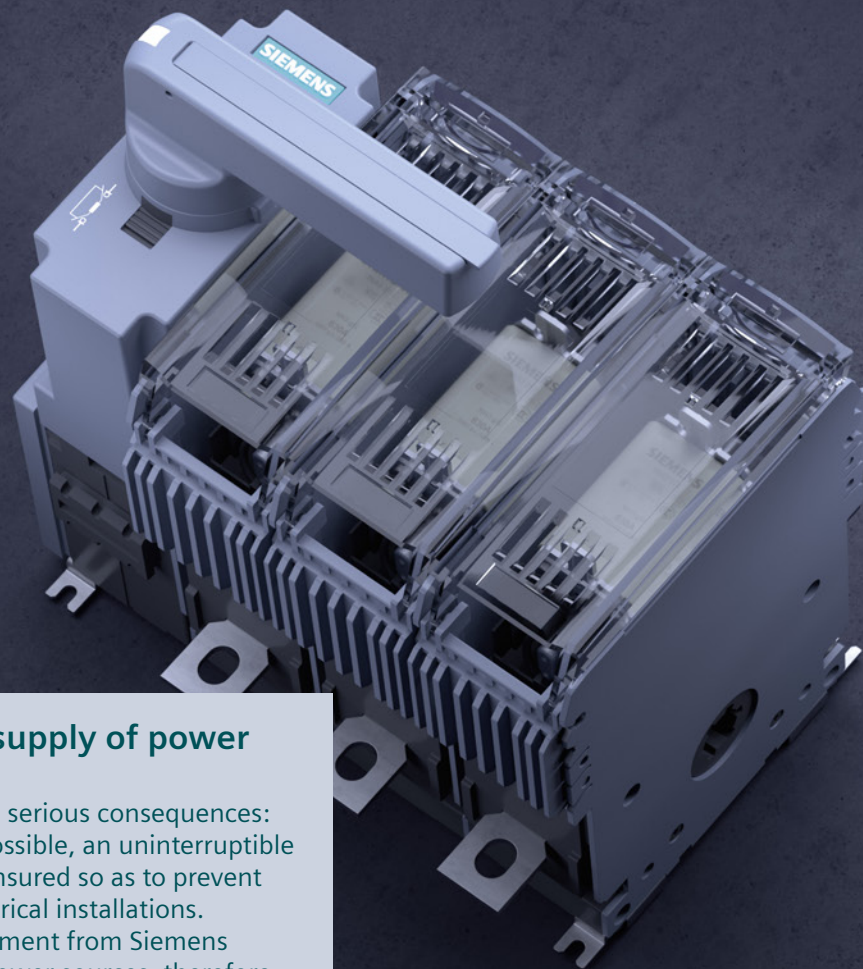
Version	Type	Mounting width	Contacts	Article No.
For MINIZED D02 switch disconnectors	Standard	0.5 MW	1 NO + 1 NC	5ST3010
			2 NO	5ST3011
			2 NC	5ST3012
	With test button	0.5 MW	1 NO + 1 NC	5ST3010-2
			2 NO	5ST3011-2
			2 NC	5ST3012-2
For NEOZED bus-mounting switch disconnectors	Standard	0.5 MW	1 CO	5SH5525

Lateral modules

Version	Type	Mounting width	Article No.
For NEOZED bus-mounting switch disconnectors	5SG7230	0.5 MW	5SH5526
	5SG7234-1 and -2	0.5 MW	5SH5533

Reducers

Version	Article No.
For D01 fuse links	5SH5527



For a continuous supply of power

A power failure can have serious consequences: To the greatest extent possible, an uninterrupted power supply must be ensured so as to prevent failure or outage of electrical installations. Transfer switching equipment from Siemens switches between two power sources, therefore providing a nearly continuous supply of power.

The devices are easy to install and can be quickly put into operation. Additional functions can also be easily added – thanks to the modular design of the devices and to their wide scope of available accessories.

Convenient ordering processes and fast delivery optimize stock-keeping and save you time and money. You can also use our CAx data for automated and streamlined planning and configuration.

Transfer Switching Equipment and Load Transfer Switches



All the information you need	9/2
System overview	9/4
Quick selection guide	9/6
Applications	9/6
Transfer switching equipment and load transfer switches	9/8
Mounting concept and accessories	9/12
Transfer switching equipment	9/16
3KC3 and 3KC4 remote transfer switching equipment (RTSE)	9/16
3KC6 and 3KC8 automatic transfer switching equipment (ATSE)	9/17
Accessories for remote transfer switching equipment (RTSE) and automatic transfer switching equipment (ATSE)	9/18
3KC0 manual transfer switching equipment (MTSE)	9/24
Accessories for manual transfer switching equipment (MTSE)	9/26
Load transfer switches	9/30
3LD2 load transfer switches	9/30
Transfer control devices	9/32
3KC ATC transfer control devices	9/32
Accessories for transfer control devices	9/34

A multitude of additional information ...

Information + ordering

All the important things at a glance

For information about transfer switching equipment and load transfer switches, please visit our website www.siemens.com/switching-devices

Our white paper provides you with a good overview of the transfer switching equipment sie.ag/2XBonli

Your product in detail

The relevant tender specifications can be found at www.siemens.com/tenderspecifications

Use our conversion tool for quick and easy conversion to Siemens products www.siemens.com/conversion-tool

Everything you need for your order

Refer to SiePortal to find an overview of your products (product catalog)

- Transfer switching equipment and load transfer switches sie.ag/2mmMw6g

Direct forwarding to the individual products in SiePortal by clicking on the article number in the catalog or entering this web address incl. article number www.siemens.com/product_catalog_SIEP?Article No.

You will find order support in SiePortal under www.siemens.com/lowvoltage/product-support

- Order Support
 - 3KC automatic transfer switching equipment (ATSE) – End-to-end safety for user and systems [\(109755620\)](http://(109755620))
 - 3KC remotely operated transfer switching equipment (RTSE) – End-to-end safety for user and systems [\(109755627\)](http://(109755627))
 - 3KC manual transfer switching equipment (MTSE) – End-to-end safety for user and systems [\(109750227\)](http://(109750227))

The fast track to the experts

Contact persons in your region

We offer a comprehensive portfolio of services. You can find your local contacts at www.siemens.com/lowvoltage/components/contact

You will find further information on services at www.siemens.com/service-offers

Competent expert advice on technical questions with a wide range of demand-optimized services for all our products and systems.

Assistance with technical queries is provided at www.siemens.com/support-request

... can be found in our online services

Commissioning + operation

Your product in detail

The SiePortal platform (knowledge base) provides detailed technical information
www.siemens.com/lowvoltage/product-support

- Operating instructions
- Certificates

Online Support app available for download from the [App Store](#) and [Play Store](#)
You will find further information at www.siemens.com/support-app

Provision of 3D data (step and u3d data formats)

- SiePortal (product catalog)
www.siemens.com/lowvoltage/product-catalog
- Image database
www.siemens.com/lowvoltage/picturedb

Engineering data for CAD or CAE systems are available in the CAx Download Manager at www.siemens.com/cax

Manuals

Manuals can be found in SiePortal at www.siemens.com/lowvoltage/manuals

- Configuration Manual
 - Transfer switching equipment and load transfer switches ([109769745](#))
- Equipment Manual
 - 3KC3 and 3KC6 transfer switching equipment ([109754954](#))
 - 3KC0 manual transfer switching equipment ([109763232](#))
 - 3KC4 and 3KC8 transfer switching equipment ([109738725](#))
 - 3KC ATC3100 transfer control device ([100341671](#))
 - 3KC ATC6300 transfer control device ([109755149](#))
 - 3KC ATC6500 transfer control device ([109758018](#))

Technical overview – Transfer switching equipment and load transfer switches



The fast way to get you to our online services

This page provides you with comprehensive information and links on transfer switching equipment and load transfer switches

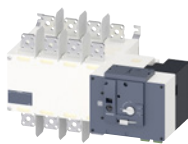
www.siemens.com/lowvoltage/product-support ([109770919](#))

System overview

Remote (RTSE) and automatic (ATSE) transfer switching equipment



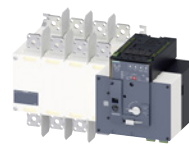
3KC3 (RTSE), 4-pole



3KC4 (RTSE), 3 and 4-pole

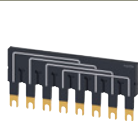


3KC6 (ATSE), 4-pole



3KC8 (ATSE), 3 and 4-pole

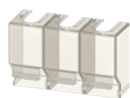
Accessories, RTSE and ATSE



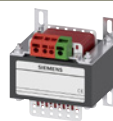
Bridging bars



Auxiliary switches



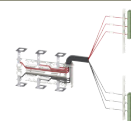
Terminal covers



Autotransformers



Dual power supply



Power supply and voltage sensing cables

Manual transfer switching equipment (MTSE)

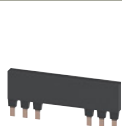


3KC0 (MTSE), 3 and 4-pole



9

Accessories, MTSE



Bridging bars



4th contact element



Auxiliary switches



Direct operating mechanisms



Door-coupling rotary operating mechanisms



Phase barriers



Terminal covers

Note:

You will find a detailed range of accessories in the Accessories section.

Load transfer switches



Front mounting
3LD2



Floor mounting
3LD2



Molded-plastic
enclosures 3LD2

Accessories



4th contact
element



N/PE terminal



Auxiliary
switches



Terminal covers

Transfer control devices



3KC ATC3100



3KC ATC6300



3KC ATC6500

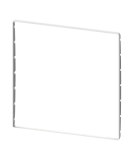
Accessories



Expansion modules



Front interface



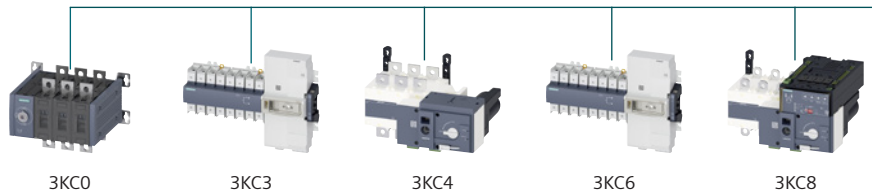
Protective seal

Note:

You will find a detailed range of accessories in the Accessories section.

Applications

Switching with switch disconnectors (without protection function)

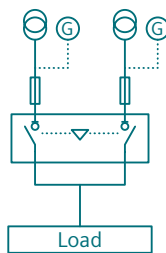


Transfer types	Load transfer	AC	■	■	■	-	-
		DC	-	-	■	-	-
Method of operation	Transfer control	AC	■	■	■	■	■
	Manual (MTSE)		■	■	■	■	■
	Remote (RTSE)		-	■	■	-	■
Transfer control	Automatic (ATSE)		-	With ATC6300	With ATC6300	■	■
	Network/network	AC	■	■	■	■	■
	Network/generator	AC	■	■	■	-	■
Rated operating current	Generator/generator	AC	■	■	■	-	-
			16 ... 1600 A	40 ... 160 A	250 ... 3200 A	40 ... 160 A	250 ... 3200 A
Number of poles			3 and 4	4	3 and 4	4	3 and 4
Communication			-	With ATC6300	With ATC6300	-	-
Automatic load shedding			-	-	-	-	-

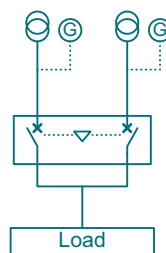
Further information	From page 9/24 onwards	From page 9/16 onwards	From page 9/16 onwards	From page 9/17 onwards	From page 9/17 onwards
----------------------------	------------------------	------------------------	------------------------	------------------------	------------------------

¹⁾ Manual load transfer switch, not an MTSE

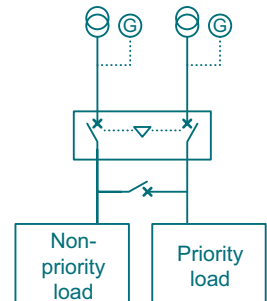
Transfer control



With switch disconnectors

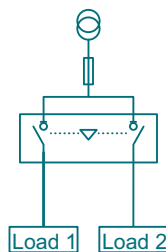


With circuit breakers



With circuit breakers and automatic load shedding

Load transfer



With switch disconnectors

Switching with circuit breakers (with protection function)



3LD2



3KC ATC3100 (+ 3VA/3WA/3WL)



3KC ATC6300 (+ 3VA/3WA/3WL)



3KC ATC6500 (+ 3VA/3WA/3WL)

■	-	-	-
-	-	-	-
-	■	■	■
■ ¹⁾	-	-	-
-	■	■	■
-	■	■	■
-	■	■	■
-	■	■	■
-	-	■	■
25 ... 250 A	3VA: 16 ... 630 A, 3WA/3WL: 630 ... 6300 A	3VA: 16 ... 630 A, 3WA/3WL: 630 ... 6300 A	3VA: 16 ... 1600 A, 3WA/3WL: 630 ... 6300 A
3 and 4	3 and 4	3 and 4	3 and 4
-	-	■	■
-	-	-	■

From page 9/30
onwards

From page 9/32
onwards

From page 9/32
onwards

From page 9/32
onwards

Transfer switching equipment and load transfer switches

Remote transfer switching equipment (RTSE), automatic transfer switching equipment (ATSE)



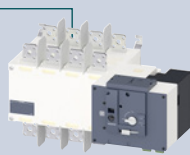
		3KC3424	3KC3426	3KC3428	3KC3430	3KC3432	3KC3434
		3KC6424	3KC6426	3KC6428	3KC6430	3KC6432	3KC6434
Rated uninterrupted current I_u		40 A	63 A	80 A	100 A	125 A	160 A
Connection		Box terminal					
Switch positions		I – O – II					
Number of poles		4					
Size		–					
General technical specifications							
Operational voltage at 50/60 Hz AC acc. to IEC 60947-6-1	V	415					
Operational voltage at 50/60 Hz AC acc. to IEC 60947-3 (load transfer switch)	V	415					
Impulse withstand voltage (U_{imp}) for main circuit	kV	6					
Impulse withstand voltage (U_{imp}) for control circuit (RTSE/ATSE)	kV	4 (RTSE)/2.5 (ATSE)					
Operational current in acc. to IEC 60947-6-1	A	40	63	80	100	100/125	100/160
	A	40	63	80	100	100/125	100/160
	A	40	63	80	100	125	125
Operational current in acc. to IEC 60947-3 (load transfer switch)	A	40	63	80	100	125	125/160
	A	40	63	80	100	125	125
	A	40	63	80	100	125	125/160
	A	40	63	80	80	100/125	100/125
	A	40	63	80	100	125	125/160
	A	40	63	63	80	80	80
Operational power in acc. to IEC 60947-3 (load transfer switch)	kW	22	37	45	55	60	75
	kW	37	55	55	75	75	75
	kW	–					
	kW	–					
Short-circuit behavior							
Short-circuit current ratings in acc. to IEC 60947-6-1	Conditional short-circuit current with gG fuse (415 V) kA	50	50	50	50	50	40
Short-circuit current ratings in acc. to IEC 60947-3 (load transfer switch)	Conditional short-circuit current with gG fuse (415 V) kA	50	50	50	50	50	40
	Conditional short-circuit current with gG fuse (690 V) kA	–					
Transfer switching properties (in acc. to IEC 60947-6-1)							
Switching time I – O and II – O	s	0.045					
Switch-off time I – O – II and II – O – I	s	0.15					
Transfer time I – O – II and II – O – I without/with line monitoring	s	0.18/1.4					
Degree of protection							
IP maximum degree of protection		IP20					
Standards UL/CSA, in acc. to UL 508							
Rated operational voltage U_e AC	V	–					
Rated uninterrupted current I_u	A	–					
Maximum rated power (AC-3), 3-phase, 40 ... 60 Hz	480 V hp	–					
	600 V hp	–					
Further information							

From page 9/16 onwards

¹⁾ For 3LD2 at 380 ... 440 V

²⁾ For 3LD2 at 660 ... 690 V

Remote transfer switching equipment (RTSE), automatic transfer switching equipment (ATSE)

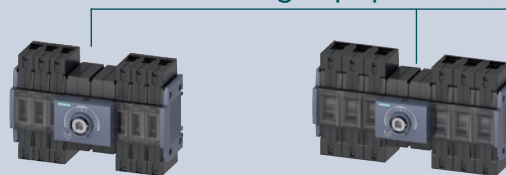


3KC4.38 3KC8.38 250 A	3KC4.42 3KC8.42 400 A	3KC4.46 3KC8.46 630 A	3KC4.48 3KC8.48 800 A	3KC4.50 3KC8.50 1000 A	3KC4.52 3KC8.52 1250 A	3KC4.54 3KC8.54 1600 A	3KC4.56 3KC8.56 2000 A	3KC4.58 3KC8.58 2500 A	3KC4.60 3KC8.60 3200 A
Flat terminal									
I – O – II									
3 and 4									
–									
415									
690									
12									
4									
–/250	–/400	–/630	–/800	–/1000	–/1250	–/1600	–/2000	–/2500	–/3200
–/200	–/400	–/500	–/800	–/1000	–/1250	–/1250	–/2000	–/2000	–/2000
200	200	400	800	1000	1000	1000	1250	1250	1250
250	400	630	800	1000	1250	1600	–/2000	–/2500	–/3200
200	200	500	800	1000	1250	1600	–/2000	–/2000	–/2000
250	400	630	800	1000	1250	1600	–/2000	–/2500	–/3200
160	160	400	630	800	1000	1000	–	–	–
200	400	500/630	800	1000	1250	1250	–/1600	–/1600	–/1600
125	125	400	630	630	800	800	–	–	–
110	220	335	450	700	800	900	–	–	–
110	110	400	400	630	800	800	–	–	–
–									
–									
50	50	50	50	50	100	100	–	–	–
–									
50	50	50	50	50	100	100	–	–	–
–									
0.5	0.5	0.6	1.4	1.4	1.4	1.4	1.6	1.6	1.6
0.4	0.4	0.4	1.4	1.4	1.4	1.5	1.2	1.2	1.2
0.9/1.0	0.9/1.0	1.0/1.1	2.8/3.1	2.8/3.1	2.8/3.1	2.9/3.3	2.8/2.8	2.8/2.8	2.8/2.8
IP20									
–									
–									
–									
–									

From page 9/16 onwards

Transfer switching equipment and load transfer switches

Manual transfer switching equipment (MTSE)



			3KC0.16	3KC0.22	3KC0.26	3KC0.28	3KC0.30	3KC0.32	3KC0.34	
Rated uninterrupted current I_u			16 A	32 A	63 A	80 A	100 A	125 A	160 A	
Connection			Box terminal			Box terminal				
Switch positions			I – O – II			I – O – II				
Number of poles			3 and 4			3 and 4				
Size			1			2				
General technical specifications										
Operational voltage at 50/60 Hz AC acc. to IEC 60947-6-1	V		415			415				
Operational voltage at 50/60 Hz AC acc. to IEC 60947-3 (load transfer switch)	V		690			690				
Impulse withstand voltage (U_{imp}) for main circuit	kV		8			8				
Impulse withstand voltage (U_{imp}) for control circuit (RTSE/ATSE)	kV		–			–				
Operational current in acc. to IEC 60947-6-1	AC-31 A/B, at 415 V	A	–/16	–/32	–/63	–/80	–/100	–/125	–/160	
	AC-32 A/B, at 415 V	A	–/16	–/32	–/63	–/80	–/100	–/125	–/160	
	AC-33 B, at 415 V	A	16	32	63	80	100	125	160	
Operational current in acc. to IEC 60947-3 (load transfer switch)	AC-21 A/B, at 415 V	A	16/16	32/32	63/63	80/80	100/100	125/125	160/160	
	AC-21 A/B, at 690 V	A	16/16	32/32	63/63	80/80	100/100	125/125	160/160	
	AC-22 A/B, at 415 V	A	16/16	32/32	63/63	80/80	100/100	125/125	160/160	
	AC-22 A/B, at 690 V	A	16/16	32/32	63/63	80/80	100/100	125/125	160/160	
	AC-23 A/B, at 415 V	A	16/16	32/32	63/63	80/80	100/100	125/125	160/160	
Operational power in acc. to IEC 60947-3 (load transfer switch)	AC-23 A/B, at 415 V ¹⁾	kW	7.5/7.5	15/15	30/30	37/37	55/55	55/55	90/90	
	AC-23 A/B, at 690 V ²⁾	kW	11/11	30/30	55/55	75/75	90/90	110/110	110/110	
	AC-3 motor load switch at 380 ... 440 V	kW		–			–		–	
AC-3 motor load switch at 660 ... 690 V	kW		–			–		–		
Short-circuit behavior										
Short-circuit current ratings in acc. to IEC 60947-6-1	Conditional short-circuit current with gG fuse (415 V)	kA		100				100		
Short-circuit current ratings in acc. to IEC 60947-3 (load transfer switch)	Conditional short-circuit current with gG fuse (415 V)	kA		100				100		
	Conditional short-circuit current with gG fuse (690 V)	kA		100				65		
Transfer switching properties (in acc. to IEC 60947-6-1)										
Switching time I – O and II – O		s		–				–		
Switch-off time I – O – II and II – O – I		s		–				–		
Transfer time I – O – II and II – O – I without/with line monitoring		s		–				–		
Degree of protection										
IP maximum degree of protection				IP20				IP20		
Standards UL/CSA, in acc. to UL 508										
Rated operational voltage U_e AC	V			–				–		
Rated uninterrupted current I_u	A			–				–		
Maximum rated power (AC-3), 3-phase, 40 ... 60 Hz	480 V	hp		–				–		
	600 V	hp		–				–		

Further information

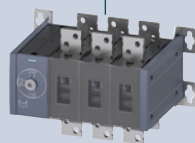
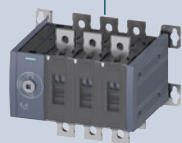
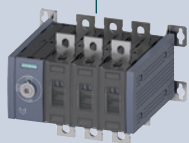
From page 9/24 onwards

From page 9/24 onwards

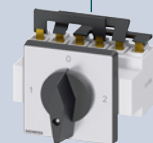
¹⁾ For 3LD2 at 380 ... 440 V

²⁾ For 3LD2 at 660 ... 690 V

Manual transfer switching equipment (MTSE)



Load transfer switches

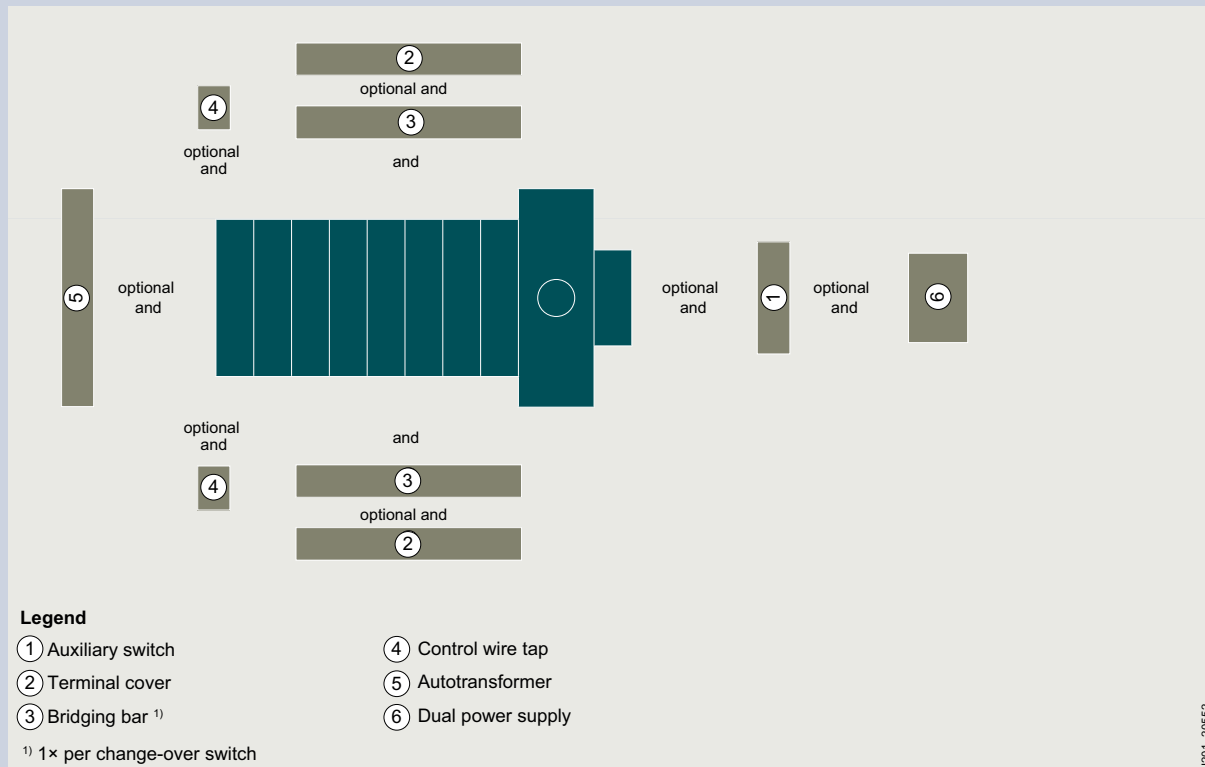


3KCO.36	3KCO.38	3KCO.40	3KCO.42	3KCO.44	3KCO.46	3KCO.48	3KCO.50	3KCO.52	3KCO.54	3LD21	3LD22	3LD25	3LD27	3LD23	3LD24	
200 A	250 A	315 A	400 A	500 A	630 A	800 A	1000 A	1250 A	1600 A	25 A	32 A	63 A	100 A	160 A	250 A	
Flat terminal				Flat terminal				Flat terminal			Box terminal			Box terminal		
I-O-II				I-O-II				I-O-II			I-O-II			I-O-II		
3 and 4				3 and 4				3 and 4			3			3 and 4		
3				4				5			-			-		
415				415				415			-			-		
690				690				690			690			690		
12				12				12			6			6		
-				-				-			-			-		
-/200	-/250	-/315	-/400	-/500	-/630	-/800	-/1000	-/1250	-/1600	-			-			
-/200	-/250	-/315	-/350	-/500	-/630	-/800	-/1000	-/1250	-/1250	-			-			
200	250	315	315	500	500	500	800	800	800	-			-			
200/200	250/250	315/315	400/400	500/500	630/630	800/800	1000/1000	1250/1250	1600/1600	25	32	63	100	160	250	
200/200	250/250	315/315	400/400	500/500	630/630	800/800	1000/1000	1250/1250	1600/1600	25	32	63	100	160	250	
200/200	250/250	315/315	400/400	500/500	630/630	800/800	1000/1000	1250/1250	1600/1600	25	32	63	100	140	230	
200/200	250/250	315/315	400/400	500/500	630/630	800/800	1000/1000	1250/1250	1600/1600	25	32	63	100	140	230	
200/200	250/250	315/315	400/400	500/500	630/630	670/670	800/800	800/800	800/800	20	22	43	70	132	224	
200/200	250/250	315/315	315/315	500/500	500/500	500/500	800/800	800/800	800/800	11.5	13.5	22	34	47	58	
110/110	132/132	160/160	220/220	280/280	355/355	355/355	400/400	400/400	400/400	9.5	11.5	22	37	75	132	
185/185	220/220	280/280	355/355	500/500	500/500	500/500	800/800	800/800	800/800	9.5	11.5	18.5	30	45	55	
-	-	-	-	-	-	-	-	-	-	7.5	9.5	18.5	30	50	110	
-	-	-	-	-	-	-	-	-	-	7.5	9.5	15	22	37	45	
100	100	65	65	100	100	65	100	80	80	-			-			
100	100	65	65	100	100	65	100	80	80	50	50	50	50	50	50	
65	65	35	35	65	65	50	-	-	-	50	50	50	50	50	50	
-	-	-	-	-	-	-	-	-	-	-			-			
-	-	-	-	-	-	-	-	-	-	-			-			
-	-	-	-	-	-	-	-	-	-	-			-			
IP20				IP20				IP20			IP65					
-	-	-	-	-	-	-	-	-	-	600	600	600	600	600	600	
-	-	-	-	-	-	-	-	-	-	20	30	60	100	160	250	
-	-	-	-	-	-	-	-	-	-	10	20 (15) ³⁾	40	60	75	100	
-	-	-	-	-	-	-	-	-	-	15	30 (20) ³⁾	50	75	75	75	
From page 9/24 onwards				From page 9/24 onwards				From page 9/24 onwards			From page 9/30 onwards					

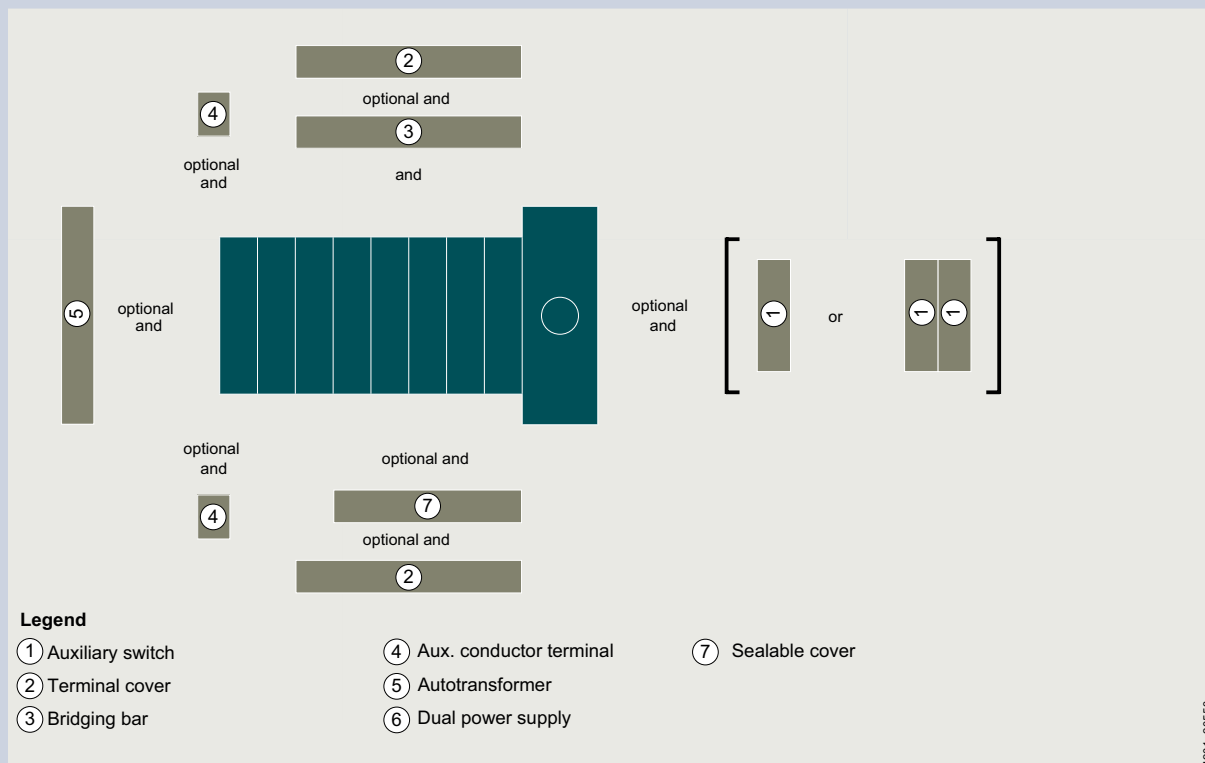
³⁾ Values in brackets apply to devices in molded-plastic enclosure.

Mounting concept and accessories

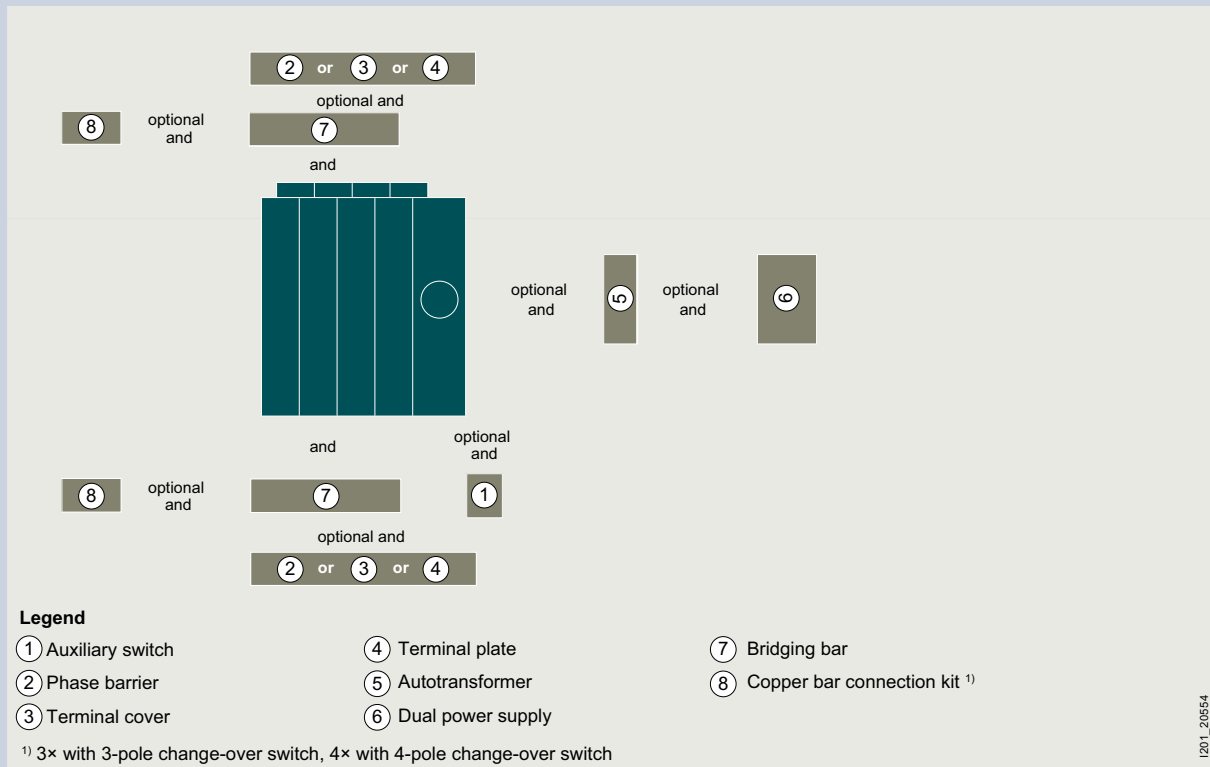
3KC3 (RTSE) 4-pole



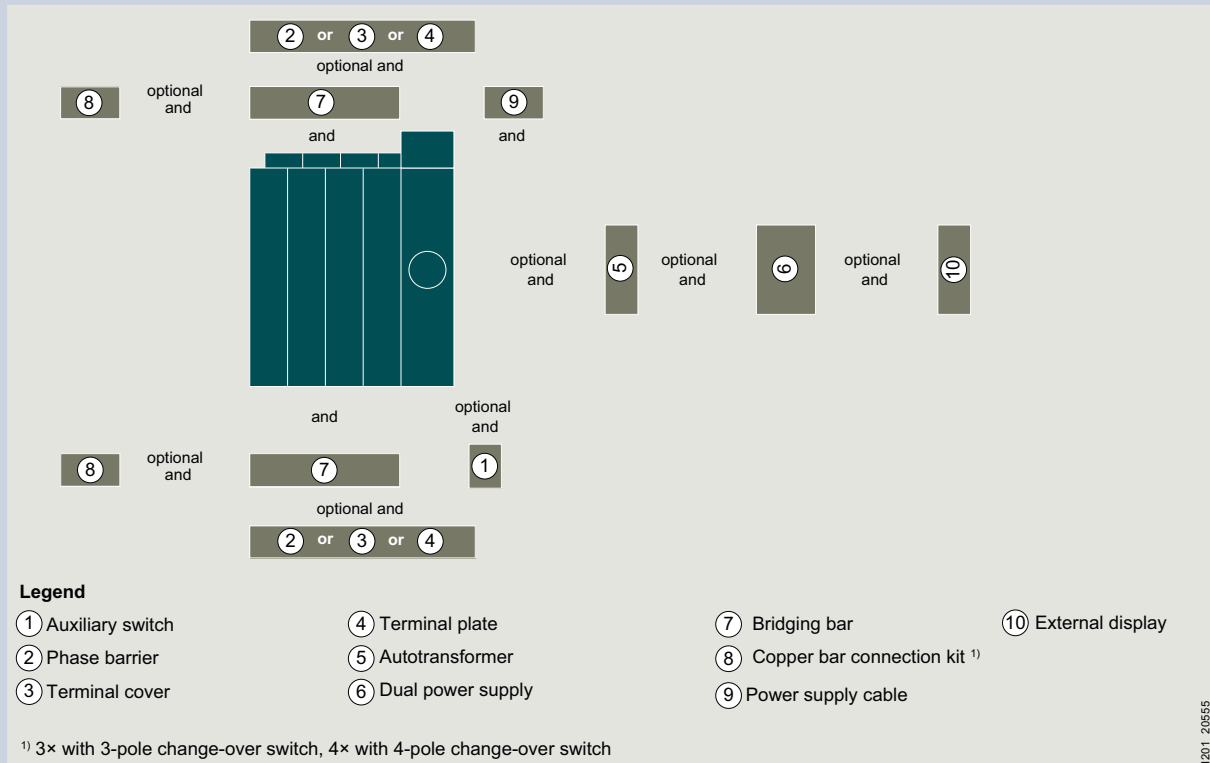
3KC6 (ATSE) 4-pole



3KC4 (RTSE) 3-pole or 4-pole

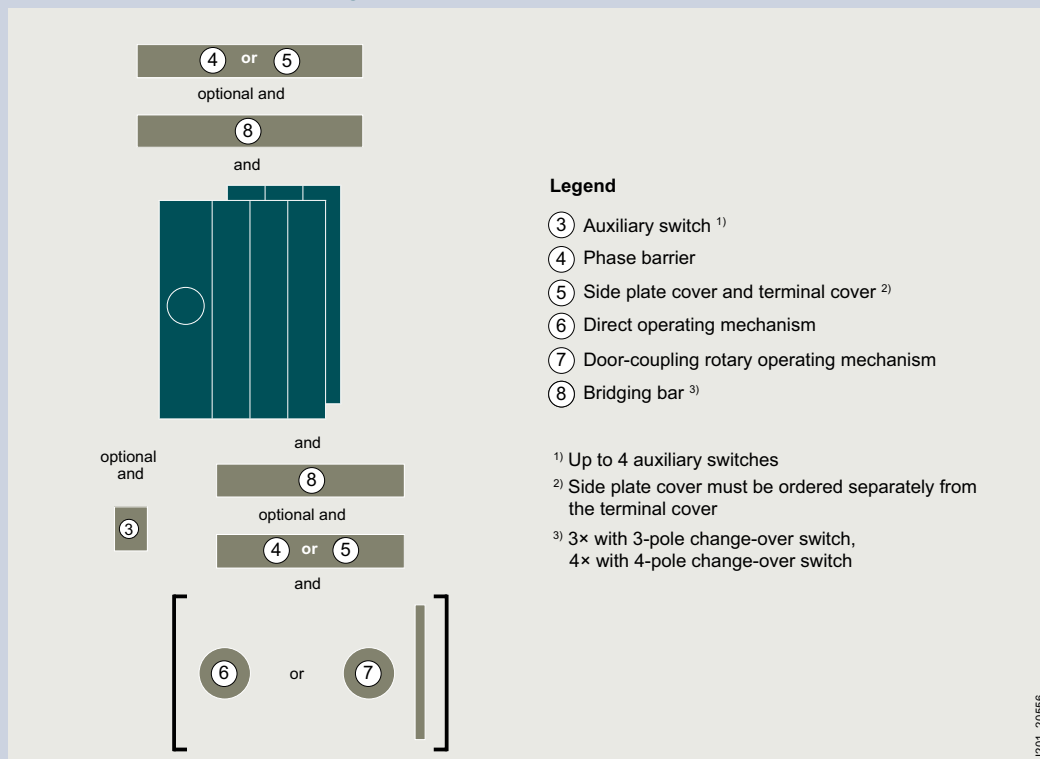


3KC8 (ATSE) 3-pole or 4-pole



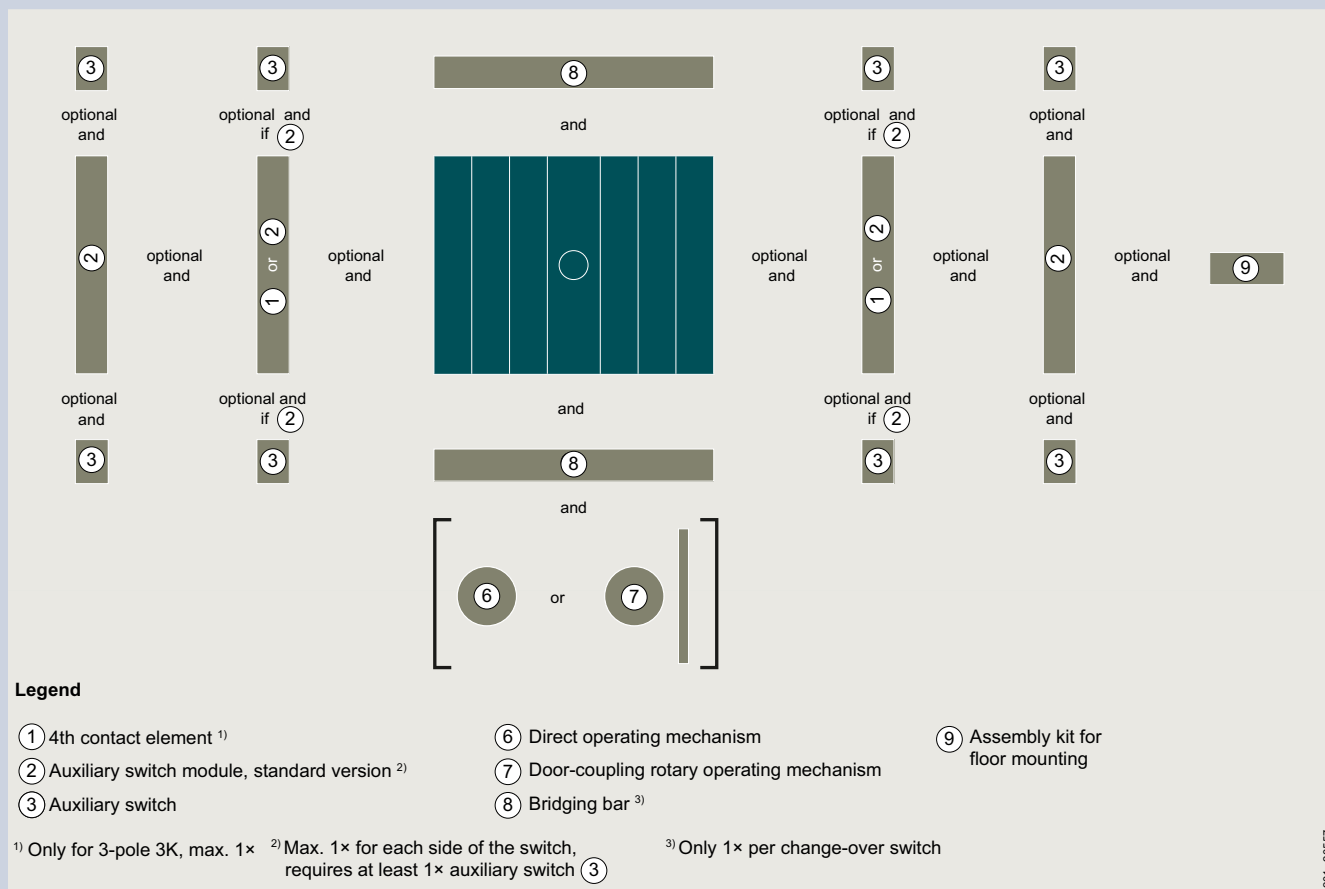
Mounting concept and accessories

3KC0 (MTSE) front operating mechanism on left, 3-pole or 4-pole, sizes 3 to 5



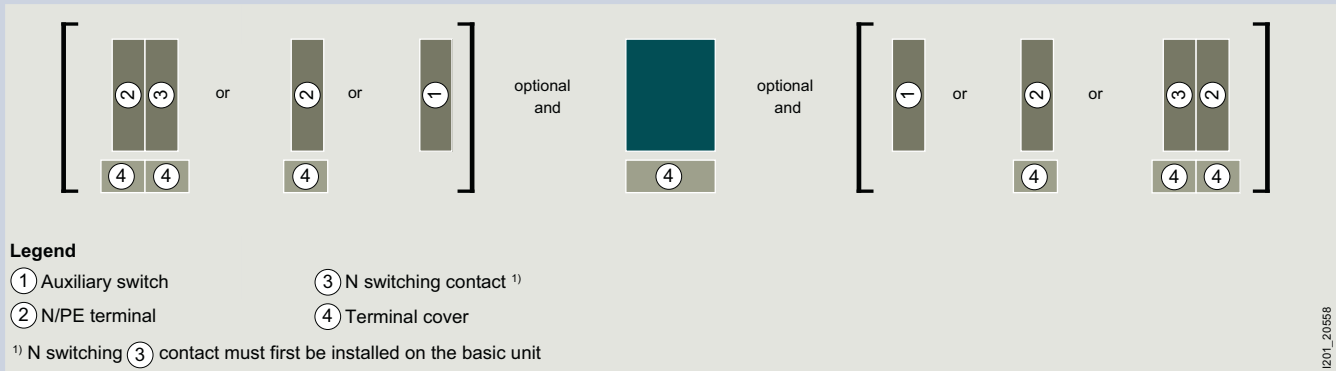
1201_20556

9



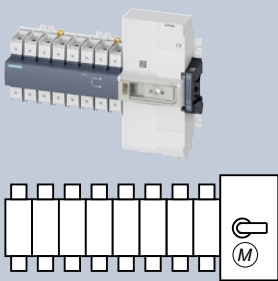
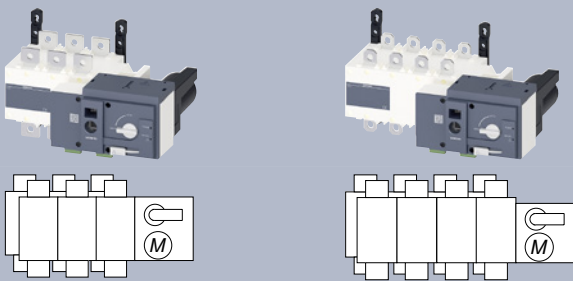
1201_20557

3LD2 load transfer switch mounting concept



3KC3 and 3KC4 remote transfer switching equipment (RTSE)


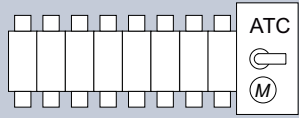

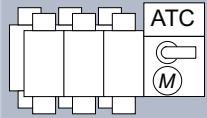
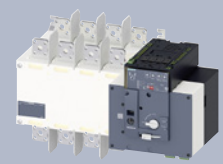
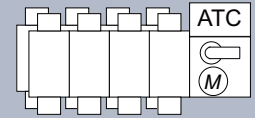
40 to 3200 A

	Box terminal 3KC3 (RTSE)	Flat terminal 3KC4 (RTSE)
Version	With motorized operating mechanism and additional handle	With motorized operating mechanism and additional handle
Operating mechanism	Operating mechanism on right	Operating mechanism on right
Mounting	Floor and DIN-rail mounting	Floor mounting
Bridging bars	Additionally required for connection side	Additionally required for connection side
Scope of supply	Including 3KC9603 auxiliary switches	
		

Rated uninterrupted current I_u	4-pole	3-pole	4-pole
Box terminal			
40 A	3KC3424-2AA22-0AA3	–	–
63 A	3KC3426-2AA22-0AA3	–	–
80 A	3KC3428-2AA22-0AA3	–	–
100 A	3KC3430-2AA22-0AA3	–	–
125 A	3KC3432-2AA22-0AA3	–	–
160 A	3KC3434-2AA22-0AA3	–	–
Flat terminal			
250 A	–	3KC4338-0CA21-0AA3	3KC4438-0CA21-0AA3
400 A	–	3KC4342-0DA21-0AA3	3KC4442-0DA21-0AA3
630 A	–	3KC4346-0EA21-0AA3	3KC4446-0EA21-0AA3
800 A	–	3KC4348-0FA21-0AA3	3KC4448-0FA21-0AA3
1000 A	–	3KC4350-0FA21-0AA3	3KC4450-0FA21-0AA3
1250 A	–	3KC4352-0GA21-0AA3	3KC4452-0GA21-0AA3
1600 A	–	3KC4354-0HA21-0AA3	3KC4454-0HA21-0AA3
2000 A	–	3KC4356-0JA21-0AA3	3KC4456-0JA21-0AA3
2500 A	–	3KC4358-0JA21-0AA3	3KC4458-0JA21-0AA3
3200 A	–	3KC4360-0JA21-0AA3	3KC4460-0JA21-0AA3

3KC6 and 3KC8 automatic transfer switching equipment (ATSE)

40 to 3200 A

	Box terminal 3KC6 (ATSE)	Flat terminal 3KC8 (ATSE)	
Version	With motorized operating mechanism, integrated controller and additional handle	With motorized operating mechanism, integrated controller and additional handle	
Operating mechanism	Operating mechanism on right	Operating mechanism on right	
Mounting	Floor and DIN-rail mounting	Floor mounting	
Bridging bars	Additionally required for connection side	Additionally required for connection side	
Scope of supply	Wired ready for operation (including power supply)	Without power supply and voltage sensing cables	
	 	 	 
Rated uninterrupted current I_u	4-pole	3-pole	4-pole
Box terminal			
40 A	3KC6424-2TA20-0TA3	–	–
63 A	3KC6426-2TA20-0TA3	–	–
80 A	3KC6428-2TA20-0TA3	–	–
100 A	3KC6430-2TA20-0TA3	–	–
125 A	3KC6432-2TA20-0TA3	–	–
160 A	3KC6434-2TA20-0TA3	–	–
Flat terminal			
250 A	–	3KC8338-0CA22-0GA3	3KC8438-0CA22-0GA3
400 A	–	3KC8342-0DA22-0GA3	3KC8442-0DA22-0GA3
630 A	–	3KC8346-0EA22-0GA3	3KC8446-0EA22-0GA3
800 A	–	3KC8348-0FA22-0GA3	3KC8448-0FA22-0GA3
1000 A	–	3KC8350-0FA22-0GA3	3KC8450-0FA22-0GA3
1250 A	–	3KC8352-0GA22-0GA3	3KC8452-0GA22-0GA3
1600 A	–	3KC8354-0HA22-0GA3	3KC8454-0HA22-0GA3
2000 A	–	3KC8356-0JA22-0GA3	3KC8456-0JA22-0GA3
2500 A	–	3KC8358-0JA22-0GA3	3KC8458-0JA22-0GA3
3200 A	–	3KC8360-0JA22-0GA3	3KC8460-0JA22-0GA3

Accessories

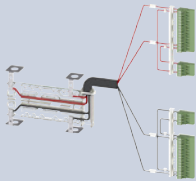
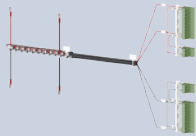
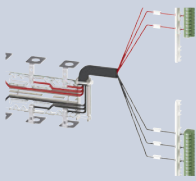
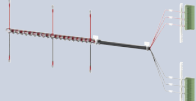
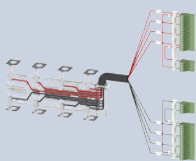
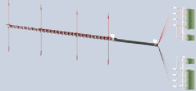
For remote transfer switching equipment (RTSE) and automatic transfer switching equipment (ATSE)






				RTSE	ATSE		
Bridging bar							
	<ul style="list-style-type: none"> For load-side connection For 3KC4/3KC8 3-pole transfer switches 3 units, for 3KC4/3KC8 4-pole transfer switches 4 units are required 						
	Version	Number of poles	Scope of supply	Article No.			
	For 40 ... 125 A	4-pole	1 unit	3KC9618-2	■	■	
	For 160 A	4-pole	1 unit	3KC9618-3	■	■	
	For 250 A	1-pole	1 unit	3KC9818-2	■	■	
	For 400 A	1-pole	1 unit	3KC9818-3	■	■	
	For 630 A	1-pole	1 unit	3KC9818-4	■	■	
	For 800 ... 1000 A	1-pole	1 unit	3KC9818-5	■	■	
	For 1250 A	1-pole	1 unit	3KC9818-6	■	■	
	For 1600 A	1-pole	1 unit	3KC9818-7	■	■	
For 2000 ... 3200 A	1-pole	1 unit	3KC9818-8	■	■		
Control wire tap							
	Version	Scope of supply		Article No.			
	For 40 ... 160 A	2 units		3KC9622-2	■	■	
Auxiliary switches for 40 ... 160 A							
	<ul style="list-style-type: none"> For 250 V AC/5 A or for 24 V DC/2 A 1 change-over contact for each position O, I, II Max. 2 auxiliary switches can be installed per transfer switching equipment unit 						
	Version	Contact configuration		Article No.			
	For 40 ... 160 A	With separate contacts		3KC9603-1	■	■	
		With linked common contacts		3KC9603-2	■	■	
Auxiliary switches for 250 ... 1600 A							
	<ul style="list-style-type: none"> One auxiliary switch contains 2 leading changeover contacts, one changeover contact for position I and one changeover contact for position II (incl. bolt set) Max. two auxiliary switches can be installed per transfer switching equipment unit For 2000 ... 3200 A transfer switching equipment the auxiliary switch is included in the basic unit 250 V AC/12 A (AC-13), 24 V DC/14 A (DC-13) 						
	Version				Article No.		
	For 250 ... 630 A				3KC9803-1	■	■
	For 800 ... 1600 A				3KC9803-2	■	■
	For 2000 ... 2500 A (included in the basic unit)				–	■	■

					RTSE	ATSE
Terminal covers						
	Version	Number of poles	Scope of supply	Article No.		
	For 40 ... 160 A	4-pole	2 units (1 unit covers 4 poles)	3KC9604-2	■	■
	For 250 ... 400 A	3-pole	3 units (1 unit covers 1 pole)	3KC9804-1	■	■
4-pole		4 units (1 unit covers 1 pole)	3KC9804-2	■	■	
	For 630 A	3-pole	3 units (1 unit covers 1 pole)	3KC9804-3	■	■
		4-pole	4 units (1 unit covers 1 pole)	3KC9804-4	■	■
						
Sealable cover						
	Version	Scope of supply		Article No.		
	For 3KC6 (ATSE) 40 ... 160 A	Incl. bolt set and sealing ribbons		3KC9721-1	–	■
	For 3KC8 (ATSE) 250 ... 3200 A	Incl. bolt set and sealing ribbons		3KC9821-0	–	■
						
Sealing ribbon						
	<ul style="list-style-type: none"> Also as spare part for sealable cover 					
	Version	Scope of supply		Article No.		
	For 40 ... 3200 A	10 units		3KC9621-2	–	■
Autotransformers						
	Version	Technical specifications		Article No.		
	For 40 ... 160 A	400 V/230 V AC; 400 VA		3KC9624-1	■	■
	For 250 ... 3200 A, 3-pole	400 V/230 V AC; 200 VA		3KC9824-1	■	■
						

Accessories

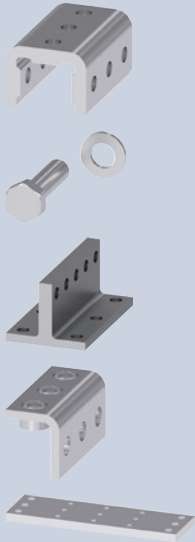
For remote transfer switching equipment (RTSE) and automatic transfer switching equipment (ATSE)

Power supply and voltage sensing cables for ATSE						RTSE	ATSE
Application	Infeed	Switches	Version	Article No.			
 <p>For 250 ... 630 A</p>	From below, with power supply	3-pole	For 250 A	3KC9833-1	–	■	
			For 400 A	3KC9833-2	–	■	
			For 630 A	3KC9833-3	–	■	
			For 800 ... 1000 A	3KC9833-4	–	■	
			For 1250 A	3KC9833-5	–	■	
			For 1600 A	3KC9833-6	–	■	
			For 2000 ... 3200 A	3KC9833-7	–	■	
 <p>For 800 ... 3200 A</p>	From above, with power supply	3-pole	For 250 A	3KC9834-1	–	■	
			For 400 A	3KC9834-2	–	■	
			For 630 A	3KC9834-3	–	■	
			For 800 ... 1000 A	3KC9834-4	–	■	
			For 1250 A	3KC9834-5	–	■	
			For 1600 A	3KC9834-6	–	■	
			For 2000 ... 3200 A	3KC9834-7	–	■	
 <p>For 250 ... 630 A</p>	From below, without power supply	3-pole	For 250 A	3KC9822-1	–	■	
			For 400 A	3KC9822-2	–	■	
			For 630 A	3KC9822-3	–	■	
			For 800 ... 1000 A	3KC9822-4	–	■	
			For 1250 A	3KC9822-5	–	■	
			For 1600 A	3KC9822-6	–	■	
			For 2000 ... 3200 A	3KC9822-7	–	■	
 <p>For 800 ... 3200 A</p>	From above, without power supply	3-pole	For 250 A	3KC9832-1	–	■	
			For 400 A	3KC9832-2	–	■	
			For 630 A	3KC9832-3	–	■	
			For 800 ... 1000 A	3KC9832-4	–	■	
			For 1250 A	3KC9832-5	–	■	
			For 1600 A	3KC9832-6	–	■	
			For 2000 ... 3200 A	3KC9832-7	–	■	
 <p>For 250 ... 630 A</p>	From below, with power supply	4-pole	For 250 A	3KC9830-1	–	■	
			For 400 A	3KC9830-2	–	■	
			For 630 A	3KC9830-3	–	■	
			For 800 ... 1000 A	3KC9830-4	–	■	
			For 1250 A	3KC9830-5	–	■	
			For 1600 A	3KC9830-6	–	■	
			For 2000 ... 3200 A	3KC9830-7	–	■	
 <p>For 800 ... 3200 A</p>	From above, with power supply	4-pole	For 250 A	3KC9831-1	–	■	
			For 400 A	3KC9831-2	–	■	
			For 630 A	3KC9831-3	–	■	
			For 800 ... 1000 A	3KC9831-4	–	■	
			For 1250 A	3KC9831-5	–	■	
			For 1600 A	3KC9831-6	–	■	
			For 2000 ... 3200 A	3KC9831-7	–	■	

				RTSE	ATSE	
Dual power supply						
	Version	Technical specifications	Article No.			
	For 3KC3 and 3KC4 (RTSE) 40 ... 3200 A	240 V AC, 3 A	3KC9625-1	■	–	
External display						
	<ul style="list-style-type: none"> For installing in the control cabinet door 					
	Version	Article No.				
For 3KC8 (ATSE) 250 ... 3200 A	3KC9823-0	–	■			
Connection cable						
	<ul style="list-style-type: none"> 3 m RJ45 cable for external display 					
	Version	Article No.				
For 250 ... 3200 A	3KC9823-2	–	■			
Phase barrier						
	<ul style="list-style-type: none"> For 800 ... 3200 A transfer switching equipment included in the scope of supply of the basic unit 					
	Version	Number of poles	Scope of supply	Article No.		
	For 250 ... 400 A	3-pole	2 units	3KC9808-1	■	■
		4-pole	3 units	3KC9808-6	■	■
	For 630 A	3-pole	2 units	3KC9808-2	■	■
4-pole		3 units	3KC9808-7	■	■	
Cover frame for ATSE						
	<ul style="list-style-type: none"> For a clean and safe door cut-out To enable access to the front of the 3KC8 transfer switching equipment (electronic module and operation of the motorized operating mechanism) 					
	Version	Article No.				
	250 ... 630 A	3KC9820-4	–	■		
800 ... 3200 A	3KC9820-5	–	■			

Accessories

For remote transfer switching equipment (RTSE) and automatic transfer switching equipment (ATSE)

					RTSE	ATSE
Copper bar connection kit						
Version	Designation	Scope of supply	Article No.			
	For 2000 ... 2500 A	C-bracket, part A	1 unit	3KC9811-0	■	■
	For 2000 ... 3200 A	Bolt set, part B	1 unit	3KC9811-1	■	■
				3KC9811-2	■	■
		T-bracket, part C	1 unit	3KC9811-3	■	■
		L-bracket, part D	2 units	3KC9811-4	■	■
	Bridging bars, part E	1 unit	3KC9818-8	■	■	

Terminal plates						
• For protecting the front side at the upper and lower connecting terminals						
Version	Number of poles	Article No.				
For 250 ... 400 A	3-pole	3KC9827-1	■	■		
	4-pole	3KC9828-1	■	■		
For 630 A	3-pole	3KC9827-2	■	■		
	4-pole	3KC9828-2	■	■		
For 800 ... 1250 A	3-pole	3KC9827-3	■	■		
	4-pole	3KC9828-3	■	■		
For 1600 A	3-pole	3KC9827-4	■	■		
	4-pole	3KC9828-4	■	■		
For 2000 ... 3200 A	3-pole	3KC9827-5	■	■		
	4-pole	3KC9828-5	■	■		

			RTSE	ATSE
Motorized operating mechanism as spare part				
	Version	Article No.		
	For 250 ... 400 A	3KC9826-1	■	■
	For 630 A	3KC9826-2	■	■
	For 800 ... 1250 A	3KC9826-3	■	■
	For 1600 A	3KC9826-4	■	■
	For 2000 ... 3200 A	3KC9826-5	■	■
Controller (electronic module) as spare part				
	Version	Article No.		
	For 250 ... 3200 A	3KC9826-0	–	■
Mounting kit as spare part				
	<ul style="list-style-type: none"> Comprising two device holders, each with two plastic covers 			
	Version	Article No.		
	For 250 ... 630 A	3KC9820-6	■	■



Copper bar connection kit

You will find further information at:
sie.ag/36U7MCb

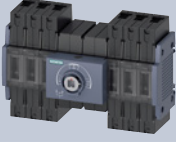
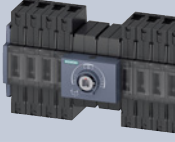


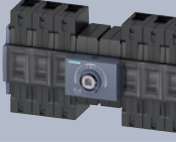
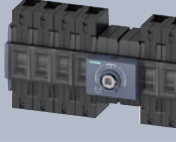


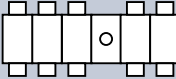
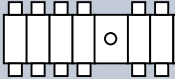

3KC0 manual transfer switching equipment (MTSE)

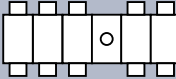
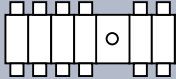
16 to 1600 A

	Box terminal Size 1	Size 2
Version	Basic unit without handle	Basic unit without handle
Operating mechanism	Front operating mechanism	Front operating mechanism
Mounting	DIN-rail and floor mounting ¹⁾	DIN-rail and floor mounting ¹⁾
Bridging bars	Additionally required for connection side	Additionally required for connection side





Rated uninterrupted current I_u	Box terminal		Flat terminal	
	3-pole	4-pole	3-pole	4-pole
Box terminal				
16 A	3KC0316-2ME00-0AA0	3KC0416-2ME00-0AA0	–	–
32 A	3KC0322-2ME00-0AA0	3KC0422-2ME00-0AA0	–	–
63 A	3KC0326-2ME00-0AA0	3KC0426-2ME00-0AA0	–	–
80 A	–	–	3KC0328-2NE00-0AA0	3KC0428-2NE00-0AA0
100 A	–	–	3KC0330-2NE00-0AA0	3KC0430-2NE00-0AA0
125 A	–	–	3KC0332-2NE00-0AA0	3KC0432-2NE00-0AA0
160 A	–	–	3KC0334-2NE00-0AA0	3KC0434-2NE00-0AA0
Flat terminal				
200 A	–	–	–	–
250 A	–	–	–	–
315 A	–	–	–	–
400 A	–	–	–	–
500 A	–	–	–	–
630 A	–	–	–	–
800 A	–	–	–	–
1000 A	–	–	–	–
1250 A	–	–	–	–
1600 A	–	–	–	–

¹⁾ An assembly kit is required for floor mounting

Accessories


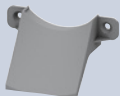
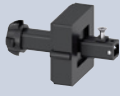





For manual transfer switching equipment (MTSE)

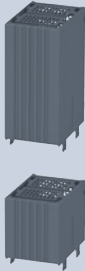


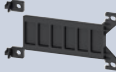
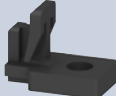

				Size 1	Size 2	Size 3	Size 4	Size 5				
Box terminal (4th contact element, switching pole)												
	Connection			Article No.								
		3KD9105-2		■								
		3KD9205-2			■							
Auxiliary switch module												
	<ul style="list-style-type: none"> • Delivery: Does not include auxiliary switch • A maximum of 2 auxiliary switches can be installed per auxiliary switch module. • The auxiliary switches indicate the switch position of the respective switching equipment (I or II) to which the auxiliary switch module is connected. 											
	Type			Article No.								
Standard version			3KD9103-5		■	■						
Auxiliary switches												
<ul style="list-style-type: none"> • Auxiliary switches for sizes 3 to 5 have a screw terminal and are mounted on the 3K operating mechanism module. Auxiliary switches with spring-loaded terminals from the 3SU1 program can also be used. • All auxiliary switches for sizes 3 to 5 can be used as leading auxiliary switches, depending on the mounting position of the auxiliary switch (see operating instructions). 												
  	Type		Contacts		Contact surface		Article No.					
	With connecting cables		1 CO		Standard		3KD9103-1		■	■		
					Solid-state compatible		3KD9103-3		■	■		
	Without connecting cables		1 CO		Standard		3KD9103-2		■	■		
					Solid-state compatible		3KD9103-4		■	■		
			1 NO		Standard		3SU1400-1AA10-1BA0			■	■	■
					Gold-plated		3SU1400-1AA10-1LA0			■	■	■
	1 NC		Standard		3SU1400-1AA10-1CA0			■	■	■		
			Gold-plated		3SU1400-1AA10-1MA0			■	■	■		
	1 NO + 1 NC		Standard		3SU1400-1AA10-1FA0			■	■	■		
			Gold-plated		3SU1400-1AA10-1QA0			■	■	■		
	2 NO		Standard		3SU1400-1AA10-1DA0			■	■	■		
			Gold-plated		3SU1400-1AA10-1NA0			■	■	■		
	2 NC		Standard		3SU1400-1AA10-1EA0			■	■	■		
Gold-plated			3SU1400-1AA10-1PA0			■	■	■				
Bridging bars												
<ul style="list-style-type: none"> • For load-side connection • For 3-pole transfer switches (sizes 3 to 5) 3 units, for 4-pole transfer switches (sizes 3 to 5) 4 units are required 												
	Number of poles			Article No.								
	1-pole		1 unit		3KC9318-0			■				
					3KC9418-0				■			
					3KC9518-0					■		
	3-pole		1 unit		3KC9118-1		■					
					3KC9218-1			■				
	4-pole		1 unit		3KC9118-2		■					
					3KC9218-2			■				

					Size 1	Size 2	Size 3	Size 4	Size 5	
Direct operating mechanism standard version										
<ul style="list-style-type: none"> • Can be locked with up to max. 3 padlocks • Requires additional mounting depth in locked state 										
	Color			Article No.						
	Gray			3KC9201-3	■	■				
				3KC9301-1			■			
				3KC9401-1				■		
				3KC9501-1					■	
	Red/yellow			3KC9301-2			■			
			3KC9401-2				■			
			3KC9501-2					■		
Flat direct operating mechanism for distribution boards										
<ul style="list-style-type: none"> • Can be locked with one padlock • No additional mounting depth in locked state 										
	Color			Article No.						
	Gray			3KC9101-4	■					
Door-coupling rotary operating mechanism, 8UD1 series										
<ul style="list-style-type: none"> • Handle with masking plate • Coupling driver with tolerance compensation • Shaft 300 mm • Can be locked with up to max. 3 padlocks • Labeling I – O – II 										
	Color			Article No.						
	Gray			55 mm	8 × 8 mm	8UD1131-2AE21	■	■		
				100 mm	8 × 8 mm	8UD1141-2AE21			■	
				140 mm	10 × 10 mm	8UD1151-3AE21				■
				200 mm	12 × 12 mm	8UD1161-4AE21				■
Handles for door-coupling rotary operating mechanisms, 8UD1 series										
<ul style="list-style-type: none"> • Without extension shaft and coupling driver • With masking plate • Can be locked with up to max. 3 padlocks • Labeling I – O – II 										
	Color			Article No.						
	Gray			55 mm	8 × 8 mm	8UD1731-2AE01	■	■		
				100 mm	8 × 8 mm	8UD1841-2AE01			■	
				140 mm	10 × 10 mm	8UD1851-3AE01				■
				200 mm	12 × 12 mm	8UD1861-4AE01				■
	Red/yellow			55 mm	8 × 8 mm	8UD1731-2AE05	■	■		
				100 mm	8 × 8 mm	8UD1841-2AE05			■	
				140 mm	10 × 10 mm	8UD1851-3AE05				■
				200 mm	12 × 12 mm	8UD1861-4AE05				■

Accessories

For manual transfer switching equipment (MTSE)

				Size 1	Size 2	Size 3	Size 4	Size 5
Extension shaft for door-coupling rotary operating mechanism, 8UD1 series								
	<ul style="list-style-type: none"> A shaft jack is required for the 8UD1 handle when the 600 mm long shaft is used and for sizes 1/2. 							
	Length	Cross-section	Article No.					
	300 mm	8 × 8 mm	8UC6032	■	■	■		
		10 × 10 mm	8UC6033				■	
		12 × 12 mm	8UC6034					■
	600 mm	8 × 8 mm	8UC6082	■	■	■		
		10 × 10 mm	8UC6083				■	
		12 × 12 mm	8UC6084					■
Shaft jack for 8UD1 handle for shaft, 600 mm								
	Shaft	Article No.						
	8 × 8 mm	8UD1900-0FA00		■	■			
Coupling drivers								
	Type	Shaft	Article No.					
	With tolerance compensation	8 × 8 mm	8UD1900-2GA00	■	■			
		8 × 8 mm	8UD1900-6GA00				■	
		10 × 10 mm	8UD1900-3GA00					■
		12 × 12 mm	8UD1900-4GA00					■
	Without tolerance compensation	8 × 8 mm	8UD1900-2HA00	■	■			
		8 × 8 mm	8UD1900-6HA00				■	
		10 × 10 mm	8UD1900-3HA00					■
		12 × 12 mm	8UD1900-4HA00					■
Adapters for shafts								
	<ul style="list-style-type: none"> Non-interchangeability features (rivet and lug) 							
	Shaft	Article No.						
	8 × 8 mm	8UC6022		■	■			
	8 × 8 mm	8UC6022					■	
	10 × 10 mm	8UC6023						■
	12 × 12 mm	8UC6024						■
Phase barriers								
	<ul style="list-style-type: none"> For manual transfer switching equipment (MTSE) with flat terminals One pack (6 or 8 units) is required for the infeed side and the load side 							
	Number of poles, switch	Scope of supply	Article No.					
	3-pole	6 units	3KD9308-6				■	
		6 units	3KD9408-6					■
		6 units	3KD9508-6					■
	4-pole	8 units	3KD9308-8				■	
		8 units	3KD9408-8					■
		8 units	3KD9508-8					■

				Size 1	Size 2	Size 3	Size 4	Size 5	
Terminal covers									
<ul style="list-style-type: none"> For manual transfer switching equipment (MTSE) with flat terminals One pack (6 or 8 units) is required for the infeed side and the load side Additional side plate covers are required for terminal covers on the terminal side, where bridging bars are used (normally the load side) 									
	Length	Number of poles, switch	Scope of supply	Article No.					
	Standard length	3-pole	6 units	3KD9304-6			■		
				3KD9404-6				■	
				3KD9504-6					■
	Short version	3-pole	6 units	3KD9304-7			■		
				3KD9404-7				■	
				3KD9504-8					■
	Standard length	4-pole	8 units	3KD9304-8			■		
				3KD9404-8				■	
				3KD9504-8					■
Short version	4-pole	8 units	3KD9304-5			■			
			3KD9404-5				■		
			3KD9504-5					■	
Terminal covers as spare parts									
	Length		Scope of supply	Article No.					
	Standard length		1 unit	3KD9504-1				■	
		Short version			3KD9304-1			■	
			1 unit	3KD9404-1				■	
Side plate covers									
	<ul style="list-style-type: none"> For lateral touch protection on the terminal side, where bridging bars are used (normally the load side) Suitable for terminal covers in standard length 								
	Length		Scope of supply	Article No.					
	Standard length		2 units	3KC9304-0			■		
				3KC9404-0				■	
		3KC9504-0						■	
Assembly kit for floor mounting									
	<ul style="list-style-type: none"> For floor mounting of sizes 1 and 2 Contains 4 mounting brackets and 2 mounting plates for 3-pole and 4-pole devices 								
				Article No.					
				3KC9120-1		■	■		
Mounting bracket as spare part									
	<ul style="list-style-type: none"> Spare part for mounting brackets included in the assembly kit for 3-pole and 4-pole devices 								
	Scope of supply			Article No.					
	4 units			3KD9120-1		■	■		
Slide for mounting on DIN rail as spare part									
	<ul style="list-style-type: none"> Spare part included in the scope of supply for the 3KCO slide for DIN-rail mounting 								
	Scope of supply			Article No.					
	5 units			3KF9112-0BA00		■	■		

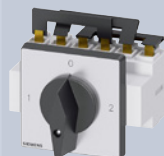
3LD2 load transfer switches

Up to 250 A

Front mounting

Direct operating mechanism (knob-operated mechanism)

Actuator color	Black
Locking device	3LD23 and 3LD24 lockable with up to 3 padlocks with a hasp thickness of 4 to 6 mm (all other versions non-lockable)
Mounting	Four-hole mounting
Bridging bars	Pre-assembled



Rated uninterrupted current I_n (AC-21A, 380 ... 440 V)	Rated operational power (50/60 Hz, 380 ... 440 V)		3P		3P+N	
	At AC-23A	At AC-3				
25 A	9.5 kW	7.5 kW	3LD2123-7UK01			–
32 A	11.5 kW	9.5 kW	3LD2223-7UK01			–
63 A	22.0 kW	18.5 kW	3LD2524-7UK01			–
100 A	37.0 kW	30.0 kW	3LD2724-7UK01			–
160 A	75 kW	50 kW	3LD2305-7UK01			3LD2305-7UL01
250 A	132 kW	110 kW	3LD2405-7UK01			3LD2405-7UL01

9

Accessories

4th contact (N conductor)



- Leading switch-on, lagging switch-off
- Bridging bars for the switchable N pole are not included in the scope of supply

Load transfer switch design

Front mounting

Article No.

	3LD21 (25 A)	3LD22 (32 A)	3LD25 (63 A)	3LD27 (100 A)	3LD23 (160 A)	3LD24 (250 A)
3LD9220-0B	■	■				
3LD9250-0BA			■			
3LD9280-0B				■		
3LD9240-0B					■	■
Floor mounting					■	■
Molded-plastic enclosures						
3LD9220-0C	■	■				
3LD9250-0CA ¹⁾			■			
3LD9280-0C ¹⁾				■		

N or PE terminals



- Through-type

Load transfer switch design



Front mounting



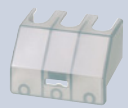

Article No.

Floor mounting

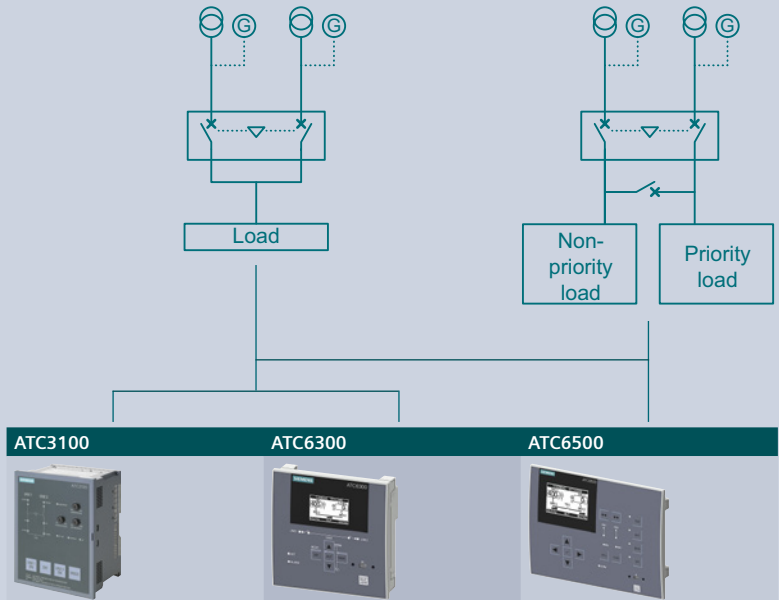
3LD9240-2C

¹⁾ Can only be used as a spare part, as no additional poles can be installed in the enclosure.

Floor mounting Door-coupling rotary operating mechanism (knob-operated mechanism)		Molded-plastic enclosures Direct operating mechanism (knob-operated mechanism)
Black		Black
Lockable in O position with up to 3 padlocks with a hasp thickness of 4 to 6 mm		3LD21 and 3LD22 lockable in O position with up to 3 padlocks with a hasp thickness of 4 to 6 mm (all other versions non-lockable)
Four-hole mounting		Metric screw connection
Pre-assembled		Pre-assembled
		
3P	3P+N	3P+N and PE base terminal
-	-	3LD2165-7UB01
-	-	3LD2265-7UB01
-	-	3LD2566-7UB01
-	-	3LD2766-7UB01
3LD2318-7UK01	3LD2318-7UL01	-
3LD2418-7UK01	3LD2418-7UL01	-

				3LD21 (25 A)	3LD22 (32 A)	3LD25 (63 A)	3LD27 (100 A)	3LD23 (160 A)	3LD24 (250 A)
Auxiliary switches									
	<ul style="list-style-type: none"> For mounting on the left and/or right, lagging switch-on, leading switch-off For 3-pole load transfer switches only Indicate the switch position of the respective load transfer switch (I or II) to which the auxiliary switch module is connected 								
	Load transfer switch design	Contacts	Type of contact	Article No.					
	Front mounting	1 NO + 1 NC	Standard Gold-plated	3LD9200-5B 3LD9200-5BF	■	■	■	■	■
	Floor mounting and molded-plastic enclosure	1 NO + 1 NC	Standard Gold-plated	3LD9200-5C 3LD9200-5CF	■	■	■	■	■
		2 NO	Standard	3LD9200-6C	■	■	■	■	■
Terminal covers as additional touch protection									
	For mounting on load side only								
	Number of poles		Scope of supply	Article No.					
	1-pole		4 units	3LD9221-2A 3LD9251-2A 3LD9281-2A 3LD9241-2A	■	■			■
	3-pole		4 units	3LD9221-0A 3LD9251-0A	■	■			■
Shaft coupling									
	No ON-lock								
	Load transfer switch design			Article No.					
	Floor mounting			3LD9242-4F				■	■

3KC ATC transfer control devices



Version	Controllable switching devices	Interfaces	ATC3100	ATC6300	ATC6500
For fast parameterization without software	2	–	3KC9000-8EL10	–	–
For programming with user-friendly software, with programmable inputs and outputs	2	Optional communications interface and LCD display	–	3KC9000-8TL40	–
	3	Integrated RS485 interface and LCD display	–	–	3KC9000-8TL50

9

Further technical specifications		ATC3100	ATC6300	ATC6500
Application				
Transfer between		Network/network, network/generator	Network/network, network/generator, generator/generator	
Controllable switching devices		2		3
In-phase transition		–		Yes
Implementation of transfer with		3VA, 3VL, 3VT, 3WA/3WL, 3WT	3WA/3WL FSI-III, 3WT, 3KC3, 3KC4, 3VA, 3VL	3WA/3WL FSI-III, 3WL10, 3WT, 3VA
Measuring inputs				
Max. rated operational voltage U_e	Phase-phase	400 V AC	480 V AC	600 V AC
	Phase-neutral conductor	230 V AC	277 V AC	346 V AC
Measuring range	Phase-phase	–	50 ... 576 V AC	50 ... 720 V AC
	Phase-neutral conductor	161 ... 264 V AC	50 ... 333 V AC	30 ... 415 V AC
Frequency range		50/60 Hz	45 ... 65 Hz	
Relative error of measurement method		±5%	±0.25%	
Communication				
Integrated RS485 interface (Modbus RTU)		–		Yes
Optional RS485 interface (Modbus RTU)		–	Yes	Ready-integrated
Optional Ethernet interface (Modbus TCP)		–	Yes	
Power supply				
Auxiliary power supply	Rated operational voltage U_e AC	220 ... 240 V	100 ... 240 V	
	Rated operational voltage U_e DC	–	110 ... 250 V	
	Frequency range	50/60 Hz	45 ... 65 Hz	
Battery power supply	Rated operational voltage U_e DC	12/24 V		12/24/48 V
Digital inputs				
Number of inputs		5	6	8
Freely programmable		–	All	
Relay outputs				
Number of outputs		7	7	
Freely programmable		–	All	
Contact configuration		–	6 × 1 NO, 8 A, 250 V AC (AC-1) 1 × 1 CO, 8 A, 250 V AC (AC-1)	2 × 1 NO, 12 A, 250 V AC (AC-1) 2 × 1 NO, 8 A, 250 V AC (AC-1) 3 × 1 CO, 8 A, 250 V AC (AC-1)
Real time clock and event log				
ATC component		No	Yes	
Operating time without voltage		–	300 s	14 days
Max. number of events that can be stored		–	100	250
Connections				
Terminal type		Removable/plug-in		
Cable cross-section IEC		0.5 ... 2.5 mm ²	0.2 ... 2.5 mm ²	
Enclosures				
Version		Door installation, DIN-rail mounting, floor mounting	Door installation	
Degree of protection		IP41 on the front, IP20 on the rear side	IP40 on the front, IP20 on the rear side	

Accessories for transfer control devices

For 3KC ATC3100 transfer switching equipment

Connecting cable for 3KC ATC3100

- Measurement and control cable for connection of 3KC ATC3100 to 3VL or 3WA/3WL

Cable length	Article No.
1.8 m	3KC9000-8EL62

For 3KC ATC6300 and 3KC ATC6500 transfer switching equipment

Expansion modules with digital inputs and outputs



ATC6 expansion module	Features	Article No.
4DI	<ul style="list-style-type: none"> 4 digital inputs Including insulated 24 V DC/1 W power supply for digital inputs and sensors 	3KC9000-8TL60
4DO, SSR	<ul style="list-style-type: none"> 4 solid-state-compatible digital outputs 4 NO at the solid-state-compatible output max. 55 mA at 30 V AC or 40 V DC 	3KC9000-8TL61
2DI/2DO, SSR	<ul style="list-style-type: none"> 2 digital inputs and 2 solid-state compatible digital outputs Including insulated 24 V DC/1 W power supply for digital inputs and sensors 2 NO at the solid-state-compatible output max. 55 mA at 30 V AC or 40 V DC 	3KC9000-8TL62
2DO, relay	<ul style="list-style-type: none"> 2 relay outputs 2 CO at relay output, 5 A, 250 V AC (AC-1) 	3KC9000-8TL63
2DI/2DO, relay	<ul style="list-style-type: none"> 2 digital inputs and 2 relay outputs 2 NO at relay output, 5 A, 250 V AC (AC-1) 	3KC9000-8TL64

Expansion modules with communications interfaces



- Note:** The 3KC ATC6500 transfer switching equipment comes with an integrated RS485 interface

ATC6 expansion module	Features	Article No.
RS485	<ul style="list-style-type: none"> RS485 interface, Modbus RTU 	3KC9000-8TL74
Ethernet	<ul style="list-style-type: none"> Ethernet interface, Modbus TCP 	3KC9000-8TL75

Front interface



- For parameterization on the front using software

ATC6 front interface	Features	Article No.
USB	<ul style="list-style-type: none"> Mini-USB cable, 1.8 m 	3KC9000-8TL73

Protective seal



- For front IP65 protection

Suitable for	Version	Article No.
3KC ATC6300	144 × 144 mm	3KC9000-8TL67
3KC ATC6500	240 × 180 mm	3KC9000-8TL68



Easy, reliable, cost-efficient

There are many advantages to be had from keeping a watchful eye on your energy consumption: in addition to cost savings through optimized consumption, you ensure increased resilience with the monitoring of power supply systems and network quality in infrastructure and industrial plants.

At the same time, systematic power monitoring increases your awareness of actual energy consumption, making it a key prerequisite for greater energy efficiency.

Integration into open IoT operating systems such as Insights Hub results in even greater optimization potential.

What is more, with a power monitoring system you lay the foundation for regular energy audits and a corporate energy management system according to ISO 50001 and ISO 50003.

Measuring Devices, Power Monitoring and Digitalization Solutions

All the information you need	10/2
Quick selection guide	10/4
Power monitoring	10/4
Hardware components	10/6
Accessories	10/10
Software and digitalization solutions	10/12
SENTRON Powerconfig	10/12
SENTRON Powermanager	10/14
SENTRON Powercenter	10/18
SENTRON Powermind	10/22
SIMATIC Modbus/TCP SENTRON PAC	10/24
PAC/3WL/3VA SIMATIC PCS 7 library	10/25
Measuring devices	10/26
7KM PAC measuring devices	10/26
7KT PAC measuring devices	10/30
SEM3 multichannel current measuring system	10/32
SEM3T multichannel temperature measuring system	10/34
Time and pulse counters	10/36
Current transformers	10/38
Bushing-type current transformers for measurement purposes	10/38

A multitude of additional information ...

Information + ordering

All the important things at a glance

For information about measuring devices, power monitoring and digitalization solutions, please visit our websites

www.siemens.com/sentron-measuring-devices
www.siemens.com/sentron-digital

Your product in detail

The SiePortal platform (knowledge base) provides comprehensive information

www.siemens.com/lowvoltage/product-support

- Quick Selection Guide
 - SENTRON portfolio for power monitoring (109744725)
- Brochure
 - SENTRON Powermanager – update and benefit (109805178)

The relevant tender specifications can be found at www.siemens.com/tenderspecifications

Siemens YouTube channel

- Power monitoring (general) sie.ag/7N6g4g

Everything you need for your order

Refer to SiePortal to find an overview of your products (product catalog)

- Measuring devices and power monitoring sie.ag/2kTH9Lz
- Digitalization solutions sie.ag/2olliNi
- Configuring and visualizing for SIMATIC sie.ag/2kpbwcs
- Software and apps sie.ag/2kTJjuF

Direct forwarding to the individual products in SiePortal by clicking on the article number in the catalog or entering this web address incl. article number www.siemens.com/product_catalog_SIEP?Article.No.

Configurators

The configurator reduces the time and effort required in the planning and ordering process, and allows for individual adaptations.

Configure your 7KM PAC and 7KT PAC measuring device at www.siemens.com/lowvoltage/pac-configurator

The fast track to the experts

Contact persons in your region

We offer a comprehensive portfolio of services.

You can find your local contacts at

www.siemens.com/lowvoltage/components/contact

You will find further information on services at

www.siemens.com/service-offers

Competent expert advice on technical questions with a wide range of demand-optimized services for all our products and systems.

Assistance with technical queries is provided at

www.siemens.com/support-request

... can be found in our online services

Commissioning + operation

Your product in detail

The SiePortal platform (knowledge base) provides detailed technical information

www.siemens.com/lowvoltage/product-support

- Operating instructions
- Certificates

Online Support app available for download from the [App Store](#) and [Play Store](#)

You will find further information at www.siemens.com/support-app

Provision of 3D data (step and u3d data formats)

- SiePortal (product catalog)
www.siemens.com/lowvoltage/product-catalog
- Image database
www.siemens.com/lowvoltage/picturedb

Engineering data for CAD or CAE systems are available in the CAx Download Manager at www.siemens.com/cax

Face-to-face or online training

Our training courses can be found at www.siemens.com/sitrain-lowvoltage

- Digitalization in power distribution boards (WT-LVDIGI)
- SENTRON circuit protection devices with measuring and communication function (WT-LVBCOM)
- Power Monitoring with SENTRON (WT-LVAEM)
- Energy Management with SENTRON Powermanager – User training (LV-PM)
- SENTRON Powermanager graphic module – User training (LV-PMG)

SENTRON Powerconfig

The combined commissioning and service tool SENTRON Powerconfig for communication-capable measuring devices, circuit protection devices and circuit breakers.

Free download SENTRON Powerconfig
www.siemens.com/powerconfig

Free download SENTRON Powerconfig mobile via [App Store](#) and [Play Store](#)

Manuals

Manuals can be found in SiePortal at www.siemens.com/lowvoltage/manuals

- Configuration Manual
 - Measuring devices and power monitoring (45315973)
- Equipment Manual
 - 7KT PAC1600 energy meter (109759827)
 - 7KT PAC1600 multimeter (109760293)
 - 7KM PAC2200 power monitoring device (109746835)
 - 7KM PAC2200CLP power monitoring device (109783220)
 - 7KM PAC3200T power monitoring device (109746833)
 - SENTRON PAC5100/5200 7KM5212/5412 (109477872)
 - 7KM PAC3120 and 7KM PAC3220 (109767307)
 - SENTRON Powercenter 3000 (109763838)
- System Manual
 - 7KT multichannel current measuring system (109483442)
 - SENTRON power monitoring device PAC4200 (34261595) // PAC4220 (109823026)
 - SENTRON circuit protection devices with communication and measuring function (109791806)
- Communication Manual
 - SENTRON PAC5100/5200 7KM5212/5412 (109477870)
 - 3VA molded case circuit breakers with IEC and UL certification (98746267)
- SEM3™
 - Embedded Micro Metering Module™ (109748928)
- Quick Installation Guide
 - SENTRON POWERCENTER 3000 (109766001)
- Installation Manual
 - Circuit protection devices with communication and measuring function (109791805)

Technical overview – Measuring devices, power monitoring and digitalization solutions



The fast way to get you to our online services

This page provides you with comprehensive information and links on measuring devices, power monitoring and digitalization solutions

www.siemens.com/lowvoltage/product-support (109764480)

Power monitoring

Software

Local monitoring systems

Web



Web interface integrated

Mobile App



SENTRON Powerconfig

Functions for power monitoring

- Commissioning of measuring devices and circuit breakers
- Displaying current data
- Displaying/evaluating current/historical values
- Prepared analyses/reports
- Customized reporting
- Data analysis in the cloud

Commissioning of measuring devices and circuit breakers	–	■
Displaying current data	■	■
Displaying/evaluating current/historical values	■	■
Prepared analyses/reports	–	–
Customized reporting	–	–
Data analysis in the cloud	–	–

Additionally for energy management

- Switching loads on and off

Switching loads on and off	–	–
----------------------------	---	---

Operating environment

- Use
- System requirements
- Suitable according to ISO 50001
- Connection of non-Siemens devices
- Integrated cloud interface

Use	Free of charge	Free of charge
System requirements	Browser	Android, iOS
Suitable according to ISO 50001	–	–
Connection of non-Siemens devices	–	–
Integrated cloud interface	–	–

Further information

From page 10/12

Measuring devices, circuit breakers and circuit protection devices

Measuring devices for industrial applications



7KM PAC1020	–	–
7KM PAC2200/PAC2200CLP	■	■ ^{1) 2)}
7KM PAC3200T	■	■ ¹⁾
7KM PAC3120	–	■ ²⁾
7KM PAC3220	■	■
7KM PAC4200	■	■
7KM PAC4220	–	–
7KM PAC5200	■	–

Measuring devices for buildings and infrastructure



7KT PAC1200	■	–
7KT PAC1600	–	–
SEM3/SEM3T	■	–

Circuit breakers



3WA	–	■
3WL	–	■
3WL10/3VA27	–	–
3VA ETU5/8	–	■

Communication-capable circuit protection devices



SENTRON Powercenter 1000/ 5ST3 COM AS+FC/ 5SL6 COM MCB/ 5SV6 COM AFDD/ 3NA COM Fuse	–	■
---	---	---

Other Modbus devices

- Function available
- Function not available

¹⁾ Via WiFi

²⁾ Via gateway (PAC4200)

³⁾ Incl. module for Desigo CC building management

⁴⁾ Via XML/JSON

⁵⁾ Via SPP2000

⁶⁾ Via Modbus TCP

PC-based			Cloud	World of SIMATIC	
SENTRON Powerconfig	SENTRON Powermanager ³⁾	SENTRON Powercenter 3000	SENTRON Powermind (Insights Hub)	TIA Portal	
				SIMATIC TIA Portal integrated	SIMATIC TIA Portal capable
■	-	-	-	■	-
■	■	■	■	■	■
■	■	■	■	■	■
-	■	-	■	■	-
-	■	-	-	-	-
-	-	-	■	-	-
-	■	-	-	■	■
Free of charge	License and trial license	-	Subscription	-	-
Windows X64	Windows X64	-	Browser	-	-
-	■ (TÜV)	■	■	-	-
-	■	■	■	-	-
-	■	■	■	-	-
From page 10/12	From page 10/14	From page 10/18	From page 10/22		
■	■ ⁴⁾	■	■	-	-
■	■	■	■	-	■ ⁵⁾
■	■	■	■	-	■ ⁵⁾
■	■	■	■	-	-
■	■	■	■	■	■
■	■	■	■	■	■
■	-	-	-	-	-
■	■	-	-	-	-
■	■	-	-	-	-
■	■	-	-	-	-
■	■/■ ⁴⁾	-	-	-	-
■	■	■	■	-	■
■	■	■	■	■	■
■	■	-	-	-	■
■	■	■	■	■	■
■	■	■	■	-	■ ⁶⁾
■	■	■	■	-	-

Hardware components

Industry



	7KM PAC1020	7KM PAC2200	7KM PAC2200- CLP	7KM PAC3200T	7KM PAC3120	7KM PAC3220
Type of mounting						
Front mounting DIN rail Screw mounting	■ - -	- ■ -	- ■ -	- ■ -	■ - -	■ - -
Withdrawable Fixed-mounted	- -	- -	- -	- -	- -	- -
Measuring connection						
Direct measurement	-	■	■	-	-	-
Transformer measurement	■	■	■	■	■	■
Multichannel measuring system	-	-	-	-	-	-
Suitable transformers						
Window-type current transformers	■	■	■	■	■	■
Folding transformer	■	■	■	■	■	■
Integrated transformer	-	-	-	-	-	-
Commissioning						
MID/PTB-A50.7 version	- -	■ -	■ ■	- -	- -	- -
Max. input voltage L-L/L-N	400 V/230 V	400 V/230 V	400 V/230 V	400 V/230 V	690 V/400 V	690 V/400 V
Transformer connection version	x/1 A or x/5 A	x/1 A or x/5 A	x/1 A or x/5 A	x/1 A or x/5 A	x/1 A or x/5 A	x/1 A or x/5 A
Direct connection version	-	65 A	65 A	-	-	-
DC power supply unit with extra-low voltage version	-	-	-	-	24 ... 60 V DC ±20%	24 ... 60 V DC ±20%
1-phase counter version	-	■	■	-	-	-
Electrically isolated voltage inputs	-	-	-	-	-	-
Version without display (for web interface)	-	-	-	■	-	-
Evaluation						
Measured quantities						
Average value of measured values	-	■	■	■	■	■
Voltage, current, frequency	■	■	■	■	■	■
Power, power factor	■	■	■	■	■	■
Energy measurement						
Daily energy storage	-	> 221 days	> 10 years	> 221 days	> 221 days	> 221 days
Monthly energy storage	-	> 25 months	> 10 years	> 25 months	> 25 months	> 25 months
Yearly energy storage	-	> 7 years	> 10 years	> 7 years	> 7 years	> 7 years
Apparent Active Reactive energy p.f. power factor	- ■ ■ - ■	■ ■ ■ - ■	■ ■ ■ - ■	■ ■ ■ - ■	■ ■ ■ ■ ■	■ ■ ■ ■ ■
Distortion factor THD (voltage, current)	-	-	-	■	■	■
Harmonics (voltage, current)	-	-	-	-	-	-
Phase angle/phase chart	-	-	-	-	-	-
Load profile recording	-	-	■	-	-	-
Flicker acc. to IEC 61000-4-15	-	-	-	-	-	-
Monitoring functions						
Operating hours counter	-	-	-	■	■	■
Limit monitoring	-	-	-	■	■	■
Logic functions	-	-	-	■	■	■
Event log	-	-	-	-	-	-
Gateway function	-	-	-	-	-	-
Reporting acc. to EN 50160	-	-	-	-	-	-
Integrated fault recorder	-	-	-	-	-	-
Integrated communications interfaces						
Digital inputs/digital outputs	1/1	1/1	1/1	1/1	2/2	2/2
S0 interface	■	■	■	■	■	■
M-Bus	-	■	-	-	-	-
RS485 (Modbus RTU)	■	■	-	-	■	-
Ethernet with Modbus TCP	-	■	■	■	-	■
BACnet	-	-	-	-	-	-
Further information						
	See page 10/26	See page 10/26	See page 10/26	See page 10/26	See page 10/26	See page 10/26

¹⁾ Available with prompt firmware update (see SiePortal)

Industry

Buildings and infrastructure

Circuit breakers



7KM PAC4200 7KM PAC4220 7KM PAC5200 7KT PAC1200 7KT PAC1600 SEM3 3WA 3WL 3WL10/3VA27 3VA ETU8

■ - -	■ - -	■ ■ -	- - -	- - -	- - ■	- - -	- - -	- - -	- - -
- -	- -	- -	- -	- -	- -	■ ■	■ ■	■ ■	- ■
-	-	-	■	■	-	-	-	-	-
■	■	■	■	■	-	■	■	■	■
-	-	-	■	-	■	-	-	-	-
■	■	■	■	■	■	-	-	-	-
■	■	■	■	■	■	-	-	-	-
-	-	-	■	-	■	■	■	■	■
- -	- -	- -	- -	■ -	- -	- -	- -	- -	- -
690 V/400 V x/1 A or x/5 A	690 V/400 V x/1 A oder x/5 A	690 V/400 V x/1 A or x/5 A	400 V/230 V x/5 A	400 V/230 V x/5 A	480 V/277 V 50 ... 1200 A/0.1 A	1000 V/577 V integrated	690 V/400 V integrated	690 V/400 V integrated	690 V/400 V integrated
-	-	-	40/63 A	63/80 A	-	-	-	-	-
22 ... 65 V DC	DC 24 ... 48 V ±25%	-	-	-	-	24 V DC	24 V DC	24 V DC	24 V DC
-	-	-	■	■	■	-	-	-	-
-	-	■	-	-	-	-	-	-	-
-	-	■	■	-	■	-	-	-	-
■	- ¹⁾	-	-	-	-	■	■	-	-
■	■	■	■	■	■	■	■	■	■
■	■	■	■	■	■	■	■	■	■
> 365 days	- ¹⁾	-	-	-	-	-	-	-	-
> 24 months	- ¹⁾	-	-	-	-	-	-	-	-
-	- ¹⁾	-	-	-	-	-	-	-	-
■ ■ ■ ■	■ ■ ■ ■	■ ■ ■ ■	- ■ ■ ■	■ ■ ■ ■	■ ■ ■ ■	■ ■ ■ ■	■ ■ ■ ■	■ ■ ■ ■	■ ■ ■ ■
■	■	■	-	-	■	■	■	■	■
■	■	■	-	-	-	-	-	-	■
2nd to 64th	2. bis 64.	2nd to 40th	-	-	-	2nd to 31st	2nd to 29th	-	-
■	■	■	-	-	-	-	-	-	-
■	- ¹⁾	-	-	-	■	■	■	■	■
-	-	■	-	-	-	-	-	-	-
■	■	-	-	■	-	■	■	-	■
■	- ¹⁾	■	-	■	-	-	■	■	■
■	- ¹⁾	■	-	-	■	-	-	-	-
> 4000 events	- ¹⁾	■	-	-	-	-	■	■	■
■	- ¹⁾	-	-	-	-	-	-	-	-
-	-	■	-	-	-	-	-	-	-
-	-	■	-	-	-	-	-	-	-
2/2	2/2	0/2	-	1/1	2/1	■	■	■	■
■	■	-	-	■	-	■	-	■	■
-	-	-	-	■	-	-	-	-	-
-	-	-	-	■	-	-	■	■	■
■	■	■	■	-	■	■	■	■	■
-	-	-	-	-	■	-	-	-	-

See page 10/26 See page 10/26 See page 10/26 See page 10/31 See page 10/30 See page 10/32 See page 1/4 See page 1/74 See page 1/74 See page 2/6 See page 2/6

Hardware components

Circuit protection devices



**SENTRON Powercenter
1000**

**5ST3 COM auxiliary
switches and fault
signal contacts**

5SV6 COM AFDD/MCB

Communications interfaces

Radio link	■	■	■
Modbus TCP	■	–	–
Bluetooth	■	–	–
Gateway function	■	–	–

Type of mounting

DIN rail	■	■	■
Busbar	–	–	–

Evaluation

Switching state	–	■	■
Temperature	–	■	■
Current	–	–	■
Residual current (in various frequency ranges)	–	–	–
Voltage	–	–	■
Frequency	–	–	■
Apparent, reactive and active power, power factor	–	–	■
Reactive and active energy	–	–	■

Monitoring functions

Operating hours counter	■	■	■
Operating hours counter with load current	–	–	■
Operating cycles counter	–	■	■
Trip counter	–	■	■
Short-circuit trip counter	–	–	■
Alarms for limit monitoring	■	■	■
Detection of overload and short circuit	–	–	■
Detection of arcing faults	–	–	■

Further information

See page 10/20

See page 3/54 and 4/64

See page 4/56

¹⁾ Protection function provided, but tripping is not communicated

Circuit protection devices



5SL6 COM miniature circuit breakers

EM

RCM/EMw

3NA COM fuses

EM	RCM/EMw	3NA COM fuses
■	■	■
-	-	-
-	-	-
■	■	-
-	-	■
■	■	-
■	■	■
■	■	■
-	■	-
■	■	-
■	■	-
■	■	-
■	■	-
■	■	-
■	■	-
■	■	■
■	■	■
■	■	-
■	■	-
■	■	-
■	■	■
■	■	- ¹⁾
-	-	-

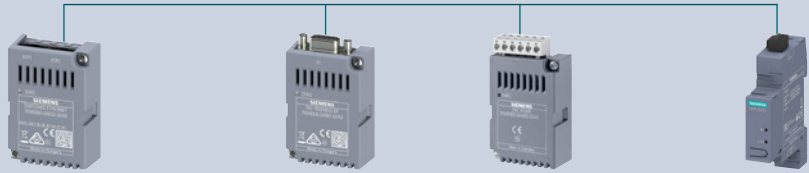
See page 3/40

See page 3/42

See page 7/50

Accessories

Communication modules



**7KM Switched Ethernet
PROFINET/Modbus TCP**

**7KM
PROFIBUS DP**

**7KM RS485
Modbus RTU**

**SETRON PROFINET
Proxy SPP2000**

Industry

	7KM PAC1020	-	-	-	-
	7KM PAC2200	-	-	-	■
	7KM PAC2200CLP	-	-	-	■
	7KM PAC3200T	-	-	-	■
	7KM PAC3120	-	-	-	-
	7KM PAC3220	■	■	■	-
	7KM PAC42x0	- ¹⁾	- ¹⁾	■	-
	7KM PAC5200	-	-	-	-

Buildings and infrastructure

	7KT PAC1200	-	-	-	-
	7KT PAC1600	-	-	-	-
	SEM3	-	-	-	-

Circuit breakers

	3WA/3WL	-	-	-	-
	3WL10/3VA27	-	-	-	-
	3VA ETU5/8	■	■	■	-

¹⁾ Available with prompt firmware update (see SiePortal)

Expansion modules

Current transformers



7KM PAC
4DI/2DO

7KM PAC
I(N), I(Diff), analog

4NC

7KT

3NJ calibrated

7KM PAC 4DI/2DO	7KM PAC I(N), I(Diff), analog	4NC	7KT	3NJ calibrated
-	-	■	■	■
-	-	■	■	■
-	-	-	-	■
-	-	■	■	■
-	-	■	■	■
■	■	■	■	■
- 1)	- 1)	■	■	■
-	-	■	■	■
-	-	-	-	-
-	-	■	■	■
-	-	-	-	-
-	-	-	-	-
-	-	-	-	-
-	-	-	-	-
-	-	-	-	-

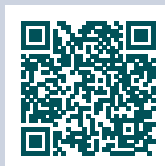
SENTRON Powerconfig

Configuration software for commissioning and maintenance

SENTRON Powerconfig is available free of charge at www.siemens.com/powerconfig

You will find further information on the internet at www.siemens.com/sentron

Free download SENTRON Powerconfig mobile via:

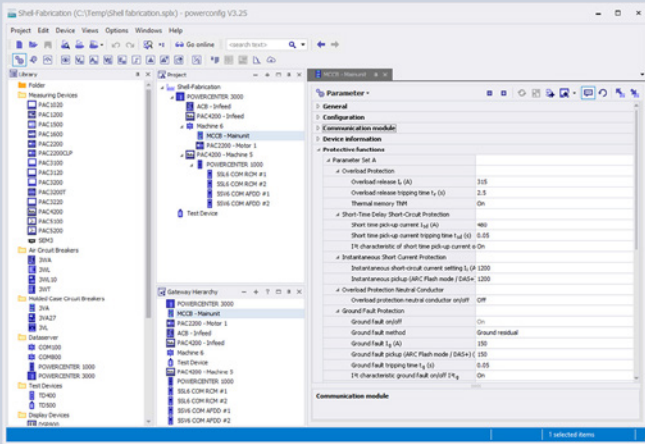


App Store

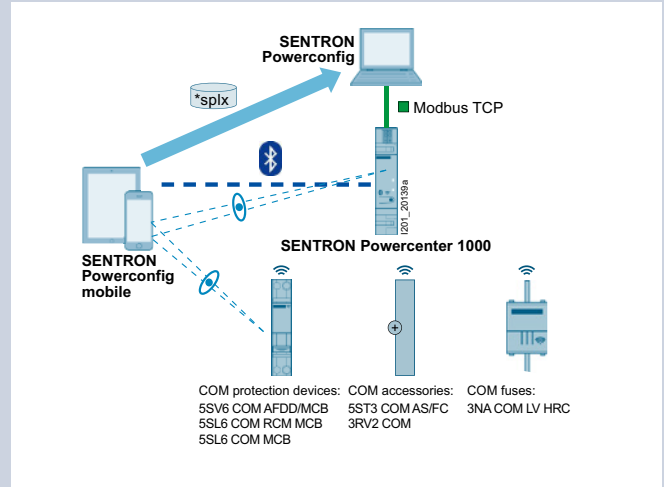


Play Store

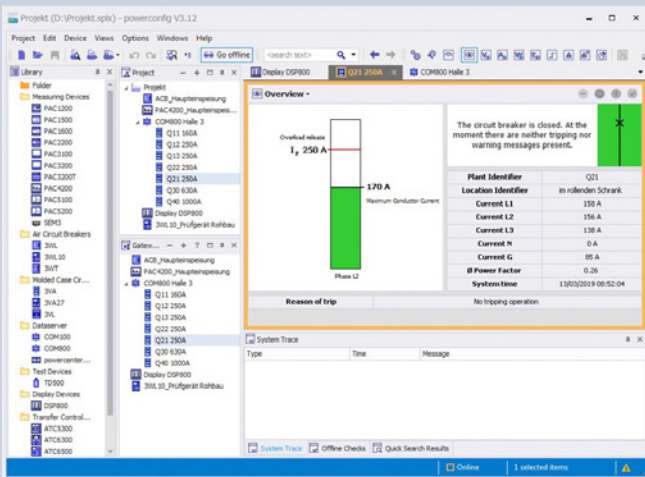
- Software tool for the efficient commissioning and diagnostics of communication-capable SENTRON components
- Supports all electronic SENTRON devices, e.g. 3WA, 3WL, 3VA, SENTRON Powercenter 3000 and SENTRON Powercenter 1000, with 5ST3 AS+FC COM, 5SL6 MCB COM, 5SV6 AFDD COM and 3NA Fuse COM
- General range of functions:
 - User-friendly parameter assignment even for complex devices such as the 3WA
 - Fast, optical detection of communication and measuring-capable circuit protection devices, such as SENTRON Powercenter 1000
 - Saving and printing of device settings
 - Testing the 3WA and archiving the test results
 - Monitoring, saving and printing of instantaneous measured quantities
 - Execution of specific device functions, such as resetting of devices and setting of energy meters
- Service functions:
 - Detection of devices and acquisition of measured quantities and status information via different networks, e.g. via Ethernet
 - Device and status acquisition via local interfaces, such as Bluetooth and USB
 - Acquisition and archiving of historic records, such as load profiles and events
 - Firmware updates
 - Switching of language packs for 7KM PAC measuring devices
- Cooperative interaction between SENTRON Powerconfig mobile and SENTRON Powerconfig on the PC:
 - SENTRON Powerconfig mobile offers a high degree of mobile versatility, e.g. to scan codes on the circuit protection devices
 - SENTRON Powerconfig on the PC can be used for subsequent editing and archiving of the system configuration



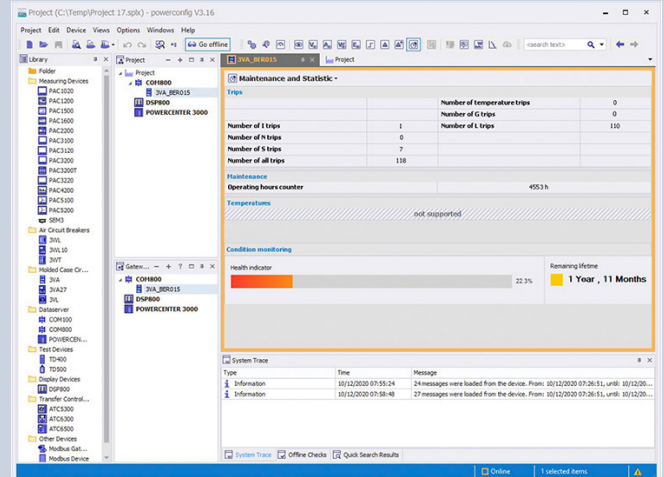
Setting of parameter values



Scanning of circuit protection devices



Display of the circuit breaker status



Display of the state of health of the 3VA

SENTRON Powermanager

PC-based power monitoring software



SENTRON Powermanager

SENTRON Powermanager is based on the modern Desigo CC platform with advanced graphical capabilities and a standard SQL database. The workflows for setting up the system, creating devices, graphically displaying the device data and processing it in reports have been fundamentally revised.

You can find the latest download and change information at www.siemens.com/lowvoltage/product-support (109771760)

Updates and upgrades of version 4.x or higher are based on the SUS/SUR principles.

You will find further information in the brochure – SENTRON Powermanager – update and benefit

www.siemens.com/lowvoltage/product-support (109805178)

If you wish to migrate from classic Powermanager (3.6) to the current version, please get in touch with your local Siemens contact.

The "Trial" license gives customers the opportunity to gain initial experience with SENTRON Powermanager during a 60-day test phase. The application can still be used by purchasing a regular license.

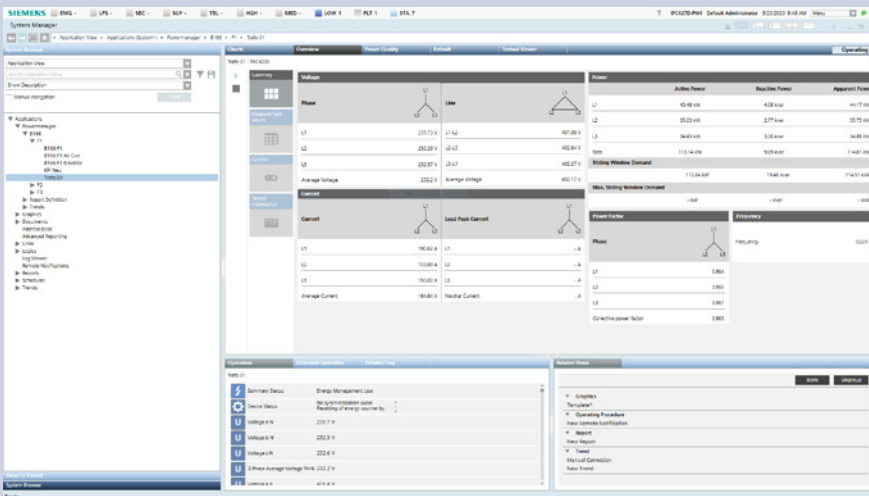
You will find further information on the internet at www.siemens.com/powermanager

You will find training courses on the internet at www.siemens.com/sitrain-lowvoltage

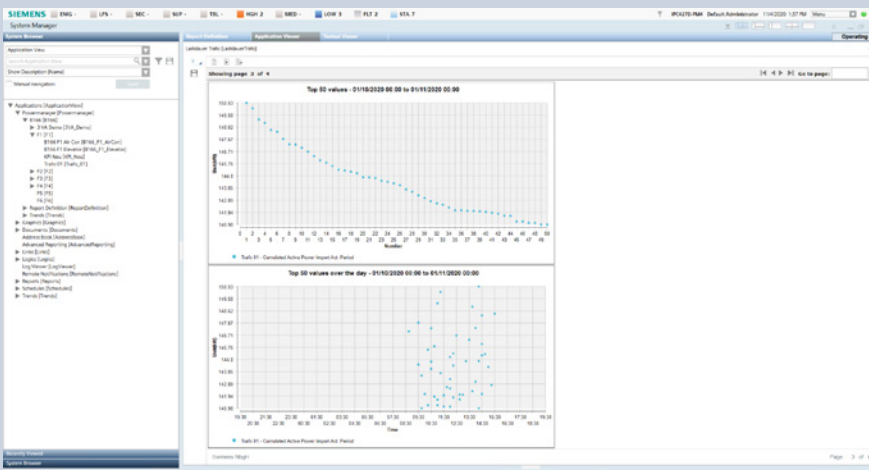
Version	Description	Article No.
SENTRON Powermanager		
Extended Package	Full product license for up to 10 devices, installation for client/server, web access via Windows App Client	7KN2710-2CE40-0YCO
Trial license	Full product license limited to 60 days for up to 10 devices, incl. all functions; software download via SIOS Portal www.siemens.com/lowvoltage/product-support (109771760) A free license for one-time use (trial license limited to 60 days) must also be requested via www.siemens.com/sentron-powermanager-trialversion	
Device expansions		
Device Pack (20)	Device expansion license for up to 20 devices	7KN2711-1CE40-0YCO
Device Pack (50)	Device expansion license for up to 50 devices	7KN2711-2CE40-0YCO
Device Pack (100)	Device expansion license for up to 100 devices	7KN2711-3CE40-0YCO
Device Pack (200)	Device expansion license for up to 200 devices	7KN2711-4CE40-0YCO
Device Pack (500)	Device expansion license for up to 500 devices	7KN2711-5CE40-0YCO
Device Pack (1000)	Device expansion license for up to 1000 devices	7KN2711-6CE40-0YCO
Option packs		
"Graphics Editor 60 Days" option pack	Option for creating any number of freely configured graphics, validity period limited to 60 days	7KN2712-0CE40-0YCO
"Graphics Editor Unlimited" option pack	Option for creating custom-made SENTRON Powermanager applications, e.g. graphics; especially suitable for partners such as Solution Providers, control cabinet builders, etc.	7KN2712-0CE40-0YC1
"Client (2)" option pack	Expansion for up to 2 clients	7KN2712-1CE40-0YCO
"Client (5)" option pack	Expansion for up to 5 clients	7KN2712-2CE40-0YCO
"SENTRON Powermanager OPC UA/DA Client (100)" option pack	100 data points for OPC client configuration	7KN2712-3CE40-0YCO
"SENTRON Powermanager OPC UA Server" option pack	OPC server configuration	7KN2712-3CE40-0YC2
"SENTRON Powermanager Server" option pack	Additionally, SENTRON Powermanager server license for distributed systems without devices, web, etc.	7KN2712-4CE40-0YCO
"SENTRON logics" option pack	Extended logic function	7KN2712-6CE40-0YCO
SENTRON Powermanager SUR-Unit	Update – Extend subscription period by 12 months	7KN2713-7CE40-0YCO
SENTRON Powermanager SUS-Unit	Update – Start new 12-month subscription period	7KN2713-8CE40-0YCO
System packages		
System 1	Package comprising 1× SENTRON Powermanager Extended 1× PAC4200 1× PAC3120 1× RS485 modules	7KN2715-1CE40-0YCO
System 3	Package comprising 1× SENTRON Powermanager Extended 3× PAC3220	7KN2715-3CE40-0YCO
System 4	Package comprising 1× SENTRON Powermanager Extended 1× PAC4200 4× PAC1600 1× RS485 module	7KN2715-4CE40-0YCO
System 5	Package comprising 1× SENTRON Powermanager Extended 5× PAC2200 transformer measurement Modbus TCP	7KN2715-5CE40-0YCO



SENTRON Powermanager – Measuring device diagram



SENTRON Powermanager – Overview of measuring devices

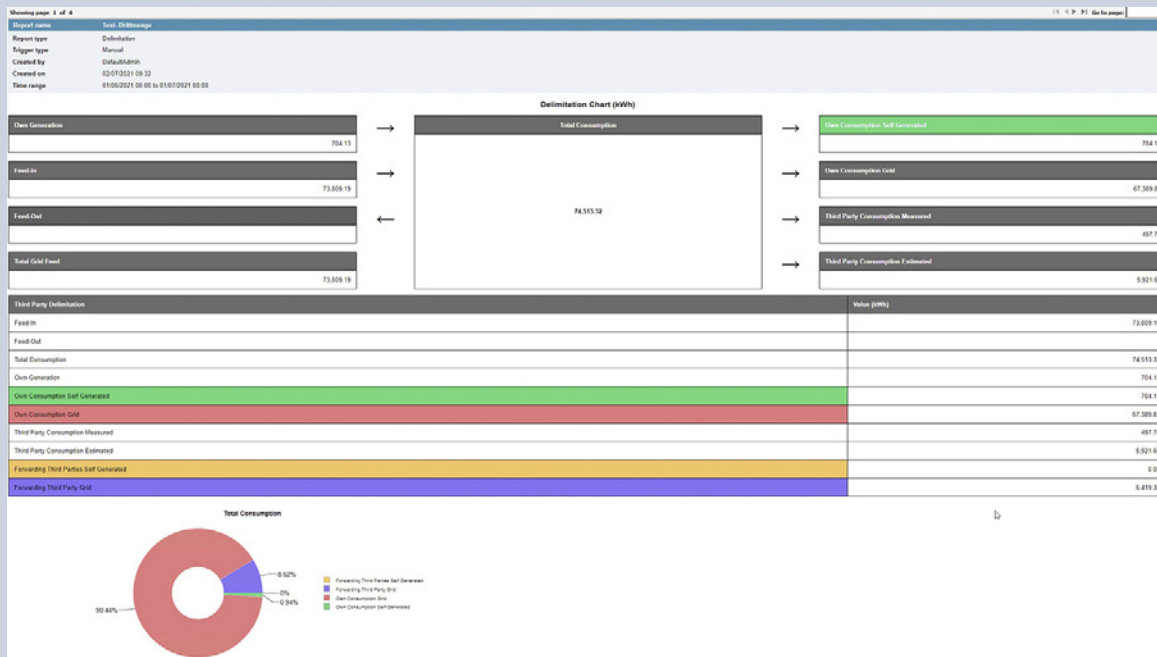


SENTRON Powermanager – Load duration report

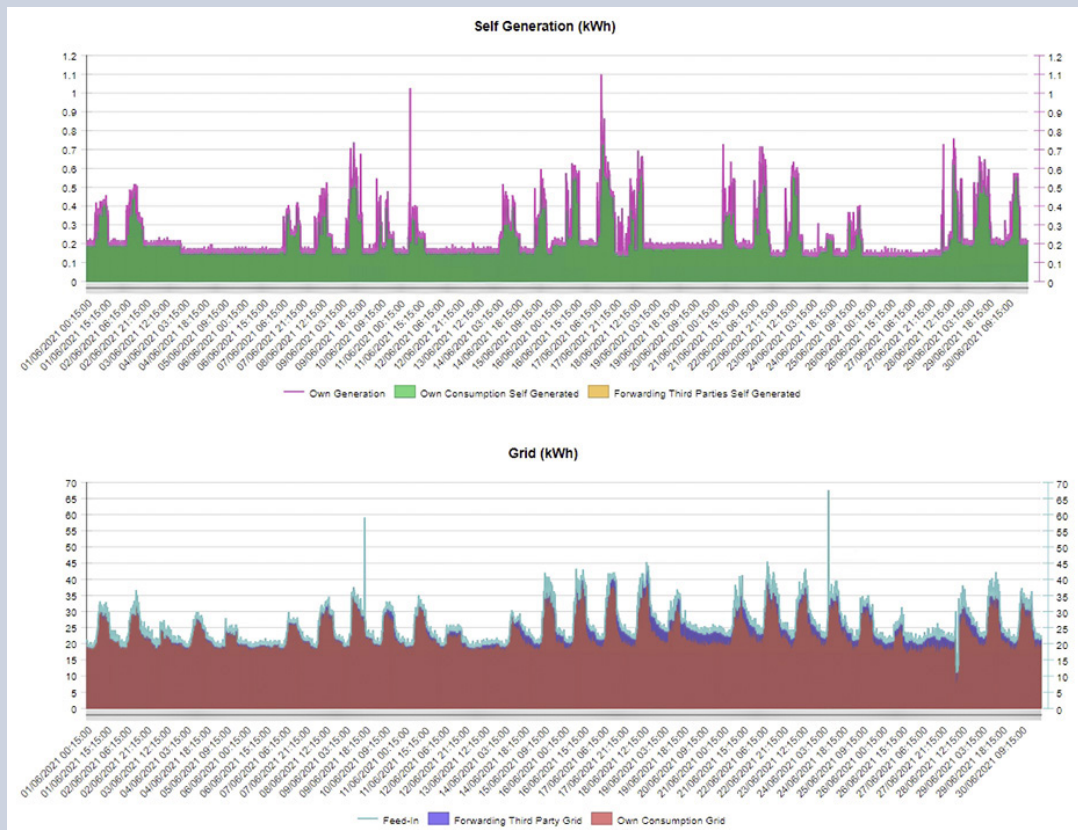
10

SENTRON Powermanager

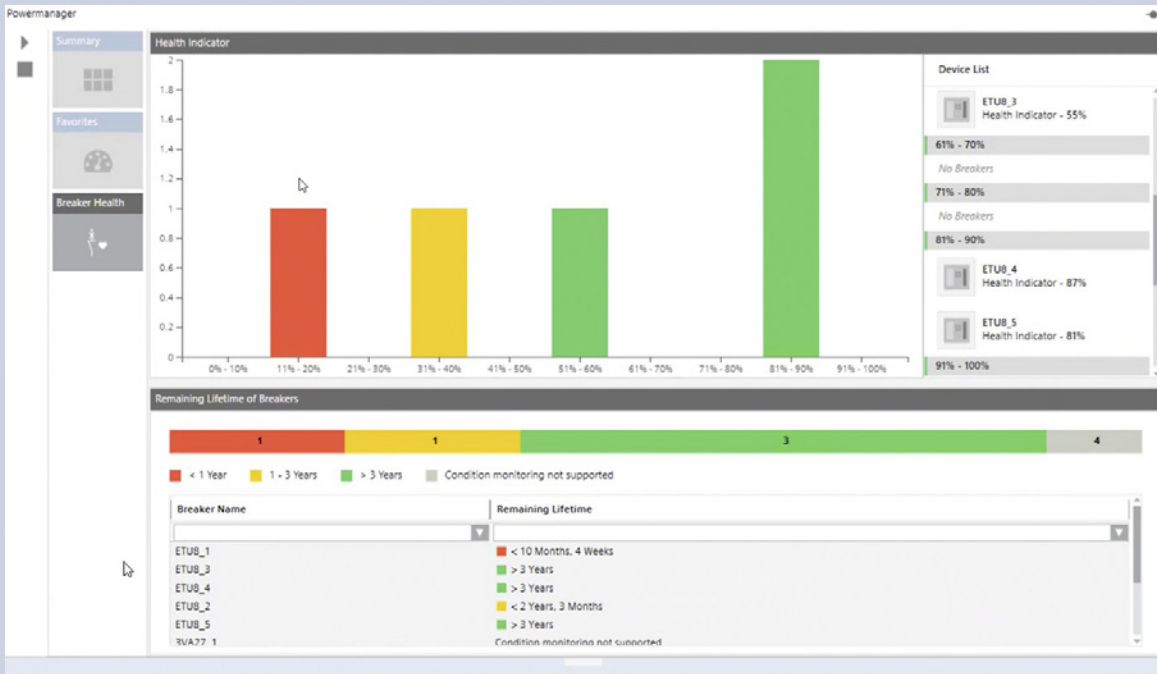
PC-based power monitoring software



10

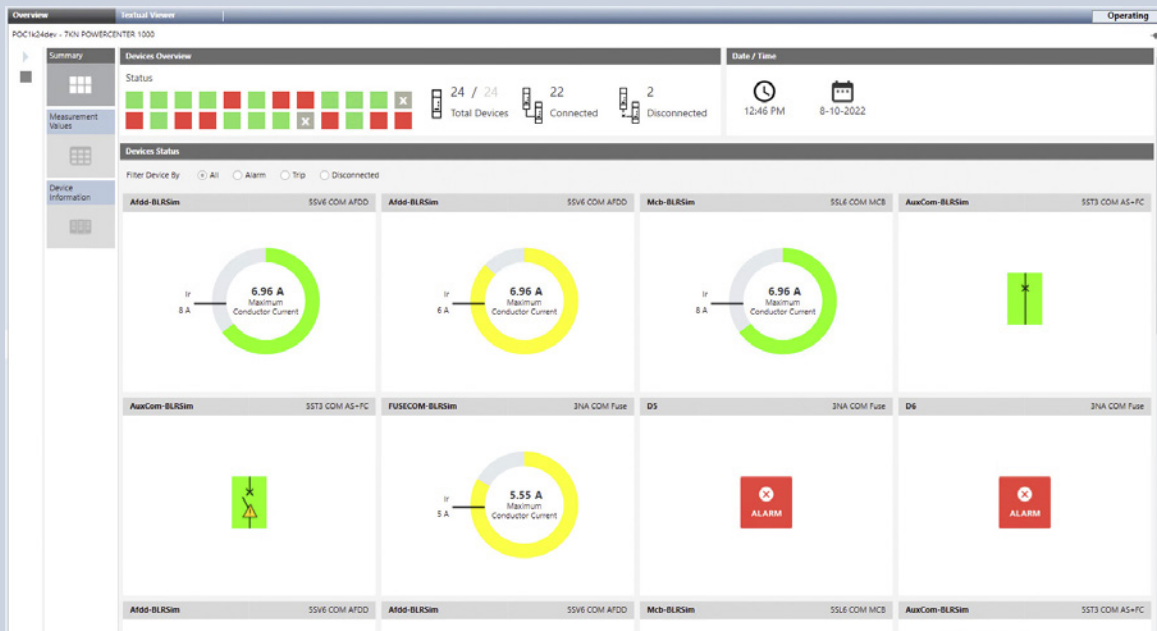


Third-party quantity report



Health Dashboard

10



SENTRON Powercenter 1000 Dashboard

SENTRON Powercenter

Edge/IoT-based data acquisition and visualization for low-voltage power distribution

SENTRON Powercenter 3000

Areas of use and applications

- Basis for certified energy management according to ISO 50001 to improve energy efficiency and optimize maintenance management
- Transparency and fault localization in single and distributed locations
- Future-proof foundation for expanding data analysis from on-site analysis to cloud-based analysis

Features

- Simple and fast commissioning via
 - Reuse of the configuration data from SENTRON Powerconfig or
 - An integrated network scan with automatic device recognition and dashboard selection in accordance with the device type
- Data acquisition, storage and provision
 - All key data of lower-level devices and energy/demand values, breaker status, signals etc.
 - The 15min energy values as a basis for energy reporting as part of ISO 50001 certification
 - Export in form of CSV file (once, periodically, send e.g. by email)
- Visualization/data analysis
 - Analysis of the data in graphical form, e.g. lines, bars, diagrams, and also in tabular form

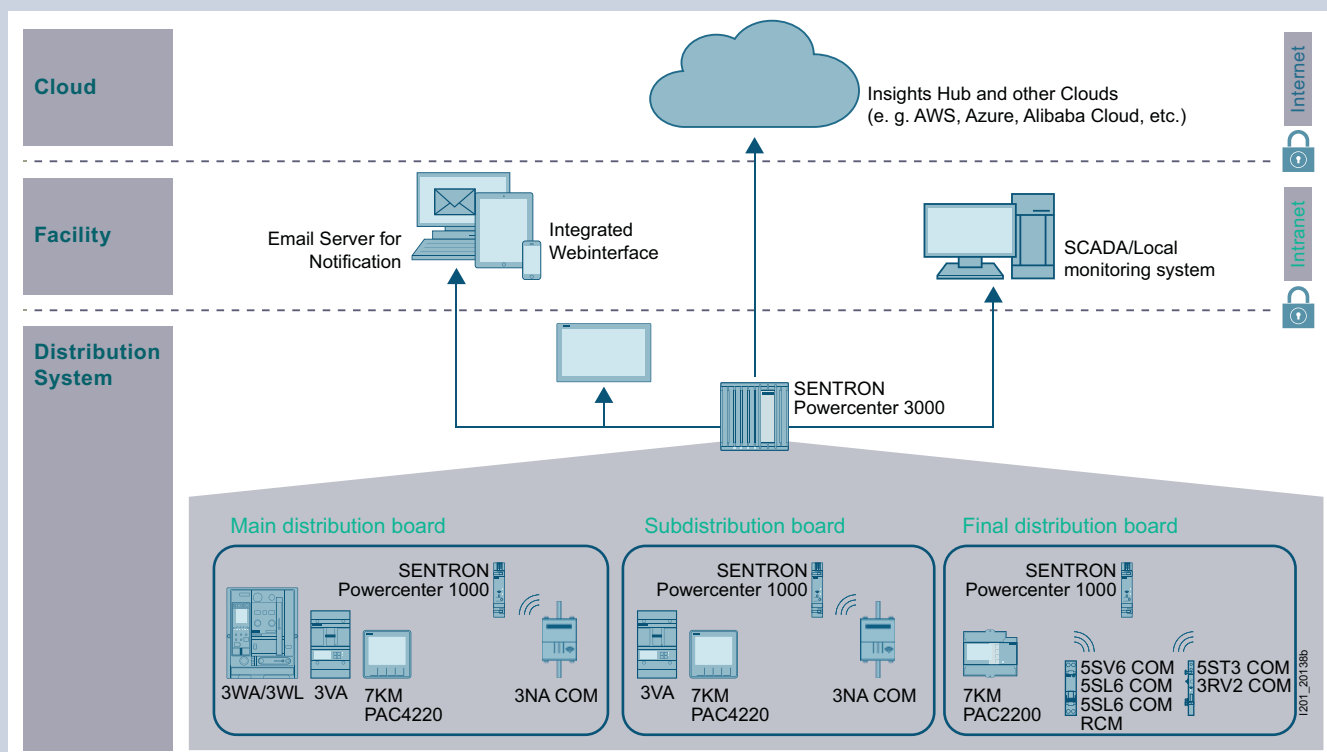
- In the web interface of the SENTRON Powercenter 3000 via the predefined device dashboards and the customer-specific dashboards
- Can also be output as a report
- Interfaces for the digitalization of low-voltage
 - Integrated and easy-to-configure communication with SENTRON Powermind (see separate section)
 - To other cloud applications, e.g. based on AWS, Azure, AliCloud, etc.
 - Via Modbus TCP for other applications, e.g. SENTRON Powermanager
- General:
 - Energy and status data from infeed to the final circuit of up to 32 SENTRON protection, switching, measuring and monitoring devices (expandable to up to 212 devices with license-based extensions – subject to fee)
 - Non-Siemens devices are created via SENTRON Power Device Engineer and treated like any other device
 - Compact design, Web interface in 10 languages
 - Flexible IT security features for protection against unauthorized access

More information:

www.siemens.com/sentron-powercenter3000

10

Mounting	Interfaces	Protocols	Article No.
DIN-rail mounting	2x Ethernet	Modbus TCP, http, Insights Hub	7KN1310-0MC00-0AA8



Areas of use and applications for SENTRON Powercenter 3000

The following examples give an impression of the diverse functions of the SENTRON Powercenter 3000. These are aimed at different customer groups, such as energy managers and maintenance personnel, but also electricians. All information is available via a web browser on a standard PC, but also on mobile devices, such as tablets and smartphones. The information is therefore also available remotely within the company network.

Predefined dashboards

These are automatically selected according to the configuration of the SENTRON Powercenter 3000 and show the most important data of SENTRON protection, switching and measuring devices.



Data visualization based on the example of a measuring device

- Key data points such as active energy or active power are displayed in the form of a curve (time range can be altered by scrolling).
- Further instantaneous values or device information are available in tabular form.



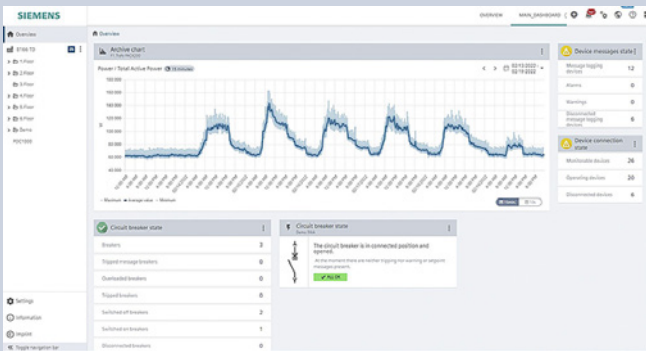
Information on the status of protection and switching devices

- Representation of the device status, e.g. open, closed, tripped and relevant measured quantities, such as maximum phase current, total power ...
- Condition monitoring information is used to assess the state of health and predict the remaining service life

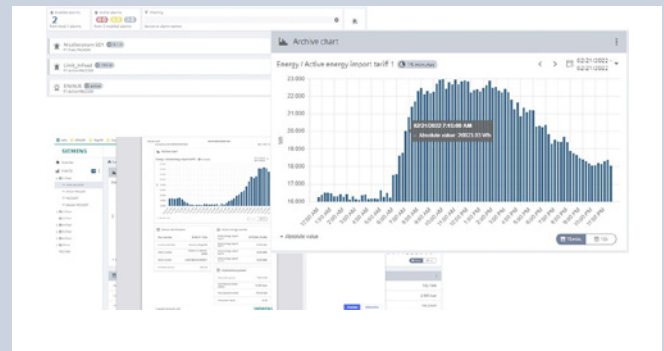
10

Creation of customer-specific dashboards

Users can create their own dashboards (in addition to the standard "Overview" dashboard) by using widgets from the library to compile their own views of the most important information.



Example of a customer-specific dashboard



Several examples of the UI elements

Easy-to-operate user interface

Further UI elements provide additional operating convenience and more in-depth views of the collected data.

- The alarm widget serves as a convenient tool to obtain an overview of the active limit monitoring and any alarms that may be triggered.
 - In the archive graph widget, the 15min energy values (kWh) are displayed as a bar chart
 - The detailed display on "mouse over" shows the individual values in the bar chart with the corresponding date/time stamp
- Dashboards and their contents, e.g. results of data analysis can be printed using the web browser print function

SENTRON Powercenter

Wireless data acquisition and visualization in the final circuit

SENTRON Powercenter 1000

The SENTRON Powercenter 1000 data transceiver is designed to enable comprehensive data acquisition of communication and measuring-capable circuit protection devices. This increases transparency in the final circuit, through which optimization measures can be derived to increase system availability.

Up to 24 devices can communicate wirelessly with SENTRON Powercenter 1000 via radio link. This means that no increased installation effort is required for communication. Selected measured values of the circuit protection devices are stored in the data transceiver for up to 30 days. These can be visualized to ensure extensive data availability.

The compact design of the SENTRON Powercenter 1000, in a single modular width, results in an extremely small footprint in the distribution board so as to enable wireless, comprehensive data acquisition.

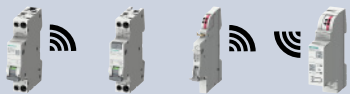
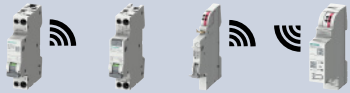




This is complemented by easy mounting on a 35 mm DIN rail and plug-in terminals for a 24 V DC power supply, which can be immediately looped through (daisy chain) to supply other devices.

The integrated Bluetooth interface enables simple on-site communication and commissioning via the SENTRON Powerconfig mobile app. Connection to various configuration or power monitoring systems, such as SENTRON Powerconfig, SENTRON Powermanager or customized solutions, is ensured via the Modbus TCP interface. Furthermore, this interface also enables a connection via e.g. SENTRON Powercenter 3000 or via LOGO! to cloud applications.

Mounting	Power supply	Devices that can be connected	Interfaces	Article No.
DIN-rail mounting	24 V DC SELV	24 circuit protection devices via radio link	2x Ethernet	7KN1110-0MC00

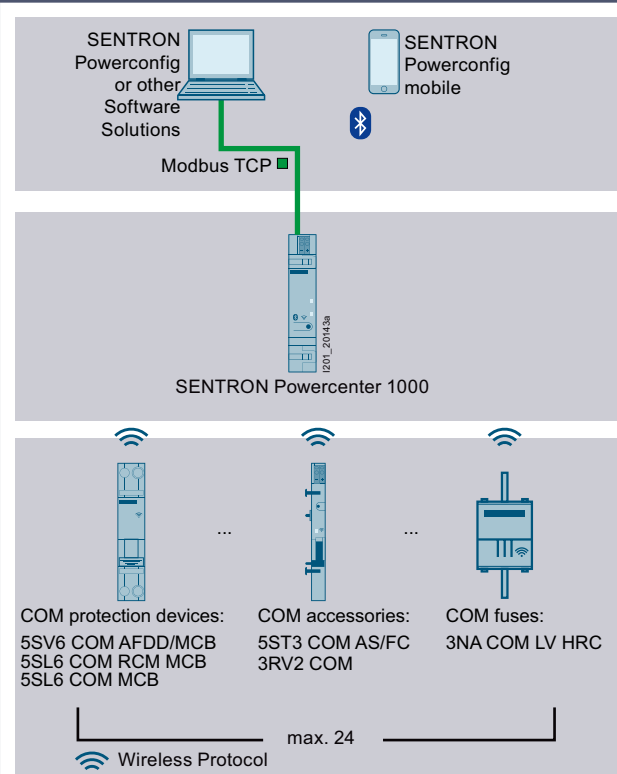
Note:

Please note the country-specific radio licenses of the products at www.siemens.com/lowvoltage/certificates (109801197)

Bundles	Scope of supply	Article No.
Bundle 1 	2x MCB 5SL6 COM B16 1x RCBO 5SV1 B16 1x AS/FC 5ST3 COM 1x SENTRON Powercenter 1000	7KN1110-0XC01
Bundle 2 	2x MCB 5SL6 COM C16 1x RCBO 5SV1 B16 1x AS/FC 5ST3 COM 1x SENTRON Powercenter 1000	7KN1110-0XC02
Bundle 3 	3x 3NA COM LV HRC fuse links 250 A gG 1x SENTRON Powercenter 1000 1x 3NP1 fuse switch disconnectors	7KN1110-0XC03
Bundle 4 	9x 3NA COM LV HRC fuse links 250 A gG 1x SENTRON Powercenter 1000 1x SENTRON Powercenter 3000	7KN1110-0XC04
Bundle 5 	9x 3NA COM LV HRC fuse links 250 A gG 1x SENTRON Powercenter 1000	7KN1110-0XC05
Bundle 6 	1x MCB 5SL6 COM B10 1x MCB 5SL6 COM B13 1x RCBO 5SV1 B13, short-time delayed G 1x AS/FC 5ST3 COM 1x SENTRON Powercenter 1000	7KN1110-0XC06



SENTRON Powercenter 1000 data transceiver



- Acquisition and storage of data and measured values from up to 24 communication-capable circuit protection devices via radio link
- Parameterization, visualization and further processing of the data in higher-level applications via Bluetooth and Modbus TCP



You will find further information under:
www.siemens.com/lowvoltage/manuals

Installation Manual – Circuit protection devices with communication and measuring function (109791805)



System Manual – Circuit protection devices with communication and measuring function (109791806)



SENTRON Powermind

Cloud-based solution for data visualization and analysis in power distribution systems



SENTRON Powermind is aimed equally at energy managers, facility managers and/or operators. For energy managers, predefined, automated representations and analyses of energy data are available, such as:

- Analysis of data in graphical form, e.g. lines, bars, heatmap, Sankey diagram, pie diagram and diagram of top 10 loads (can also be output in the form of a report)
- Comparison of energy consumption on weekdays versus weekends with percentage day-by-day representation of the distribution of energy consumption to identify unnecessary energy consumption
- Comparison of energy consumption and power import during a selected period as compared with a reference period to assess the effectiveness of energy efficiency measures
- Day-by-day representation of the 15 min power demand, incl. min and max values to assess power peaks

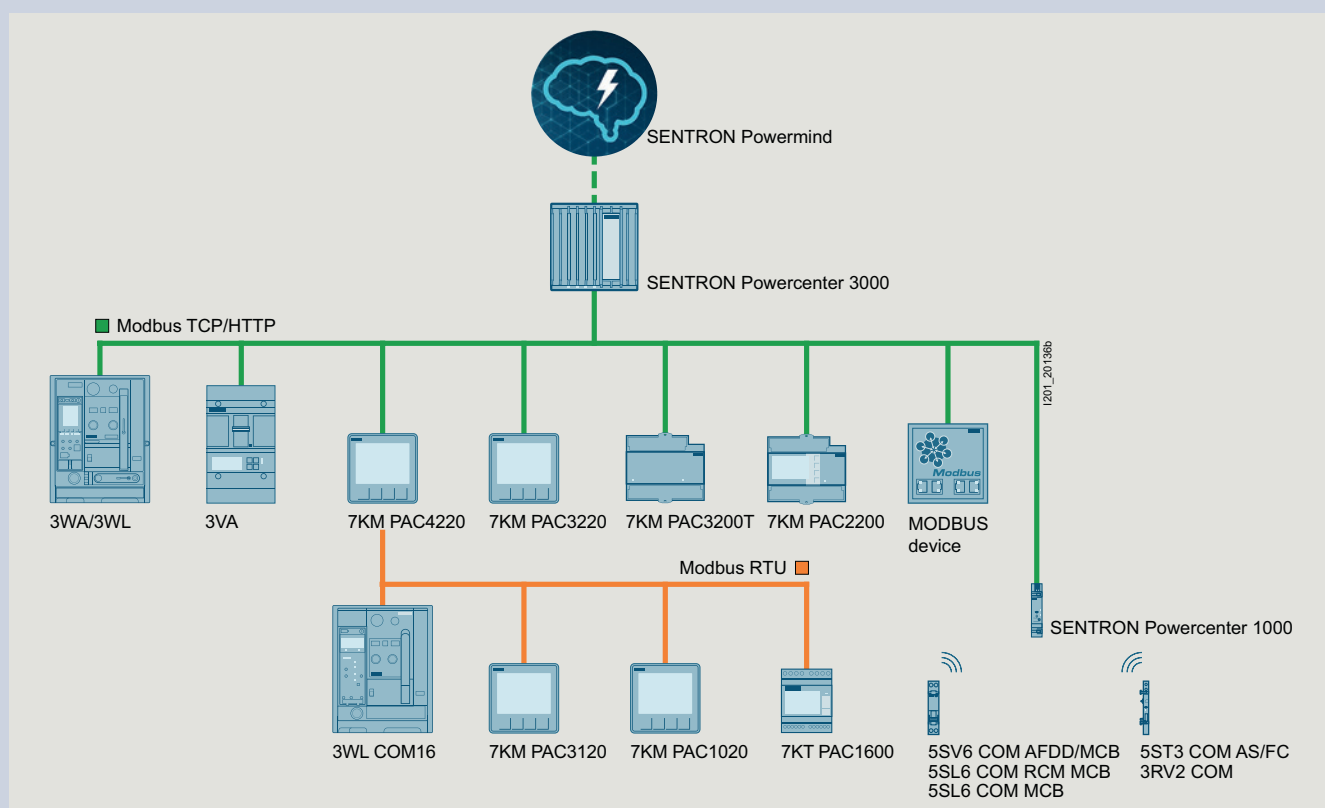
SENTRON Powermind offers operators and facility managers the following information and analyses:

- Status of the switching and protection devices, such as 3VA, 3WA and 3WL
- Display of the maximum current value of an individual phase in relation to I_n
- Condition monitoring information about the condition of the contact system of each circuit breaker and also as an overview of all circuit breakers
- The following devices are supported:
PAC1020, PAC2200/PAC2200CLP, PAC3100/PAC3120, PAC3200/PAC3200T/PAC3220, PAC4200 measuring devices,
3VA, 3WA and 3WL circuit breakers

You will find further information on the Insights Hub Store at

www.dex.siemens.com/industrial-iot/step-4-book-apps-and-extras/sentron-powermind

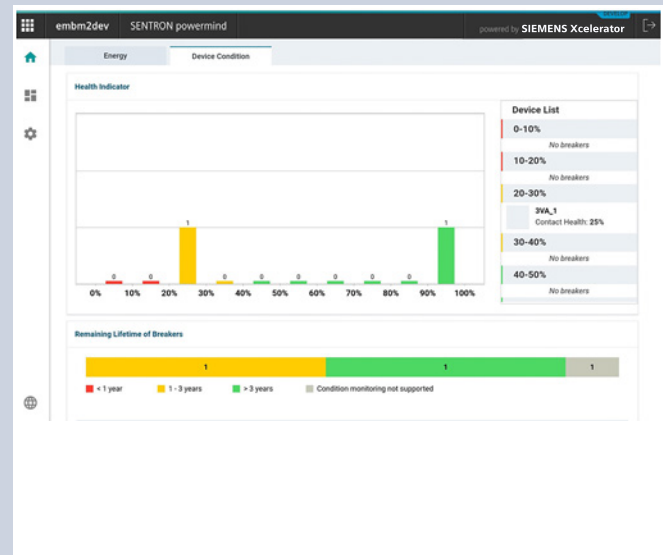
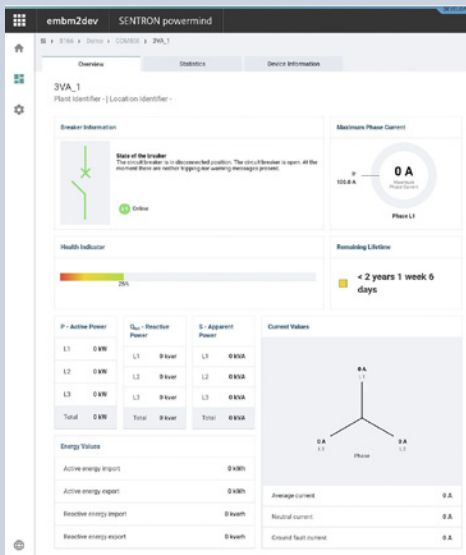
10



A large number of devices transmit data via SENTRON Powercenter 3000 or SENTRON Powermanager to SENTRON Powermind

SENTRON Powermind processes data from SENTRON Powercenter 3000. No complex configuration or parameterization is required, as the necessary information is exchanged using files. This also prevents possible incorrect entries or write errors. An error-free connection can thus be easily established in just a few minutes.

The examples show some of the functions of SENTRON Powermind, which are aimed at different customer groups, such as energy managers and maintenance personnel, but also electricians. All information is available via a web browser on a standard PC, but also on mobile devices, such as tablets and smartphones. The information is therefore available both on-site (locally) and off-site (remotely).



Creating transparency

- Representation of the device status, e.g. open, closed, tripped and relevant measured quantities, such as maximum phase current, total power ...
- Information about the state of health of the device to take action proactively

Overview of the circuit breaker status

- Overview of the state of the health of all circuit breakers in the switchboard
- Assignment to a maintenance cycle (< 1 year; between 1 and 3 years; > 3 years)
- Display of circuit breakers in list form as well as link to the respective circuit breaker dashboard

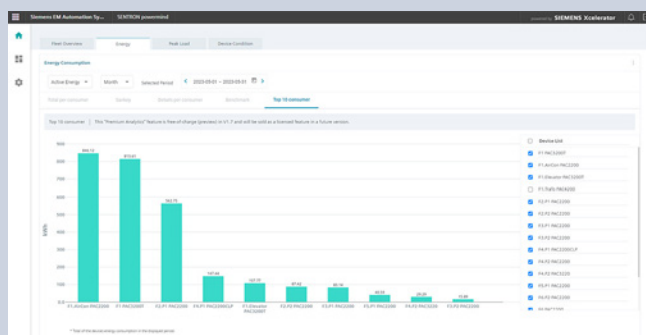
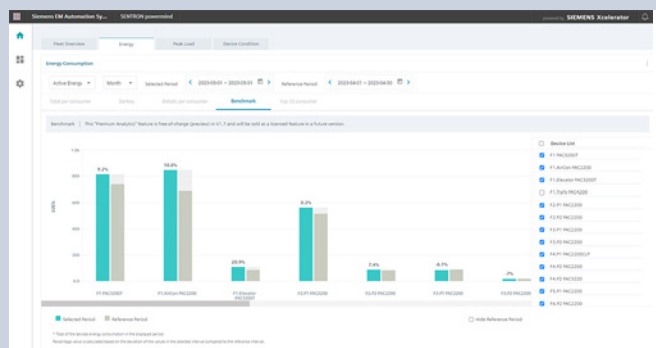
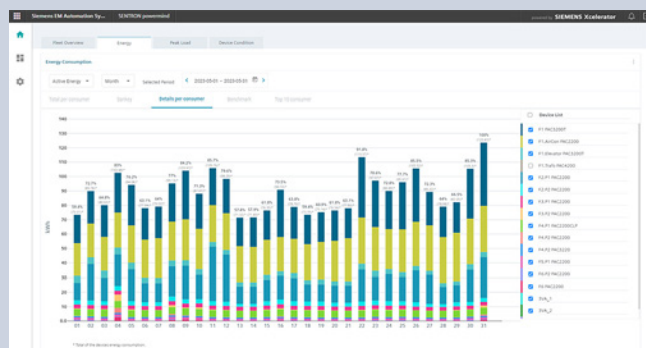
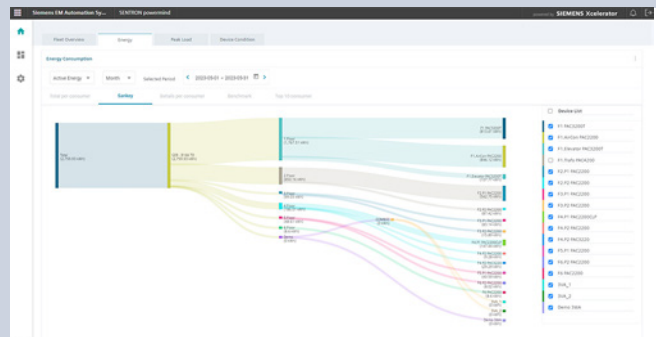
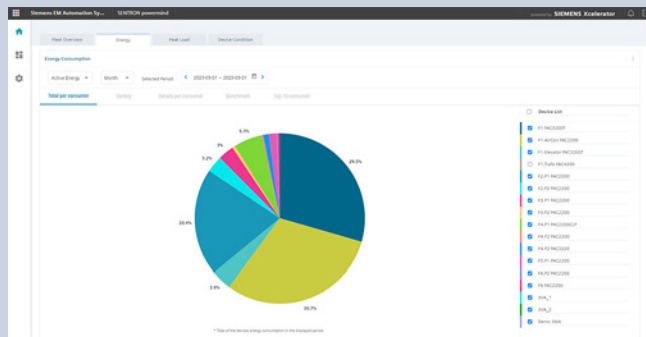


Energy management

- Comparison of the energy consumption of two periods, for example, to assess the effectiveness of energy saving measures
- Representation of the active power as mean and min/max values in a line diagram or heatmap

SENTRON Powermind

Cloud-based solution for data visualization and analysis in power distribution systems



Creating transparency and analyzing energy data

- Representation of the power flow/power import in various parts of the power distribution system
- Analysis of energy consumption in a freely selectable period (Total, Details, Sankey, Top 10) or in comparison to another period (benchmark), including percentage and absolute deviation; applicable to the overall system, system components and individual loads

SIMATIC Modbus/TCP SENTRON PAC

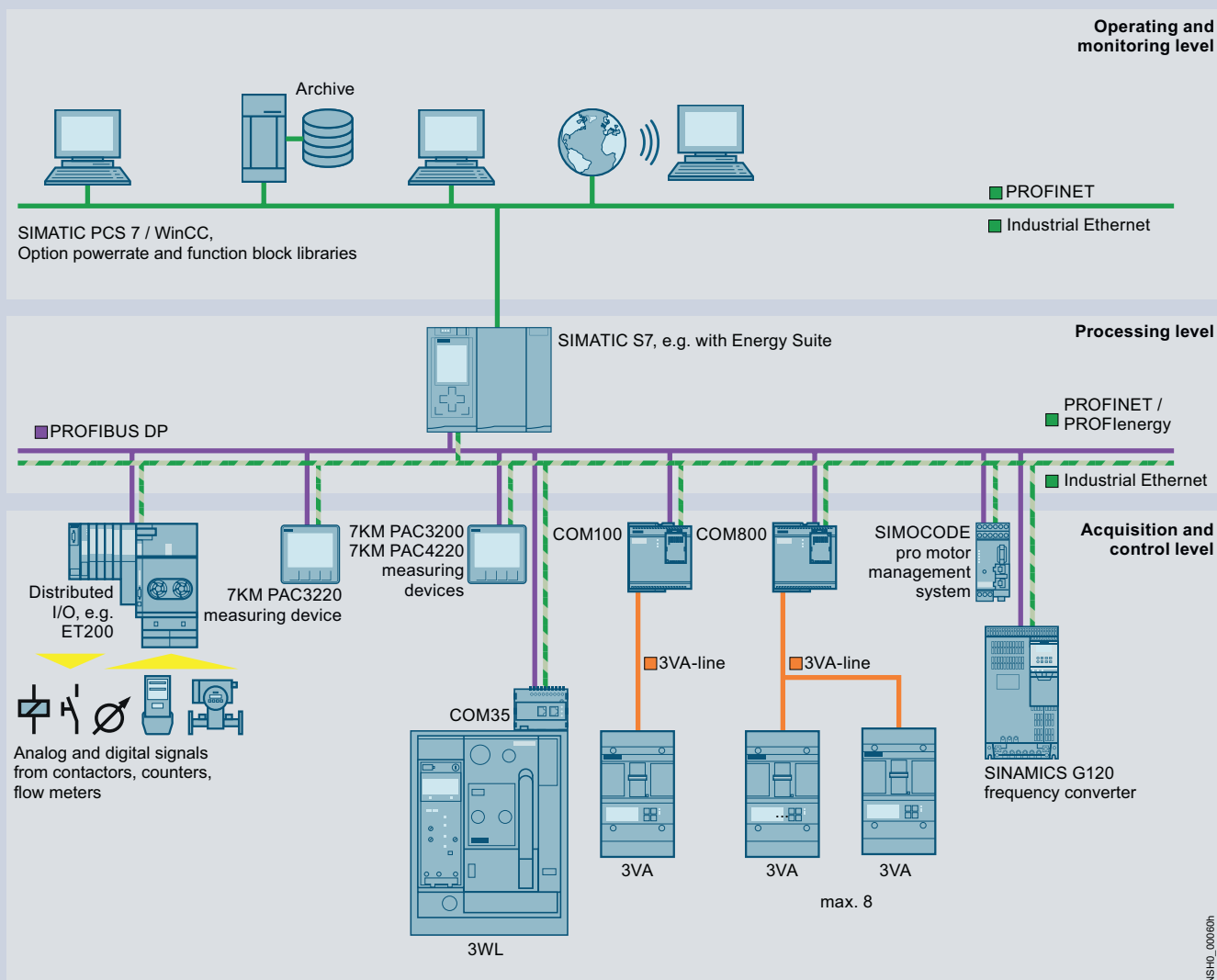
For 7KM PAC3200/4200 measuring devices

Use and version	Valid for	Type	Article No.
Communication via the integrated PN interface for reading values out of PAC3200 and PAC4200 devices, single license	1 CPU and up to 20 SENTRON PACs	Modbus/TCP 20 SENTRON PAC	6AV6676-6MA30-0AX0
	1 CPU and up to 100 SENTRON PACs	Modbus/TCP 100 SENTRON PAC	6AV6676-6MA30-1AX0
	1 CPU and up to 512 SENTRON PACs	Modbus/TCP 512 SENTRON PAC	6AV6676-6MA30-2AX0

PAC/3WL/3VA SIMATIC PCS 7 library

For 7KM PAC3200/3220/4200 measuring devices and 3WL/3VA/3VL circuit breakers

Use	Version	Type of delivery	Article No.
PAC/3WL/3VA SIMATIC PCS 7 library <ul style="list-style-type: none"> AS blocks and faceplates for integrating the 3WL/3VA/3VL circuit breakers into SIMATIC PCS 7, V8.x, V9.0 SP2 or V9.1 For each SIMATIC PCS 7 Operator Station of the single station/server version, a license containing the following is required: <ul style="list-style-type: none"> Engineering license for one SIMATIC PCS 7 Operator Station of the single station/server version Runtime license for one automation system (1 required per automation system, further AS runtime licenses can be ordered separately) 	Engineering and runtime software, software class A, 2-language (English, German), single license for one installation	Software and electronic documentation as a software download, engineering and runtime license as Certificate of License	7KN2780-OCE24-0YAO
AS runtime license for PAC/3WL/3VA library for SIMATIC PCS 7 License for one automation system in each case	Runtime software, software class A, 2-language (English, German), single license for one installation	Runtime license as Certificate of License without software and documentation	7KN2780-OCE00-0YCO



7KM PAC measuring devices

Basic units



Connections	Power supply	Display	Interface	MID	PTB-A50.7	7KM PAC1020	7KM PAC2200/PAC2200CLP	7KM PAC3200T
Transformer measurement								
Screw terminals	Self-powered	With	M-Bus	With	Without	–	7KM2200-2EA30-1GA1	–
				Without	Without	–	7KM2200-2EA30-1CA1	–
				With	Without	–	7KM2200-2EA30-1HA1	–
				Without	Without	–	7KM2200-2EA30-1DA1	–
				Without	Without	–	7KM2200-2EA30-1EA1	–
			Modbus TCP	With	With	–	7KM2200-2EA00-1JB1	–
				Without	Without	–	7KM2200-2EA30-1JA1	–
				Without	Without	–	7KM2200-2EA30-1EA1	–
				Without	Without	–	7KM1020-0BA01-1DA0	–
				Without	Without	–	7KM3200-0CA01-1AA0	–
AC/DC wide-range power supply unit	With	Without	Modbus RTU	Without	Without	–	–	–
			Modbus TCP	Without	Without	–	–	–
DC power supply unit with extra-low voltage	With	Without	Modbus TCP	Without	Without	–	–	–
			Modbus RTU	Without	Without	–	–	–
Ring cable lug connection	AC/DC wide-range power supply unit	With	Modbus TCP	Without	Without	–	–	–
Direct measurement								
Screw terminals	Self-powered	With	M-Bus	With	Without	–	7KM2200-2EA40-1GA1	–
				Without	Without	–	7KM2200-2EA40-1CA1	–
				With	Without	–	7KM2200-2EA40-1HA1	–
				Without	Without	–	7KM2200-2EA40-1DA1	–
				Without	Without	–	7KM2200-2EA40-1EA1	–
			Modbus TCP	With	With	–	7KM2200-2EA40-1JB1	–
				Without	Without	–	7KM2200-2EA40-1JA1	–
				Without	Without	–	7KM2200-2EA40-1EA1	–
				Without	Without	–	7KM2200-2EA40-1EA1	–
				Without	Without	–	7KM2200-2EA40-1EA1	–

Further technical specifications

	7KM1020-..	7KM2200-..	7KM3200-..	7KM3120-0..	7KM3120-1..
Basic data					
Installation	Front mounting	DIN rail		Front mounting	
Mounting width	–	6 MW		–	
Control panel instrument	96 × 96 mm	–		96 × 96 mm	
External auxiliary voltage	50/60 Hz AC	100 ... 250 V	–	90 ... 276 V	100 ... 250 V ±10%
	DC	110 ... 250 V ±10%	–	110 ... 275 V	110 ... 250 V ±10%
					24 ... 60 V ±20%
Measuring inputs					
Transformer connection	Secondary input current I_e	x/1 A or x/5 A	x/1 A or x/5 A	x/1 A or x/5 A	
Direct connection	Input voltage U_e 3 50/60 Hz AC	400/230 V		690/400 V	
	Rated current I_n	–	65 A	–	–

7KM PAC measuring devices

Accessories

7KM PAC1020
7KM PAC3100
7KM PAC3120
7KM PAC3200
7KM PAC3220
7KM PAC4200
7KM PAC4220

7KM PAC TMP2 DIN-rail adapter



- Two-tier adapter for mounting a measuring device on a DIN rail
- Front display
- For manual intervention

7KM9900-0XA00-0AA0

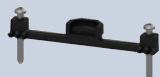
7KM PAC TMP mounting plate



- Adapter for mounting a measuring device on DIN rail
- Display faces backwards towards DIN rail
- Readout and evaluation of measurements solely via mains operation

7KM9900-0YA00-0AA0

Compact holder



- Device holder for 7KM PAC1020/3100/3120/3200/3220/4200
- 10 holders for 5 PAC devices
- For seamless side-by-side mounting of the devices (without spaces)

7KM9900-0GA00-0AA0

7KM PAC3100
7KM PAC3200
7KM PAC4200

7KM PAC3120
7KM PAC3220
7KM PAC4220

Spare parts for 7KM PAC



- Spare parts comprising:
 - Device holders for panel mounting (2X)
Note: can also be used for 7KM PAC3120/3220
 - Screw terminal for connection of voltage inputs
 - Screw terminal for connection of current inputs
 - Terminal block inputs/outputs for 7KM PAC3100/4200
 - Terminal block inputs/outputs for 7KM PAC3200
 - RS485 terminal blocks for 7KM PAC3100

7KM9900-0SA00-0AA0

–

- Spare part package comprising:
 - Device holders for panel mounting

– 7KM9900-0SA00-0AA0

7KM PAC2200
7KM PAC2200CLP
7KM PAC2200 MID
7KM PAC3200T






SENTRON PROFINET Proxy SPP2000



- Proxy for transition from Modbus TCP-capable measuring devices to PROFINET IO. Connection of up to 8 devices from the PAC2200, PAC2200CLP, PAC2200 MID and PAC3200T product ranges
- PROFINET Conformance Class C
- Two switched ports
- Integration in TIA by means of GSDML file

7KM9300-0PP20-0AA0

Expansion and communication modules

	7KM PAC3220 7KM PAC4200 7KM PAC4220	COM100/800 (3VA)
7KM Switched Ethernet PROFINET communication module  <ul style="list-style-type: none"> • Latest PROFINET switching properties • S2 system redundancy for operation in H systems • CiR Configuration in Run • Firmware update via the modules for PAC4200 and PAC3220 		
		7KM9300-0AE02-0AA0
7KM PROFIBUS DP communication module 		7KM9300-0AB01-0AA0
7KM RS485 communication module 		7KM9300-0AM00-0AA0 ¹⁾
7KM PAC 4DI/2DO expansion module 		7KM9200-0AB00-0AA0 –
7KM PAC I(N), I(Diff), analog expansion module  <ul style="list-style-type: none"> • To add the following functions to the measuring inputs: <ul style="list-style-type: none"> – N conductor measurement – Two analog inputs, also for measuring non-electrical quantities such as temperature, water or air pressure – Residual current measurement via type A or type B summation current transformers 		7KM9200-0AD00-0AA0 –

¹⁾ Suitable for 7KM PAC4200/4220 (especially for the Modbus TCP/RTU Gateway)

Residual-current transformers for 7KM PAC I(N), I(Diff), analog expansion module, [from page 11/1 onwards](#)

7KT PAC measuring devices

PAC1600 basic unit



Connections	Version	Power supply	Display	Interface	MID	7KT PAC1600	
Transformer measurement							
Screw terminals	3-phase	Self-powered	With	Modbus RTU	Without	7KT1661	
					With	7KT1662	
				M-Bus	Without	7KT1663	
					With	7KT1664	
				SO interface	Without	7KT1672	
	With	7KT1673					
	3-phase, universal	Auxiliary power: 100 ... 240 V AC, 110 ... 250 V DC 50/60Hz	With	–	Without	7KT1681	
				Modbus RTU	Without	7KT1682	
	Direct measurement						
	Screw terminals	1-phase	Self-powered	With	Modbus RTU	Without	7KT1651
With						7KT1652	
M-Bus					Without	7KT1653	
					With	7KT1654	
SO interface					Without	7KT1655	
					With	7KT1656	
3-phase		Self-powered	With	Modbus RTU	Without	7KT1665	
					With	7KT1666	
				M-Bus	Without	7KT1667	
					With	7KT1668	
				SO interface	Without	7KT1670	
					With	7KT1671	

PAC1200 multichannel current measuring system

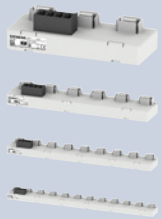


Connections	Version	Power supply	Display	Interface	MID	7KT PAC1200
Direct measurement						
Screw terminals	3-phase	Self-powered	Without	Modbus TCP	Without	7KT1260

PAC1200

7KT PAC1200

Data manager with 7KT1260, sensor bars



Number of connections	Article No.
3	7KT1233
6	7KT1236
9	7KT1238
12	7KT1242

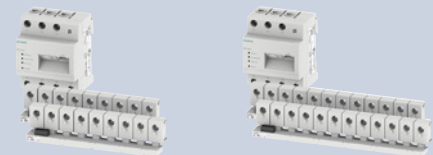
Data manager with 7KT1260, sensors



Current I_e	Article No.
40 A	7KT1254
63 A	7KT1255

10

PAC1200 Bundles



Data manager	Sensor bars	Sensors	18 bundle	24 bundle
1× data manager 7KT1260	2× 9-sensor bar 7KT1238	18× sensors 40 A 7KT1254	7KT1222	–
	2× 12-sensor bar 7KT1242	24× sensors 40 A 7KT1254	–	7KT1223

SEM3 multichannel current measuring system

Data manager



Connections	Version	Power supply	Display	Interface	MID	
Transformer measurement						
Screw terminals	3-phase	Self-powered	Without	Modbus TCP RS485 Modbus RTU	Without	US2:SEM3CONTROLLER

Further technical specifications

SEM3

Basic data	
Installation	Screw mounting
Measuring inputs	
Max. input voltage 50/60 Hz AC	480 V/277 V
Standard current transformers	50 ... 1200 A/0.1 A
Folding transformer	50 ... 2000 A/0.1 A

Accessories

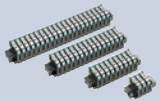
Metering modules



- For recording measured values
- Accuracy of 0.2% or 1% for the entire measurement including current transformer
- Simple setting of phase configuration by means of slide switch
- Connection of a current transformer for measuring a phase
- Metering module is plugged into meter rack

Measuring accuracy	Article No.
0.2%	US2:SEM3PHAMETER
1%	US2:SEM3PLAMETER

Meter racks



Version	Article No.
For 3 metering modules	US2:SEM3RACK3
For 9 metering modules	US2:SEM3RACK9
For 15 metering modules	US2:SEM3RACK15
For 21 metering modules	US2:SEM3RACK21

Connecting cables



Length	Article No.
0.3 m	US2:SEM3CAB12INCH
0.6 m	US2:SEM3CAB24INCH
0.9 m	US2:SEM3CAB36INCH

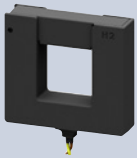
Standard current transformers



- Standard power cable brown and yellow, 1.82 m long
- Can be extended up to 100 m while still maintaining accuracy
- Transformer configuration is carried out in the data manager

Output signal	Transformer transmission ratio	Article No.
100 mA	50: 0.1	US2:SEM3SCCT50
	125: 0.1	US2:SEM3SCCT125
	250: 0.1	US2:SEM3SCCT250
	400: 0.1	US2:SEM3SCCT400
	600: 0.1	US2:SEM3SCCT600
	800: 0.1	US2:SEM3SCCT800
	1200: 0.1	US2:SEM3SCCT1200

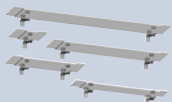
Folding transformers



- Standard power cable brown and yellow, 1.82 m long
- Can be extended up to 100 m while still maintaining accuracy
- Transformer configuration is carried out in the data manager

Output signal	Transformer transmission ratio	Article No.
100 mA	50: 0.1	7KT1280-5MA00
	125: 0.1	7KT1280-5MA01
	250: 0.1	7KT1280-5MA02
	400: 0.1	7KT1280-5MA03
	600: 0.1	7KT1280-5MA04
	800: 0.1	7KT1280-5MA05
	1200: 0.1	7KT1280-5MA06
	1600: 0.1	7KT1280-5MA07
	2000: 0.1	7KT1280-5MA08

DIN-rail adapters



- 5 adapters for snapping onto DIN rail
- 1 adapter each for data manager and for meter racks with 3, 9, 15 and 21 metering modules
- Adapters are screwed onto the data manager or the meter racks

Article No.
US2:SEM3DINKIT

SEM3T multichannel temperature measuring system

Data manager for thermal monitoring in electrical systems



Connections	Version	Power supply	Display	Interface	
Plug-in connectors	Temperature measurement	24 V DC	Without	Modbus TCP	7KT1281-0AA00
				Modbus TCP/Wi-Fi	7KT1281-0AA10

Further technical specifications

SEM3T

Basic data	
Installation	DIN-rail mounting
Measuring inputs	
Temperature sensors	0 to 130 °C

Accessories

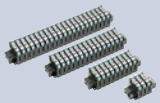
Metering module



- For recording measured values
- No configuration necessary for modules
- Connection of a temperature sensor
- Metering module is plugged into meter rack

Article No.
7KT1281-1AA00

Meter racks



Version	Article No.
For 3 metering modules	US2:SEM3RACK3
For 9 metering modules	US2:SEM3RACK9
For 15 metering modules	US2:SEM3RACK15
For 21 metering modules	US2:SEM3RACK21

Connecting cables



• 600 V insulated special cable for connecting meter racks to the data manager	
Length	Article No.
0.3 m	US2:SEM3CAB12INCH
0.6 m	US2:SEM3CAB24INCH
0.9 m	US2:SEM3CAB36INCH

Temperature sensors

- Standard connection cable, brown and yellow, 3 m long
- Can be extended up to 15 m while still maintaining accuracy
- Configuration is carried out in the data manager



Version	Size	Article No.
Sensors with ring cable lugs	Sensor 1/4"	7KT1281-2SA00
	Sensor 5/16"	7KT1281-2SA01
	Sensor 3/8"	7KT1281-2SA02
	Sensor 1/2"	7KT1281-2SA03
Cylindrical sensor		7KT1281-2CA00

Time and pulse counters

Mechanical counting mechanisms



Display	Resetting	Rated frequency	Rated control supply voltage U_c	48 × 48 mm	72 × 72 mm	–
Time counter						
00000.00 h	Without	–	10 ... 80 V DC	7KT5500	–	–
			10 ... 50 V DC	–	7KT5600	–
			12 ... 24 V DC	–	–	7KT5801
		50 Hz	24 V AC	7KT5505	–	7KT5802
			115 V AC	7KT5501	7KT5601	7KT5803
			230 V AC	7KT5502	7KT5602	7KT5804
		60 Hz	115 V AC	7KT5503	7KT5603	7KT5806
			230 V AC	7KT5504	7KT5604	7KT5807
Pulse counter						
0000000	Without	–	12 ... 24 V DC	–	–	7KT5811
		50/60 Hz	24 V AC	–	–	7KT5812
			230 V AC	–	–	7KT5814

Further technical specifications

	7KT55..	7KT56..	7KT58..
Basic data			
Installation	Front mounting		DIN-rail mounting
Mounting width	–		2 MW
Front frame	48 × 48 mm	72 × 72 mm	–
Display	Drum-type register		
Version	–	With narrow frame according to DIN 43700	–

Accessories

	7KT55..	7KT56..	7KT58..
Cover			
Size	Article No.	Article No.	Article No.
55 × 55 mm	7KT9020	–	–
Sealing ring for cover			
Degree of protection	Scope of supply	Article No.	Article No.
IP43 (in control panels with smooth surfaces)	1 set = 5 units	7KT9000	–
Terminal cover			
Degree of protection	Article No.	Article No.	Article No.
IP20 (with connected conductors)	–	7KT9021	–

Electronic counting mechanisms



Display	Resetting	Rated frequency	Rated control supply voltage U_c	
Time counter				
000000.0 h	Without	50/60 Hz	24 ... 240 V AC, 12 ... 150 V DC	7KT5821
	Electrical	50/60 Hz	24 ... 240 V AC, 12 ... 150 V DC	7KT5822
	Electrical and mechanical	50/60 Hz	24 ... 240 V AC, 12 ... 150 V DC	7KT5823
Pulse counter				
0000000	Electrical and mechanical	50/60 Hz	24 ... 240 V AC, 12 ... 150 V DC	7KT5833

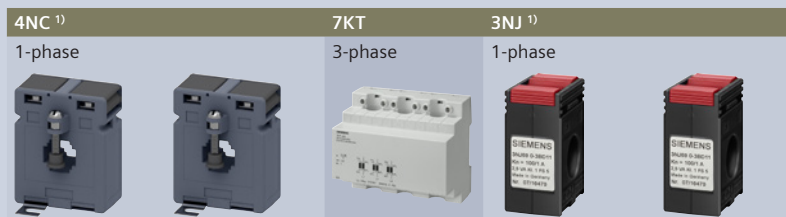
Further technical specifications

7KT58..

Basic data	
Installation	DIN-rail mounting
Mounting width	2 MW
Display	LCD display

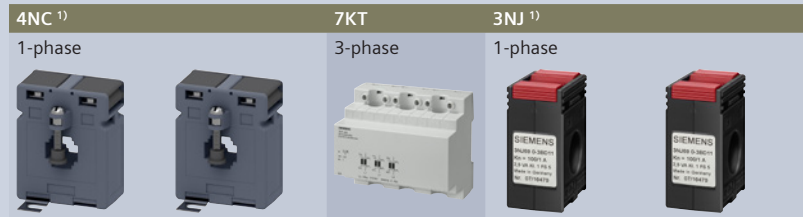
Current transformers

Bushing-type current transformers for measurement purposes



Size	Insulation level U_m	Rated primary current I_{pr}	Rated power P_n	Secondary rated current I_{sr}				
				$I_{sr} = 5\text{ A}$	$I_{sr} = 1\text{ A}$	$I_{sr} = 5\text{ A}$	$I_{sr} = 5\text{ A}$	$I_{sr} = 1\text{ A}$
Accuracy class 0.2s								
1	720 V	150 A	1 VA	4NC5121-2FA21	–	–	–	–
		200 A	2.5 VA	4NC5122-2FC21	–	–	–	–
		250 A	2.5 VA	4NC5123-2FC21	–	–	–	–
		300 A	5 VA	4NC5124-2FE21	–	–	–	–
		400 A	5 VA	4NC5125-2FE21	–	–	–	–
5	720 V	500 A	5 VA	4NC5126-2FE21	–	–	–	–
		600 A	5 VA	4NC5227-2FE21	–	–	–	–
		700 A	5 VA	4NC5228-2FE21	–	–	–	–
		800 A	5 VA	4NC5231-2FE21	–	–	–	–
		1000 A	5 VA	4NC5232-2FE21	–	–	–	–
Accuracy class 0.5								
1	720 V	100 A	1 VA	4NC5117-2DA21	4NC5117-0DA21	–	–	–
		150 A	2.5 VA	4NC5121-2DC21	4NC5121-0DC21	–	–	–
		200 A	5 VA	4NC5122-2DE21	4NC5122-0DE21	–	–	–
		250 A	5 VA	4NC5123-2DE21	4NC5123-0DE21	–	–	–
2	720 V	200 A	5 VA	4NC5222-2DE21	4NC5222-0DE21	–	–	–
		250 A	5 VA	4NC5223-2DE21	4NC5223-0DE21	–	–	–
		300 A	5 VA	4NC5224-2DE21	4NC5224-0DE21	–	–	–
		400 A	5 VA	4NC5225-2DE21	4NC5225-0DE21	–	–	–
3	720 V	400 A	5 VA	4NC5325-2DE21	4NC5325-0DE21	–	–	–
		500 A	5 VA	4NC5326-2DE21	4NC5326-0DE21	–	–	–
		600 A	5 VA	4NC5327-2DE21	4NC5327-0DE21	–	–	–
		750 A	5 VA	4NC5330-2DE21	4NC5330-0DE21	–	–	–
4	720 V	800 A	5 VA	4NC5331-2DE21	–	–	–	–
		800 A	10 VA	4NC5431-2DH21	4NC5431-0DH21	–	–	–
		1000 A	10 VA	4NC5432-2DH21	4NC5432-0DH21	–	–	–
		1200 A	10 VA	4NC5433-2DH21	4NC5433-0DH21	–	–	–
		1500 A	10 VA	4NC5435-2DH21	4NC5435-0DH21	–	–	–
		1600 A	15 VA	4NC5436-2DK21	–	–	–	–
		2000 A	20 VA	4NC5438-2DL21	–	–	–	–
		2500 A	25 VA	4NC5440-2DM21	–	–	–	–
		3000 A	30 VA	4NC5441-2DN21	–	–	–	–
Accuracy class 0.5 calibrated								
–	720 V	100 A	1.5 VA	–	–	–	3NJ6920-3BD23	3NJ6920-3BD13
		150 A	2.5 VA	–	–	–	3NJ6920-3BE23	3NJ6920-3BE13
		300 A	5 VA	–	–	–	3NJ6940-3BH23	3NJ6940-3BH13
		400 A	5 VA	–	–	–	3NJ6940-3BJ23	3NJ6940-3BJ13
		500 A	5 VA	–	–	–	3NJ6940-3BK23	3NJ6940-3BK13
		600 A	5 VA	–	–	–	3NJ6940-3BL23	3NJ6940-3BL13

¹⁾ Overcurrent limiting factor FS5



Size	Insulation level U_m	Rated primary current I_{pr}	Rated power P_n	Secondary rated current I_{sr}				
				$I_{sr} = 5\text{ A}$	$I_{sr} = 1\text{ A}$	$I_{sr} = 5\text{ A}$	$I_{sr} = 5\text{ A}$	$I_{sr} = 1\text{ A}$
Accuracy class 1.0								
1	720 V	50 A	1.2 VA	4NC5112-2CB21	4NC5112-0CB21	–	–	–
		60 A	1.2 VA	4NC5113-2CB21	4NC5113-0CB21	–	–	–
			1.25 VA	–	–	7KT1200	–	–
		75 A	2.5 VA	4NC5115-2CC21	4NC5115-0CC21	–	–	–
		100 A	2.5 VA	4NC5117-2CC21	4NC5117-0CC21	7KT1201	–	–
		150 A	2.5 VA	4NC5121-2CC21	4NC5121-0CC21	–	–	–
			3.75 VA	–	–	7KT1202	–	–
2	720 V	200 A	5 VA	4NC5122-2CE21	4NC5122-0CE21	–	–	–
		250 A	5 VA	4NC5123-2CE21	4NC5123-0CE21	–	–	–
		300 A	5 VA	4NC5222-2CE21	4NC5222-0CE21	–	–	–
		400 A	5 VA	4NC5223-2CE21	4NC5223-0CE21	–	–	–
		500 A	5 VA	4NC5224-2CE21	4NC5224-0CE21	–	–	–
3	720 V	400 A	5 VA	4NC5225-2CE21	4NC5225-0CE21	–	–	–
		500 A	5 VA	4NC5325-2CE21	4NC5325-0CE21	–	–	–
		600 A	5 VA	4NC5326-2CE21	4NC5326-0CE21	–	–	–
		750 A	5 VA	4NC5327-2CE21	4NC5327-0CE21	–	–	–
4	720 V	800 A	10 VA	4NC5330-2CE21	4NC5330-0CE21	–	–	–
		1000 A	10 VA	4NC5431-2CH21	4NC5431-0CH21	–	–	–
		1250 A	10 VA	4NC5432-2CH21	4NC5432-0CH21	–	–	–
		1500 A	10 VA	4NC5434-2CH21	4NC5434-0CH21	–	–	–
		2000 A	10 VA	4NC5435-2CH21	4NC5435-0CH21	–	–	–
		2500 A	12.5 VA	4NC5438-2CJ21	4NC5438-0CJ21	–	–	–
		3000 A	12.5 VA	4NC5440-2CJ21	4NC5440-0CJ21	–	–	–
			30 VA	4NC5441-2CN21	–	–	–	–

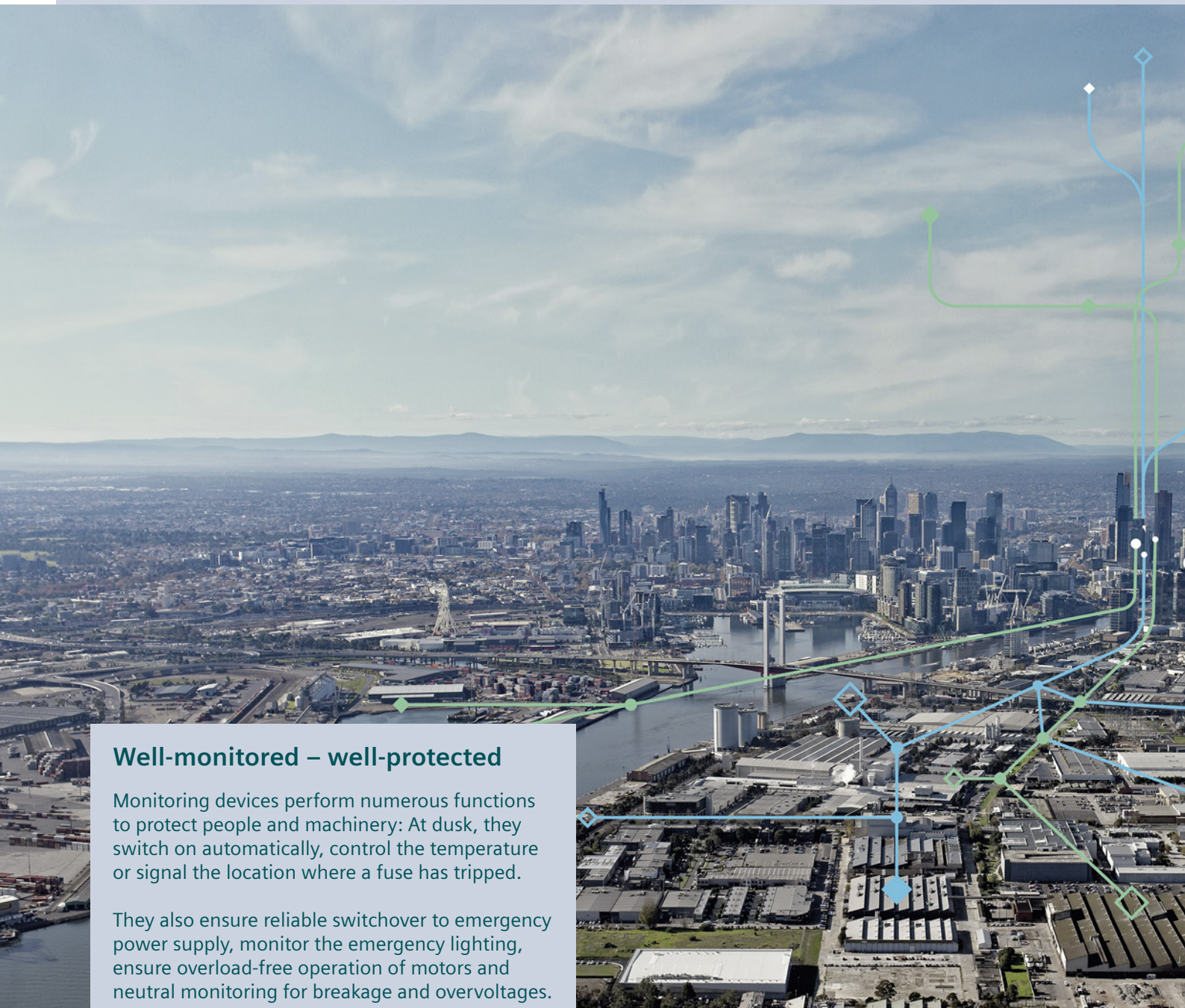
¹⁾ Overcurrent limiting factor FS5

Accessories

DIN-rail mounting



For transformer size	Article No.	Article No.	Article No.	Article No.	Article No.
1 and 5	4NC5923-5LT21	4NC5923-5LT21	–	–	–
2	4NC5925-5LT21	4NC5925-5LT21	–	–	–
3	4NC5930-5LT21	4NC5930-5LT21	–	–	–
4	4NC5940-5LT21	4NC5940-5LT21	–	–	–



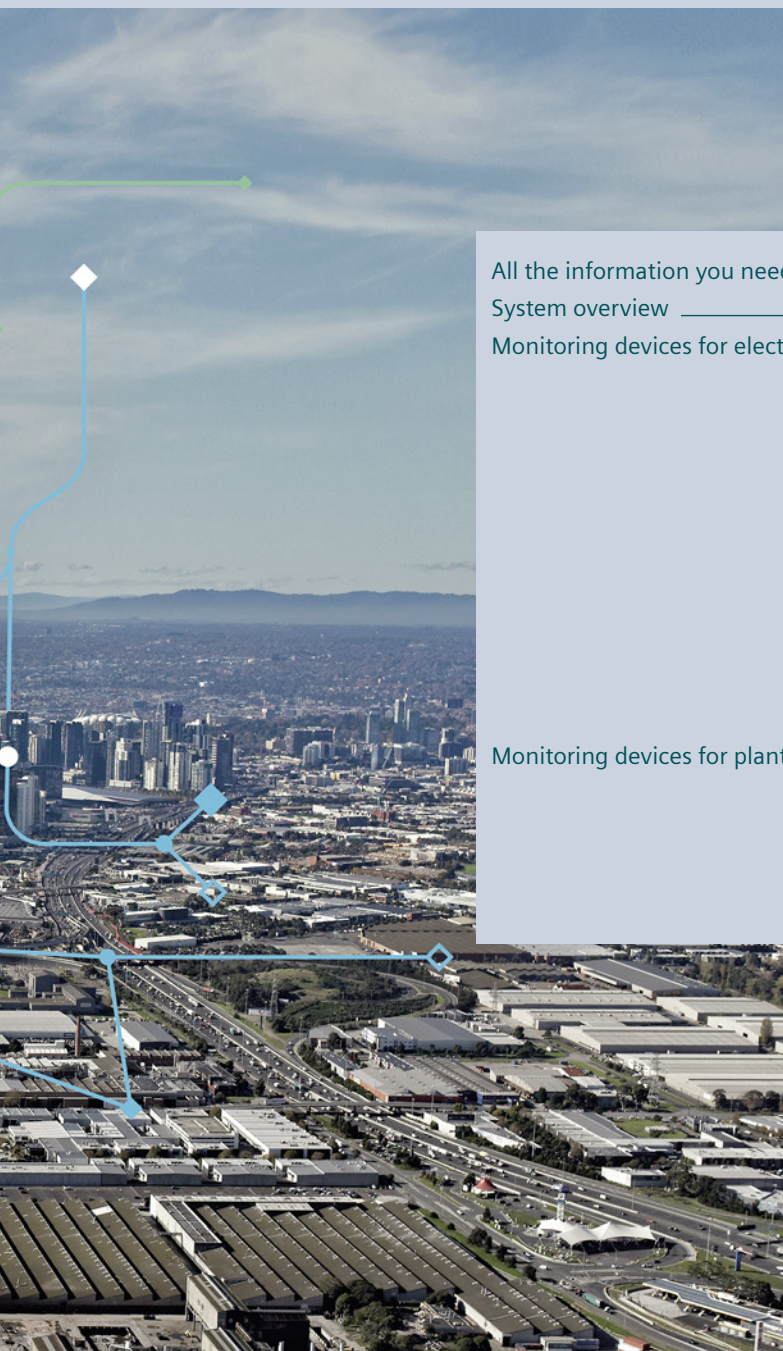
Well-monitored – well-protected

Monitoring devices perform numerous functions to protect people and machinery: At dusk, they switch on automatically, control the temperature or signal the location where a fuse has tripped.

They also ensure reliable switchover to emergency power supply, monitor the emergency lighting, ensure overload-free operation of motors and neutral monitoring for breakage and overvoltages.

Monitoring devices can do even more, e.g., underload monitoring of asynchronous motors in no-load operation.

Monitoring Devices



All the information you need	11/2
System overview	11/4
Monitoring devices for electrical values	11/6
5SV8 residual current monitors	11/6
5SV8 modular residual current device	11/8
5TT3 undervoltage relays	11/12
5TT3 short-time voltage relay	11/14
5TT3 undervoltage and overvoltage relays	11/15
5TT6 current relays	11/16
5TT3 fuse monitors	11/17
5TT3 phase monitors	11/18
5TT3 phase sequence monitors	11/19
5TT3 insulation monitors for industrial applications	11/20
Monitoring devices for plants and equipment	11/21
5TT5 EMERGENCY STOP modules	11/21
5TT3 level relays	11/22
5TT3 line circuit relays	11/23
7LQ2 twilight switches	11/24

A multitude of additional information ...

Information + ordering

All the important things at a glance

For information about monitoring devices, please visit our website www.siemens.com/lowvoltage

Your product in detail

The relevant tender specifications can be found at www.siemens.com/tenderspecifications

Use our conversion tool for quick and easy conversion to Siemens products www.siemens.com/conversion-tool

Everything you need for your order

Refer to SiePortal to find an overview of your products (product catalog)

- Monitoring devices sie.ag/2m3no4A

Direct forwarding to the individual products in SiePortal by clicking on the article number in the catalog or entering this web address incl. article number www.siemens.com/product_catalog_SIEP?Article No.

The fast track to the experts

Contact persons in your region

We offer a comprehensive portfolio of services. You can find your local contacts at www.siemens.com/lowvoltage/components/contact

You will find further information on services at www.siemens.com/service-offers

Competent expert advice on technical questions with a wide range of demand-optimized services for all our products and systems.

Assistance with technical queries is provided at www.siemens.com/support-request

... can be found in our online services

Commissioning + operation

Your product in detail

The SiePortal platform (knowledge base) provides detailed technical information

www.siemens.com/lowvoltage/product-support

- Operating instructions
- Characteristic curves
- Certificates

Online Support app available for download from the [App Store](#) and [Play Store](#)

You will find further information at www.siemens.com/support-app

Provision of 3D data (step and u3d data formats)

- SiePortal (product catalog)
www.siemens.com/lowvoltage/product-catalog
- Image database
www.siemens.com/lowvoltage/picturedb

Engineering data for CAD or CAE systems are available in the CAX Download Manager at www.siemens.com/cax

Manuals

Manuals can be found in SiePortal at www.siemens.com/lowvoltage/manuals

- Configuration Manual
 - Monitoring devices ([45316099](#))

Technical overview – Monitoring devices



The fast way to get you to our online services

This page provides you with comprehensive information and links on monitoring devices
www.siemens.com/lowvoltage/product-support (109769086)

System overview

Monitoring devices for electrical values



5SV8 residual current monitor



5SV8 modular residual current device



5TT3 and 5TT6 relay



5TT3 monitors

Accessories



Summation current transformer



Holders for DIN rails



Magnetic field centering sleeves

Monitoring devices for plants and equipment



5TT5 EMERGENCY STOP modules



5TT3 relay



7LQ2 twilight switches

Accessories







Immersion electrodes

Note:

You will find a detailed range of accessories with the basic units.

5SV8 residual current monitors

Type A and type AC

Mounting width	RCM analog		RCM digital			
	2 MW	3 MW	3 MW	3 MW		
						
Rated operational voltage U_e	Rated residual current $I_{\Delta n}$		Response time Δt	1 channel	4 channels	
230 V AC	Type A	> 3 A	0.02 ... 5 s	5SV8000-6KK	–	–
	Type AC	5 ... 30 A	0.02 ... 10 s, INS, SEL ¹⁾	–	5SV8001-6KK	5SV8200-6KK

Further technical specifications

	5SV8000-6KK	5SV8001-6KK	5SV8200-6KK
Standards			
Standards	EN 62020, IEC 62020		
Approvals	–	UL	
Supply			
Rated operational voltage U_e	230 V AC		
Frequency	50/60 Hz		
Rated residual current $I_{\Delta n}$	Type A	0.03 ... 3 A	
	Type AC	> 3 A	5 ... 30 A
Response time Δt	0.02 ... 5 s	0.02 ... 10 s, INS, SEL ¹⁾	
Relay contacts			
Relay contacts	1 × alarm	1 × pre-alarm, 1 × alarm	1 × pre-alarm, 4 × alarm
Rated voltage	230 V AC		
Rated current	6 A		
Summation current transformer			
Diameter	20 ... 210 mm		
Equipment			
Maximum cable length RCM/CT	10 m (shielded cable)		
Conductor cross-section	1.5 mm ²		
Test/reset	Yes/Yes		
External tripping operation/external reset	–/Yes	Yes/Yes	
Safety			
Degree of protection	Contacts	IP20	
	Front	IP41	
Ambient conditions			
Operating temperature	-10 ... +50 °C		

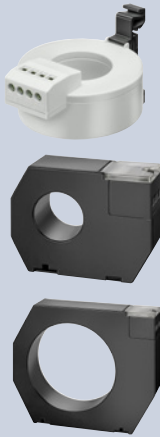
¹⁾ INS: Instantaneous,
SEL: Selective

Accessories

Summation current transformers

- Including holder for DIN rail or wall mounting
- Standard ☉

Mounting options	Lowest measurable residual current $I_{\Delta n \text{ min}}$	Rated current I_n	Maximum current ²⁾ I_{max}	Internal diameter	Article No.
DIN rail	30 mA	$\leq 40 \text{ A}$	240 A	20 mm	5SV8700-0KK
		$\leq 63 \text{ A}$	380 A	30 mm	5SV8701-0KK
Wall mounting, DIN rail ¹⁾	30 mA	$\leq 80 \text{ A}$	480 A	35 mm	5SV8702-0KK
		$\leq 200 \text{ A}$	1200 A	70 mm	5SV8703-0KK
Wall mounting	100 mA	$\leq 250 \text{ A}$	1500 A	105 mm	5SV8704-0KK
	300 mA	$\leq 500 \text{ A}$	3000 A	140 mm	5SV8705-0KK
		$\leq 600 \text{ A}$	3600 A	210 mm	5SV8706-0KK



Holders for DIN rails

- Suitable for summation current transformers with internal diameter of 20 mm, 30 mm, 35 mm, 70 mm
- Cannot be used together with magnetic field centering sleeves

Article No.
5SV8900-1KK



Magnetic field centering sleeves

Internal diameter	Article No.
35 mm	5SV8902-1KK
70 mm	5SV8903-1KK
105 mm	5SV8904-1KK
140 mm	5SV8905-1KK
210 mm	5SV8906-1KK



¹⁾ The holder for DIN rails is additionally required for mounting onto the DIN rail.

²⁾ Short-time starting current, up to 2 s

5SV8 modular residual current device

Type A



Rated operational voltage U_e	Rated residual current $I_{\Delta n}$ Type A	Response time Δt	
230 V AC	0.03 ... 3 A	0.02 ... 10 s, INS, SEL ¹⁾	5SV8101-6KK

Further technical specifications

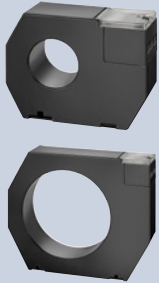
Standards		
Standards	EN 60947-2 (Annex M), IEC 60947-2 (Annex M)	
Approvals	–	
Supply		
Rated operational voltage U_e	230 V AC from a 1-phase auxiliary voltage source (also externally)	
Frequency	50/60 Hz	
Rated residual current $I_{\Delta n}$	Type A	0.03 ... 3 A (default setting: 30 mA)
	Type AC	–
Response time Δt	$I_{\Delta n} = 30 \text{ mA}$	INS instantaneous
	$I_{\Delta n} > 30 \text{ mA}$	INS – SEL – 0.06 ... 10 s ¹⁾ (default setting INS)
Relay contacts		
Relay contacts	1 × alarm, 1 × tripping operation	
Rated voltage	230 V AC	
Rated current	6 A	
Summation current transformer		
Diameter	35 ... 210 mm	
Equipment		
Maximum cable length RCM/CT	10 m (shielded cable)	
Conductor cross-section	0.125 ... 2.08 mm ²	
Test/reset	Yes/Yes	
External tripping operation/external reset	Yes/Yes	
Safety		
Degree of protection	Contacts	IP20
	Front	IP41
Ambient conditions		
Operating temperature	-10 ... +50 °C	

¹⁾ INS: Instantaneous,
SEL: Selective

Accessories

Summation current transformers

- Including holder for wall mounting
- Standard ☉



Mounting options	Lowest measurable residual current $I_{\Delta n \text{ min}}$	Rated current I_n	Maximum current ²⁾ I_{max}	Internal diameter	Article No.
Wall mounting, DIN rail ¹⁾	30 mA	≤ 80 A	480 A	35 mm	5SV8702-0KK
	30 mA	≤ 200 A	1200 A	70 mm	5SV8703-0KK
Wall mounting	100 mA	≤ 250 A	1500 A	105 mm	5SV8704-0KK
	300 mA	≤ 500 A	3000 A	140 mm	5SV8705-0KK
		≤ 600 A	3600 A	210 mm	5SV8706-0KK

Holders for DIN rails



- Suitable for summation current transformers with internal diameter of 20 mm, 30 mm, 35 mm, 70 mm
- Cannot be used together with magnetic field centering sleeves

Article No.
5SV8900-1KK

Magnetic field centering sleeves

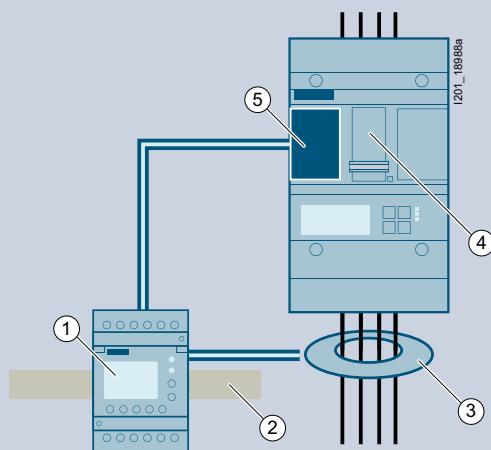


Internal diameter	Article No.
35 mm	5SV8902-1KK
70 mm	5SV8903-1KK
105 mm	5SV8904-1KK
140 mm	5SV8905-1KK
210 mm	5SV8906-1KK

¹⁾ The holder for DIN rails is additionally required for mounting onto the DIN rail.

²⁾ Short-time starting current, up to 2 s

Tested combination options



5SV8101-6KK/- (tested combinations)

① Modular residual current device

5SV8101-6KK

② DIN rail

EN 60715 – TH35 – 7.5 35 – 15

③ Summation current transformers

Magnetic field centering sleeves

Ø 35 mm 5SV8702-0KK 5SV8902-1KK

Ø 70 mm 5SV8703-0KK 5SV8903-1KK

Ø 105 mm 5SV8704-0KK 5SV8904-1KK

Ø 140 mm 5SV8705-0KK 5SV8905-1KK

Ø 210 mm 5SV8706-0KK 5SV8906-1KK

④ Molded case circuit breakers

⑤ Trip element

3VL17...

3VL9400-1UP00

3VL27...

3VL37...

3VL47...

3VA10...

3VA9908-0BB11

3VA11...

3VA9908-0BB20

3VA20...

3VA9908-0BB24

3VA21...

3VA9908-0BB25

3VA22...

3VA12...

3VA9908-0BB11

3VA23...

3VA9908-0BB20

3VA24...

3VA9908-0BB24

5SV8 modular residual current device

Type B

Mounting width **MRCD digital**
2 MW



Rated operational voltage U_e	Rated residual current $I_{\Delta n}$ Type B	Response time Δt	
230 V AC	0.03 ... 1 A	0 ... 10 s	5SV8101-4KK
24 V DC	0.03 ... 1 A	0 ... 10 s	5SV8111-4KK

Further technical specifications

5SV8101-4KK

5SV8111-4KK

Standards		Standards	
Standards		EN 60947-2 (Annex M), IEC 60947-2 (Annex M)	
Supply			
Supply voltage U_s		230 V AC (70 ... 300 V AC)	24 V DC (9.6 ... 94 V DC)
Frequency		50/60 Hz	–
Power consumption		< 6.5 VA	
Relay contacts			
Relay contacts		1 × alarm, 1 × tripping operation	
Rated voltage		250 V AC	
Rated current		5 A	
External summation current transformer			
Internal diameter		35 ... 210 mm (5SV8701-2KK, 5SV8701-2KP, 5SV8702-2KK, 5SV8702-2KP, 5SV8703-2KK, 5SV8704-2KK)	
Rated voltage	(Summation current transformers)	690 V	
Response characteristic	Acc. to IEC 60947-2 (M)	Type B	
Rated frequency		0 ... 2 kHz	
Response residual current	$I_{\Delta n1}$ (AL1 alarm)	50 ... 100% of $I_{\Delta n2}$ (factory setting: 50%)	
	$I_{\Delta n2}$ (TP2 tripping)	30 mA ... 1 A (factory setting: 30 mA)	
Response delay	t_{on1} (alarm)	0 ... 10 s (factory setting: 1 s)	
	t_{on2} (tripping)	0 ... 10 s (factory setting: 0 s)	
Equipment			
Maximum cable length MRCD/converter		10 m (6 × 0.75 mm ²)	
Password		Off/0 ... 999 (factory setting: 0)	
Safety			
Degree of protection	Components (IEC 60529)	IP30	
	Terminals (IEC 60529)	IP20	
EMC		IEC 60947-2 (M)	
Overvoltage category		III	
Pollution degree		3	
Mechanical data			
Width		36 mm (2 MW)	
Depth		64 mm	
Height		85 mm	
Weight		150 g	
Mounting		DIN rail	
Enclosure material		Polycarbonate	
Electrical connection		Screw terminals	
Conductor cross-section	Rigid	0.2 ... 4 mm ²	
	Flexible, with end sleeve	0.2 ... 2.5 mm ² (AWG 24 ... 12)	
Stripped length		8 ... 9 mm	
Tightening torque		0.5 ... 0.6 Nm	
Ambient conditions			
Operating temperature		-25 ... +55 °C	

Accessories

Summation current transformers



Lowest measurable residual current $I_{\Delta n \text{ min}}$	Rated current I_n	Maximum current ¹⁾ I_{max}	Internal diameter	Version	Article No.
10 mA	$\leq 80 \text{ A}$	500 A	35 mm	Standard	5SV8701-2KK
				With shield	5SV8701-2KP
	$\leq 160 \text{ A}$	1000 A	60 mm	Standard	5SV8702-2KK
				With shield	5SV8702-2KP
100 mA	$\leq 330 \text{ A}$	2000 A	120 mm	Standard	5SV8703-2KK
300 mA	$\leq 630 \text{ A}$	3800 A	210 mm	Standard	5SV8704-2KK

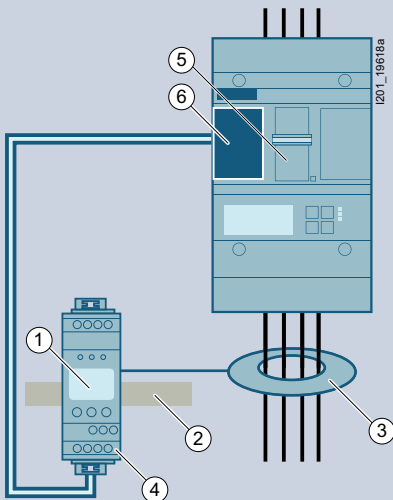
Holders for DIN rails



Suitable for summation current transformers	Article No.
5SV8701-2KK, 5SV8701-2KP	5SV8900-2KK
5SV8702-2KK, 5SV8702-2KP	5SV8900-3KK

¹⁾ Short-time starting current, up to 2 s

Tested combination options



5SV8101-4KK/5SV8111-4KK (tested combinations)

① Modular residual current device

5SV8101-4KK/5SV8111-4KK

② DIN rail

EN 60715 – TH35 – 7,5 35 – 15

③ Summation current transformers

Ø 35 mm 5SV8701-2KK/5SV8701-2KP

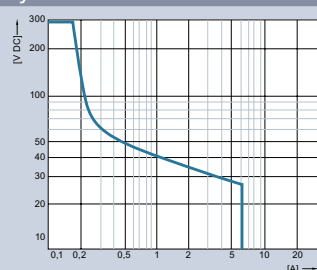
Ø 60 mm 5SV8702-2KK/5SV8702-2KP

Ø 120 mm 5SV8703-2KK

Ø 210 mm 5SV8704-2KK

④ Relay contacts

DC:



AC: max. 230 V, 5A

⑤ Molded case circuit breakers

3VA1...

3VA20...

3VA21...

3VA22...

3VA23...

3VA24...

⑥ Trip element

3VA9908-0BB11

3VA9908-0BB24




3VA9908-0BB25

3VA9908-0BB11

3VA9908-0BB25

5TT3 undervoltage relays

Without response delay

Contacts	For the monitoring of		
	1, 2 or 3 phases against N	2 CO	3 phases against N
Mounting width	1 MW	2 MW	2 MW
			

Rated operational voltage U_e	Rated operational current I_e	Switching thresholds	Hysteresis			
Not adjustable						
230 V AC	4 A	0.7 and 0.9 × U_c	–	5TT3400	5TT3402	5TT3404
		0.85 and 0.95 × U_c	–	5TT3401	–	5TT3405
Adjustable						
230 V AC	4 A	0.7 ... 0.95 × U_c	5%	–	–	5TT3406
		0.9 ... 0.95 × U_c	–	–	5TT3403	–



5TT3400		
5TT3401		
5TT3402	5TT3404	
5TT3403	5TT3405	5TT3406

Further technical specifications

Standards			
Standards		IEC 60255, DIN VDE 0435-110, DIN VDE 0435-303	
Supply			
Rated control circuit voltage U_c		230/400 V AC	
Primary operating range (overload capability)		1.1 × U_c	
Rated frequency		50/60 Hz	
Contacts			
μ contact		AC-11	4 A
Response values		ON-switching	0.9/0.95 × U_c
		OFF-switching	0.7/0.85 × U_c
Minimum contact load		10 V/100 mA	
Safety			
Rated insulation voltage U_i		Between coil/contact	4 kV
Electrical isolation, creepage distances and clearances		Actuator/contact	3 mm 5.5 mm
Rated impulse withstand voltage U_{imp}		Actuator/contact	> 2.5 kV > 4 kV
Functions			
Phase asymmetry		Setting accuracy	– Approx. 5 ... 10%
		Repeat accuracy	– 1
Phase failure detection		At L1 or L2 or L3	100 ms
Functions		Monitoring of 1/2 phases against N	Yes –
		Monitoring of 3 phases against N	Yes
		Asymmetry (failure) detection	– Yes
		Reverse (failure) detection	– Yes
		Phase failure detection	Yes
		N-conductor monitoring	– Yes
Connection			
Terminals		± Screw (Pozidriv)	PZ 1
Conductor cross-sections		Rigid	Max. 2 × 2.5 mm ²
		Flexible, with end sleeve	Min. 1 × 0.5 mm ²
Ambient conditions			
Permissible ambient temperature		-20 ... +60 °C	
Resistance to climate		Acc. to EN 60068-1	20/60/4

5TT3 undervoltage relays

With response delay

		For the monitoring of 1, 2 or 3 phases against N	
Contacts		1 CO	2 CO
Mounting width		1 MW	1 MW
			

Rated operational voltage U_e	Rated operational current I_e	Switching thresholds	Hysteresis	Standard	With TEST pushbutton
Not adjustable					
230 V AC	4 A	$0.85 \times U_c$	5%	5TT3414	5TT3415

Further technical specifications

		5TT3414	5TT3415
Supply			
Rated control circuit voltage U_c		230/400 V AC	
Primary operating range (overload capability)		$1.15 \times U_c$	
Rated frequency		50/60 Hz	
Contacts			
Contacts	AC-15	1 CO	2 CO
Response values	ON-switching	5% hysteresis	
	OFF-switching	$0.85 \times U_c$	
Response delay		0.5 s	
Return transfer delay		60 s	
Minimum contact load		10 V/100 mA	
Electrical endurance in operating cycles	AC-15 (1 A, 230 V AC)	1×10^5	
Safety			
Rated insulation voltage U_i	Between coil/contact	–	
Rated impulse withstand voltage	Acc. to IEC 60664-1	6 kV	
Pollution degree		2	
Functions			
Phase failure detection	At L1 or L2 or L3	500 ms	
Functions	Monitoring of 1 or 2 phases against N	Yes	
	Monitoring of 3 phases against N	Yes	
	Phase failure detection	Yes	
Connection			
Terminals	– Screw (slot)	3.5 mm	
Conductor cross-sections	Rigid	$1 \times 4 \text{ mm}^2$	
	Flexible, with end sleeve	$1 \times 2.5 \text{ mm}^2$	
Ambient conditions			
Permissible ambient temperature		-25 ... +60 °C	
Resistance to climate	Acc. to EN 60068-1	20/060/04	

5TT3 short-time voltage relay

Without response delay

For the monitoring of
1, 2 or 3 phases against N

Contacts 2 CO
Mounting width 2 MW



Rated operational voltage U_e	Rated operational current I_e	Switching thresholds	
Not adjustable			
230 V AC	4 A	$0.8 \dots 0.85 \times U_c$	5TT3407

Further technical specifications

Standards			
Standards		IEC 60255, DIN VDE 0435-303	
Supply			
Rated control circuit voltage U_c		230/400 V AC	
Primary operating range (overload capability)		$1.1 \times U_c$	
Rated frequency		50/60 Hz	
Rated operational power P_s		AC operation:	230 V and p.f. = 1 230 V and p.f. = 0.4
		DC operation:	$U_e = 24 \text{ V}$ and $I_e = 6 \text{ A}$ $U_e = 60 \text{ V}$ and $I_e = 1 \text{ A}$ $U_e = 110 \text{ V}$ and $I_e = 0.6 \text{ A}$ $U_e = 220 \text{ V}$ and $I_e = 0.5 \text{ A}$
Back-up fuse		Terminals L1/L2/L3	2 A
Contacts			
μ contact		AC-11	3 A
Response values		ON-switching	$0.85 \times U_c$
		OFF-switching	$0.8 \times U_c$
Automatic reclosing delay (return transfer delay)		0.2 ... 2 s	
Minimum contact load		10 V/100 mA	
Safety			
Rated insulation voltage U_i		Between coil/contact	4 kV
Electrical isolation, creepage distances and clearances		Actuator/contact	4 mm
Rated impulse withstand voltage U_{imp}		Actuator/contact	> 4 kV
Functions			
Phase failure detection		At L1 or L2 or L3	$\geq 20 \text{ ms}$
Phase asymmetry		Setting accuracy	Approx. 5 ... 10%
		Repeat accuracy	1
Functions		Monitoring of 1 or 2 phases against N	Yes
		Monitoring of 3 phases against N	Yes
		Phase failure detection	Yes
		N-conductor monitoring	Yes
Connection			
Terminals		\pm Screw (Pozidriv)	PZ 1
Conductor cross-sections		Rigid	Max. $2 \times 2.5 \text{ mm}^2$
		Flexible, with end sleeve	Min. $1 \times 0.5 \text{ mm}^2$
Ambient conditions			
Permissible ambient temperature		-20 ... +60 °C	
Humidity class		Acc. to IEC 60068-2-30	F

5TT3 undervoltage and overvoltage relays

With adjustable response delay

For the monitoring of
3 phases against N

Contacts 2 CO
Mounting width 2 MW








Rated operational voltage U_e	Rated operational current I_e	Switching thresholds	Hysteresis	
Adjustable				
230 V AC	4 A	0.7 and $1.1 \times U_c$ 0.9 and $1.3 \times U_c$	4% 4%	5TT3408

Further technical specifications

Standards			
Standards			IEC 60255, DIN VDE 0435-303
Supply			
Rated control circuit voltage U_c			230/400 V AC
Primary operating range (overload capability)			$1.35 \times U_c$
Rated frequency			50/60 Hz
Back-up fuse	Terminals L1/L2/L3		2 A
Contacts			
μ contact	AC-11		1 A
Response values	Overvoltage:	ON-switching	4% hysteresis
		OFF-switching	$0.9 \dots 1.3 \times U_c$
	Undervoltage:	ON-switching	4% hysteresis
		OFF-switching	$0.7 \dots 1.1 \times U_c$
OFF-delay (response delay)			0.1 ... 20 s
Automatic reclosing delay (return transfer delay)			–
Minimum contact load			10 V/100 mA
Safety			
Rated insulation voltage U_i	Between coil/contact		4 kV
Electrical isolation, creepage distances and clearances	Contact/contact		4 mm
	Actuator/contact		4 mm
Rated impulse withstand voltage U_{imp}	Actuator/contact		> 4 kV
Functions			
Phase failure detection	At L1 or L2 or L3		100 ms
Phase asymmetry	Setting accuracy		Approx. 5 ... 10%
	Repeat accuracy		1
Functions	Monitoring of 1 or 2 phases against N		–
	Monitoring of 3 phases against N		Yes
	Asymmetry detection		Yes
	Reverse voltage detection		Yes
	Phase failure detection		Yes
	N-conductor monitoring		Yes
Connection			
Terminals	\pm Screw (Pozidriv)		PZ 1
Conductor cross-sections	Rigid		Max. $2 \times 2.5 \text{ mm}^2$
	Flexible, with end sleeve		Min. $1 \times 0.5 \text{ mm}^2$
Ambient conditions			
Permissible ambient temperature			-20 ... +60 °C
Humidity class	Acc. to IEC 60068-2-30		F

5TT6 current relays

For 1-phase loads up to 230 V AC

Rated operational voltage U_e	Rated operational current I_e	Contacts	Rated control current I_c	Auxiliary voltage and load voltage				
				Not isolated		Electrically isolated		
				Mounting width		1 MW	1 MW	2 MW
								
				Monitoring Undercurrent	Monitoring Overcurrent	Monitoring Undercurrent	Monitoring Overcurrent	Monitoring Overcurrent/undercurrent
230 V AC	5 A	1 CO 2 CO	1 ... 10 A 0.1 ... 1 A, 0.5 ... 5 A, 1 ... 10 A, 1.5 ... 15 A	5TT6111 –	5TT6112 –	– 5TT6113	– 5TT6114	– 5TT6115

Further technical specifications

Standards								
Standards						IEC 60255		IEC 60255 DIN VDE 0435-303
Supply								
Rated control current I_c						1 ... 10 A		0.1 ... 1 A, 0.5 ... 5 A, 1 ... 10 A, 1.5 ... 15 A
Rated control circuit voltage U_c						230 V AC		
Primary operating range						0.9 ... 1.1 × U_c		
Overload capability			Continuous			15 A		20 A
			At 50 °C ambient temperature max. 3 s			20 A		–
			Independent of measuring range, max. 3 s			–		30 A
Rated frequency						50/60 Hz		
Contacts								
μ contact (AC-15)			NO			3 A		5 A
			NC			1 A		
Response values			ON-switching			Infinitely variable		
			OFF-switching			Permanent, 4% hysteresis		
Switching delay t_v						0.1 ... 20 s, continuously adjustable		
Response time			Non-adjustable			Current corresponds to the rated operational power of the continuous-flow heater		See Siemens Service and Support Portal, search term "Article No.", e.g. 5TT6113
Minimum contact load						10 V/100 mA		
Safety								
Rated insulation voltage U_i			Between coil/contact			2.5 kV		
Electrical isolation, creepage distances and clearances			Actuator/contact			3 mm		
Rated impulse withstand voltage U_{imp}			Actuator/contact			> 4 kV		
Connection								
Terminals			± Screw (Pozidriv)			PZ 1		
Conductor cross-sections			Rigid			Max. 2 × 2.5 mm ²		
			Flexible, with end sleeve			Min. 1 × 0.5 mm ²		
Ambient conditions								
Permissible ambient temperature						-20 ... +60 °C		
Resistance to climate			Acc. to EN 60068-1			20/60/4		

5TT3 fuse monitors

For all low-voltage fuse systems

Mounting width 2 MW



Rated operational voltage U_e	Rated operational current I_e	Rated control circuit voltage U_c	
Adjustable			
250 V AC	4 A	380 ... 415 V AC	5TT3170

Further technical specifications

Standards		
Standards	IEC 60255, DIN VDE 0435-110	
Supply		
Rated operational voltage U_e	250 V AC	
Rated operational current I_e	AC-1	4 A
Rated control circuit voltage U_c	3 AC	380 ... 415 V
Primary operating range	0.8 ... 1.1 × U_c	
Rated frequency	50 ... 400 Hz	
Contacts		
Internal resistance of measuring paths	> 1000 Ω/V	
Max. permissible rear feed	90%	
Response/release time	< 50 ms	
Electrical endurance AC-11	In switching cycles at 1 A	1.5×10^5
Safety		
Rated impulse withstand voltage U_{imp}	Input/output	> 4 kV
Application		
Area of application	Asymmetric, systems afflicted with harmonics, regenerative motors	
Message	Also for disconnected loads	
Connection		
Terminals	± Screw (Pozidriv)	PZ 1
Conductor cross-sections	Rigid	Max. 2 × 2.5 mm ²
	Flexible, with end sleeve	Min. 1 × 0.5 mm ²
Ambient conditions		
Permissible ambient temperature	-20 ... +45 °C	
Resistance to climate	Acc. to EN 60068-1	20/45/4

5TT3 phase monitors

For monitoring of voltages in a three-phase system

Mounting width 1 MW



Rated operational voltage U_e	Rated operational current I_e	Contacts	Rated control circuit voltage U_c	With 3 green LEDs for 3 phases
250 V AC	4 A	1 CO	230/400 V	5TT3421

Further technical specifications

Standards			
Standards		IEC 60255, DIN VDE 0435	
Supply			
Rated operational voltage U_e		250 V AC	
Rated operational current I_e		4 A	
Rated control circuit voltage U_c		230/400 V AC	
Primary operating range		0.8 ... 1.1 × U_c	
Rated frequency		50/60 Hz	
Rated power dissipation P_v		Electronics	9 VA
		Contacts	0.2 VA
Contacts			
μ contact		AC-11	3 A
Minimum contact load		10 V/100 mA	
Safety			
Rated insulation voltage U_i		Between coil/contact	4 kV
Electrical isolation, creepage distances and clearances		Actuator/contact	4 mm
Rated impulse withstand voltage U_{imp}		Actuator/contact	> 2.5 kV
Degree of protection		Acc. to EN 60529	IP20, with connected conductors
Protection class		Acc. to EN 61140/VDE 0140-1	II
Connection			
Terminals		± Screw (Pozidriv)	PZ 1
Conductor cross-sections		Rigid	Max. 2 × 2.5 mm ²
		Flexible, with end sleeve	–
Ambient conditions			
Permissible ambient temperature		-20 ... +60 °C	
Resistance to climate		Acc. to EN 60068-1	20/60/4

5TT3 phase sequence monitors

For monitoring of phase sequence in a three-phase system

Mounting width 1 MW



Rated operational voltage U_e	Rated operational current I_e	Contacts	Rated control circuit voltage U_c	With one green LED, which lights up for right-rotating field
250 V AC	4 A	1 CO	400 V	5TT3423

Further technical specifications

Standards			
Standards		IEC 60255, DIN VDE 0435	
Supply			
Rated operational voltage U_e		250 V AC	
Rated operational current I_e		4 A	
Rated control circuit voltage U_c		400 V AC	
Primary operating range		$0.8 \dots 1.1 \times U_c$	
Rated frequency		50/60 Hz	
Rated power dissipation P_v		Electronics	9 VA
		Contacts	0.2 VA
Contacts			
μ contact		AC-11	3 A
Minimum contact load		10 V/100 mA	
Safety			
Rated insulation voltage U_i		Between coil/contact	4 kV
Electrical isolation, creepage distances and clearances		Actuator/contact	4 mm
Rated impulse withstand voltage U_{imp}		Actuator/contact	> 2.5 kV
Degree of protection		Acc. to EN 60529	IP20, with connected conductors
Protection class		Acc. to EN 61140/VDE 0140-1	II
Connection			
Terminals		\pm Screw (Poqidriv)	PZ 1
Conductor cross-sections		Rigid	Max. $2 \times 2.5 \text{ mm}^2$
		Flexible, with end sleeve	–
Ambient conditions			
Permissible ambient temperature		-20 ... +60 °C	
Resistance to climate		Acc. to EN 60068-1	20/60/4

5TT3 insulation monitors for industrial applications

Are used for protection of persons and against fire in non-grounded systems (IT systems)

Mounting width 2 MW



Measurement voltage range U_{meas}	Measuring range	Contacts	Rated control circuit voltage U_c	
0 ... 500 V AC	5 ... 100 k Ω	2 CO	230 V AC	5TT3470
12 ... 280 V DC	5 ... 200 k Ω	2 CO	–	5TT3471

Further technical specifications

		5TT3470	5TT3471
Supply			
Rated operational voltage U_e		230 V AC	12 ... 280 V DC
Rated operational current I_s	Thermal current I_{th}	4 A	
	DC-13 at 24 V DC	–	2 A
	DC-13 at 250 V DC	–	0.2 A
	AC-15	–	3 A
	AC-15 NO	5 A	–
	AC-15 NC	2 A	–
Supply voltage U_c	For AC supply	220 ... 240 V AC	–
Primary operating range	For AC supply	0.8 ... 1.1 $\times U_c$	–
Frequency range for U_c		45 ... 400 Hz	–
Rated power dissipation P_v	For AC supply	Approx. 2 VA	–
	For DC supply	–	Approx. 1 W
Contacts			
μ contact		2 CO	
Switching hysteresis	At R_{meas} 50 k Ω	15%	10 ... 15%
Measuring circuit			
Measuring circuit		For 3-phase and AC systems	For direct voltage systems
Measurement voltage range U_{meas}		0 ... 500 V AC	12 ... 280 V DC
Measurement voltage U_{meas}	Internal	Approx. 15 V DC	–
Primary operating range		0 ... 1.1 $\times U_{meas}$	0.9 ... 1.1 $\times U_{meas}$
Frequency range for U_{meas}		10 ... 10000 Hz	–
Alarm values	Measuring shunt R_{AL}	5 ... 100 k Ω	5 ... 200 k Ω
	Setting of alarm value	On absolute scale	Infinitely variable
Alternating current internal resistance	Internal testing resistance	> 250 k Ω	–
Direct current internal resistance	Internal testing resistance	> 250 k Ω	–
	L+ and L- to PE	–	75 k Ω each
Max. measurement current I_{meas}	Short circuit	< 0.1 mA	0.2 ... 4 mA, depending on the voltage
Direct interference voltage	Max. permissible	500 V DC	–
Response delay at R_{AL} 50 k Ω and 1 μ F	∞ to 0.9 $\times R_{meas}$	< 1.3 s	0.8 s
	R_{meas} from ∞ to 0 Ω	< 0.7 s	0.4 s
Safety			
Rated impulse withstand voltage U_{imp}	Terminals A1 to A2	< 4 kV	
	Terminals L to PE	< 4 kV	
	Terminals A1, A2 to L, PE	< 4 kV	< 3 kV
	Terminals against contacts	< 6 kV	
Degree of protection	Terminals (according to EN 60529)	IP20	
	Enclosure (according to EN 60529)	IP40	
Connection			
Terminals	\pm Screw (Pozidriv)	PZ 2	
Conductor cross-sections	Rigid	Max. 2 \times 2.5 mm ²	
	Flexible, with end sleeve	Min. 1 \times 0.50 mm ²	
Ambient conditions			
Permissible ambient temperature		-20 ... +60 °C	
Resistance to climate	Acc. to EN 60068-1	20/060/04	

5TT5 EMERGENCY STOP modules

Efficient personal and machine protection in small units

Mounting width 4 MW



Rated operational voltage U_e	Rated operational current I_e	Rated control circuit voltage U_c	5TT5200
400 V AC	5 A	230 V AC	

Further technical specifications

Standards		
Standards		ISO 13849-1: 2015; EN 62061: 2005 + AC: 2010 + A1: 2013 + A2: 2015; ISO 13850: 2015; EN 60204-1: 2006 + A1: 2009 + AC: 2010 (in extracts); EN 60947-5: 2004 + A1: 2009; EN 50178: 1997; EN 61508 Parts 1-7: 2010; EN 50156-1: 2005 (in extracts)
Certification		German Technical Inspectorate Rheinland
Supply		
Primary operating range		$0.8 \dots 1.1 \times U_c$
Rated frequency f_n		50 Hz
Rated power dissipation P_v	Coil/drive	3.5 VA
	Contact per pole	0.8 VA
Control voltage	Terminal Y1	24 V AC/DC
Control current	Terminal Y1	45 mA
Contacts		
Contacts	NO AC-15	3 A
	NC AC-15	2 A
	NO/NC AC-1	5 A
Contact gap		> 1 mm
Electrical endurance	AC-15 (2 A, 230 V AC)	10^5 operating cycles
Reliable switching frequency		600 operating cycles/h
Recovery time		500 ms
Safety		
Rated impulse withstand voltage U_{imp}	Actuator/contact	> 4 kV
Electrical isolation, creepage distances and clearances	Actuator/contact	3 mm
Vibration resistance	Amplitude acc. to EN 60068-2-610 (up to 55 Hz)	0.35 mm
Connection		
Terminals	± Screw (Pozidriv)	PZ 1
Conductor cross-sections of main current paths	Rigid	Max. $2 \times 2.5 \text{ mm}^2$
	Flexible, with end sleeve	Min. $1 \times 0.50 \text{ mm}^2$
Ambient conditions		
Permissible ambient temperature		0 ... +50 °C
Resistance to climate	Acc. to EN 60068-1	0/55/04

5TT3 level relays

For level monitoring and control

Mounting width 2 MW



Rated operational voltage U_e	Rated operational current I_e	Rated control circuit voltage U_c	
250 V AC	5 A	230 V AC	5TT3435

Further technical specifications

Standards		
Standards		IEC 60255; DIN VDE 0435-110
Supply		
Rated operational voltage U_e		250 V AC
Rated operational current I_e		5 A
Rated control circuit voltage U_c		230 V AC
Primary operating range		0.8 ... 1.1 × U_c
Rated frequency f_n		50/60 Hz
Measuring circuit		
Setting range of the liquid level		2 ... 450 kΩ
Switching point hysteresis of setting value	At 450 kΩ	3%
	At 2 kΩ	6%
Electrode voltage		Max. approx. 10 V AC
Electrode current		Max. approx. 1.5 mA AC
Response delay	Adjustable	0.2 ... 20 s
OFF-delay	Adjustable	0.2 ... 20 s
Test voltage	Input/auxiliary circuit	4 kV
	Input/output circuit	4 kV
	Auxiliary/output circuit	4 kV
Voltage temperature influence		From setting value
Max. cable length to the electrodes at 100 μF/km	Setting value 450 kΩ	50 m
	Setting value 100 kΩ	200 m
	Setting value 35 kΩ	500 m
	Setting value 10 kΩ	1500 m
	Setting value 5 kΩ	3000 m
Connection		
Terminals	± Screw (Pozidriv)	PZ 2
Conductor cross-sections	Rigid, max.	Max. 2 × 2.5 mm ²
	Flexible, with end sleeve	Min. 1 × 0.50 mm ²
Ambient conditions		
Permissible ambient temperature		-20 ... +60 °C
Resistance to climate	Acc. to EN 60068-1	20/60/4

Accessories

Immersion electrodes



- Made of stainless steel, with PG13 sealing cap
- Suitable for pure water in open containers

Temperature range	Connection	Article No.
0 ... 60 °C	Terminal connection	5TG8223

5TT3 line circuit relays

To interrupt circuits where there are no active loads

Mounting width 1 MW



Rated operational voltage U_e	Rated operational current I_e	Contacts	Rated control circuit voltage U_c	Article No.
250 V AC	16 A	1 NC	230 V AC	5TT3171

Further technical specifications

Standards			
Standards		IEC 60255; DIN VDE 0435-110	
Supply			
Rated operational voltage U_e		250 V AC	
Rated operational current I_e		AC-1	16 A
Rated control circuit voltage U_c		230 V AC	
Primary operating range		0.85 ... $1.15 \times U_c$	
Rated frequency		50/60 Hz	
Rated power dissipation P_v		Electronics	5 VA
		Contacts	2.6 VA
Contacts			
Response value		Adjustable	2 ... 20 VA
Release value		% of the response value	70%
Electrical endurance		In switching cycles at 3 A (AC-11)	5×10^5
Safety			
Rated impulse withstand voltage U_{imp}		Input/output	> 4 V
Degree of protection		Acc. to IEC/EN 60529	IP20, with connected conductors
Protection class		Acc. to EN 61140/VDE 0140-1	II
Monitoring voltage		3 V	
Connection			
Terminals		\pm Screw (Pozidriv)	PZ 1
Conductor cross-sections		Rigid	Max. $2 \times 2.5 \text{ mm}^2$
		Flexible, with end sleeve	Min. $1 \times 0.50 \text{ mm}^2$
Ambient conditions			
Permissible ambient temperature		-20 ... +45 °C	
Humidity class		Acc. to IEC 60068-2-30	F

Accessories

Base load resistors for electronic devices

- With 15 cm connection wires, end sleeves and shrink sleeving

Article No.

5TG8222

7LQ2 twilight switches

For lighting system monitoring and control

Mounting width 1 MW




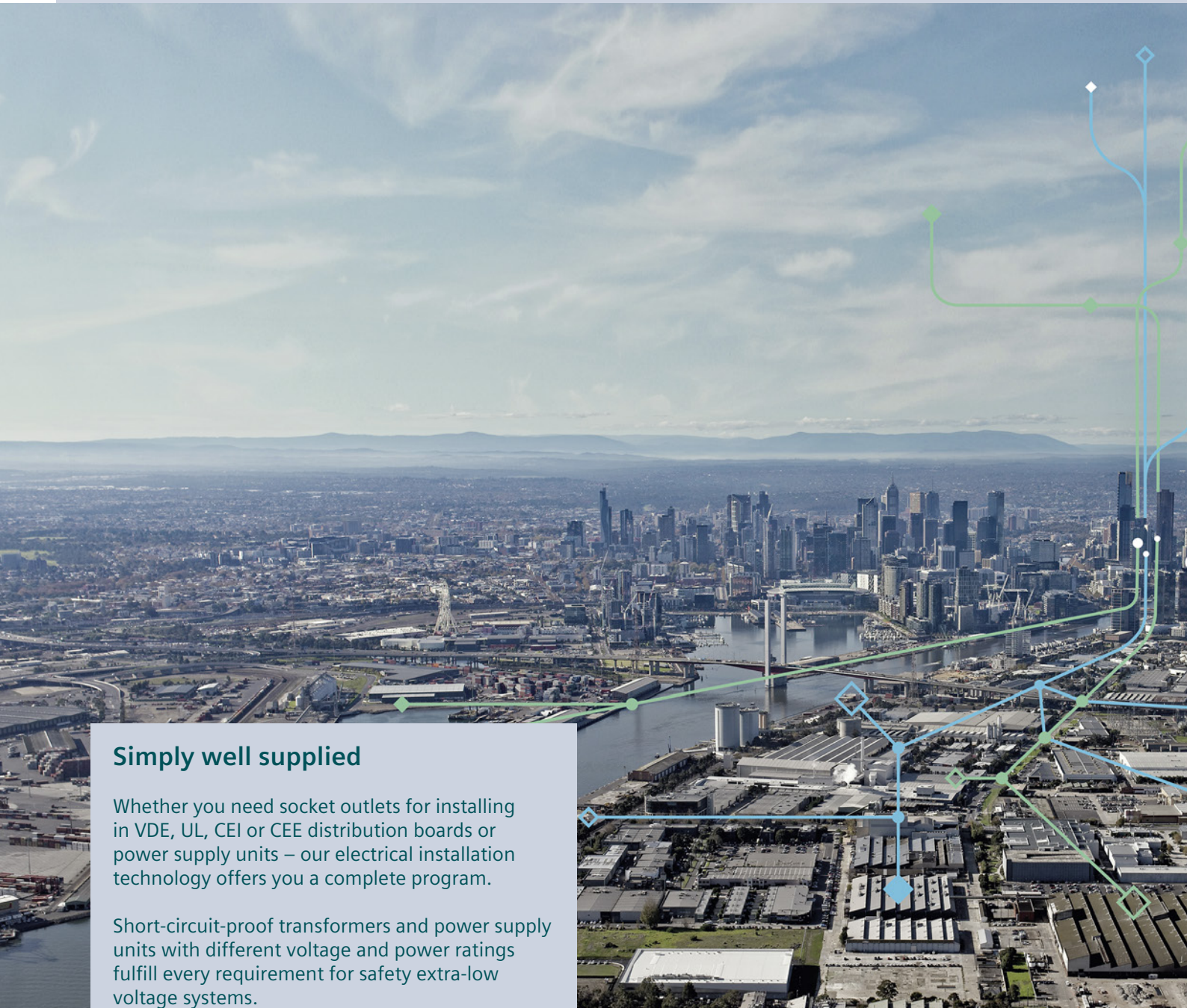
Rated operational voltage U_e	Rated operational current I_e	Contacts	Rated control circuit voltage U_c	
230 V AC	16 A	1 NO	250 V AC	7LQ2300

Further technical specifications

Standards		
Standards	EN 60669-1	
Supply		
Rated operational voltage U_e	230 V AC	
Rated frequency f_n	50/60 Hz	
Safety		
Degree of protection	IP30	
Contacts		
Incandescent lamp/halogen lamp load	2000 W	
Energy-saving lamp load	1000 W	
Fluorescent lamp load	Series corrected	2000 W
	Parallel corrected (at max. 70 μ F)	1000 W
LV halogen lamp load ECG	2000 W	
Luminosity setting	1 ... 100000 Lux	
Measuring circuit		
ON/OFF-delay	Approx. 90 s	
Connection		
Terminals	\pm Screw (Pozidriv)	PZ1
Conductor cross-sections	Rigid	Max. 2 \times 1.5 mm ²
Mechanical data		
Width		17.5 mm (1 MW)
Mounting		DIN rail
Ambient conditions		
Permissible ambient temperature		-20 ... +55 °C

Spare part

Light sensor		
 <ul style="list-style-type: none"> Included in the 7LQ2300 package Degree of protection IP65 	Temperature range	Article No.
	-20 ... +70 °C	7LQ2920
	Mounting	Surface mounting



Simply well supplied

Whether you need socket outlets for installing in VDE, UL, CEI or CEE distribution boards or power supply units – our electrical installation technology offers you a complete program.

Short-circuit-proof transformers and power supply units with different voltage and power ratings fulfill every requirement for safety extra-low voltage systems.

Transformers, Power Supply Units and Socket Outlets



All the information you need	12/2
System overview	12/4
Transformers	12/6
4AC32 bell transformer	12/6
4AC37 safety transformer	12/8
Power supply units	12/10
4AC2 electronic power supply unit	12/10
Socket outlets	12/12
5TE6 socket outlet for modular installation devices	12/12

A multitude of additional information ...

Information + ordering

All the important things at a glance

For information about transformers, power supply units and socket outlets, please visit our website www.siemens.com/lowvoltage

Your product in detail

The relevant tender specifications can be found at www.siemens.com/tenderspecifications

Use our conversion tool for quick and easy conversion to Siemens products www.siemens.com/conversion-tool

Everything you need for your order

Refer to SiePortal to find an overview of your products (product catalog)

- Transformers, power supply units and socket outlets sie.ag/2mmSHHu

Direct forwarding to the individual products in SiePortal by clicking on the article number in the catalog or entering this web address incl. article number www.siemens.com/product_catalog_SIEP?Article No.

The fast track to the experts

Contact persons in your region

We offer a comprehensive portfolio of services. You can find your local contacts at www.siemens.com/lowvoltage/components/contact

You will find further information on services at www.siemens.com/service-offers

Competent expert advice on technical questions with a wide range of demand-optimized services for all our products and systems.

Assistance with technical queries is provided at www.siemens.com/support-request

... can be found in our online services

Commissioning + operation

Your product in detail

The SiePortal platform (knowledge base) provides detailed technical information
www.siemens.com/lowvoltage/product-support

- Operating instructions
- Certificates

Online Support app available for download from the [App Store](#) and [Play Store](#)
You will find further information at
www.siemens.com/support-app

Provision of 3D data (step and u3d data formats)

- SiePortal (product catalog)
www.siemens.com/lowvoltage/product-catalog
- Image database
www.siemens.com/lowvoltage/picturedb

Engineering data for CAD or CAE systems are available in the CAX Download Manager at
www.siemens.com/cax

Manuals

Manuals can be found in SiePortal at
www.siemens.com/lowvoltage/manuals

- Configuration Manual
 - Transformers, power supply units and socket outlets
[\(45315886\)](#)

Technical overview – Transformers, power supply units and socket outlets



The fast way to get you to our online services

This page provides you with comprehensive information and links on transformers, power supply units and socket outlets

www.siemens.com/lowvoltage/product-support (109778781)

System overview

Transformers



4AC32 bell transformers



4AC37 safety transformers

Power supply units



4AC2 electronic power supply units

Socket outlets



5TE6 socket outlet for modular installation devices

Note:

You will find a detailed range of accessories with the basic units.

Accessories



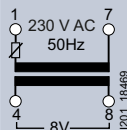
Hinged lid

4AC32 bell transformer

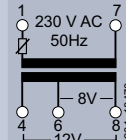
U_e 230 V AC



Mounting width 2 MW



2 MW



Rated secondary current I_{sec} AC
at rated secondary voltage U_{sec} AC

8 V	12 V	24 V
1.0 A	–	–
	0.6 A	–
2.0 A	1.3 A	0.6 A
	1.5 A	–

Rated operational power P_s

8 VA	8 VA
4AC3208-0	–
–	4AC3208-1
–	–
–	–

Further technical specifications

4AC3208-0

4AC3208-1

4AC3214-0

4AC3218-0

Standards

Standards EN 61558-1, EN 61558-2-8

Supply

Rated operational voltage U_e 230 V AC

Primary operating range at 50 Hz $1.04 \times U_e$

Rated frequency 50 Hz

Rated power dissipation P_v	In no-load operation	1.2 W		1.3 W		
		At a rated voltage of 8 V	5.7 W		10.5 W	8.1 W
		At a rated voltage of 12 V	–	3.8 W	7.4 W	8.4 W
		At a rated voltage of 24 V	–		4.2 W	–

Safety

Safe separation Creepage distances and clearances > 6 mm

Insulation class E

Test voltage (50 Hz, 1 s) Primary against secondary winding 4 kV

Connection

Conductor cross-section Rigid $1 \times 4 \text{ mm}^2$ or $2 \times 2.5 \text{ mm}^2$

Flexible, with end sleeve $1 \times 2.5 \text{ mm}^2$ or $2 \times 1.5 \text{ mm}^2$

Ambient conditions

Permissible ambient temperature 40 °C 35 °C 40 °C

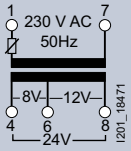
Permissible humidity 91%

Degree of protection Acc. to EN 60629 IP20

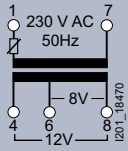
Protection class Acc. to EN 61140 (VDE 0140-1) II



2 MW



2 MW



14 VA

-
-
4AC3214-0
-

18 VA

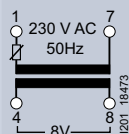
-
-
-
4AC3218-0

4AC37 safety transformer

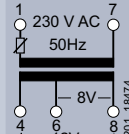
U_e 230 V AC



Mounting width 2 MW



3 MW



Rated secondary current I_{sec} AC
at rated secondary voltage U_{sec} AC

8 V	12 V	16 V	24 V	32 V
2.0 A	–	–	–	–
–	2.0 A	–	–	–
–	3.3 A	2.5 A	1.6 A	1.2 A
–	–	–	1.6 A	–
–	5.2 A	–	2.6 A	–

Rated operational power P_s

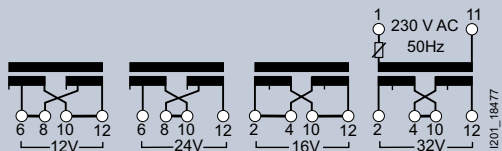
16 VA	24 VA
4AC3716-0	–
–	4AC3724-0
–	–
–	–

Further technical specifications

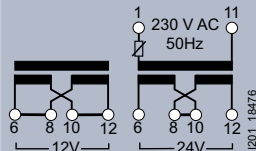
	4AC3716-0	4AC3724-0	4AC3740-0	4AC3740-1	4AC3763-0	
Standards						
Standards	EN 61558-1, EN 61558-2-6					
Supply						
Rated operational voltage U_e	230 V AC					
Primary operating range at 50 Hz	$1.04 \times U_e$					
Rated frequency	50 Hz					
Rated power dissipation P_v	In no-load operation	1.1 W	–	3.5 W	3.9 W	
	At a rated voltage of 8 V	6.8 W	4.6 W	–	–	
	At a rated voltage of 12 V	–	7.6 W	7.1 W	7.5 W	13.2 W
	At a rated voltage of 16 V	–	–	–	7.7 W	–
	At a rated voltage of 24 V	–	–	7.7 W	8.1 W	13.5 W
	At a rated voltage of 32 V	–	–	–	7.6 W	–
Safety						
Safe separation	Creepage distances and clearances		> 6 mm			
Insulation class	E		F			
Test voltage (50 Hz, 1 s)	Primary against secondary winding		4 kV			
Connection						
Conductor cross-section	Rigid		$1 \times 4 \text{ mm}^2$ or $2 \times 2.5 \text{ mm}^2$			
	Flexible, with end sleeve		$1 \times 2.5 \text{ mm}^2$ or $2 \times 1.5 \text{ mm}^2$			
Ambient conditions						
Permissible ambient temperature	25 °C					
Permissible humidity	91%					
Degree of protection	Acc. to EN 60629		IP20			
Protection class	Acc. to EN 61140 (VDE 0140-1)		II			



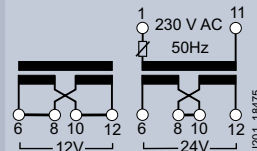
5 MW



5 MW



5 MW



40 VA

-
-
- 4AC3740-1
-
-

40 VA

-
-
- 4AC3740-0
-
-

63 VA

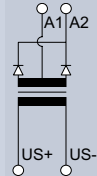
-
-
-
- 4AC3763-0
-

4AC2 electronic power supply unit

SELV, short-circuit-proof



Mounting width 2 MW



Rated operational voltage U_e		Rated secondary voltage U_{sec} DC	Rated secondary current I_{sec} DC	Rated operational power P_s	4AC2402
AC	DC				
85 ... 265 V	85 ... 300 V	24 ±5% V	0.35 A	8.4 W	

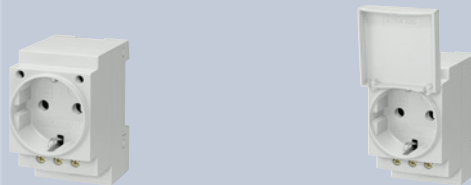
Further technical specifications

Standards		
Standards		EN 60068-2, EN 61558-1, EN 61000-4
Approvals		–
Supply		
Primary operating range	At 50/60 Hz	–
Rated frequency		50/60 Hz
Operating frequency range		–
Rated power dissipation P_v	In no-load operation	–
	At rated load	–
Safety		
Current limitation		Electronic overload protection
Residual ripple		< 100 mV
Hum-free	Core molded	–
Safe separation, creepage distances and clearances		> 5.5 mm
Insulation class		–
Test voltage (50 Hz, 1 min)	Primary against secondary winding	–
Insulation resistance		4 kV
Rated impulse withstand voltage/Degree of pollution	Acc. to IEC 60664-1	6 kV/2
Static discharge	Acc. to IEC/EN 61000-4-2	8 kV
RF irradiation	Acc. to IEC/EN 61000-4-3	10 V/m
Transient overvoltage (burst)	Acc. to IEC/EN 61000-4-4	4 kV
Transient overvoltage (surge)	Acc. to IEC/EN 61000-4-5	
	Supply lines A1, A2	1 kV
	A1/A2 and ground	2 kV
RF, conducted disturbance	Acc. to IEC/EN 61000-4-6	10 V
Interference suppression to lower limit class	Acc. to EN 61000-6-3	Complied with
Connection		
Terminals	Screw (slotted-head)	M2.5
	± Screw (Pozidriv)	–
Conductor cross-section	Rigid	0.5 ... 2.5 mm ²
	Flexible, with end sleeve, min.	0.5 ... 1.5 mm ²
Ambient conditions		
Permissible ambient temperature		–20 ... +60 °C
Resistance to climate	Acc. to IEC/EN 60068-1	20/045/04
Resistance to vibrations, frequency 10 ... 55 Hz	Acc. to IEC/EN 60068-2-6	0.35 mm amplitude
Degree of protection	Acc. to EN 60529	IP20, with connected conductors
Protection class	Acc. to EN 61140	II

5TE6 socket outlet for modular installation devices

SCHUKO® socket outlet
DIN VDE 0620-1

Version



Rated operational voltage U_e	Rated operational current I_e	Mounting width
------------------------------------	------------------------------------	----------------

Without hinged lid ¹⁾

125 V AC	15 A	2.5 MW
230 V AC	16 A	2.5 MW

–	5TE6800
–	–

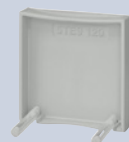
With hinged lid ²⁾

230 V AC	16 A	2.5 MW
----------	------	--------

–	5TE6801
---	---------

Accessories

5TE6 hinged lids for socket outlets



Mounting width	Article No.	Article No.
2.5 MW	5TE9120	–

¹⁾ The hinged lid can be retrofitted on all versions.

²⁾ In distribution boards with 55 mm mounting depth, the socket outlet can only be used without the hinged lid.

³⁾ In system components where equipment is still live even after the main switch has been disconnected, this must be indicated according to EN 50110-1 (VDE 0105-1) and IEC/EN 60204-1/VDE 0113-1. Yellow socket outlets are used for these applications.

12

Further technical specifications

5TE6800
5TE6801
5TE6810

5TE6802

5TE6803

5TE6804

Standards





Standards	VDE 0620-1	CEI 23-50	CEE 7 standard sheet V	UL 498
Approvals	VDE 0620-1	–	–	UL File No. E258598/ CSA C22.2 No. 182.3M


Connection

Terminals	± Screw (Poqidriv)	PZ1
Terminal tightening torque	Max.	0.8 ... 1 Nm
Stripped length		10 mm
Conductor cross-section	Rigid	1.5 ... 6 mm ² (AWG 10 ... 14)
	Flexible, with end sleeve	0.5 ... 4 mm ² (AWG 14)

Ambient conditions

Permissible ambient temperature		–10 ... +55 °C
Degree of protection	Acc. to EN 60529	IP20, with connected conductors
Mounting position	Without hinged lid	Any
	With hinged lid	Horizontally or vertically

	Socket outlets CEE 7 standard sheet V	Socket outlets CEI 23-50	Socket outlets UL 498
Yellow RAL 1018 ³⁾	With grounding pin		
			
-	-	-	5TE6804
5TE6810	5TE6803	-	-
-	-	5TE6802	-
Article No.	Article No.	Article No.	Article No.
-	5TE9120	-	5TE9120



Simplified distribution board design and time-saving assembly

Simplified assembly and connection of electrical power distribution systems and devices ensures that customer requirements can be met more quickly and flexibly.

In addition, installation and plant engineers benefit from a simplified configuration and reduced space requirements in distribution systems and control cabinets.

Our busbar systems for electrical installations offer a particularly easy way of fitting distribution systems with electrotechnical components.

The modular design saves space, while quick assembly contacts ensure fast mounting.

A multitude of additional information ...

Information + ordering

All the important things at a glance

For information about busbar systems, please visit our website www.siemens.com/lowvoltage

Your product in detail

The relevant tender specifications can be found at www.siemens.com/tenderspecifications

Use our conversion tool for quick and easy conversion to Siemens products www.siemens.com/conversion-tool

Everything you need for your order

Refer to SiePortal to find an overview of your products (product catalog)

- Busbar systems sie.ag/2IXoUFI

Direct forwarding to the individual products in SiePortal by clicking on the article number in the catalog or entering this web address incl. article number www.siemens.com/product_catalog_SIEP?Article No.



The fast track to the experts

Contact persons in your region

We offer a comprehensive portfolio of services. You can find your local contacts at www.siemens.com/lowvoltage/components/contact

You will find further information on services at www.siemens.com/service-offers

Competent expert advice on technical questions with a wide range of demand-optimized services for all our products and systems.

Assistance with technical queries is provided at www.siemens.com/support-request

... can be found in our online services

Commissioning + operation

Your product in detail

The SiePortal platform (knowledge base) provides detailed technical information
www.siemens.com/lowvoltage/product-support

- Operating instructions
- Certificates

Online Support app available for download from the [App Store](#) and [Play Store](#)

You will find further information at
www.siemens.com/support-app

Provision of 3D data (step and u3d data formats)

- SiePortal (product catalog)
www.siemens.com/lowvoltage/product-catalog
- Image database
www.siemens.com/lowvoltage/picturedb

Engineering data for CAD or CAE systems are available in the CAx Download Manager at
www.siemens.com/cax

Manuals

Manuals can be found in SiePortal at
www.siemens.com/lowvoltage/manuals

- Configuration Manual
– 8US busbar systems ([109769746](#))

Technical overview – Busbar systems



The fast way to get you to our online services

This page provides you with comprehensive information and links on busbar systems
www.siemens.com/lowvoltage/product-support ([109769087](#))

System overview

1 Basic assemblies



Busbar supports



N/PE busbar supports

Accessories



Flat copper profiles

TT special profiles

Connection pieces

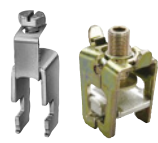
Cover profiles

Blanking covers

2 Infeeds and connection methods



Connection modules



Terminals

Accessories



Covers

3 Built-in components



Bus-mounting fuse bases



Bus-mounting fuse holders



Bus-mounting switch disconnectors

Accessories



Covers

Auxiliary switches

Lateral modules

4 Device adapters



Device adapters



Device holders

Accessories



N/PE modules

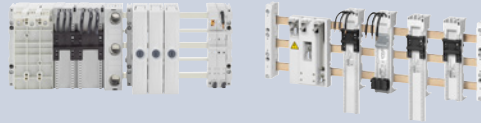
Lateral modules

Vibration & shock kits

Note:

You will find a detailed range of accessories with the basic units.

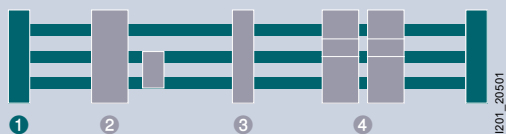
Quick selection guide





		40 mm busbar system	60 mm compact busbar system	60 mm busbar system flat copper profile	60 mm busbar system TT profile
Busbars					
Busbar center-to-center spacing		40 mm	60 mm	60 mm	60 mm
Flat copper profiles	5 mm	12 × 5 mm 15 × 5 mm	12 × 5 mm	12 × 5 mm 15 × 5 mm 20 × 5 mm 25 × 5 mm 30 × 5 mm	–
	10 mm	12 × 10 mm 15 × 10 mm	12 × 10 mm	20 × 10 mm 30 × 10 mm	–
TT special profile		–	–	–	2400 × 30 × 40 mm
Rated values					
Rated operational current	IEC	200 ... 360 A	200 ... 360 A	200 ... 900 A	1020 ... 1600 A
I_e	UL 508	–	300 A	630 A	1400 A
Rated operational voltage	IEC	690 V AC	690 V AC	690 V AC	690 V AC
	UL 508	–	600 V AC	600 V AC	600 V AC
Standards					
IEC		■	■	■	■
UL 508		■	■	■	■
Connection modules and terminals for					
Circular conductors	IEC	–	Cu 1.5 ... 150 mm ²	Cu 1.5 ... 300 mm ² Al 95 ... 300 mm ²	Cu 16 ... 300 mm ²
	UL 508	–	Cu AWG 2 ... MCM 300	Cu AWG 16 ... MCM 600 Al AWG 3	Cu AWG 4 ... MCM 600
Laminated copper		–	Cu lam. 15 ... 20 × 5 ... 10 mm	Cu lam. 3 × 20 × 1 ... 10 × 32 × 1 mm	Cu lam. 2 × 40 × 10 mm
Cable lugs		–	–	Max. 240 mm ²	–
Built-in components for					
NEOZED bus-mounting fuse bases		–	■	■	■
DIAZED bus-mounting fuse bases		–	–	■	■
Bus-mounting fuse holders for cylindrical fuses 10 × 38 mm		–	–	■	■
Class CC bus-mounting fuse holders		–	–	■	■
Class J bus-mounting fuse holders		–	–	■	■
NEOZED bus-mounting switch disconnectors		–	–	■	■
Device adapters for					
Universal application 3P/5P		–	■/■	■/■	■/■
Molded case circuit breakers		–	■	■	■
Switch disconnectors		–	–	■	■
Fuse switch disconnectors		–	–	■	■
SIRIUS 3RM1 motor starters		–	■	–	–
SIRIUS load feeders		–	–	■	■
3RM193 fuse module		–	■	–	–
5SY miniature circuit breakers		–	■	–	–
Further information					
		See page 13/6	See page 13/7	See page 13/12	See page 13/14

1 Basic assemblies



For 40 mm 8US busbar system up to 400 A



		Busbar supports	
		3P	5P
			
Flat copper profiles		Connection	Connection
12 x 5 mm	15 x 5 mm	12 x 10 mm	15 x 10 mm
Rated operational voltage U_e			
		IEC	IEC
Interior mounting		L1–L3	L1–L3 + N + PE/N
■	■	■	■
■	–	■	–
Further information		690 V AC	690 V AC
3NP1 fuse switch disconnectors		IEC	IEC
		8US1903-3AB00 ¹⁾	–
		–	8US1903-5AA00
		See page 8/88	See page 8/88

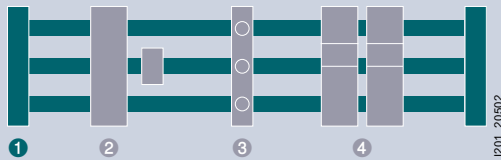
¹⁾ One package contains 2 busbar supports including inlay parts for bar thickness 5 mm and lateral finger-safe covers.

Accessories

		3P	5P
Flat copper profile			
	Surface	Length	Size
	Bare	2400 mm	12 x 5 mm
			15 x 5 mm
			Article No.
			8WC5123
			8WC5121
			–
Cover profiles for busbars			
	Material	Length	Size
	Plastic profile	1000 mm	12 x 5 mm
			15 x 5 mm
			Article No.
			8US1922-2CA00
			8US1922-2AA00
			–

1 Basic assemblies

For 8US compact busbar system up to 360 A (3P) or 200 A (5P)



No. of poles	Busbar supports ¹⁾
3P/5P	

Flat copper profiles		Rated operational voltage U_e		Short-circuit current rating SCCR		Standard	Dimensions	Min. order quantity	Connection
12 × 5 mm	12 × 10 mm	IEC	UL 508	3-pole	5-pole				L1–L3 + N + PE/N
Interior mounting									
■	■	690 V AC	–	54 kA	32 kA	IEC	12 × 160 × 45 mm	10 units	8US1923-5CA02
		–	600 V AC	18 kA	–	UL 508	12 × 160 × 45 mm	10 units	8US1923-5CA02

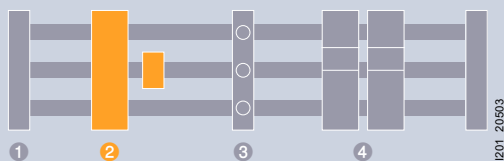
¹⁾ Including end cover

Accessories

Flat copper profiles			
	Surface	Length	Size
	Bare	2400 mm	12 × 5 mm
			Article No.
			8WC5123
UL spacers for busbar supports			
	Dimensions	Minimum order quantity	Height
	12 × 160 × 18 mm	10 units	18 mm
			Article No.
			8US1922-1CA02
Stabilizing modules			
	<ul style="list-style-type: none"> Only for 12 × 5 mm busbars For protecting the N and PE busbars against bending 		
	Dimensions	Minimum order quantity	Article No.
	2 × 160 × 47 mm	10 units	8US1928-5CA02
Cover profiles			
	Dimensions	Minimum order quantity	Article No.
	700 × 160 × 63 mm	2 units	8US1922-2CB02
Holders for 8US1922-2CB02 cover profile			
	Dimensions	Minimum order quantity	Article No.
	5 × 156 × 55 mm	10 units	8US1922-2CA02

② Infeeds and connection methods

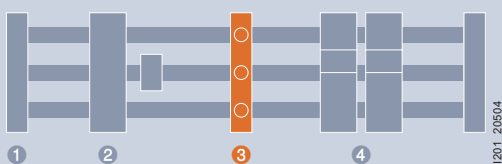
For 8US compact busbar system up to 360 A (3P) or 200 A (5P)



Conductor cross-section	Rated operational current I_e		Rated operational voltage U_e		Rated peak with-stand current IEC I_{pk} max	Standard	Minimum order quantity	Dimensions
	IEC	UL 508	IEC	UL 508				
Spring terminal								
1.5 ... 16 mm ²	63 A	48 A	690 V AC	600 V AC	10 kA	IEC, UL 508	6 units	20 × 160 × 91 mm
Connecting terminal								
6 ... 50 mm ²	175 A	175 A	690 V AC	600 V AC	40.5 kA	IEC, UL 508	1 unit	54 × 160 × 115 mm
10 ... 120 mm ²	250 A	200 A	690 V AC	600 V AC	35.4 kA	IEC, UL 508	1 unit	90 × 160 × 80 mm
			690 V AC	600 V AC	35.1 kA	IEC, UL 508	1 unit	30 × 160 × 80 mm
			690 V AC	600 V AC	35.4 kA	IEC, UL 508	1 unit	30 × 160 × 80 mm
35 ... 150 mm ²	275 A	285 A	690 V AC	600 V AC	45.9 kA	IEC, UL 508	1 unit	90 × 160 × 115 mm

③ Built-in components

For 8US compact busbar systems up to 360 A (3P)



Number of poles
Mounting width

Conductor cross-section	For flat copper profiles		Rated operational current I_e	Rated operational voltage U_e	Standard	Minimum order quantity
	12 × 5 mm	12 × 10 mm				
Box terminals						
Rigid 1.5 ... 10 mm ²	■	■	63 A	400 V AC	IEC	6 units
Flexible 1.5 ... 25 mm ²	■	■				

See NEOZED screw caps, NEOZED adapter sleeves and NEOZED fuse links, from page 7/1 onwards

For 12 × 5 mm and 12 × 10 mm flat copper profiles
For 3-pole system (up to 360 A)



Connection modules

3P

8US1921-1BA02

8US1921-1CB02

–

–

–

8US1921-1CC02

For 5-pole system (up to 200 A)



Connection modules

3P

–

–

8US1921-1CD02

–

–

–



Connection modules

N

–

–

8US1921-1CE02

–

–



Connection modules

PE

–

–

–

8US1921-1CF02

–

NEOZED bus-mounting bases

Size D02

3P

2 MW

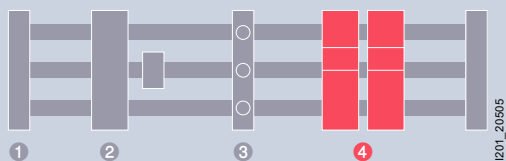


With touch protection

5SG6208

4 Device adapters

For 8US compact busbar system up to 360 A (3P) or 200 A (5P)




For 3-pole system
For universal
applications




Rated operational current I_e	Rated operational voltage U_e		Standard	For flat copper profiles		Adapters			Minimum order quantity		
	IEC	UL 508		IEC	UL 508	12 × 5 mm	12 × 10 mm	Height		Width	Length
16 A	–	690 V AC	–	IEC, UL 508	–	–	160 mm	22.5 mm	122 mm	4 units	–
							200 mm	22.5 mm	122 mm	5 units	–
25 A	–	690 V AC	–	IEC, UL 508	■	–	160 mm	22.5 mm	41.5 mm	5 units	–
							185 mm	22.5 mm	23.5 mm	5 units	–
							200 mm	22.5 mm	41.5 mm	5 units	–
32 A	–	690 V AC	–	IEC	■	–	160 mm	18 mm	73 mm	12 units	–
	25 A	690 V AC	600 V AC	IEC, UL 508	■	■	160 mm	45 mm	63 mm	4 units	8US1651-5DK02
63 A	–	690 V AC	–	IEC	■	–	160 mm	18 mm	73 mm	12 units	–
	65 A	690 V AC	600 V AC	IEC, UL 508	■	■	160 mm	18 mm	82 mm	12 units	–
144 A	–	690 V AC	–	IEC	■	■	160 mm	54 mm	63 mm	4 units	8US1661-5FK02
	–	690 V AC	–	IEC	■	■	160 mm	77 mm	35 mm	1 unit	–

Accessories


N modules

	Rated voltage U_e	Connecting terminal	Dimensions	Minimum order quantity	Article No.
	690 V AC	1.5 ... 16 mm ²	9 × 160 × 114 mm	12 units	–


PE modules

	Rated voltage U_e	Connecting terminal	Dimensions	Minimum order quantity	Article No.
	690 V AC	1.5 ... 16 mm ²	9 × 160 × 114 mm	12 units	–


Support modules






	Dimensions	Minimum order quantity	Article No.
	18 × 160 × 54 mm	6 units	8US1620-5AK02

Lateral modules

	Dimensions	Minimum order quantity	Article No.
	9 × 160 × 47 mm	12 units	8US1998-2BH02

Set of module connectors

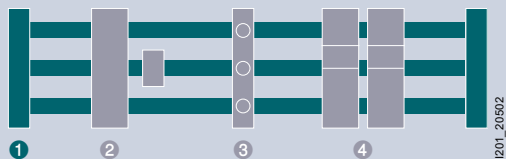
	Use	Package	Article No.
	For connecting adapters	1 pack = 100 units	–

For 3-pole system For 3VA10/11 molded case circuit breakers	For 5-pole system For universal applications	For SIRIUS 3RM1 motor starters and for relays	For 3RM193, 8US1615 and 8US1215 fuse modules	For 55Y miniature circuit breakers
				
With latching function	Adapters, 1-pole	With fuse module and DIN mounting rail	With DIN mounting rail	Adapters, 1-pole
–	–	8US1615-5CK10	–	–
–	–	8US1215-5CS10	–	–
–	–	–	8US1616-0AK02	–
–	–	–	–	8US1716-0RK00
–	–	–	8US1216-0AS00	–
–	8US1621-2NJ02	–	–	–
–	–	–	–	–
–	8US1621-2FK02	–	–	–
–	–	–	–	8US1624-2FK02
–	–	–	–	–
8US1613-4AU01	–	–	–	–

Article No.	Article No.	Article No.	Article No.	Article No.	Article No.
–	8US1600-0RE02	8US1600-0RE02	8US1600-0RE02	8US1600-0RE02	8US1600-0RE02
Article No.	Article No.	Article No.	Article No.	Article No.	Article No.
–	8US1600-0RF02	8US1600-0RF02	8US1600-0RF02	8US1600-0RF02	8US1600-0RF02
Article No.	Article No.	Article No.	Article No.	Article No.	Article No.
8US1620-5AK02	8US1620-5AK02	8US1620-5AK02	8US1620-5AK02	8US1620-5AK02	8US1620-5AK02
Article No.	Article No.	Article No.	Article No.	Article No.	Article No.
8US1998-2BH02	8US1998-2BH02	8US1998-2BH02	8US1998-2BH02	8US1998-2BH02	8US1998-2BH02
Article No.	Article No.	Article No.	Article No.	Article No.	Article No.
–	8US1998-1AA02	8US1998-1AA02	8US1998-1AA02	8US1998-1AA02	8US1998-1AA02

1 Basic assemblies

Up to 630 A







Flat copper profiles							Standard
12×5 mm	15×5 mm	20×5 mm	25×5 mm	30×5 mm	20×10 mm	30×10 mm	
Interior mounting							
■	■	■	■	■	■	■	IEC 61439-1
–	–	■	–	–	■	■	IEC 61439-1, UL 508 ¹⁾
■	■	■	■	■	■	■	IEC 61439-1
■	–	■	–	■	■	■	IEC 61439-1
■	■	■	■	■	■	■	IEC 61439-1, UL 508
Exterior mounting							
■	■	■	■	■	■	■	IEC 61439-1
■	■	■	■	■	■	■	IEC 61439-1

¹⁾ Only with base plate 8US1922-2UA01

Accessories


Flat copper profile							
	Surface	Length	Size	Rated operational current	Cross-section	Standard	Article No.
	Bare	1100 mm	25×5 mm	400 A	125 mm ²	EN 12167	8WC5031-1AA00
			30×5 mm	447 A	150 mm ²	EN 12167	8WC5033-1AA00
	2400 mm		12×5 mm	200 A	60 mm ²	EN 12167	8WC5123
			15×5 mm	250 A	75 mm ²	EN 12167	8WC5121
			20×5 mm	320 A	100 mm ²	EN 12167	8WC5126
			25×5 mm	400 A	125 mm ²	EN 12167	8WC5131
			30×5 mm	447 A	150 mm ²	EN 12167	8WC5133
			20×10 mm	520 A	200 mm ²	EN 12167	8WC5128
			30×10 mm	630 A	300 mm ²	EN 12167	8WC5134
			Tin-coated	2000 mm	12×5 mm	200 A	60 mm ²
15×5 mm	250 A	75 mm ²			EN 12167	8WC5052	
20×5 mm	320 A	100 mm ²			EN 12167	8WC5053	
25×5 mm	400 A	125 mm ²			EN 12167	8WC5054	
30×5 mm	447 A	150 mm ²			EN 12167	8WC5055	
20×10 mm	520 A	200 mm ²			EN 12167	8WC5063	
30×10 mm	630 A	300 mm ²			EN 12167	8WC5065	
End covers							
	• For covering free busbar ends						
	For connection		For busbar support			Standard	Article No.
	L1–L3		8US1923-2AA01, 8US1923-3AA01, 8US1923-3UA01			IEC, UL 508	8US1922-1AC00
	L1–L3 + PE/N		8US1923-4AA00			IEC	8US1922-1AB00

No. of poles	End and intermediate supports			N/PE busbar supports
	3P	2P	4P	1P
				
	Connection L1–L3	Connection L1/L2/L3/PE/N	Connection L1–L3 + PE/N	Connection PE/N
	8US1923-3AA01	–	–	–
	8US1923-3UA01	–	–	–
	–	–	8US1923-4AA00	–
	–	–	–	5SH3540
	–	–	–	8US1923-1AA01
	8US1923-2AA01	–	–	–
	–	8US1923-5AA00	–	–


Cover profiles for busbars

	Length	Width	Depth	Flat copper profile size	Standard	Article No.
	1000 mm	15 mm	10 mm	12 × 5 mm	UL 508	8US1922-2CA00
		40 mm	9 mm	15, 20, 25, 30 × 5 mm	UL 508	8US1922-2AA00
		40 mm	14 mm	12, 15, 20, 25, 30 × 10 mm	UL 508	8US1922-2BA00

Blanking covers

	Length	Height	Depth	Standard	Article No.
	700 mm	195 mm	63 mm	UL 508	8US1922-2EB00


Supports for blanking covers

	Depth	Standard	Article No.
	32 mm	UL 508	8US1922-2EA00
	107 mm	UL 508	8US1922-2EA01

Base plates

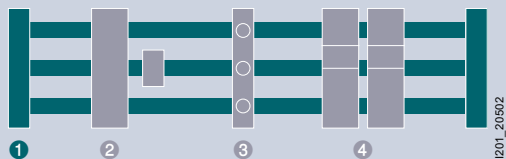
	Version	Length	Width	Standard	Article No.
	For 3-pole system	1100 mm	240 mm	UL 508	8US1922-2UA01

Connecting piece for flat copper profiles

	Length	For flat copper profiles	Article No.
	40 mm	20 × 5 mm, 25 × 5 mm, 30 × 5 mm, 20 × 10 mm, 25 × 10 mm, 30 × 10 mm	8US1921-2BE00
55 mm	12 × 5 mm, 15 × 5 mm, 20 × 5 mm 12 × 10 mm, 15 × 10 mm, 20 × 10 mm	8US1921-2BF00	

1 Basic assemblies

Up to 1600 A




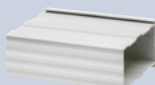



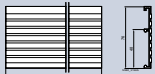
Copper profile	Rated operational current I_e		Rated operational voltage U_e		Short-circuit current rating SCCR		Standard	Connection
	IEC	UL 508	IEC	UL 508	IEC	UL 508		
Interior mounting								
TT special profile	1600 A	1400 A	690 V AC	600 V AC	90 kA	100 kA	IEC, UL 508	8US1943-3AA00
1 pack = 2 busbar supports + finger-safe end covers								

Busbar supports

No. of poles 3P

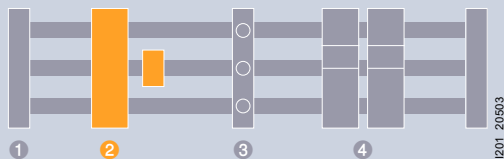


Accessories

TT special copper profile						
	Surface	Length	Rated operational current	Rated operational voltage	Cross-section	Article No.
		Tin-coated	2400 mm	1600 A	690 V AC	720 mm ²
Cover profile for TT special copper profile						
	Length					Article No.
	1000 mm					8US1922-2DA00
Blanking covers						
	Length	Height	Depth	Standard	Article No.	
	700 mm	195 mm	63 mm	UL 508	8US1922-2EB00	
Supports for blanking covers						
	Depth			Standard	Article No.	
	32 mm			UL 508	8US1922-2EA00	
	107 mm			UL 508	8US1922-2EA01	
Connecting piece for TT special profile						
						Article No.
						8US1941-2BF01
Partitions, closed						
	• For additional lateral touch protection at the top/bottom					Article No.
	Length	Depth			8US1922-1JA00	
2400 mm		76 mm				

② Infeeds and connection methods

Up to 1600 A



Conductor cross-section, circular conductor		Conductor cross-section, laminated copper	Rated operational current I_e		Rated operational voltage U_e		Standard	Length
IEC	UL 508		IEC	UL 508	IEC	UL 508		
With cover								
Cu 1.5 ... 16 mm ²	Cu AWG 16 ... 4	Cu lam. 8 × 6 × 0.5 mm	63 A	48 A	690 V AC	600 V AC	IEC, UL 508	200 mm
Cu 6 ... 50 mm ²	Cu AWG 10 ... 2	–	175 A	175 A	690 V AC	600 V AC	IEC, UL 508	200 mm
Cu 25 ... 120 mm ²	Cu AWG 6 ... MCM 250	–	250 A	250 A	690 V AC	600 V AC	IEC, UL 508	200 mm
Cu 95 ... 300 mm ² Al 120 ... 240 mm ²	AWG 3/0 ... MCM 600	–	500 A	420 A	690 V AC	–	IEC, UL 508	200 mm
Without cover								
Cu 95 ... 300 mm ²	AWG 3/0 ... MCM 600	–	500 A	420 A	690 V AC	600 V AC	IEC, UL 508	184 mm
–	–	Cu lam. 3 × 20 × 1 ... 10 × 32 × 1 mm	550 A	420 A	690 V AC	600 V AC	IEC, UL 508	184 mm
For 4th pole (PE/N) ²⁾								
Cu 1.5 ... 16 mm ²	–	–	–	–	690 V AC	600 V AC	IEC, UL 508	242 mm

¹⁾ Shown without cover

²⁾ For mounting on device adapter or device holder

Accessories

Cover for connection module



Connection modules
 For 5 mm and 10 mm flat copper profiles For 5 mm and 10 mm flat copper profiles and TT special profile For laminated copper

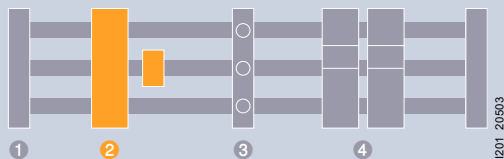


Width	Connection modules	Connection modules	Connection modules	Connection modules	Connection modules
	3P	3P	3P	PE/N	3P
20 mm	5SH3538	–	–	–	–
54 mm	–	–	8US1921-1BA00	–	–
81 mm	–	–	8US1921-1AA00	–	–
135 mm	–	5SH3535 ¹⁾	–	–	–
153 mm	–	–	–	–	8US1941-2AA03
153 mm	–	–	–	–	8US1941-2AA04
18 mm	–	–	–	8US1200-0AA00	–

Article No.	Article No.	Article No.	Article No.	Article No.
–	–	–	–	8US1922-1GC00

② Infeeds and connection methods

Up to 1600 A



Conductor cross-section, circular conductor		Conductor cross-section, laminated copper	Rated operational current I_e		Rated operational voltage U_e		Standard	Minimum order quantity
IEC	UL 508		IEC	UL 508	IEC	UL 508		
Cu 1.5 ... 16 mm ²	AWG 16 .. 6	Cu lam. 8×6×0.5 mm	65 A	55 A	690 V AC	600 V AC	IEC, UL 508	15 units 100 units
Cu 4 ... 35 mm ²	AWG 10 ... 2	Cu lam. 3×9×0.8 mm, Cu lam. 6×9×0.8 mm	115 A	115 A	690 V AC	600 V AC	IEC, UL 508	15 units 50 units
Cu 16 ... 70 mm ²	AWG 4 ... 2/0	Cu lam. 2×9×0.8 mm, Cu lam. 6×9×0.8 mm, Cu lam. 6×13×0.5 mm	175 A	175 A	690 V AC	600 V AC	IEC, UL 508	15 units 50 units
Cu 16 ... 120 mm ²	AWG 4 ... MCM 250	Cu lam. 4×15.5×0.8 mm, Cu lam. 6×15.5×0.8 mm, Cu lam. 10×15.5×0.5 mm	250 A	255 A	690 V AC	600 V AC	IEC, UL 508	15 units 50 units

¹⁾ Finely stranded, directly clamped or with end sleeve, solid and stranded circular conductor

Accessories

Terminal covers for circular conductors

- Fixing to busbar

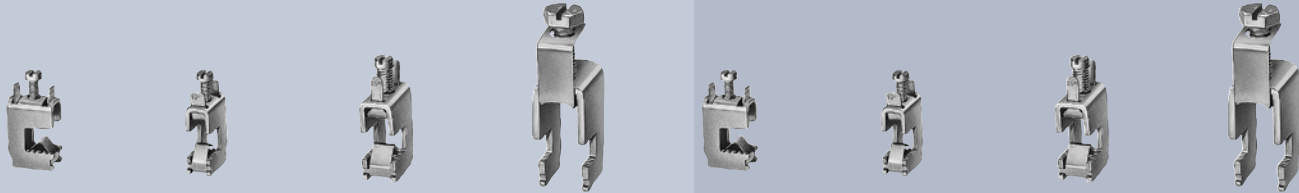


Length	Width
200 mm	84 mm

Terminals¹⁾

For 12 × 5 mm, 15 × 5 mm, 20 × 5 mm, 25 × 5 mm and 30 × 5 mm flat copper profiles

For 12 × 10 mm, 15 × 10 mm, 20 × 10 mm, 25 × 10 mm and 30 × 10 mm flat copper profiles and TT special profile

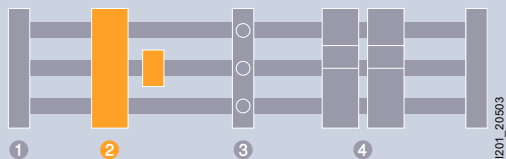


8US1921-2AA01	–	–	–	8US1921-2BA01	–	–	–
8US1921-2AA00	–	–	–	8US1921-2BA00	–	–	–
–	8US1921-2AB01	–	–	–	8US1921-2BB01	–	–
–	8US1921-2AB00	–	–	–	8US1921-2BB00	–	–
–	–	8US1921-2AD01	–	–	–	8US1921-2BD01	–
–	–	8US1921-2AD00	–	–	–	8US1921-2BD00	–
–	–	–	8US1921-2AC01	–	–	–	8US1921-2BC01
–	–	–	8US1921-2AC00	–	–	–	8US1921-2BC00

Article No.	Article No.	Article No.	Article No.	Article No.	Article No.	Article No.	Article No.
8US1922-1GA00	8US1922-1GA00	8US1922-1GA00	8US1922-1GA00	8US1922-1GA00	8US1922-1GA00	8US1922-1GA00	8US1922-1GA00

② Infeeds and connection methods

Up to 1600 A



Conductor cross-section, circular conductor		Conductor cross-section, laminated copper	Conductor cross-section, cable lugs	Rated operational current I_e		Rated operational voltage U_e		Standard
IEC	UL 508			IEC	UL 508	IEC	UL 508	
Cu 95 ... 185 mm ² Al 95 ... 185 mm ²	AWG 3/0 ... MCM 350	–	–	300 A	310 A	690 V AC	600 V AC	IEC, UL 508
Cu 95 ... 300 mm ² Al 120 ... 140 mm ²	AWG 3/0 ... MCM 600	–	–	500 A	420 A	690 V AC	600 V AC	IEC, UL 508
–	–	Cu lam. 3 × 20 × 1 ... 10 × 24 × 1 mm	–	500 A	420 A	690 V AC	600 V AC	IEC, UL 508
–	–	Cu lam. 2 × 40 × 10 mm	–	1250 A	–	690 V AC	–	IEC
–	–	–	Max. 240 mm ²	630 A	–	690 V AC	–	IEC

Accessories

Terminal covers for circular conductors

- Fixing to busbar



Length	Width
200 mm	270 mm



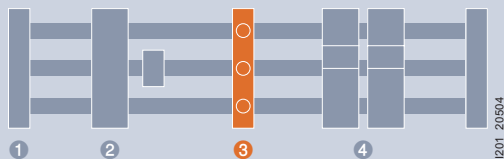
Mounting

–	8US1941-2AA01	–	–	–	–
–	8US1941-2AA02	–	–	–	–
M16 threaded pin, size 8 Allen key	–	8US1941-2BB00	–	8US1941-2BB00	–
M16 threaded pin, size 8 Allen key	–	–	–	–	8US1941-2BA00
M16 threaded pin, size 8 Allen key, M10 hexagon bolt, width across flats 17	–	–	8US1941-2AC00	–	–

Article No.	Article No.	Article No.	Article No.	Article No.
8US1922-1GA02	8US1922-1GA02	8US1922-1GA02	8US1922-1GA02	8US1922-1GA02

③ Built-in components

Up to 630 A



NEOZED bus-mounting fuse bases Size D02

Mounting width

1.5 MW

1.5 MW

2 MW



For flat copper profiles	Rated operational current I_e		Rated operational voltage U_e			Standard	Standard		With touch protection	
	IEC	UL 508	IEC AC	IEC DC	UL		Standard	With touch protection		
Box terminals										
5 mm and 10 mm	25 A	–	500 V AC	–	–	IEC	–	–	–	
	63 A	–	400 V AC	250 V DC	–	IEC	5SG6202 ¹⁾	5SG6206 ¹⁾	5SG6207	
			690 V AC	–	–	IEC	–	–	–	
	–	30 A	–	690 V AC	–	600 V AC	IEC,	–	–	–
				–	–	600 V AC		–	–	–
				–	–	600 V AC		–	–	–
–				–	600 V AC		–	–	–	
–	–	–	–	600 V AC		–	–	–		

Further information

3NP1 fuse switch disconnectors

[See page 8/88](#)

[See page 8/88](#)

[See page 8/88](#)

¹⁾From 35 A continuous current load, mount the fuse base with spacing and use a wider cover

Note:

NEOZED adapter sleeves or DIAZED screw adapters are required for NEOZED and DIAZED bus-mounting fuse bases.

13








Accessories

NEOZED covers for standard version

	Size	Version	Mounting width	Article No.	Article No.	Article No.
	D02	Standard	1.5 MW	5SH5241	–	–
		Extra wide	2 MW	5SH5242	–	–
		With double width	3 MW	5SH5243	–	–

DIAZED covers for standard version

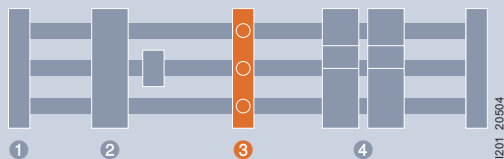
	Size	Mounting width	Article No.	Article No.	Article No.
	DII	2.3 MW	–	–	–
	DIII	3.2 MW	–	–	–

DIAZED bus-mounting fuse bases		Bus-mounting fuse holders				
Size DII	Size DIII	Cylindrical fuses 10×38 mm	Class CC	Class J		
2.3 MW	3.2 MW	1.5 MW	1.5 MW	106 mm	184 mm	256 mm
						
Standard	With touch protection			3P	3P	3P
5SF6015	5SF6020	–	–	–	–	–
–	–	–	–	–	–	–
5SF6215	5SF6220	–	–	–	–	–
–	–	3NW7431	–	–	–	–
–	–	–	3NW7431-0HG	–	–	–
–	–	–	–	3NW7431-6HG	–	–
–	–	–	–	–	3NW7431-7HG	–
–	–	–	–	–	–	3NW7431-8HG
See page 8/88	See page 8/88	See page 8/88	See page 8/88	See page 8/88	See page 8/88	See page 8/88

Article No.	Article No.	Article No.	Article No.	Article No.	Article No.	Article No.
–	–	–	–	–	–	–
–	–	–	–	–	–	–
–	–	–	–	–	–	–
Article No.	Article No.	Article No.	Article No.	Article No.	Article No.	Article No.
5SH2042	–	–	–	–	–	–
5SH2242	–	–	–	–	–	–

③ Built-in components

Up to 630 A



NEOZED bus-mounting switch disconnectors Size D02

Mounting width

1.5 MW

1.5 MW

1.5 MW



For flat copper profiles	Rated operational current I_e		Rated operational voltage U_e			Standard	Without LED signal detector		With LED signal detector
	IEC	UL 508	IEC AC	IEC DC	UL 508				
Box terminals									
5 mm, 10 mm	63 A	–	400 V AC	–	–	IEC	5SG7234-1 ²⁾	–	5SG7234-2 ²⁾
				110 V DC	–	IEC	–	5SG7230 ¹⁾	–

¹⁾ From 35 A current load use 5SH5526 lateral module

²⁾ From 35 A current load use 5SH5533 lateral module

Note:

NEOZED adapter sleeves or DIAZED screw adapters are required for NEOZED and DIAZED bus-mounting fuse bases.

Accessories

Auxiliary switches



- For signaling the switching state for bus-mounting switch disconnectors

Contacts	Mounting width	Article No.	Article No.	Article No.
1 CO	0.5 MW	–	5SH5525	–

Lateral modules



- For greater heat dissipation for loads from 35 A

Mounting width	Article No.	Article No.	Article No.
0.5 MW	5SH5533	5SH5526	5SH5533

Reducers

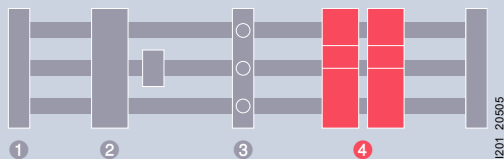


- For NEOZED D01 fuse links in bus-mounting switch disconnectors

Article No.	Article No.	Article No.
–	5SH5527	–

4 Device adapters and device holders

For universal application up to 1600 A



Rated operational current I_e		Rated operational voltage U_e		Standard	For copper profiles	Adapters		Connecting cable		
IEC	UL 508	IEC	UL 508			Width	Height	Cross-section	Max. temperature	Length
25 A	25 A	690 V AC	600 V AC	IEC, UL 508	5 mm, 10 mm, TT profile	45 mm	200 mm	AWG 12	150 °C	99 mm
								167 mm		
32 A	32 A	690 V AC	600 V AC	IEC, UL 508	5 mm, 10 mm, TT profile	45 mm	200 mm	AWG 12	150 °C	99 mm
								167 mm		
								AWG 10	105 °C	118 mm
								150 °C	99 mm	
80 A	80 A	690 V AC	600 V AC	IEC, UL 508	5 mm, 10 mm, TT profile	54 mm	200 mm	AWG 10	150 °C	167 mm
								99 mm		
								AWG 10	150 °C	99 mm
								167 mm		
100 A	100 A	690 V AC	600 V AC	IEC, UL 508	5 mm, 10 mm, TT profile	72 mm	200 mm	AWG 4	150 °C	150 mm
								150 °C	150 mm	
								150 °C	150 mm	
-	-	-	-	-	5 mm, 10 mm, TT profile	45 mm	200 mm	-	-	-
								-	-	-
								260 mm	-	-

13

Accessories

Lateral modules



- For extending device adapters and device holders of the same length

Length	Width
200 mm	9 mm

Device adapters For plug-in units		Device adapters with connecting cables For contact with busbars					Device holders No electrical contact		
									For lateral mounting on device adapter
-	8US1251-5DS10	-	-	-	-	-	-	-	-
-	8US1251-5DS11	-	-	-	-	-	-	-	-
-	8US1251-5DT10	-	-	-	-	-	-	-	-
-	8US1251-5DT11	-	-	-	-	-	-	-	-
-	-	8US1211-1NS10	-	-	-	-	-	-	-
-	-	-	8US1251-5NS10	-	-	-	-	-	-
-	-	-	8US1251-5NS11	-	-	-	-	-	-
8US1216-5AS80	-	-	-	-	-	-	-	-	-
-	-	-	8US1251-5NT10	-	-	-	-	-	-
-	-	-	8US1251-5NT11	-	-	-	-	-	-
8US1216-5AT80	-	-	-	-	-	-	-	-	-
-	-	-	-	8US1261-5MS13	-	-	-	-	-
-	-	-	-	8US1261-6MT10	-	-	-	-	-
-	-	-	-	-	-	8US1211-6MT10	-	-	-
-	-	-	-	-	8US1211-4TR00	-	-	-	-
-	-	-	-	-	-	-	-	8US1250-1AA10	-
-	-	-	-	-	-	-	8US1250-5AS10	-	-
-	-	-	-	-	-	-	8US1250-5AT10	-	-


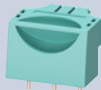
Article No.	Article No.	Article No.	Article No.	Article No.	Article No.	Article No.	Article No.	Article No.
8US1998-2BJ10	8US1998-2BJ10	8US1998-2BJ10	8US1998-2BJ10	8US1998-2BJ10	-	-	8US1998-2BJ10	-

4 Device adapters and device holders


For universal application up to 1600 A

Accessories

Plug-in connectors to make contact with the 3RV2 motor starter protectors for 8US1216-5AS80 and 8US1216-5AT80

	Use	Version	Size	Article No.
	For spring-loaded terminals	Single-unit packaging	S00 ¹⁾	3RV2917-5AA00
			S0 ²⁾	3RV2927-5AA00
		Multi-unit packaging	S00 ¹⁾	3RV2917-5A
			S0 ²⁾	3RV2927-5A
	For screw terminals	Single-unit packaging	S00 ^{1) 3)}	3RV2917-5CA00
			S0 ^{2) 4)}	3RV1927-5AA00
		Multi-unit packaging	S00 ^{1) 3)}	3RV2917-5C
			S0 ^{2) 4)}	3RV1927-5A

Plug-in connectors to make contact with the 3RV1011 motor starter protectors

	Use	Version	Size	Article No.
	For screw terminals	Single-unit packaging	S00	3RV1917-5CA00
		Multi-unit packaging	S00	3RV1917-5C

¹⁾ $I > 14$ A, please note derating.

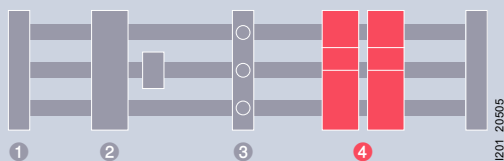
²⁾ $I > 16$ A, please note derating.

³⁾ The plug-in connector cannot be used for the 3RV2711 and 3RV2811 circuit breakers with size S00.

⁴⁾ The plug-in connector can be used for the 3RV2711, 3RV2811 (size S00) and 3RV2721, 3RV2821 (size S0) circuit breakers.

4 Device adapters and device holders

For molded case circuit breakers and switch disconnectors up to 1600 A



Rated operational current I_e		Rated operational voltage U_e		Standard	For copper profile	Adapters		Connecting cable
IEC	UL 508	IEC	UL 508			Length	Width	
Screw terminals								
80 A	80 A	–	600 V AC	UL 508	5 mm, 10 mm, TT profile	200 mm	81 mm	AWG 4
125 A	125 A	690 V AC	600 V AC	IEC, UL 508	5 mm, 10 mm, TT profile	200 mm	90 mm	Cu laminated 6 × 9 × 0.8 mm
Busbar contact								
144 A	–	690 V AC	–	IEC	5 mm, 10 mm, TT profile	200 mm	76 mm	–
160 A	–	690 V AC	–	IEC	5 mm, 10 mm, TT profile	175 mm	108 mm	–
250 A	–	690 V AC	–	IEC	5 mm, 10 mm, TT profile	175 mm	108 mm	–
Tubular contacts								
150 A	150 A	690 V AC	600 V AC	IEC, UL 508	5 mm, 10 mm, TT profile	190 mm	105 mm	–
250 A	250 A	690 V AC	600 V AC	IEC, UL 508	5 mm, 10 mm, TT profile	190 mm	105 mm	–
						240 mm	105 mm	–
	–	690 V AC	–	IEC	5 mm, 10 mm, TT profile	270 mm	140 mm	–
400 A	400 A	690 V AC	600 V AC	IEC, UL 508	5 mm, 10 mm, TT profile	296 mm	140 mm	–
540 A	540 A	690 V AC	600 V AC	IEC, UL 508	5 mm, 10 mm, TT profile	296 mm	140 mm	–
580 A	–	690 V AC	–	IEC	5 mm, 10 mm, TT profile	325 mm	184 mm	–
590 A	600 A	690 V AC	600 V AC	IEC, UL 508	5 mm, 10 mm, TT profile	300 mm	140 mm	–
	–	690 V AC	–	IEC	5 mm, 10 mm, TT profile	300 mm	185 mm	–
M10 pin connector								
400 A	–	690 V AC	–	IEC	5 mm, 10 mm, TT profile	320 mm	184 mm	–
630 A	630 A	690 V AC	600 V AC	IEC, UL 508	5 mm, 10 mm, TT profile	320 mm	250 mm	–
	–	690 V AC	–	IEC	5 mm, 10 mm, TT profile	320 mm	184 mm	–
						320 mm	250 mm	–

¹⁾ Observe the short-circuit strength of the busbar system: Short-circuit strength > 50 kA on request.

²⁾ Usable only for 3VL circuit breakers with line-side box terminals.

³⁾ Only for 3VL 250 A circuit breakers, for screw fixing with metric thread, for flat terminals.

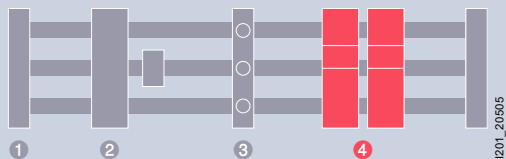
⁴⁾ Without connecting cables. The connecting cable between adapter and device should be manufactured in accordance with the rated operational current as a circular conductor, e.g. H07V-R with cable lug, or as a flat conductor for an M10 pin connector.

⁵⁾ Without connecting cables. The connecting cable between adapter and device should be manufactured in accordance with the rated operational current as a circular conductor, e.g. H07V-R, bared at both ends for tunnel terminals.

Device	Device adapters					
	For molded case circuit breakers		For switch disconnectors		For fuse switch disconnectors	
Size/type	3VA	3VL ¹⁾	3KA and 3KL	3NP5		
						
	3-pole	4-pole	3-pole	3-pole	3-pole	
NGG, HGG, LGG	8US1240-5MA00	–	–	–	–	–
3VA10, 3VA11, 3VA51, NGG, HGG, LGG (connection at top)	8US1211-4SS00	–	–	–	–	–
3VA10, 3VA11, 3VA51 (connection at bottom)	8US1215-4SS00	–	–	–	–	–
3VA10, 3VA11	8US1213-4AU01	–	–	–	–	–
3VL1 ²⁾ , 3VL2 ²⁾	–	–	8US1211-4SL01	–	–	–
3NP5060 (NH00)	–	–	–	–	–	8US1291-4SB00
3VL3 ³⁾	–	–	8US1211-4SL00	–	–	–
VL150X UL, CG frame	–	–	8US1213-4AQ01	–	–	–
VL150 UL, DG frame	–	–	8US1213-4AQ03	–	–	–
VL250 UL, FG frame	–	–	8US1213-4AQ03	–	–	–
3VA12, 3VA20, 3VA21, 3VA22, 3VA52, 3VA61, 3VA62	8US1213-4AP03	–	–	–	–	–
3VA12, 3VA20, 3VA21, 3VA22	–	8US1313-4AH03	–	–	–	–
VL400 UL, JG frame	–	–	8US1213-4AH00	–	–	–
VL400X UL, LG frame	–	–	8US1213-4AH00	–	–	–
3VL5	–	–	8US1213-4AF00	–	–	–
3VA13, 3VA14, 3VA23, 3VA24, 3VA53, 3VA54, 3VA63, 3VA64	8US1213-4AH04	–	–	–	–	–
3VA13, 3VA14, 3VA23, 3VA24	–	8US1313-4AM04	–	–	–	–
3VL1 to 3VL4 (also with RCD module) ²⁾	–	–	8US1210-4AF00 + 8US1927-4AF01	–	–	–
3NP52, 3NP53, 3NP54 ⁵⁾	–	–	–	–	–	8US1210-4AG00
3KA52, 3KA53, 3KL52, 3KL53	–	–	–	8US1210-4AF00 ⁴⁾	–	–
3KA55, 3KA57, 3KA58, 3KL55, 3KL57	–	–	–	8US1210-4AG00 ⁴⁾	–	–

4 Device adapters and device holders

For load feeders up to 1600 A



Rated operational current I_e		Rated operational voltage U_e			Standard	For copper profile	Adapters		Connecting cable		Device
IEC	UL 508	IEC	UL 508	VA, Ⓢ			Length	Width	Cross-section	Max. temperature	
Screw terminals											
25 A	25 A	690 V AC	600 V AC	–	IEC, UL 508	5 mm, 10 mm, TT profile	200 mm	45 mm	AWG 12	150 °C	S00
							260 mm	45 mm	AWG 12	150 °C	S0
32 A	32 A	690 V AC	600 V AC	–	IEC, UL 508	5 mm, 10 mm, TT profile	200 mm	45 mm	AWG 10	150 °C	S0
									–	–	S00/S0
							260 mm	45 mm	AWG 10	150 °C	S0
									–	–	S00/S0
–	–	690 V AC	VA, Ⓢ	5 mm, 10 mm, TT profile	200 mm	45 mm	AWG 10	105 °C	S00/S0		
65 A	65 A	690 V AC	600 V AC	–	IEC, UL 508	5 mm, 10 mm, TT profile	260 mm	54 mm	AWG 4	150 °C	S2
								119 mm	AWG 4	150 °C	S2
80 A	80 A	690 V AC	600 V AC	–	IEC, UL 508	5 mm, 10 mm, TT profile	200 mm	54 mm	AWG 4	150 °C	S2
							215 mm	72 mm	AWG 4	150 °C	S3
Spring-loaded terminals											
25 A	25 A	690 V AC	600 V AC	–	IEC, UL 508	5 mm, 10 mm, TT profile	200 mm	45 mm	AWG 12	150 °C	S00
							260 mm	45 mm	AWG 12	150 °C	S00
32 A	32 A	690 V AC	600 V AC	–	IEC, UL 508	5 mm, 10 mm, TT profile	200 mm	45 mm	AWG 10	150 °C	S0
							260 mm	45 mm	AWG 10	150 °C	S0

Accessories

Vibration & shock kit S2



Use

For size 2 devices

Lateral modules



- For extending device adapters and device holders of the same length

Length	Width
200 mm	9 mm

For 3-pole system

Device adapters for plug-in units SIRIUS		Device adapters for load feeders SIRIUS 3RV2/3RT2			SIRIUS 3RV1/3RT1	SIRIUS 3RA6	
Circuit breakers, Direct-on-line starters	Circuit breakers, Direct-on-line starters, Reversing starters	Circuit breakers	Direct-on-line starters	Reversing starters	Circuit breakers	Direct-on-line starters	Reversing starters

–	–	8US1251-5DS10	8US1251-5DS10	8US1251-5DS10 + 8US1250-5AS10	–	–	–
–	–	8US1251-5DS10	–	–	–	–	–
–	–	–	8US1251-5DT10	–	–	–	–
–	–	8US1251-5NS10	–	–	–	–	–
8US1216-5AS80	–	–	–	–	–	–	–
–	–	8US1251-5NT10	8US1251-5NT10	8US1251-5NT10 + 8US1250-5AT10	–	–	–
8US1216-5AT80	8US1216-5AT80 + 8US1250-5AT10	–	–	–	–	–	–
–	–	–	–	–	–	8US1211-1NS10	8US1211-1NS10 + 8US1250-1AA10
–	–	–	8US1261-6MT10	–	–	–	–
–	–	–	–	8US1211-6MT10	–	–	–
–	–	8US1261-5MS13	–	–	–	–	–
–	–	–	–	–	8US1211-4TR00	–	–
–	–	8US1251-5DS11	–	–	–	–	–
–	–	8US1251-5DT11	8US1251-5DT11	8US1251-5DT11 + 8US1250-5AT10	–	–	–
–	–	8US1251-5NS11	–	–	–	–	–
–	–	8US1251-5NT11	8US1251-5NT11	8US1251-5NT11 + 8US1250-5AT10	–	–	–

Article No.	Article No.	Article No.	Article No.	Article No.	Article No.	Article No.	Article No.
8US1998-1DA10	8US1998-1DA10	8US1998-1DA10	8US1998-1DA10	8US1998-1DA10	–	–	–



Article No.	Article No.	Article No.	Article No.	Article No.	Article No.	Article No.	Article No.
8US1998-2BJ10	8US1998-2BJ10	8US1998-2BJ10	8US1998-2BJ10	8US1998-2BJ10	–	8US1998-2BJ10	8US1998-2BJ10

4 Device adapters and device holders


For load feeders up to 1600 A

Accessories

Plug-in connectors to make contact with the 3RV2 motor starter protectors for 8US1216-5AS80 and 8US1216-5AT80

	Use	Version	Size	Article No.
	For spring-loaded terminals	Single-unit packaging	S00 ¹⁾	3RV2917-5AA00
			S0 ²⁾	3RV2927-5AA00
		Multi-unit packaging	S00 ¹⁾	3RV2917-5A
			S0 ²⁾	3RV2927-5A
	For screw terminals	Single-unit packaging	S00 ^{1) 3)}	3RV2917-5CA00
			S0 ^{2) 4)}	3RV1927-5AA00
		Multi-unit packaging	S00 ^{1) 3)}	3RV2917-5C
			S0 ^{2) 4)}	3RV1927-5A

Plug-in connectors to make contact with the 3RV1011 motor starter protectors

	Use	Version	Size	Article No.
	For screw terminals	Single-unit packaging	S00	3RV1917-5CA00
		Multi-unit packaging	S00	3RV1917-5C

¹⁾ $I > 14$ A, please note derating.

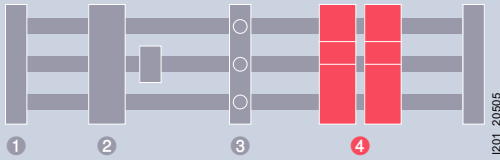
²⁾ $I > 16$ A, please note derating.

³⁾ The plug-in connector cannot be used for the 3RV2711 and 3RV2811 circuit breakers with size S00.

⁴⁾ The plug-in connector can be used for the 3RV2711, 3RV2811 (size S00) and 3RV2721, 3RV2821 (size S0) circuit breakers.

4 Device adapters and device holders

Accessories for device adapters for SIRIUS 3RV2/3RT2 load feeders





Mounting rails (35 mm) made of plastic with fixing screws

	Width	For adapter width	Article No.
	45 mm	45 mm	8US1998-7CB45
	54 mm	54 mm	8US1998-7CB54
	72 mm	54 mm	8US1998-7CB72

Positioning pieces

- For pushing on
- Secures the adaptable devices on the adapter

	For adapter width	Article No.
	45 mm	8US1998-1DA45
	54 mm	8US1998-1DA54

Connecting element

- For connecting busbar adapters and device holders

	Article No.
	8US1998-1AA10

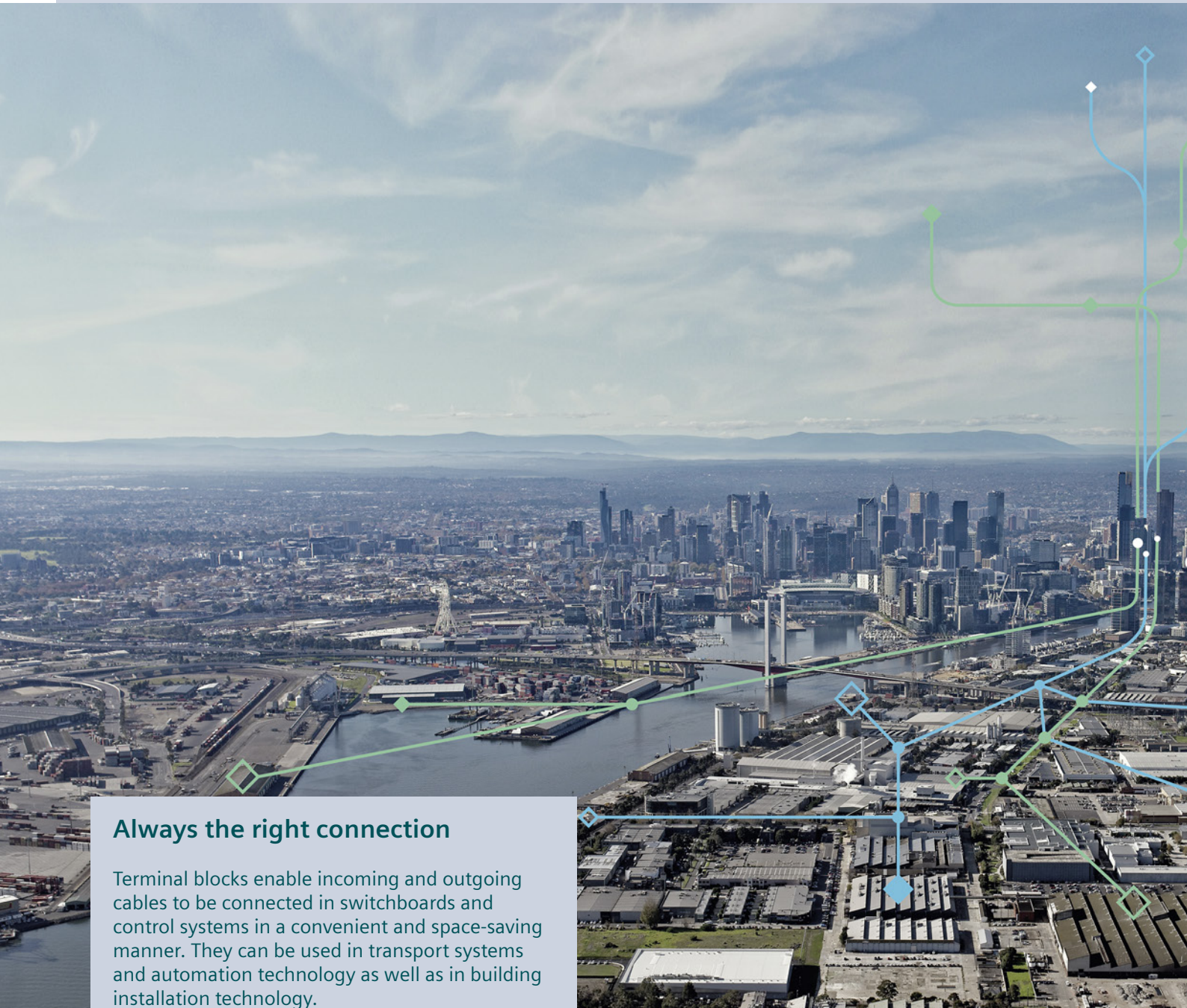
Spacers

- Fix the feeder to the busbar adapter

	Article No.
	8US1998-1BA10

Vibration & shock kit

	Article No.
	8US1998-1CA10

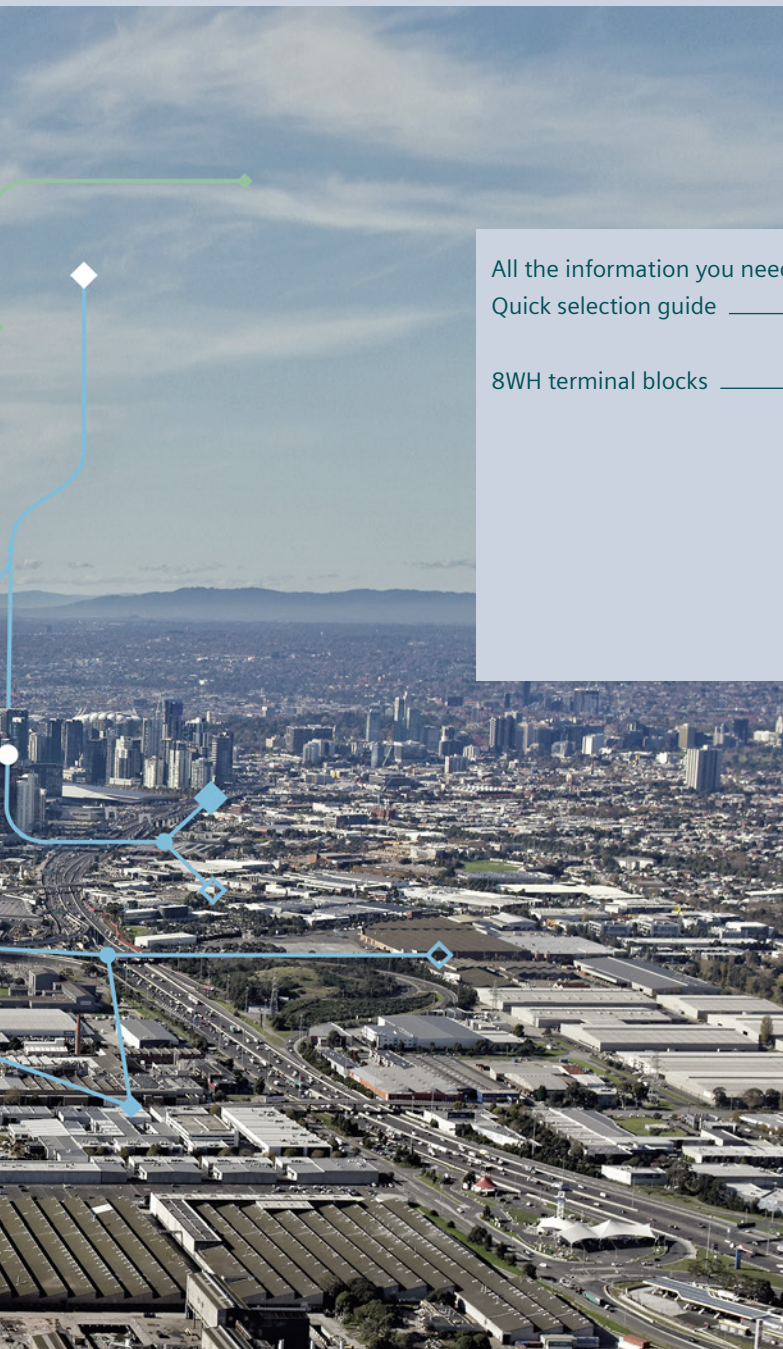


Always the right connection

Terminal blocks enable incoming and outgoing cables to be connected in switchboards and control systems in a convenient and space-saving manner. They can be used in transport systems and automation technology as well as in building installation technology.

We offer you the complete range of connection technology with screw terminals, spring-loaded terminals and In-Push-out (iPo) terminals, combination plug-in terminals, insulation displacement terminals and a wide variety of accessories. These can be combined with each other. This allows you to benefit from a high level of flexibility as well as simplified configuration.

Terminal Blocks



All the information you need	14/2
Quick selection guide	14/4
8WH terminal blocks	14/4
8WH terminal blocks	14/6
8WH6 iPo plug-in terminals	14/6
8WH6 iPo installation terminals	14/16
8WH2 spring-loaded terminals	14/22
8WH5 combination plug-in terminals	14/34
8WH3 insulation displacement terminals	14/38
8WH screw terminals	14/42
Accessories for 8WH terminal blocks	14/55

A multitude of additional information ...

Information + ordering

All the important things at a glance

For information about terminal blocks, please visit our website www.siemens.com/distribution-components

Your product in detail

Use our conversion tool for quick and easy conversion to Siemens products www.siemens.com/conversion-tool

Siemens YouTube channel

- Siemens ALPHA FIX terminal blocks – 8WH2 terminal with spring-loaded-connection sie.ag/6FTjPN

Everything you need for your order

Refer to SiePortal to find an overview of your products (product catalog)

- Terminal blocks sie.ag/2kW8ZXo

Direct forwarding to the individual products in SiePortal by clicking on the article number in the catalog or entering this web address incl. article number www.siemens.com/product_catalog_SIEP?Article No.

The fast track to the experts

Contact persons in your region

We offer a comprehensive portfolio of services. You can find your local contacts at www.siemens.com/lowvoltage/components/contact

You will find further information on services at www.siemens.com/service-offers

Competent expert advice on technical questions with a wide range of demand-optimized services for all our products and systems.

Assistance with technical queries is provided at www.siemens.com/support-request

... can be found in our online services

Commissioning + operation

Your product in detail

The SiePortal platform (knowledge base) provides detailed technical information

www.siemens.com/lowvoltage/product-support

- Operating instructions
- Certificates

Online Support app available for download from the [App Store](#) and [Play Store](#)

You will find further information at

www.siemens.com/support-app

Provision of 3D data (step and u3d data formats)

- SiePortal (product catalog)
www.siemens.com/lowvoltage/product-catalog
- Image database
www.siemens.com/lowvoltage/picturedb

Engineering data for CAD or CAE systems are available in the CAx Download Manager at

www.siemens.com/cax

Technical overview – Terminal blocks

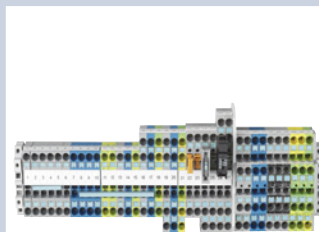


The fast way to get you to our online services

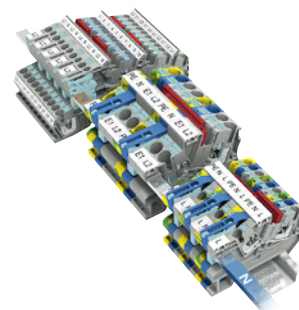
This page provides you with comprehensive information and links on terminal blocks

www.siemens.com/lowvoltage/product-support (109769088)

8WH terminal blocks

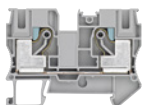


8WH6
iPo plug-in terminals



8WH6
iPo installation terminals

Through-type terminals



Through-type terminals

Two-tier terminals

Three-tier terminals

Four-tier motor terminals

2.5 ... 150 mm² [See page 14/6](#)

2.5 ... 4 mm² [See page 14/9](#)

–

–

2.5 ... 35 mm² [See page 14/16](#)

–

–

–

Isolating terminals



Isolating and isolating blade terminals

Two-tier isolating terminals

N conductor isolating terminals

Measuring transformer isolating terminals

2.5 ... 4 mm² [See page 14/10](#)

–

–

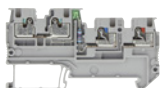
–

2.5 ... 35 mm² [See page 14/18](#)

–

14

Initiator/actuator terminals



Initiator terminals

Actuator terminals

Infeed terminals

1.5 mm² [See page 14/13](#)

1.5 mm² [See page 14/13](#)

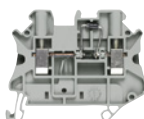
2.5 mm² [See page 14/14](#)

–

–

–

Function terminals



Fuse terminals

Three-tier terminals

Three-tier isolating terminals

Diode terminals

Two-tier diode terminals

Shield terminals

4 mm² [See page 14/12](#)

–

–

–

–

–

–

2.5 mm² [See page 14/20](#)

2.5 mm² [See page 14/21](#)

–

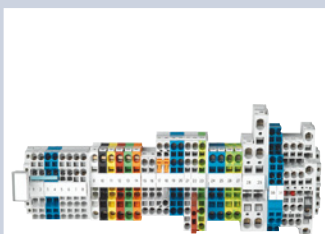
–

–

Further information

[From page 14/6](#)

[From page 14/16](#)



8WH2
spring-loaded
terminals

1.5 ... 35 mm² [See page 14/22](#)

1.5 ... 4 mm² [See page 14/25](#)

2.5 mm² [See page 14/26](#)

2.5 ... 4 mm² [See page 14/27](#)

2.5 ... 4 mm² [See page 14/28](#)

–

–

–

–

–

–

–

4 mm² [See page 14/30](#)

–

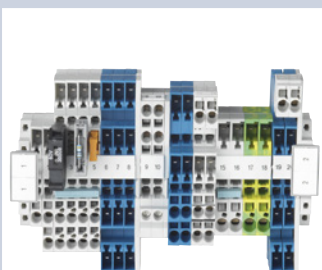
–

2.5 mm² [See page 14/32](#)

2.5 mm² [See page 14/33](#)

–

From page 14/22



8WH5
combination
plug-in terminals

2.5 mm² [See page 14/34](#)

–

–

–

–

–

–

–

–

–

–

–

–

–

–

–

–

–

–

From page 14/34



8WH3
insulation displacement
terminals

1.5 ... 2.5 mm² [See page 14/38](#)

1.5 mm² [See page 14/39](#)

–

–

1.5 ... 2.5 mm² [See page 14/40](#)

–

–

–

–

–

–

–

–

–

–

–

–

–

–

From page 14/38



8WH1
screw terminals

2.5 ... 240 mm² [See page 14/42](#)

2.5 ... 4 mm² [See page 14/45](#)

–

–

4 ... 6 mm² [See page 14/46](#)

4 mm² [See page 14/48](#)

–

6 mm² [See page 14/49](#)

–

–

–

–

4 ... 6 mm² [See page 14/50](#)

–

–

4 mm² [See page 14/52](#)

2.5 mm² [See page 14/53](#)

Diameter
2 ... 35 mm [See page 14/54](#)

From page 14/42

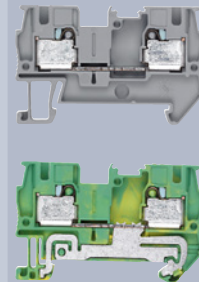
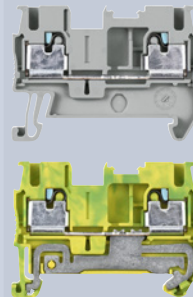
8WH6 iPo plug-in terminals

Through-type terminals



Terminal width	5.2 mm	6.2 mm
Max. load current I_{\max}	24 A	32 A
Max. operational voltage U_{\max}	800 V	800 V
AWG	26 ... 12	24 ... 10
Connection capacity, one rigid conductor	0.14 ... 4 mm ²	0.2 ... 6 mm ²
Connection capacity, one flexible conductor with end sleeve	0.14 ... 2.5 mm ²	0.2 ... 4 mm ²
Standard	IEC 60947-7-1, IEC 60947-7-2,	IEC 60947-7-1, IEC 60947-7-2,

Terminal size





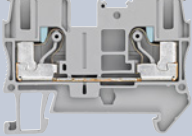

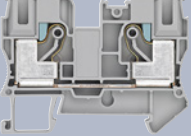
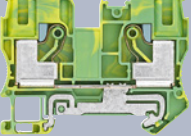
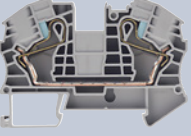
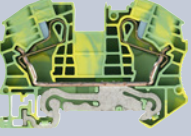


2.5 mm²
4 mm²


Terminals	Color		
① Through-type terminals			
2	● Gray	8WH6000-0AF00	8WH6000-0AG00
	● Blue	8WH6000-0AF01	8WH6000-0AG01
3	● Gray	8WH6003-0AF00	8WH6003-0AG00
	● Blue	8WH6003-0AF01	8WH6003-0AG01
4	● Gray	8WH6004-0AF00	8WH6004-0AG00
	● Blue	8WH6004-0AF01	8WH6004-0AG01
② PE through-type terminals			
2	● Green-yellow	8WH6000-0CF07	8WH6000-0CG07
3	● Green-yellow	8WH6003-0CF07	8WH6003-0CG07
4	● Green-yellow	8WH6004-0CF07	8WH6004-0CG07

Specific accessories

Covers					
Terminals	Color	Width	Article No.	Article No.	
2	● Gray	2.2 mm	8WH9000-1GA00	8WH9003-1GA00	
3	● Gray	2.2 mm	8WH9000-2GA00	8WH9003-2SA00	
4	● Gray	2.2 mm	8WH9000-4GA00	8WH9003-4SA00	
Compartment partitions					
Terminals	Color	Width	Article No.	Article No.	
2	● Gray	2.0 mm	8WH9070-0AA00	8WH9070-0AA00	
3	● Gray	2.0 mm	8WH9070-0GA00	8WH9070-0GA00	
4	● Gray	2.0 mm	8WH9070-0HA00	8WH9070-0HA00	
Cover segments					
	Color		Article No.	Article No.	
	● Gray		8WH9000-0GA00	–	
Warning covers					
			Article No.	Article No.	
			8WH9060-5CA06	8WH9063-5CA06	

See general accessories, from page 14/55 onwards

6 mm ²	10 mm ²	16 mm ²	35 mm ²
8.2 mm	10.2 mm	12.2 mm	16 mm
41 A	57 A	90 A	125 A
1000 V	1000 V	1000 V	1000 V
20 ... 8	20 ... 6	20 ... 4	10 ... 2
0.5 ... 10 mm ²	0.5 ... 16 mm ²	0.5 ... 25 mm ²	6 ... 35 mm ²
0.5 ... 6 mm ²	0.5 ... 10 mm ²	0.5 ... 16 mm ²	6 ... 35 mm ²
IEC 60947-7-1, IEC 60947-7-2, 	IEC 60947-7-1, IEC 60947-7-2, 	IEC 60947-7-1, IEC 60947-7-2, 	IEC 60947-7-1, IEC 60947-7-2, 
 	 	 	 
8WH6000-0AH00	8WH6000-0AJ00	8WH6000-0AK00	8WH6000-0AM00
8WH6000-0AH01	8WH6000-0AJ01	8WH6000-0AK01	8WH6000-0AM01
-	-	-	-
-	-	-	-
-	-	-	-
-	-	-	-
8WH6000-0CH07	8WH6000-0CJ07	8WH6000-0CK07	8WH6000-0CM07
-	-	-	-
-	-	-	-
Article No.	Article No.	Article No.	Article No.
8WH9004-3SA00	8WH9005-1SA00	8WH9006-1SA00	-
-	-	-	-
-	-	-	-
Article No.	Article No.	Article No.	Article No.
-	-	-	-
-	-	-	-
-	-	-	-
Article No.	Article No.	Article No.	Article No.
-	-	-	-
Article No.	Article No.	Article No.	Article No.
8WH9063-5CA06	8WH9065-5CA06	8WH9066-5CA06	8WH9067-5CA06

8WH6 iPo plug-in terminals

Through-type terminals for high-current applications



	Terminal size		
	50 mm ²	95 mm ²	150 mm ²
Terminal width	20 mm	25 mm	31 mm
Max. load current I_{max}	150 A	232 A	309 A
Operational voltage AC/DC	1000 V/1500 V	1000 V/1500 V	1000 V/1500 V
AWG	8 ... 2/0	4 ... 3/0	1/0 ... 300
Connection capacity, rigid	10 ... 70 mm ²	25 ... 95 mm ²	95 ... 150 mm ²
Connection capacity, flexible with end sleeve	10 ... 50 mm ²	25 ... 95 mm ²	95 ... 150 mm ²
Standard	IEC 60947-7-1, IEC 60947-7-2,	IEC 60947-7-1, IEC 60947-7-2,	IEC 60947-7-1,

Terminals	Color			
① Through-type terminals				
2		Gray	8WH6000-0AN00	8WH6000-0AQ00
		Blue	8WH6000-0AN01	8WH6000-0AQ01
				8WH6000-0AS00
				8WH6000-0AS01
② PE through-type terminals				
2		Green-yellow	8WH6000-0CN07	8WH6000-0CQ07
				–



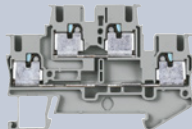
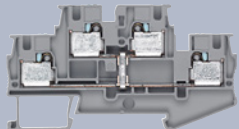
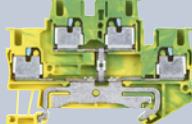
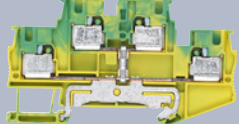
Specific accessories





Connecting combs				
	Number of poles	Article No.	Article No.	Article No.
	2-pole	8WH9020-3AB00	8WH9020-3AD00	8WH9020-3AF00
	3-pole	8WH9020-3AC00	8WH9020-3AE00	8WH9020-3AG00
Tap-off terminal				
	Number of poles	Article No.	Article No.	Article No.
	1-pole	8WH9120-0DA00	8WH9120-0DA00	8WH9120-0DA00
Test plugs				
	Surface	Article No.	Article No.	Article No.
	Metal	8WH9010-0NB00	8WH9010-0NB00	8WH9010-0NB00
Insulating sleeves for test plugs				
	Color	Article No.	Article No.	Article No.
		Red	8WH9010-0MB02	8WH9010-0MB02
			8WH9010-0MB02	8WH9010-0MB02
Warning covers				
		Article No.	Article No.	Article No.
		8WH9067-5CA06	8WH9068-5CA06	8WH9068-5CA06

See general accessories, from page 14/55 onwards

Two-tier terminals







	Terminal size	
	2.5 mm ²	4 mm ²
Terminal width	5.2 mm	6.2 mm
Max. load current I_{max}	26 A	32 A
Max. operational voltage U_{max}	500 V	500 V
AWG	26 ... 12	24 ... 10
Connection capacity, one rigid conductor	0.14 ... 4 mm ²	0.2 ... 6 mm ²
Connection capacity, one flexible conductor with end sleeve	0.14 ... 2.5 mm ²	0.2 ... 4 mm ²
Standard	IEC 60947-7-1, IEC 60947-7-2, 	IEC 60947-7-1, IEC 60947-7-2, 
		
		

Version	Color		
① Two-tier terminals			
Without equipotential bonding	 Gray	8WH6020-0AF00	8WH6020-0AG00
	 Blue	8WH6020-0AF01	8WH6020-0AG01
With equipotential bonding	 Gray	8WH6025-0AF00	8WH6025-0AG00
② PE two-tier terminals¹⁾			
	 Green-yellow	8WH6020-0CF07	8WH6020-0CG07

¹⁾ Bridging the terminal is only possible in the top tier (in the center).

Specific accessories

Covers					
	Terminals	Color	Width	Article No.	Article No.
	4	 Gray	2.2 mm	8WH9000-4SE00	–
				–	8WH9003-1VA00
Compartment partitions					
	Terminals	Color	Width	Article No.	Article No.
	4	 Gray	2 mm	8WH9070-0BA00	8WH9070-0BA00

See general accessories, from page 14/55 onwards

8WH6 iPo plug-in terminals

Isolating terminals



	Terminal size	
	2.5 mm ²	4 mm ²
Terminal width	5.2 mm	6.2 mm
Max. load current I_{max}	20 A	20 A
Max. operational voltage U_{max}	400 V	500 V
AWG	26 ... 12	24 ... 10
Connection capacity, one rigid conductor	0.14 ... 4 mm ²	0.2 ... 6 mm ²
Connection capacity, one flexible conductor with end sleeve	0.14 ... 2.5 mm ²	0.2 ... 4 mm ²
Standard	IEC 60947-7-1,	IEC 60947-7-1,

Terminals	Color		
2	Gray	8WH6000-6CF00	8WH6000-6AG00
3	Gray	8WH6003-6CF00	–
4	Gray	8WH6004-6CF00	–

Specific accessories

Covers						
	Terminals	Color	Width	Article No.	Article No.	
	2	Gray	2.2 mm	8WH9000-3SC00	8WH9003-1GA00	
	3	Gray	2.2 mm	8WH9000-3SD00	–	
	4	Gray	2.2 mm	8WH9000-5GA00	–	
Compartment partitions						
	Terminals	Color	Width	Article No.	Article No.	
	2	Gray	2.2 mm	8WH9070-0AA00	8WH9070-0AA00	
	3	Gray	2.2 mm	8WH9070-0GA00	–	
Plug-in zone connectors						
	Types	Color	I_{max}	Illuminated display	Article No.	Article No.
	Isolating plugs	Orange	–	–	8WH9040-0DB04	8WH9040-0DB04
	Through-type connectors	Gray	16 A	–	8WH9020-8AB00	8WH9020-8AB00
	Fused connectors ¹⁾	Black	6.3 A	12 ... 30 V, 1 ... 2.5 mA	8WH9040-3AB08	8WH9040-3AB08
				Without	8WH9040-3DB08	8WH9040-3DB08
	Component connectors	Gray	6 A	–	8WH9040-0BB00	8WH9040-0BB00

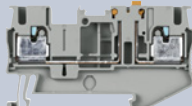
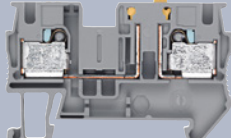
¹⁾ The G fuse holders must be selected according to the maximum power loss (heat dissipation) of the G fuse links. Depending on the application and method of installation, the heat rise conditions in closed fuse holders must be tested. Higher ambient temperatures represent an additional load for the fuse links. A shift in rated current should therefore be taken into account in such applications.

See general accessories, from page 14/55 onwards

Isolating blade terminals



	Terminal size	
	2.5 mm ²	4 mm ²
Terminal width	5.2 mm	6.2 mm
Max. load current I_{max}	20 A	20 A
Max. operational voltage U_{max}	400 V	400 V
AWG	26 ... 12	24 ... 10
Connection capacity, one rigid conductor	0.14 ... 4 mm ²	0.2 ... 6 mm ²
Connection capacity, two rigid conductors	–	0.5 ... 6 mm ²
Connection capacity, one flexible conductor	0.14 ... 2.5 mm ²	0.2 ... 4 mm ²
Standard	IEC 60947-7-1,	IEC 60947-7-1,

Terminals	Color		
2	Gray	8WH6000-6AF00	8WH6000-6CG00
3	Gray	8WH6003-6AF00	–
4	Gray	8WH6004-6AF00	–

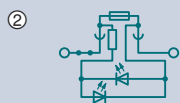
Specific accessories

Covers					
	Terminals	Color	Width	Article No.	Article No.
	2	Gray	2.2 mm	8WH9000-3SC00	8WH9003-1GA00
	3	Gray	2.2 mm	8WH9000-3SD00	–
	4	Gray	2.2 mm	8WH9000-5GA00	–
Compartment partitions					
	Terminals	Color	Width	Article No.	Article No.
	2	Gray	2 mm	8WH9070-0AA00	8WH9070-0AA00

See general accessories, from page 14/55 onwards

8WH6 iPo plug-in terminals

Fuse terminals



Terminal size

4 mm²

Terminal width 6.2 mm

Max. load current I_{max} 6.3 A

Max. operational voltage U_{max} 500 V

AWG 24 ... 10

Connection capacity, one rigid conductor 0.2 ... 6 mm²

Connection capacity, one flexible conductor with end sleeve 0.2 ... 4 mm²

Standard



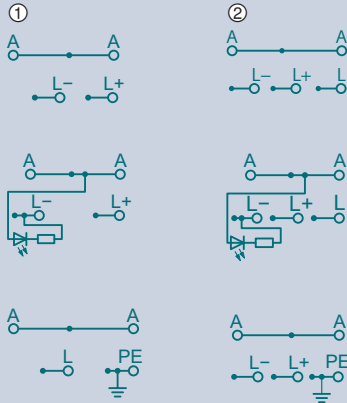
LED	Color	
Fuse terminals for 5 × 20 mm G fuse links		
① Without	● Black	8WH6000-1GG08
② 10 ... 30 V AC/DC	● Black	8WH6000-1KG38
② 110 ... 250 V AC/DC	● Black	8WH6000-1MG88

Specific accessories

Covers				
	Terminals	Color	Width	Article No.
	2	● Gray	2.2 mm	8WH9003-1GA00
5 × 25 mm G fuse links				
	Types	Breaking capacity	Rated uninterrupted current	Article No.
	Quick	Large	1 A	8WA1822-7EF16
			1.6 A	8WA1822-7EF18
			2.5 A	8WA1822-7EF21
			4 A	8WA1822-7EF23
			6.3 A	8WA1822-7EF25
	Slow	Small	1 A	8WA1822-7EF76
			1.6 A	8WA1822-7EF78
			2.5 A	8WA1822-7EF81
			4 A	8WA1822-7EF83
6.3 A			8WA1822-7EF85	
Isolating links, 5 × 20 mm				
	Size	5 × 20 mm	Article No.	8WH9021-0CB12

See general accessories, from page 14/55 onwards

Initiator/actuator terminals



	Terminal size 1.5 mm ²	
Terminal width	3.5 mm	3.5 mm
Max. load current I_{\max}	13.5 A	13.5 A
Max. operational voltage U_{\max}	250 V	250 V
AWG	26 ... 14	26 ... 14
Connection capacity, flexible with end sleeve, with plastic sleeve	0.14 ... 1.0 mm ²	0.14 ... 1.0 mm ²
Connection capacity, flexible with end sleeve, without plastic sleeve	0.14 ... 1.5 mm ²	0.14 ... 1.5 mm ²
Standard	IEC 60947-7-1	IEC 60947-7-1

Conductors ¹⁾	Number of connections	LED	Color		
① Initiator terminal					
3-wire, L+, L-, A	4	–	● Gray	8WH6003-0DE00	–
3-wire, L+, L-, A	4	Green, 24 V (15 ... 30 V DC)	● Gray	8WH6003-0FE00	–
3-wire, L, A, PE	4	–	● Gray	8WH6003-0HE00	–
② Actuator terminal					
4-wire, L+, L-, L, A	5	–	● Gray	–	8WH6004-0DE00
4-wire, L+, L-, L, A	5	Green, 24 V (15 ... 30 V DC)	● Gray	–	8WH6004-0FE00
4-wire, L+, L-, PE, A	5	–	● Gray	–	8WH6004-0HE00

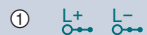
¹⁾ L+ = red, L- = blue, A (output) = petrol, L = petrol, PE (ground) = green/yellow

Specific accessories

Covers	Version	Width	Color	Article No.	Article No.
	For 3-wire	2.2 mm	● Gray	8WH9001-2VD00	–
	For 4-wire	2.2 mm	● Gray	–	8WH9001-4VE00

8WH6 iPo plug-in terminals

Infeed terminals for initiator/actuator terminals



Connection capacity, flexible with end sleeve, with plastic sleeve
 Connection capacity, flexible with end sleeve, without plastic sleeve
 Standard

Terminal size

2.5 mm²

Terminal width 7 mm

Max. load current I_{max} 20 A

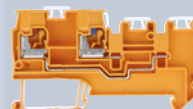
Max. operational voltage U_{max} 250 V

AWG 24 ... 12

0.2 ... 2.5 mm²

0.2 ... 2.5 mm²

IEC 60947-7-1



Conductors ¹⁾	Color	
① 3-wire, L+, L-	● Orange	8WH6003-0DF04
② 4-wire, L+, L-, PE	● Orange	8WH6004-0HE04

¹⁾ L+ = red, L- = blue, A (output) = petrol, L = petrol, PE (ground) = green/yellow

See general accessories, from page 14/55 onwards

Specific accessories for 8WH6 initiator/actuator terminals

Connecting combs



Number of poles	Load current	Color	Article No.
2-pole	17.5 A	● Red	8WH9020-6JC02
		● Blue	8WH9020-6JC01
		● Gray	8WH9020-6JC00
3-pole	17.5 A	● Red	8WH9020-6JD02
		● Blue	8WH9020-6JD01
		● Gray	8WH9020-6JD00
4-pole	17.5 A	● Red	8WH9020-6JE02
		● Blue	8WH9020-6JE01
		● Gray	8WH9020-6JE00
5-pole	17.5 A	● Red	8WH9020-6JF02
		● Blue	8WH9020-6JF01
		● Gray	8WH9020-6JF00
10-pole	17.5 A	● Red	8WH9020-6JL02
		● Blue	8WH9020-6JL01
		● Gray	8WH9020-6JL00
20-pole	17.5 A	● Red	8WH9020-6JS02
		● Blue	8WH9020-6JS01
		● Gray	8WH9020-6JS00

Labels, front, for terminal width 3.5 mm and terminal size 1.5 mm²



Types	Color	Article No.
Blank	● White	8WH8110-0AA05
Custom inscription	● White	8WH8140-0XA05-Z Y01
	● White	8WH8120-0XA05-Z Y01

Labels, flat, for terminal width 3.5 mm and terminal size 1.5 mm²



1 2 3 4 5 6 7 8 9 10

1
2
3
4
5
6
7
8
9
10

Types	Inscription	Color	Article No.
Blank		● White	8WH8111-0AA05
Consecutive numbering	Printed vertically	● White	8WH8141-0AB05
		● White	8WH8141-0AB15
		● White	8WH8141-0AB25
		● White	8WH8141-0AB35
		● White	8WH8141-0AB45
	Printed horizontally	● White	8WH8121-0AB05
		● White	8WH8121-0AB15
		● White	8WH8121-0AB25
		● White	8WH8121-0AB35
		● White	8WH8121-0AB45
Custom inscription	Printed vertically	● White	8WH8141-0XA05-Z Y01
	Printed horizontally	● White	8WH8121-0XA05-Z Y01

Labels for 8WH initiator/actuator terminals for labeling system



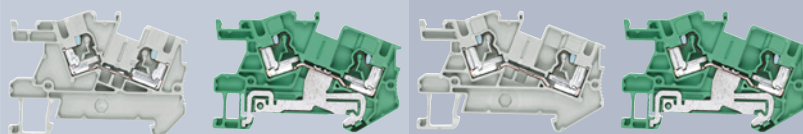
Types	Terminal width	Standard	Color	Article No.
Front, blank	3.5 mm	WIN 486	● White	8WH8112-0AA05
Flat, blank	3.5 mm	WIN 416	● White	8WH8113-0AA05

8WH6 iPo installation terminals

Through-type terminals



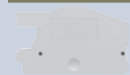
	Terminal size			
	2.5 mm ²		4 mm ²	
Terminal width	5.2 mm	5.2 mm	6.2 mm	6.2 mm
Terminal length	59.5 mm	59.5 mm	66 mm	66 mm
Terminal height	42.5 mm	43 mm	44 mm	46.3 mm
Max. load current I_{\max}	24 A	–	32 A	–
Max. operational voltage U_{\max}	800 V	–	800 V	–
Rated impulse voltage	–	–	–	–
AWG	26 ... 12	24 ... 12	24 ... 10	24 ... 10
Connection capacity, one rigid conductor	0.14 ... 4 mm ²	0.2 ... 4 mm ²	0.2 ... 6 mm ²	0.2 ... 6 mm ²
Connection capacity, two rigid conductors	–	–	–	–
Connection capacity, flexible with end sleeve	0.14 ... 2.5 mm ²	0.25 ... 2.5 mm ²	0.25 ... 4 mm ²	0.25 ... 4 mm ²
Connection capacity, flexible without end sleeve	0.14 ... 2.5 mm ²	0.25 ... 2.5 mm ²	0.25 ... 4 mm ²	0.25 ... 4 mm ²
Tightening torque	–	–	–	–
Standard	IEC 60947-7-1	IEC 60947-7-2	IEC 60947-7-1	IEC 60947-7-2



Terminals	Color	iPo plug-in technology		iPo plug-in technology	
① Through-type terminals					
2	● Gray	8WH6001-0AF00	–	8WH6001-0AG00	–
	● Blue	8WH6001-0AF01	–	8WH6001-0AG01	–
② PE through-type terminals					
2	● Green-yellow	–	8WH6001-0CF07	–	8WH6001-0CG07

Specific accessories

Covers



Color	Width	Article No.	Article No.
● Gray	1.8 mm	–	–
	2.2 mm	8WH9000-1WA00	8WH9003-7WA00

N conductor support brackets



- For holding the N busbar

Color	Article No.	Article No.
● Blue	8WH9143-0AF01	8WH9143-0AF01

Connecting combs



Number of poles	Article No.	Article No.
2-pole	–	–
3-pole	–	–
10-pole	–	–

Compartment partitions



Color	Article No.	Article No.
● Gray	–	–

Connecting terminals









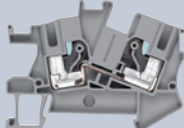





Color	Width	Article No.	Article No.
● Blue	10.3 mm	8WH9126-0BA01	8WH9126-0BA01

N busbars, 10 × 3 mm



Version	Length	Article No.	Article No.
Copper, tinned	1000 mm	8WH9030-2AB12	8WH9030-2AB12

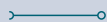
See general accessories, from page 14/55 onwards

6 mm ²		16 mm ²		35 mm ²	
8.2 mm	8.2 mm	12.2 mm	12.2 mm	15.2 mm	15 mm
66 mm	66 mm	51 mm	51 mm	55 mm	55 mm
50 mm	50 mm	50 mm	50 mm	51 mm	51 mm
41 A	–	76 A	–	125 A	125 A
800 V	–	400 V	–	800 V	–
–	–	6 kV	6 kV	8 kV	8 kV
20 ... 8	20 ... 8	22 ... 4	22 ... 4	18 ... 2	18 ... 2
0.5 ... 10 mm ²	0.5 ... 10 mm ²	6 ... 25 mm ²	6 ... 25 mm ²	0.75 ... 35 mm ²	0.75 ... 35 mm ²
–	–	2.5 ... 10 mm ²	2.5 ... 10 mm ²	0.75 ... 10 mm ²	0.75 ... 10 mm ²
0.5 ... 6 mm ²	0.5 ... 6 mm ²	6 ... 16 mm ²	6 ... 16 mm ²	0.75 ... 35 mm ²	0.75 ... 35 mm ²
0.5 ... 6 mm ²	0.5 ... 6 mm ²	6 ... 16 mm ²	6 ... 16 mm ²	0.75 ... 10 mm ²	0.75 ... 10 mm ²
–	–	2.5 ... 3.0 Nm	2.5 ... 3.0 Nm	3.2 ... 3.7 Nm	3.2 ... 3.7 Nm
IEC 60947-7-1	IEC 60947-7-2	IEC 60947-7-1, IEC 60947-7-2, 	IEC 60947-7-1, IEC 60947-7-2, 	 	 
					
iPo plug-in technology		Screw terminals		Screw terminals	
8WH6001-0AH00	–	8WH1201-0AK00	–	8WH1201-0AM00	–
8WH6001-0AH01	–	8WH1201-0AK01	–	8WH1201-0AM01	–
–	8WH6001-0CH07	–	8WH1201-0CK07	–	8WH1201-0CM07

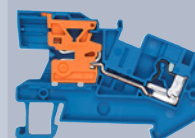
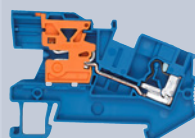
Article No.	Article No.	Article No.
–	8WH9005-3PA00	–
8WH9004-1WA00	–	–
Article No.	Article No.	Article No.
8WH9143-0AH01	–	–
Article No.	Article No.	Article No.
–	–	8WH9030-6BC00
–	–	8WH9030-6BD00
–	8WH9030-6AL00	–
Article No.	Article No.	Article No.
–	8WH9070-6HA00	–
Article No.	Article No.	Article No.
8WH9126-0BA01	8WH9126-0BA01	–
Article No.	Article No.	Article No.
8WH9030-2AB12	8WH9030-2AB12	8WH9030-2AB12

8WH6 iPo installation terminals

N conductor isolating terminals





	Terminal size	
	2.5 mm ²	4 mm ²
Terminal width	5.2 mm	6.2 mm
Terminal length	59 mm	66 mm
Terminal height	46.3 mm	46.3 mm
Max. load current I_{max} / cross-section	24 A/2.5 mm ²	32 A/4 mm ²
Max. operational voltage U_{max}	250 V	250 V
Rated impulse voltage	4 kV	6 kV
AWG	26 ... 12	24 ... 10
Connection capacity, one rigid conductor	0.14 ... 4 mm ²	0.2 ... 6 mm ²
Connection capacity, two rigid conductors	0.2 ... 1.5 mm ²	0.2 ... 2 mm ²
Connection capacity, one flexible conductor with end sleeve	0.14 ... 2.5 mm ²	0.25 ... 4 mm ²
Connection capacity, two flexible conductors with end sleeve	max. 0.5 mm ²	max. 1 mm ²
Tightening torque	–	–
Standard	IEC 60947-7-1	IEC 60947-7-1



Terminals	Color	iPo plug-in technology	iPo plug-in technology
2	● Blue	8WH6001-0BF01	8WH6001-0BG01

Specific accessories

Covers


	Color	Width	Article No.	Article No.
	● Blue	2.2 mm	8WH9000-1SA00	8WH9003-1SA00
	● Gray	2.2 mm	–	–

N conductor support brackets

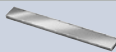
- For holding the N busbar 10 × 3 mm
- To be placed every 20 cm

	Color	Article No.	Article No.
	● Blue	8WH9143-0AF01	8WH9143-0AF01
	–	–	–

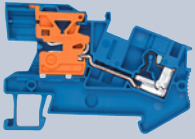

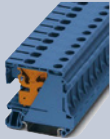
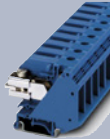
Connecting terminals

	Color	Width	Article No.	Article No.
	● Blue	10.3 mm	8WH9126-0BA01	8WH9126-0BA01

N busbars, 10 × 3 mm

	Version	Length	Article No.	Article No.
	Copper, tinned	1000 mm	8WH9030-2AB12	8WH9030-2AB12

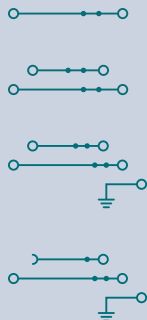
See general accessories, from page 14/55 onwards

6 mm ²	10 mm ²	16 mm ²	35 mm ²
8.2 mm	10.2 mm	12.2 mm	15 mm
66.3 mm	55 mm	55 mm	55 mm
50 mm	47 mm	50 mm	50 mm
41 A/6 mm ²	57 A/16 mm ²	76 A/25 mm ²	110 A/35 mm ²
400 V	400 V	400 V	400 V
6 kV	6 kV	6 kV	6 kV
20 ... 8	–	–	–
0.5 ... 10 mm ²	0.5 ... 16 mm ²	6 ... 25 mm ²	0.75 ... 35 mm ²
0.5 ... 4 mm ²	0.5 ... 4 mm ²	2.5 ... 10 mm ²	0.75 ... 10 mm ²
0.5 ... 6 mm ²	0.5 ... 10 mm ²	6 ... 16 mm ²	0.75 ... 35 mm ²
0.5 ... 1.5 mm ²	0.5 ... 2.5 mm ²	4 ... 6 mm ²	0.75 ... 10 mm ²
–	1.5 ... 1.8 Nm	1.5 ... 1.8 Nm	3.2 ... 3.7 Nm
IEC 60947-7-1	IEC 60947-7-1	IEC 60947-7-1	IEC 60947-7-1
			
iPo plug-in technology	Screw terminals	Screw terminals	Screw terminals
8WH6001-0BH01	8WH1201-0BJ01	8WH1201-0BK01	8WH1201-0BM01

Article No.	Article No.	Article No.	Article No.
8WH9004-1SA00	–	–	–
–	8WH9005-3PB00	8WH9005-3PB00	–
Article No.	Article No.	Article No.	Article No.
8WH9143-0AH01	–	–	–
–	8WH9141-0BC01	8WH9141-0BC01	8WH9141-0BC01
Article No.	Article No.	Article No.	Article No.
8WH9126-0BA01	8WH9126-0BA01	8WH9126-0BA01	–
Article No.	Article No.	Article No.	Article No.
8WH9030-2AB12	8WH9030-2AB12	8WH9030-2AB12	8WH9030-2AB12

8WH6 iPo installation terminals

Three-tier terminals






	Terminal size
	2.5 mm ²
Terminal width	5.2 mm
Terminal length	101 mm
Terminal height	50.5 mm
Max. load current I_{\max} /cross-section	24 A/4 mm ²
Max. operational voltage U_{\max} (L-L)	400 V
Rated voltage U_n (L-N, L-PE)	250 V
AWG	26 ... 12
Connection capacity, rigid	0.14 ... 4 mm ²
Connection capacity, flexible with end sleeve	0.14 ... 2.5 mm ²



Types	Color	
L	● Gray	8WH6001-4QF00
L/L	● Gray	8WH6001-4DF00
L/N	● Gray	8WH6001-4CF00
PE/L/L	● Gray	8WH6001-4HF00
PE/L/N	● Gray	8WH6001-4EF00
PE/L/NT	● Gray	8WH6001-4FF00

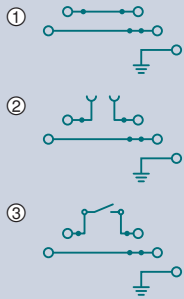
Specific accessories

Covers			
	Color	Width	Article No.
	● Gray	2.2 mm	8WH9000-3SA00
N conductor support brackets			
	<ul style="list-style-type: none"> For holding the N busbar To be placed every 20 cm 		
	Color	Width	Article No.
	● Blue	2 mm	8WH9142-0AF01
Connecting terminals			
	Color	Width	Article No.
	● Blue	10.3 mm	8WH9126-0BA01
N busbars, 10 × 3 mm			
	Version	Length	Article No.
	Copper, tinned ¹⁾	1000 mm	8WH9030-2AB12

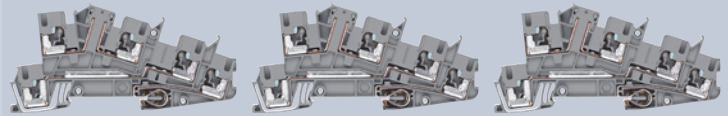
¹⁾ Only copper busbars may be installed.

See general accessories, from page 14/55 onwards

Three-tier isolating terminals




	Terminal size		
	2.5 mm ²		
Terminal width	5.2 mm	5.2 mm	5.2 mm
Terminal length	101 mm	101 mm	101 mm
Terminal height	50.5 mm	50.5 mm	50.5 mm
Max. load current I_{max} /cross-section	24 A/4 mm ²	24 A/4 mm ²	24 A/4 mm ²
Max. operational voltage U_{max} (L-L)	400 V	400 V	400 V
Rated voltage U_n (L-N, L-PE)	250 V	250 V	250 V
AWG	26 ... 12	26 ... 12	26 ... 12
Connection capacity, rigid	0.25 ... 4 mm ²	0.25 ... 4 mm ²	0.25 ... 4 mm ²
Connection capacity, flexible with end sleeve	0.25 ... 2.5 mm ²	0.25 ... 2.5 mm ²	0.25 ... 2.5 mm ²



Types	Color			
① Through-type terminals with identical contour				
PE/L/L	● Gray	–	–	8WH6001-4PF00
② Isolating terminals				
PE/L/L isolation	● Gray	8WH6001-4MF00	–	–
③ Isolating blade terminals				
PE/L/L isolating blade	● Gray	–	8WH6001-4NF00	–
PE/L/N isolating blade	● Gray	–	8WH6001-4GF00	–

Specific accessories

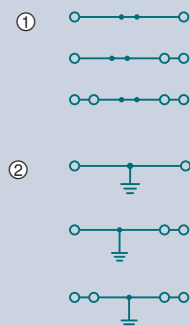
Covers for isolating terminal in the contour

	Color	Width	Article No.	Article No.	Article No.
	● Gray	2.2 mm	–	8WH9000-6SA00	8WH9000-6SA00

See general accessories, from page 14/55 onwards

8WH2 spring-loaded terminals

Through-type terminals



	Terminal size	
	1.5 mm ²	2.5 mm ²
Terminal width	4.2 mm	5.2 mm
Max. load current I_{max}	17.5 A	31 A
Max. operational voltage U_{max}	500 V	800 V
AWG	28 ... 16	28 ... 12
Connection capacity, rigid	0.08 ... 1.5 mm ²	0.08 ... 4 mm ²
Connection capacity, flexible with end sleeve	0.14 ... 1.5 mm ²	0.14 ... 2.5 mm ²
Standard	IEC 60947-7-1, IEC 60947-7-2,	IEC 60947-7-1, IEC 60947-7-2,

Terminals	Color		
① Through-type terminals			
2	Gray	8WH2000-0AE00	8WH2000-0AF00
	Blue	8WH2000-0AE01	8WH2000-0AF01
	Orange	8WH2000-0AE04	8WH2000-0AF04
	Red	8WH2000-0AE02	8WH2000-0AF02
	Black	8WH2000-0AE08	8WH2000-0AF08
	Green	8WH2000-0AE03	8WH2000-0AF03
	White	8WH2000-0AE05	8WH2000-0AF05
	Yellow	8WH2000-0AE06	8WH2000-0AF06
3	Gray	8WH2003-0AE00	8WH2003-0AF00
	Blue	8WH2003-0AE01	8WH2003-0AF01
	Orange	8WH2003-0AF04	8WH2003-0AF04
4	Gray	8WH2004-0AE00	8WH2004-0AF00
	Blue	8WH2004-0AE01	8WH2004-0AF01
	Orange	8WH2004-0AF04	8WH2004-0AF04
② PE through-type terminals			
2	Green-yellow	8WH2000-0CE07	8WH2000-0CF07
3	Green-yellow	8WH2003-0CE07	8WH2003-0CF07
4	Green-yellow	8WH2004-0CE07	8WH2004-0CF07

Specific accessories

Covers					
	Color	Width	Terminals	Article No.	Article No.
	Gray	2.2 mm	2	8WH9000-1GA00	8WH9000-1GA00
			3	8WH9000-2GA00	8WH9000-2GA00
			4	8WH9000-4GA00	8WH9000-4GA00
Compartment partitions					
	Color		Terminals	Article No.	Article No.
	Gray		2	8WH9070-0AA00	8WH9070-0AA00
			3	8WH9070-0GA00	8WH9070-0GA00
			4	8WH9070-0HA00	8WH9070-0HA00
Cover segments					
	• For covering multi-wire terminals when mounting two-wire terminals side-by-side				
	Color			Article No.	Article No.
	Gray			8WH9000-0GA00	8WH9000-0GA00
Warning covers for the operating shafts of 8WH2 through-type terminals					
				Article No.	Article No.
				8WH9061-5AA06	8WH9060-5AA06

4 mm ²	6 mm ²	10 mm ²	16 mm ²	35 mm ²
6.2 mm	8.2 mm	10.2 mm	12.2 mm	16 mm
40 A	52 A	65 A	90 A	125 A
800 V	1000 V	1000 V	1000 V	1000 V
28 ... 10	24 ... 8	24 ... 6	24 ... 4	14 ... 2
0.08 ... 6 mm ²	0.2 ... 10 mm ²	1.5 ... 16 mm ²	0.2 ... 25 mm ²	2.5 ... 35 mm ²
0.14 ... 4 mm ²	0.25 ... 6 mm ²	1.5 ... 10 mm ²	0.25 ... 16 mm ²	2.5 ... 35 mm ²
IEC 60947-7-1, IEC 60947-7-2, SIL US	IEC 60947-7-1, IEC 60947-7-2, SIL US	IEC 60947-7-1, IEC 60947-7-2, SIL US	IEC 60947-7-1, IEC 60947-7-2, SIL US	IEC 60947-7-1, IEC 60947-7-2, SIL US
				

8WH2000-0AG00	8WH2000-0AH00	8WH2000-0AJ00	8WH2000-0AK00	8WH2000-0AM00
8WH2000-0AG01	8WH2000-0AH01	8WH2000-0AJ01	8WH2000-0AK01	8WH2000-0AM01
8WH2000-0AG04	–	–	–	–
8WH2000-0AG02	–	–	–	–
8WH2000-0AG08	–	–	–	–
8WH2000-0AG03	–	–	–	–
8WH2000-0AG05	–	–	–	–
8WH2000-0AG06	–	–	–	–
8WH2003-0AG00	8WH2003-0AH00	–	–	–
8WH2003-0AG01	8WH2003-0AH01	–	–	–
–	–	–	–	–
8WH2004-0AG00	–	–	–	–
8WH2004-0AG01	–	–	–	–
–	–	–	–	–
8WH2000-0CG07	8WH2000-0CH07	8WH2000-0CJ07	8WH2000-0CK07	8WH2000-0CM07
8WH2003-0CG07	8WH2003-0CH07	–	–	–
8WH2004-0CG07	–	–	–	–

Article No.	Article No.	Article No.	Article No.	Article No.
8WH9003-1GA00	8WH9004-1GA00	8WH9005-1GA00	8WH9006-1GA00	–
8WH9003-2GA00	8WH9004-2GA00	–	–	–
8WH9003-4GA00	–	–	–	–
Article No.	Article No.	Article No.	Article No.	Article No.
8WH9070-0AA00	8WH9070-0DA00	–	–	–
8WH9070-0GA00	8WH9070-0DA00	–	–	–
8WH9070-0HA00	–	–	–	–
Article No.	Article No.	Article No.	Article No.	Article No.
8WH9003-0GA00	–	–	–	–
Article No.	Article No.	Article No.	Article No.	Article No.
8WH9063-5AA06	8WH9064-5AA06	–	–	8WH9067-5AA06

8WH2 spring-loaded terminals

Hybrid through-type terminals



	Terminal size	
	2.5 mm ²	4 mm ²
Terminal width	5.2 mm	6.2 mm
Max. load current I_{\max}	28 A	32 A
Max. operational voltage U_{\max}	800 V	800 V
AWG spring	28 ... 12	28 ... 10/26 ... 10
Connection capacity, rigid, spring-loaded	0.08 ... 4 mm ²	0.08 ... 6 mm ²
Connection capacity, flexible, spring-loaded	0.08 ... 2.5 mm ²	0.08 ... 4 mm ²
AWG screw	26 ... 14	28 ... 10/26 ... 10
Connection capacity, rigid, screw-type	0.14 ... 4 mm ²	0.14 ... 6 mm ²
Connection capacity, flexible, screw-type	0.14 ... 2.5 mm ²	0.14 ... 4 mm ²
Standard	IEC 60947-7-1, IEC 60947-7-2	IEC 60947-7-1, IEC 60947-7-2

Terminals	Color	Screw connection and spring-loaded connection	Screw connection and spring-loaded connection
① Hybrid through-type terminals			
3	● Gray	8WH2103-2BF00	8WH2103-2BG00
	● Blue	8WH2103-2BF01	8WH2103-2BG01
② PE hybrid through-type terminals			
3	● Green-yellow	8WH2103-3BF07	8WH2103-3BG07





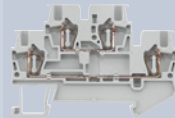
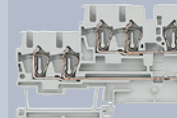
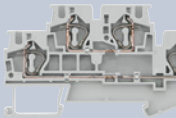


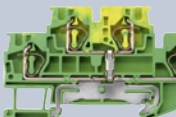
Specific accessories









Covers					
	Color	Width	Terminals	Article No.	Article No.
	● Gray	2.2 mm	3	8WH9000-2HA00	8WH9003-2HA00

See general accessories, from page 14/55 onwards

Two-tier terminals







	Terminal size		
	1.5 mm ²	2.5 mm ²	4 mm ²
Terminal width	4.2 mm	5.2 mm	6.2 mm
Max. load current I_{max}	17.5 A	26 A	32 A
Max. operational voltage U_{max}	500 V	500 V	500 V
AWG	28 ... 16	28 ... 12	28 ... 10
Connection capacity, rigid	0.08 ... 1.5 mm ²	0.08 ... 4 mm ²	0.08 ... 6 mm ²
Connection capacity, flexible with end sleeve	0.08 ... 1.5 mm ²	0.08 ... 2.5 mm ²	0.08 ... 4 mm ²
Standard	IEC 60947-7-1, IEC 60947-7-2,  	IEC 60947-7-1, IEC 60947-7-2, 	IEC 60947-7-1, IEC 60947-7-2, 
			
			

Version	Number of poles	Terminals	Color			
① Two-tier terminals						
Without equipotential bonding	2-pole	4	 Gray	8WH2020-0AE00	8WH2020-0AF00	8WH2020-0AG00
			 Blue	8WH2020-0AE01	8WH2020-0AF01	8WH2020-0AG01
	6	 Gray	–	8WH2023-0AF00	–	
		 Blue	–	8WH2023-0AF01	–	
With equipotential bonding	1-pole	4	 Gray	8WH2025-0AE00	8WH2025-0AF00	8WH2025-0AG00
			 Blue	–	8WH2025-0AF01	–
	6	 Gray	–	8WH2022-0AF00	–	
② Two-tier terminals, N at top and L at bottom						
Without equipotential bonding	2-pole	4	 Gray	–	8WH2020-4CF00	–
③ PE two-tier terminals ¹⁾						
		4	 Green-yellow	8WH2020-0CE07	8WH2020-0CF07	8WH2020-0CG07
		6	 Green-yellow	–	8WH2023-0CF07	–

¹⁾ Only top tier can be fitted with connecting combs.

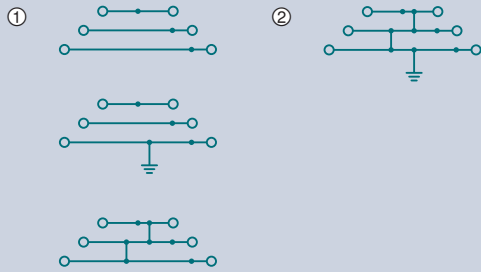
Specific accessories

Covers						
	Width	Terminals	Color	Article No.	Article No.	Article No.
	2.2 mm	4	 Gray	8WH9000-1VA00	8WH9000-1VA00	8WH9003-1VA00
		6	 Gray	–	8WH9000-2VA00	–
Compartment partitions						
			Color	Article No.	Article No.	Article No.
			 Gray	8WH9070-0BA00	8WH9070-0BA00	8WH9070-0BA00

See general accessories, from page 14/55 onwards

8WH2 spring-loaded terminals

Three-tier terminals



Terminal size

2.5 mm²

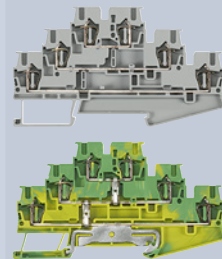
Terminal width 5.2 mm

Max. load current I_{\max} 28 A ¹⁾Max. operational voltage U_{\max} 500 V

AWG 28 ... 12

Connection capacity, rigid 0.08 ... 4 mm²Connection capacity, flexible with end sleeve 0.08 ... 2.5 mm²

Standard IEC 60947-7-1, IEC 60947-7-2,



Version	Types	Color	
① Three-tier terminals			
Without equipotential bonding	–	● Gray	8WH2030-0AF00
		● Blue	8WH2030-0AF01
	PE/L/N	● Gray	8WH2030-4EF00
	PE/L/L	● Gray	8WH2030-4HF00
With equipotential bonding		● Gray	8WH2035-0AF00
		● Blue	8WH2035-0AF01
② PE three-tier terminals			
		● Green-yellow	8WH2035-0CF07

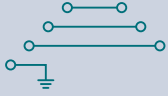
¹⁾ The total current through all connected conductors must not exceed the maximum load current.




Specific accessories



Covers			
	Width	Color	Article No.
	2.2 mm	● Gray	8WH9000-1GD00
Label holder			
		Color	Article No.
		● Gray	8WH9060-4BA00

See general accessories, from page 14/55 onwards

Four-tier motor terminals





	Terminal size	
	2.5 mm ²	4 mm ²
Terminal width	5.2 mm	6.2 mm
Max. load current I_{max}	26 A	32 A
Max. operational voltage U_{max}	800 V	800 V
AWG	28 ... 12	28 ... 10
Connection capacity, rigid	0.08 ... 4 mm ²	0.08 ... 6 mm ²
Connection capacity, flexible with end sleeve	0.08 ... 2.5 mm ²	0.08 ... 4 mm ²
Standard	IEC 60947-7-1, IEC 60947-7-2, 	IEC 60947-7-1, IEC 60947-7-2,  

Types	Color		
L/L/L/PE	 Gray	8WH2040-4LF00	8WH2040-4LG00

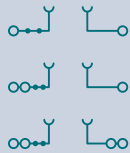
Specific accessories

Covers				
	Color	Width	Article No.	Article No.
	 Gray	2.2 mm	8WH9000-1GE00	–

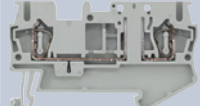

See general accessories, from page 14/55 onwards

8WH2 spring-loaded terminals

Isolating terminals



	Terminal size	
	2.5 mm ²	4 mm ²
Terminal width	5.2 mm	6.2 mm
Max. load current I_{max}	16 A	16 A
Max. operational voltage U_{max}	400 V	400 V
AWG	28 ... 12	28 ... 10
Connection capacity, rigid	0.08 ... 4 mm ²	0.08 ... 6 mm ²
Connection capacity, flexible with end sleeve	0.08 ... 2.5 mm ²	0.08 ... 4 mm ²
Standard	IEC 60947-7-1,	IEC 60947-7-1,

Terminals	Color		
2	Gray	8WH2000-6AF00	8WH2000-6AG00
3	Gray	8WH2003-6AF00	–
4	Gray	8WH2004-6AF00	–

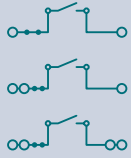
Specific accessories

Covers						
	Width	Color	Terminals	Article No.	Article No.	
	2.2 mm	Gray	2	8WH9000-2GA00	–	
			3	8WH9000-4GA00	–	
			4	8WH9000-5GA00	–	
Compartment partitions						
		Color	Terminals	Article No.	Article No.	
		Gray	2	8WH9070-0AA00	8WH9070-0AA00	
			3	8WH9070-0GA00	–	
			4	8WH9070-0HA00	–	
Cover segments						
	<ul style="list-style-type: none"> For covering multi-wire terminals when mounting two-wire terminals side-by-side 					
		Color	Terminals	Article No.	Article No.	
		Gray	3/4	8WH9000-0GA00	–	
Plug-in zone connectors						
	Types	Color	I_{max}	Illuminated display	Article No.	Article No.
	Isolating plugs	Orange	20 A	–	8WH9040-0DB04	8WH9040-0DB04
	Through-type connectors	Gray	16 A	–	8WH9020-8AB00	8WH9020-8AB00
	Fused connectors ¹⁾	Black	6.3 A	12 ... 30 V, 1 ... 2.5 mA	8WH9040-3AB08	8WH9040-3AB08
				Without	8WH9040-3DB08	8WH9040-3DB08
	Component connectors	Gray	6 A	–	8WH9040-0BB00	8WH9040-0BB00

¹⁾ The G fuse holders must be selected according to the maximum power loss (heat dissipation) of the G fuse links. Depending on the application and method of installation, the heat rise conditions in closed fuse holders must be tested. Higher ambient temperatures represent an additional load for the fuse links. A shift in rated current should therefore be taken into account in such applications.

See general accessories, from page 14/55 onwards

Isolating blade terminals



	Terminal size		
	2.5 mm ²	5.2 mm	4 mm ²
Terminal width	5.2 mm	5.2 mm	6.2 mm
Max. load current I_{max}	16 A	16 A ¹⁾	16 A
Max. operational voltage U_{max}	400 V	400 V	400 V
AWG	28 ... 12	26 ... 14	28 ... 10
Connection capacity, rigid	0.08 ... 4 mm ²	0.14 ... 4 mm ²	0.08 ... 6 mm ²
Connection capacity, flexible with end sleeve	0.08 ... 2.5 mm ²	0.14 ... 2.5 mm ²	0.08 ... 4 mm ²
Standard	IEC 60947-7-1,	IEC 60947-7-1,	IEC 60947-7-1,

Terminals	Color			
2	Gray	8WH2000-6CF00	–	8WH2000-6CG00
3	Gray	–	8WH2003-6CF00	–
4	Gray	–	8WH2004-6CF00	–

¹⁾ On terminals with three and four clamping points, the total current through all connected conductors must not exceed the max. load current.

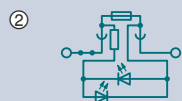
Specific accessories

Covers						
	Color	Width	Terminals	Article No.	Article No.	Article No.
	Gray	2.2 mm	2	8WH9000-2GA00	8WH9000-2GA00	–
			3	8WH9000-4GA00	8WH9000-4GA00	–
			4	8WH9000-5GA00	8WH9000-5GA00	–
Compartment partitions						
	Color		Terminals	Article No.	Article No.	Article No.
	Gray		2	8WH9070-0AA00	8WH9070-0AA00	8WH9070-0AA00
			3	8WH9070-0GA00	8WH9070-0GA00	–
			4	8WH9070-0HA00	8WH9070-0HA00	–
Cover segments						
	Color		Terminals	Article No.	Article No.	Article No.
	Gray		3/4	8WH9000-0GA00	8WH9000-0GA00	–

See general accessories, from page 14/55 onwards

8WH2 spring-loaded terminals

Fuse terminals



	Terminal size		
	4 mm ²		
Terminal width	6.2 mm	8.2 mm	8.2 mm
Max. load current I_{\max}	6.3 A	10 A	30 A
Max. operational voltage U_{\max}	250 V	400 V	400 V
Max. individual power loss as overload protection	1.6 W	–	–
Max. power loss as a group as overload protection	1.6 W	–	–
Max. individual power loss as short-circuit protection	4 W	–	–
Max. power loss as a group as short-circuit protection	2.5 W	–	–
AWG	28 ... 10	28 ... 10	28 ... 10
Connection capacity, rigid	0.08 ... 6 mm ²	0.08 ... 6 mm ²	0.08 ... 6 mm ²
Connection capacity, flexible with end sleeve	0.08 ... 4 mm ²	0.08 ... 4 mm ²	0.08 ... 4 mm ²
Standard	IEC 60947-7-3,	IEC 60947-7-3,	IEC 60947-7-3,

Illuminated display	Color			
For 5 × 20 mm G fuse links				
① Without	● Black	8WH2000-1GG08	–	–
② 15 ... 30 V	● Black	8WH2000-1JG38	–	–
② 30 ... 60 V	● Black	8WH2000-1JG68	–	–
② 110 ... 250 V	● Black	8WH2000-1MG08	–	–
For 6.3 × 32 mm G fuse links				
① Without	● Black	–	8WH2000-1HG08	–
② 100 ... 250 V	● Black	–	8WH2000-1RG08	–
For blade-type fuses according to ISO/DIS 8820 and DIN 72581-3 ¹⁾				
① Without	● Black	–	–	8WH2000-1AG08
② 12 V	● Black	–	–	8WH2000-1BG28
② 24 V	● Black	–	–	8WH2000-1BG38

¹⁾ Blade-type fuses must be ordered separately.

14

Specific accessories

Compartment partitions

	Color	Terminals	Article No.	Article No.	Article No.
	● Gray	2	8WH9070-0AA00	8WH9070-0AA00	8WH9070-0AA00

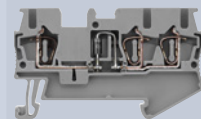
See general accessories, from page 14/55 onwards

8WH2 spring-loaded terminals

Diode terminals



Terminal size	2.5 mm ²
Terminal width	5.2 mm
Max. load current I_{max}	Determined by the diode
Uninterrupted limiting current	0.5 A
Max. operational voltage U_{max}	500 V
Blocking voltage	1300 V
AWG	28 ... 12
Connection capacity, rigid	0.08 ... 4 mm ²
Connection capacity, flexible with end sleeve	0.08 ... 2.5 mm ²
Diode	1N 4007, integrated
Standard	



Terminals	Color	Let-through	
3	● Gray	① From left to right	8WH2003-5DF00
	● Gray	② From right to left	8WH2003-5CF00

Specific accessories

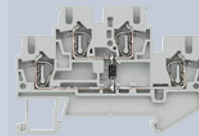
Covers				
	Color	Width	Terminals	Article No.
	● Gray	2.2 mm	3	8WH9000-4GA00
Compartment partitions				
	Color	Terminals	Article No.	
	● Gray	3	8WH9070-0GA00	
Cover segments				
		• For covering multi-wire terminals when mounting two-wire terminals side-by-side		
	Color	Terminals	Article No.	
	● Gray	3	8WH9000-0GA00	

See general accessories, from page 14/55 onwards

Two-tier diode terminals



Terminal size	2.5 mm ²
Terminal width	5.2 mm
Max. load current I_{max}	26 A
Uninterrupted limiting current	0.5 A
Max. operational voltage U_{max}	500 V
Blocking voltage	1300 V
AWG	28 ... 12
Connection capacity, rigid	0.08 ... 4 mm ²
Connection capacity, flexible with end sleeve	0.08 ... 2.5 mm ²
Diode	1N 4007, integrated
Standard	



Types	Color	
① With one diode		
Let-through from top to bottom	● Gray	8WH2020-5AF00
Let-through from bottom left to bottom right	● Gray	8WH2020-5DF00
② With two diodes		
Let-through from top to bottom left and from bottom right to bottom left	● Gray	8WH2020-5KF00
③ With illuminated display		
15 ... 30 V DC/2.5 ... 7.5 A	● Gray	8WH2020-5JF30

Specific accessories

Covers			
	Width	Color	Article No.
	2.2 mm	● Gray	8WH9000-1VA00
Compartment partitions			
		Color	Article No.
		● Gray	8WH9070-0BA00

See general accessories, from page 14/55 onwards

8WH5 combination plug-in terminals

Through-type terminals



Terminal size

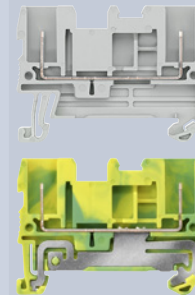
2.5 mm²

Terminal width 5.2 mm

Max. load current I_{\max} 24 A

Max. operational voltage U_{\max} 500 V

Standard IEC 61984,

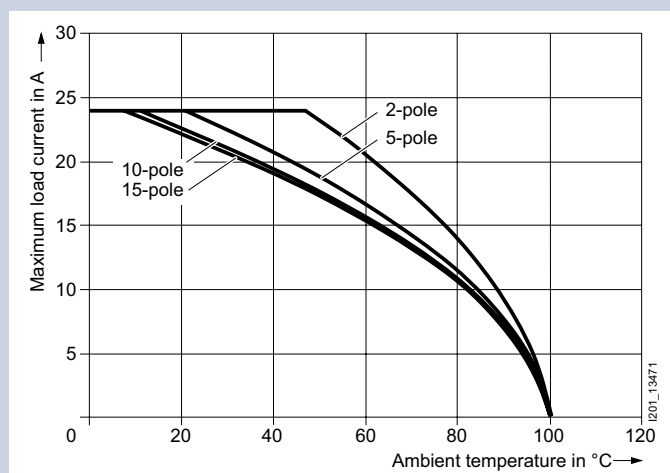


Terminals	Color	Combination plug-in connection
① Through-type terminals		
2	● Gray	8WH5000-0AF00
	● Blue	8WH5000-0AF01
② PE through-type terminals		
2	● Green-yellow	8WH5000-0CF07

Specific accessories

Covers				
	Terminals	Color	Width	Article No.
	2	● Gray	2.2 mm	8WH9000-1VA00
Compartment partitions				
	Terminals	Color		Article No.
	2	● Gray		8WH9070-0BA00

14 See general accessories, from page 14/55 onwards



Derating curve for 8WH5000-0AF00

Hybrid through-type terminals



	Terminal size	2.5 mm ²
	Terminal width	5.2 mm
	Max. load current I_{max}/cross-section	24 A/2.5 mm ²
	Max. operational voltage U_{max}	500 V
	AWG	26 ... 12
	Connection capacity, rigid	0.14 ... 4 mm ²
	Connection capacity, flexible with end sleeve	0.14 ... 2.5 mm ²
	Standard	

Terminals	Color	iPo plug-in connection and combination plug-in connection
① Hybrid through-type terminals		
2	● Gray	8WH5100-2PF00
② PE hybrid through-type terminals		
2	● Green-yellow	8WH5100-3PF07





Specific accessories










Covers				
	Terminals	Color	Width	Article No.
	2	● Gray	2.2 mm	8WH9000-1GA00
Compartment partitions				
	Terminals	Color		Article No.
	4	● Gray		8WH9070-0HA00

See general accessories, from page 14/55 onwards

8WH5 combination plug-in terminals






8WH9 plugs

	Terminal size 2.5 mm ²	
Terminal width	5.2 mm	5.2 mm
Max. load current I_{\max}	24 A	24 A
Max. operational voltage U_{\max}	500 V	500 V
AWG	28 ... 12	28 ... 12
Connection capacity, rigid	0.08 ... 4 mm ²	0.08 ... 4 mm ²
Connection capacity, flexible with end sleeve	0.08 ... 2.5 mm ²	0.08 ... 2.5 mm ²
Number of poles	1P	1P
Standard		
		

Version	Color	With slot for comb	Without slot for comb
Plug			
Left element	 Gray	8WH9040-1DB00	8WH9040-1AB00
	 Blue	8WH9040-1DB01	8WH9040-1AB01
Central element	 Gray	8WH9040-1EB00	8WH9040-1BB00
	 Blue	8WH9040-1EB01	8WH9040-1BB01
Right element	 Gray	8WH9040-1FB00	8WH9040-1CB00
	 Blue	8WH9040-1FB01	8WH9040-1CB01
PE plugs			
Left element	 Green-yellow	8WH9040-1DB07	8WH9040-1AB07
Central element	 Green-yellow	8WH9040-1EB07	–
Right element	 Green-yellow	8WH9040-1FB07	8WH9040-1CB07

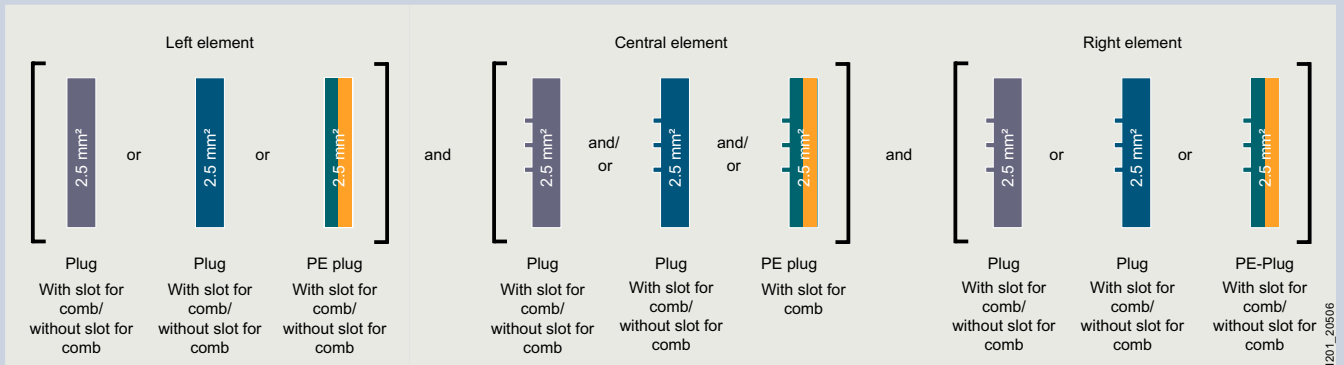
14

Specific accessories

Latches				
	Version	Color	Article No.	Article No.
	With strain relief	 Orange	8WH9050-2BA04	8WH9050-2BA04
	Without strain relief	 Orange	8WH9050-2AA04	8WH9050-2AA04
Shielding				
	• For connection of shielded cables			
	Cable diameter	Color	Article No.	Article No.
5 ... 10 mm	 Black	8WH9120-0DB08	8WH9120-0DB08	

See general accessories, from page 14/55 onwards

Configuration of combination plug

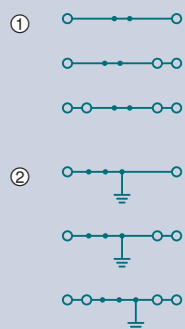


Note:

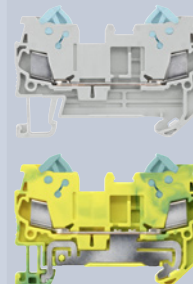
The configuration concept shown is just one example of how combination plugs can be configured.

8WH3 insulation displacement terminals

Through-type terminals



	Terminal size
	1.5 mm ²
Terminal width	5.2 mm
Max. load current I_{\max}	17.5 A ¹⁾
Max. operational voltage U_{\max}	800 V
AWG	24 ... 16
Connection capacity, rigid	0.25 ... 1.5 mm ²
Connection capacity, flexible with end sleeve	0.25 ... 1.5 mm ²



Terminals	Color	
① Through-type terminals		
2	● Gray	8WH3000-0AE00
	● Blue	8WH3000-0AE01
3	● Gray	8WH3003-0AE00
	● Blue	8WH3003-0AE01
4	● Gray	8WH3004-0AE00
	● Blue	8WH3004-0AE01
② PE through-type terminals		
2	● Green-yellow	8WH3000-0CE07
3	● Green-yellow	8WH3003-0CE07
4	● Green-yellow	8WH3004-0CE07

¹⁾ On terminals with three and four clamping points, the total current through all connected conductors must not exceed the maximum load current.

Specific accessories

Covers



Terminals	Color	Width	Article No.
2	● Gray	2.2 mm	8WH9001-1AA00
3	● Gray	2.2 mm	8WH9001-2AA00
4	● Gray	2.2 mm	8WH9001-4AA00

Compartment partitions



Terminals	Color	Width	Article No.
2	● Gray	2 mm	8WH9070-0JA00
4	● Gray	2 mm	8WH9070-0MA00

Cover segments



- For covering multi-wire terminals when mounting two-wire terminals side-by-side

Terminals	Color	Article No.
3	● Gray	—

See general accessories, from page 14/55 onwards

Two-tier terminals



Terminal size

1.5 mm²

Terminal width 5.2 mm

Max. load current I_{\max} 17.5 A

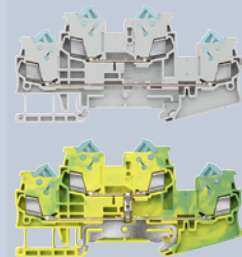
Max. operational voltage U_{\max} 500 V

AWG 24 ... 16

Connection capacity, rigid 0.25 ... 1.5 mm²

Connection capacity, flexible with end sleeve 0.25 ... 1.5 mm²

Standard



Version	Color	
① Two-tier terminals		
Without equipotential bonding	Gray	8WH3020-0AE00
	Blue	8WH3020-0AE01
② PE two-tier terminals		
	Green-yellow	8WH3020-0CE07

Specific accessories

Covers



Width
2.2 mm

Color
 Gray

Article No.
8WH9001-1BA00

Compartment partitions



Color
 Gray

Article No.
8WH9070-0MA00

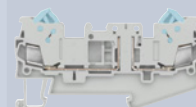
See general accessories, from page 14/55 onwards

8WH3 insulation displacement terminals

Isolating terminals








Terminal size	1.5 mm²
Terminal width	5.2 mm
Max. load current I_{max}	16 A
Max. operational voltage U_{max}	400 V
AWG	24 ... 16
Connection capacity, rigid	0.25 ... 1.5 mm ²
Connection capacity, flexible with end sleeve	0.25 ... 1.5 mm ²
Standard	5V_{US}



Terminals	Color	Article No.
2	● Gray	8WH3000-6AE00

Specific accessories

Covers					
	Width	Color			Article No.
	2.2 mm	● Gray			8WH9001-2AA00
Plug-in zone connectors					
	Types	Color	I_{max}	Illuminated display	Article No.
	Isolating plugs	● Orange	–	–	8WH9040-0DB04
	Through-type connectors	● Gray	16 A	–	8WH9020-8AB00
	Fused connectors ¹⁾	● Black	6.3 A	12 ... 30 V, 1 ... 2.5 mA Without	8WH9040-3AB08 8WH9040-3DB08
	Component connectors	● Gray	6 A	–	8WH9040-0BB00

¹⁾ The G fuse holders must be selected according to the maximum power loss (heat dissipation) of the G fuse links. Depending on the application and method of installation, the heat rise conditions in closed fuse holders must be tested. Higher ambient temperatures represent an additional load for the fuse links. A shift in rated current should therefore be taken into account in such applications.

See general accessories, from page 14/55 onwards

8WH screw terminals

8WH1 through-type terminals



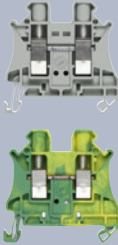


	Terminal size	
	2.5 mm ²	4 mm ²
Terminal width	5.2 mm	6.2 mm
Max. load current I_{max}	32 A	41 A
Max. operational voltage U_{max}	1000 V	1000 V
AWG	26 ... 12	26 ... 10
Connection capacity, one rigid conductor	0.14 ... 4 mm ²	0.14 ... 6 mm ²
Connection capacity, two rigid conductors	0.14 ... 1.5 mm ²	0.14 ... 1.5 mm ²
Connection capacity, one flexible conductor with end sleeve	0.14 ... 2.5 mm ²	0.14 ... 4 mm ²
Connection capacity, two flexible conductors with end sleeve	0.14 ... 1.5 mm ²	0.14 ... 1.5 mm ²
Tightening torque	0.5 ... 0.6 Nm	0.6 ... 0.8 Nm
Standard	IEC 60947-7-1, IEC 60947-7-2, cULus, c	IEC 60947-7-1, IEC 60947-7-2, cULus, c

Terminals	Color		
① Through-type terminals			
2	<ul style="list-style-type: none"> ● Gray ● Blue ● Orange ● Red ● Black ● Green ● Yellow 	8WH1000-0AF00 8WH1000-0AF01 8WH1000-0AF04 8WH1000-0AF02 8WH1000-0AF08 8WH1000-0AF03 8WH1000-0AF06	8WH1000-0AG00 8WH1000-0AG01 8WH1000-0AG04 8WH1000-0AG02 8WH1000-0AG08 – –
② PE through-type terminals			
2	<ul style="list-style-type: none"> ● Green-yellow 	8WH1000-0CF07	8WH1000-0CG07

Specific accessories

Covers				
	Width	Color	Article No.	Article No.
	2.2 mm	● Gray	8WH9000-1PA00	8WH9000-1PA00
Compartment partitions				
	Width	Color	Article No.	Article No.
	2 mm	● Gray	8WH9070-6BA00	8WH9070-6BA00
Reducing combs				
	Version	Color	Article No.	Article No.
	From screw to screw	● Turquoise	–	–
	From screw to spring	● Turquoise	–	–
Warning covers for 8WH1				
	Image	Color	Article No.	Article No.
	Lightning symbol	● Yellow	8WH9060-5BA06	8WH9063-5BA06

See general accessories, from page 14/55 onwards

6 mm ²	10 mm ²	16 mm ²	35 mm ²	
8.2 mm	10.2 mm	12.2 mm	16 mm	16 mm
57 A	76 A	101 A	150 A	–
1000 V	1000 V	1000 V	1000 V	–
24 ... 8	20 ... 6	16 ... 4	16 ... 1/0	16 ... 2
0.2 ... 10 mm ²	0.5 ... 16 mm ²	1.5 ... 25 mm ²	1.5 ... 50 mm ²	1.5 ... 35 mm ²
0.2 ... 2.5 mm ²	0.5 ... 4 mm ²	1 ... 6 mm ²	1.5 ... 16 mm ²	1.5 ... 16 mm ²
0.25 ... 6 mm ²	0.5 ... 10 mm ²	1 ... 16 mm ²	1.5 ... 35 mm ²	1.5 ... 35 mm ²
0.2 ... 2.5 mm ²	0.5 ... 4 mm ²	1 ... 6 mm ²	1.5 ... 10 mm ²	1.5 ... 10 mm ²
1.5 ... 1.8 Nm	1.6 ... 1.8 Nm	2.5 ... 3.0 Nm	3.2 ... 3.7 Nm	3.2 ... 3.7 Nm
IEC 60947-7-1, IEC 60947-7-2, cULus, CE	IEC 60947-7-1, IEC 60947-7-2, cULus, CE	IEC 60947-7-1, IEC 60947-7-2, cULus, CE	IEC 60947-7-1, IEC 60947-7-2, cULus, CE	IEC 60947-7-1, IEC 60947-7-2, cULus, CE
				

8WH1000-0AH00	8WH1000-0AJ00	8WH1000-0AK00	8WH1000-0AM00	–
8WH1000-0AH01	8WH1000-0AJ01	8WH1000-0AK01	8WH1000-0AM01	–
–	–	–	–	–
8WH1000-0AH02	–	–	–	–
8WH1000-0AH08	–	–	–	–
–	–	–	–	–
–	–	–	–	–
8WH1000-0CH07	8WH1000-0CJ07	8WH1000-0CK07	–	8WH1000-0CM07

Article No.	Article No.	Article No.	Article No.	Article No.
8WH9000-1PA00	8WH9000-1PA00	8WH9076-1PA00	–	–
Article No.	Article No.	Article No.	Article No.	Article No.
8WH9070-6BA00	8WH9070-6BA00	–	–	–
Article No.	Article No.	Article No.	Article No.	Article No.
8WH9002-8AC10	–	8WH9002-8EC10	8WH9002-8GC10	8WH9002-8GC10
–	–	8WH9002-8FC10	8WH9002-8HC10	8WH9002-8HC10
Article No.	Article No.	Article No.	Article No.	Article No.
8WH9064-5BA06	8WH9065-5BA06	8WH9066-5BA06	8WH9067-5BA06	8WH9067-5BA06

8WH screw terminals

8WH1 through-type terminals for high-current applications



	Terminal size				
	50 mm ²	70 mm ²	95 mm ²	150 mm ²	240 mm ²
Terminal width	20 mm	20 mm	25 mm	31 mm	36 mm
Max. load current I_{max}	150 A	192 A	232 A	309 A	415 A
Max. operational voltage U_{max}	1000 V	1000 V	1000 V	1000 V	1000 V
AWG	6 ... 0	4 ... 000	4 ... 000	2 ... 300	00 ... 500
Connection capacity, rigid	16 ... 70 mm ²	16 ... 95 mm ²	25 ... 95 mm ²	35 ... 150 mm ²	70 ... 240 mm ²
Connection capacity, flexible with end sleeve	25 ... 50 mm ²	16 ... 70 mm ²	35 ... 95 mm ²	50 ... 150 mm ²	70 ... 185 mm ²
Tightening torque	6 ... 8 Nm	8 ... 10 Nm	15 ... 20 Nm	25 ... 30 Nm	25 ... 30 Nm
Standard	IEC 60947-7-1, IEC 60947-7-2, 	IEC 60947-7-1, IEC 60947-7-2, 	IEC 60947-7-1, IEC 60947-7-2, 	IEC 60947-7-1, 	IEC 60947-7-1,

Terminals	Color					
① Through-type terminals						
2		8WH1000-0AN00	8WH1000-0AP00	8WH1000-0AQ00	8WH1000-0AS00	8WH1000-0AU00
		8WH1000-0AN01	8WH1000-0AP01	8WH1000-0AQ01	8WH1000-0AS01	8WH1000-0AU01
② PE through-type terminals						
2		8WH1000-0CN07	8WH1000-0CP07	8WH1000-0CQ07	–	–

Specific accessories

Tap-off terminal



- When wiring a tap-off with a smaller cross-section, observe the overload and short-circuit strength specified in VDE 0100 Part 430

I_{max}	Cross-section	Article No.	Article No.	Article No.	Article No.	Article No.
57 A	10 mm ²	8WH9120-0AA00	–	8WH9120-0BA00	8WH9120-0CA00	8WH9120-0CA00

Insertion profiles



- Evens out the prismatic sleeve base when using flat conductors

Article No.	Article No.	Article No.	Article No.	Article No.
8WH9020-3MA00	–	8WH9020-3NA00	8WH9020-3PA00	8WH9020-3PA00

Combs



- Fully insulated, fitted in the clamping sleeve and latched with the terminal enclosure

I_{max}	Number of poles	Article No.	Article No.	Article No.	Article No.	Article No.
232 A	2-pole	–	–	8WH9020-3AA00	8WH9020-3CA00	–
	3-pole	–	–	8WH9020-3BA00	8WH9020-3DA00	–
320 A	2-pole	–	–	–	–	8WH9020-3EA00
	3-pole	–	–	–	–	8WH9020-3FA00

Permanent links



- For cross links
- Screw heads with insulating collar
- Remove partition first

I_{max}	Number of poles	Article No.	Article No.	Article No.	Article No.	Article No.
150 A	2-pole	8WH9020-6HC00	8WH9020-3AH00	–	–	–
	3-pole	8WH9020-6HD00	8WH9020-3AJ00	–	–	–

See general accessories, from page 14/55 onwards

8WH1 two-tier terminals



	Terminal size	
	2.5 mm ²	4 mm ²
Terminal width	5.2 mm	6.2 mm
Max. load current I_{max}	28 A	36 A
Max. operational voltage U_{max}	500 V	800 V
AWG	26 ... 12	26 ... 10
Connection capacity, one rigid conductor	0.14 ... 4 mm ²	0.14 ... 6 mm ²
Connection capacity, two rigid conductors	0.14 ... 1.5 mm ²	0.14 ... 1.5 mm ²
Connection capacity, one flexible conductor with end sleeve	0.14 ... 2.5 mm ²	0.14 ... 4 mm ²
Connection capacity, two flexible conductors with end sleeve	0.14 ... 1.5 mm ²	0.14 ... 1.5 mm ²
Tightening torque	0.5 ... 0.6 Nm	0.6 ... 0.8 Nm
Standard		

Version	Color		
1 Two-tier terminals			
Without equipotential bonding	● Gray	8WH1020-0AF00	8WH1020-0AG00
	● Blue	8WH1020-0AF01	8WH1020-0AG01
With equipotential bonding	● Gray	8WH1025-0AF00	8WH1025-0AG00
2 PE two-tier terminals			
	● Green-yellow	8WH1020-0CF07	8WH1020-0CG07

Specific accessories





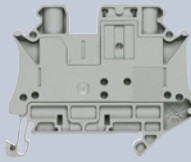
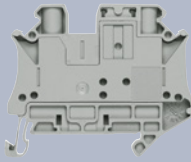
Covers				
	Width	Color	Article No.	Article No.
	2.2 mm	● Gray	8WH9000-1QA00	8WH9000-1QA00
Compartment partitions				
	Width	Color	Article No.	Article No.
	2 mm	● Gray	8WH9070-6FA00	8WH9070-6FA00
Spacer plates				
	• Compensates for tier offset if other terminals are mounted side by side			
	Width	Color	Article No.	Article No.
	2.5 mm	● Gray	8WH9160-0AA00	8WH9160-0AA00

See general accessories, from page 14/55 onwards

8WH screw terminals









8WH1 isolating terminals



	Terminal size	
	4 mm ²	6 mm ²
Terminal width	6.2 mm	8.2 mm
Max. load current I_{max}	20 A	20 A
Max. operational voltage U_{max}	400 V	500 V
AWG	26 ... 10	24 ... 8
Connection capacity, one rigid conductor	0.14 ... 6 mm ²	0.2 ... 10 mm ²
Connection capacity, two rigid conductors	0.14 ... 1.5 mm ²	0.2 ... 2.5 mm ²
Connection capacity, one flexible conductor with end sleeve	0.14 ... 6 mm ²	0.2 ... 10 mm ²
Connection capacity, two flexible conductors with end sleeve	0.14 ... 1.5 mm ²	0.2 ... 2.5 mm ²
Tightening torque	0.6 ... 0.8 Nm	1.5 ... 1.8 Nm
Standard	 	 
		

Terminals	Color		
2	 Gray	8WH1000-6AG00	8WH1000-6AH00

Specific accessories

Plug-in zone connectors						
	Types	Color	I_{max}	Illuminated display	Article No.	Article No.
	Isolating plugs	 Orange	–	–	8WH9040-0DB04	8WH9040-0DB04
	Through-type connectors	 Gray	16 A	–	8WH9020-8AB00	8WH9020-8AB00
	Fused connectors ¹⁾	 Black	6.3 A	12 ... 30 V, 1 ... 2.5 mA	8WH9040-3AB08	8WH9040-3AB08
				Without	8WH9040-3DB08	8WH9040-3DB08
	Component connectors	 Gray	6 A	–	8WH9040-0BB00	8WH9040-0BB00

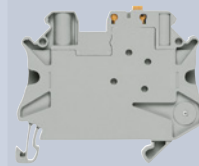
¹⁾ The G fuse holders must be selected according to the maximum power loss (heat dissipation) of the G fuse links. Depending on the application and method of installation, the heat rise conditions in closed fuse holders must be tested. Higher ambient temperatures represent an additional load for the fuse links. A shift in rated current should therefore be taken into account in such applications.

See general accessories, from page 14/55 onwards

8WH1 isolating blade terminals



	Terminal size
	4 mm ²
Terminal width	6.2 mm
Max. load current I_{max}	20 A
Max. operational voltage U_{max}	500 V
AWG	26 ... 12
Connection capacity, one rigid conductor	0.14 ... 4 mm ²
Connection capacity, two rigid conductors	0.14 ... 1.5 mm ²
Connection capacity, one flexible conductor with end sleeve	0.14 ... 4 mm ²
Connection capacity, two flexible conductors with end sleeve	0.14 ... 1.5 mm ²
Tightening torque	0.6 ... 0.8 Nm
Standard	IEC 60947-1, IEC 60947-2



Terminals	Color	
2	● Gray	8WH1000-6CG00

Specific accessories

Warning covers for 8WH1







Image	Color	Article No.
Lightning symbol	● Yellow	8WH9063-5BA06

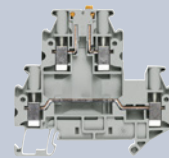
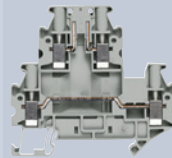
See general accessories, from page 14/55 onwards

8WH screw terminals

8WH1 two-tier terminals with isolating function



		Terminal size 4 mm ²	
Terminal width		6.2 mm	6.2 mm
Max. load current I_{max}		38 A	38 A
Max. operational voltage U_{max}		500 V	500 V
AWG		26 ... 10	26 ... 10
Connection capacity, one rigid conductor		0.14 ... 6 mm ²	0.14 ... 6 mm ²
Connection capacity, two rigid conductors		0.14 ... 1.5 mm ²	0.14 ... 1.5 mm ²
Connection capacity, one flexible conductor with end sleeve		0.14 ... 6 mm ²	0.14 ... 6 mm ²
Connection capacity, two flexible conductors with end sleeve		0.14 ... 1.5 mm ²	0.14 ... 1.5 mm ²
Tightening torque		0.6 ... 0.8 Nm	0.6 ... 0.8 Nm
Standard		 	 



Version	Color		
① Isolating terminal			
Isolating terminal in the upper tier	● Gray	8WH1020-6AG00	–
② Isolating blade			
Isolating blade in the upper tier	● Gray	–	8WH1020-6AC00

Specific accessories

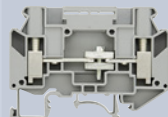
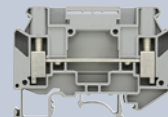
Covers				
	Width	Color	Article No.	Article No.
	2.2 mm	● Gray	8WH9000-1QA00	8WH9000-1QA00
Compartment partitions				
	Width	Color	Article No.	Article No.
	2 mm	● Gray	8WH9070-6FA00	8WH9070-6FA00
Spacer plates				
	• Compensates for tier offset if other terminals are mounted side by side			
	Width	Color	Article No.	Article No.
2.5 mm	● Gray	8WH9160-0AA00	8WH9160-0AA00	

See general accessories, from page 14/55 onwards

8WH1 measuring transformer isolating terminals









	Terminal size 6 mm ²	
Terminal width	8.2 mm	8.2 mm
Rated uninterrupted current I_U	41 A	41 A
Rated insulation voltage U_i	500 V	800 V
AWG	24	8
Connection capacity, rigid	0.5 ... 10 mm ²	0.5 ... 10 mm ²
Connection capacity, flexible with end sleeve	0.5 ... 6 mm ²	0.5 ... 6 mm ²
Disconnect slide tightening torque	0.6 ... 0.8 Nm	–
Tightening torque	1.5 ... 1.6 Nm	1.5 ... 1.6 Nm
Standard	UL, CE	UL, CE

Terminals	Color		
1 Isolating terminals			
2 recesses for screwing in the test sockets	● Gray	8WH1000-7AH00	–
2 Through-type terminals with identical contour			
2 recesses for screwing in the test sockets	● Gray	–	8WH1000-7BH00

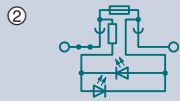
Specific accessories




Covers				
	Width	Color	Article No.	Article No.
	2.2 mm	● Gray	8WH9000-3UA00	8WH9000-3UA00
Disconnecting links				
	<ul style="list-style-type: none"> For bridging two adjacent terminals Cannot be used with the bare 8WH9010-0MB12 test socket 			
	Tightening torque	Number of poles	Color	Article No.
	0.6 ... 0.8 Nm	2-pole	● Gray	8WH9021-0AC00
				Article No.
				8WH9021-0AC00
Connecting combs, separable				
	<ul style="list-style-type: none"> Consisting of connection wire, spacer sleeves and screws For bridging terminals, the connection wire is adjustable Cannot be used with the bare 8WH9010-0MB12 test socket 			
	Tightening torque	Number of poles	Color	Article No.
	0.6 ... 0.8 Nm	10-pole	● Gray	8WH9021-0AL00
				Article No.
				8WH9021-0AL00
Short-circuiting plugs, fully insulated				
	<ul style="list-style-type: none"> For short-circuiting adjacent terminals For simple transformer measurements Required when the bare 8WH9010-0MB12 test adapter is used in the measuring transformer terminal 			
	I_{max}	Number of poles	Color	Article No.
	20 A	2-pole	● Black	8WH9010-0BC08
				Article No.
				8WH9010-0BC08
Test sockets, insulated				
	<ul style="list-style-type: none"> For screwing into the measuring transformer terminals The 8WH9021-0AC00 disconnecting link shall be used for short-circuiting adjacent terminals 			
	Tightening torque	Color	Article No.	Article No.
	0.6 ... 0.8 Nm	● Green	8WH9010-0MB03	8WH9010-0MB03
		● Violet	8WH9010-0MB11	8WH9010-0MB11
		● Yellow	8WH9010-0MB06	8WH9010-0MB06
Test sockets, bare				
	<ul style="list-style-type: none"> For screwing into the measuring transformer terminals For simple transformer measurements For tapping with test plug The 8WH9010-0BC08 short-circuiting plug shall be used for short-circuiting adjacent terminals 			
	Tightening torque	Article No.	Article No.	
	0.6 ... 0.8 Nm	8WH9010-0MB12	8WH9010-0MB12	

See general accessories, from page 14/55 onwards

8WH screw terminals


8WH1 fuse terminals



	Terminal size	
	4 mm ²	6 mm ²
Terminal width	6.2 mm	8.2 mm
Max. load current I_{max}	6.3 A	10 A
Max. operational voltage U_{max}	500 V	630 V
AWG	26 ... 10	24 ... 8
Connection capacity, one rigid conductor	0.14 ... 6 mm ²	0.2 ... 10 mm ²
Connection capacity, two rigid conductors	0.14 ... 1.5 mm ²	0.2 ... 2.5 mm ²
Connection capacity, one flexible conductor with end sleeve	0.14 ... 6 mm ²	0.2 ... 10 mm ²
Connection capacity, two flexible conductors with end sleeve	0.14 ... 1.5 mm ²	0.2 ... 2.5 mm ²
Tightening torque	0.6 ... 0.8 Nm	1.5 ... 1.8 Nm
Standard	IEC 60947-7-3,  	IEC 60947-7-3,  
		

LED	Color		
For 5 × 20 mm G fuse links			
① Without	● Black	8WH1000-1GG08	–
② AC/DC with LED 10 ... 30 V	● Black	8WH1000-1KG38	–
② AC/DC with LED 110 ... 250 V	● Black	8WH1000-1MG88	–
For 6.3 × 32 mm G fuse links (inch fuses)			
① Without	● Black	–	8WH1000-1HH08
② AC/DC with LED 12 ... 30 V	● Black	–	8WH1000-1PH38

Specific accessories

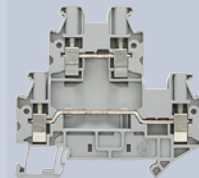
Plug-in zone connectors						
Version	Color	I_{max}	Illuminated display	Article No.	Article No.	
Fused connectors ¹⁾	● Black	6.3 A	12 ... 30 V, 1 ... 2.5 mA	8WH9040-3AB08	8WH9040-3AB08	
			Without	8WH9040-3DB08	8WH9040-3DB08	
Reducing combs						
	• For connecting terminals from terminal size 6 mm ² to 2.5 mm ² or 4 mm ²					
	Version	Color	Article No.	Article No.		
From screw to screw	● Turquoise	–	8WH9002-8AC10			

¹⁾ The G fuse holders must be selected according to the maximum power loss (heat dissipation) of the G fuse links. Depending on the application and method of installation, the heat rise conditions in closed fuse holders must be tested. Higher ambient temperatures represent an additional load for the fuse links. A shift in rated current should therefore be taken into account in such applications.

See general accessories, from page 14/55 onwards

8WH1 two-tier terminals for soldering of components ¹⁾




	Terminal size
	2.5 mm ²
Terminal width	5.2 mm
Max. load current I_{\max}	28 A
Max. operational voltage U_{\max}	500 V
AWG	26 ... 10
Connection capacity, one rigid conductor	0.14 ... 4 mm ²
Connection capacity, two rigid conductors	0.14 ... 1.5 mm ²
Connection capacity, one flexible conductor with end sleeve	0.14 ... 4 mm ²
Connection capacity, two flexible conductors with end sleeve	0.14 ... 1.5 mm ²
Tightening torque	0.5 ... 0.6 Nm
Standard	UL 504, CE



Terminals	Color	
4	● Gray	8WH1020-5LF00

¹⁾ Supplied without components; the appropriate components (resistors, diodes, capacitors, ...) are to be soldered in by user

Specific accessories

Covers			
	Width	Color	Article No.
	2.2 mm	● Gray	8WH9000-1QA00
Compartment partitions			
	Width	Color	Article No.
	2 mm	● Gray	8WH9070-6FA00
Spacer plates			
	• Compensates for tier offset if other terminals are mounted side by side		
	Width	Color	Article No.
	2.5 mm	● Gray	8WH9160-0AA00

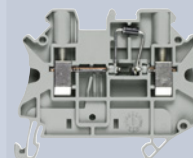
See general accessories, from page 14/55 onwards

8WH screw terminals

8WH1 diode terminals



Terminal size	
4 mm ²	
Terminal width	6.2 mm
Uninterrupted limiting current	0.5 A
Max. operational voltage U_{\max}	800 V
Blocking voltage	1300 V
AWG	26 ... 10
Connection capacity, one rigid conductor	0.14 ... 6 mm ²
Connection capacity, two rigid conductors	0.14 ... 1.5 mm ²
Connection capacity, one flexible conductor with end sleeve	0.14 ... 4 mm ²
Connection capacity, two flexible conductors with end sleeve	0.14 ... 1.5 mm ²
Tightening torque	0.6 ... 0.8 Nm
Diode	1N 4007, integrated
Standard	UL 95, CE



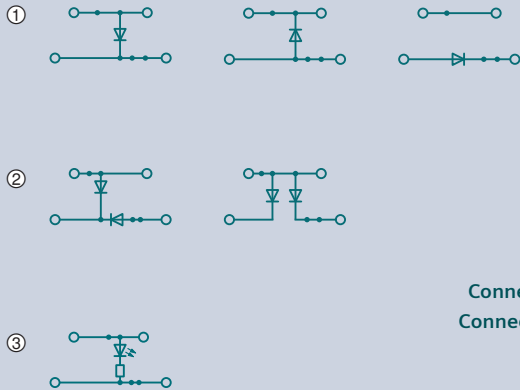
Let-through		Color		
①	From left to right	●	Gray	8WH1000-6LG00
②	From right to left	●	Gray	8WH1000-6KG00

Specific accessories

Covers				
	Width	Color	Article No.	
	2.2 mm	● Gray	8WH9000-2PA00	
Warning covers				
	Image	Color	Article No.	
	Lightning symbol	● Yellow	8WH9063-5CA06	

See general accessories, from page 14/55 onwards

8WH1 two-tier diode terminals



Terminal size

2.5 mm²

Terminal width 5.2 mm

Max. load current I_{max} 28 A

Uninterrupted limiting current 0.5 A

Max. operational voltage U_{max} 500 V

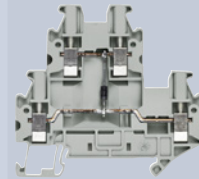
AWG 26 ... 10

Connection capacity, one rigid conductor 0.14 ... 4 mm²Connection capacity, two rigid conductors 0.14 ... 1.5 mm²Connection capacity, one flexible conductor with end sleeve 0.14 ... 2.5 mm²Connection capacity, two flexible conductors with end sleeve 0.14 ... 1.5 mm²

Tightening torque 0.5 ... 0.6 Nm

Diode 1N 4007, integrated

Standard



Types	LED	Color	
① With one diode			
Let-through from top to bottom		● Gray	8WH1020-5AF00
Let-through from bottom to top		● Gray	8WH1020-5BF00
Let-through from bottom left to bottom right		● Gray	8WH1020-5DF00
② With two diodes			
Let-through from top to bottom left and from bottom right to bottom left		● Gray	8WH1020-5FF00
Let-through from top to bottom left and from top to bottom right		● Gray	8WH1020-5HF00
③ With illuminated display			
Let-through from top to bottom	24 V DC	● Gray	8WH1020-5JF30

Specific accessories

Covers



Width	Color	Article No.
2.2 mm	● Gray	8WH9000-1QA00

Compartment partitions



Width	Color	Article No.
2 mm	● Gray	8WH9070-6FA00

Spacer plates







• Compensates for tier offset if other terminals are mounted side by side		
Width	Color	Article No.
2.5 mm	● Gray	8WH9160-0AA00

See general accessories, from page 14/55 onwards

8WH screw terminals

8WH9 shield terminals

	Terminal diameter			
	3 ... 8 mm	3 ... 14 mm	3 ... 20 mm	20 ... 35 mm
Tightening torque	0.6 Nm	0.8 Nm	0.8 Nm	1.5 ... 1.8 Nm
Sheet thickness, mounting plate	1 ... 2 mm	1 ... 2 mm	1 ... 2 mm	1 ... 2 mm
				

Version

For direct shield attachment on conductive mounting plate




For connecting cable shield and enclosure ground	8WH9130-0AA00	8WH9130-0BA00	8WH9130-0CA00	8WH9130-0DA00
--	---------------	---------------	---------------	---------------

For 10 × 3 mm busbars


For connecting cable shield and enclosure ground	8WH9130-0LA00	8WH9130-0MA00	8WH9130-0NA00	8WH9130-0PA00
--	---------------	---------------	---------------	---------------

Specific accessories

N conductor support brackets

	Version	Article No.	Article No.	Article No.	Article No.
	Made of molded plastic and conductive connection with retaining screw	8WH9140-0DA00	8WH9140-0DA00	8WH9140-0DA00	8WH9140-0DA00
	For mounting rail with clearance of approx. 30 mm to the busbar	8WH9140-0BA00	8WH9140-0BA00	8WH9140-0BA00	–
	For mounting rail with clearance of approx. 65 mm to the busbar	8WH9140-0CA00	8WH9140-0CA00	8WH9140-0CA00	–

N busbars, 10 × 3 mm

	Version	Length	Article No.	Article No.	Article No.	Article No.
	Copper, tinned	1000 mm	8WH9030-2AB12	8WH9030-2AB12	8WH9030-2AB12	8WH9030-2AB12

See general accessories, from page 14/55 onwards

Accessories for 8WH terminal blocks

Individual labeling system

Labeling systems for

- Terminal blocks
- Modular installation devices
- Circuit breakers
- Switch disconnectors

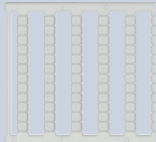
The inscription labels can be inscribed with Murrplastik labeling systems or by hand.

The WIN designation facilitates assignment in the inscription software.

Labeling systems available from:

Murrplastik Systemtechnik GmbH
 Dieselstraße 10
 D-71570 Oppenweiler
 Telephone: +49 7191-482-0
 email: info@murrplastik.de

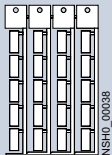
Blank labels



- Horizontal and vertical labeling

Version	Terminal width	Designation	Color	Article No.
Front	3.5 mm	WIN 97	● White	8WH8112-0AA05
	4.2 mm	WIN 97	● White	8WH8112-1AA05
	5.2 and 6.2 mm	WIN 88	● White	8WH8112-2AA05
	8.2, 10.2, 12.2 and 16 mm	WIN 40	● White	8WH8112-4AA05
Flat	3.5 mm	WIN 97	● White	8WH8113-0AA05
	4.2 mm	WIN 180	● White	8WH8113-1AA05
	5.2 mm	WIN 182	● White	8WH8113-1AA05
	6.2 mm	WIN 184	● White	8WH8113-1AA05
	8.2 mm	WIN 186	● White	8WH8113-1AA05
	10.2 mm	WIN 188	● White	8WH8113-1AA05
	12.2 and 16 mm	WIN 46Z	● White	8WH8113-6AA05

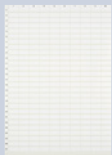
Snap-on device labels



- For identification of, e.g. circuit breakers, contactors and control systems

Version	Designation	Color	Article No.
20 × 7 mm, snap-on hooks at side	WIN 95	● White	8WH8210-0AA55
20 × 7 mm, snap-on hooks at side	WIN 95	● Turquoise	8WH8210-0AA56

Adhesive device labels

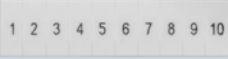
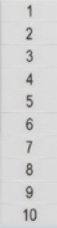
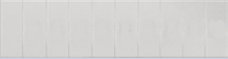
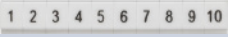

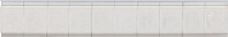


- For identification of, e.g. modular installation devices and switch disconnectors

Types	Designation	Color	Article No.
15 × 6 mm	WIN 098	● White	8WH8210-0AA35
	WIN 099	● Yellow	8WH8210-0AA36
19 × 8 mm	WIN 088	● White	8WH8210-0AA45
	WIN 082	● Yellow	8WH8210-0AA46

Accessories for 8WH terminal blocks

Standard labeling system

				Terminal size	1.5 mm ²	2.5 mm ²
				Terminal width	4.2 mm/5.2 mm (8WH3)	5.2 mm/6.2 mm (8WH3)
Front						
	Vertical	Consecutive numbering	1 ... 10 (10×)	8WH8120-1AB05	8WH8120-2AB05	
			11 ... 20 (10×)	8WH8120-1AB15	8WH8120-2AB15	
			21 ... 30 (10×)	8WH8120-1AB25	8WH8120-2AB25	
			31 ... 40 (10×)	8WH8120-1AB35	8WH8120-2AB35	
			41 ... 50 (10×)	8WH8120-1AB45	8WH8120-2AB45	
			51 ... 60 (10×)	8WH8120-1AB55	8WH8120-2AB55	
			61 ... 70 (10×)	8WH8120-1AB65	8WH8120-2AB65	
			71 ... 80 (10×)	8WH8120-1AB75	8WH8120-2AB75	
			81 ... 90 (10×)	8WH8120-1AB85	8WH8120-2AB85	
			91 ... 100 (10×)	8WH8120-1AC05	8WH8120-2AC05	
	L1, L2, L3, N, PE	–	–	8WH8120-2AA15		
	Custom inscription	–	8WH8120-1XA05-Z Y01	8WH8120-2XA05-Z Y01		
		Horizontal	Consecutive numbering	1 ... 10 (10×)	8WH8140-1AB05	8WH8140-2AB05
				11 ... 20 (10×)	8WH8140-1AB15	8WH8140-2AB15
				21 ... 30 (10×)	8WH8140-1AB25	8WH8140-2AB25
31 ... 40 (10×)				8WH8140-1AB35	8WH8140-2AB35	
41 ... 50 (10×)				–	8WH8140-2AB45	
51 ... 60 (10×)				–	8WH8140-2AB55	
61 ... 70 (10×)				–	8WH8140-2AB65	
71 ... 80 (10×)				–	8WH8140-2AB75	
81 ... 90 (10×)				–	8WH8140-2AB85	
91 ... 100 (10×)				–	8WH8140-2AC05	
Custom inscription	–	8WH8140-1XA05-Z Y01	8WH8140-2XA05-Z Y01			
	Blank	–	–	8WH8110-1AA05	8WH8110-2AA05	
Flat						
	Vertical	Consecutive numbering	1 ... 10 (10×)	8WH8121-1AB05	8WH8121-2AB05	
			11 ... 20 (10×)	8WH8121-1AB15	8WH8121-2AB15	
			21 ... 30 (10×)	8WH8121-1AB25	8WH8121-2AB25	
			31 ... 40 (10×)	8WH8121-1AB35	8WH8121-2AB35	
			41 ... 50 (10×)	8WH8121-1AB45	8WH8121-2AB45	
			51 ... 60 (10×)	8WH8121-1AB55	8WH8121-2AB55	
			61 ... 70 (10×)	–	8WH8121-2AB65	
			71 ... 80 (10×)	–	8WH8121-2AB75	
			81 ... 90 (10×)	–	8WH8121-2AB85	
			91 ... 100 (10×)	–	8WH8121-2AC05	
	Custom inscription	–	8WH8121-1XA05-Z Y01	8WH8121-2XA05-Z Y01		
		Horizontal	Consecutive numbering	1 ... 10 (10×)	8WH8141-1AB05	8WH8141-2AB05
				11 ... 20 (10×)	8WH8141-1AB15	8WH8141-2AB15
				21 ... 30 (10×)	8WH8141-1AB25	8WH8141-2AB25
				31 ... 40 (10×)	8WH8141-1AB35	8WH8141-2AB35
41 ... 50 (10×)				8WH8141-1AB45	8WH8141-2AB45	
51 ... 60 (10×)				–	8WH8141-2AB55	
61 ... 70 (10×)				–	8WH8141-2AB65	
71 ... 80 (10×)				–	8WH8141-2AB75	
81 ... 90 (10×)				–	8WH8141-2AB85	
91 ... 100 (10×)				–	8WH8141-2AC05	
Custom inscription	–	8WH8141-1XA05-Z Y01	8WH8141-2XA05-Z Y01			
	Blank	–	–	8WH8111-1AA05	8WH8111-2AA05	

4 mm ²	6 mm ²	10 and 16 mm ²	35 mm ²
6.2 mm	8.2 mm	10.2 and 12.2 mm	16 mm
Article No.	Article No.	Article No.	Article No.
8WH8120-3AB05	8WH8120-4AB05	8WH8120-5AB05	–
8WH8120-3AB15	8WH8120-4AB15	8WH8120-5AB15	–
8WH8120-3AB25	8WH8120-4AB25	8WH8120-5AB25	–
8WH8120-3AB35	8WH8120-4AB35	8WH8120-5AB35	–
8WH8120-3AB45	8WH8120-4AB45	–	–
8WH8120-3AB55	8WH8120-4AB55	–	–
8WH8120-3AB65	8WH8120-4AB65	–	–
8WH8120-3AB75	8WH8120-4AB75	–	–
8WH8120-3AB85	–	–	–
8WH8120-3AC05	–	–	–
8WH8120-3AA15	8WH8120-4AA15	8WH8120-5AA15	8WH8120-7AA15
8WH8120-3XA05-Z Y01	8WH8120-4XA05-Z Y01	8WH8120-5XA05-Z Y01	8WH8120-7XA05-Z Y01
8WH8140-3AB05	8WH8140-4AB05	8WH8140-5AB05	–
8WH8140-3AB15	8WH8140-4AB15	8WH8140-5AB15	–
8WH8140-3AB25	8WH8140-4AB25	–	–
8WH8140-3AB35	–	–	–
8WH8140-3AB45	–	–	–
8WH8140-3AB55	–	–	–
8WH8140-3AB65	–	–	–
8WH8140-3AB75	–	–	–
8WH8140-3AB85	–	–	–
8WH8140-3AC05	–	–	–
8WH8140-3XA05-Z Y01	8WH8140-4XA05-Z Y01	8WH8140-5XA05-Z Y01	8WH8140-7XA05-Z Y01
8WH8110-3AA05	8WH8110-4AA05	8WH8110-5AA05	8WH8110-7AA05
Article No.	Article No.	Article No.	Article No.
8WH8121-3AB05	8WH8121-4AB05	8WH8121-5AB05	–
8WH8121-3AB15	8WH8121-4AB15	8WH8121-5AB15	–
8WH8121-3AB25	–	8WH8121-5AB25	–
8WH8121-3AB35	–	–	–
8WH8121-3AB45	–	–	–
8WH8121-3AB55	–	–	–
8WH8121-3AB65	–	–	–
8WH8121-3AB75	–	–	–
8WH8121-3AB85	–	–	–
8WH8121-3AC05	–	–	–
8WH8121-3XA05-Z Y01	8WH8121-4XA05-Z Y01	8WH8121-5XA05-Z Y01	–
–	–	–	–
–	–	–	–
–	–	–	–
–	–	–	–
–	–	–	–
–	–	–	–
–	–	–	–
–	–	–	–
–	–	–	–
–	–	–	–
8WH8141-3XA05-Z Y01	8WH8141-4XA05-Z Y01	8WH8141-5XA05-Z Y01	–
8WH8111-3AA05	8WH8111-4AA05	8WH8111-5AA05	8WH8111-7AA05

Accessories for 8WH terminal blocks

Mounting accessories

Lateral mounting test plugs



- For individual assembly of test plug connectors
- Cannot be used for 8WH3 insulation displacement terminals.

Terminal size	Terminal width	Color	Article No.
2.5 mm ²	5.2 mm	● Red	8WH9010-0EB02

Spacer plates



- For skipping single terminals for individual test plug assembly
- Not suitable for 8WH3 insulation displacement terminals

Terminal size	Terminal width	Color	Article No.
2.5 mm ²	5.2 mm	● Red	8WH9010-2BA02

Bare infed terminals, for N busbars



Size	Conductor cross-section	Rated uninterrupted current	Article No.
6 × 6 mm and 10 × 3 mm	Up to 4 mm ²	32 A	8WA2867
	Up to 25 mm ²	76 A	8WA2868
	Up to 35 mm ²	125 A	8WA2870

Terminal strip markers, for end retainers



- Height-adjustable
- For quick-fit end retainers
- Can be provided with two front labels, for terminal width 10.2 mm and terminal strip markers

Labeling field size	Color	Article No.
20 × 8 mm	● Gray	8WH9150-1CA00

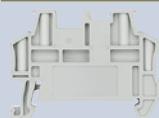
Test adapters



- When plugged in, finger-safe against accidental direct contact according to EN 50274
- For 4 mm test plugs and terminal blocks with 4.2 mm ... 8.2 mm spacing

Color	Article No.
● Gray	8WH9010-0JB00

Quick-fit end retainers



- Can be provided with front labels, for terminal width 5.2 mm and terminal strip markers

Color	Article No.
● Gray	8WH9150-0CA00

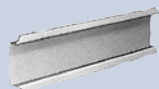
End retainers, steel



- Suitable for 8WA1806 end label
- An 8WA1820 barrier must be inserted if using end retainers against an 8WA189 connection bar (size 2.5)

Mounting width	Article No.
10.3 mm	8WA1805

DIN rails



Version	Material	Norm	Length	Thickness	Article No.
Perforated	Steel, sendzimir-galvanized	EN 60715-35 × 7.5	2 m	1 mm	5ST1145
Non-perforated	Steel, sendzimir-galvanized	EN 60715-35 × 7.5	2 m	1 mm	5ST1141
	Copper	EN 60715-35 × 15	2 m	2.3 mm	8WA7551
	Steel, zinc-plated, chromated	Similar to EN 50022-35 × 15	2 m	1.5 mm	5ST1142

N busbars, 6 × 6 mm



Version	Length	Rated uninterrupted current	Article No.
For four-field	1109 mm	125 A	8GF9324-2

Insulation carriers



Use	Article No.
For mounting insulated mounting rails	8WA1857

Isolating links, 5 × 20 mm



Size	Article No.
5 × 20 mm	8WH9021-0CB12

5 × 25 mm G fuse links



Types	Breaking capacity	Rated uninterrupted current	Article No.
Quick	Large	1 A	8WA1822-7EF16
		1.6 A	8WA1822-7EF18
		2.5 A	8WA1822-7EF21
		4 A	8WA1822-7EF23
		6.3 A	8WA1822-7EF25
Slow	Small	1 A	8WA1822-7EF76
		1.6 A	8WA1822-7EF78
		2.5 A	8WA1822-7EF81
		4 A	8WA1822-7EF83
		6.3 A	8WA1822-7EF85

Reducing combs



- For connecting two through-type terminals
- Cannot be used for 8WH1 through-type terminals and 8WH3 insulation displacement terminals

From terminal size	To terminal size	Color	Article No.
2.5 mm ² or 4 mm ²	1.5 mm ²	Turquoise	8WH9020-0CC10
	6 mm ²	Turquoise	8WH9020-0FC10
	10 mm ²	Turquoise	8WH9020-0AC10
	16 mm ²	Turquoise	8WH9020-0BC10
	35 mm ²	Turquoise	8WH9020-0EC10
16 mm ²	35 mm ²	Turquoise	8WH9020-0DC10

Connecting combs

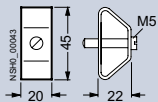


Terminal size	Terminal width	Max. load current I_{max}	Used for 8WH3	Number of poles	Article No.
1.5 mm ²	4.2 mm	17.5 A	Cannot be used	2-pole	8WH9020-6AC10
				3-pole	8WH9020-6AD10
				4-pole	8WH9020-6AE10
				5-pole	8WH9020-6AF10
				10-pole	8WH9020-6AL10
2.5 mm ²	5.2 mm	24 A	Can be used for terminal size 1.5 mm ²	20-pole	8WH9020-6AS10
				2-pole	8WH9020-6BC10
				3-pole	8WH9020-6BD10
				4-pole	8WH9020-6BE10
				5-pole	8WH9020-6BF10
4 mm ²	6.2 mm	32 A	Can be used for terminal size 2.5 mm ²	10-pole	8WH9020-6BL10
				20-pole	8WH9020-6BS10
				50-pole	8WH9020-6BT10
				2-pole	8WH9020-6CC10
				3-pole	8WH9020-6CD10
6 mm ²	8.2 mm	41 A	Cannot be used	4-pole	8WH9020-6CE10
				5-pole	8WH9020-6CF10
				10-pole	8WH9020-6CL10
				20-pole	8WH9020-6CS10
				50-pole	8WH9020-6CT10
10 mm ²	10.2 mm	57 A	Cannot be used	2-pole	8WH9020-6DC10
				3-pole	8WH9020-6DD10
				4-pole	8WH9020-6DE10
				5-pole	8WH9020-6DF10
16 mm ²	12.2 mm	76 A	Cannot be used	10-pole	8WH9020-6DL10
				2-pole	8WH9020-6EC10
35 mm ²	16 mm	101 A	Cannot be used	2-pole	8WH9020-6FC10
				2-pole	8WH9020-6GC10

Accessories for 8WH terminal blocks

Mounting accessories

Spacer brackets



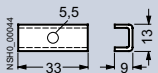
Version

For raised mounting of terminal strips

Article No.

8WA753

Spacers



Version

For raised mounting of terminal strips

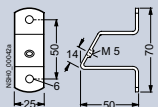
Drill hole

5.5 mm

Article No.

8WA752

Mounting brackets



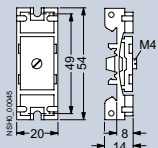
Version

For mounting rails

Article No.

8WA746

Insulation carriers



Version

For insulated mounting of mounting rails onto plates, frame profiles and DIN rails EN 50022-35

Article No.

8WA1857

Reliable and efficient power supply in infrastructure and industrial applications

The electrical power distribution in buildings, infrastructure and industry is undergoing a transformation. A growing number of electrical loads, fluctuating load conditions and an increasing level of automation pose new challenges for switchboard manufacturers and electrical planners. Availability, safety and efficiency of the power distribution system are becoming more important. This is reflected in detailed standards and regulations and in requirements for company power management.

The planning and operation of electrical power distribution systems are becoming more complex, and the technical demands placed on the underlying systems and products are rising – in particular with respect to flexibility, communication capability and integrability. A data-based engineering process, hardware and software systems, an intelligent data management must all interact smoothly to provide optimum support to dynamic industrial and infrastructure processes.

The basis for a reliable and efficient power supply is provided by our portfolio of power distribution boards and distribution boards with innovative products and systems. A data-based engineering process with SIMARIS software tools, high availability of product-related data support the value chain of the switchgear manufacturer – from planning to documentation of the installation.



Switchboards, Distribution Boards and Small Distribution Boards



All the information you need	15/2
Quick selection guide	15/4
Distribution systems	15/4
System overview	15/10
SIMARIS planning tools	15/14
SIVACON S8 power distribution boards and motor control centers new	15/16
System overview	15/16
Design	15/18
ALPHA 3200 Eco power distribution boards new	15/20
System overview	15/20
Frame and enclosure	15/22
Doors	15/26
Busbar systems	15/28
Section expansion	15/30
Accessories	15/52
SIVACON S4 power distribution boards	15/54
System overview	15/54
Frame and enclosure	15/56
Busbar systems	15/77
Section expansion	15/80
Internal separation	15/148
Accessories	15/158
ALPHA UNIVERSAL distribution boards (NF technology)	15/160
System overview	15/160
Special colors for ALPHA	15/162
ALPHA 800 UNIVERSAL floor-mounted distribution boards	15/164
ALPHA 630 UNIVERSAL wall-mounted distribution boards	15/166
ALPHA 630 UNIVERSAL floor-mounted distribution boards	15/168
ALPHA 125 UNIVERSAL distribution boards	15/172
Assembly kits	15/174
Busbars	15/180
Accessories	15/184
ALPHA distribution boards (DIN technology)	15/192
System overview	15/192
Special colors for ALPHA	15/194
ALPHA 1250 floor-mounted distribution boards	15/196
ALPHA 1250 marshaling boxes	15/198
ALPHA 630 floor-mounted distribution boards	15/200
ALPHA 630 marshaling boxes	15/202
ALPHA 400 distribution boards	15/204
ALPHA 160 distribution boards	15/208
Assembly kits	15/210
Quick-assembly kits	15/224
Busbars	15/226
Accessories	15/227
Small distribution boards	15/238
System overview	15/238
ALPHA SIMBOX XL small distribution boards	15/240
ALPHA SIMBOX WP small distribution boards	15/243

A multitude of additional information ...

Information + ordering

All the important things at a glance

For information about Switchboards, distribution boards and small distribution boards, please visit our websites
www.siemens.com/sivacon-S8
www.siemens.com/distributionsystems

Your product in detail

The SiePortal platform (knowledge base) provides comprehensive information
www.siemens.com/lowvoltage/product-support

- Brochure
 - SIVACON S8^{plus} – The plus for your business: Intelligent. Flexible. Safe. **(109747937)**

The relevant tender specifications can be found at
www.siemens.com/tenderspecifications

Use our conversion tool for quick and easy conversion to Siemens products www.siemens.com/conversion-tool

Siemens YouTube channel

- Power distribution – SIVACON (general) sie.ag/6wacV9
- Siemens SIVACON S4 power distribution boards up to 4000 A sie.ag/6v6kNm

Everything you need for your order

Refer to SiePortal to find an overview of your products (product catalog)

- Switchboards sie.ag/31er6zp
- SIVACON S8 Power distribution boards and motor control centers sie.ag/3EbN0kC
- SIVACON S4 (NF) sie.ag/2JUQwE4
- Distribution boards sie.ag/2kURLd8
- Small distribution boards sie.ag/3I4DUYm
- Planning software sie.ag/2m3oFbS

Direct forwarding to the individual products in SiePortal by clicking on the article number in the catalog or entering this web address incl. article number
www.siemens.com/product_catalog_SIEP?Article No.

Use the competence and experience of our experts at one of the production locations near you
www.siemens.com/sivaconS8-contact
 or call
 +49 (9131) 174-3072

Our certified SIVACON Technology Partners are also available to you for questions relating to the high quality of our low-voltage switchboards
www.siemens.com/sivacon-partnerfinder

The fast track to the experts

Contact persons in your region

We offer a comprehensive portfolio of services. You can find your local contacts at
www.siemens.com/lowvoltage/components/contact

You will find further information on services at
www.siemens.com/service-offers

Competent expert advice on technical questions with a wide range of demand-optimized services for all our products and systems.

Assistance with technical queries is provided at
www.siemens.com/support-request

... can be found in our online services

Commissioning + operation



SIMARIS planning tools

The SIMARIS planning tools effectively assist you in your planning process. Project-specific IFC data (Building Information Modeling) for cross-package planning is also possible.

www.siemens.com/simaris



SIMARIS configuration

The SIMARIS configuration software supports the engineering process of the SIVACON and ALPHA distribution systems from planning right through to plant documentation. www.siemens.com/simarisconfig



Manuals

Manuals can be found in SiePortal at www.siemens.com/lowvoltage/manuals

- Planning Manual
 - SIVACON S8 – Technical planning information (107113936)
- Application Manual
 - SIVACON S4 Power distribution boards up to 6300 A (25909512)



Your product in detail

The SiePortal platform (knowledge base) provides detailed technical information

www.siemens.com/lowvoltage/product-support

- Operating instructions
- Characteristic curves
- Certificates

Online Support app available for download from the [App Store](#) and [Play Store](#)

You will find further information at www.siemens.com/support-app

Provision of 3D data (step and u3d data formats)

- SiePortal (product catalog)
 - www.siemens.com/lowvoltage/product-catalog
- Image database
 - www.siemens.com/lowvoltage/picturedb

Engineering data for CAD or CAE systems are available in the CAx Download Manager at www.siemens.com/cax



Face-to-face or online training

Our training courses can be found at www.siemens.com/sitrain-lowvoltage

- SIMARIS configuration (WT-LVASIMC)



Technical overview – Switchboards, distribution boards and small distribution boards



The fast way to get you to our online services

This page provides you with comprehensive information and links on switchboards, distribution boards and small distribution boards

www.siemens.com/lowvoltage/product-support (109769089)

Distribution systems

Power distribution boards



SIVACON S4

Basic data		
Rated current	A	4000 6300 with license
Busbar position		Top, rear (NF)
Overtoltage category		III/IV
Rated impulse withstand voltage U_{imp}	kV	12
Rated insulation voltage U_i	V	1000
Rated operational voltage U_e	V AC	690
Rated peak withstand current I_{pk}	kA	220
Rated short-time current I_{cw} (1 s)	kA	100
Degree of protection according to IEC 60529/EN 60529		IP40 + IPX1/IP55
Form of internal separation		4b
Protection class		I
Color		RAL 7035 (light gray)
Dimensions		
Height	mm	2000 Base 100/200
Width	mm	400 ... 1200
Depth	mm	400 ... 1200
Standards and specifications		
DIN		EN 61439-1/-2
IEC		IEC 61439-1/-2
VDE		VDE 0660-600-1/-2
Operating personnel	Ordinary person	–
	Electrically skilled person	■
Approvals		VDE, EAC
Other		
Type of installation		Wall/back to back
Pre-assembled solutions	Without copper	■
	With copper	■
Further information		

[See page 15/54](#)

ALPHA UNIVERSAL distribution boards (NF technology)



ALPHA 800 UNIVERSAL	ALPHA 630 UNIVERSAL	ALPHA 125 UNIVERSAL
800	630	125
–	–	–
III	III	III
6	6	6
690	690	400
690	690	400
74	53	10
35	25	17
IP30/IP43/IP55	IP30/IP43/IP55	IP30/IP31D/IP43
1	1	1
I	I	I
RAL 7035 (light gray)	RAL 7035 (light gray)	RAL 7035 (light gray)
1800/2000	400/600/800/1000/1200/ 1600/1800/2000	400/600/800 /1000/1200
300/600/900	600 + 250/900	600
400	250	140
EN 61439-1/-2	EN 61439-1/-2	EN 61439-1/-3
IEC 61439-1/-2	IEC 61439-1/-2	IEC 61439-1/-3
VDE 0660-600-1/-2	VDE 0660-600-1/-2	VDE 0660-600-1/-3
–	–	■
■	■	■
–	–	–
Wall	Wall	Wall
–	–	–
–	–	–
See page 15/164	See page 15/166	See page 15/172

Distribution systems

Power distribution boards and motor control centers



SIVACON S8

Power distribution boards



ALPHA 3200

ALPHA 3200 Eco

Basic data

Rated current	A	7010	3200	3200
Busbar position		Top, rear	Rear	Center
Overtoltage category		IV	III/IV	III/IV
Rated impulse withstand voltage U_{imp}	kV	12 ¹⁾	8	8
Rated insulation voltage U_i	V	1000	1000	1000
Rated operational voltage U_e	V AC	690	690	400
Rated peak withstand current I_{pk}	kA	330	165	165
Rated short-time current I_{cw} (1 s)	kA	150	75	75
Degree of protection according to IEC 60529/EN 60529		IP30 ... IP54	IP40 + IPX1/ IP54	IP30 + IPX1/IP54
Form of internal separation		4b	2b	1
Protection class		I	I	I
Color		RAL 7035 (light gray)	RAL 7035 (light gray)	RAL 7035 (light gray)

Dimensions

Height	mm	2000/2200 Base 100/200	2000 Base 100/200	2000 Base 100/200
Width	mm	200 ... 1400	350 ... 1400	350 ... 1100
Depth	mm	500 ... 1200	600	400/600

Standards and specifications

DIN		EN 61439-2	EN 61439-1/-2	EN 61439-1/-2
IEC		IEC 61439-2	IEC 61439-1/-2	IEC 61439-1/-2
VDE		VDE 0660-600-2	VDE 0660-600-2	VDE 0660-600-2

Operating personnel	Ordinary person	–	–	–
	Electrically skilled person	■	■	■
Approvals		DNV GL, ASTA, EAC, CCC, DEKRA	–	–

Other

Type of installation		Wall/back to back/ double-fronted	Wall/back to back	Wall/back to back
Pre-assembled solutions	Without copper	■	■	■
	With copper	■	■	■

Further information

See page 15/10

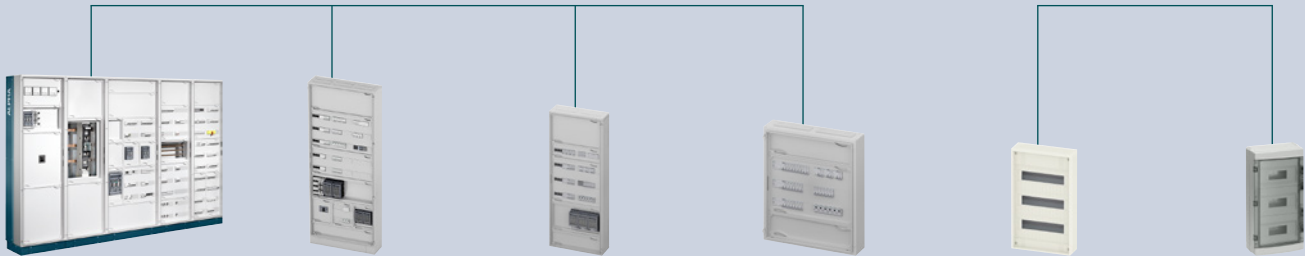
See page 15/12

See page 15/12

¹⁾ Depending on the devices used

ALPHA distribution boards (DIN technology)

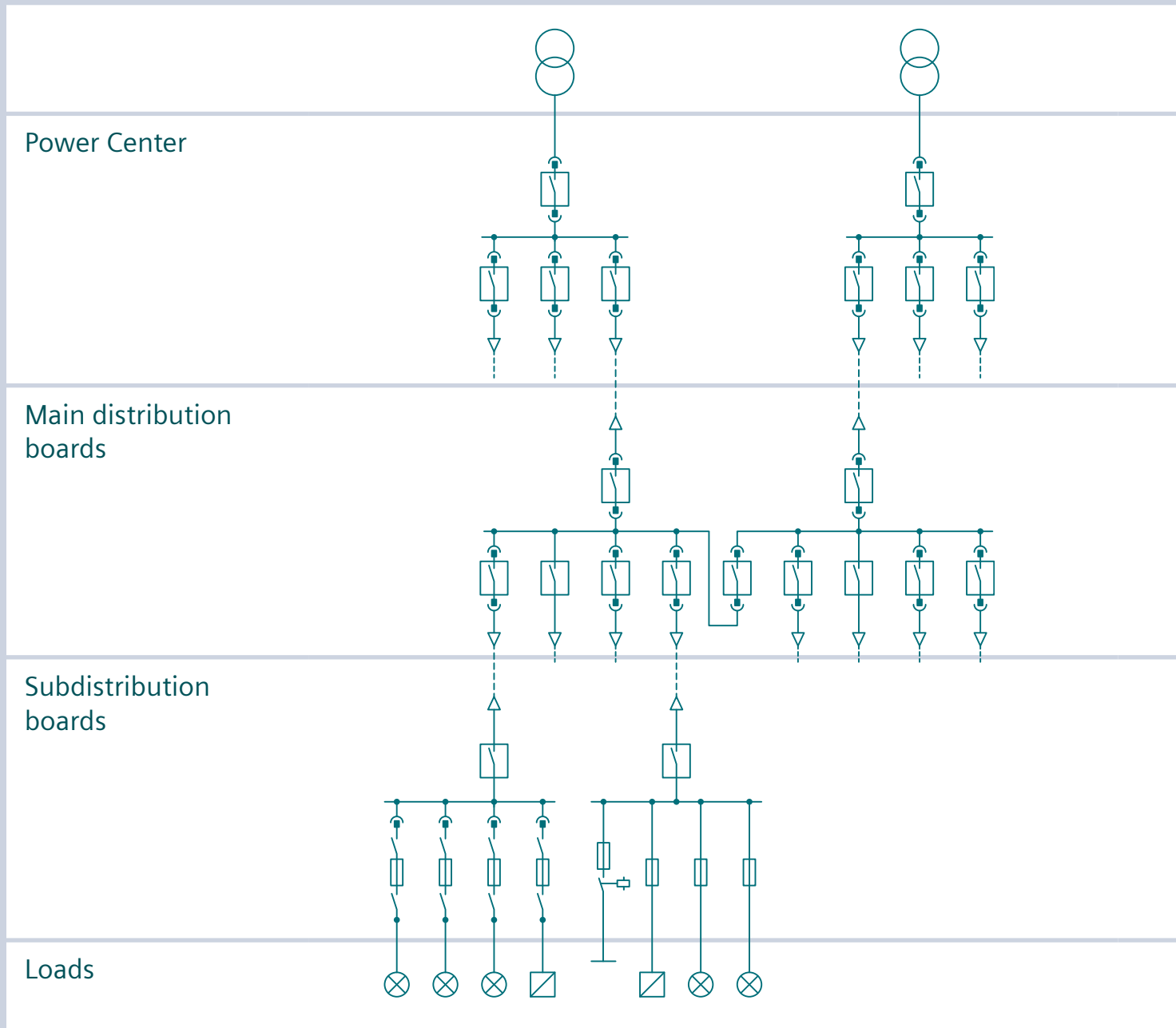
Small distribution boards



ALPHA 1250	ALPHA 630	ALPHA 400	ALPHA 160	ALPHA SIMBOX XL	ALPHA SIMBOX WP
1250	630	400	160	63	63
–	–	–	–	–	–
III	III	III	II	II	II
8	6	6	6	–	–
690	690	690	690	–	1000
690	690	690	690	400	400
110	76	76	–	–	–
35	34	34	–	–	–
IP55	IP43/IP55	IP31/IP43/IP55	IP31/IP43/IP44	IP30	IP65
–	–	–	–	–	–
I	I/II	I/II	II	II	II
RAL 7035 (light gray)	RAL 7035 (light gray)	RAL 9016 (traffic white)/ RAL 7035 (light gray)	RAL 9016 (traffic white)/ RAL 7035 (light gray)	RAL 9010 (pure white)	RAL 7035 (light gray)
1950 Base 100	1950 Base 100	650/800/950/1100/ 1250/1400	500/650/800/950/1100	1- ... 4-tier	1- ... 4-tier
300/550/800/ 1050/1300	300/550/800/ 1050/1300	300/550/800/ 1050/1300	300/550	305	4 ... 18 MW
400	210/250/320	210	140	88/99	100/140/160
EN 61439-1/-2	EN 61439-1/-2	EN 61439-1/-2/-3	EN 61439-1/-3	DIN 43871	EN 61439-1/-3, DIN 43871
IEC 61439-1/-2	IEC 61439-1/-2	IEC 61439-1/-2/-3	IEC 61439-1/-3	IEC 61439-1/-3	IEC 61439-1/-3
VDE 0660-600-1/-2/-3	VDE 0660-600-1/-2/-3	VDE 0660-600-1/-2/-3	VDE 0660-600-1/-3	DIN VDE 0603	DIN VDE 0603-1, VDE 0660-500/-504
–	–	■	■	■	■
■	■	■	■	■	■
VDE, EAC	VDE, EAC	VDE, EAC	VDE, EAC	VDE, EAC	VDE, EAC
Surface mounting	Surface mounting	Surface mounting/ flush mounting	Surface mounting/ flush mounting	Flush mounting/ hollow wall/ surface mounting	Surface mounting
■	■	■	■	–	–
–	–	–	–	–	–
See page 15/196	See page 15/200	See page 15/204	See page 15/208	See page 15/240	See page 15/243

Distribution systems

Applications



SIVACON S8



SIVACON S8



SIVACON S4



ALPHA 3200



ALPHA 3200 Eco



ALPHA UNIVERSAL (NF technology)

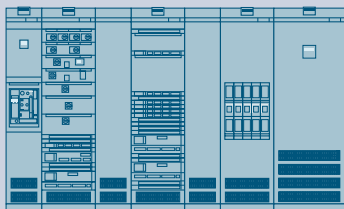


ALPHA (DIN technology)



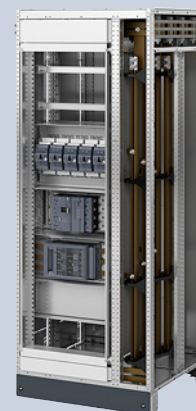
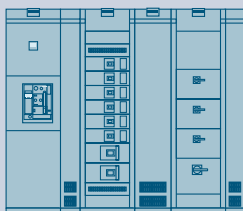
System overview

SIVACON S8



	Circuit breaker design	Fixed-mounted design	In-line design, plugged in
Devices	3WA, 3WL and 3VA	3VA, 3RV, 3NP, 3K... and 5S...	3NJ6
Installation system	Fixed-mounted Withdrawable	Fixed-mounted with front covers	Plug-in
Functions	Infeed, Outgoing feeder, Coupling	Outgoing cable feeders	Outgoing cable feeders
Rated values	6300 A	630 A	630 A
Connection type	Front or rear	Front	Front

SIVACON S4



	Circuit breaker design	Molded case circuit breakers	Fixed-mounted design
Devices	3WA	3VA15, 3VA25 – 3VA26	3WA, 3VA, 3NP1, Modular installation devices
Installation system	Fixed-mounted Withdrawable	Fixed-mounted	Fixed-mounted with front covers or modular doors
Functions	Infeed, Outgoing feeder, Coupling	Infeed Outgoing feeder	Infeed Outgoing cable feeders
Rated values	6300 A	1250 A	2000 A
Connection type	Front or rear	Front or rear	Front or rear



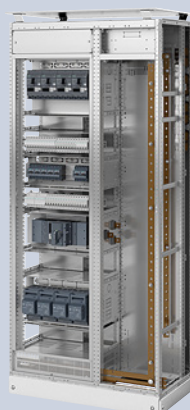
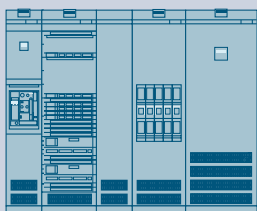
In-line design, Fixed-mounted	Reactive power compensation	Active protection against internal arcing	Universal mounting design/ motor control center	Frequency converter technology
3NJ4	Capacitor units, controllers	Internal arcing protection system	3VA, 3RV, 3NP, 3K..., 3R..., 3UF, 3NJ6 and 3LD	SINAMICS G120 (6SL)
Fixed-mounted	Fixed-mounted	Fixed-mounted	Withdrawable Fixed-mounted with compartment doors Plug-in	Fixed-mounted (modules)
Outgoing cable feeders	Central compensation of reactive power	Active protection against internal arcing	Outgoing cable feeders Motor feeders (MCC)	Motor feeders (MCC)
630 A	Without inductor up to 600 kvar With inductor up to 500 kvar	Short-circuit-proof up to 100 kA at 690 V	630 A, 250 kW	132 kW
Front	Front	–	Front or rear	Front



In-line design, plugged in	In-line design, Fixed-mounted	Mounting plates
3NJ63	3NJ4	Section for free configuration
Plug-in	Fixed-mounted	Fixed-mounted
Outgoing cable feeders	Outgoing cable feeders	Control equipment
630 A	630 A	–
Front	Front	Front

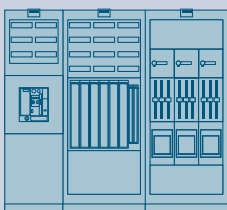
System overview

ALPHA 3200

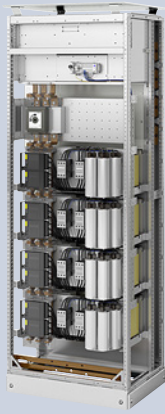


	Circuit breaker design	Fixed-mounted design	In-line design, plugged in
Devices	3WA and 3VA	3VA, 3RV, 3NP, 3K..	3NJ6
Installation system	Fixed-mounted Withdrawable	Fixed-mounted with front covers	Plug-in
Functions	Infeed Outgoing feeder Coupling	Outgoing cable feeders	Outgoing cable feeders
Rated values	3200 A	630 A	630 A
Connection type	Front or rear	Front	Front

ALPHA 3200 Eco



	Circuit breaker design	Molded case circuit breakers	In-line design, fixed-mounted
Devices	3WA, 3WL10	3VA14 – 3VA15, 3VA24 – 3VA27	3NJ4
Installation system	Fixed-mounted Withdrawable	Fixed-mounted	Fixed-mounted
Functions	Infeed Outgoing feeder Coupling up to 2000 A	Infeed Outgoing feeder	Outgoing cable feeders
Rated values	3200 A	1600 A	630 A
Connection type	Front	Front	Front



In-line design, Fixed-mounted	Reactive power compensation
3NJ4	Capacitor units, controllers
Fixed-mounted	Fixed-mounted
Outgoing cable feeders	Central compensation of reactive power
630 A	Without inductor up to 600 kvar With inductor up to 500 kvar
Front	Front

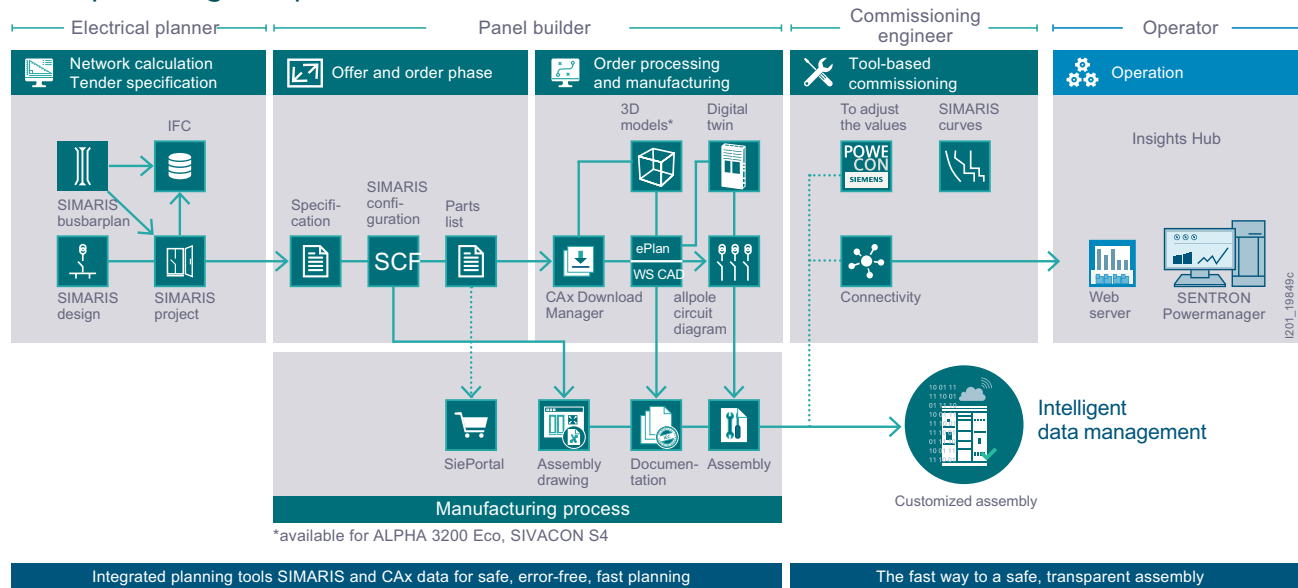


ALPHA DIN modular installation system	Mounting plates
ALPHA 8GK	Section for free configuration
Fixed-mounted	Fixed-mounted
Branch circuits Transformer measurement	Control equipment
630 A	710 W
Front	Front

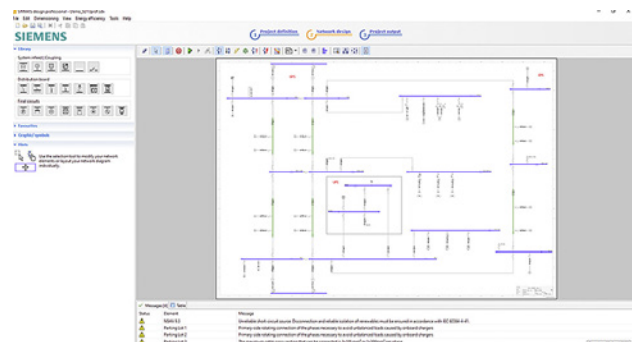
SIMARIS planning tools

For planning and visualizing the power distribution system

From planning to operation



SIMARIS design



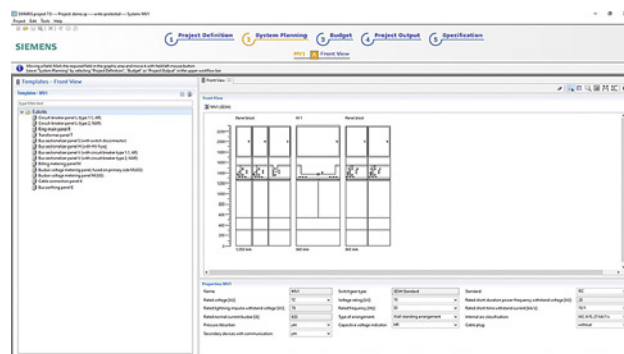
SIMARIS design is a planning tool for quick, effective network calculations and dimensioning of electrical power distribution systems for non-residential and industrial buildings.

- Dimensioning of electrical networks on the basis of real products according to acknowledged rules of technology and the applicable standards (VDE, IEC)
- Automatic selection of the appropriate components from the integrated product database

SIMARIS design forms part of SIMARIS Suite.

Free download of the SIMARIS Suite and further information at: www.siemens.com/simarisdg

SIMARIS project



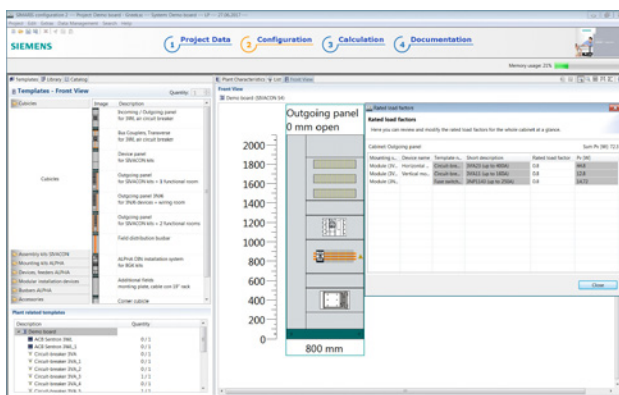
SIMARIS project is a planning tool for fast calculation of space requirements and electrical power distribution system budgets for non-residential and industrial buildings, and for generating specifications automatically.

- Import of projects created in SIMARIS design
- Export of 3D data in IFC 4.x format for BIM (Building Information Modeling)

SIMARIS project forms part of SIMARIS Suite.

Free download of the SIMARIS Suite and further information at: www.siemens.com/simarisproject

SIMARIS configuration

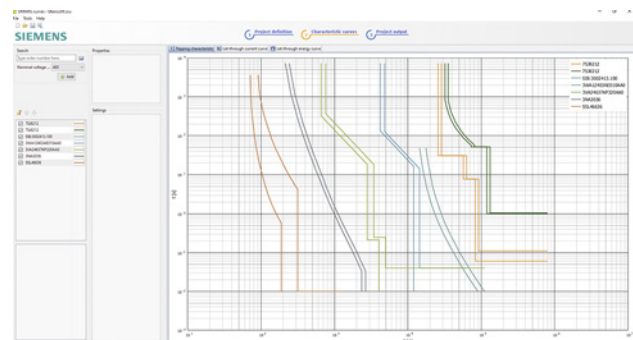


With the configuration software SIMARIS configuration, the SIVACON S8, ALPHA 3200 and SIVACON S4 power distribution boards as well as the ALPHA UNIVERSAL and ALPHA distribution boards can be quickly and reliably configured.

- Comprehensive documentation of the installation with design verification acc. to IEC 61439
- Configuration of the devices from the SENTRON portfolio with the exact article numbers and integrated price calculation feature

Free download and further information at:
www.siemens.com/simarisconfig

SIMARIS curves



SIMARIS curves is a planning tool for visualizing and evaluating characteristic curves of Siemens low-voltage protection equipment and fuses (IEC) quickly and easily, including the possibility of simulating instrument settings.

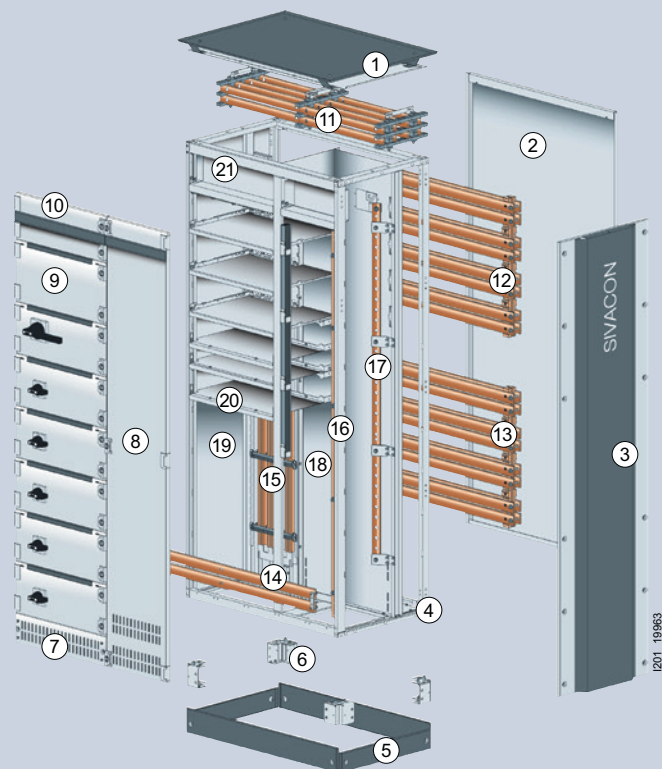
- Is available both as a PC version and also as an app for use on a tablet PC or a smartphone

SIMARIS curves forms part of SIMARIS Suite.

Free download of the SIMARIS Suite and further information at:
www.siemens.com/simariscures

System overview

SIVACON S8 power distribution boards and motor control centers



Enclosure

- ① Roof plate
- ② Rear wall
- ③ Design side wall
- ④ Frame
- ⑤ Base cover
- ⑥ Base
- ⑦ Base compartment cover, ventilated
- ⑧ Cubicle door, ventilated
- ⑨ Compartment door
- ⑩ Head compartment door

Busbars

- ⑪ Main busbar (L1 ... L3, N), top
- ⑫ Main busbar (L1 ... L3, N), rear, top
- ⑬ Main busbar (L1 ... L3, N), rear, bottom
- ⑭ Main busbar (PE), bottom
- ⑮ Distribution busbar (L1 ... L3, N) – device compartment
- ⑯ Distribution busbar (PE) – cable compartment
- ⑰ Distribution busbar (N) – cable compartment

Internal separation

- ⑱ Device compartment/busbar compartment
- ⑲ Cubicle to cubicle
- ⑳ Compartment to compartment
- ㉑ Cross-wiring compartment

The SIVACON S8 low-voltage switchboard is a design-verified, low-voltage switchgear and controlgear assembly according to IEC 61439-1/2.

Furthermore, the verified testing under arcing conditions in compliance with the requirements of IEC/TR 61641 ensures the optimum safety of personnel. SIVACON S8 also integrates arc-fault protection systems in accordance with IEC/TS6107 and thus offers a high level of safety.

SIVACON S8 can be used as a type-tested power distribution board and motor control center up to 7000 A.

The optional, likewise design-verified, efficient and redundantly designed ventilation system additionally contributes to ensuring safe and reliable operation.

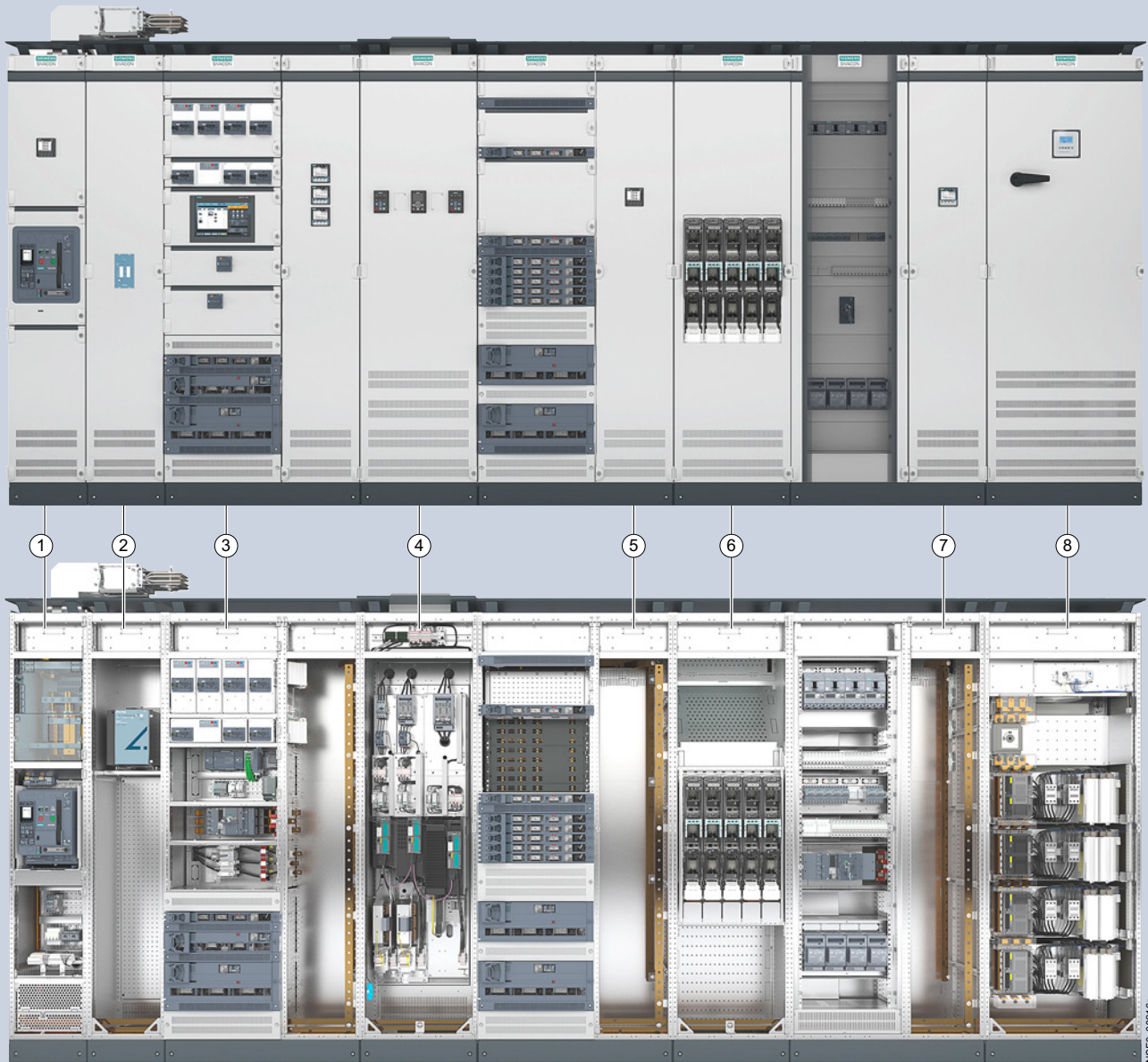
Thanks to the complete building information modeling data (BIM) of SIVACON S8, the entire lifecycle of the switchboard in an infrastructure is supported from the planning stage to operation and service.

Highlights

- Design verification in accordance with IEC 61439-2 and testing in the event of arcing due to an internal fault in accordance with IEC/TR 61641
- Extended protection against internal arcing with active protection system
- Redundantly designed, efficient ventilation system
- Universal design-verified connection to SIVACON 8PS busbar trunking systems
- Innovative, modular system
- Space-optimized use with compact withdrawable design
- Optimum application thanks to high-performance SIMOCODE pro motor management system

Design

Mounting designs



NSFD_00216a

- ① Circuit breaker design with 3WA air circuit breaker up to 6300A or 3VA molded case circuit breaker up to 1000A
- ② Protection against internal arcing, the extended active protection against internal arcing
- ③ Universal mounting design section for motor and cable feeders up to 630 A in withdrawable design with combination options with fixed-mounted design (modular door) and plug-in design
- ④ Frequency converter cubicle up to 132 kW
- ⑤ In-line design, plugged-in, for outgoing cables up to 630 A
- ⑥ In-line design, fixed-mounted in vertical version for cable feeders up to 630 A
- ⑦ In-line design section, in vertical version for cable feeders up to 630 A
- ⑧ Reactive power compensation section up to 500 kvar

SIVACON S8 low-voltage switchboard with standardized and typified components

Design

Universal mounting design and withdrawable design

Universal mounting design

In many applications it is necessary for space reasons to integrate various mounting designs in one and the same section. The universal mounting design from SIVACON S8 offers high efficiency, safety and high variability through the combination of

- withdrawable,
- fixed-mounted with compartment doors and
- plug-in version.

Withdrawable

The flexible withdrawable unit design is suitable for different applications, e.g. as a motor control center.

The following features are offered to improve personnel and machine safety:

- Uniform operation for all withdrawable unit sizes
- Integrated operating error protection for all withdrawable units
- Unambiguous indication of withdrawable unit positions
- Separate actuation for main control switch and withdrawable unit position
- Test and disconnected position with door closed, without cancelation of degree of protection
- Withdrawable unit coding prevents swapping of withdrawable units of same size
- Lockable disconnected position
- Swiveling instrument panel on standard withdrawable units for making settings during operation
- Small withdrawable units for motor and cable feeders up to 63 A

Withdrawable unit versions

Small withdrawable units:

- Size 1/4 and 1/2
- up to 48 withdrawable units per section

Standard withdrawable units:

- Height 100 to 700 mm
- up to 18 withdrawable units per section



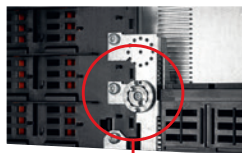
Flexible withdrawable design with standard and small withdrawable units for high packing densities

Standard withdrawable unit

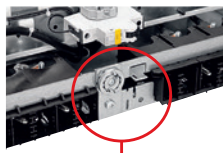
Withdrawable unit coding and initialization modules

The mechanical withdrawable unit coding prevents swapping of withdrawable units of the same size.

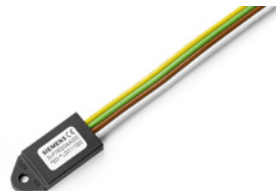
Alternatively, motor starters can be fitted with SIMOCODE pro initialization modules that considerably simplify commissioning and replacement.



Withdrawable unit coding in the compartment



Withdrawable unit coding on the unit



SIMOCODE pro initialization module

SIMARIS control

When visualized with SIMARIS control, all communication-capable switching devices can be operated and monitored uniformly by means of the SIVACON S8 low-voltage switchboard.

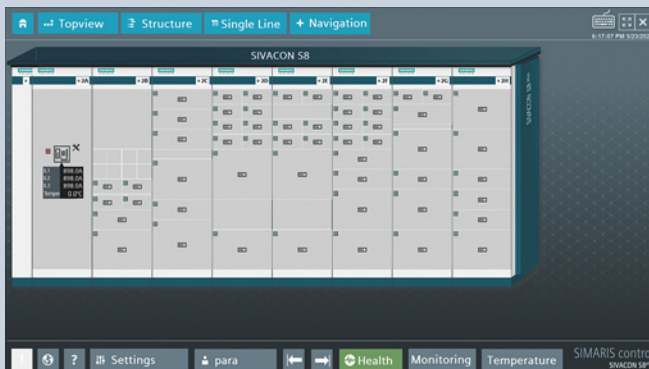
In addition, the data can be integrated into higher-level automation or energy management systems. Cloud-based analysis systems such as Insights Hub open up new opportunities of enhanced switchboard availability and high transparency of power flows. As a digital twin of the switchboard, SIMARIS control provides an ideal solution for local or remote visualization and control of the installed communication-capable switching devices.

SIMARIS control integrates various bus systems. A standardized data model for motor control centers enables uniform visualization of the data, which means that all the information delivered by the communication-capable switching, protection and measuring devices used in SIVACON S8 is displayed in SIMARIS control clearly and in a structured, needs-oriented format.

Highlights

- An integrated system with easier and faster identification of events thanks to in-app alerts and email notifications
- Greater flexibility in on-site operation with local control and monitoring functions
- Increased system availability thanks to the Health Index function for accurate system health monitoring
- Easy maintenance with digital documentation and maintenance logbook
- Saves costs and space that would otherwise be required for various monitoring devices in the switchboard by displaying power flows and electrical measured values
- Easy integration with a cloud-based system
- Parallel independent operation with a higher-level control system (DC/E-SCADA)

SIMARIS control is part of the curated and modular Siemens Xcelerator portfolio.



System overview

ALPHA 3200 Eco power distribution boards

Frame and enclosure



Accessories



Double-bit key



Standardized parts



Mounting accessories

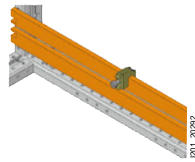


Transport aids

Busbar systems



Busbar, central



Copper grounding bars

Section expansion



3WA, 3WL10 incoming feeder panels



3WA coupling panels



3VA molded case circuit breakers



3NJ4 in-line design



ALPHA 8GK modular installation system



Mounting plates

ALPHA assembly kits



Modular installation devices



Terminal blocks



3NJ4
fuse switch
disconnectors



3K
switch
disconnectors



3VA
molded case circuit
breakers



8US
busbar-adaptable units



3NP1
fuse switch
disconnectors



Meter mounting



Transformer
measurement



Mounting plates

ALPHA accessories



Front covers
closed



transparent



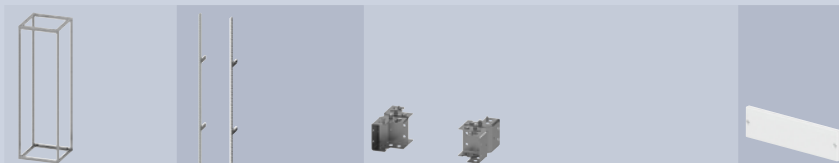
deep-drawn



Door connection module

See ALPHA 8GK assembly kits from page 15/210

Frame and enclosure



1 Frame

2 Uprights

3 Base corner pieces

4 Base cover

Depth	Width			Height		Height	
				100 mm	200 mm	100 mm	200 mm
400 mm	350 mm	8LK1200-4AA03	–	8LK1010-0AA01	8LK1020-0AA11	8LK1014-0AA02	8LK1024-0AA04
	400 mm	8LK1204-4AA01	–	8LK1010-0AA01	8LK1020-0AA11	8LK1014-0AA03	8LK1024-0AA05
	600 mm	8LK1206-4AA01	–	8LK1010-0AA01	8LK1020-0AA11	8LK1016-0AA02	8LK1026-0AA04
	800 mm	8LK1208-4AA01	–	8LK1010-0AA01	8LK1020-0AA11	8LK1018-0AA06	8LK1028-0AA07
	850 mm	8LK1200-4AA04	–	8LK1010-0AA01	8LK1020-0AA11	8LK1018-0AA04	8LK1028-0AA05
	1100 mm	8LK1200-4AA05	–	8LK1010-0AA01	8LK1020-0AA11	8LK1011-0AA05	8LK1021-0AA06
600 mm	350 mm	8LK1200-6AA05	8LK3011-8AA38	8LK1010-0AA01	8LK1020-0AA11	8LK1014-0AA02	8LK1024-0AA04
	400 mm	8LK1204-6AA01	8LK3011-8AA38	8LK1010-0AA01	8LK1020-0AA11	8LK1014-0AA03	8LK1024-0AA05
	600 mm	8LK1206-6AA01	8LK3011-8AA38	8LK1010-0AA01	8LK1020-0AA11	8LK1016-0AA02	8LK1026-0AA04
	800 mm	8LK1208-6AA01	8LK3011-8AA38	8LK1010-0AA01	8LK1020-0AA11	8LK1018-0AA06	8LK1028-0AA07
	850 mm	8LK1208-6AA02	8LK3011-8AA38	8LK1010-0AA01	8LK1020-0AA11	8LK1018-0AA04	8LK1028-0AA05
	1100 mm	8LK1200-6AA06	8LK3011-8AA38	8LK1010-0AA01	8LK1020-0AA11	8LK1011-0AA05	8LK1021-0AA06



④ Base cover lateral

Height
100 mm 200 mm

8LK1010-4AA01	8LK1020-4AA01
8LK1010-4AA01	8LK1020-4AA01
8LK1010-4AA01	8LK1020-4AA01
8LK1010-4AA01	8LK1020-4AA01
8LK1010-4AA01	8LK1020-4AA01
8LK1010-4AA01	8LK1020-4AA01
8LK1010-4AA01	8LK1020-4AA01
8LK1010-0AA05	8LK1020-0AA14
8LK1010-0AA05	8LK1020-0AA14
8LK1010-0AA05	8LK1020-0AA14
8LK1010-0AA05	8LK1020-0AA14
8LK1010-0AA05	8LK1020-0AA14
8LK1010-0AA05	8LK1020-0AA14
8LK1010-0AA05	8LK1020-0AA14



⑤ Side panels

IP30 IP54

8LK2520-4AA11	8LK2520-4AA10
8LK2520-4AA11	8LK2520-4AA10
8LK2520-4AA11	8LK2520-4AA10
8LK2520-4AA11	8LK2520-4AA10
8LK2520-4AA11	8LK2520-4AA10
8LK2520-4AA11	8LK2520-4AA10
8LK2520-4AA11	8LK2520-4AA10
8LK2520-6AA17	8LK2520-6AA16
8LK2520-6AA17	8LK2520-6AA16
8LK2520-6AA17	8LK2520-6AA16
8LK2520-6AA17	8LK2520-6AA16
8LK2520-6AA17	8LK2520-6AA16
8LK2520-6AA17	8LK2520-6AA16



⑥ Rear panels

IP30 IP54

8LK2420-0AA15	8LK2420-0AA21
8LK2420-4AA07	8LK2420-4AA08
8LK2420-6AA07	8LK2420-6AA08
8LK2420-8AA07	8LK2420-8AA08
8LK2420-0AA18	8LK2420-0AA24
8LK2420-0AA20	8LK2420-0AA25
8LK2420-0AA15	8LK2420-0AA21
8LK2420-4AA07	8LK2420-4AA08
8LK2420-6AA07	8LK2420-6AA08
8LK2420-8AA07	8LK2420-8AA08
8LK2420-0AA18	8LK2420-0AA24
8LK2420-0AA20	8LK2420-0AA25

Accessories

Cross-wiring



Version	Scope of supply	Article No.
Brackets	1 set = 2 units	8LK3011-6AA30

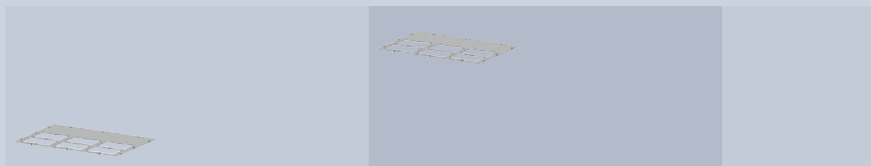
Seals IP54



Version	Width	Height	Scope of supply	Article No.
Base corner pieces	30 mm	0.05 mm	1 roll = 228 m	8LK1000-0AA78
Frame sealing corners			1 set = 8 units	8LK1000-0AA25

Frame and enclosure

Floor plates and roof plates



Depth	Width	Floor plates		Roof plates		Number of module inserts
		IP30	IP54	IP30	IP54	
400 mm	350 mm	8LK2300-4AA35	8LK2300-4AA21	8LK2300-4AA42	8LK2300-4AA27	2
	400 mm	8LK2304-4AA71	8LK2304-4AA61	8LK2304-4AA74	8LK2304-4AA63	2
	600 mm	8LK2306-4AB15	8LK2306-4AB00	8LK2306-4AB18	8LK2306-4AB02	4
	800 mm	8LK2308-4AB27	8LK2308-4AB10	8LK2308-4AB31	8LK2308-4AB12	4
	850 mm	8LK2300-4AA36	8LK2300-4AA22	8LK2300-4AA43	8LK2300-4AA28	6
	1100 mm	8LK2300-4AA37	8LK2300-4AA23	8LK2300-4AA44	8LK2300-4AA30	8
600 mm	350 mm	8LK2300-6AA65	8LK2300-6AA52	8LK2300-6AA72	8LK2300-6AA40	3
	400 mm	8LK2304-6AB21	8LK2304-6AB13	8LK2304-6AB24	8LK2304-6AB10	3
	600 mm	8LK2306-6AC34	8LK2306-6AC04	8LK2306-6AC37	8LK2306-6AC01	6
	800 mm	8LK2308-6AC62	8LK2308-6AC15	8LK2308-6AC65	8LK2308-6AC12	6
	850 mm	8LK2300-6AA66	8LK2300-6AA21	8LK2300-6AA73	8LK2300-6AA41	9
	1100 mm	8LK2300-6AA67	8LK2300-6AA54	8LK2300-6AA74	8LK2300-6AA42	12

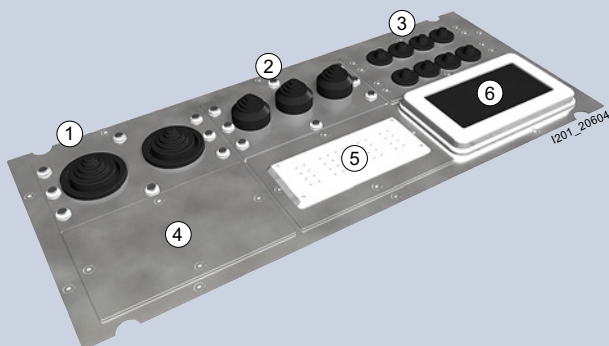
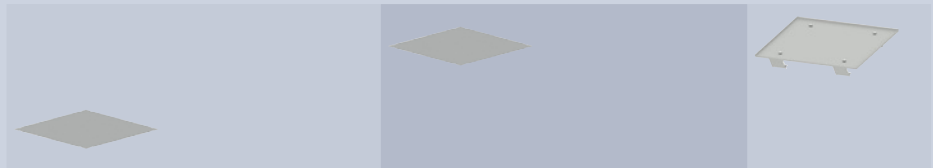


Plate IP30	Plate IP54	Insert	Cable diameter
① 8LK2300-0AA35	8LK2300-0AA23	8HC6900	1 x 14 - 65 mm
② 8LK2300-0AA34	8LK2300-0AA22	8LK9400-3AA75	1 x 14 - 38 mm
③ 8LK2300-0AA36	8LK2300-0AA24	8HP1805	1 x 12 - 29 mm
		8HP1806	2 x 6 - 15 mm
		8HP1807	3 x 4 - 12,5 mm
		8HP1808	4 x 4 - 12 mm
④ 8LK2300-0AA32	8LK2300-0AA21	–	–
⑤ 8LK2300-0AA33	8LK2300-0AA25	8GK9100-0KK01	44 x 9 mm
			22 x 12 mm
⑥ 8GD6095	8GD6095	–	–



Depth	Width	Floor plates		Roof plates		Roof add-on-plates
		IP30	IP54	IP30	IP54	IPX1
400 mm	350 mm	8LK2300-4AA32	8LK2300-4AA07	8LK2300-4AA38	8LK2300-4AA11	8LK2304-4AA66
	400 mm	8LK2304-4AA68	8LK2304-4AA56	8LK2304-4AA72	8LK2304-4AA57	8LK2304-4AA67
	600 mm	8LK2306-4AB13	8LK2306-4AB83	8LK2306-4AB16	8LK2306-4AA86	8LK2306-4AB04
	800 mm	8LK2308-4AB25	8LK2308-4AB05	8LK2308-4AB28	8LK2308-4AB06	8LK2308-4AB15
	850 mm	8LK2300-4AA33	8LK2300-4AA08	8LK2300-4AA40	8LK2300-4AA12	8LK2300-4AA31
	1100 mm	8LK2300-4AA34	8LK2300-4AA10	8LK2300-4AA41	8LK2300-4AA13	8LK2301-4AB03
600 mm	350 mm	8LK2300-6AA62	8LK2300-6AA34	8LK2300-6AA68	8LK2300-6AA36	8LK2300-4AA43
	400 mm	8LK2304-6AB18	8LK2304-6AB07	8LK2304-6AB22	8LK2304-6AB08	8LK2304-4AB11
	600 mm	8LK2306-6AC32	8LK2306-6AC87	8LK2306-6AC35	8LK2306-6AC00	8LK2306-4AC02
	800 mm	8LK2308-6AC61	8LK2308-6AC07	8LK2308-6AC63	8LK2308-6AC08	8LK2308-4AC20
	850 mm	8LK2300-6AA63	8LK2300-6AA51	8LK2300-6AA70	8LK2300-6AA37	8LK2300-4AA44
	1100 mm	8LK2300-6AA64	8LK2300-6AA35	8LK2300-6AA71	8LK2300-6AA38	8LK2300-4AA45

Accessories

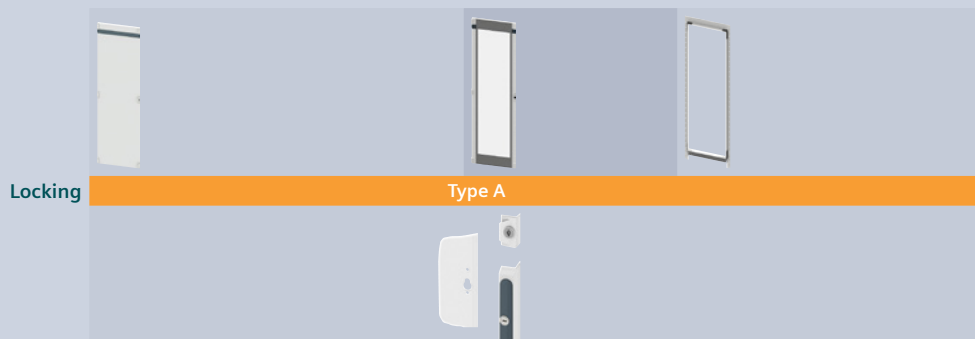
Seals









Version	Width	Scope of supply	Article No.
Sealing foil base of frame	19 mm	1 roll = 50 m	8LK2000-0AJ71

Frame and enclosure

Doors



Hinge	Width	Door		Glass door	Sealing frame
		IP30	IP54	IP54	IP54
Left	350 mm	8LK2197-4AD56	8LK2197-4AD55	–	+ 8LK2197-0AA35
	400 mm	8LK2197-4AD57	8LK2197-4AD54	–	+ 8LK2197-4AD43
	600 mm	8LK2197-6AC75	8LK2197-6AC74	8LK2197-6AC82	+ 8LK2197-6AC64
	800 mm	8LK2197-8AD41	8LK2197-8AD40	–	+ 8LK2197-8AD24
	850 mm	8LK2197-8AD42	8LK2197-8AD38	8LK2197-8AD64	+ 8LK2197-0AA34
	1100 mm	8LK2197-1AC07	8LK2197-1AC10	–	+ 8LK2197-0AA33
Right	350 mm	8LK2197-4AD56	8LK2197-4AD55	–	+ 8LK2197-0AA35
	400 mm	8LK2197-4AD57	8LK2197-4AD54	–	+ 8LK2197-4AD43
	600 mm	8LK2197-6AC75	8LK2197-6AC74	8LK2197-6AC82	+ 8LK2197-6AC64
	800 mm	8LK2197-8AD41	8LK2197-8AD40	–	+ 8LK2197-8AD24
	850 mm	8LK2197-8AD42	8LK2197-8AD38	8LK2197-8AD64	+ 8LK2197-0AA34
	1100 mm	8LK2197-1AC07	8LK2197-1AC10	–	+ 8LK2197-0AA33
Hinge					
	Ti-Grey	3 × 8LK2000-0AH55	3 × 8LK2000-0AH55	3 × 8LK2000-0AH55	–
Single locking					
	Handle	8LK2000-0AH56	8LK2000-0AH56	8LK2000-0AH56	–
	Handle, lockable	8LK2000-0AH61	8LK2000-0AH61	8LK2000-0AH61	–
	Double-bit	8LK2000-0AH58	8LK2000-0AH58	8LK2000-0AH58	–
Central locking					
	Rotary handle	8LK2000-0AH57	8LK2000-0AH57	8LK2000-0AH57	–
	Rotary handle, double-bit	8LK2000-0AH60	8LK2000-0AH60	8LK2000-0AH60	–
	Rotary handle, flat cylinder	8LK2000-0AH62	8LK2000-0AH62	8LK2000-0AH62	–
	Rotary handle for profile semicylinder	–	–	–	–
	Profile semicylinder	–	–	–	–
	Locking rods	8LK2100-0AA06	8LK2100-0AA06	8LK2100-0AA06	–
Accessories					
	Inner door struts	8LK2000-0AD07	8LK2000-0AD07	–	–

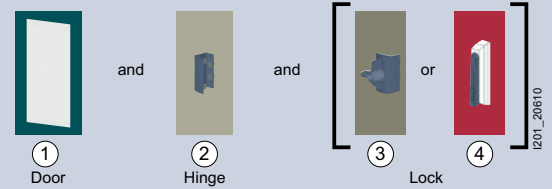


Type B

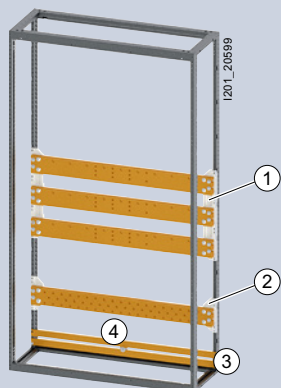



Door IP30	IP54	Glass door IP54	Sealing frame IP54
8LK2197-4AD45	8LK2197-4AD47	–	+ 8LK2197-0AA35
8LK2197-4AD50	8LK2197-4AD52	–	+ 8LK2197-4AD43
8LK2197-6AC66	8LK2197-6AC68	8LK2197-6AC83	+ 8LK2197-6AC64
8LK2197-8AD26	8LK2197-8AD28	–	+ 8LK2197-8AD24
8LK2197-8AD31	8LK2197-8AD33	8LK2197-8AD65	+ 8LK2197-0AA34
8LK2197-1AC08	8LK2197-1AC11	–	+ 8LK2197-0AA33
8LK2197-4AD46	8LK2197-4AD48	–	+ 8LK2197-0AA35
8LK2197-4AD51	8LK2197-4AD53	–	+ 8LK2197-4AD43
8LK2197-6AC67	8LK2197-6AC70	8LK2197-6AC84	+ 8LK2197-6AC64
8LK2197-8AD27	8LK2197-8AD30	–	+ 8LK2197-8AD24
8LK2197-8AD32	8LK2197-8AD34	8LK2197-8AD66	+ 8LK2197-0AA34
8LK2197-1AC08	8LK2197-1AC11	–	+ 8LK2197-0AA33
3 × 8LK2000-0AH55	3 × 8LK2000-0AH55	3 × 8LK2000-0AH55	–
–	–	–	–
–	–	–	–
–	–	–	–
–	–	–	–
–	–	–	–
–	–	–	–
–	–	–	–
8LK2000-0AH63	8LK2000-0AH63	8LK2000-0AH63	–
8PQ9400-0BA26	8PQ9400-0BA26	8PQ9400-0BA26	–
8LK2100-0AA07	8LK2100-0AA07	8LK2100-0AA07	–
8LK2000-0AD07	8LK2000-0AD07	–	–

Ordering guide







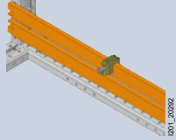
Busbar systems



Busbar supports	Grounding	③ Frame connection	④ Mounting brackets
 			
① L1 ... L3 8LK4002-6AA38	② N 8LK4002-6AA40	PEN 8LK4002-6AA48	③ PE 8LK4002-7AA28
			④ PE 8LK4003-2AA76

Accessories

	Designation	Connection	Scope of supply	Article No.
	Busbar clamps	M10	20 units	8LK6034-7AA41
	Roll Ø outside: 25 mm	M10	10 units	8LK4003-1AA27
	Intermediate piece Potential: N	M12	10 units	8LK4002-6AA47
	Intermediate piece cable connection Potential: N	M12	1 unit	8LK6035-2AA60

Circular conductors				
	Busbar thickness	Ø Cable	Scope of supply	Article No.
	5 mm	1.5 ... 16 mm ²	100 units	8US1921-2AA00
		1.5 ... 35 mm ²	50 units	8US1921-2AB00
		16 ... 70 mm ²	50 units	8US1921-2AC00
		16 ... 120 mm ²	50 units	8US1921-2AD00
	10 mm	1.5 ... 16 mm ²	100 units	8US1921-2BA00
		1.5 ... 35 mm ²	50 units	8US1921-2BB00
		16 ... 70 mm ²	50 units	8US1921-2BC00
		16 ... 120 mm ²	50 units	8US1921-2BD00

Connecting lugs

L1 ... L3
N

Busbar cross-section

Article No.

30 × 10 mm

8LK4002-6AA41

40 × 10 mm

8LK4002-6AA42

50 × 10 mm

8LK4002-6AA43

60 × 10 mm

8LK4002-6AA44

80 × 10 mm

8LK4002-6AA45

100 × 10 mm

8LK4002-6AA46

PE

20 × 5 mm

8LK4002-7AA30

30 × 10 mm

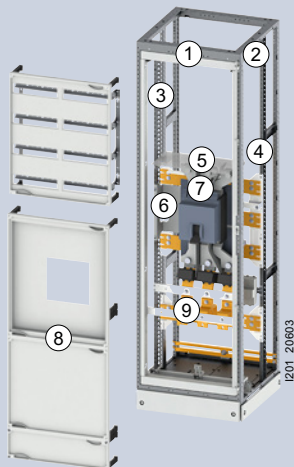
8LK4002-7AA30

40 × 5 mm

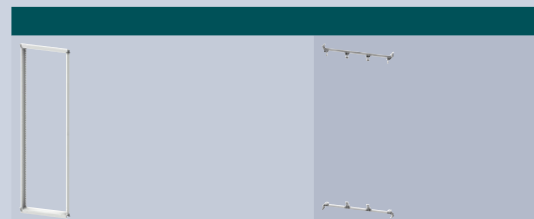
8LK4002-7AA31

Section expansion

3VA molded case circuit breakers

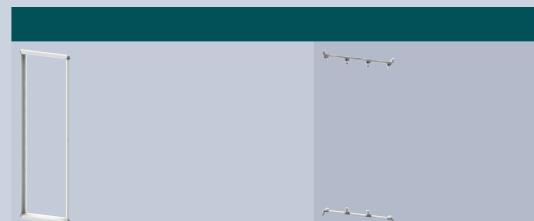


3-pole



Depth	Width	MCCB	I_n	Trip unit	1 Cover frames		2 8GK adaptation
					IP30	IP54	
400 mm	350 mm	3VA14	630 A	TM	8LK3011-5AA85	8LK3011-6AA00	8LK3011-6AA31
		3VA24	630 A	ETU	8LK3011-5AA85	8LK3011-6AA00	8LK3011-6AA31
		3VA15	1000 A	TM	8LK3011-5AA85	8LK3011-6AA00	8LK3011-6AA31
	600 mm	3VA25	1000 A	ETU	8LK3011-5AA85	8LK3011-6AA00	8LK3011-6AA31
		3VA26	1250 A	ETU	8LK3011-5AA86	8LK3011-6AA01	8LK3011-6AA32
		3VA27	1600 A	ETU	8LK3011-5AA86	8LK3011-6AA01	8LK3011-6AA32
600 mm	350 mm	3VA14	630 A	TM	8LK3011-5AA85	8LK3011-6AA00	8LK3011-6AA31
		3VA24	630 A	ETU	8LK3011-5AA85	8LK3011-6AA00	8LK3011-6AA31
		3VA15	1000 A	TM	8LK3011-5AA85	8LK3011-6AA00	8LK3011-6AA31
	600 mm	3VA25	1000 A	ETU	8LK3011-5AA85	8LK3011-6AA00	8LK3011-6AA31
		3VA26	1250 A	ETU	8LK3011-5AA86	8LK3011-6AA01	8LK3011-6AA32
		3VA27	1600 A	ETU	8LK3011-5AA86	8LK3011-6AA01	8LK3011-6AA32

4-pole



Depth	Width	MCCB	I_n	Trip unit	1 Cover frames		2 8GK adaptation
					IP30	IP54	
400 mm	350 mm	3VA14	630 A	TM	8LK3011-5AA85	8LK3011-6AA00	8LK3011-6AA31
		3VA24	630 A	ETU	8LK3011-5AA85	8LK3011-6AA00	8LK3011-6AA31
	600 mm	3VA15	1000 A	TM	8LK3011-5AA86	8LK3011-6AA01	8LK3011-6AA32
		3VA25	1000 A	ETU	8LK3011-5AA86	8LK3011-6AA01	8LK3011-6AA32
		3VA26	1250 A	ETU	8LK3011-5AA86	8LK3011-6AA01	8LK3011-6AA32
		3VA27	1600 A	ETU	8LK3011-5AA86	8LK3011-6AA01	8LK3011-6AA32
600 mm	350 mm	3VA14	630 A	TM	8LK3011-5AA85	8LK3011-6AA00	8LK3011-6AA31
		3VA24	630 A	ETU	8LK3011-5AA85	8LK3011-6AA00	8LK3011-6AA31
	600 mm	3VA15	1000 A	TM	8LK3011-5AA86	8LK3011-6AA01	8LK3011-6AA32
		3VA25	1000 A	ETU	8LK3011-5AA86	8LK3011-6AA01	8LK3011-6AA32
		3VA26	1250 A	ETU	8LK3011-5AA86	8LK3011-6AA01	8LK3011-6AA32
		3VA27	1600 A	ETU	8LK3011-5AA86	8LK3011-6AA01	8LK3011-6AA32

Accessories

DIN rail overvoltage protection

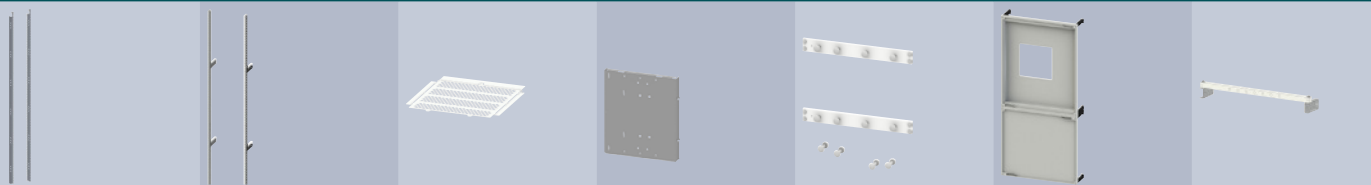


Position	Article No.
Lateral overvoltage protection, see page 6/10	8LK6034-3AA10

Circuit breaker insulation

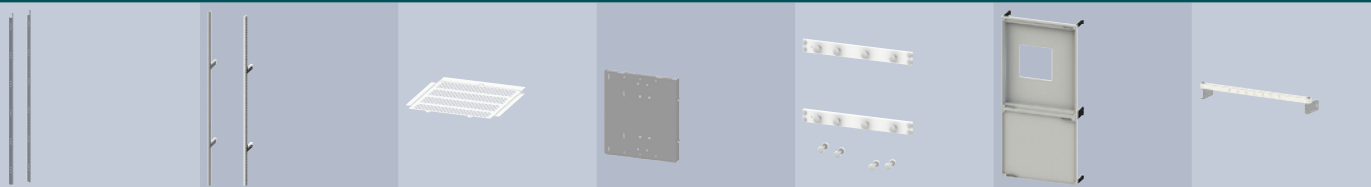


Width	Scope of supply	Article No.
35 mm	1 roll = 15 m	8LK6036-2AA14



① Longitudinal stays ② Section expansion ③ Obstacle ④ Mounting plates ⑤ Busbar connection ⑥ Section covers ⑦ Cable connection

Height 1800 mm	Depth 600 mm					
8GK4853-8KK02	–	8LK3011-8AA40	8LK5002-1AA41	8LK6035-1AA52	8LK5002-1AA46	8LK6035-1AA57
8GK4853-8KK02	–	8LK3011-8AA40	8LK5002-1AA41	8LK6035-1AA52	8LK5002-1AA46	8LK6035-1AA57
8GK4853-8KK02	–	8LK3011-8AA40	8LK5002-1AA42	8LK6035-1AA53	8LK5002-1AA47	8LK6035-1AA58
8GK4853-8KK02	–	8LK3011-8AA40	8LK5002-1AA42	8LK6035-1AA53	8LK5002-1AA47	8LK6035-1AA58
8GK4853-8KK02	–	8LK3011-8AA41	8LK5002-1AA44	8LK6035-1AA55	8LK5002-1AA50	8LK6035-1AA61
8GK4853-8KK02	–	8LK3011-8AA41	8LK5002-1AA45	8LK6035-1AA56	8LK5002-1AA51	8LK6035-1AA62
8GK4853-8KK02	8LK3011-8AA38	8LK3011-8AA40	8LK5002-1AA41	8LK6035-1AA52	8LK5002-1AA46	8LK6035-1AA57
8GK4853-8KK02	8LK3011-8AA38	8LK3011-8AA40	8LK5002-1AA41	8LK6035-1AA52	8LK5002-1AA46	8LK6035-1AA57
8GK4853-8KK02	8LK3011-8AA38	8LK3011-8AA40	8LK5002-1AA42	8LK6035-1AA53	8LK5002-1AA47	8LK6035-1AA58
8GK4853-8KK02	8LK3011-8AA38	8LK3011-8AA40	8LK5002-1AA42	8LK6035-1AA53	8LK5002-1AA47	8LK6035-1AA58
8GK4853-8KK02	8LK3011-8AA38	8LK3011-8AA41	8LK5002-1AA44	8LK6035-1AA55	8LK5002-1AA50	8LK6035-1AA61
8GK4853-8KK02	8LK3011-8AA38	8LK3011-8AA41	8LK5002-1AA45	8LK6035-1AA56	8LK5002-1AA51	8LK6035-1AA62



① Longitudinal stays ② Section expansion ③ Obstacle ④ Mounting plates ⑤ Busbar connection ⑥ Section covers ⑦ Cable connection

Height 1800 mm	Depth 600 mm					
8GK4853-8KK02	–	8LK3011-8AA40	8LK5002-1AA41	8LK6035-1AA52	8LK5002-1AA46	8LK6035-1AA57
8GK4853-8KK02	–	8LK3011-8AA40	8LK5002-1AA41	8LK6035-1AA52	8LK5002-1AA46	8LK6035-1AA57
8GK4853-8KK02	–	8LK3011-8AA41	8LK5002-1AA43	8LK6035-1AA54	8LK5002-1AA48	8LK6035-1AA60
8GK4853-8KK02	–	8LK3011-8AA41	8LK5002-1AA43	8LK6035-1AA54	8LK5002-1AA48	8LK6035-1AA60
8GK4853-8KK02	–	8LK3011-8AA41	8LK5002-1AA44	8LK6035-1AA55	8LK5002-1AA50	8LK6035-1AA61
8GK4853-8KK02	–	8LK3011-8AA41	8LK5002-1AA45	8LK6035-1AA56	8LK5002-1AA51	8LK6035-1AA62
8GK4853-8KK02	8LK3011-8AA38	8LK3011-8AA40	8LK5002-1AA41	8LK6035-1AA52	8LK5002-1AA46	8LK6035-1AA57
8GK4853-8KK02	8LK3011-8AA38	8LK3011-8AA40	8LK5002-1AA41	8LK6035-1AA52	8LK5002-1AA46	8LK6035-1AA57
8GK4853-8KK02	8LK3011-8AA38	8LK3011-8AA41	8LK5002-1AA43	8LK6035-1AA54	8LK5002-1AA48	8LK6035-1AA60
8GK4853-8KK02	8LK3011-8AA38	8LK3011-8AA41	8LK5002-1AA43	8LK6035-1AA54	8LK5002-1AA48	8LK6035-1AA60
8GK4853-8KK02	8LK3011-8AA38	8LK3011-8AA41	8LK5002-1AA44	8LK6035-1AA55	8LK5002-1AA50	8LK6035-1AA61
8GK4853-8KK02	8LK3011-8AA38	8LK3011-8AA41	8LK5002-1AA45	8LK6035-1AA56	8LK5002-1AA51	8LK6035-1AA62

Section expansion

Incoming feeder panels, 3-pole








IP30



Cable connection	Size	I_n	Width	① Compartment doors at top ¹⁾	Door strut	② Compartment doors 3W ¹⁾	Sealing frame	③ Compartment doors at bottom ¹⁾	④ Mounting plates	
Fixed-mounted										
At bottom	0	1250 A	400 mm	8LK2067-4AA07	2 × 8LK3011-6AA57	8LK2060-4AA61	+ 3VW9011-0AP01	8LK2070-4AA21	8LK5002-0AA38	
			600 mm	8LK2067-6AA07	8LK3011-6AA58	8LK2060-6AA60	+ 3WA9111-0AP01	8LK2070-6AA23	8LK5002-1AA53	
	2	3200 A	600 mm	8LK2067-6AA07	8LK3011-6AA58	8LK2060-6AA64	+ 3WA9111-0AP01	8LK2070-6AA23	8LK5002-1AA53	
			800 mm	8LK2067-8AA11	8LK3011-8AA82	8LK2060-8AA41	+ 3WA9111-0AP01	8LK2070-8AA42	8LK5002-1AA54	
	At top	0	1250 A	400 mm	8LK2067-4AA07	2 × 8LK3011-6AA57	8LK2060-4AA61	+ 3VW9011-0AP01	8LK2070-4AA21	8LK5002-0AA38
				600 mm	8LK2067-6AA07	8LK3011-6AA58	8LK2060-6AA60	+ 3WA9111-0AP01	8LK2070-6AA23	8LK5002-1AA53
2		3200 A	600 mm	8LK2067-6AA07	8LK3011-6AA58	8LK2060-6AA64	+ 3WA9111-0AP01	8LK2070-6AA23	8LK5002-1AA53	
			800 mm	8LK2067-8AA11	8LK3011-8AA82	8LK2060-8AA41	+ 3WA9111-0AP01	8LK2070-8AA42	8LK5002-1AA54	
Withdrawable										
At bottom	0	1250 A	400 mm	8LK2067-4AA07	2 × 8LK3011-6AA57	8LK2060-4AA62	+ 3VW9011-0AP02	8LK2070-4AA21	8LK5002-0AA40	
			600 mm	8LK2067-6AA07	8LK3011-6AA58	8LK2060-6AA60	+ 3WA9111-0AP01	8LK2070-6AA23	8LK5002-1AA53	
	2	3200 A	600 mm	8LK2067-6AA07	8LK3011-6AA58	8LK2060-6AA64	+ 3WA9111-0AP01	8LK2070-6AA23	8LK5002-1AA53	
			800 mm	8LK2067-8AA11	8LK3011-8AA82	8LK2060-8AA41	+ 3WA9111-0AP01	8LK2070-8AA42	8LK5002-1AA54	
	At top	0	1250 A	400 mm	8LK2067-4AA07	2 × 8LK3011-6AA57	8LK2060-4AA62	+ 3VW9011-0AP02	8LK2070-4AA21	8LK5002-0AA40
				600 mm	8LK2067-6AA07	8LK3011-6AA58	8LK2060-6AA60	+ 3WA9111-0AP01	8LK2070-6AA23	8LK5002-1AA53
2		3200 A	600 mm	8LK2067-6AA07	8LK3011-6AA58	8LK2060-6AA64	+ 3WA9111-0AP01	8LK2070-6AA23	8LK5002-1AA53	
			800 mm	8LK2067-8AA11	8LK3011-8AA82	8LK2060-8AA41	+ 3WA9111-0AP01	8LK2070-8AA42	8LK5002-1AA54	

¹⁾ Without locking and hinge

Accessories

Hinge		
	Version	Article No.
	Ti-Grey	8LK2000-0AH55
Locking		
	Version	Article No.
	Double-bit	8LK2000-0AH58
	Handle	8LK2000-0AH56
	Handle, lockable	8LK2000-0AH61
	Inner door struts	8LK2000-0AD15
DIN rail overvoltage protection		
	Position	Article No.
	Lateral overvoltage protection, see page 6/10	8LK6034-3AA10

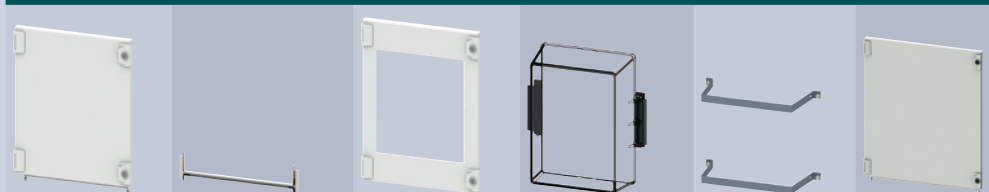
							
Insulation	Ⓢ Busbar connection	Ⓢ Cable connection	Obstacle	Holders	8GK adaptation	Cover frames	Ⓢ Uprights
–	8LK6034-2AA63	8LK3011-6AA41	8LK6034-2AA34	8LK3011-6AA43	8LK3011-6AA45	8LK3011-6AA60 + 8LK3011-8AA38	
–	8LK6035-3AA07	8LK3011-6AA41	8LK6035-3AA33	8LK3011-6AA43	8LK3011-6AA45	8LK3012-0AA32	
–	8LK6035-3AA10	8LK3011-6AA61	8LK6035-3AA34	8LK3011-6AA44	8LK3011-6AA50	8LK3012-0AA32	
–	8LK6035-3AA12	8LK3011-6AA61	8LK6035-3AA36	8LK3011-6AA44	8LK3011-6AA50	8LK3012-0AA32	
–	8LK6035-3AA14	8LK3012-0AA00	8LK6035-3AA38	8LK3011-8AA83	8LK3011-8AA88	8LK3012-0AA32	
–	8LK6034-2AA63	8LK3011-6AA41	8LK6034-2AA34	8LK3011-6AA43	8LK3011-6AA47	8LK3011-6AA60 + 8LK3011-8AA38	
–	8LK6035-3AA07	8LK3011-6AA41	8LK6035-3AA33	8LK3011-6AA43	8LK3011-6AA47	8LK3012-0AA16	
–	8LK6035-3AA10	8LK3011-6AA61	8LK6035-3AA34	8LK3011-6AA44	8LK3011-6AA52	8LK3012-0AA16	
–	8LK6035-3AA12	8LK3011-6AA61	8LK6035-3AA36	8LK3011-6AA44	8LK3011-6AA52	8LK3012-0AA16	
–	8LK6035-3AA14	8LK3012-0AA00	8LK6035-3AA38	8LK3011-8AA83	8LK3011-8AA86	8LK3012-0AA16	
–	8LK6034-2AA64	8LK3011-6AA41	8LK6034-2AA37	8LK3011-6AA43	8LK3011-6AA45	8LK3011-6AA60 + 8LK3011-8AA38	
8LK6035-3AA68	8LK6035-3AA06	8LK3011-6AA41	8LK6035-3AA32	8LK3011-6AA43	8LK3011-6AA45	8LK3012-0AA32	
–	8LK6035-3AA08	8LK3011-6AA61	8LK6035-2AA33	8LK3011-6AA44	8LK3011-6AA50	8LK3012-0AA32	
–	8LK6035-3AA11	8LK3011-6AA61	8LK6035-3AA35	8LK3011-6AA44	8LK3011-6AA50	8LK3012-0AA32	
–	8LK6035-3AA13	8LK3012-0AA00	8LK6035-2AA34	8LK3011-8AA83	8LK3011-8AA88	8LK3012-0AA32	
–	8LK6034-2AA64	8LK3011-6AA41	8LK6034-2AA37	8LK3011-6AA43	8LK3011-6AA47	8LK3011-6AA60 + 8LK3011-8AA38	
8LK6035-3AA68	8LK6035-3AA06	8LK3011-6AA41	8LK6035-3AA32	8LK3011-6AA43	8LK3011-6AA47	8LK3012-0AA16	
–	8LK6035-3AA08	8LK3011-6AA61	8LK6035-2AA33	8LK3011-6AA44	8LK3011-6AA52	8LK3012-0AA16	
–	8LK6035-3AA11	8LK3011-6AA61	8LK6035-3AA35	8LK3011-6AA44	8LK3011-6AA52	8LK3012-0AA16	
–	8LK6035-3AA13	8LK3012-0AA00	8LK6035-2AA34	8LK3011-8AA83	8LK3011-8AA86	8LK3012-0AA16	

Section expansion

Incoming feeder panels, 3-pole








IP54

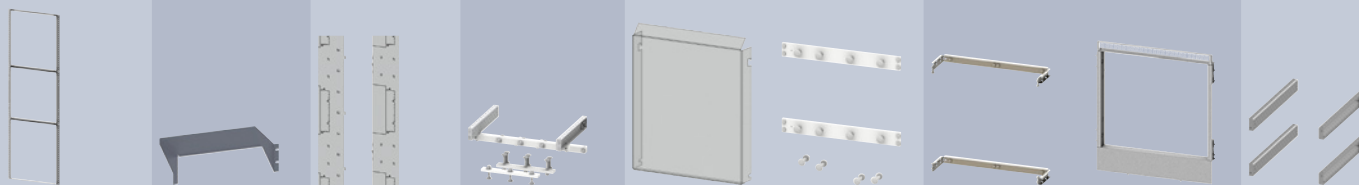


Cable connection	Size	I_n	Width	⊙ Compartment doors at top ¹⁾	Door strut	⊙ Compartment doors 3W ¹⁾	Plexiglas cover	Fixing element	⊙ Compartment doors at bottom ¹⁾
Fixed-mounted									
At bottom	0	1250 A	400 mm	8LK2067-4AA08	2 × 8LK3011-6AA57	8LK2060-4AA57	+ 3WA9111-0AP03	+ 8LK2000-0AJ65	8LK2070-4AA22
	1	2000 A	400 mm	8LK2067-4AA08	8LK3011-6AA57	8LK2060-4AA70	+ 3WA9111-0AP03	–	8LK2070-4AA22
			600 mm	8LK2067-6AA08	8LK3011-6AA58	8LK2060-6AA61	+ 3WA9111-0AP03	–	8LK2070-6AA24
	2	3200 A	600 mm	8LK2067-6AA08	8LK3011-6AA58	8LK2060-6AA65	+ 3WA9111-0AP03	–	8LK2070-6AA24
			800 mm	8LK2067-8AA12	8LK3011-8AA82	8LK2060-8AA42	+ 3WA9111-0AP03	–	8LK2070-8AA43
	At top	0	1250 A	400 mm	8LK2067-4AA08	2 × 8LK3011-6AA57	8LK2060-4AA57	+ 3WA9111-0AP03	+ 8LK2000-0AJ65
1		2000 A	400 mm	8LK2067-4AA08	8LK3011-6AA57	8LK2060-4AA70	+ 3WA9111-0AP03	–	8LK2070-4AA22
			600 mm	8LK2067-6AA08	8LK3011-6AA58	8LK2060-6AA61	+ 3WA9111-0AP03	–	8LK2070-6AA24
2		3200 A	600 mm	8LK2067-6AA08	8LK3011-6AA58	8LK2060-6AA65	+ 3WA9111-0AP03	–	8LK2070-6AA24
			800 mm	8LK2067-8AA12	8LK3011-8AA82	8LK2060-8AA42	+ 3WA9111-0AP03	–	8LK2070-8AA43
Withdrawable									
At bottom	0	1250 A	400 mm	8LK2067-4AA08	2 × 8LK3011-6AA57	8LK2060-4AA60	+ 3WA9111-0AP03	+ 8LK2000-0AJ65	8LK2070-4AA22
	1	2000 A	400 mm	8LK2067-4AA08	8LK3011-6AA57	8LK2060-4AA70	+ 3WA9111-0AP03	–	8LK2070-4AA22
			600 mm	8LK2067-6AA08	8LK3011-6AA58	8LK2060-6AA61	+ 3WA9111-0AP03	–	8LK2070-6AA24
	2	3200 A	600 mm	8LK2067-6AA08	8LK3011-6AA58	8LK2060-6AA65	+ 3WA9111-0AP03	–	8LK2070-6AA24
			800 mm	8LK2067-8AA12	8LK3011-8AA82	8LK2060-8AA42	+ 3WA9111-0AP03	–	8LK2070-8AA43
	At top	0	1250 A	400 mm	8LK2067-4AA08	2 × 8LK3011-6AA57	8LK2060-4AA60	+ 3WA9111-0AP03	+ 8LK2000-0AJ65
1		2000 A	400 mm	8LK2067-4AA08	8LK3011-6AA57	8LK2060-4AA70	+ 3WA9111-0AP03	–	8LK2070-4AA22
			600 mm	8LK2067-6AA08	8LK3011-6AA58	8LK2060-6AA61	+ 3WA9111-0AP03	–	8LK2070-6AA24
2		3200 A	600 mm	8LK2067-6AA08	8LK3011-6AA58	8LK2060-6AA65	+ 3WA9111-0AP03	–	8LK2070-6AA24
			800 mm	8LK2067-8AA12	8LK3011-8AA82	8LK2060-8AA42	+ 3WA9111-0AP03	–	8LK2070-8AA43

¹⁾ Without locking and hinge

Accessories

Hinge		
	Version	Article No.
	Ti-Grey	8LK2000-0AH55
Locking		
	Version	Article No.
	Double-bit	8LK2000-0AH58
	Handle	8LK2000-0AH56
	Handle, lockable	8LK2000-0AH61
	Inner door struts	8LK2000-0AD15
DIN rail overvoltage protection		
	Position	Article No.
	Lateral overvoltage protection, see page 6/10	8LK6034-3AA10



Sealing frame

④ Mounting plates

Insulation

⑤ Busbar connection

⑥ Cable connection

Obstacle

Holders

⑦ Auxiliary device compartments

8GK adaptation

Cover frames

⑧ Uprights

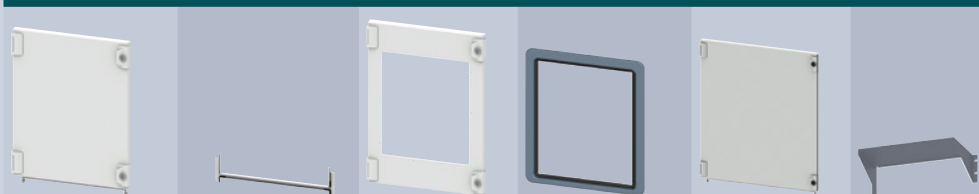
8LK2197-4AD44	8LK5002-0AA38	–	8LK6034-2AA63	8LK3011-6AA41	8LK6034-2AA34	8LK3011-6AA43	8LK3011-6AA46	8LK3011-6AA60 + 8LK3011-8AA38
8LK2197-4AD44	8LK5002-1AA52	–	8LK6035-3AA07	8LK3011-6AA41	8LK6035-3AA33	8LK3011-6AA43	8LK3011-6AA46	8LK3012-0AA32
8LK2197-6AC65	8LK5002-1AA53	–	8LK6035-3AA10	8LK3011-6AA61	8LK6035-3AA34	8LK3011-6AA44	8LK3011-6AA51	8LK3012-0AA32
8LK2197-6AC65	8LK5002-1AA53	–	8LK6035-3AA12	8LK3011-6AA61	8LK6035-3AA36	8LK3011-6AA44	8LK3011-6AA51	8LK3012-0AA32
8LK2197-8AD25	8LK5002-1AA54	–	8LK6035-3AA14	8LK3012-0AA00	8LK6035-3AA38	8LK3011-8AA83	8LK3011-8AA85	8LK3012-0AA32
8LK2197-4AD44	8LK5002-0AA38	–	8LK6034-2AA63	8LK3011-6AA41	8LK6034-2AA34	8LK3011-6AA43	8LK3011-6AA48	8LK3011-6AA60 + 8LK3011-8AA38
8LK2197-4AD44	8LK5002-1AA52	–	8LK6035-3AA07	8LK3011-6AA41	8LK6035-3AA33	8LK3011-6AA43	8LK3011-6AA48	8LK3012-0AA16
8LK2197-6AC65	8LK5002-1AA53	–	8LK6035-3AA10	8LK3011-6AA61	8LK6035-3AA34	8LK3011-6AA44	8LK3011-6AA53	8LK3012-0AA16
8LK2197-6AC65	8LK5002-1AA53	–	8LK6035-3AA12	8LK3011-6AA61	8LK6035-3AA36	8LK3011-6AA44	8LK3011-6AA53	8LK3012-0AA16
8LK2197-8AD25	8LK5002-1AA54	–	8LK6035-3AA14	8LK3012-0AA00	8LK6035-3AA38	8LK3011-8AA83	8LK3011-8AA87	8LK3012-0AA16
8LK2197-4AD44	8LK5002-0AA40	–	8LK6034-2AA64	8LK3011-6AA41	8LK6034-2AA37	8LK3011-6AA43	8LK3011-6AA46	8LK3011-6AA60 + 8LK3011-8AA38
8LK2197-4AD44	8LK5002-1AA52	8LK6035-3AA68	8LK6035-3AA06	8LK3011-6AA41	8LK6035-3AA32	8LK3011-6AA43	8LK3011-6AA46	8LK3012-0AA32
8LK2197-6AC65	8LK5002-1AA53	–	8LK6035-3AA08	8LK3011-6AA61	8LK6035-2AA33	8LK3011-6AA44	8LK3011-6AA51	8LK3012-0AA32
8LK2197-6AC65	8LK5002-1AA53	–	8LK6035-3AA11	8LK3011-6AA61	8LK6035-3AA35	8LK3011-6AA44	8LK3011-6AA51	8LK3012-0AA32
8LK2197-8AD25	8LK5002-1AA54	–	8LK6035-3AA13	8LK3012-0AA00	8LK6035-2AA34	8LK3011-8AA83	8LK3011-8AA85	8LK3012-0AA32
8LK2197-4AD44	8LK5002-0AA40	–	8LK6034-2AA64	8LK3011-6AA41	8LK6034-2AA37	8LK3011-6AA43	8LK3011-6AA48	8LK3011-6AA60 + 8LK3011-8AA38
8LK2197-4AD44	8LK5002-1AA52	8LK6035-3AA68	8LK6035-3AA06	8LK3011-6AA41	8LK6035-3AA32	8LK3011-6AA43	8LK3011-6AA48	8LK3012-0AA16
8LK2197-6AC65	8LK5002-1AA53	–	8LK6035-3AA08	8LK3011-6AA61	8LK6035-2AA33	8LK3011-6AA44	8LK3011-6AA53	8LK3012-0AA16
8LK2197-6AC65	8LK5002-1AA53	–	8LK6035-3AA11	8LK3011-6AA61	8LK6035-3AA35	8LK3011-6AA44	8LK3011-6AA53	8LK3012-0AA16
8LK2197-8AD25	8LK5002-1AA54	–	8LK6035-3AA13	8LK3012-0AA00	8LK6035-2AA34	8LK3011-8AA83	8LK3011-8AA87	8LK3012-0AA16

Section expansion

Incoming feeder panels, 4-pole




IP30







Cable connection	Size	I_n	Width	① Compartment doors at top ¹⁾	Door strut	② Compartment doors 3W ¹⁾	Sealing frame	③ Compartment doors at bottom ¹⁾	④ Mounting plates
Fixed-mounted									
At bottom	0	1250 A	400 mm	8LK2067-4AA07	2 × 8LK3011-6AA57	8LK2060-4AA61	3VW9011-0AP01	8LK2070-4AA21	8LK5002-0AA38
	1	2000 A	600 mm	8LK2067-6AA07	8LK3011-6AA58	8LK2060-6AA60	3WA9111-0AP01	8LK2070-6AA23	8LK5002-1AA53
	2	3200 A	800 mm	8LK2067-8AA11	8LK3011-8AA82	8LK2060-8AA41	3WA9111-0AP01	8LK2070-8AA42	8LK5002-1AA54
At top	0	1250 A	400 mm	8LK2067-4AA07	2 × 8LK3011-6AA57	8LK2060-4AA61	3VW9011-0AP01	8LK2070-4AA21	8LK5002-0AA38
	1	2000 A	600 mm	8LK2067-6AA07	8LK3011-6AA58	8LK2060-6AA60	3WA9111-0AP01	8LK2070-6AA23	8LK5002-1AA53
	2	3200 A	800 mm	8LK2067-8AA11	8LK3011-8AA82	8LK2060-8AA41	3WA9111-0AP01	8LK2070-8AA42	8LK5002-1AA54
Withdrawable									
At bottom	0	1250 A	600 mm	8LK2067-6AA07	2 × 8LK3011-6AA58	8LK2060-6AA54	3VW9011-0AP02	8LK2070-6AA23	8LK5002-0AA41
	1	2000 A	600 mm	8LK2067-6AA07	8LK3011-6AA58	8LK2060-6AA60	3WA9111-0AP01	8LK2070-6AA23	8LK5002-1AA53
	2	3200 A	800 mm	8LK2067-8AA11	8LK3011-8AA82	8LK2060-8AA41	3WA9111-0AP01	8LK2070-8AA42	8LK5002-1AA54
At top	0	1250 A	600 mm	8LK2067-6AA07	2 × 8LK3011-6AA58	8LK2060-6AA54	3VW9011-0AP02	8LK2070-6AA23	8LK5002-0AA41
	1	2000 A	600 mm	8LK2067-6AA07	8LK3011-6AA58	8LK2060-6AA60	3WA9111-0AP01	8LK2070-6AA23	8LK5002-1AA53
	2	3200 A	800 mm	8LK2067-8AA11	8LK3011-8AA82	8LK2060-8AA41	3WA9111-0AP01	8LK2070-8AA42	8LK5002-1AA54

¹⁾ Without locking and hinge

Accessories

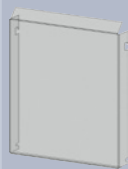
Hinge		
	Version	Article No.
	Ti-Grey	8LK2000-0AH55

Locking		
	Version	Article No.
	Double-bit	8LK2000-0AH58
	Handle	8LK2000-0AH56
	Handle, lockable	8LK2000-0AH61
	Inner door struts	8LK2000-0AD15

DIN rail overvoltage protection		
	Position	Article No.
	Lateral overvoltage protection, see page 6/10	8LK6034-3AA10



⑥ Busbar connection



⑥ Cable connection

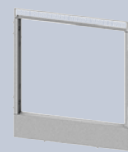


Obstacle

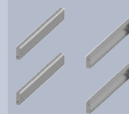
Holders



8GK adaptation



Cover frames



⑥ Uprights

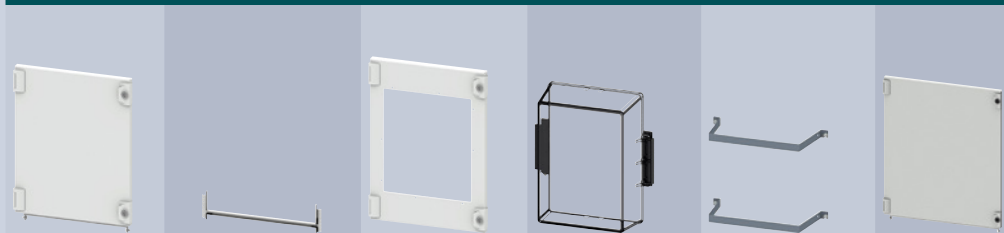
8LK6034-2AA63	8LK3011-6AA41	8LK6034-2AA34	8LK3011-6AA43	8LK3011-6AA45	8LK3011-6AA60 + 8LK3011-8AA38
8LK6035-3AA15	8LK3011-6AA61	8LK6035-3AA37	8LK3011-6AA44	8LK3011-6AA50	8LK3012-0AA32
8LK6035-3AA16	8LK3012-0AA00	8LK6035-3AA40	8LK3011-8AA83	8LK3011-8AA88	8LK3012-0AA32
8LK6034-2AA63	8LK3011-6AA41	8LK6034-2AA34	8LK3011-6AA43	8LK3011-6AA47	8LK3011-6AA60 + 8LK3011-8AA38
8LK6035-3AA15	8LK3011-6AA61	8LK6035-3AA37	8LK3011-6AA44	8LK3011-6AA52	8LK3012-0AA16
8LK6035-3AA16	8LK3012-0AA00	8LK6035-3AA40	8LK3011-8AA83	8LK3011-8AA86	8LK3012-0AA16
8LK6034-2AA65	8LK3011-6AA61	8LK6034-2AA42	8LK3011-6AA44	8LK3011-6AA50	8LK3011-6AA60 + 8LK3011-8AA38
8LK6035-2AA27	8LK3011-6AA61	8LK6035-2AA33	8LK3011-6AA44	8LK3011-6AA50	8LK3012-0AA32
8LK6035-2AA67	8LK3012-0AA00	8LK6035-4AA78	8LK3011-8AA83	8LK3011-8AA88	8LK3012-0AA32
8LK6034-2AA65	8LK3011-6AA61	8LK6034-2AA42	8LK3011-6AA44	8LK3011-6AA52	8LK3011-6AA60 + 8LK3011-8AA38
8LK6035-2AA27	8LK3011-6AA61	8LK6035-2AA33	8LK3011-6AA44	8LK3011-6AA52	8LK3012-0AA16
8LK6035-2AA67	8LK3012-0AA00	8LK6035-4AA78	8LK3011-8AA83	8LK3011-8AA86	8LK3012-0AA16

Section expansion

Incoming feeder panels, 4-pole








IP54



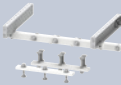




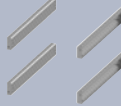


Cable connection	Size	I_n	Width	① Compartment doors at top ¹⁾	Door strut	② Compartment doors 3W ¹⁾	Plexiglas cover	Fixing element	③ Compartment doors at bottom ¹⁾
Fixed-mounted									
At bottom	0	1250 A	400 mm	8LK2067-4AA08	2 × 8LK3011-6AA57	8LK2060-4AA57	+ 3WA9111-0AP03	+ 8LK2000-0AJ65	8LK2070-4AA22
	1	2000 A	600 mm	8LK2067-6AA08	8LK3011-6AA58	8LK2060-6AA61	+ 3WA9111-0AP03	–	8LK2070-6AA24
	2	3200 A	800 mm	8LK2067-8AA12	8LK3011-8AA82	8LK2060-8AA42	+ 3WA9111-0AP03	–	8LK2070-8AA43
At top	0	1250 A	400 mm	8LK2067-4AA08	2 × 8LK3011-6AA57	8LK2060-4AA57	+ 3WA9111-0AP03	+ 8LK2000-0AJ65	8LK2070-4AA22
	1	2000 A	600 mm	8LK2067-6AA08	8LK3011-6AA58	8LK2060-6AA61	+ 3WA9111-0AP03	–	8LK2070-6AA24
	2	3200 A	800 mm	8LK2067-8AA12	8LK3011-8AA82	8LK2060-8AA42	+ 3WA9111-0AP03	–	8LK2070-8AA43
Withdrawable									
At bottom	0	1250 A	600 mm	8LK2067-6AA08	2 × 8LK3011-6AA58	8LK2060-6AA53	+ 3WA9111-0AP03	+ 8LK2000-0AJ65	8LK2070-6AA24
	1	2000 A	600 mm	8LK2067-6AA08	8LK3011-6AA58	8LK2060-6AA61	+ 3WA9111-0AP03	–	8LK2070-6AA24
	2	3200 A	800 mm	8LK2067-8AA12	8LK3011-8AA82	8LK2060-8AA42	+ 3WA9111-0AP03	–	8LK2070-8AA43
At top	0	1250 A	600 mm	8LK2067-6AA08	2 × 8LK3011-6AA58	8LK2060-6AA53	+ 3WA9111-0AP03	+ 8LK2000-0AJ65	8LK2070-6AA24
	1	2000 A	600 mm	8LK2067-6AA08	8LK3011-6AA58	8LK2060-6AA61	+ 3WA9111-0AP03	–	8LK2070-6AA24
	2	3200 A	800 mm	8LK2067-8AA12	8LK3011-8AA82	8LK2060-8AA42	+ 3WA9111-0AP03	–	8LK2070-8AA43

¹⁾ Without locking and hinge

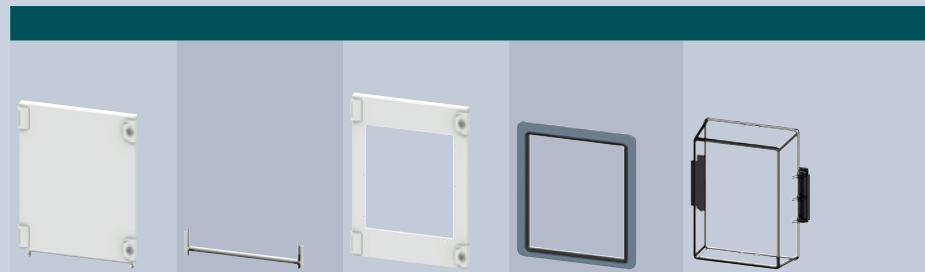
Accessories

Hinge		
	Version	Article No.
	Ti-Grey	8LK2000-0AH55
Locking		
	Version	Article No.
	Double-bit	8LK2000-0AH58
	Handle	8LK2000-0AH56
	Handle, lockable	8LK2000-0AH61
	Inner door struts	8LK2000-0AD15
DIN rail overvoltage protection		
	Position	Article No.
	Lateral overvoltage protection, see page 6/10	8LK6034-3AA10

							
Sealing frame	④ Mounting plates	⑤ Busbar connection	⑥ Obstacle	⑦ Holders	⑧ 8GK adaptation	⑨ Cover frames	⑩ Uprights
8LK2197-4AD44	8LK5002-0AA38	8LK6034-2AA63	8LK3011-6AA41	8LK6034-2AA34	8LK3011-6AA43	8LK3011-6AA46	8LK3011-6AA60 + 8LK3011-8AA38
8LK2197-6AC65	8LK5002-1AA53	8LK6035-3AA15	8LK3011-6AA61	8LK6035-3AA37	8LK3011-6AA44	8LK3011-6AA51	8LK3012-0AA32
8LK2197-8AD25	8LK5002-1AA54	8LK6035-3AA16	8LK3012-0AA00	8LK6035-3AA40	8LK3011-8AA83	8LK3011-8AA85	8LK3012-0AA32
8LK2197-4AD44	8LK5002-0AA38	8LK6034-2AA63	8LK3011-6AA41	8LK6034-2AA34	8LK3011-6AA43	8LK3011-6AA48	8LK3011-6AA60 + 8LK3011-8AA38
8LK2197-6AC65	8LK5002-1AA53	8LK6035-3AA15	8LK3011-6AA61	8LK6035-3AA37	8LK3011-6AA44	8LK3011-6AA53	8LK3012-0AA16
8LK2197-8AD25	8LK5002-1AA54	8LK6035-3AA16	8LK3012-0AA00	8LK6035-3AA40	8LK3011-8AA83	8LK3011-8AA87	8LK3012-0AA16
8LK2197-6AC65	8LK5002-0AA41	8LK6034-2AA65	8LK3011-6AA61	8LK6034-2AA42	8LK3011-6AA44	8LK3011-6AA51	8LK3011-6AA60 + 8LK3011-8AA38
8LK2197-6AC65	8LK5002-1AA53	8LK6035-2AA27	8LK3011-6AA61	8LK6035-2AA33	8LK3011-6AA44	8LK3011-6AA51	8LK3012-0AA32
8LK2197-8AD25	8LK5002-1AA54	8LK6035-2AA67	8LK3012-0AA00	8LK6035-4AA78	8LK3011-8AA83	8LK3011-8AA85	8LK3012-0AA32
8LK2197-6AC65	8LK5002-0AA41	8LK6034-2AA65	8LK3011-6AA61	8LK6034-2AA42	8LK3011-6AA44	8LK3011-6AA53	8LK3011-6AA60 + 8LK3011-8AA38
8LK2197-6AC65	8LK5002-1AA53	8LK6035-2AA27	8LK3011-6AA61	8LK6035-2AA33	8LK3011-6AA44	8LK3011-6AA53	8LK3012-0AA16
8LK2197-8AD25	8LK5002-1AA54	8LK6035-2AA67	8LK3012-0AA00	8LK6035-4AA78	8LK3011-8AA83	8LK3011-8AA87	8LK3012-0AA16

Section expansion

Coupling panels



Degree of protection	Size	I_n	Type of mounting	Width	① Compartment doors at top ¹⁾	Door strut	② Compartment doors 3W ¹⁾	Sealing frame	Plexiglas cover
3-pole									
IP30	1	2000 A	Fixed-mounted	600 mm	8LK2067-6AA07	8LK3011-6AA58	8LK2060-4AA66	+ 3WA9111-0AP01	
			Withdrawable	600 mm	8LK2067-6AA07	8LK3011-6AA58	8LK2060-4AA66	+ 3WA9111-0AP01	
IP54	1	2000 A	Fixed-mounted	600 mm	8LK2067-6AA08	8LK3011-6AA58	8LK2060-6AA67		+ 3WA9111-0AP03
			Withdrawable	600 mm	8LK2067-6AA08	8LK3011-6AA58	8LK2060-6AA67		+ 3WA9111-0AP03
4-pole									
IP30	1	2000 A	Fixed-mounted	600 mm	8LK2067-6AA07	8LK3011-6AA58	8LK2060-4AA66	+ 3WA9111-0AP01	
			Withdrawable	600 mm	8LK2067-6AA07	8LK3011-6AA58	8LK2060-4AA66	+ 3WA9111-0AP01	
IP54	1	2000 A	Fixed-mounted	600 mm	8LK2067-6AA08	8LK3011-6AA58	8LK2060-6AA67		+ 3WA9111-0AP03
			Withdrawable	600 mm	8LK2067-6AA08	8LK3011-6AA58	8LK2060-6AA67		+ 3WA9111-0AP03

¹⁾ Without locking and hinge

Accessories

Hinge		
	Version	Article No.
	Ti-Grey	8LK2000-0AH55
Locking		
	Version	Article No.
	Double-bit	8LK2000-0AH58
	Handle	8LK2000-0AH56
	Handle, lockable	8LK2000-0AH61
	Inner door struts	8LK2000-0AD15



③ Compartment doors at bottom ¹⁾



Sealing frame IP54



④ Mounting plates



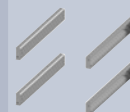
⑤ Busbar connection L1 - L3 N



⑥ Auxiliary device compartments 8GK adaptation



Cover frames

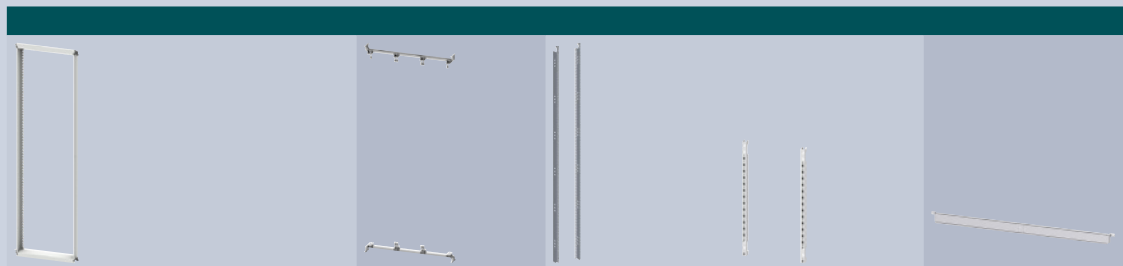
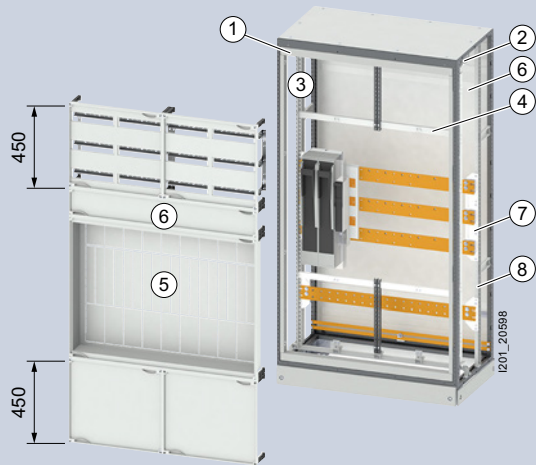


⑦ Uprights

8LK2070-6AA23		8LK5002-1AA53	8LK6035-4AA33	–	2 × 8LK3011-6AA44	8LK3012-0AA25	8LK3012-0AA23
8LK2070-6AA23		8LK5002-1AA53	8LK6035-4AA32	–	2 × 8LK3011-6AA44	8LK3012-0AA25	8LK3012-0AA23
8LK2070-6AA24	8LK2197-6AC65	8LK5002-1AA53	8LK6035-4AA33	–	2 × 8LK3011-6AA44	8LK3012-0AA26	8LK3012-0AA23
8LK2070-6AA24	8LK2197-6AC65	8LK5002-1AA53	8LK6035-4AA32	–	2 × 8LK3011-6AA44	8LK3012-0AA26	8LK3012-0AA23
8LK2070-6AA23		8LK5002-1AA53	8LK6035-4AA33	8LK6035-4AA35	2 × 8LK3011-6AA44	8LK3012-0AA25	8LK3012-0AA23
8LK2070-6AA23		8LK5002-1AA53	8LK6035-4AA32	8LK6035-4AA34	2 × 8LK3011-6AA44	8LK3012-0AA25	8LK3012-0AA23
8LK2070-6AA24	8LK2197-6AC65	8LK5002-1AA53	8LK6035-4AA33	8LK6035-4AA35	2 × 8LK3011-6AA44	8LK3012-0AA26	8LK3012-0AA23
8LK2070-6AA24	8LK2197-6AC65	8LK5002-1AA53	8LK6035-4AA32	8LK6035-4AA34	2 × 8LK3011-6AA44	8LK3012-0AA26	8LK3012-0AA23

Section expansion

3NJ4 in-line design



Depth	Width	Quantity NH1	1 Cover frames		2 8GK adaptation	3 Longitudinal stays		4 Crossbars
			IP30	IP54		Height 1800 mm	450 mm	
400 mm	600 mm	4	8LK3011-5AA86	8LK3011-6AA01	8LK3011-6AA32	8GK4853-8KK02	–	–
	850 mm	7	8LK3011-5AA87	8LK3011-6AA02	8LK3011-6AA33	8GK4853-8KK02	–	–
	1100 mm	9	8LK3011-5AA88	8LK3011-6AA03	8LK3011-6AA34	8GK4853-8KK02	8GK4851-3KK00	8GK4853-OKK40
600 mm	600 mm	4	8LK3011-5AA86	8LK3011-6AA01	8LK3011-6AA32	8GK4853-8KK02	–	–
	850 mm	7	8LK3011-5AA87	8LK3011-6AA02	8LK3011-6AA33	8GK4853-8KK02	–	–
	1100 mm	9	8LK3011-5AA88	8LK3011-6AA03	8LK3011-6AA34	8GK4853-8KK02	8GK4851-3KK00	8GK4853-OKK40

15

Accessories

NH00 installation



Version	Article No.
Adapter 185 mm	3NJ4918-0DA02



Covers	3NJ4912-1DA02
--------	---------------



⑥ 3NJ4 covers



⑥ Blanking covers



⑦ Busbar supports



⑧ Uprights

8LK5002-0AA30

8LK5002-2AA21

8LK4002-6AA38

–

8LK5002-0AA31

8LK5002-2AA22

8LK4002-6AA38

–

8LK5002-0AA37

8LK5002-2AA04

8LK4002-6AA38

–

8LK5002-0AA30

8LK5002-2AA21

8LK4002-6AA38

8LK3011-8AA38

8LK5002-0AA31

8LK5002-2AA22

8LK4002-6AA38

8LK3011-8AA38

8LK5002-0AA37

8LK5002-2AA04

8LK4002-6AA38

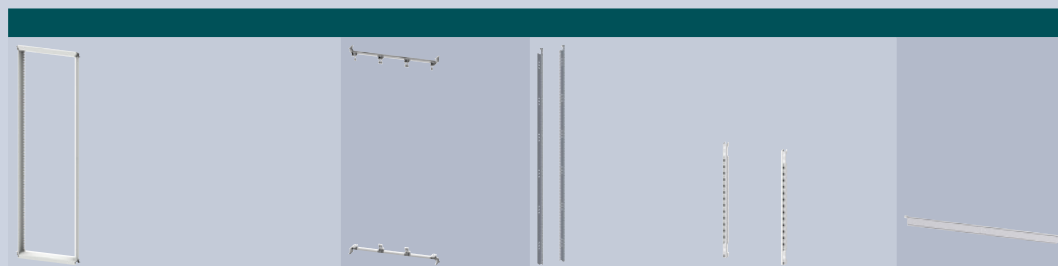
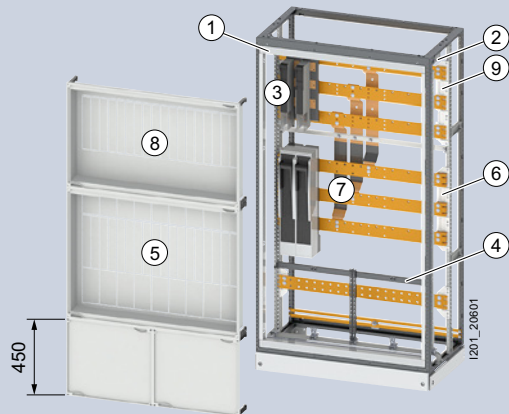
8LK3011-8AA38

See 3NJ4 fuse switch disconnectors from page 8/102

See LV HRC fuse links from page 7/36

Section expansion

3NJ4 in-line design with second level



Depth	Width	Quantity		1 Cover frames		2 8GK adaptation	3 Longitudinal stays		4 Crossbars
		NH1	NH2	IP30	IP54		Height	450 mm	
400 mm	600 mm	3	8	8LK3011-5AA86	8LK3011-6AA01	8LK3011-6AA32	8GK4853-8KK02	–	–
	850 mm	6	14	8LK3011-5AA87	8LK3011-6AA02	8LK3011-6AA33	8GK4853-8KK02	–	–
	1100 mm	7	18	8LK3011-5AA88	8LK3011-6AA03	8LK3011-6AA34	8GK4853-8KK02	8GK4851-3KK00	8GK4853-0KK40
600 mm	600 mm	3	8	8LK3011-5AA86	8LK3011-6AA01	8LK3011-6AA32	8GK4853-8KK02	–	–
	850 mm	6	14	8LK3011-5AA87	8LK3011-6AA02	8LK3011-6AA33	8GK4853-8KK02	–	–
	1100 mm	7	18	8LK3011-5AA88	8LK3011-6AA03	8LK3011-6AA34	8GK4853-8KK02	8GK4851-3KK00	8GK4853-0KK40

15

Accessories

NH00 installation

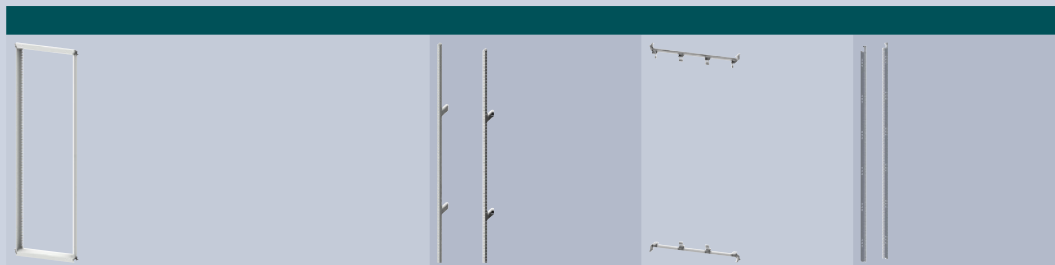
Version	Article No.
Adapter 185 mm	3NJ4918-0DA02
Covers	3NJ4912-1DA02

⑥ 3NJ4 covers		⑧ Busbar supports		⑦ Cable duct		⑥ 3NJ4 covers		⑧ Busbar supports		⑧ Uprights	
				center	outside	rear	NH00	at top			
8LK5002-0AA30	8LK4002-6AA38	–		8LK5002-0AA36	–	–	8LK5002-0AA32	8LK4002-8AA82	–		
8LK5002-0AA31	8LK4002-6AA38	–		8LK5002-0AA34	–	–	8LK5002-0AA28	8LK4002-8AA83	–		
8LK5002-0AA37	8LK4002-6AA38	8LK5002-0AA35		8LK5002-0AA36	–	–	8LK5002-0AA33	8LK4002-8AA84	–		
8LK5002-0AA30	8LK4002-6AA38	–	–	–	–	8LK5002-2AA17	8LK5002-0AA32	8LK4002-8AA82	–	8LK3011-8AA38	
8LK5002-0AA31	8LK4002-6AA38	–	–	–	–	8LK5002-2AA20	8LK5002-0AA28	8LK4002-8AA83	–	8LK3011-8AA38	
8LK5002-0AA37	8LK4002-6AA38	–	–	–	–	8LK5002-2AA18	8LK5002-0AA33	8LK4002-8AA84	–	8LK3011-8AA38	

See 3NJ4 fuse switch disconnectors from page 8/102
 See LV HRC fuse links from page 7/36

Section expansion

ALPHA 8GK modular installation system



Depth	Width	① Cover frames		② Uprights Depth 600 mm	③ 8GK adaptation	④ Longitudinal stays Height 1800 mm
		IP30	IP54			
400 mm	350 mm	8LK3011-5AA85	8LK3011-6AA00	–	8LK3011-6AA31	1 × 8GK4853-8KK02
	600 mm	8LK3011-5AA86	8LK3011-6AA01	–	8LK3011-6AA32	2 × 8GK4853-8KK02
	850 mm	8LK3011-5AA87	8LK3011-6AA02	–	8LK3011-6AA33	3 × 8GK4853-8KK02
	1100 mm	8LK3011-5AA88	8LK3011-6AA03	–	8LK3011-6AA34	4 × 8GK4853-8KK02
600 mm	350 mm	8LK3011-5AA85	8LK3011-6AA00	8LK3011-8AA38	8LK3011-6AA31	1 × 8GK4853-8KK02
	600 mm	8LK3011-5AA86	8LK3011-6AA01	8LK3011-8AA38	8LK3011-6AA32	2 × 8GK4853-8KK02
	850 mm	8LK3011-5AA87	8LK3011-6AA02	8LK3011-8AA38	8LK3011-6AA33	3 × 8GK4853-8KK02
	1100 mm	8LK3011-5AA88	8LK3011-6AA03	8LK3011-8AA38	8LK3011-6AA34	4 × 8GK4853-8KK02

Accessories

Cable clamping rail



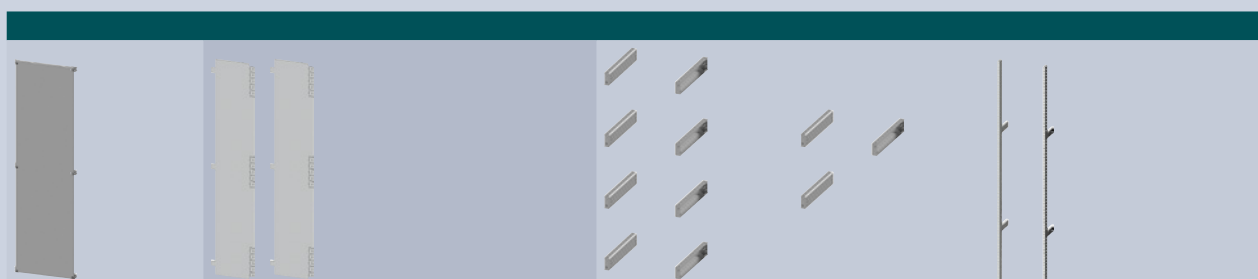
- For strain relief
- C profile 30 × 15 mm
- Mounting on longitudinal stays

Width	Article No.
250 mm	8GK9911-0KK10
500 mm	8GK9911-0KK20
750 mm	8GK9911-0KK30
1000 mm	8GK9911-0KK40
1250 mm	8GK9911-0KK50

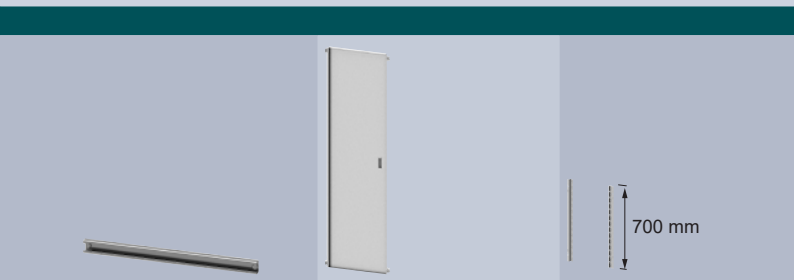
See ALPHA 8GK assembly kits from page 15/210

Section expansion

Mounting plates



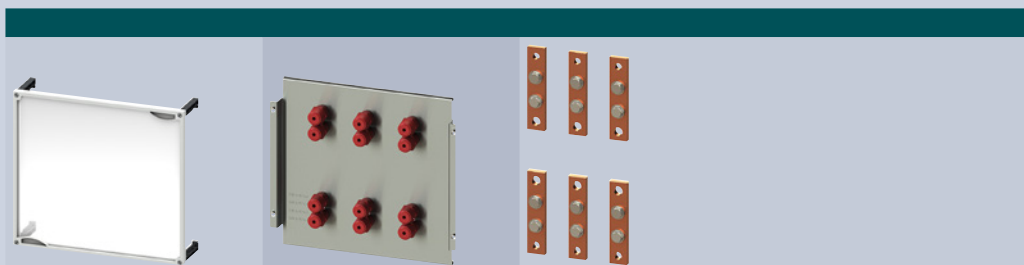
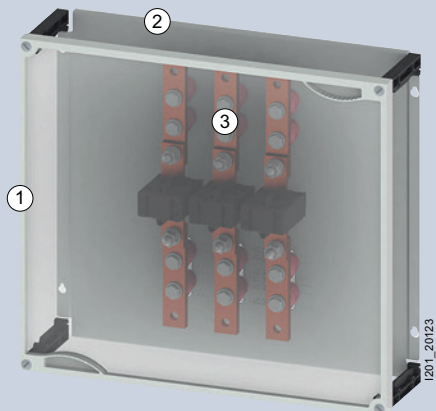
Depth	Width	① Mounting plates	② Separation		③ Uprights		Depth 600 mm
			with main busbar	without main busbar	with main busbar	without main busbar	
400 mm	400 mm	8LK3011-5AA30	8LK3011-5AA23	8LK3011-5AA35	8LK3011-5AA37	8LK3011-5AA36	–
	600 mm	8LK3011-5AA31	8LK3011-5AA23	8LK3011-5AA35	8LK3011-5AA37	8LK3011-5AA36	–
	800 mm	8LK3011-5AA32	8LK3011-5AA23	8LK3011-5AA35	8LK3011-5AA37	8LK3011-5AA36	–
	1100 mm	8LK3011-5AA33	8LK3011-5AA23	8LK3011-5AA35	8LK3011-5AA37	8LK3011-5AA36	–
600 mm	400 mm	8LK3011-5AA30	8LK3011-5AA23	8LK3011-5AA35	8LK3011-5AA37	8LK3011-5AA36	8LK3011-8AA38
	600 mm	8LK3011-5AA31	8LK3011-5AA23	8LK3011-5AA35	8LK3011-5AA37	8LK3011-5AA36	8LK3011-8AA38
	800 mm	8LK3011-5AA32	8LK3011-5AA23	8LK3011-5AA35	8LK3011-5AA37	8LK3011-5AA36	8LK3011-8AA38
	1100 mm	8LK3011-5AA33	8LK3011-5AA23	8LK3011-5AA35	8LK3011-5AA37	8LK3011-5AA36	8LK3011-8AA38



④ Cable brackets C40 × 22.5 mm	⑤ Inner door	Inner door struts
8LK3001-6AA60	–	–
8LK3001-6AA61	8LK3011-6AA37	2 × 8LK2000-0AD16
8LK3001-6AA62	8LK3011-6AA38	2 × 8LK2000-0AD16
8LK3011-6AA40	–	–
8LK3001-6AA60	–	–
8LK3001-6AA61	8LK3011-6AA37	2 × 8LK2000-0AD16
8LK3001-6AA62	8LK3011-6AA38	2 × 8LK2000-0AD16
8LK3011-6AA40	–	–

Section expansion

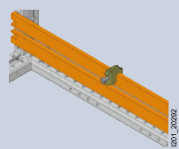
Assembly kit for power supply company transformer measurement



Height	Width	① Transparent section covers	② Mounting plates	③ Copper connection	
				30 × 10 mm	40 × 10 mm
450 mm	250 mm	8LK5002-1AA57	8LK5002-1AA55	8LK6035-3AA82	8LK6035-3AA83
	500 mm	8LK5002-1AA58	8LK5002-1AA56	8LK6035-3AA82	8LK6035-3AA83

Accessories

Circular conductors



Busbar thickness	Ø Cable	Scope of supply	Article No.
5 mm	1.5 ... 16 mm ²	100 units	8US1921-2AA00
	1.5 ... 35 mm ²	50 units	8US1921-2AB00
	16 ... 70 mm ²	50 units	8US1921-2AC00
	16 ... 120 mm ²	50 units	8US1921-2AD00
10 mm	1.5 ... 16 mm ²	100 units	8US1921-2BA00
	1.5 ... 35 mm ²	50 units	8US1921-2BB00
	16 ... 70 mm ²	50 units	8US1921-2BC00
	16 ... 120 mm ²	50 units	8US1921-2BD00

Roll material



Application	Version	Scope of supply	Article No.
Sealing tape – base	Width 30 mm, height 0.05 mm	1 roll = 228 m	8LK1000-0AA78
Sealing foil – base of frame	Width 19 mm	1 roll = 50 m	8LK2000-0AJ71
Sealing tape – cable entry at top	Width 10 mm, height 4 mm	1 roll = 20 m	8LK2000-0AJ72
Circuit breaker insulation	Width 35 mm	1 roll = 15 m	8LK6036-2AA14

Cubicle keys



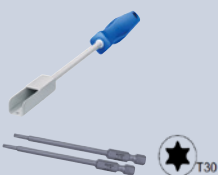
Version	Scope of supply	Article No.
3 mm double bit	10 units	8PQ9400-0BA12

Self-tapping screws – Frame



Type	Version	Scope of supply	Article No.
Cylinder-head screws	M6 x 10 mm	100 units	8PQ9500-0BA34
	M6 x 16 mm	100 units	8PQ9500-0BA32
	M6 x 20 mm	100 units	8PQ9500-0BA31
Countersunk screws	M6 x 12 mm	100 units	8PQ9500-1BA07

Mounting accessories



	Scope of supply	Article No.
ALPHA 8GK assembly tool for supports	1 unit	8GK9910-0KK27
Screwdriver insert, length 200 mm	2 units	8PQ9400-0BA10

Cable brackets C40 × 22.5 mm

Type	Width	Scope of supply	Article No.
Direct installation	350 mm	1 unit	8LK3006-6AA46
	400 mm	1 unit	8LK3001-6AA60
	600 mm	1 unit	8LK3001-6AA61
	800 mm	1 unit	8LK3001-6AA62
	850 mm	1 unit	8LK3006-6AA45
	1100 mm	1 unit	8LK3011-6AA40
With bracket	350 mm	1 unit	8LK3011-8AA42
	400 mm	1 unit	8LK3011-8AA43
	600 mm	1 unit	8LK3011-8AA44
	800 mm	1 unit	8LK3011-8AA45
	850 mm	1 unit	8LK3011-8AA46
	1100 mm	1 unit	8LK3011-8AA47

Transport aids

Type	Width	Scope of supply	Article No.
Lifting brackets	350 mm	1 set = 2 units	8LK9400-4AA14
	400 mm	1 set = 2 units	8LK9400-4AA15
	600 mm	1 set = 2 units	8LK9400-4AA16
	800 mm	1 set = 2 units	8LK9400-4AA17
	850 mm	1 set = 2 units	8LK9400-4AA18
	1100 mm	1 set = 2 units	8LK9400-4AA21
Lifting eyes	–	1 set = 4 units	8LK9400-3AA74
Base reinforcements	350 mm	1 set = 2 units	8LK1000-0AA43
	400 mm	1 set = 2 units	8LK1000-0AA11
	600 mm	1 set = 2 units	8LK1000-0AA12
	800 mm	1 set = 2 units	8LK1000-0AA13
	850 mm	1 set = 2 units	8LK1000-0AA42
	1100 mm	1 set = 2 units	8LK1011-0AA04

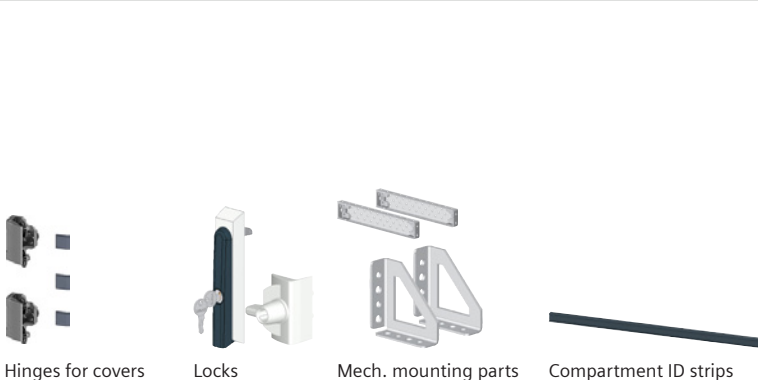
System overview

SIVACON S4 power distribution boards

Frame and enclosure



Accessories for frame and enclosure



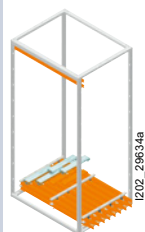
Hinges for covers

Locks

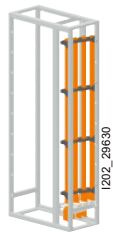
Mech. mounting parts

Compartment ID strips

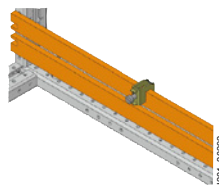
Busbar systems



Main busbars



Vertical distribution busbars



PE bars



N and PE elevations

Section expansion: Main busbar at top/at bottom



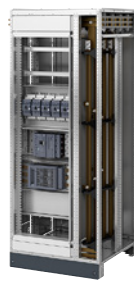
3WA incoming feeder panels



3WA coupling panels



3VA molded case circuit breaker design



3VA outgoing feeder panels
3NP1 modular installation devices



3NJ4 outgoing feeder panels



3NJ6 outgoing feeder panels



Cable section



Corner sections



Mounting plates

Section expansion: Main busbar at rear



3WA
incoming feeder panels



3VA
outgoing feeder panels
3NP1 modular
installation devices



3WA
coupling panels

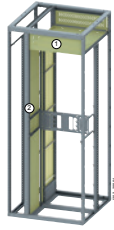


Mounting plates

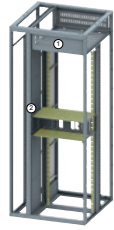
Internal separation



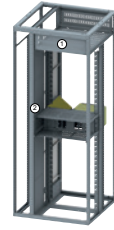
Form 1
No internal separation



Form 2
Separation
+ busbar systems



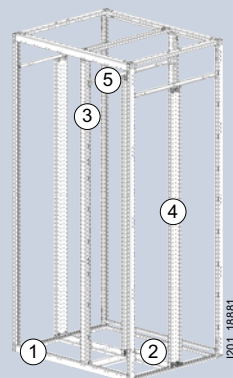
Form 3
Separation
+ busbar systems
+ device compartments



Form 4
Separation
+ busbar systems
+ device compartments
+ connections

Frame

For main busbar at top, at bottom and without



Position of main busbar

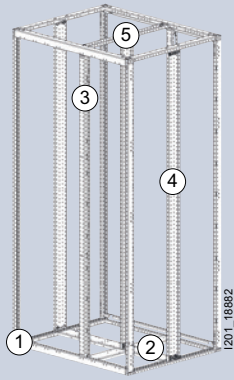
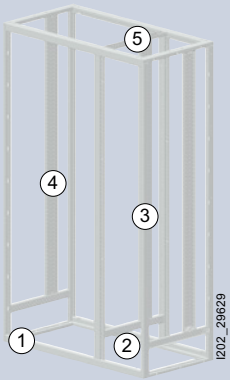
At top

At bottom

Without



Width	Depth	① Frame	② Floor plate partition crossbar	③ Exterior intermediate upright	④ Interior side upright	⑤ Section division
400 mm	400 mm	8PQ1204-4BA01	–	–	8PQ3000-0BA65	–
	600 mm	8PQ1204-6BA01	–	–	8PQ3000-0BA01	–
	800 mm	8PQ1204-8BA01	–	–	8PQ3000-0BA02	–
600 mm	400 mm	8PQ1206-4BA01	–	–	8PQ3000-0BA65	–
	600 mm	8PQ1206-6BA01	–	–	8PQ3000-0BA01	–
	800 mm	8PQ1206-8BA01	–	–	8PQ3000-0BA02	–
800 mm	400 mm	8PQ1208-4BA01	8PQ3000-1BA38	8PQ3000-1BA43	8PQ3000-0BA65	8PQ3000-1BA31
	600 mm	8PQ1208-6BA01	8PQ3000-1BA40	8PQ3000-1BA43	8PQ3000-0BA01	8PQ3000-1BA32
	800 mm	8PQ1208-8BA01	2 × 8PQ3000-1BA38	8PQ3000-1BA43	8PQ3000-0BA02	8PQ3000-1BA34
1000 mm	400 mm	8PQ1201-4BA02	8PQ3000-1BA38	8PQ3000-1BA43	8PQ3000-0BA65	8PQ3000-1BA31
	600 mm	8PQ1201-6BA02	8PQ3000-1BA40	8PQ3000-1BA43	8PQ3000-0BA01	8PQ3000-1BA32
	800 mm	8PQ1201-8BA03	2 × 8PQ3000-1BA38	8PQ3000-1BA43	8PQ3000-0BA02	8PQ3000-1BA34
1200 mm	400 mm	8PQ1202-4BA02	8PQ3000-1BA38	8PQ3000-1BA43	8PQ3000-0BA65	8PQ3000-1BA31
	600 mm	8PQ1202-6BA02	8PQ3000-1BA40	8PQ3000-1BA43	8PQ3000-0BA01	8PQ3000-1BA32
	800 mm	8PQ1202-8BA02	2 × 8PQ3000-1BA38	8PQ3000-1BA43	8PQ3000-0BA02	8PQ3000-1BA34



4 Interior side upright

5 Section division

4 Interior side upright

5 Section division

8PQ3000-0BA10	–	–	–
8PQ3000-3BA10	–	8PQ3000-0BA03	–
8PQ3000-3BA11	–	8PQ3000-0BA03	–
8PQ3000-0BA10	–	–	–
8PQ3000-3BA10	–	8PQ3000-0BA03	–
8PQ3000-3BA11	–	8PQ3000-0BA03	–
8PQ3000-0BA10	8PQ3000-0BA10	–	–
8PQ3000-3BA10	8PQ3000-3BA47	8PQ3000-0BA03	8PQ3000-1BA36
8PQ3000-3BA11	8PQ3000-3BA48	8PQ3000-0BA03	8PQ3000-1BA37
8PQ3000-0BA10	8PQ3000-0BA10	–	–
8PQ3000-3BA10	8PQ3000-3BA47	8PQ3000-0BA03	8PQ3000-1BA36
8PQ3000-3BA11	8PQ3000-3BA48	8PQ3000-0BA03	8PQ3000-1BA37
8PQ3000-0BA10	8PQ3000-0BA10	–	–
8PQ3000-3BA10	8PQ3000-3BA47	8PQ3000-0BA03	8PQ3000-1BA36
8PQ3000-3BA11	8PQ3000-3BA48	8PQ3000-0BA03	8PQ3000-1BA37

Frame

For main busbar at rear

Position of main busbar **At rear**



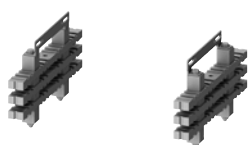
Width	Depth	Main busbar system	① Frame		② Floor plate partition crossbar	
			Front	Rear	Depth 400 mm	Depth 600 mm
600 mm	800 mm		8PQ1206-8BA01	–	–	–
	1000 mm		8PQ1206-4BA01	+ 8PQ1206-6BA01	–	–
	1200 mm	Single	8PQ1206-4BA01	+ 8PQ1206-8BA01	–	–
		Duplex	8PQ1206-4BA01	+ 8PQ1206-8BA01	–	–
800 mm	800 mm		8PQ1208-8BA01	–	8PQ3000-1BA38	–
	1000 mm		8PQ1208-4BA01	+ 8PQ1208-6BA01	8PQ3000-1BA38	8PQ3000-1BA40
	1200 mm	Single	8PQ1208-4BA01	+ 8PQ1208-8BA01	3 × 8PQ3000-1BA38	–
		Duplex	8PQ1208-4BA01	+ 8PQ1208-8BA01	3 × 8PQ3000-1BA38	–
1000 mm	800 mm		8PQ1201-8BA03	–	8PQ3000-1BA38	–
	1000 mm		8PQ1201-4BA02	+ 8PQ1201-6BA02	8PQ3000-1BA38	8PQ3000-1BA40
	1200 mm	Single	8PQ1201-4BA02	+ 8PQ1201-8BA03	3 × 8PQ3000-1BA38	–
		Duplex	8PQ1201-4BA02	+ 8PQ1201-8BA03	3 × 8PQ3000-1BA38	–

15



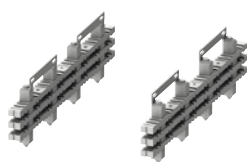
Main busbar systems

Single

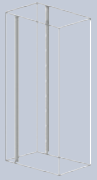
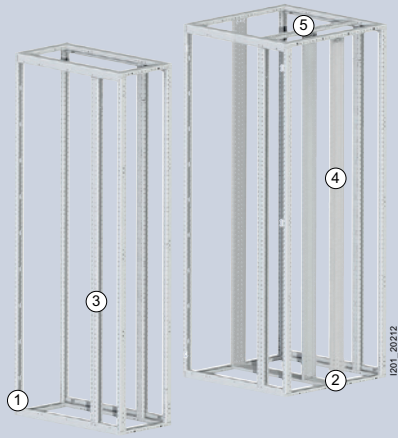


$I_n = 3200 \text{ A}$

Duplex



$I_n = 6300 \text{ A}$



⊕ Exterior intermediate upright

⊕ Interior side upright

⊕ Section division

–	8PQ3000-0BA03	–
–	8PQ3000-0BA03	–
–	8PQ3000-0BA03	–
–	8PQ3000-0BA03	–
8PQ3000-1BA43	8PQ3000-0BA03	8PQ3000-1BA37
8PQ3000-1BA43	8PQ3000-0BA03	8PQ3000-1BA36
8PQ3000-1BA43	8PQ3000-0BA03	8PQ3000-1BA37
8PQ3000-1BA43	8PQ3000-0BA03	8PQ3000-1BA37
8PQ3000-1BA43	8PQ3000-0BA03	8PQ3000-1BA37
8PQ3000-1BA43	8PQ3000-0BA03	8PQ3000-1BA36
8PQ3000-1BA43	8PQ3000-0BA03	8PQ3000-1BA37
8PQ3000-1BA43	8PQ3000-0BA03	8PQ3000-1BA37

Frame

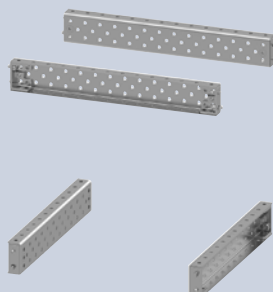
Accessories

Frame reinforcement



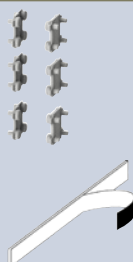
Use	Scope of supply	Article No.
Recommended from width 1000 mm	4 units	8PQ9400-0BA35

Crossbars



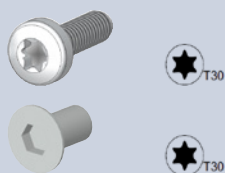
Version	Width	Crossbar length	Scope of supply	Article No.
-	400 mm	350 mm	2 units	8PQ3000-0BA12
	600 mm	550 mm	2 units	8PQ3000-0BA71
	800 mm	750 mm	2 units	8PQ3000-0BA72
	1000 mm	950 mm	2 units	8PQ3000-0BA84
	1200 mm	1150 mm	2 units	8PQ3000-0BA85
Without uprights	400 mm	300 mm	2 units	8PQ3000-0BA10
	600 mm	500 mm	2 units	8PQ3000-1BA24
	800 mm	700 mm	2 units	8PQ3000-1BA25
With uprights	600 mm	300 mm	2 units	8PQ3000-0BA10
	800 mm	300 mm	2 units	8PQ3000-0BA10

Forming rows of frames



Version	Scope of supply	Article No.
Frame connection	6 units	8PQ1204-4BA05
Set of IP55 seals	5.5 m	8PQ1204-4BA04

Self-tapping screws



Type	Version	Scope of supply	Article No.
Cylinder-head screws	M6 × 10 mm	100 units	8PQ9500-0BA34
	M6 × 16 mm	100 units	8PQ9500-0BA32
	M6 × 20 mm	100 units	8PQ9500-0BA31
Countersunk screws	M6 × 12 mm	100 units	8PQ9500-1BA07

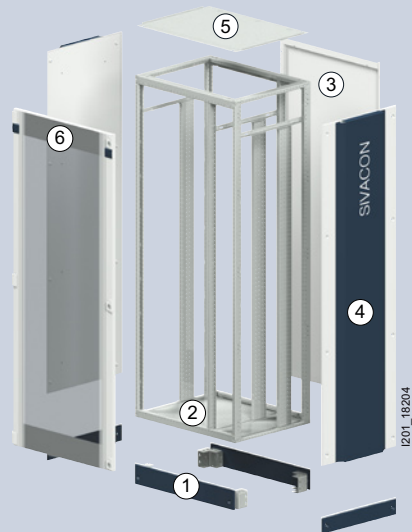
Lifting eyebolts (Transport aids)



Version	Scope of supply	Article No.
M12	4 units	8PQ9400-0BA11

Enclosure

Paneling sections, main busbar at top/at bottom



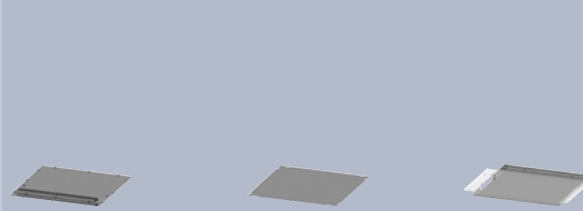
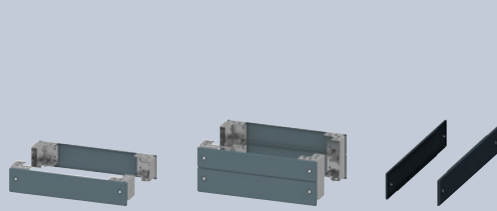
Position of main busbar

At top

At bottom

① Bases

② Floor plates



Width	Depth	Height			IP40 cable entry	IP55	IP20
		100 mm	200 mm	100 mm			
200 mm	400 mm	–	–	–	–	8PQ2302-4BA04	–
	600 mm	–	–	–	–	8PQ2302-6BA04	–
	800 mm	–	–	–	–	2 × 8PQ2302-4BA04	–
400 mm	400 mm	8PQ1014-0BA01	8PQ1024-0BA01	8PQ1010-4BA01	8PQ2304-4BA06	8PQ2304-4BA05	8PQ2304-4BA14
	600 mm	8PQ1014-0BA01	8PQ1024-0BA01	8PQ1010-6BA01	8PQ2306-4BA06	8PQ2306-4BA05	8PQ2304-6BA11
	800 mm	8PQ1014-0BA01	8PQ1024-0BA01	8PQ1010-8BA01	2 × 8PQ2304-4BA06	2 × 8PQ2304-4BA05	8PQ2304-8BA05
600 mm	400 mm	8PQ1016-0BA01	8PQ1026-0BA01	8PQ1010-4BA01	8PQ2306-4BA06	8PQ2306-4BA05	8PQ2306-4BA10
	600 mm	8PQ1016-0BA01	8PQ1026-0BA01	8PQ1010-6BA01	8PQ2306-6BA06	8PQ2306-6BA05	8PQ2306-6BA16
	800 mm	8PQ1016-0BA01	8PQ1026-0BA01	8PQ1010-8BA01	2 × 8PQ2306-4BA06	2 × 8PQ2306-4BA05	8PQ2306-8BA05
800 mm	400 mm	8PQ1018-0BA01	8PQ1028-0BA01	8PQ1010-4BA01	8PQ2308-4BA06	8PQ2308-4BA05	8PQ2308-4BA13
	600 mm	8PQ1018-0BA01	8PQ1028-0BA01	8PQ1010-6BA01	8PQ2308-6BA06	8PQ2308-6BA05	8PQ2308-6BA13
	800 mm	8PQ1018-0BA01	8PQ1028-0BA01	8PQ1010-8BA01	2 × 8PQ2308-4BA06	2 × 8PQ2308-4BA05	8PQ2308-8BA10
1000 mm	400 mm	8PQ1011-0BA01	8PQ1021-0BA01	8PQ1010-4BA01	–	8PQ2301-4BA04	8PQ2301-4BA06
	600 mm	8PQ1011-0BA01	8PQ1021-0BA01	8PQ1010-6BA01	–	–	8PQ2301-6BA05
	800 mm	8PQ1011-0BA01	8PQ1021-0BA01	8PQ1010-8BA01	–	2 × 8PQ2301-4BA04	8PQ2301-8BA04
1200 mm	400 mm	8PQ1012-0BA01	8PQ1022-0BA01	8PQ1010-4BA01	–	–	8PQ2302-4BA05
	600 mm	8PQ1012-0BA01	8PQ1022-0BA01	8PQ1010-6BA01	–	–	8PQ2302-6BA05
	800 mm	8PQ1012-0BA01	8PQ1022-0BA01	8PQ1010-8BA01	–	–	8PQ2302-8BA04

Rear panels		Side panels		Roof plates			
							
IP40	IP55	IP55	IP55 with design strip	IP40	IP40 cable entry	IPX1 upgrade	IP55
-	-	-	-	-	-	-	-
-	-	-	-	-	-	-	-
-	-	-	-	-	-	-	-
8PQ2420-4BA02	8PQ2420-4BA01	8PQ2520-4BA02	8PQ2520-4BA01	8PQ2304-4BA02	8PQ2304-4BA03	8PQ2304-4BA04	8PQ2304-4BA01
8PQ2420-4BA02	8PQ2420-4BA01	8PQ2520-6BA02	8PQ2520-6BA01	8PQ2304-6BA02	8PQ2304-6BA03	8PQ2304-6BA04	8PQ2304-6BA01
8PQ2420-4BA02	8PQ2420-4BA01	8PQ2520-8BA02	8PQ2520-8BA01	8PQ2304-8BA02	8PQ2304-8BA03	8PQ2304-8BA04	8PQ2304-8BA01
8PQ2420-6BA02	8PQ2420-6BA01	8PQ2520-4BA02	8PQ2520-4BA01	8PQ2306-4BA02	8PQ2306-4BA03	8PQ2306-4BA04	8PQ2306-4BA01
8PQ2420-6BA02	8PQ2420-6BA01	8PQ2520-6BA02	8PQ2520-6BA01	8PQ2306-6BA02	8PQ2306-6BA03	8PQ2306-6BA04	8PQ2306-6BA01
8PQ2420-6BA02	8PQ2420-6BA01	8PQ2520-8BA02	8PQ2520-8BA01	8PQ2306-8BA02	8PQ2306-8BA03	8PQ2306-8BA04	8PQ2306-8BA01
8PQ2420-8BA02	8PQ2420-8BA01	8PQ2520-4BA02	8PQ2520-4BA01	8PQ2308-4BA02	8PQ2308-4BA03	8PQ2308-4BA04	8PQ2308-4BA01
8PQ2420-8BA02	8PQ2420-8BA01	8PQ2520-6BA02	8PQ2520-6BA01	8PQ2308-6BA02	8PQ2308-6BA03	8PQ2308-6BA04	8PQ2308-6BA01
8PQ2420-8BA02	8PQ2420-8BA01	8PQ2520-8BA02	8PQ2520-8BA01	8PQ2308-8BA02	8PQ2308-8BA03	8PQ2308-8BA04	8PQ2308-8BA01
8PQ2420-1BA02	8PQ2420-1BA01	8PQ2520-4BA02	8PQ2520-4BA01	8PQ2301-4BA02	-	8PQ2301-4BA03	8PQ2301-4BA01
8PQ2420-1BA02	8PQ2420-1BA01	8PQ2520-6BA02	8PQ2520-6BA01	8PQ2301-6BA02	-	8PQ2301-6BA03	8PQ2301-6BA01
8PQ2420-1BA02	8PQ2420-1BA01	8PQ2520-8BA02	8PQ2520-8BA01	8PQ2301-8BA02	-	8PQ2301-8BA03	8PQ2301-8BA01
8PQ2420-2BA02	8PQ2420-2BA01	8PQ2520-4BA02	8PQ2520-4BA01	8PQ2302-4BA02	-	8PQ2302-4BA03	8PQ2302-4BA01
8PQ2420-2BA02	8PQ2420-2BA01	8PQ2520-6BA02	8PQ2520-6BA01	8PQ2302-6BA02	-	8PQ2302-6BA03	8PQ2302-6BA01
8PQ2420-2BA02	8PQ2420-2BA01	8PQ2520-8BA02	8PQ2520-8BA01	8PQ2302-8BA02	-	8PQ2302-8BA03	8PQ2302-8BA01

Enclosure

Paneling sections, main busbar at top/at bottom

Accessories

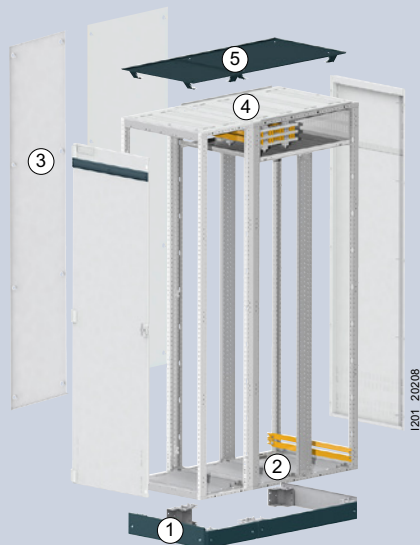
Reinforcements for transport



Height	Width/depth	Article No.
100 mm	400 mm	8PQ1014-0BA02
	600 mm	8PQ1016-0BA02
	800 mm	8PQ1018-0BA02
	1000 mm	8PQ1011-1BA01
	1200 mm	8PQ1012-2BA01

Enclosure

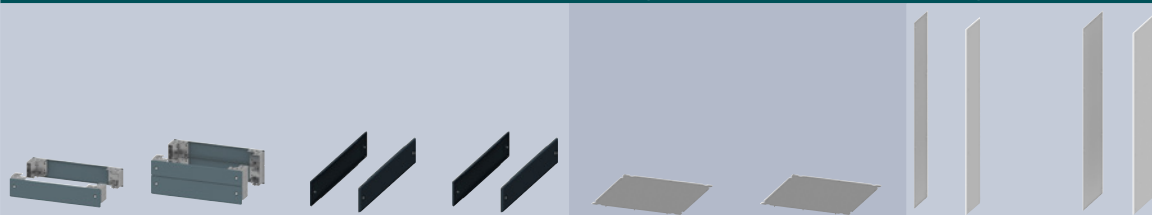
Paneling sections, main busbar at rear



1 Bases

2 Floor plates

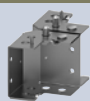
3 Side panels



Width	Depth	Height		Height		IP55	IP55	IP55	IP55
		100 mm	200 mm	100 mm	200 mm				
400 mm	800 mm	8PQ1014-0BA01	8PQ1024-0BA01	8PQ1010-8BA01	–	2 × 8PQ2304-4BA05	–	8PQ2520-8BA02	–
	1000 mm	8PQ1014-0BA01	8PQ1024-0BA01	8PQ1010-4BA01	8PQ1010-6BA01	8PQ2304-4BA05 +	8PQ2306-4BA05	8PQ2520-4BA02 +	8PQ2520-6BA02
	1200 mm	8PQ1014-0BA01	8PQ1024-0BA01	8PQ1010-4BA01	8PQ1010-8BA01	3 × 8PQ2304-4BA05	–	8PQ2520-4BA02 +	8PQ2520-8BA02
600 mm	800 mm	8PQ1016-0BA01	8PQ1026-0BA01	8PQ1010-8BA01	–	2 × 8PQ2306-4BA05	–	8PQ2520-8BA02	–
	1000 mm	8PQ1016-0BA01	8PQ1026-0BA01	8PQ1010-4BA01	8PQ1010-6BA01	8PQ2306-4BA05 +	8PQ2306-6BA05	8PQ2520-4BA02 +	8PQ2520-6BA02
	1200 mm	8PQ1016-0BA01	8PQ1026-0BA01	8PQ1010-4BA01	8PQ1010-8BA01	3 × 8PQ2306-4BA05	–	8PQ2520-4BA02 +	8PQ2520-8BA02
800 mm	800 mm	8PQ1018-0BA01	8PQ1028-0BA01	8PQ1010-8BA01	–	2 × 8PQ2308-4BA05	–	8PQ2520-8BA02	–
	1000 mm	8PQ1018-0BA01	8PQ1028-0BA01	8PQ1010-4BA01	8PQ1010-6BA01	8PQ2308-4BA05 +	8PQ2308-6BA05	8PQ2520-4BA02 +	8PQ2520-6BA02
	1200 mm	8PQ1018-0BA01	8PQ1028-0BA01	8PQ1010-4BA01	8PQ1010-8BA01	3 × 8PQ2308-4BA05	–	8PQ2520-4BA02 +	8PQ2520-8BA02
1000 mm	800 mm	8PQ1011-0BA01	8PQ1021-0BA01	8PQ1010-8BA01	–	2 × 8PQ2301-4BA04	–	8PQ2520-8BA02	–
	1000 mm	8PQ1011-0BA01	8PQ1021-0BA01	8PQ1010-4BA01	8PQ1010-6BA01	8PQ2301-4BA04 +	8PQ2301-6BA06	8PQ2520-4BA02 +	8PQ2520-6BA02
	1200 mm	8PQ1011-0BA01	8PQ1021-0BA01	8PQ1010-4BA01	8PQ1010-8BA01	3 × 8PQ2301-4BA04	–	8PQ2520-4BA02 +	8PQ2520-8BA02
1200 mm	800 mm	8PQ1012-0BA01	8PQ1022-0BA01	8PQ1010-8BA01	–	4 × 8PQ2306-4BA05	–	8PQ2520-8BA02	–
	1000 mm	8PQ1012-0BA01	8PQ1022-0BA01	8PQ1010-4BA01	8PQ1010-6BA01	2 × 8PQ2306-4BA05	2 × 8PQ2306-6BA05	8PQ2520-4BA02 +	8PQ2520-6BA02
	1200 mm	8PQ1012-0BA01	8PQ1022-0BA01	8PQ1010-4BA01	8PQ1010-8BA01	6 × 8PQ2306-4BA05	–	8PQ2520-4BA02 +	8PQ2520-8BA02

Accessories

Base corner pieces for depths of 1000 mm and 1200 mm



Height

100 mm

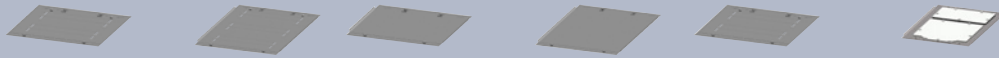
200 mm

Article No.

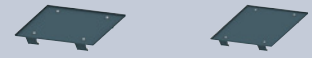
8PQ1010-1BA01

8PQ1020-1BA01

Roof plates



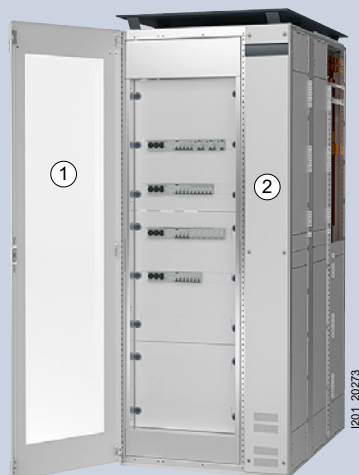
Roof add-on-plates



IP40		IP40		IP55		IP55		IP40 cable entry		IP40 cable entry		IPX1		IPX1	
8PQ2304-8BA02	–			8PQ2304-8BA01	–			–	8PQ2304-8BA08	8PQ2304-8BA04	–				
8PQ2304-4BA02	+	8PQ2304-6BA02		8PQ2304-4BA01	+	8PQ2304-6BA01		8PQ2304-4BA02	+	8PQ2304-6BA13		8PQ2304-4BA15	+	8PQ2304-6BA12	
8PQ2304-4BA02	+	8PQ2304-8BA02		8PQ2304-4BA01	+	8PQ2304-8BA01		8PQ2304-8BA08	+	8PQ2304-4BA16		8PQ2304-4BA15	+	8PQ2304-8BA07	
8PQ2306-8BA02	–			8PQ2306-8BA01	–			–	8PQ2306-8BA08	8PQ2306-8BA04	–				
8PQ2306-4BA02	+	8PQ2306-6BA02		8PQ2306-4BA01	+	8PQ2306-6BA01		8PQ2306-4BA02	+	8PQ2306-6BA18		8PQ2306-4BA11	+	8PQ2306-6BA17	
8PQ2306-4BA02	+	8PQ2306-8BA02		8PQ2306-4BA01	+	8PQ2306-8BA01		8PQ2306-4BA12	+	8PQ2306-8BA08		8PQ2306-4BA11	+	8PQ2306-8BA07	
8PQ2308-8BA02	–			8PQ2308-8BA01	–			–	8PQ2308-8BA13	8PQ2308-8BA04	–				
8PQ2308-4BA02	+	8PQ2308-6BA02		8PQ2308-4BA01	+	8PQ2308-6BA01		8PQ2308-4BA02	+	8PQ2308-6BA15		8PQ2308-4BA14	+	8PQ2308-6BA14	
8PQ2308-4BA02	+	8PQ2308-8BA02		8PQ2308-4BA01	+	8PQ2308-8BA01		8PQ2308-4BA15	+	8PQ2308-8BA13		8PQ2308-4BA14	+	8PQ2308-8BA12	
8PQ2301-8BA02	–			8PQ2301-8BA01	–			–	8PQ2301-8BA07	8PQ2301-8BA03	–				
8PQ2301-4BA02	+	8PQ2301-6BA02		8PQ2301-4BA01	+	8PQ2301-6BA01		8PQ2301-4BA02	+	8PQ2301-6BA08		8PQ2301-4BA07	+	8PQ2301-6BA07	
8PQ2301-4BA02	+	8PQ2301-8BA02		8PQ2301-4BA01	+	8PQ2301-8BA01		8PQ2301-4BA08	+	8PQ2301-8BA07		8PQ2301-4BA07	+	8PQ2301-8BA06	
8PQ2302-8BA02	–			8PQ2302-8BA01	–			–	8PQ2302-8BA07	8PQ2302-8BA03	–				
8PQ2302-4BA02	+	8PQ2302-6BA02		8PQ2302-4BA01	+	8PQ2302-6BA01		8PQ2302-4BA02	+	8PQ2302-6BA07		8PQ2302-4BA06	+	8PQ2302-6BA06	
8PQ2302-4BA02	+	8PQ2302-8BA02		8PQ2302-4BA01	+	8PQ2302-8BA01		8PQ2302-4BA07	+	8PQ2302-8BA07		8PQ2302-4BA06	+	8PQ2302-8BA06	

Enclosure

Paneling sections



1 Doors With double-bit lock

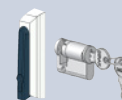
For profile semicylinder



Hinge	Width	IP40	IP55	IP55 glass doors	IP40	IP55	IP55 glass doors
Left	200 mm	–	–	–	–	–	–
	400 mm	8PQ2197-4BA08	8PQ2197-4BA05	–	8PQ2197-4BA06	8PQ2197-4BA03	–
	600 mm	8PQ2197-6BA06	8PQ2197-6BA03	8PQ2197-6BA10	8PQ2197-6BA04	8PQ2197-6BA01	8PQ2197-6BA07
	800 mm	8PQ2197-8BA06	8PQ2197-8BA03	8PQ2197-8BA10	8PQ2197-8BA04	8PQ2197-8BA01	8PQ2197-8BA07
	1000 mm	8PQ2197-1BA06	8PQ2197-1BA03	8PQ2197-1BA10	8PQ2197-1BA07	8PQ2197-1BA04	8PQ2197-1BA11
Right	200 mm	–	–	–	–	–	–
	400 mm	8PQ2197-4BA11	8PQ2197-4BA10	–	8PQ2197-4BA07	8PQ2197-4BA04	–
	600 mm	8PQ2197-6BA13	8PQ2197-6BA12	8PQ2197-6BA14	8PQ2197-6BA05	8PQ2197-6BA02	8PQ2197-6BA08
	800 mm	8PQ2197-8BA13	8PQ2197-8BA12	8PQ2197-8BA14	8PQ2197-8BA05	8PQ2197-8BA02	8PQ2197-8BA08
	1000 mm	8PQ2197-1BA18	8PQ2197-1BA17	8PQ2197-1BA20	8PQ2197-1BA08	8PQ2197-1BA05	8PQ2197-1BA12

15

Lock systems



Double-bit lock

Flat cylinder

Profile semicylinder

Rotary handles	8PQ9400-0BA08	8PQ9400-0BA07	8PQ9400-0BA41 + 8PQ9400-0BA26
Coupling bars	8PQ9400-0BA27	8PQ9400-0BA27	8PQ9400-0BA28
Locking rods	8PQ9400-0BA37	8PQ9400-0BA37	8PQ9400-0BA38
Bar guides	8PQ9400-0BA36	8PQ9400-0BA36	8PQ9400-0BA36

Frame paneling		Outer cover	
IP30	IP40	IP55	
–	8PQ2197-2BA15	8PQ2197-2BA14	
–	8PQ2197-4BA02	8PQ2197-4BA01	
8PQ2197-6BA11	–	–	
8PQ2197-8BA11	–	–	
–	–	–	
–	8PQ2197-2BA15	8PQ2197-2BA14	
–	8PQ2197-4BA02	8PQ2197-4BA01	
8PQ2197-6BA11	–	–	
8PQ2197-8BA11	–	–	
–	–	–	



Door cutouts

Double-bit lock



Flat cylinder







Profile semicylinder



Enclosure

Paneling sections

Accessories

Cubicle keys			
	Version	Scope of supply	Article No.
	3 mm double bit	10 units	8PQ9400-0BA12
Inner door struts			
	Version		Article No.
	Section-high		8PQ2197-0BA10
Cubicle ID plate			
	Version		Article No.
	SIVACON designed by Siemens		8PQ9400-0BA06
Door hinges			
	Version	Scope of supply	Article No.
	Hinges	2 units	8PQ9400-0BA55

Enclosure

Internal covers

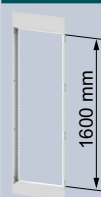


Position of main busbar

At top

Without

1 Cover frames






Width	Fixed	Swivel	Fixed	Swivel
600 mm	8PQ2000-6BA03	8PQ2000-6BA02	8PQ2000-6BA04	8PQ2000-6BA01
800 mm	8PQ2000-8BA03	8PQ2000-8BA02	8PQ2000-8BA04	8PQ2000-8BA01

2 Covers



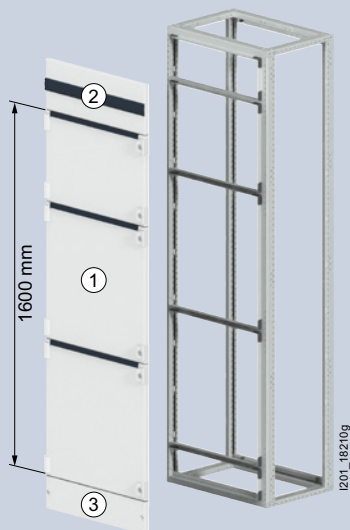
Height	Width 600 mm	Width 800 mm
50 mm	8PQ2005-6BA01	8PQ2005-8BA01
100 mm	8PQ2010-6BA01	8PQ2010-8BA01
150 mm	8PQ2015-6BA02	8PQ2015-8BA02
200 mm	8PQ2020-6BA01	8PQ2020-8BA01
250 mm	8PQ2025-6BA01	8PQ2025-8BA01
300 mm	8PQ2030-6BA01	8PQ2030-8BA01
350 mm	8PQ2035-6BA01	8PQ2035-8BA01
400 mm	8PQ2040-6BA01	8PQ2040-8BA01
500 mm	8PQ2050-6BA01	8PQ2050-8BA01
550 mm	8PQ2055-6BA01	8PQ2055-8BA01
600 mm	8PQ2060-6BA01	8PQ2060-8BA01
650 mm	8PQ2065-6BA01	8PQ2065-8BA01
700 mm	8PQ2070-6BA12	8PQ2070-8BA03
800 mm	8PQ2080-6BA01	8PQ2080-8BA01

Accessories

Covers, ventilated			
	Height	Width	Article No.
	100 mm	600 mm	8PQ2010-6BA02
		800 mm	8PQ2010-8BA02
Quick-release lock			
	Version	Scope of supply	Article No.
	SIVACON – Blue green basic	20 units	8PQ9400-0BA54
Hinges for masking frames			
	Version	Scope of supply	Article No.
	<ul style="list-style-type: none"> Hinges, incl. fixing accessories From a masking frame height of 150 mm 	1 set	8PQ2000-0BA08

Enclosure

Compartment doors





① Device compartments

		Compartment doors		Covers	
Width	Height	IP40	IP55 upgrade	IP40	IP55 upgrade
400 mm	50 mm	–	–	8PQ2005-4BA03	8PQ2005-4BA01
	100 mm	–	–	8PQ2010-4BA02	8PQ2010-4BA01
	150 mm	8PQ2015-4BA04	8PQ2015-4BA05	–	–
	200 mm	8PQ2020-4BA01	8PQ2020-4BA03	–	–
	250 mm	8PQ2025-4BA01	8PQ2025-4BA02	–	–
	300 mm	8PQ2030-4BA01	8PQ2030-4BA02	–	–
	350 mm	8PQ2035-4BA01	8PQ2035-4BA02	–	–
	400 mm	8PQ2040-4BA01	8PQ2040-4BA03	–	–
	450 mm	8PQ2045-4BA01	8PQ2045-4BA02	–	–
	500 mm	8PQ2050-4BA01	8PQ2050-4BA02	–	–
	550 mm	8PQ2055-4BA11	8PQ2055-4BA07	–	–
	600 mm	8PQ2060-4BA01	8PQ2060-4BA03	–	–
	650 mm	8PQ2065-4BA01	8PQ2065-4BA02	–	–
	700 mm	8PQ2070-4BA07	8PQ2070-4BA08	–	–
	750 mm	8PQ2072-4BA01	8PQ2075-4BA01	–	–
	800 mm	8PQ2080-4BA01	8PQ2080-4BA04	–	–
600 mm	50 mm	–	–	8PQ2005-6BA04	8PQ2005-6BA03
	100 mm	–	–	8PQ2010-6BA04	8PQ2010-6BA03
	150 mm	8PQ2015-6BA10	8PQ2015-6BA12	–	–
	200 mm	8PQ2020-6BA14	8PQ2020-6BA15	–	–
	250 mm	8PQ2025-6BA07	8PQ2025-6BA08	–	–
	300 mm	8PQ2030-6BA10	8PQ2030-6BA12	–	–
	350 mm	8PQ2035-6BA12	8PQ2035-6BA13	–	–
	400 mm	8PQ2040-6BA12	8PQ2040-6BA13	–	–
	450 mm	8PQ2045-6BA05	8PQ2045-6BA06	–	–
	500 mm	8PQ2050-6BA03	8PQ2050-6BA04	–	–
	550 mm	8PQ2055-6BA04	8PQ2055-6BA06	–	–
	600 mm	8PQ2060-6BA06	8PQ2060-6BA07	–	–
	650 mm	8PQ2065-6BA03	8PQ2065-6BA04	–	–
	700 mm	8PQ2070-6BA03	8PQ2070-6BA04	–	–
	750 mm	8PQ2075-6BA01	8PQ2075-6BA02	–	–
	800 mm	8PQ2080-6BA03	8PQ2080-6BA04	–	–
800 mm	50 mm	–	–	8PQ2005-8BA04	8PQ2005-8BA03
	100 mm	–	–	8PQ2010-8BA04	8PQ2010-8BA03
	150 mm	8PQ2015-8BA05	8PQ2015-8BA07	–	–
	200 mm	8PQ2020-8BA07	8PQ2020-8BA08	–	–
	250 mm	8PQ2025-8BA04	8PQ2025-8BA05	–	–
	300 mm	8PQ2030-8BA05	8PQ2030-8BA06	–	–
	350 mm	8PQ2035-8BA06	8PQ2035-8BA07	–	–
	400 mm	8PQ2040-8BA12	8PQ2040-8BA13	–	–
	450 mm	8PQ2045-8BA03	8PQ2045-8BA04	–	–
	500 mm	8PQ2050-8BA03	8PQ2050-8BA04	–	–
	550 mm	8PQ2055-8BA03	8PQ2055-8BA06	–	–
	600 mm	8PQ2060-8BA04	8PQ2060-8BA05	–	–
	650 mm	8PQ2065-8BA03	8PQ2065-8BA04	–	–
	700 mm	8PQ2070-8BA01	8PQ2070-8BA02	–	–
	750 mm	8PQ2075-8BA01	8PQ2075-8BA02	–	–
	800 mm	8PQ2080-8BA03	8PQ2080-8BA04	–	–

② Head compartments

		Covers	Doors
			
Width	Height	IP40	IP55 upgrade
Main busbar at top			
400 mm	225 mm	8PQ2022-4BA01	8PQ2022-4BA03
600 mm	225 mm	8PQ2022-6BA01	8PQ2022-6BA02
800 mm	225 mm	8PQ2022-8BA01	8PQ2022-8BA02
Main busbar at bottom			
400 mm	175 mm	8PQ2000-4BA02	8PQ2022-4BA03
600 mm	175 mm	8PQ2000-6BA08	8PQ2022-6BA02
800 mm	175 mm	8PQ2000-8BA08	8PQ2022-8BA02

③ Base compartments

		Covers	Doors
			
Width	Height	IP4X	IP55 upgrade
Main busbar at top			
400 mm	150 mm	8PQ2015-4BA01	8PQ2015-4BA03
600 mm	150 mm	8PQ2000-6BA07	8PQ2015-6BA13
800 mm	150 mm	8PQ2000-8BA07	8PQ2015-8BA08
Main busbar at bottom			
400 mm	200 mm	8PQ2020-4BA04	8PQ2020-4BA05
600 mm	200 mm	8PQ2020-6BA34	8PQ2020-6BA35
800 mm	200 mm	8PQ2020-8BA17	8PQ2020-8BA18

Enclosure

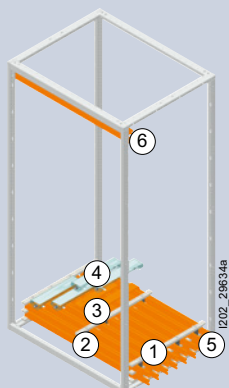
Compartment doors

Accessories

Door hinges			
	Version	Scope of supply	Article No.
	Light gray	2 units	8PQ9400-0BA55
Locks			
	Version		Article No.
	Two-way interlocking mechanisms		8PQ9400-0BA40
Handles for compartment doors			
	Version		Article No.
	Without lock		8PQ9400-0BA73
	With flat cylinder, identical key type		8PQ9400-0BA72
Compartment ID strip for plug-in plates, H = 17 mm			
	Width	Scope of supply	Article No.
	400 mm	6 units	8PQ5000-3BA42
	600 mm	6 units	8PQ5000-3BA43
	800 mm	6 units	8PQ5000-3BA46
Inner door struts			
	Height		Article No.
	400 mm		8PQ2040-0BA06
	550 mm		8PQ2055-0BA05
	600 mm		8PQ2060-0BA14
	700 mm		8PQ2070-0BA02
	800 mm		8PQ2080-0BA07
Cubicle keys			
	Version	Scope of supply	Article No.
	3 mm double bit	10 units	8PQ9400-0BA12

Busbar systems

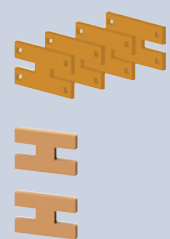
Main busbars



	1 Busbar supports		2 Reinforcement		3 Equipotential bonding	4 Covers	PEN grounding	Arcing fault barriers
							1 set = 10 units	
Position	Single $I_n = 3200 \text{ A}$	Duplex $I_n = 6300 \text{ A}$	Single $I_n = 3200 \text{ A}$	Duplex $I_n = 6300 \text{ A}$	Duplex $I_n = 6300 \text{ A}$			
Top	8PQ4000-0BA04	8PQ4000-0BA60	8PQ4000-0BA37	2 × 8PQ4000-0BA37	8PQ4000-0BA62	–	8PQ4000-0BA12	8PQ9400-0BA21
Bottom	8PQ4000-0BA04	8PQ4000-0BA60	8PQ4000-0BA37	2 × 8PQ4000-0BA37	8PQ4000-0BA62	4 × 8PQ4000-1BA25	8PQ4000-0BA12	8PQ9400-0BA21
Rear	8PQ4000-0BA04 + 8PQ3000-0BA10	8PQ4000-0BA60 + 2 × 8PQ3000-0BA10	8PQ4000-0BA37	2 × 8PQ4000-0BA37	–	–	8PQ4000-2BA24	8PQ9400-0BA21

Accessories

Connecting lugs



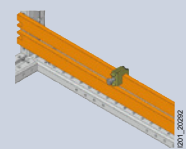
Type	Cross-section	Article No.
⑤ Main busbars	20 × 10 mm	8PQ4000-0BA53
	30 × 10 mm	8PQ4000-0BA54
	40 × 10 mm	8PQ4000-0BA56
	50 × 10 mm	8PQ4000-0BA57
⑥ PE bar	20 × 5 mm	8PQ4000-0BA52
	30 × 5 mm	
	30 × 10 mm	
	40 × 5 mm	8PQ4000-0BA67
	40 × 10 mm	
50 × 10 mm		

Protective cover



Type	Article No.
<ul style="list-style-type: none"> Main busbar at rear Mounting width 200 mm 	8PQ4000-3BA35

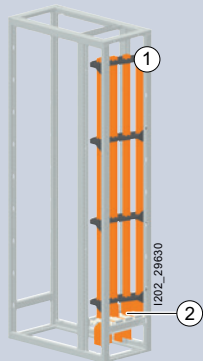
Circular conductors



Busbar thickness	Ø Cable	Scope of supply	Article No.
5 mm	1.5 ... 16 mm ²	100 units	8US1921-2AA00
	1.5 ... 35 mm ²	50 units	8US1921-2AB00
	16 ... 70 mm ²	50 units	8US1921-2AC00
	16 ... 120 mm ²	50 units	8US1921-2AD00
10 mm	1.5 ... 16 mm ²	100 units	8US1921-2BA00
	1.5 ... 35 mm ²	50 units	8US1921-2BB00
	16 ... 70 mm ²	50 units	8US1921-2BC00
	16 ... 120 mm ²	50 units	8US1921-2BD00

Busbar systems

Vertical distribution busbars, cascaded, up to $I_{CW} = 65 \text{ kA}$



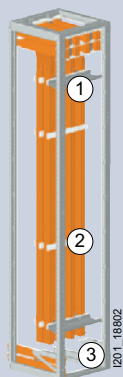
	① Busbar supports	② Supports	
Position of main busbar	30 × 10 mm	40 × 10 mm	
Top	8PQ4000-0BA32	8PQ4000-0BA63	–
Bottom	8PQ4000-0BA32	8PQ4000-0BA63	8PQ4000-1BA23

Accessories

Connection				
	Component	Version	Scope of supply	Article No.
	Busbar clamps	M10	20 units	8PQ9400-0BA02
	Saucer-head bolts	M10 × 35 mm	50 units	8PQ9500-0BA14
		M10 × 45 mm	50 units	8PQ9500-0BA16
		M10 × 55 mm	50 units	8PQ9500-1BA36
		M10 × 65 mm	50 units	8PQ9500-1BA25
	Spring washers	For M10	50 units	8PQ9500-0BA60
	Hexagonal nuts	M10	50 units	8PQ9500-0BA05

Connecting lugs						
	Cross-section	Position of vertical distribution busbar	Position of main busbar	Depth	Article No.	
	30 × 10 mm	Right	Front	400 mm	8PQ4000-0BA45	
				600 mm	8PQ4000-0BA46	
				800 mm	8PQ4000-0BA46	
		Left	Rear	800 mm	8PQ4000-0BA50	
				Front	400 mm	8PQ4000-0BA73
					600 mm	8PQ4000-0BA72
	40 × 10 mm	Right	Front	400 mm	8PQ4000-0BA47	
				600 mm	8PQ4000-0BA48	
				800 mm	8PQ4000-0BA48	
		Left	Rear	800 mm	8PQ4000-0BA51	
				Front	400 mm	8PQ4000-0BA75
					600 mm	8PQ4000-0BA48
		Rear	800 mm	8PQ4000-0BA48		
			800 mm	8PQ4000-0BA71		

Vertical distribution busbars, non-cascaded, up to $I_{cw} = 100$ kA



Position of main busbar	Width	1 Busbar supports	2 Reinforcement	3 Supports
At top	200 mm	8PQ4000-2BA25	8PQ4000-0BA37	8PQ4000-0BA78
	400 mm	8PQ4000-2BA26	8PQ4000-0BA37	8PQ4000-0BA61
At bottom	200 mm	8PQ4000-2BA25	8PQ4000-0BA37	–
	400 mm	8PQ4000-2BA26	8PQ4000-0BA37	–
At rear	200 mm	8PQ4000-2BA25	8PQ4000-0BA37	8PQ4000-0BA78

Accessories

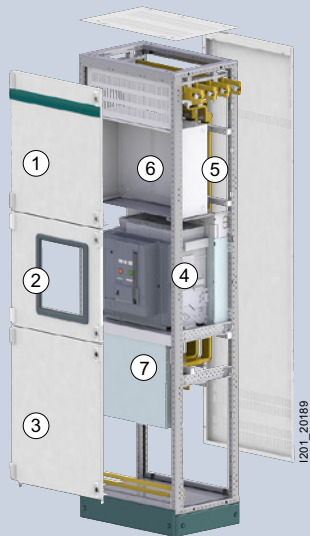
Connecting lugs



Cross-section	Position of main busbar	Depth	Article No.
20 × 10 mm 30 × 10 mm	At front	400 mm	8PQ4000-0BA38
		600 mm	8PQ4000-0BA40
		800 mm	8PQ4000-0BA40
	At rear	800 mm	8PQ4000-0BA43
40 × 10 mm 50 × 10 mm	At front	400 mm	8PQ4000-0BA41
		600 mm	8PQ4000-0BA42
		800 mm	8PQ4000-0BA42
	At rear	800 mm	8PQ4000-0BA44

Section expansion

3WA air circuit breakers, main busbar at top





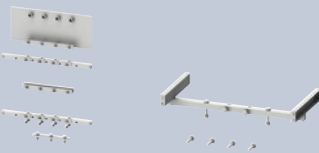
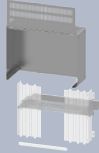
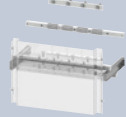

3 and 4-pole

① Head compartment doors

② Compartment doors



Type of mounting	Size	Width	Depth	IP40	IP55 upgrade	IP40	IP55	IP55 upgrade
Fixed-mounted	1	600 mm	400 mm	8PQ2067-6BA01	8PQ2067-6BA02	8PQ2055-6BA16	8PQ2055-6BA17	8PQ2055-6BA06
			600 mm	8PQ2067-6BA01	8PQ2067-6BA02	8PQ2055-6BA16	8PQ2055-6BA17	8PQ2055-6BA06
			800 mm	8PQ2067-6BA01	8PQ2067-6BA02	8PQ2055-6BA16	8PQ2055-6BA17	8PQ2055-6BA06
	2	800 mm	600 mm	8PQ2067-8BA01	8PQ2067-8BA02	8PQ2055-8BA08	8PQ2055-8BA10	8PQ2055-8BA06
			800 mm	8PQ2067-8BA01	8PQ2067-8BA02	8PQ2055-8BA08	8PQ2055-8BA10	8PQ2055-8BA06
			800 mm	8PQ2067-8BA01	8PQ2067-8BA02	8PQ2055-8BA08	8PQ2055-8BA10	8PQ2055-8BA06
3	1000 mm	800 mm	8PQ2067-1BA01	8PQ2067-1BA02	8PQ2055-1BA03	8PQ2055-1BA04	8PQ2055-1BA06	
Withdrawable	1	600 mm	400 mm	8PQ2067-6BA01	8PQ2067-6BA02	8PQ2055-6BA16	8PQ2055-6BA17	8PQ2055-6BA06
			600 mm	8PQ2067-6BA01	8PQ2067-6BA02	8PQ2055-6BA16	8PQ2055-6BA17	8PQ2055-6BA06
			800 mm	8PQ2067-6BA01	8PQ2067-6BA02	8PQ2055-6BA16	8PQ2055-6BA17	8PQ2055-6BA06
	2	800 mm	600 mm	8PQ2067-8BA01	8PQ2067-8BA02	8PQ2055-8BA08	8PQ2055-8BA10	8PQ2055-8BA06
			800 mm	8PQ2067-8BA01	8PQ2067-8BA02	8PQ2055-8BA08	8PQ2055-8BA10	8PQ2055-8BA06
			800 mm	8PQ2067-8BA01	8PQ2067-8BA02	8PQ2055-8BA08	8PQ2055-8BA10	8PQ2055-8BA06
	3	1000 mm	800 mm	8PQ2067-1BA01	8PQ2067-1BA02	8PQ2055-1BA03	8PQ2055-1BA04	8PQ2055-1BA06

③ Base compartment doors		④ Mounting plates		⑤ Main busbar connection		⑥ Separation 4b	⑦ Cable connection	Insulation
								
IP40	IP55 upgrade	Front		Rear				
8PQ2075-6BA01	8PQ2075-6BA03	8PQ6000-5BA26	8PQ6000-6BA75	–	8PQ5000-4BA28	8PQ6000-5BA81	–	
8PQ2075-6BA01	8PQ2075-6BA03	8PQ6000-5BA26	8PQ6000-6BA75	–	8PQ5000-4BA30	8PQ6000-5BA81	–	
8PQ2075-6BA01	8PQ2075-6BA03	8PQ6000-5BA26	8PQ6000-6BA75	8PQ6001-1BA00	8PQ5000-4BA31	8PQ6000-5BA81	–	
8PQ2075-8BA01	8PQ2075-8BA03	8PQ6000-5BA24	8PQ6000-6BA76	–	8PQ5000-4BA32	8PQ6000-5BA83	–	
8PQ2075-8BA01	8PQ2075-8BA03	8PQ6000-5BA24	8PQ6000-6BA76	8PQ6001-1BA01	8PQ5000-4BA33	8PQ6000-5BA83	–	
8PQ2075-1BA01	8PQ2075-1BA02	8PQ6000-5BA23	8PQ6000-5BA33	–	8PQ5000-5BA11	8PQ6000-5BA84	–	
8PQ2075-6BA01	8PQ2075-6BA03	8PQ6000-5BA26	8PQ6000-6BA75	–	8PQ5000-4BA28	8PQ6000-5BA82	8PQ6000-7BA28	
8PQ2075-6BA01	8PQ2075-6BA03	8PQ6000-5BA26	8PQ6000-6BA75	–	8PQ5000-4BA30	8PQ6000-5BA82	8PQ6000-7BA28	
8PQ2075-6BA01	8PQ2075-6BA03	8PQ6000-5BA26	8PQ6000-6BA75	8PQ6001-1BA00	8PQ5000-4BA31	8PQ6000-5BA82	8PQ6000-7BA28	
8PQ2075-8BA01	8PQ2075-8BA03	8PQ6000-5BA24	8PQ6000-6BA76	–	8PQ5000-4BA32	8PQ6000-5BA83	–	
8PQ2075-8BA01	8PQ2075-8BA03	8PQ6000-5BA24	8PQ6000-6BA76	8PQ6001-1BA01	8PQ5000-4BA33	8PQ6000-5BA83	–	
8PQ2075-1BA01	8PQ2075-1BA02	8PQ6000-5BA23	8PQ6000-5BA33	–	8PQ5000-5BA11	8PQ6000-5BA84	–	

Accessories

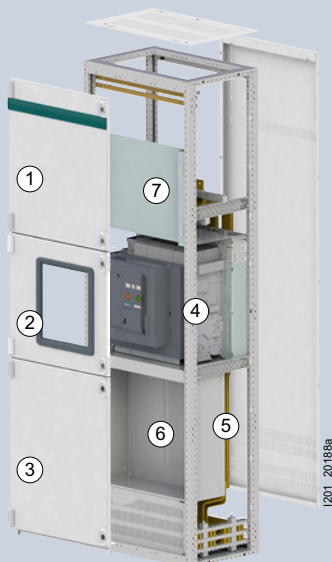
Compartment ID strip for plug-in plates, H = 17 mm



Width	Scope of supply	Article No.
600 mm	6 units	8PQ5000-3BA43
800 mm	6 units	8PQ5000-3BA46
1000 mm	6 units	8PQ5000-3BA47

Section expansion

3WA air circuit breakers, main busbar at bottom





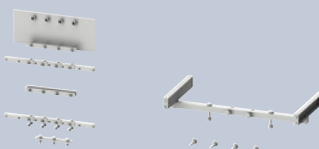
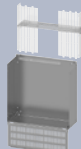
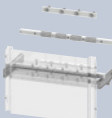

3 and 4-pole

① Head compartment doors

② Compartment doors



Type of mounting	Size	Width	Depth	① Head compartment doors		② Compartment doors		
				IP40	IP55 upgrade	IP40	IP55	IP55 upgrade
Fixed-mounted	1	600 mm	400 mm	8PQ2067-6BA01	8PQ2067-6BA02	8PQ2055-6BA16	8PQ2055-6BA17	8PQ2055-6BA06
			600 mm	8PQ2067-6BA01	8PQ2067-6BA02	8PQ2055-6BA16	8PQ2055-6BA17	8PQ2055-6BA06
			800 mm	8PQ2067-6BA01	8PQ2067-6BA02	8PQ2055-6BA16	8PQ2055-6BA17	8PQ2055-6BA06
	2	800 mm	600 mm	8PQ2067-8BA01	8PQ2067-8BA02	8PQ2055-8BA08	8PQ2055-8BA10	8PQ2055-8BA06
			800 mm	8PQ2067-8BA01	8PQ2067-8BA02	8PQ2055-8BA08	8PQ2055-8BA10	8PQ2055-8BA06
			800 mm	8PQ2067-8BA01	8PQ2067-8BA02	8PQ2055-8BA08	8PQ2055-8BA10	8PQ2055-8BA06
Withdrawable	1	600 mm	400 mm	8PQ2067-6BA01	8PQ2067-6BA02	8PQ2055-6BA16	8PQ2055-6BA17	8PQ2055-6BA06
			600 mm	8PQ2067-6BA01	8PQ2067-6BA02	8PQ2055-6BA16	8PQ2055-6BA17	8PQ2055-6BA06
			800 mm	8PQ2067-6BA01	8PQ2067-6BA02	8PQ2055-6BA16	8PQ2055-6BA17	8PQ2055-6BA06
	2	800 mm	600 mm	8PQ2067-8BA01	8PQ2067-8BA02	8PQ2055-8BA08	8PQ2055-8BA10	8PQ2055-8BA06
			800 mm	8PQ2067-8BA01	8PQ2067-8BA02	8PQ2055-8BA08	8PQ2055-8BA10	8PQ2055-8BA06
			800 mm	8PQ2067-8BA01	8PQ2067-8BA02	8PQ2055-8BA08	8PQ2055-8BA10	8PQ2055-8BA06

③ Base compartment doors		④ Mounting plates		⑤ Main busbar connection		⑥ Separation 4b	⑦ Cable connection	Insulation
								
IP40	IP55 upgrade	Front		Rear				
8PQ2075-6BA01	8PQ2075-6BA03	8PQ6000-5BA26	8PQ6000-6BA75	–	8PQ5000-4BA34	8PQ6000-5BA81	–	
8PQ2075-6BA01	8PQ2075-6BA03	8PQ6000-5BA26	8PQ6000-6BA75	–	8PQ5000-4BA35	8PQ6000-5BA81	–	
8PQ2075-6BA01	8PQ2075-6BA03	8PQ6000-5BA26	8PQ6000-6BA75	8PQ6001-1BA00	8PQ5000-4BA36	8PQ6000-5BA81	–	
8PQ2075-8BA01	8PQ2075-8BA03	8PQ6000-5BA24	8PQ6000-6BA76	–	8PQ5000-4BA37	8PQ6000-5BA83	–	
8PQ2075-8BA01	8PQ2075-8BA03	8PQ6000-5BA24	8PQ6000-6BA76	8PQ6001-1BA01	8PQ5000-4BA38	8PQ6000-5BA83	–	
8PQ2075-6BA01	8PQ2075-6BA03	8PQ6000-5BA26	8PQ6000-6BA75	–	8PQ5000-4BA34	8PQ6000-5BA82	8PQ6000-7BA28	
8PQ2075-6BA01	8PQ2075-6BA03	8PQ6000-5BA26	8PQ6000-6BA75	–	8PQ5000-4BA35	8PQ6000-5BA82	8PQ6000-7BA28	
8PQ2075-6BA01	8PQ2075-6BA03	8PQ6000-5BA26	8PQ6000-6BA75	8PQ6001-1BA00	8PQ5000-4BA36	8PQ6000-5BA82	8PQ6000-7BA28	
8PQ2075-8BA01	8PQ2075-8BA03	8PQ6000-5BA24	8PQ6000-6BA76	–	8PQ5000-4BA37	8PQ6000-5BA83	–	
8PQ2075-8BA01	8PQ2075-8BA03	8PQ6000-5BA24	8PQ6000-6BA76	8PQ6001-1BA01	8PQ5000-4BA38	8PQ6000-5BA83	–	

Accessories

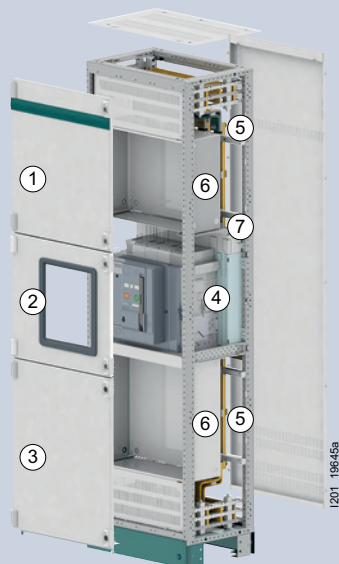
Compartment ID strip for plug-in plates, H = 17 mm



Width	Scope of supply	Article No.
600 mm	6 units	8PQ5000-3BA43
800 mm	6 units	8PQ5000-3BA46

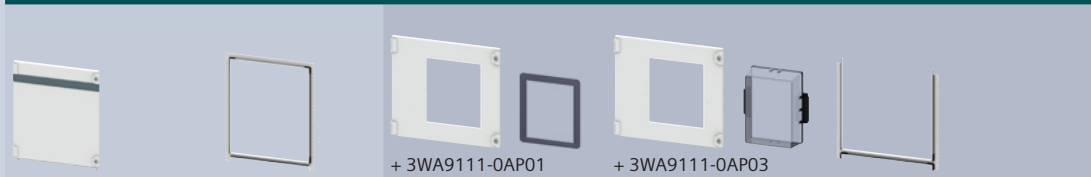
Section expansion

3WA air circuit breakers, coupling



1 Head compartment doors

2 Compartment doors



Type of mounting	Size	Width	Depth	IP40	IP55 upgrade	IP4X	IP55	IP55 upgrade
Fixed-mounted	1	600 mm	400 mm	8PQ2067-6BA01	8PQ2067-6BA02	8PQ2055-6BA16	8PQ2055-6BA17	8PQ2055-6BA06
			600 mm	8PQ2067-6BA01	8PQ2067-6BA02	8PQ2055-6BA16	8PQ2055-6BA17	8PQ2055-6BA06
			800 mm	8PQ2067-6BA01	8PQ2067-6BA02	8PQ2055-6BA16	8PQ2055-6BA17	8PQ2055-6BA06
	2	800 mm	600 mm	8PQ2067-8BA01	8PQ2067-8BA02	8PQ2055-8BA08	8PQ2055-8BA10	8PQ2055-8BA06
			800 mm	8PQ2067-8BA01	8PQ2067-8BA02	8PQ2055-8BA08	8PQ2055-8BA10	8PQ2055-8BA06
			800 mm	8PQ2067-8BA01	8PQ2067-8BA02	8PQ2055-8BA08	8PQ2055-8BA10	8PQ2055-8BA06
Withdrawable	1	600 mm	400 mm	8PQ2067-6BA01	8PQ2067-6BA02	8PQ2055-6BA16	8PQ2055-6BA17	8PQ2055-6BA06
			600 mm	8PQ2067-6BA01	8PQ2067-6BA02	8PQ2055-6BA16	8PQ2055-6BA17	8PQ2055-6BA06
			800 mm	8PQ2067-6BA01	8PQ2067-6BA02	8PQ2055-6BA16	8PQ2055-6BA17	8PQ2055-6BA06
	2	800 mm	600 mm	8PQ2067-8BA01	8PQ2067-8BA02	8PQ2055-8BA08	8PQ2055-8BA10	8PQ2055-8BA06
			800 mm	8PQ2067-8BA01	8PQ2067-8BA02	8PQ2055-8BA08	8PQ2055-8BA10	8PQ2055-8BA06
			800 mm	8PQ2067-8BA01	8PQ2067-8BA02	8PQ2055-8BA08	8PQ2055-8BA10	8PQ2055-8BA06

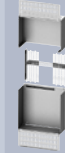
④ Base compartment doors

⑤ Mounting plates

⑥ Main busbar connection

⑧ Separation 4b

⑦ Uprights



IP40		IP55 upgrade				
8PQ2075-6BA01	8PQ2075-6BA03	8PQ6000-5BA26	2 × 8PQ6000-6BA75	8PQ5000-5BA12	–	
8PQ2075-6BA01	8PQ2075-6BA03	8PQ6000-5BA26	2 × 8PQ6000-6BA75	8PQ5000-5BA13	2 × 8PQ3000-3BA50	
8PQ2075-6BA01	8PQ2075-6BA03	8PQ6000-5BA26	2 × 8PQ6000-6BA75	8PQ5000-5BA14	2 × 8PQ3000-3BA51	
8PQ2075-8BA01	8PQ2075-8BA03	8PQ6000-5BA24	2 × 8PQ6000-6BA76	8PQ5000-5BA15	2 × 8PQ3000-3BA50	
8PQ2075-8BA01	8PQ2075-8BA03	8PQ6000-5BA24	2 × 8PQ6000-6BA76	8PQ5000-5BA16	2 × 8PQ3000-3BA51	
8PQ2075-6BA01	8PQ2075-6BA03	8PQ6000-5BA26	2 × 8PQ6000-6BA75	8PQ5000-5BA12	–	
8PQ2075-6BA01	8PQ2075-6BA03	8PQ6000-5BA26	2 × 8PQ6000-6BA75	8PQ5000-5BA13	2 × 8PQ3000-3BA50	
8PQ2075-6BA01	8PQ2075-6BA03	8PQ6000-5BA26	2 × 8PQ6000-6BA75	8PQ5000-5BA14	2 × 8PQ3000-3BA51	
8PQ2075-8BA01	8PQ2075-8BA03	8PQ6000-5BA24	2 × 8PQ6000-6BA76	8PQ5000-5BA15	2 × 8PQ3000-3BA50	
8PQ2075-8BA01	8PQ2075-8BA03	8PQ6000-5BA24	2 × 8PQ6000-6BA76	8PQ5000-5BA16	2 × 8PQ3000-3BA51	

Accessories

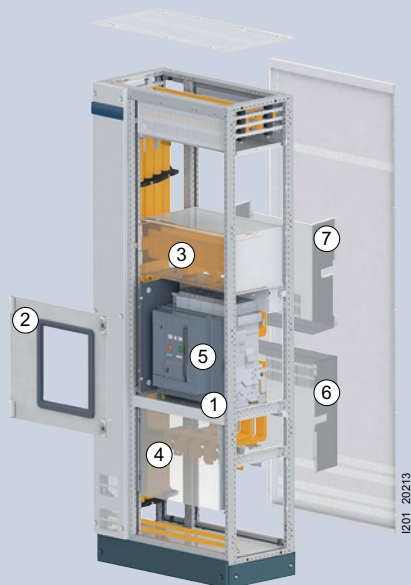
Compartment ID strip for plug-in plates, H = 17 mm



Width	Scope of supply	Article No.
600 mm	6 units	8PQ5000-3BA43
800 mm	6 units	8PQ5000-3BA46

Section expansion

3WA air circuit breakers, connection of section busbar systems



Compartment doors

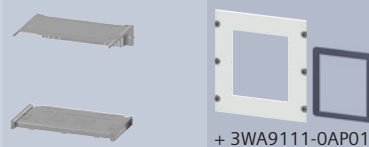
① Mounting plates ② Compartment doors



Type of mounting	Size	Width	Number of poles	I_n		IP40	IP55	IP55 upgrade
Fixed-mounted	1	400 mm	3-pole	1600 A	8PQ6000-5BA25	8PQ2055-4BA12	–	–
				2000 A	8PQ6000-5BA25	8PQ2055-4BA12	–	–
	600 mm	4-pole	1600 A	8PQ6000-5BA26	8PQ2055-6BA16	8PQ2055-6BA17	+ 8PQ2055-6BA06	
			2000 A	8PQ6000-5BA26	8PQ2055-6BA16	8PQ2055-6BA17	+ 8PQ2055-6BA06	
Withdrawable	1	400 mm	3-pole	1600 A	8PQ6000-5BA25	8PQ2055-4BA12	–	–
				2000 A	8PQ6000-5BA25	8PQ2055-4BA12	–	–
	600 mm	4-pole	1600 A	8PQ6000-5BA26	8PQ2055-6BA16	8PQ2055-6BA17	+ 8PQ2055-6BA06	
			2000 A	8PQ6000-5BA26	8PQ2055-6BA16	8PQ2055-6BA17	+ 8PQ2055-6BA06	

Covers

① Mounting plates ② Covers



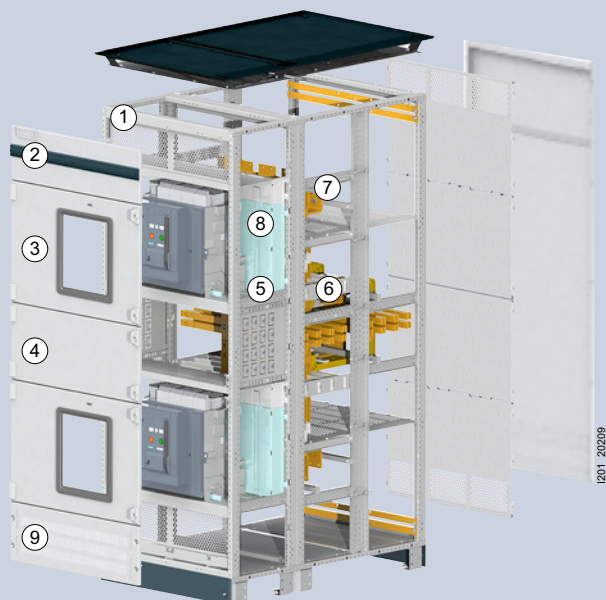
Type of mounting	Size	Width	Number of poles	I_n		IP40
Fixed-mounted	1	600 mm	3-pole	1600 A	8PQ6000-3BA31	8PQ2055-6BA05
				2000 A	8PQ6000-3BA31	8PQ2055-6BA05
	4-pole	1600 A	8PQ6000-3BA31	8PQ2055-6BA07		
		2000 A	8PQ6000-3BA31	8PQ2055-6BA07		
	800 mm	3/4-pole	1600 A	8PQ6000-3BA32	8PQ2055-8BA04	
			2000 A	8PQ6000-3BA32	8PQ2055-8BA04	
Withdrawable	1	600 mm	3-pole	1600 A	8PQ6000-3BA31	8PQ2055-6BA05
				2000 A	8PQ6000-3BA31	8PQ2055-6BA05
	4-pole	1600 A	8PQ6000-3BA31	8PQ2055-6BA07		
		2000 A	8PQ6000-3BA31	8PQ2055-6BA07		
	800 mm	3/4-pole	1600 A	8PQ6000-3BA32	8PQ2055-8BA04	
			2000 A	8PQ6000-3BA32	8PQ2055-8BA04	

③ Section busbars		④ Cable connection		⑤ Device compartment		⑥ Cable connection		⑦ Section busbars	
				Separation 3b		Separation 4b		Separation 4b	
8PQ6000-5BA48	8PQ6000-5BA78	8PQ5000-3BA82	8PQ5000-3BA84	8PQ5000-3BA82	8PQ5000-3BA84	8PQ5000-3BA84	8PQ5000-3BA84	8PQ5000-3BA84	8PQ5000-3BA84
8PQ6000-7BA05	8PQ6000-5BA78	8PQ5000-3BA82	8PQ5000-4BA00	8PQ5000-3BA82	8PQ5000-4BA00	8PQ5000-3BA85	8PQ5000-3BA85	8PQ5000-3BA85	8PQ5000-3BA85
8PQ6000-5BA51	8PQ6000-5BA81	8PQ5000-3BA82	8PQ5000-3BA86	8PQ5000-3BA82	8PQ5000-3BA86	8PQ5000-3BA86	8PQ5000-3BA86	8PQ5000-3BA86	8PQ5000-3BA86
8PQ6000-7BA07	8PQ6000-5BA81	8PQ5000-3BA82	8PQ5000-4BA01	8PQ5000-3BA82	8PQ5000-4BA01	8PQ5000-3BA87	8PQ5000-3BA87	8PQ5000-3BA87	8PQ5000-3BA87
8PQ6000-5BA50	8PQ6000-5BA80	8PQ5000-3BA82	8PQ5000-3BA84	8PQ5000-3BA82	8PQ5000-3BA84	8PQ5000-3BA84	8PQ5000-3BA84	8PQ5000-3BA84	8PQ5000-3BA84
8PQ6000-7BA06	8PQ6000-5BA80	8PQ5000-3BA82	8PQ5000-4BA00	8PQ5000-3BA82	8PQ5000-4BA00	8PQ5000-3BA85	8PQ5000-3BA85	8PQ5000-3BA85	8PQ5000-3BA85
8PQ6000-5BA52	8PQ6000-5BA82	8PQ5000-3BA82	8PQ5000-3BA86	8PQ5000-3BA82	8PQ5000-3BA86	8PQ5000-3BA86	8PQ5000-3BA86	8PQ5000-3BA86	8PQ5000-3BA86
8PQ6000-7BA08	8PQ6000-5BA82	8PQ5000-3BA82	8PQ5000-4BA01	8PQ5000-3BA82	8PQ5000-4BA01	8PQ5000-3BA87	8PQ5000-3BA87	8PQ5000-3BA87	8PQ5000-3BA87

③ Section busbars		④ Cable connection		⑤ Device compartment		⑥ Cable connection		⑦ Section busbars	
				Separation 3b		Separation 4b		Separation 4b	
8PQ6000-5BA45	8PQ6000-5BA75	8PQ5000-0BA08	8PQ5000-0BA30	8PQ5000-0BA08	8PQ5000-0BA30	8PQ5000-0BA14	8PQ5000-0BA14	8PQ5000-0BA14	8PQ5000-0BA14
8PQ6000-7BA03	8PQ6000-5BA75	8PQ5000-0BA08	8PQ5000-0BA30	8PQ5000-0BA08	8PQ5000-0BA30	8PQ5000-0BA14	8PQ5000-0BA14	8PQ5000-0BA14	8PQ5000-0BA14
8PQ6000-5BA45	8PQ6000-5BA75	8PQ5000-0BA08	8PQ5000-0BA30	8PQ5000-0BA08	8PQ5000-0BA30	8PQ5000-0BA14	8PQ5000-0BA14	8PQ5000-0BA14	8PQ5000-0BA14
8PQ6000-7BA03	8PQ6000-5BA75	8PQ5000-0BA08	8PQ5000-0BA30	8PQ5000-0BA08	8PQ5000-0BA30	8PQ5000-0BA14	8PQ5000-0BA14	8PQ5000-0BA14	8PQ5000-0BA14
8PQ6000-5BA46	8PQ6000-5BA76	8PQ5000-1BA65	8PQ5000-1BA68	8PQ5000-1BA65	8PQ5000-1BA68	8PQ5000-1BA67	8PQ5000-1BA67	8PQ5000-1BA67	8PQ5000-1BA67
8PQ6000-7BA04	8PQ6000-5BA76	8PQ5000-1BA65	8PQ5000-1BA68	8PQ5000-1BA65	8PQ5000-1BA68	8PQ5000-1BA67	8PQ5000-1BA67	8PQ5000-1BA67	8PQ5000-1BA67
8PQ6000-5BA45	8PQ6000-5BA75	8PQ5000-0BA07	8PQ5000-0BA30	8PQ5000-0BA07	8PQ5000-0BA30	8PQ5000-0BA14	8PQ5000-0BA14	8PQ5000-0BA14	8PQ5000-0BA14
8PQ6000-7BA03	8PQ6000-5BA75	8PQ5000-0BA07	8PQ5000-0BA30	8PQ5000-0BA07	8PQ5000-0BA30	8PQ5000-0BA14	8PQ5000-0BA14	8PQ5000-0BA14	8PQ5000-0BA14
8PQ6000-5BA45	8PQ6000-5BA75	8PQ5000-0BA07	8PQ5000-0BA30	8PQ5000-0BA07	8PQ5000-0BA30	8PQ5000-0BA14	8PQ5000-0BA14	8PQ5000-0BA14	8PQ5000-0BA14
8PQ6000-7BA03	8PQ6000-5BA75	8PQ5000-0BA07	8PQ5000-0BA30	8PQ5000-0BA07	8PQ5000-0BA30	8PQ5000-0BA14	8PQ5000-0BA14	8PQ5000-0BA14	8PQ5000-0BA14
8PQ6000-5BA46	8PQ6000-5BA76	8PQ5000-1BA66	8PQ5000-1BA68	8PQ5000-1BA66	8PQ5000-1BA68	8PQ5000-1BA67	8PQ5000-1BA67	8PQ5000-1BA67	8PQ5000-1BA67
8PQ6000-7BA04	8PQ6000-5BA76	8PQ5000-1BA66	8PQ5000-1BA68	8PQ5000-1BA66	8PQ5000-1BA68	8PQ5000-1BA67	8PQ5000-1BA67	8PQ5000-1BA67	8PQ5000-1BA67

Section expansion

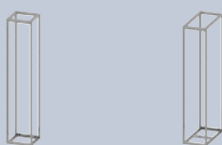
3WA air circuit breakers, fixed-mounted



① Frames

② Head compartments

③ Compartment doors



+ 3WA9111-0AP01

+ 3WA9111-0AP03

Size	I_n	Width	Depth	Number of poles	At front	At rear	Covers	IP40	IP55	IP55 upgrade			
1	2000 A	400 mm	800 mm	3-pole	8PQ1204-8BA01	–	8PQ2025-4BA03	8PQ2055-4BA12	–	–			
			1000 mm	3-pole	8PQ1204-4BA01 + 8PQ1204-6BA01	8PQ2025-4BA03	8PQ2055-4BA12	–	–				
			1200 mm	3-pole	8PQ1204-4BA01 + 8PQ1204-8BA01	8PQ2025-4BA03	8PQ2055-4BA12	–	–				
			1200 mm duplex	3-pole	8PQ1204-4BA01 + 8PQ1204-8BA01	8PQ2025-4BA03	8PQ2055-4BA12	–	–				
	600 mm	3/4-pole	800 mm	3/4-pole	8PQ1206-8BA01	–	8PQ2025-6BA25	8PQ2055-6BA16	8PQ2055-6BA17	+ 8PQ2055-6BA06			
			1000 mm	3/4-pole	8PQ1206-4BA01 + 8PQ1206-6BA01	8PQ2025-6BA25	8PQ2055-6BA16	8PQ2055-6BA17	+ 8PQ2055-6BA06				
			1200 mm	3/4-pole	8PQ1206-4BA01 + 8PQ1206-8BA01	8PQ2025-6BA25	8PQ2055-6BA16	8PQ2055-6BA17	+ 8PQ2055-6BA06				
			1200 mm duplex	3/4-pole	8PQ1206-4BA01 + 8PQ1206-8BA01	8PQ2025-6BA25	8PQ2055-6BA16	8PQ2055-6BA17	+ 8PQ2055-6BA06				
			2	3200 A	800 mm	800 mm	3/4-pole	8PQ1208-8BA01	–	8PQ2025-8BA16	8PQ2055-8BA08	8PQ2055-8BA10	+ 8PQ2055-8BA06
						1000 mm	3/4-pole	8PQ1208-4BA01 + 8PQ1208-6BA01	8PQ2025-8BA16	8PQ2055-8BA08	8PQ2055-8BA10	+ 8PQ2055-8BA06	
						1200 mm	3/4-pole	8PQ1208-4BA01 + 8PQ1208-8BA01	8PQ2025-8BA16	8PQ2055-8BA08	8PQ2055-8BA10	+ 8PQ2055-8BA06	
						1200 mm duplex	3/4-pole	8PQ1208-4BA01 + 8PQ1208-8BA01	8PQ2025-8BA16	8PQ2055-8BA08	8PQ2055-8BA10	+ 8PQ2055-8BA06	
3	4000 A	1000 mm	1200 mm	3/4-pole	8PQ1201-4BA02 + 8PQ1201-8BA03	8PQ2025-1BA01	8PQ2055-1BA03	8PQ2055-1BA04	+ 8PQ2055-1BA06				
					8PQ1201-4BA02 + 8PQ1201-8BA03	8PQ2025-1BA01	8PQ2055-1BA03	8PQ2055-1BA04	+ 8PQ2055-1BA06				

Accessories

Frame reinforcement




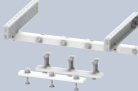
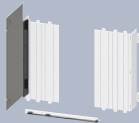

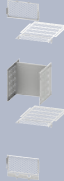


Size	Depth	Article No.
3	1200 mm	8PQ5000-5BA46

Barrier supports

Size	Depth	Scope of supply	Article No.
1, 2, 3	1200 mm	1 set = 6 units	8PQ3000-3BA67

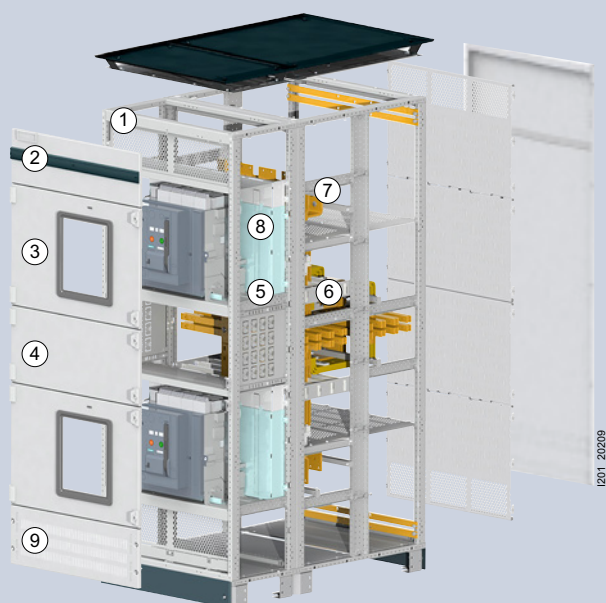
Compartment ID strip for plug-in plates, H = 17 mm

Width	Scope of supply	Article No.
400 mm	6 units	8PQ5000-3BA42
600 mm	6 units	8PQ5000-3BA43
800 mm	6 units	8PQ5000-3BA46
1000 mm	6 units	8PQ5000-3BA47

4 Auxiliary device compartments	5 Mounting plates	6 Main busbar connection	7 Cable connection	8 Separation	9 Base compartment covers			
								
Compartment doors				Device compartment	Rear panels	Section	IP40	IP55
8PQ2035-4BA01	8PQ6000-5BA25	8PQ6001-0BA65	8PQ6001-0BA77	8PQ5000-3BA82	8PQ5000-5BA21	8PQ5000-5BA30	8PQ2000-4BA06	–
8PQ2035-4BA01	8PQ6000-5BA25	8PQ6001-0BA65	8PQ6001-0BA77	8PQ5000-3BA82	8PQ5000-5BA48	8PQ5000-5BA30	8PQ2000-4BA06	–
8PQ2035-4BA01	8PQ6000-5BA25	8PQ6001-0BA65	8PQ6001-0BA77	8PQ5000-3BA82	8PQ5000-5BA21	8PQ5000-5BA30	8PQ2000-4BA06	–
8PQ2035-4BA01	8PQ6000-5BA25	8PQ6001-0BA65 + 8PQ6001-0BA61	8PQ6001-0BA77	8PQ5000-3BA82	8PQ5000-5BA21	8PQ5000-5BA32	8PQ2000-4BA06	–
8PQ2035-6BA12	8PQ6000-5BA26	8PQ6001-0BA67	8PQ6001-0BA78	8PQ5000-3BA82	8PQ5000-5BA22	8PQ5000-5BA34	8PQ2000-6BA13	8PQ2000-6BA11
8PQ2035-6BA12	8PQ6000-5BA26	8PQ6001-0BA67	8PQ6001-0BA78	8PQ5000-3BA82	8PQ5000-5BA50	8PQ5000-5BA34	8PQ2000-6BA13	8PQ2000-6BA11
8PQ2035-6BA12	8PQ6000-5BA26	8PQ6001-0BA67	8PQ6001-0BA78	8PQ5000-3BA82	8PQ5000-5BA22	8PQ5000-5BA34	8PQ2000-6BA13	8PQ2000-6BA11
8PQ2035-6BA12	8PQ6000-5BA26	8PQ6001-0BA67 + 8PQ6001-0BA62	8PQ6001-0BA78	8PQ5000-3BA82	8PQ5000-5BA22	8PQ5000-5BA36	8PQ2000-6BA13	8PQ2000-6BA11
8PQ2035-8BA06	8PQ6000-5BA24	8PQ6001-0BA72	8PQ6001-0BA81	8PQ5000-3BA81	8PQ5000-5BA23	8PQ5000-5BA38	8PQ2000-8BA13	8PQ2000-8BA11
8PQ2035-8BA06	8PQ6000-5BA24	8PQ6001-0BA72	8PQ6001-0BA81	8PQ5000-3BA81	8PQ5000-5BA51	8PQ5000-5BA38	8PQ2000-8BA13	8PQ2000-8BA11
8PQ2035-8BA06	8PQ6000-5BA24	8PQ6001-0BA72	8PQ6001-0BA81	8PQ5000-3BA81	8PQ5000-5BA23	8PQ5000-5BA38	8PQ2000-8BA13	8PQ2000-8BA11
8PQ2035-8BA06	8PQ6000-5BA24	8PQ6001-0BA72 + 8PQ6001-0BA64	8PQ6001-0BA81	8PQ5000-3BA81	8PQ5000-5BA23	8PQ5000-5BA41	8PQ2000-8BA13	8PQ2000-8BA11
8PQ2035-1BA01	8PQ6000-8BA70	8PQ6001-0BA74	8PQ6001-0BA82	8PQ5000-1BA74	8PQ5000-5BA24	8PQ5000-5BA43	8PQ2000-1BA04	8PQ2000-1BA02
8PQ2035-1BA01	8PQ6000-8BA70	8PQ6001-0BA75	8PQ6001-4BA18	8PQ5000-1BA74	8PQ5000-5BA24	8PQ5000-5BA43	8PQ2000-1BA04	8PQ2000-1BA02

Section expansion

3WA air circuit breakers, withdrawable



1 Frames

2 Head compartments

3 Compartment doors



+ 3WA9111-0AP01



+ 3WA9111-0AP03



Size	I_n	Width	Depth	Number of poles	At front	At rear	Covers	IP40	IP55	IP55 upgrade
1	2000 A	400 mm	800 mm	3-pole	8PQ1204-8BA01	–	8PQ2025-4BA03	8PQ2055-4BA12	–	–
			1000 mm	3-pole	8PQ1204-4BA01	+ 8PQ1204-6BA01	8PQ2025-4BA03	8PQ2055-4BA12	–	–
			1200 mm	3-pole	8PQ1204-4BA01	+ 8PQ1204-8BA01	8PQ2025-4BA03	8PQ2055-4BA12	–	–
			1200 mm duplex	3-pole	8PQ1204-4BA01	+ 8PQ1204-8BA01	8PQ2025-4BA03	8PQ2055-4BA12	–	–
		600 mm	800 mm	3/4-pole	8PQ1204-4BA05	–	8PQ2025-6BA25	8PQ2055-6BA16	8PQ2055-6BA17	+ 8PQ2055-6BA06
			1000 mm	3/4-pole	8PQ1206-4BA01	+ 8PQ1206-6BA01	8PQ2025-6BA25	8PQ2055-6BA16	8PQ2055-6BA17	+ 8PQ2055-6BA06
			1200 mm	3/4-pole	8PQ1206-4BA01	+ 8PQ1206-8BA01	8PQ2025-6BA25	8PQ2055-6BA16	8PQ2055-6BA17	+ 8PQ2055-6BA06
2	3200 A	800 mm	800 mm	3/4-pole	8PQ1204-4BA05	–	8PQ2025-8BA16	8PQ2055-8BA08	8PQ2055-8BA10	+ 8PQ2055-8BA06
			1000 mm	3/4-pole	8PQ1208-4BA01	+ 8PQ1208-6BA01	8PQ2025-8BA16	8PQ2055-8BA08	8PQ2055-8BA10	+ 8PQ2055-8BA06
			1200 mm	3/4-pole	8PQ1208-4BA01	+ 8PQ1208-8BA01	8PQ2025-8BA16	8PQ2055-8BA08	8PQ2055-8BA10	+ 8PQ2055-8BA06
			1200 mm duplex	3/4-pole	8PQ1208-4BA01	+ 8PQ1208-8BA01	8PQ2025-8BA16	8PQ2055-8BA08	8PQ2055-8BA10	+ 8PQ2055-8BA06
3	4000 A	1000 mm	1200 mm	3/4-pole	8PQ1201-4BA02	+ 8PQ1201-8BA03	8PQ2025-1BA01	8PQ2055-1BA03	8PQ2055-1BA04	+ 8PQ2055-1BA06
3	5000 A	1000 mm	1200 mm	3/4-pole	8PQ1201-4BA02	+ 8PQ1201-8BA03	8PQ2025-1BA01	8PQ2055-1BA03	8PQ2055-1BA04	+ 8PQ2055-1BA06
3	6300 A	1000 mm	1200 mm	3/4-pole	8PQ1201-4BA02	+ 8PQ1201-8BA03	8PQ2025-1BA01	8PQ2055-1BA03	8PQ2055-1BA04	+ 8PQ2055-1BA06

Accessories

Frame reinforcement



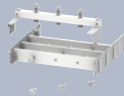
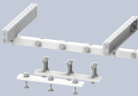
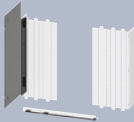

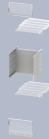


Size	Depth	Article No.
3	1200 mm	8PQ5000-5BA46

Barrier supports

Size	Depth	Scope of supply	Article No.
1, 2, 3	1200 mm	1 set = 6 units	8PQ3000-3BA67

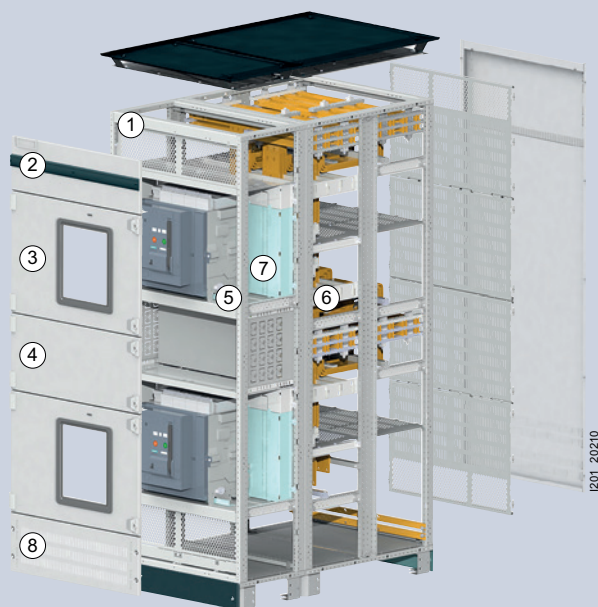
Compartment ID strip for plug-in plates, H = 17 mm

Width	Scope of supply	Article No.
400 mm	6 units	8PQ5000-3BA42
600 mm	6 units	8PQ5000-3BA43
800 mm	6 units	8PQ5000-3BA46
1000 mm	6 units	8PQ5000-3BA47

4 Auxiliary device compartments	5 Mounting plates	6 Main busbar connection	7 Cable connection	8 Separation	9 Base compartment covers			
								
Compartment doors				Device compartment	Rear panels	Section	IP40	IP55
8PQ2035-4BA01	8PQ6000-5BA25	8PQ6001-0BA66	8PQ6001-0BA77	8PQ5000-3BA82	8PQ5000-5BA21	8PQ5000-5BA30	8PQ2000-4BA06	–
8PQ2035-4BA01	8PQ6000-5BA25	8PQ6001-0BA66	8PQ6001-0BA77	8PQ5000-3BA82	8PQ5000-5BA48	8PQ5000-5BA30	8PQ2000-4BA06	–
8PQ2035-4BA01	8PQ6000-5BA25	8PQ6001-0BA66	8PQ6001-0BA77	8PQ5000-3BA82	8PQ5000-5BA21	8PQ5000-5BA30	8PQ2000-4BA06	–
8PQ2035-4BA01	8PQ6000-5BA25	8PQ6001-0BA66 + 8PQ6001-0BA61	8PQ6001-0BA77	8PQ5000-3BA82	8PQ5000-5BA21	8PQ5000-5BA32	8PQ2000-4BA06	–
8PQ2035-6BA12	8PQ6000-5BA26	8PQ6001-0BA68	8PQ6001-0BA78	8PQ5000-3BA82	8PQ5000-5BA22	8PQ5000-5BA34	8PQ2000-6BA13	8PQ2000-6BA11
8PQ2035-6BA12	8PQ6000-5BA26	8PQ6001-0BA68	8PQ6001-0BA78	8PQ5000-3BA82	8PQ5000-5BA50	8PQ5000-5BA34	8PQ2000-6BA13	8PQ2000-6BA11
8PQ2035-6BA12	8PQ6000-5BA26	8PQ6001-0BA68	8PQ6001-0BA78	8PQ5000-3BA82	8PQ5000-5BA22	8PQ5000-5BA34	8PQ2000-6BA13	8PQ2000-6BA11
8PQ2035-6BA12	8PQ6000-5BA26	8PQ6001-0BA68 + 8PQ6001-0BA61	8PQ6001-0BA78	8PQ5000-3BA82	8PQ5000-5BA22	8PQ5000-5BA36	8PQ2000-6BA13	8PQ2000-6BA11
8PQ2035-8BA06	8PQ6000-5BA24	8PQ6001-0BA73	8PQ6001-0BA81	8PQ5000-3BA81	8PQ5000-5BA23	8PQ5000-5BA38	8PQ2000-8BA13	8PQ2000-8BA11
8PQ2035-8BA06	8PQ6000-5BA24	8PQ6001-0BA73	8PQ6001-0BA81	8PQ5000-3BA81	8PQ5000-5BA51	8PQ5000-5BA38	8PQ2000-8BA13	8PQ2000-8BA11
8PQ2035-8BA06	8PQ6000-5BA24	8PQ6001-0BA73	8PQ6001-0BA81	8PQ5000-3BA81	8PQ5000-5BA23	8PQ5000-5BA38	8PQ2000-8BA13	8PQ2000-8BA11
8PQ2035-8BA06	8PQ6000-5BA24	8PQ6001-0BA73 + 8PQ6001-0BA61	8PQ6001-0BA81	8PQ5000-3BA81	8PQ5000-5BA23	8PQ5000-5BA41	8PQ2000-8BA13	8PQ2000-8BA11
8PQ2035-1BA01	8PQ6000-8BA70	8PQ6001-0BA74	8PQ6001-0BA83	8PQ5000-1BA74	8PQ5000-5BA24	8PQ5000-5BA43	8PQ2000-1BA04	8PQ2000-1BA02
8PQ2035-1BA01	8PQ6000-8BA70	8PQ6001-0BA75	8PQ6001-0BA83	8PQ5000-1BA74	8PQ5000-5BA24	8PQ5000-5BA43	8PQ2000-1BA04	8PQ2000-1BA02
8PQ2035-1BA01	8PQ6000-8BA70	8PQ6001-0BA76	8PQ6001-0BA84	8PQ5000-1BA74	8PQ5000-5BA24	8PQ5000-5BA43	8PQ2000-1BA04	8PQ2000-1BA02

Section expansion

3WA air circuit breakers, couplings, fixed-mounted



1 Frame

2 Head compartments

3 Compartment doors



+ 3WA9111-0AP01



+ 3WA9111-0AP03



Size	I_n	Width	Depth	Number of poles	At front	At rear	Covers	IP40	IP55	IP55 upgrade
1	2000 A	400 mm	800 mm	3-pole	8PQ1204-8BA01	–	8PQ2025-4BA03	8PQ2055-4BA12	–	–
			1000 mm	3-pole	8PQ1204-4BA01 + 8PQ1204-6BA01	8PQ2025-4BA03	8PQ2055-4BA12	–	–	
			1200 mm	3-pole	8PQ1204-4BA01 + 8PQ1204-8BA01	8PQ2025-4BA03	8PQ2055-4BA12	–	–	
			1200 mm duplex	3-pole	8PQ1204-4BA01 + 8PQ1204-8BA01	8PQ2025-4BA03	8PQ2055-4BA12	–	–	
	600 mm	800 mm	3/4-pole	8PQ1206-8BA01	–	8PQ2025-6BA25	8PQ2055-6BA16	8PQ2055-6BA17 + 8PQ2055-6BA06		
		1000 mm	3/4-pole	8PQ1206-4BA01 + 8PQ1206-6BA01	8PQ2025-6BA25	8PQ2055-6BA16	8PQ2055-6BA17 + 8PQ2055-6BA06			
		1200 mm	3/4-pole	8PQ1206-4BA01 + 8PQ1206-8BA01	8PQ2025-6BA25	8PQ2055-6BA16	8PQ2055-6BA17 + 8PQ2055-6BA06			
		1200 mm duplex	3/4-pole	8PQ1206-4BA01 + 8PQ1206-8BA01	8PQ2025-6BA25	8PQ2055-6BA16	8PQ2055-6BA17 + 8PQ2055-6BA06			
2	3200 A	800 mm	800 mm	3/4-pole	8PQ1208-8BA01	–	8PQ2025-8BA16	8PQ2055-8BA08	8PQ2055-8BA10 + 8PQ2055-8BA06	
			1000 mm	3/4-pole	8PQ1208-4BA01 + 8PQ1208-6BA01	8PQ2025-8BA16	8PQ2055-8BA08	8PQ2055-8BA10 + 8PQ2055-8BA06		
			1200 mm	3/4-pole	8PQ1208-4BA01 + 8PQ1208-8BA01	8PQ2025-8BA16	8PQ2055-8BA08	8PQ2055-8BA10 + 8PQ2055-8BA06		
			1200 mm duplex	3/4-pole	8PQ1208-4BA01 + 8PQ1208-8BA01	8PQ2025-8BA16	8PQ2055-8BA08	8PQ2055-8BA10 + 8PQ2055-8BA06		
3	4000 A	1000 mm	1200 mm	3/4-pole	8PQ1201-4BA02 + 8PQ1201-8BA03	8PQ2025-1BA01	8PQ2055-1BA03	8PQ2055-1BA04 + 8PQ2055-1BA06		
3	5000 A	1000 mm	1200 mm	3/4-pole	8PQ1201-4BA02 + 8PQ1201-8BA03	8PQ2025-1BA01	8PQ2055-1BA03	8PQ2055-1BA04 + 8PQ2055-1BA06		

Accessories

Frame reinforcement



Size	Depth	Article No.
3	1200 mm	8PQ5000-5BA46

Barrier supports



Size	Depth	Scope of supply	Article No.
1, 2, 3	1200 mm	1 set = 6 units	8PQ3000-3BA67

Compartment ID strip for plug-in plates, H = 17 mm

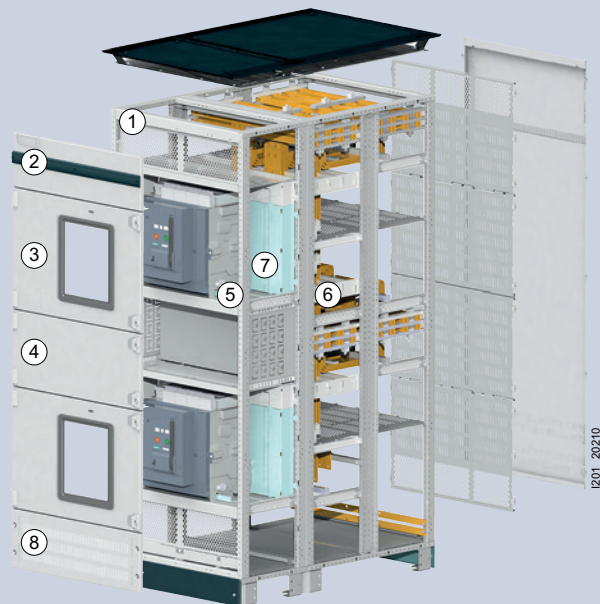


Width	Scope of supply	Article No.
400 mm	6 units	8PQ5000-3BA42
600 mm	6 units	8PQ5000-3BA43
800 mm	6 units	8PQ5000-3BA46
1000 mm	6 units	8PQ5000-3BA47

4 Auxiliary device compartments		5 Mounting plates		6 Main busbar connection		7 Separation		8 Base compartment covers	
Compartment doors		Device compartment		Rear panels	Section	IP40	IP55		
8PQ2035-4BA01	8PQ6000-5BA25	2 × 8PQ6001-0BA65	8PQ5000-3BA82	8PQ5000-5BA25	8PQ5000-5BA31	8PQ2000-4BA06	–		
8PQ2035-4BA01	8PQ6000-5BA25	2 × 8PQ6001-0BA65	8PQ5000-3BA82	8PQ5000-5BA52	8PQ5000-5BA31	8PQ2000-4BA06	–		
8PQ2035-4BA01	8PQ6000-5BA25	2 × 8PQ6001-0BA65	8PQ5000-3BA82	8PQ5000-5BA25	8PQ5000-5BA31	8PQ2000-4BA06	–		
8PQ2035-4BA01	8PQ6000-5BA25	2 × 8PQ6001-0BA65 + 8PQ6001-0BA61	8PQ5000-3BA82	8PQ5000-5BA25	8PQ5000-5BA33	8PQ2000-4BA06	–		
8PQ2035-6BA12	8PQ6000-5BA26	2 × 8PQ6001-0BA67	8PQ5000-3BA82	8PQ5000-5BA26	8PQ5000-5BA35	8PQ2000-6BA13	8PQ2000-6BA11		
8PQ2035-6BA12	8PQ6000-5BA26	2 × 8PQ6001-0BA67	8PQ5000-3BA82	8PQ5000-5BA53	8PQ5000-5BA35	8PQ2000-6BA13	8PQ2000-6BA11		
8PQ2035-6BA12	8PQ6000-5BA26	2 × 8PQ6001-0BA67	8PQ5000-3BA82	8PQ5000-5BA26	8PQ5000-5BA35	8PQ2000-6BA13	8PQ2000-6BA11		
8PQ2035-6BA12	8PQ6000-5BA26	2 × 8PQ6001-0BA67 + 8PQ6001-0BA62	8PQ5000-3BA82	8PQ5000-5BA26	8PQ5000-5BA37	8PQ2000-6BA13	8PQ2000-6BA11		
8PQ2035-8BA06	8PQ6000-5BA24	2 × 8PQ6001-0BA72	8PQ5000-3BA81	8PQ5000-5BA27	8PQ5000-5BA40	8PQ2000-8BA13	8PQ2000-8BA11		
8PQ2035-8BA06	8PQ6000-5BA24	2 × 8PQ6001-0BA72	8PQ5000-3BA81	8PQ5000-5BA54	8PQ5000-5BA40	8PQ2000-8BA13	8PQ2000-8BA11		
8PQ2035-8BA06	8PQ6000-5BA24	2 × 8PQ6001-0BA72	8PQ5000-3BA81	8PQ5000-5BA27	8PQ5000-5BA40	8PQ2000-8BA13	8PQ2000-8BA11		
8PQ2035-8BA06	8PQ6000-5BA24	2 × 8PQ6001-0BA72 + 8PQ6001-0BA64	8PQ5000-3BA81	8PQ5000-5BA27	8PQ5000-5BA42	8PQ2000-8BA13	8PQ2000-8BA11		
8PQ2035-1BA01	8PQ6000-8BA70	2 × 8PQ6001-0BA74	8PQ5000-1BA74	8PQ5000-5BA28	8PQ5000-5BA44	8PQ2000-1BA04	8PQ2000-1BA02		
8PQ2035-1BA01	8PQ6000-8BA70	2 × 8PQ6001-0BA75	8PQ5000-1BA74	8PQ5000-5BA28	8PQ5000-5BA44	8PQ2000-1BA04	8PQ2000-1BA02		

Section expansion

3WA air circuit breakers, couplings, withdrawable



1 Frame

2 Head compartments

3 Compartment doors



+ 3WA9111-0AP01

+ 3WA9111-0AP03

Size	I_n	Width	Depth	Number of poles	At front	At rear	Covers	IP40	IP55	IP55 upgrade
1	2000 A	400 mm	800 mm	3-pole	8PQ1204-8BA01	–	8PQ2025-4BA03	8PQ2055-4BA12	–	–
			1000 mm	3-pole	8PQ1204-4BA01 + 8PQ1204-6BA01	8PQ2025-4BA03	8PQ2055-4BA12	–	–	
			1200 mm	3-pole	8PQ1204-4BA01 + 8PQ1204-8BA01	8PQ2025-4BA03	8PQ2055-4BA12	–	–	
			1200 mm	3-pole duplex	8PQ1204-4BA01 + 8PQ1204-8BA01	8PQ2025-4BA03	8PQ2055-4BA12	–	–	
		600 mm	800 mm	3/4-pole	8PQ1206-8BA01	–	8PQ2025-6BA25	8PQ2055-6BA16	8PQ2055-6BA17 + 8PQ2055-6BA06	
			1000 mm	3/4-pole	8PQ1206-4BA01 + 8PQ1206-6BA01	8PQ2025-6BA25	8PQ2055-6BA16	8PQ2055-6BA17 + 8PQ2055-6BA06		
			1200 mm	3/4-pole	8PQ1206-4BA01 + 8PQ1206-8BA01	8PQ2025-6BA25	8PQ2055-6BA16	8PQ2055-6BA17 + 8PQ2055-6BA06		
			1200 mm	3/4-pole duplex	8PQ1206-4BA01 + 8PQ1206-8BA01	8PQ2025-6BA25	8PQ2055-6BA16	8PQ2055-6BA17 + 8PQ2055-6BA06		
2	3200 A	800 mm	800 mm	3/4-pole	8PQ1208-8BA01	–	8PQ2025-8BA16	8PQ2055-8BA08	8PQ2055-8BA10 + 8PQ2055-8BA06	
			1000 mm	3/4-pole	8PQ1208-4BA01 + 8PQ1208-6BA01	8PQ2025-8BA16	8PQ2055-8BA08	8PQ2055-8BA10 + 8PQ2055-8BA06		
			1200 mm	3/4-pole	8PQ1208-4BA01 + 8PQ1208-8BA01	8PQ2025-8BA16	8PQ2055-8BA08	8PQ2055-8BA10 + 8PQ2055-8BA06		
			1200 mm	3/4-pole duplex	8PQ1208-4BA01 + 8PQ1208-8BA01	8PQ2025-8BA16	8PQ2055-8BA08	8PQ2055-8BA10 + 8PQ2055-8BA06		
3	4000 A	1000 mm	1200 mm	3/4-pole	8PQ1201-4BA02 + 8PQ1201-8BA03	8PQ2025-1BA01	8PQ2055-1BA03	8PQ2055-1BA04 + 8PQ2055-1BA06		
3	5000 A	1000 mm	1200 mm	3/4-pole	8PQ1201-4BA02 + 8PQ1201-8BA03	8PQ2025-1BA01	8PQ2055-1BA03	8PQ2055-1BA04 + 8PQ2055-1BA06		
3	6300 A	1000 mm	1200 mm	3/4-pole	8PQ1201-4BA02 + 8PQ1201-8BA03	8PQ2025-1BA01	8PQ2055-1BA03	8PQ2055-1BA04 + 8PQ2055-1BA06		

Accessories

Frame reinforcement



Size	Depth	Article No.
3	1200 mm	8PQ5000-5BA46

Barrier supports



Size	Depth	Scope of supply	Article No.
1, 2, 3	1200 mm	1 set = 6 units	8PQ3000-3BA67

Compartment ID strip for plug-in plates, H = 17 mm



Width	Scope of supply	Article No.
400 mm	6 units	8PQ5000-3BA42
600 mm	6 units	8PQ5000-3BA43
800 mm	6 units	8PQ5000-3BA46
1000 mm	6 units	8PQ5000-3BA47

4 Auxiliary device compartments		5 Mounting plates		6 Main busbar connection		7 Separation		8 Base compartment covers			
Compartment doors		Device compartment		Rear panels		Section		IP40		IP55	
8PQ2035-4BA01	8PQ6000-5BA25	2 ×	8PQ6001-0BA66	8PQ5000-3BA82	8PQ5000-5BA25	8PQ5000-5BA31	8PQ2000-4BA06	–			
8PQ2035-4BA01	8PQ6000-5BA25	2 ×	8PQ6001-0BA66	8PQ5000-3BA82	8PQ5000-5BA52	8PQ5000-5BA31	8PQ2000-4BA06	–			
8PQ2035-4BA01	8PQ6000-5BA25	2 ×	8PQ6001-0BA66	8PQ5000-3BA82	8PQ5000-5BA25	8PQ5000-5BA31	8PQ2000-4BA06	–			
8PQ2035-4BA01	8PQ6000-5BA25	2 ×	8PQ6001-0BA66 + 8PQ6001-0BA61	8PQ5000-3BA82	8PQ5000-5BA25	8PQ5000-5BA33	8PQ2000-4BA06	–			
8PQ2035-6BA12	8PQ6000-5BA26	2 ×	8PQ6001-0BA68	8PQ5000-3BA82	8PQ5000-5BA26	8PQ5000-5BA35	8PQ2000-6BA13	8PQ2000-6BA11			
8PQ2035-6BA12	8PQ6000-5BA26	2 ×	8PQ6001-0BA68	8PQ5000-3BA82	8PQ5000-5BA53	8PQ5000-5BA35	8PQ2000-6BA13	8PQ2000-6BA11			
8PQ2035-6BA12	8PQ6000-5BA26	2 ×	8PQ6001-0BA68	8PQ5000-3BA82	8PQ5000-5BA26	8PQ5000-5BA35	8PQ2000-6BA13	8PQ2000-6BA11			
8PQ2035-6BA12	8PQ6000-5BA26	2 ×	8PQ6001-0BA68 + 8PQ6001-0BA62	8PQ5000-3BA82	8PQ5000-5BA26	8PQ5000-5BA35	8PQ2000-6BA13	8PQ2000-6BA11			
8PQ2035-8BA06	8PQ6000-5BA24	2 ×	8PQ6001-0BA73	8PQ5000-3BA81	8PQ5000-5BA27	8PQ5000-5BA40	8PQ2000-8BA13	8PQ2000-8BA11			
8PQ2035-8BA06	8PQ6000-5BA24	2 ×	8PQ6001-0BA73	8PQ5000-3BA81	8PQ5000-5BA54	8PQ5000-5BA40	8PQ2000-8BA13	8PQ2000-8BA11			
8PQ2035-8BA06	8PQ6000-5BA24	2 ×	8PQ6001-0BA73	8PQ5000-3BA81	8PQ5000-5BA27	8PQ5000-5BA40	8PQ2000-8BA13	8PQ2000-8BA11			
8PQ2035-8BA06	8PQ6000-5BA24	2 ×	8PQ6001-0BA73 + 8PQ6001-0BA64	8PQ5000-3BA81	8PQ5000-5BA27	8PQ5000-5BA42	8PQ2000-8BA13	8PQ2000-8BA11			
8PQ2035-1BA01	8PQ6000-8BA70	2 ×	8PQ6001-0BA74	8PQ5000-1BA74	8PQ5000-5BA28	8PQ5000-5BA44	8PQ2000-1BA04	8PQ2000-1BA02			
8PQ2035-1BA01	8PQ6000-8BA70	2 ×	8PQ6001-0BA75	8PQ5000-1BA74	8PQ5000-5BA28	8PQ5000-5BA44	8PQ2000-1BA04	8PQ2000-1BA02			
8PQ2035-1BA01	8PQ6000-8BA70	2 ×	8PQ6001-0BA76	8PQ5000-1BA74	8PQ5000-5BA28	8PQ5000-5BA44	8PQ2000-1BA04	8PQ2000-1BA02			

Section expansion

3WA air circuit breakers, accessories

Busbar supports



Size	Width	Number of poles	Scope of supply	Article No.
1	600 mm	4-pole	4 units	8PQ6000-4BA35
	800 mm	4-pole	4 units	8PQ6000-4BA37
2	600 mm	3-pole	4 units	8PQ6000-4BA36
	800 mm	4-pole	4 units	8PQ6000-4BA38
3	1000 mm	4-pole	4 units	8PQ6000-4BA40

Busbar connections



For use with SIVACON 8PS

Size	Width	Number of poles	Scope of supply	Article No.
1	600 mm	4-pole	1 unit	8PQ3000-1BA70
	800 mm	4-pole	1 unit	8PQ3000-1BA71
2	600 mm	3-pole	1 unit	8PQ3000-1BA70
	800 mm	4-pole	1 unit	8PQ3000-1BA71
3	1000 mm	4-pole	1 unit	8PQ3000-1BA72

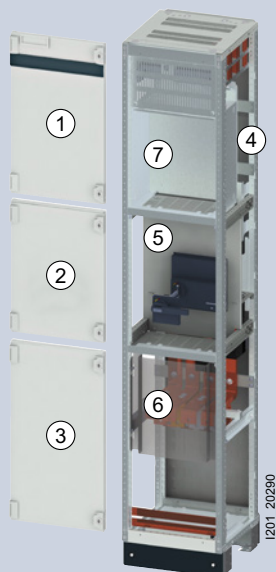
Cable brackets



Size	Width	Scope of supply	Article No.
1	400 mm	5 units	8PQ3000-0BA41
	600 mm	5 units	8PQ3000-0BA42
	800 mm	5 units	8PQ3000-0BA43
2	600 mm	5 units	8PQ3000-0BA42
	800 mm	5 units	8PQ3000-0BA43
3	1000 mm	4 units	8PQ3000-3BA68

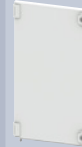
Section expansion

3VA molded case circuit breakers, 3-pole



Width 400 mm, fixed-mounted

① Head compartment doors ② Compartment doors ③ Base compartment doors



Main busbars	Type	I_n	① Head compartment doors		② Compartment doors		③ Base compartment doors	
			IP40	IP55 upgrade	IP40	IP55 upgrade	IP40	IP55 upgrade
Top front	3VA15	1000 A	8PQ2067-4BA01	8PQ2067-4BA02	8PQ2055-4BA15	8PQ2055-4BA07	8PQ2072-4BA01	8PQ2075-4BA02
	3VA25	1000 A	8PQ2067-4BA01	8PQ2067-4BA02	8PQ2055-4BA15	8PQ2055-4BA07	8PQ2072-4BA01	8PQ2075-4BA02
	3VA26	1250 A	8PQ2067-4BA01	8PQ2067-4BA02	8PQ2055-4BA15	8PQ2055-4BA07	8PQ2072-4BA01	8PQ2075-4BA02
Top rear	3VA15	1000 A	8PQ2067-4BA01	8PQ2067-4BA02	8PQ2055-4BA15	8PQ2055-4BA07	8PQ2072-4BA01	8PQ2075-4BA02
	3VA25	1000 A	8PQ2067-4BA01	8PQ2067-4BA02	8PQ2055-4BA15	8PQ2055-4BA07	8PQ2072-4BA01	8PQ2075-4BA02
	3VA26	1250 A	8PQ2067-4BA01	8PQ2067-4BA02	8PQ2055-4BA15	8PQ2055-4BA07	8PQ2072-4BA01	8PQ2075-4BA02
Top duplex	3VA15	1000 A	8PQ2067-4BA01	8PQ2067-4BA02	8PQ2055-4BA15	8PQ2055-4BA07	8PQ2072-4BA01	8PQ2075-4BA02
	3VA25	1000 A	8PQ2067-4BA01	8PQ2067-4BA02	8PQ2055-4BA15	8PQ2055-4BA07	8PQ2072-4BA01	8PQ2075-4BA02
	3VA26	1250 A	8PQ2067-4BA01	8PQ2067-4BA02	8PQ2055-4BA15	8PQ2055-4BA07	8PQ2072-4BA01	8PQ2075-4BA02
Bottom front	3VA15	1000 A	8PQ2067-4BA01	8PQ2067-4BA02	8PQ2055-4BA15	8PQ2055-4BA07	8PQ2072-4BA01	8PQ2075-4BA02
	3VA25	1000 A	8PQ2067-4BA01	8PQ2067-4BA02	8PQ2055-4BA15	8PQ2055-4BA07	8PQ2072-4BA01	8PQ2075-4BA02
	3VA26	1250 A	8PQ2067-4BA01	8PQ2067-4BA02	8PQ2055-4BA15	8PQ2055-4BA07	8PQ2072-4BA01	8PQ2075-4BA02
Bottom rear	3VA15	1000 A	8PQ2067-4BA01	8PQ2067-4BA02	8PQ2055-4BA15	8PQ2055-4BA07	8PQ2072-4BA01	8PQ2075-4BA02
	3VA25	1000 A	8PQ2067-4BA01	8PQ2067-4BA02	8PQ2055-4BA15	8PQ2055-4BA07	8PQ2072-4BA01	8PQ2075-4BA02
	3VA26	1250 A	8PQ2067-4BA01	8PQ2067-4BA02	8PQ2055-4BA15	8PQ2055-4BA07	8PQ2072-4BA01	8PQ2075-4BA02
Bottom duplex	3VA15	1000 A	8PQ2067-4BA01	8PQ2067-4BA02	8PQ2055-4BA15	8PQ2055-4BA07	8PQ2072-4BA01	8PQ2075-4BA02
	3VA25	1000 A	8PQ2067-4BA01	8PQ2067-4BA02	8PQ2055-4BA15	8PQ2055-4BA07	8PQ2072-4BA01	8PQ2075-4BA02
	3VA26	1250 A	8PQ2067-4BA01	8PQ2067-4BA02	8PQ2055-4BA15	8PQ2055-4BA07	8PQ2072-4BA01	8PQ2075-4BA02

Accessories

Compartment ID strip for plug-in plates, Height = 17 mm			
Width	Scope of supply	Article No.	
400 mm	6 units	8PQ5000-3BA42	

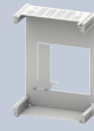
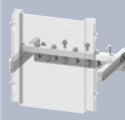
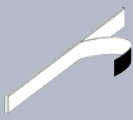
Insulation			
Size	Scope of supply	Article No.	
3VA26	3 units	8PQ5000-5BA74	

4 Main busbar connection

5 Mounting plates

6 Cable connection

7 Separation

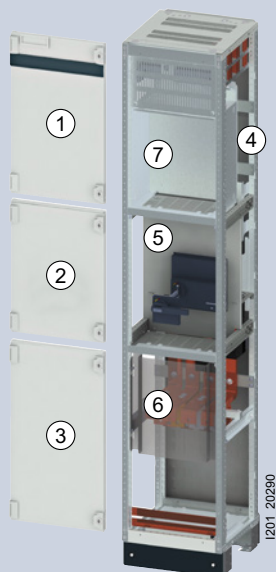


	Insulation Length 15 m				Auxiliary device compartments	Compartment	Rear Depth 600 mm	Depth 800 mm
8PQ6001-5BA55	8PQ3000-3BA82 ¹⁾	8PQ6001-4BA26	8PQ6001-4BA67	8PQ5000-5BA65	8PQ5000-5BA57	8PQ5000-5BA70	8PQ5000-5BA71	
8PQ6001-5BA55	8PQ3000-3BA82 ¹⁾	8PQ6001-4BA26	8PQ6001-4BA67	8PQ5000-5BA65	8PQ5000-5BA57	8PQ5000-5BA70	8PQ5000-5BA71	
8PQ6001-5BA58	8PQ3000-3BA81	8PQ6001-4BA26	8PQ6001-4BA68	8PQ5000-5BA65	8PQ5000-5BA57	8PQ5000-5BA70	8PQ5000-5BA71	
8PQ6001-5BA56	8PQ3000-3BA82 ¹⁾	8PQ6001-4BA26	8PQ6001-4BA67	8PQ5000-5BA65	8PQ5000-5BA57	–	8PQ5000-5BA71	
8PQ6001-5BA56	8PQ3000-3BA82 ¹⁾	8PQ6001-4BA26	8PQ6001-4BA67	8PQ5000-5BA65	8PQ5000-5BA57	–	8PQ5000-5BA71	
8PQ6001-5BA60	8PQ3000-3BA81	8PQ6001-4BA26	8PQ6001-4BA68	8PQ5000-5BA65	8PQ5000-5BA57	–	8PQ5000-5BA71	
8PQ6001-5BA57	8PQ3000-3BA82 ¹⁾	8PQ6001-4BA26	8PQ6001-4BA67	8PQ5000-5BA65	8PQ5000-5BA57	–	8PQ5000-5BA71	
8PQ6001-5BA57	8PQ3000-3BA82 ¹⁾	8PQ6001-4BA26	8PQ6001-4BA67	8PQ5000-5BA65	8PQ5000-5BA57	–	8PQ5000-5BA71	
8PQ6001-5BA61	8PQ3000-3BA81	8PQ6001-4BA26	8PQ6001-4BA68	8PQ5000-5BA65	8PQ5000-5BA57	–	8PQ5000-5BA71	
8PQ6001-5BA55	8PQ3000-3BA81	8PQ6001-4BA26	8PQ6001-4BA67	8PQ5000-5BA66	8PQ5000-5BA57	8PQ5000-5BA70	8PQ5000-5BA71	
8PQ6001-5BA55	8PQ3000-3BA81	8PQ6001-4BA26	8PQ6001-4BA67	8PQ5000-5BA66	8PQ5000-5BA57	8PQ5000-5BA70	8PQ5000-5BA71	
8PQ6001-5BA58	8PQ3000-3BA81	8PQ6001-4BA26	8PQ6001-4BA68	8PQ5000-5BA66	8PQ5000-5BA57	8PQ5000-5BA70	8PQ5000-5BA71	
8PQ6001-5BA56	8PQ3000-3BA81	8PQ6001-4BA26	8PQ6001-4BA67	8PQ5000-5BA66	8PQ5000-5BA57	–	8PQ5000-5BA71	
8PQ6001-5BA56	8PQ3000-3BA81	8PQ6001-4BA26	8PQ6001-4BA67	8PQ5000-5BA66	8PQ5000-5BA57	–	8PQ5000-5BA71	
8PQ6001-5BA60	8PQ3000-3BA81	8PQ6001-4BA26	8PQ6001-4BA68	8PQ5000-5BA66	8PQ5000-5BA57	–	8PQ5000-5BA71	
8PQ6001-5BA57	8PQ3000-3BA81	8PQ6001-4BA26	8PQ6001-4BA67	8PQ5000-5BA66	8PQ5000-5BA57	–	8PQ5000-5BA71	
8PQ6001-5BA57	8PQ3000-3BA81	8PQ6001-4BA26	8PQ6001-4BA67	8PQ5000-5BA66	8PQ5000-5BA57	–	8PQ5000-5BA71	
8PQ6001-5BA61	8PQ3000-3BA81	8PQ6001-4BA26	8PQ6001-4BA68	8PQ5000-5BA66	8PQ5000-5BA57	–	8PQ5000-5BA71	

¹⁾ Plastic cover

Section expansion

3VA molded case circuit breakers, 4-pole



Width 400 mm, fixed-mounted

① Head compartment doors

② Compartment doors

③ Base compartment doors



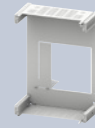
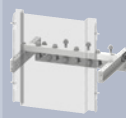
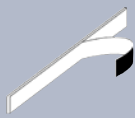
Main busbars	Type	I_n	① Head compartment doors		② Compartment doors		③ Base compartment doors	
			IP40	IP55 upgrade	IP40	IP55 upgrade	IP40	IP55 upgrade
Top front	3VA15	1000 A	8PQ2067-4BA01	8PQ2067-4BA02	8PQ2055-4BA15	8PQ2055-4BA07	8PQ2072-4BA01	8PQ2075-4BA02
	3VA25	1000 A	8PQ2067-4BA01	8PQ2067-4BA02	8PQ2055-4BA15	8PQ2055-4BA07	8PQ2072-4BA01	8PQ2075-4BA02
	3VA26	1250 A	8PQ2067-4BA01	8PQ2067-4BA02	8PQ2055-4BA15	8PQ2055-4BA07	8PQ2072-4BA01	8PQ2075-4BA02
Top rear	3VA15	1000 A	8PQ2067-4BA01	8PQ2067-4BA02	8PQ2055-4BA15	8PQ2055-4BA07	8PQ2072-4BA01	8PQ2075-4BA02
	3VA25	1000 A	8PQ2067-4BA01	8PQ2067-4BA02	8PQ2055-4BA15	8PQ2055-4BA07	8PQ2072-4BA01	8PQ2075-4BA02
	3VA26	1250 A	8PQ2067-4BA01	8PQ2067-4BA02	8PQ2055-4BA15	8PQ2055-4BA07	8PQ2072-4BA01	8PQ2075-4BA02
Top duplex	3VA15	1000 A	8PQ2067-4BA01	8PQ2067-4BA02	8PQ2055-4BA15	8PQ2055-4BA07	8PQ2072-4BA01	8PQ2075-4BA02
	3VA25	1000 A	8PQ2067-4BA01	8PQ2067-4BA02	8PQ2055-4BA15	8PQ2055-4BA07	8PQ2072-4BA01	8PQ2075-4BA02
	3VA26	1250 A	8PQ2067-4BA01	8PQ2067-4BA02	8PQ2055-4BA15	8PQ2055-4BA07	8PQ2072-4BA01	8PQ2075-4BA02
Bottom front	3VA15	1000 A	8PQ2067-4BA01	8PQ2067-4BA02	8PQ2055-4BA15	8PQ2055-4BA07	8PQ2072-4BA01	8PQ2075-4BA02
	3VA25	1000 A	8PQ2067-4BA01	8PQ2067-4BA02	8PQ2055-4BA15	8PQ2055-4BA07	8PQ2072-4BA01	8PQ2075-4BA02
	3VA26	1250 A	8PQ2067-4BA01	8PQ2067-4BA02	8PQ2055-4BA15	8PQ2055-4BA07	8PQ2072-4BA01	8PQ2075-4BA02
Bottom rear	3VA15	1000 A	8PQ2067-4BA01	8PQ2067-4BA02	8PQ2055-4BA15	8PQ2055-4BA07	8PQ2072-4BA01	8PQ2075-4BA02
	3VA25	1000 A	8PQ2067-4BA01	8PQ2067-4BA02	8PQ2055-4BA15	8PQ2055-4BA07	8PQ2072-4BA01	8PQ2075-4BA02
	3VA26	1250 A	8PQ2067-4BA01	8PQ2067-4BA02	8PQ2055-4BA15	8PQ2055-4BA07	8PQ2072-4BA01	8PQ2075-4BA02
Bottom duplex	3VA15	1000 A	8PQ2067-4BA01	8PQ2067-4BA02	8PQ2055-4BA15	8PQ2055-4BA07	8PQ2072-4BA01	8PQ2075-4BA02
	3VA25	1000 A	8PQ2067-4BA01	8PQ2067-4BA02	8PQ2055-4BA15	8PQ2055-4BA07	8PQ2072-4BA01	8PQ2075-4BA02
	3VA26	1250 A	8PQ2067-4BA01	8PQ2067-4BA02	8PQ2055-4BA15	8PQ2055-4BA07	8PQ2072-4BA01	8PQ2075-4BA02

Accessories

Compartment ID strip for plug-in plates, Height = 17 mm			
Width	Scope of supply	Article No.	
400 mm	6 units	8PQ5000-3BA42	

Insulation			
Size	Scope of supply	Article No.	
3VA26	3 units	2 × 8PQ5000-5BA74	

④ Main busbar connection ⑤ Mounting plates ⑥ Cable connection ⑦ Separation

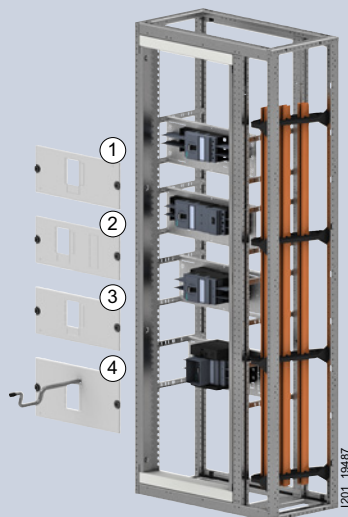


	Insulation Length 15 m			Auxiliary device compartments	Compartment	Rear Depth 600 mm	Depth 800 mm
8PQ6001-5BA55	8PQ3000-3BA82 ¹⁾	8PQ6001-4BA26	8PQ6001-4BA67	8PQ5000-5BA65	8PQ5000-5BA57	8PQ5000-5BA70	8PQ5000-5BA71
8PQ6001-5BA55	8PQ3000-3BA82 ¹⁾	8PQ6001-4BA26	8PQ6001-4BA67	8PQ5000-5BA65	8PQ5000-5BA57	8PQ5000-5BA70	8PQ5000-5BA71
8PQ6001-5BA58	8PQ3000-3BA81	8PQ6001-4BA26	8PQ6001-4BA68	8PQ5000-5BA65	8PQ5000-5BA57	8PQ5000-5BA70	8PQ5000-5BA71
8PQ6001-5BA56	8PQ3000-3BA82 ¹⁾	8PQ6001-4BA26	8PQ6001-4BA67	8PQ5000-5BA65	8PQ5000-5BA57	–	8PQ5000-5BA71
8PQ6001-5BA56	8PQ3000-3BA82 ¹⁾	8PQ6001-4BA26	8PQ6001-4BA67	8PQ5000-5BA65	8PQ5000-5BA57	–	8PQ5000-5BA71
8PQ6001-5BA60	8PQ3000-3BA81	8PQ6001-4BA26	8PQ6001-4BA68	8PQ5000-5BA65	8PQ5000-5BA57	–	8PQ5000-5BA71
8PQ6001-5BA57	8PQ3000-3BA82 ¹⁾	8PQ6001-4BA26	8PQ6001-4BA67	8PQ5000-5BA65	8PQ5000-5BA57	–	8PQ5000-5BA71
8PQ6001-5BA57	8PQ3000-3BA82 ¹⁾	8PQ6001-4BA26	8PQ6001-4BA67	8PQ5000-5BA65	8PQ5000-5BA57	–	8PQ5000-5BA71
8PQ6001-5BA61	8PQ3000-3BA81	8PQ6001-4BA26	8PQ6001-4BA68	8PQ5000-5BA65	8PQ5000-5BA57	–	8PQ5000-5BA71
8PQ6001-5BA55	8PQ3000-3BA81	8PQ6001-4BA26	8PQ6001-4BA67	8PQ5000-5BA66	8PQ5000-5BA57	8PQ5000-5BA70	8PQ5000-5BA71
8PQ6001-5BA55	8PQ3000-3BA81	8PQ6001-4BA26	8PQ6001-4BA67	8PQ5000-5BA66	8PQ5000-5BA57	8PQ5000-5BA70	8PQ5000-5BA71
8PQ6001-5BA58	8PQ3000-3BA81	8PQ6001-4BA26	8PQ6001-4BA68	8PQ5000-5BA66	8PQ5000-5BA57	8PQ5000-5BA70	8PQ5000-5BA71
8PQ6001-5BA56	8PQ3000-3BA81	8PQ6001-4BA26	8PQ6001-4BA67	8PQ5000-5BA66	8PQ5000-5BA57	–	8PQ5000-5BA71
8PQ6001-5BA56	8PQ3000-3BA81	8PQ6001-4BA26	8PQ6001-4BA67	8PQ5000-5BA66	8PQ5000-5BA57	–	8PQ5000-5BA71
8PQ6001-5BA60	8PQ3000-3BA81	8PQ6001-4BA26	8PQ6001-4BA68	8PQ5000-5BA66	8PQ5000-5BA57	–	8PQ5000-5BA71
8PQ6001-5BA57	8PQ3000-3BA81	8PQ6001-4BA26	8PQ6001-4BA67	8PQ5000-5BA66	8PQ5000-5BA57	–	8PQ5000-5BA71
8PQ6001-5BA57	8PQ3000-3BA81	8PQ6001-4BA26	8PQ6001-4BA67	8PQ5000-5BA66	8PQ5000-5BA57	–	8PQ5000-5BA71
8PQ6001-5BA61	8PQ3000-3BA81	8PQ6001-4BA26	8PQ6001-4BA68	8PQ5000-5BA66	8PQ5000-5BA57	–	8PQ5000-5BA71

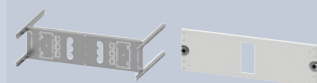
¹⁾ Plastic cover

Section expansion

3VA molded case circuit breakers, 3-pole



Fixed-mounted version









Type	I_n	Width	Operating mechanism			Device holders	Covers
			Direct	Rotary	Motorized		
3VA10	100 A	600 mm	■	■	–	8PQ6000-8BA01	8PQ2015-6BA26
		800 mm	■	■	–	8PQ6000-8BA02	8PQ2015-8BA11
3VA11	160 A	600 mm	■	■	–	8PQ6000-8BA01	8PQ2015-6BA26
		800 mm	■	■	–	8PQ6000-8BA02	8PQ2015-8BA11
3VA12	250 A	600 mm	■	■	–	8PQ6000-8BA03	8PQ2015-6BA28
		800 mm	■	■	–	8PQ6000-8BA07	8PQ2020-8BA20
3VA13	400 A	600 mm	■	■	–	8PQ6000-8BA23	8PQ2020-6BA41
		800 mm	■	■	–	8PQ6000-8BA27	8PQ2025-8BA14
3VA14	630 A	600 mm	■	■	–	8PQ6000-8BA23	8PQ2020-6BA41
		800 mm	■	■	–	8PQ6000-8BA27	8PQ2025-8BA14
3VA15	1000 A	800 mm	■	–	–	8PQ2045-8BA22	
3VA20	100 A	600 mm	■	■	–	8PQ6000-8BA08	8PQ2020-6BA38
		800 mm	■	■	–	8PQ6000-8BA10	8PQ2020-8BA21
3VA21	160 A	600 mm	■	■	–	8PQ6000-8BA08	8PQ2020-6BA38
		800 mm	■	■	–	8PQ6000-8BA10	8PQ2020-8BA21
3VA22	250 A	600 mm	■	■	–	8PQ6000-8BA08	8PQ2020-6BA38
		800 mm	■	■	–	8PQ6000-8BA10	8PQ2020-8BA21
3VA23	400 A	600 mm	■	■	–	8PQ6000-8BA23	8PQ2020-6BA41
		800 mm	■	■	–	8PQ6000-8BA27	8PQ2025-8BA14
3VA24	630 A	600 mm	■	■	–	8PQ6000-8BA23	8PQ2020-6BA41
		800 mm	■	■	–	8PQ6000-8BA27	8PQ2025-8BA14
3VA25	1000 A	800 mm	■	–	–	8PQ2045-8BA22	
3VA26	1250 A	800 mm	■	–	–	8PQ2045-8BA22	
3VA27	1600 A	800 mm	■	–	–	8PQ2045-8BA23	

Accessories

Insulation 130 × 2 mm



Size	Length	Article No.
3VA15, 3VA25, 3VA26	15 m	8PQ3000-3BA81

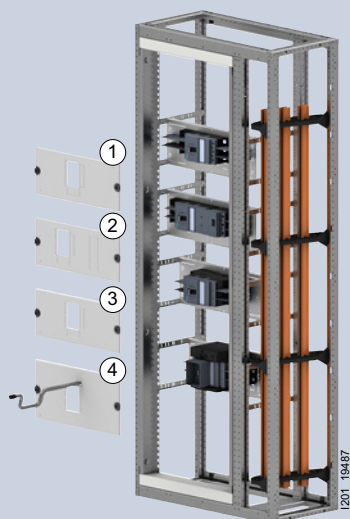
⊖ Fixed-mounted version with RCD		⊖ Plug-in version		⊕ Withdrawable version ²⁾	
					
Device holders	Covers	Device holders	Covers	Device holders	Covers
–	–	–	–	–	–
–	–	–	–	–	–
8PQ6000-8BA01	8PQ2015-6BA27	8PQ6000-8BA01	8PQ2015-6BA26	–	–
8PQ6000-8BA01	8PQ2015-6BA27	8PQ6000-8BA01	8PQ2015-6BA26	–	–
8PQ6000-8BA02	8PQ2015-8BA11	8PQ6000-8BA02	8PQ2015-8BA11	–	–
8PQ6000-8BA02	8PQ2015-8BA11	8PQ6000-8BA02	8PQ2015-8BA11	–	–
8PQ6000-8BA03 ¹⁾	8PQ2015-6BA30	8PQ6000-8BA04	8PQ2015-6BA28	8PQ6000-8BA04	8PQ2025-6BA21
8PQ6000-8BA03	8PQ2015-6BA30	8PQ6000-8BA04	8PQ2015-6BA28	–	–
8PQ6000-8BA07	8PQ2020-8BA20	8PQ6000-8BA07	8PQ2020-8BA20	8PQ6000-8BA07	8PQ2025-8BA12
8PQ6000-8BA07	8PQ2020-8BA20	8PQ6000-8BA07	8PQ2020-8BA20	–	–
–	–	–	–	–	–
–	–	–	–	–	–
–	–	8PQ6001-1BA02	8PQ2025-8BA18	8PQ6001-1BA02	8PQ2030-8BA15
–	–	8PQ6001-1BA02	8PQ2025-8BA18	–	–
–	–	–	–	–	–
–	–	–	–	–	–
–	–	8PQ6001-1BA02	8PQ2025-8BA18	8PQ6001-1BA02	8PQ2030-8BA15
–	–	8PQ6001-1BA02	8PQ2025-8BA18	–	–
–	–	–	–	–	–
8PQ6000-8BA11	8PQ2020-6BA40	8PQ6000-8BA08	8PQ2020-6BA38	8PQ6000-8BA08	8PQ2025-6BA22
8PQ6000-8BA11	8PQ2020-6BA40	8PQ6000-8BA08	8PQ2020-6BA38	–	–
8PQ6000-8BA10	8PQ2020-8BA21	8PQ6000-8BA10	8PQ2020-8BA21	8PQ6000-8BA10	8PQ2025-8BA13
8PQ6000-8BA10	8PQ2020-8BA21	8PQ6000-8BA10	8PQ2020-8BA21	–	–
8PQ6000-8BA11	8PQ2020-6BA40	8PQ6000-8BA08	8PQ2020-6BA38	8PQ6000-8BA08	8PQ2025-6BA22
8PQ6000-8BA11	8PQ2020-6BA40	8PQ6000-8BA08	8PQ2020-6BA38	–	–
8PQ6000-8BA10	8PQ2020-8BA21	8PQ6000-8BA10	8PQ2020-8BA21	8PQ6000-8BA10	8PQ2025-8BA13
8PQ6000-8BA10	8PQ2020-8BA21	8PQ6000-8BA10	8PQ2020-8BA21	–	–
8PQ6000-8BA11	8PQ2020-6BA40	8PQ6000-8BA08	8PQ2020-6BA38	8PQ6000-8BA08	8PQ2025-6BA22
8PQ6000-8BA11	8PQ2020-6BA40	8PQ6000-8BA08	8PQ2020-6BA38	–	–
8PQ6000-8BA10	8PQ2020-8BA21	8PQ6000-8BA10	8PQ2020-8BA21	8PQ6000-8BA10	8PQ2025-8BA13
8PQ6000-8BA10	8PQ2020-8BA21	8PQ6000-8BA10	8PQ2020-8BA21	–	–
–	–	–	–	–	–
–	–	–	–	–	–
8PQ6000-8BA27	8PQ2025-8BA14	8PQ6001-1BA02	8PQ2025-8BA18	8PQ6001-1BA02	8PQ2035-8BA15
8PQ6000-8BA27	8PQ2025-8BA14	8PQ6001-1BA02	8PQ2025-8BA18	–	–
–	–	–	–	–	–
–	–	–	–	–	–
8PQ6000-8BA27	8PQ2025-8BA14	8PQ6001-1BA02	8PQ2025-8BA18	8PQ6001-1BA02	8PQ2035-8BA15
8PQ6000-8BA27	8PQ2025-8BA14	8PQ6001-1BA02	8PQ2025-8BA18	–	–
–	–	–	–	–	–
–	–	–	–	–	–
–	–	–	–	8PQ6001-4BA24	8PQ2045-8BA24

¹⁾ For applications > 415 V, front mounted rotary operating mechanism or motorized operating mechanism required for compliance with creepage distances and clearances.

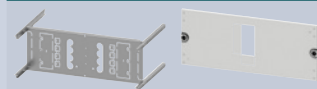
²⁾ Guide frame with direct operating mechanism only

Section expansion

3VA molded case circuit breakers, 4-pole



Fixed-mounted version



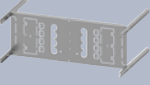

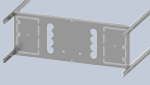



Type	I_n	Width	Operating mechanism			Device holders	Covers
			Direct	Rotary	Motorized		
3VA10	100 A	600 mm	■	■	–	8PQ6000-8BA01	8PQ2015-6BA26
		800 mm	■	■	–	8PQ6000-8BA02	8PQ2015-8BA11
3VA11	160 A	600 mm	■	■	–	8PQ6000-8BA01	8PQ2015-6BA26
		800 mm	–	–	■	8PQ6000-8BA01	8PQ2015-6BA26
			–	–	■	8PQ6000-8BA02	8PQ2015-8BA11
3VA12	250 A	600 mm	■	■	–	8PQ6000-8BA05	8PQ2020-6BA36
		800 mm	–	–	■	8PQ6000-8BA05	8PQ2020-6BA36
			–	–	■	8PQ6000-8BA07	8PQ2020-8BA20
3VA13	400 A	600 mm	■	■	–	8PQ6000-8BA25	8PQ2025-6BA23
		800 mm	–	–	■	8PQ6000-8BA25	8PQ2025-6BA23
			–	–	■	8PQ6000-8BA27	8PQ2025-8BA14
3VA14	630 A	600 mm	■	■	–	8PQ6000-8BA25	8PQ2025-6BA23
		800 mm	–	–	■	8PQ6000-8BA25	8PQ2025-6BA23
			–	–	■	8PQ6000-8BA27	8PQ2025-8BA14
3VA15	1000 A	800 mm	■	–	–	8PQ6001-4BA22	8PQ2045-8BA22
3VA20	100 A	600 mm	■	■	–	8PQ6000-8BA08	8PQ2020-6BA38
		800 mm	–	–	■	8PQ6000-8BA08	8PQ2020-6BA38
			–	–	■	8PQ6000-8BA10	8PQ2020-8BA21
3VA21	160 A	600 mm	■	■	–	8PQ6000-8BA08	8PQ2020-6BA38
		800 mm	–	–	■	8PQ6000-8BA08	8PQ2020-6BA38
			–	–	■	8PQ6000-8BA10	8PQ2020-8BA21
3VA22	250 A	600 mm	■	■	–	8PQ6000-8BA08	8PQ2020-6BA38
		800 mm	–	–	■	8PQ6000-8BA08	8PQ2020-6BA38
			–	–	■	8PQ6000-8BA10	8PQ2020-8BA21
3VA23	400 A	600 mm	■	■	–	8PQ6000-8BA25	8PQ2025-6BA23
		800 mm	–	–	■	8PQ6000-8BA25	8PQ2025-6BA23
			–	–	■	8PQ6000-8BA27	8PQ2025-8BA14
3VA24	630 A	600 mm	■	■	–	8PQ6000-8BA25	8PQ2025-6BA23
		800 mm	–	–	■	8PQ6000-8BA25	8PQ2025-6BA23
			–	–	■	8PQ6000-8BA27	8PQ2025-8BA14
3VA25	1000 A	800 mm	■	–	–	8PQ6001-4BA22	8PQ2045-8BA22
3VA26	1250 A	800 mm	■	–	–	8PQ6001-4BA22	8PQ2045-8BA22
3VA27	1600 A	800 mm	■	–	–	8PQ6001-4BA23	8PQ2045-8BA23

Accessories

Insulation 130 × 2 mm



Size	Length	Article No.
3VA15, 3VA25, 3VA26	15 m	8PQ3000-3BA81

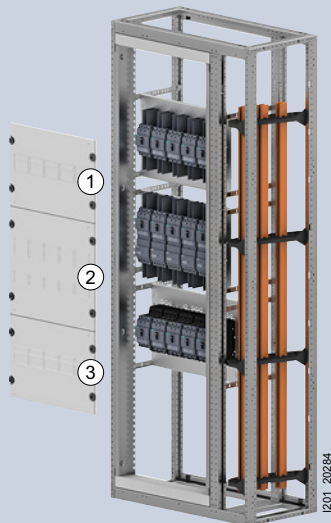
⊖ Fixed-mounted version with RCD		⊕ Plug-in version		⊕ Withdrawable version ²⁾	
					
Device holders	Covers	Device holders	Covers	Device holders	Covers
–	–	–	–	–	–
–	–	–	–	–	–
8PQ6000-8BA01	8PQ2015-6BA27	8PQ6000-8BA01	8PQ2015-6BA26	–	–
8PQ6000-8BA01	8PQ2015-6BA27	8PQ6000-8BA01	8PQ2015-6BA26	–	–
8PQ6000-8BA02	8PQ2015-8BA11	8PQ6000-8BA02	8PQ2015-8BA11	–	–
8PQ6000-8BA02	8PQ2015-8BA11	8PQ6000-8BA02	8PQ2015-8BA11	–	–
8PQ6000-8BA05 ¹⁾	8PQ2020-6BA37	8PQ6000-8BA06	8PQ2020-6BA36	8PQ6000-8BA06	8PQ2030-6BA25
8PQ6000-8BA05 ¹⁾	8PQ2020-6BA37	8PQ6000-8BA06	8PQ2020-6BA36	–	–
8PQ6000-8BA07	8PQ2020-8BA20	8PQ6000-8BA07	8PQ2020-8BA20	8PQ6000-8BA07	8PQ2030-8BA12
8PQ6000-8BA07	8PQ2020-8BA20	8PQ6000-8BA07	8PQ2020-8BA20	–	–
–	–	–	–	–	–
–	–	–	–	–	–
–	–	8PQ6001-1BA02	8PQ2025-8BA18	8PQ6001-1BA02	8PQ2030-8BA15
–	–	8PQ6001-1BA02	8PQ2025-8BA18	–	–
–	–	–	–	–	–
–	–	–	–	–	–
–	–	8PQ6001-1BA02	8PQ2025-8BA18	8PQ6001-1BA02	8PQ2030-8BA15
–	–	8PQ6001-1BA02	8PQ2025-8BA18	–	–
–	–	–	–	–	–
8PQ6000-8BA11	8PQ2020-6BA40	8PQ6000-8BA08	8PQ2020-6BA38	8PQ6000-8BA08	8PQ2030-6BA26
8PQ6000-8BA11	8PQ2020-6BA40	8PQ6000-8BA08	8PQ2020-6BA38	–	–
8PQ6000-8BA10	8PQ2020-8BA21	8PQ6000-8BA10	8PQ2020-8BA21	8PQ6000-8BA10	8PQ2030-8BA13
8PQ6000-8BA10	8PQ2020-8BA21	8PQ6000-8BA10	8PQ2020-8BA21	–	–
8PQ6000-8BA11	8PQ2020-6BA40	8PQ6000-8BA08	8PQ2020-6BA38	8PQ6000-8BA08	8PQ2030-6BA26
8PQ6000-8BA11	8PQ2020-6BA40	8PQ6000-8BA08	8PQ2020-6BA38	–	–
8PQ6000-8BA10	8PQ2020-8BA21	8PQ6000-8BA10	8PQ2020-8BA21	8PQ6000-8BA10	8PQ2030-8BA13
8PQ6000-8BA10	8PQ2020-8BA21	8PQ6000-8BA10	8PQ2020-8BA21	–	–
8PQ6000-8BA11	8PQ2020-6BA40	8PQ6000-8BA08	8PQ2020-6BA38	8PQ6000-8BA08	8PQ2030-6BA26
8PQ6000-8BA11	8PQ2020-6BA40	8PQ6000-8BA08	8PQ2020-6BA38	–	–
8PQ6000-8BA10	8PQ2020-8BA21	8PQ6000-8BA10	8PQ2020-8BA21	8PQ6000-8BA10	8PQ2030-8BA13
8PQ6000-8BA10	8PQ2020-8BA21	8PQ6000-8BA10	8PQ2020-8BA21	–	–
–	–	–	–	–	–
–	–	–	–	–	–
8PQ6000-8BA27	8PQ2025-8BA14	8PQ6001-1BA02	8PQ2025-8BA18	8PQ6001-1BA02	8PQ2035-8BA15
8PQ6000-8BA27	8PQ2025-8BA14	8PQ6001-1BA02	8PQ2025-8BA18	–	–
–	–	–	–	–	–
–	–	–	–	–	–
8PQ6000-8BA27	8PQ2025-8BA14	8PQ6001-1BA02	8PQ2025-8BA18	8PQ6001-1BA02	8PQ2035-8BA15
8PQ6000-8BA27	8PQ2025-8BA14	8PQ6001-1BA02	8PQ2025-8BA18	–	–
–	–	–	–	–	–
–	–	–	–	–	–
–	–	–	–	8PQ6001-4BA24	8PQ2045-8BA24

¹⁾ For applications > 415 V, front mounted rotary operating mechanism or motorized operating mechanism required for compliance with creepage distances and clearances.

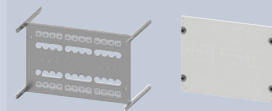
²⁾ Guide frame with direct operating mechanism only

Section expansion

3VA molded case circuit breakers, 3-pole



Fixed-mounted version

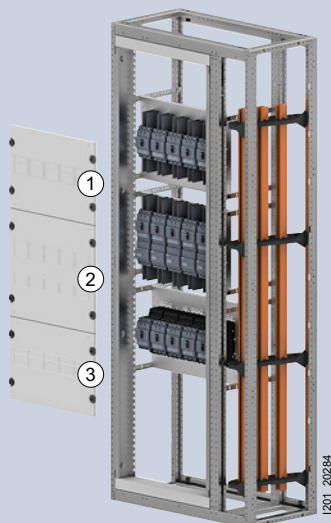


Type	I_n	Width	Operating mechanism			Device holders	Covers
			Direct	Rotary	Motorized		
3VA10	100 A	600 mm	■	■	–	8PQ6000-8BA33	8PQ2035-6BA26
		800 mm	■	■	–	8PQ6000-8BA47	8PQ2035-8BA16
3VA11	160 A	600 mm	■	■	–	8PQ6000-8BA33	8PQ2035-6BA26
		800 mm	■	■	–	8PQ6000-8BA47	8PQ2035-8BA16
3VA12	250 A	600 mm	■	■	–	8PQ6000-8BA35	8PQ2040-6BA26
		800 mm	■	■	–	8PQ6000-8BA43	8PQ2040-8BA23
3VA13	400 A	600 mm	■	■	–	8PQ6000-8BA54	8PQ2050-6BA11
		800 mm	■	■	–	8PQ6000-8BA57	8PQ2050-8BA14
3VA14	630 A	600 mm	■	■	–	8PQ6000-8BA54	8PQ2050-6BA11
		800 mm	■	■	–	8PQ6000-8BA57	8PQ2050-8BA14
3VA20	100 A	600 mm	■	■	–	8PQ6000-8BA37	8PQ2045-6BA11
		800 mm	■	■	–	8PQ6000-8BA50	8PQ2045-8BA11
3VA21	160 A	600 mm	■	■	–	8PQ6000-8BA37	8PQ2045-6BA11
		800 mm	■	■	–	8PQ6000-8BA50	8PQ2045-8BA11
3VA22	250 A	600 mm	■	■	–	8PQ6000-8BA37	8PQ2045-6BA11
		800 mm	■	■	–	8PQ6000-8BA50	8PQ2045-8BA11
3VA23	400 A	600 mm	■	■	–	8PQ6000-8BA54	8PQ2045-6BA12
		800 mm	■	■	–	8PQ6000-8BA57	8PQ2045-8BA13
3VA24	630 A	600 mm	■	■	–	8PQ6000-8BA54	8PQ2045-6BA12
		800 mm	■	■	–	8PQ6000-8BA57	8PQ2045-8BA13

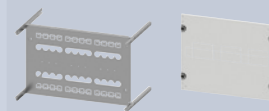
⊕ Fixed-mounted version with RCD		⊕ Plug-in version	
Device holders	Covers	Device holders	Covers
–	–	–	–
–	–	–	–
8PQ6000-8BA33	8PQ2045-6BA08	8PQ6000-8BA33	8PQ2035-6BA26
8PQ6000-8BA33	8PQ2045-6BA08	8PQ6000-8BA33	8PQ2035-6BA26
8PQ6000-8BA47	8PQ2045-8BA08	8PQ6000-8BA47	8PQ2035-8BA16
8PQ6000-8BA47	8PQ2045-8BA08	8PQ6000-8BA47	8PQ2035-8BA16
8PQ6000-8BA35	8PQ2050-6BA10	8PQ6000-8BA36	8PQ2040-6BA26
8PQ6000-8BA35	8PQ2050-6BA10	8PQ6000-8BA36	8PQ2040-6BA26
8PQ6000-8BA43	8PQ2050-8BA12	8PQ6000-8BA44	8PQ2040-8BA23
8PQ6000-8BA43	8PQ2050-8BA12	8PQ6000-8BA44	8PQ2040-8BA23
–	–	8PQ6000-8BA56	8PQ2055-6BA22
–	–	8PQ6000-8BA56	8PQ2055-6BA22
–	–	8PQ6000-8BA60	8PQ2055-8BA15
–	–	8PQ6000-8BA60	8PQ2055-8BA15
–	–	8PQ6000-8BA56	8PQ2055-6BA22
–	–	8PQ6000-8BA56	8PQ2055-6BA22
–	–	8PQ6000-8BA60	8PQ2055-8BA15
–	–	8PQ6000-8BA60	8PQ2055-8BA15
8PQ6000-8BA37	8PQ2055-6BA20	8PQ6000-8BA38	8PQ2045-6BA11
8PQ6000-8BA37	8PQ2055-6BA21	8PQ6000-8BA38	8PQ2045-6BA13
8PQ6000-8BA50	8PQ2055-8BA11	8PQ6000-8BA51	8PQ2045-8BA11
8PQ6000-8BA50	8PQ2055-8BA13	8PQ6000-8BA51	8PQ2045-8BA15
8PQ6000-8BA37	8PQ2055-6BA20	8PQ6000-8BA38	8PQ2045-6BA11
8PQ6000-8BA37	8PQ2055-6BA21	8PQ6000-8BA38	8PQ2045-6BA13
8PQ6000-8BA50	8PQ2055-8BA11	8PQ6000-8BA51	8PQ2045-8BA11
8PQ6000-8BA50	8PQ2055-8BA13	8PQ6000-8BA51	8PQ2045-8BA15
8PQ6000-8BA37	8PQ2055-6BA20	8PQ6000-8BA38	8PQ2045-6BA11
8PQ6000-8BA37	8PQ2055-6BA21	8PQ6000-8BA38	8PQ2045-6BA13
8PQ6000-8BA50	8PQ2055-8BA11	8PQ6000-8BA51	8PQ2045-8BA11
8PQ6000-8BA50	8PQ2055-8BA13	8PQ6000-8BA51	8PQ2045-8BA15
8PQ6000-8BA55	8PQ2060-6BA25	8PQ6000-8BA56	8PQ2045-6BA12
8PQ6000-8BA55	8PQ2060-6BA25	8PQ6000-8BA56	8PQ2045-6BA12
8PQ6000-8BA58	8PQ2060-8BA07	8PQ6000-8BA60	8PQ2045-8BA13
8PQ6000-8BA58	8PQ2060-8BA07	8PQ6000-8BA60	8PQ2045-8BA13
8PQ6000-8BA55	8PQ2060-6BA25	8PQ6000-8BA56	8PQ2045-6BA12
8PQ6000-8BA55	8PQ2060-6BA25	8PQ6000-8BA56	8PQ2045-6BA12
8PQ6000-8BA58	8PQ2060-8BA07	8PQ6000-8BA60	8PQ2045-8BA13
8PQ6000-8BA58	8PQ2060-8BA07	8PQ6000-8BA60	8PQ2045-8BA13

Section expansion

3VA molded case circuit breakers, 4-pole



Fixed-mounted version

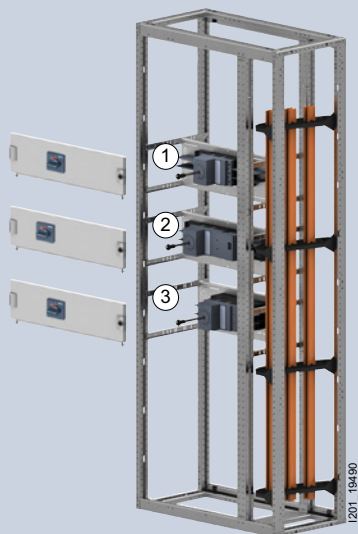


Type	I_n	Width	Operating mechanism			Device holders	Covers
			Direct	Rotary	Motorized		
3VA10	100 A	600 mm	■	■	–	8PQ6000-8BA34	8PQ2035-6BA27
		800 mm	■	■	–	8PQ6000-8BA48	8PQ2035-8BA17
3VA11	160 A	600 mm	■	■	–	8PQ6000-8BA34	8PQ2035-6BA27
		800 mm	–	–	■	8PQ6000-8BA34	8PQ2035-6BA27
			■	■	–	8PQ6000-8BA48	8PQ2035-8BA17
3VA12	250 A	600 mm	■	■	–	8PQ6000-8BA35	8PQ2040-6BA26
		800 mm	–	–	■	8PQ6000-8BA35	8PQ2040-6BA26
			■	■	–	8PQ6000-8BA45	8PQ2040-8BA24
3VA13	400 A	600 mm	■	■	–	8PQ6000-8BA64	8PQ2050-6BA12
		800 mm	–	–	■	8PQ6000-8BA64	8PQ2050-6BA12
			■	■	–	8PQ6000-8BA61	8PQ2050-8BA15
3VA14	630 A	600 mm	■	■	–	8PQ6000-8BA64	8PQ2050-6BA12
		800 mm	–	–	■	8PQ6000-8BA64	8PQ2050-6BA12
			■	■	–	8PQ6000-8BA61	8PQ2050-8BA15
3VA20	100 A	600 mm	■	■	–	8PQ6000-8BA37	8PQ2045-6BA11
		800 mm	–	–	■	8PQ6000-8BA37	8PQ2045-6BA13
			■	■	–	8PQ6000-8BA52	8PQ2045-8BA12
3VA21	160 A	600 mm	■	■	–	8PQ6000-8BA37	8PQ2045-6BA11
		800 mm	–	–	■	8PQ6000-8BA37	8PQ2045-6BA13
			■	■	–	8PQ6000-8BA52	8PQ2045-8BA12
3VA22	250 A	600 mm	■	■	–	8PQ6000-8BA37	8PQ2045-6BA11
		800 mm	–	–	■	8PQ6000-8BA37	8PQ2045-6BA13
			■	■	–	8PQ6000-8BA52	8PQ2045-8BA12
3VA23	400 A	600 mm	■	■	–	8PQ6000-8BA64	8PQ2045-6BA14
		800 mm	–	–	■	8PQ6000-8BA64	8PQ2045-6BA14
			■	■	–	8PQ6000-8BA61	8PQ2045-8BA14
3VA24	630 A	600 mm	■	■	–	8PQ6000-8BA64	8PQ2045-6BA14
		800 mm	–	–	■	8PQ6000-8BA64	8PQ2045-6BA14
			■	■	–	8PQ6000-8BA61	8PQ2045-8BA14
			–	–	■	8PQ6000-8BA61	8PQ2045-8BA14

Fixed-mounted version with RCD		Plug-in version	
Device holders	Covers	Device holders	Covers
–	–	–	–
–	–	–	–
8PQ6000-8BA34	8PQ2045-6BA10	8PQ6000-8BA34	8PQ2035-6BA27
8PQ6000-8BA34	8PQ2045-6BA10	8PQ6000-8BA34	8PQ2035-6BA27
8PQ6000-8BA48	8PQ2045-8BA10	8PQ6000-8BA48	8PQ2035-8BA17
8PQ6000-8BA48	8PQ2045-8BA10	8PQ6000-8BA48	8PQ2035-8BA17
8PQ6000-8BA35	8PQ2050-6BA10	8PQ6000-8BA36	8PQ2040-6BA26
8PQ6000-8BA35	8PQ2050-6BA10	8PQ6000-8BA36	8PQ2040-6BA26
8PQ6000-8BA45	8PQ2050-8BA13	8PQ6000-8BA46	8PQ2040-8BA24
8PQ6000-8BA45	8PQ2050-8BA13	8PQ6000-8BA46	8PQ2040-8BA24
–	–	8PQ6000-8BA66	8PQ2055-6BA23
–	–	8PQ6000-8BA66	8PQ2055-6BA23
–	–	8PQ6000-8BA63	8PQ2055-8BA16
–	–	8PQ6000-8BA63	8PQ2055-8BA16
–	–	8PQ6000-8BA66	8PQ2055-6BA23
–	–	8PQ6000-8BA66	8PQ2055-6BA23
–	–	8PQ6000-8BA63	8PQ2055-8BA16
–	–	8PQ6000-8BA63	8PQ2055-8BA16
8PQ6000-8BA37	8PQ2055-6BA20	8PQ6000-8BA38	8PQ2045-6BA11
8PQ6000-8BA37	8PQ2055-6BA21	8PQ6000-8BA38	8PQ2045-6BA13
8PQ6000-8BA52	8PQ2055-8BA12	8PQ6000-8BA53	8PQ2045-8BA12
8PQ6000-8BA52	8PQ2055-8BA14	8PQ6000-8BA53	8PQ2045-8BA16
8PQ6000-8BA37	8PQ2055-6BA20	8PQ6000-8BA38	8PQ2045-6BA11
8PQ6000-8BA37	8PQ2055-6BA21	8PQ6000-8BA38	8PQ2045-6BA13
8PQ6000-8BA52	8PQ2055-8BA12	8PQ6000-8BA53	8PQ2045-8BA12
8PQ6000-8BA52	8PQ2055-8BA14	8PQ6000-8BA53	8PQ2045-8BA16
8PQ6000-8BA37	8PQ2055-6BA20	8PQ6000-8BA38	8PQ2045-6BA11
8PQ6000-8BA37	8PQ2055-6BA21	8PQ6000-8BA38	8PQ2045-6BA13
8PQ6000-8BA52	8PQ2055-8BA12	8PQ6000-8BA53	8PQ2045-8BA12
8PQ6000-8BA52	8PQ2055-8BA14	8PQ6000-8BA53	8PQ2045-8BA16
8PQ6000-8BA65	8PQ2060-6BA26	8PQ6000-8BA66	8PQ2045-6BA14
8PQ6000-8BA65	8PQ2060-6BA26	8PQ6000-8BA66	8PQ2045-6BA14
8PQ6000-8BA62	8PQ2060-8BA08	8PQ6000-8BA63	8PQ2045-8BA14
8PQ6000-8BA62	8PQ2060-8BA08	8PQ6000-8BA63	8PQ2045-8BA14
8PQ6000-8BA65	8PQ2060-6BA26	8PQ6000-8BA66	8PQ2045-6BA14
8PQ6000-8BA65	8PQ2060-6BA26	8PQ6000-8BA66	8PQ2045-6BA14
8PQ6000-8BA62	8PQ2060-8BA08	8PQ6000-8BA63	8PQ2045-8BA14
8PQ6000-8BA62	8PQ2060-8BA08	8PQ6000-8BA63	8PQ2045-8BA14

Section expansion

3VA molded case circuit breakers, compartment door



3-pole

① Fixed-mounted

② Fixed-mounted version with RCD



Type	I_n	Width	Device holders	Compartment door	Device holders	Compartment door
3VA10	100 A	600 mm	8PQ6000-8BA01	8PQ2015-6BA31	–	–
		800 mm	8PQ6000-8BA02	8PQ2015-8BA12	–	–
3VA11	160 A	600 mm	8PQ6000-8BA01	8PQ2015-6BA31	8PQ6000-8BA01	8PQ2015-6BA33
		800 mm	8PQ6000-8BA02	8PQ2015-8BA12	8PQ6000-8BA02	8PQ2015-8BA12
3VA12	250 A	600 mm	8PQ6000-8BA03	8PQ2015-6BA34	8PQ6000-8BA03	8PQ2015-6BA35
		800 mm	8PQ6000-8BA07	8PQ2020-8BA22	8PQ6000-8BA07	8PQ2020-8BA22
3VA13	400 A	600 mm	8PQ6000-8BA23	8PQ2020-6BA46	–	–
		800 mm	8PQ6000-8BA27	8PQ2025-8BA15	–	–
3VA14	630 A	600 mm	8PQ6000-8BA23	8PQ2020-6BA46	–	–
		800 mm	8PQ6000-8BA27	8PQ2025-8BA15	–	–
3VA15	1000 A	800 mm	8PQ6001-4BA22	8PQ2045-8BA20	–	–
3VA20	100 A	600 mm	8PQ6000-8BA08	8PQ2020-6BA44	8PQ6000-8BA11	8PQ2020-6BA45
		800 mm	8PQ6000-8BA10	8PQ2020-8BA23	8PQ6000-8BA10	8PQ2020-8BA23
3VA21	160 A	600 mm	8PQ6000-8BA08	8PQ2020-6BA44	8PQ6000-8BA11	8PQ2020-6BA45
		800 mm	8PQ6000-8BA10	8PQ2020-8BA23	8PQ6000-8BA10	8PQ2020-8BA23
3VA22	250 A	600 mm	8PQ6000-8BA08	8PQ2020-6BA44	8PQ6000-8BA11	8PQ2020-6BA45
		800 mm	8PQ6000-8BA10	8PQ2020-8BA23	8PQ6000-8BA10	8PQ2020-8BA23
3VA23	400 A	600 mm	8PQ6000-8BA23	8PQ2020-6BA46	–	–
		800 mm	8PQ6000-8BA27	8PQ2025-8BA15	8PQ6000-8BA27	8PQ2025-8BA15
3VA24	630 A	600 mm	8PQ6000-8BA23	8PQ2020-6BA46	–	–
		800 mm	8PQ6000-8BA27	8PQ2025-8BA15	8PQ6000-8BA27	8PQ2025-8BA15
3VA25	1000 A	800 mm	8PQ6001-4BA22	8PQ2045-8BA20	–	–
3VA26	1250 A	800 mm	8PQ6001-4BA22	8PQ2045-8BA20	–	–
3VA27	1600 A	800 mm	8PQ6001-4BA23	8PQ2045-8BA21	–	–

4-pole

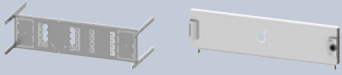
① Fixed-mounted

② Fixed-mounted version with RCD



Type	I_n	Width	Device holders	Compartment door	Device holders	Compartment door
3VA10	100 A	600 mm	8PQ6000-8BA01	8PQ2015-6BA31	–	–
		800 mm	8PQ6000-8BA02	8PQ2015-8BA12	–	–
3VA11	160 A	600 mm	8PQ6000-8BA01	8PQ2015-6BA31	8PQ6000-8BA01	8PQ2015-6BA33
		800 mm	8PQ6000-8BA02	8PQ2015-8BA12	8PQ6000-8BA02	8PQ2015-8BA12
3VA12	250 A	600 mm	8PQ6000-8BA05	8PQ2020-6BA42	8PQ6000-8BA05	8PQ2020-6BA43
		800 mm	8PQ6000-8BA07	8PQ2020-8BA22	8PQ6000-8BA07	8PQ2020-8BA22
3VA13	400 A	600 mm	8PQ6000-8BA25	8PQ2025-6BA24	–	–
		800 mm	8PQ6000-8BA27	8PQ2025-8BA15	–	–
3VA14	630 A	600 mm	8PQ6000-8BA25	8PQ2025-6BA24	–	–
		800 mm	8PQ6000-8BA27	8PQ2025-8BA15	–	–
3VA15	1000 A	800 mm	8PQ6001-4BA22	8PQ2045-8BA20	–	–
3VA20	100 A	600 mm	8PQ6000-8BA08	8PQ2020-6BA44	8PQ6000-8BA11	8PQ2020-6BA45
		800 mm	8PQ6000-8BA10	8PQ2020-8BA23	8PQ6000-8BA10	8PQ2020-8BA23
3VA21	160 A	600 mm	8PQ6000-8BA08	8PQ2020-6BA44	8PQ6000-8BA11	8PQ2020-6BA45
		800 mm	8PQ6000-8BA10	8PQ2020-8BA23	8PQ6000-8BA10	8PQ2020-8BA23
3VA22	250 A	600 mm	8PQ6000-8BA08	8PQ2020-6BA44	8PQ6000-8BA11	8PQ2020-6BA45
		800 mm	8PQ6000-8BA10	8PQ2020-8BA23	8PQ6000-8BA10	8PQ2020-8BA23
3VA23	400 A	600 mm	8PQ6000-8BA25	8PQ2025-6BA24	–	–
		800 mm	8PQ6000-8BA27	8PQ2025-8BA15	8PQ6000-8BA27	8PQ2025-8BA15
3VA24	630 A	600 mm	8PQ6000-8BA25	8PQ2025-6BA24	–	–
		800 mm	8PQ6000-8BA27	8PQ2025-8BA15	8PQ6000-8BA27	8PQ2025-8BA15
3VA25	1000 A	800 mm	8PQ6001-4BA22	8PQ2045-8BA20	–	–
3VA26	1250 A	800 mm	8PQ6001-4BA22	8PQ2045-8BA20	–	–
3VA27	1600 A	800 mm	8PQ6001-4BA23	8PQ2045-8BA21	–	–

Plug-in version



Device holders

Compartment door

–	–
–	–
8PQ6000-8BA01	8PQ2015-6BA31
8PQ6000-8BA02	8PQ2015-8BA12
8PQ6000-8BA04	8PQ2015-6BA34
8PQ6000-8BA07	8PQ2020-8BA22
–	–
8PQ6001-1BA02	8PQ2025-8BA23
–	–
8PQ6001-1BA02	8PQ2025-8BA23
–	–
8PQ6000-8BA08	8PQ2020-6BA44
8PQ6000-8BA10	8PQ2020-8BA23
8PQ6000-8BA08	8PQ2020-6BA44
8PQ6000-8BA10	8PQ2020-8BA23
8PQ6000-8BA08	8PQ2020-6BA44
8PQ6000-8BA10	8PQ2020-8BA23
–	–
8PQ6001-1BA02	8PQ2025-8BA23
–	–
8PQ6001-1BA02	8PQ2025-8BA23
–	–
–	–
–	–

Plug-in version



Device holders

Compartment door

–	–
–	–
8PQ6000-8BA01	8PQ2015-6BA31
8PQ6000-8BA02	8PQ2015-8BA12
8PQ6000-8BA06	8PQ2020-6BA42
8PQ6000-8BA07	8PQ2020-8BA22
–	–
8PQ6001-1BA02	8PQ2025-8BA23
–	–
8PQ6001-1BA02	8PQ2025-8BA23
–	–
8PQ6000-8BA08	8PQ2020-6BA44
8PQ6000-8BA10	8PQ2020-8BA23
8PQ6000-8BA08	8PQ2020-6BA44
8PQ6000-8BA10	8PQ2020-8BA23
8PQ6000-8BA08	8PQ2020-6BA44
8PQ6000-8BA10	8PQ2020-8BA23
–	–
8PQ6001-1BA02	8PQ2025-8BA23
–	–
8PQ6001-1BA02	8PQ2025-8BA23
–	–
–	–
–	–

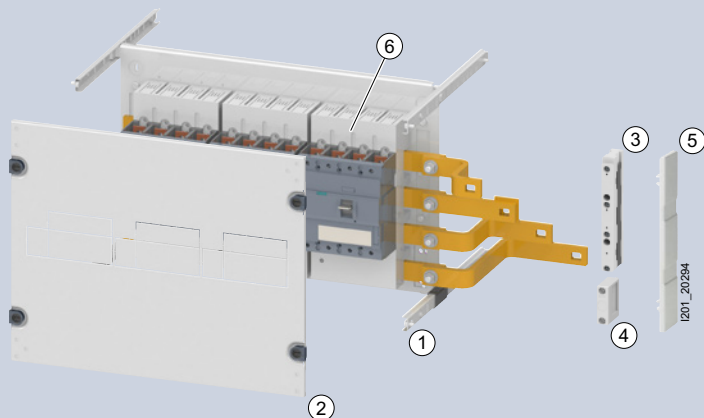
Accessories

Compartment ID strip for plug-in plates, H = 17 mm

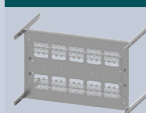
	Width	Scope of supply	Article No.
	600 mm	6 units	8PQ5000-3BA43
	800 mm	6 units	8PQ5000-3BA46

Section expansion

3VA molded case circuit breakers, 8US multiple feeders



3-pole



Type	I_n	Width	No. of switches/ breakers	Operating Direct	Rotary	Motorized	① Device holders	② Covers
3VA10	100 A	600 mm	5	■	■	–	8PQ6000-8BA33	8PQ2035-6BA26
		800 mm	7	■	■	–	8PQ6000-8BA40	8PQ2035-8BA20
3VA11	160 A	600 mm	5	■	■	■	8PQ6000-8BA33	8PQ2035-6BA26
		800 mm	7	■	■	■	8PQ6000-8BA40	8PQ2035-8BA20
3VA12	250 A	600 mm	3	■	■	■	8PQ6001-5BA68	8PQ2040-6BA26
		800 mm	5	■	■	■	8PQ6001-5BA72	8PQ2040-8BA23
3VA20	100 A	600 mm	3	■	■	–	8PQ6001-5BA71	8PQ2045-6BA11
			–	–	–	■	8PQ6001-5BA71	8PQ2045-6BA13
		800 mm	5	■	■	–	8PQ6001-5BA73	8PQ2045-8BA11
			–	–	–	■	8PQ6001-5BA73	8PQ2045-8BA15
3VA21	160 A	600 mm	3	■	■	–	8PQ6001-5BA71	8PQ2045-6BA11
			–	–	–	■	8PQ6001-5BA71	8PQ2045-6BA13
		800 mm	5	■	■	–	8PQ6001-5BA73	8PQ2045-8BA11
			–	–	–	■	8PQ6001-5BA73	8PQ2045-8BA15
3VA22	250 A	600 mm	3	■	■	–	8PQ6001-5BA71	8PQ2045-6BA11
			–	–	–	■	8PQ6001-5BA71	8PQ2045-6BA13
		800 mm	5	■	■	–	8PQ6001-5BA73	8PQ2045-8BA11
			–	–	–	■	8PQ6001-5BA73	8PQ2045-8BA15

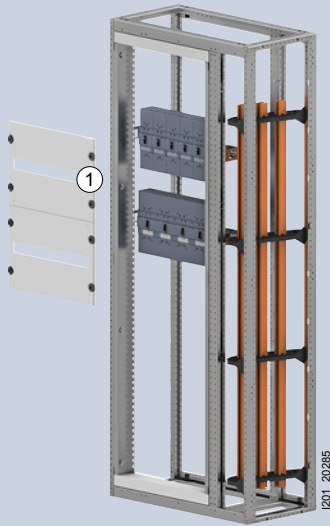
4-pole



Type	I_n	Width	No. of switches/ breakers	Operating Direct	Rotary	Motorized	① Device holders	② Covers
3VA12	250 A	600 mm	3	■	■	■	8PQ6001-5BA68	8PQ2040-6BA26
		800 mm	4	■	■	■	8PQ6001-5BA72	8PQ2040-8BA24
3VA20	100 A	600 mm	3	■	■	–	8PQ6001-5BA71	8PQ2045-6BA11
			–	–	–	■	8PQ6001-5BA71	8PQ2045-6BA13
		800 mm	4	■	■	–	8PQ6001-5BA73	8PQ2045-8BA12
			–	–	–	■	8PQ6001-5BA73	8PQ2045-8BA16
3VA21	160 A	600 mm	3	■	■	–	8PQ6001-5BA71	8PQ2045-6BA11
			–	–	–	■	8PQ6001-5BA71	8PQ2045-6BA13
		800 mm	4	■	■	–	8PQ6001-5BA73	8PQ2045-8BA12
			–	–	–	■	8PQ6001-5BA73	8PQ2045-8BA16
3VA22	250 A	600 mm	3	■	■	–	8PQ6001-5BA71	8PQ2045-6BA11
			–	–	–	■	8PQ6001-5BA71	8PQ2045-6BA13
		800 mm	4	■	■	–	8PQ6001-5BA73	8PQ2045-8BA12
			–	–	–	■	8PQ6001-5BA73	8PQ2045-8BA16

Section expansion

3VA molded case circuit breakers, DIN-rail mounting



3-pole

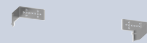
Type	I_n	No. of switches/ breakers	Width	Height	Operating mechanism		
					Direct	Rotary	Motorized
3VA10	100 A	5	600 mm	350 mm	■	–	–
		8	800 mm	350 mm	■	–	–
3VA11	160 A	4	600 mm	350 mm	■	–	–
		5	800 mm	350 mm	■	–	–

4-pole

Type	I_n	No. of switches/ breakers	Width	Height	Operating mechanism		
					Direct	Rotary	Motorized
3VA10	100 A	4	600 mm	350 mm	■	–	–
		6	800 mm	350 mm	■	–	–
3VA11	160 A	3	600 mm	350 mm	■	–	–
		4	800 mm	350 mm	■	–	–

Accessories

Cable duct fastening



Version	Article No.
Mounting brackets	8PQ6000-0BA16

Blanking strips



Types	Article No.
Length 1 m	8GK9910-0KK01

1 DIN-rail mounting



Device holders

Covers

8PQ6000-3BA36

8PQ2035-6BA28

8PQ6000-3BA37

8PQ2035-8BA18

8PQ6000-3BA36

8PQ2035-6BA28

8PQ6000-3BA37

8PQ2035-8BA18

1 DIN-rail mounting



Device holders

Covers

8PQ6000-3BA36

8PQ2035-6BA28

8PQ6000-3BA37

8PQ2035-8BA18

8PQ6000-3BA36

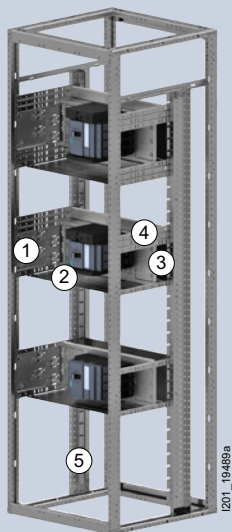
8PQ2035-6BA28

8PQ6000-3BA37

8PQ2035-8BA18

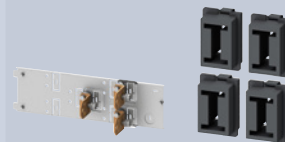
Section expansion

3VA molded case circuit breakers, internal separation – front connection










3-pole, width 600 mm

1 Cable connection

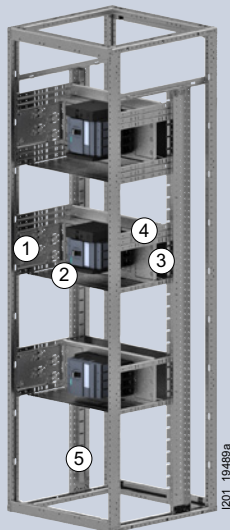


Type	I_n	Height	Operating mechanism	Operating mechanism			
				Direct	Rotary	Motorized	
3VA10	100 A	150 mm	Fixed-mounted	■	■	–	8PQ5000-2BA28 + 8PQ5000-0BA05
3VA11	160 A	150 mm	Fixed-mounted	■	■	■	8PQ5000-2BA28 + 8PQ5000-0BA05
			Plug-in	■	■	■	8PQ5000-2BA28 + 8PQ5000-0BA05
3VA12	250 A	150 mm	Fixed-mounted	■	■	–	8PQ6000-8BA12
			–	–	■	8PQ6000-8BA13	
			Plug-in	■	■	–	8PQ6000-8BA13
		–	–	■	8PQ6000-8BA12		
		250 mm	Withdrawable	■	–	■	8PQ6000-8BA12
3VA13	400 A	200 mm	Fixed-mounted	■	■	■	8PQ6000-8BA20
3VA14	630 A	200 mm	Fixed-mounted	■	■	■	8PQ6000-8BA20
3VA20	100 A	200 mm	Fixed-mounted	■	■	■	8PQ5000-2BA30 + 8PQ5000-0BA05
			Plug-in	■	■	■	8PQ5000-2BA30 + 8PQ5000-0BA05
			250 mm	Withdrawable	■	–	■
3VA21	100 A	200 mm	Fixed-mounted	■	■	■	8PQ5000-2BA30 + 8PQ5000-0BA05
			Plug-in	■	■	■	8PQ5000-2BA30 + 8PQ5000-0BA05
			250 mm	Withdrawable	■	–	■
3VA22	250 A	200 mm	Fixed-mounted	■	■	–	8PQ6000-8BA16
			–	–	■	8PQ6000-8BA17	
			Plug-in	■	■	–	8PQ6000-8BA17
		–	–	■	8PQ6000-8BA16		
		250 mm	Withdrawable	■	–	■	8PQ6000-8BA16
3VA23	400 A	200 mm	Fixed-mounted	■	■	–	8PQ6000-8BA20
			–	–	■	8PQ6000-8BA18	
3VA24	630 A	200 mm	Fixed-mounted	■	■	■	8PQ6000-8BA20
			–	–	–	8PQ6000-8BA18	

	⊖ Horizontal	⊖ Rear	⊕ Increase in module height	Horizontal with increase in module height	⊖ Plug-in rails	1600 mm	1800 mm
							
Protective bellows Form 4b						Busbar system	
					Top	Rear or without	
8PQ9400-0BA71	8PQ5000-2BA61	8PQ5000-4BA40	–	–	8PQ3000-0BA82	8PQ3000-0BA83	
8PQ9400-0BA71	8PQ5000-2BA61	8PQ5000-4BA40	–	–	8PQ3000-0BA82	8PQ3000-0BA83	
8PQ9400-0BA71	8PQ5000-2BA61	8PQ5000-4BA40	–	–	8PQ3000-0BA82	8PQ3000-0BA83	
8PQ9400-0BA71	8PQ5000-2BA61	8PQ5000-4BA40	–	–	8PQ3000-0BA82	8PQ3000-0BA83	
8PQ9400-0BA71	8PQ5000-2BA61	8PQ5000-4BA40	–	–	8PQ3000-0BA82	8PQ3000-0BA83	
8PQ9400-0BA71	8PQ5000-2BA61	8PQ5000-4BA40	–	–	8PQ3000-0BA82	8PQ3000-0BA83	
8PQ9400-0BA71	8PQ5000-2BA61	8PQ5000-4BA40	2 × 8PQ5000-4BA60	2 × 8PQ5000-4BA68	8PQ3000-0BA82	8PQ3000-0BA83	
8PQ9400-0BA71	8PQ5000-2BA61	8PQ5000-4BA41	–	–	8PQ3000-0BA82	8PQ3000-0BA83	
8PQ9400-0BA71	8PQ5000-2BA61	8PQ5000-4BA41	–	–	8PQ3000-0BA82	8PQ3000-0BA83	
8PQ9400-0BA71	8PQ5000-2BA61	8PQ5000-4BA41	–	–	8PQ3000-0BA82	8PQ3000-0BA83	
8PQ9400-0BA71	8PQ5000-2BA61	8PQ5000-4BA41	–	–	8PQ3000-0BA82	8PQ3000-0BA83	
8PQ9400-0BA71	8PQ5000-2BA61	8PQ5000-4BA41	8PQ5000-4BA62	8PQ5000-4BA70	8PQ3000-0BA82	8PQ3000-0BA83	
8PQ9400-0BA71	8PQ5000-2BA61	8PQ5000-4BA41	–	–	8PQ3000-0BA82	8PQ3000-0BA83	
8PQ9400-0BA71	8PQ5000-2BA61	8PQ5000-4BA41	–	–	8PQ3000-0BA82	8PQ3000-0BA83	
8PQ9400-0BA71	8PQ5000-2BA61	8PQ5000-4BA41	–	–	8PQ3000-0BA82	8PQ3000-0BA83	
8PQ9400-0BA71	8PQ5000-2BA61	8PQ5000-4BA41	–	–	8PQ3000-0BA82	8PQ3000-0BA83	
8PQ9400-0BA71	8PQ5000-2BA61	8PQ5000-4BA41	–	–	8PQ3000-0BA82	8PQ3000-0BA83	
8PQ9400-0BA71	8PQ5000-2BA61	8PQ5000-4BA41	–	–	8PQ3000-0BA82	8PQ3000-0BA83	
8PQ9400-0BA71	8PQ5000-2BA61	8PQ5000-4BA41	8PQ5000-4BA62	8PQ5000-4BA70	8PQ3000-0BA82	8PQ3000-0BA83	
8PQ9400-0BA71	8PQ5000-2BA61	8PQ5000-4BA41	–	–	8PQ3000-0BA82	8PQ3000-0BA83	
8PQ9400-0BA71	8PQ5000-2BA61	8PQ5000-4BA41	–	–	8PQ3000-0BA82	8PQ3000-0BA83	
8PQ9400-0BA71	8PQ5000-2BA61	8PQ5000-4BA41	–	–	8PQ3000-0BA82	8PQ3000-0BA83	
8PQ9400-0BA71	8PQ5000-2BA61	8PQ5000-4BA41	–	–	8PQ3000-0BA82	8PQ3000-0BA83	
8PQ9400-0BA71	8PQ5000-2BA61	8PQ5000-4BA41	–	–	8PQ3000-0BA82	8PQ3000-0BA83	

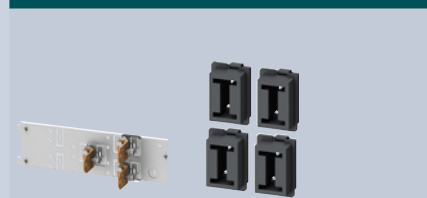
Section expansion

3VA molded case circuit breakers, internal separation – front connection





3-pole, width 800 mm

1 Cable connection

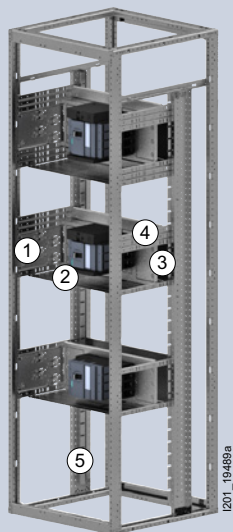


Type	I_n	Height		Operating mechanism			
				Direct	Rotary	Motorized	
3VA10	100 A	150 mm	Fixed-mounted	■	■	–	8PQ5000-2BA28 + 8PQ5000-0BA05
3VA11	160 A	150 mm	Fixed-mounted	■	■	■	8PQ5000-2BA28 + 8PQ5000-0BA05
			Plug-in	■	■	■	8PQ5000-2BA28 + 8PQ5000-0BA05
3VA12	250 A	200 mm	Fixed-mounted	■	■	■	8PQ5000-2BA30 + 8PQ5000-0BA05
			Plug-in	■	■	■	8PQ5000-2BA30 + 8PQ5000-0BA05
		250 mm	Withdrawable	■	–	■	8PQ6000-8BA14
3VA13	400 A	250 mm	Fixed-mounted	■	■	–	8PQ6000-8BA22
			Plug-in	■	■	■	8PQ6000-8BA21
		300 mm	Withdrawable	■	–	–	8PQ6000-8BA22
3VA14	630 A	250 mm	Fixed-mounted	■	■	–	8PQ6000-8BA22
			Plug-in	■	■	■	8PQ6000-8BA21
		300 mm	Withdrawable	■	–	–	8PQ6000-8BA22
3VA20	250 A	200 mm	Fixed-mounted	■	■	■	8PQ5000-2BA30 + 8PQ5000-0BA05
			Plug-in	■	■	■	8PQ5000-2BA30 + 8PQ5000-0BA05
		250 mm	Withdrawable	■	–	■	8PQ5000-2BA30 + 8PQ5000-0BA05
3VA21	250 A	200 mm	Fixed-mounted	■	■	■	8PQ5000-2BA30 + 8PQ5000-0BA05
			Plug-in	■	■	■	8PQ5000-2BA30 + 8PQ5000-0BA05
		250 mm	Withdrawable	■	–	■	8PQ5000-2BA30 + 8PQ5000-0BA05
3VA22	250 A	200 mm	Fixed-mounted	■	■	–	8PQ6000-8BA16
			Plug-in	■	■	■	8PQ6000-8BA17
		250 mm	Withdrawable	■	–	■	8PQ6000-8BA16
3VA23	400 A	250 mm	Fixed-mounted	■	■	–	8PQ6000-8BA22
			Plug-in	■	■	■	8PQ6000-8BA21
		300 mm	Withdrawable	■	–	–	8PQ6000-8BA22
3VA24	630 A	250 mm	Fixed-mounted	■	■	–	8PQ6000-8BA22
			Plug-in	■	■	■	8PQ6000-8BA21
		300 mm	Withdrawable	■	–	–	8PQ6000-8BA22

	Horizontal	Rear	Increase in module height	Plug-in rails	
				1600 mm	1800 mm
					
Protective bellows Form 4b				Busbar system	
				Top	Rear or without
8PQ9400-0BA71	8PQ5000-2BA62	–	–	8PQ3000-0BA82	8PQ3000-0BA83
8PQ9400-0BA71	8PQ5000-2BA62	–	–	8PQ3000-0BA82	8PQ3000-0BA83
8PQ9400-0BA71	8PQ5000-2BA62	–	–	8PQ3000-0BA82	8PQ3000-0BA83
8PQ9400-0BA71	8PQ5000-2BA62	8PQ5000-4BA48	–	8PQ3000-0BA82	8PQ3000-0BA83
8PQ9400-0BA71	8PQ5000-2BA62	8PQ5000-4BA48	–	8PQ3000-0BA82	8PQ3000-0BA83
8PQ9400-0BA71	8PQ5000-2BA62	8PQ5000-4BA48	8PQ5000-4BA61 + 8PQ5000-4BA71	8PQ3000-0BA82	8PQ3000-0BA83
8PQ9400-0BA71	8PQ5000-2BA62	8PQ5000-4BA50	–	8PQ3000-0BA82	8PQ3000-0BA83
8PQ9400-0BA71	8PQ5000-2BA62	8PQ5000-4BA50	–	8PQ3000-0BA82	8PQ3000-0BA83
8PQ9400-0BA71	8PQ5000-2BA62	8PQ5000-4BA50	–	8PQ3000-0BA82	8PQ3000-0BA83
8PQ9400-0BA71	8PQ5000-2BA62	8PQ5000-4BA50	8PQ5000-4BA63 + 8PQ5000-4BA72	8PQ3000-0BA82	8PQ3000-0BA83
8PQ9400-0BA71	8PQ5000-2BA62	8PQ5000-4BA50	–	8PQ3000-0BA82	8PQ3000-0BA83
8PQ9400-0BA71	8PQ5000-2BA62	8PQ5000-4BA50	–	8PQ3000-0BA82	8PQ3000-0BA83
8PQ9400-0BA71	8PQ5000-2BA62	8PQ5000-4BA50	–	8PQ3000-0BA82	8PQ3000-0BA83
8PQ9400-0BA71	8PQ5000-2BA62	8PQ5000-4BA50	8PQ5000-4BA63 + 8PQ5000-4BA72	8PQ3000-0BA82	8PQ3000-0BA83
8PQ9400-0BA71	8PQ5000-2BA62	8PQ5000-4BA48	–	8PQ3000-0BA82	8PQ3000-0BA83
8PQ9400-0BA71	8PQ5000-2BA62	8PQ5000-4BA48	–	8PQ3000-0BA82	8PQ3000-0BA83
8PQ9400-0BA71	8PQ5000-2BA62	8PQ5000-4BA48	8PQ5000-4BA63 + 8PQ5000-4BA72	8PQ3000-0BA82	8PQ3000-0BA83
8PQ9400-0BA71	8PQ5000-2BA62	8PQ5000-4BA48	–	8PQ3000-0BA82	8PQ3000-0BA83
8PQ9400-0BA71	8PQ5000-2BA62	8PQ5000-4BA48	–	8PQ3000-0BA82	8PQ3000-0BA83
8PQ9400-0BA71	8PQ5000-2BA62	8PQ5000-4BA48	–	8PQ3000-0BA82	8PQ3000-0BA83
8PQ9400-0BA71	8PQ5000-2BA62	8PQ5000-4BA48	8PQ5000-4BA63 + 8PQ5000-4BA72	8PQ3000-0BA82	8PQ3000-0BA83
8PQ9400-0BA71	8PQ5000-2BA62	8PQ5000-4BA50	–	8PQ3000-0BA82	8PQ3000-0BA83
8PQ9400-0BA71	8PQ5000-2BA62	8PQ5000-4BA50	–	8PQ3000-0BA82	8PQ3000-0BA83
8PQ9400-0BA71	8PQ5000-2BA62	8PQ5000-4BA50	–	8PQ3000-0BA82	8PQ3000-0BA83
8PQ9400-0BA71	8PQ5000-2BA62	8PQ5000-4BA50	8PQ5000-4BA63 + 8PQ5000-4BA72	8PQ3000-0BA82	8PQ3000-0BA83
8PQ9400-0BA71	8PQ5000-2BA62	8PQ5000-4BA50	–	8PQ3000-0BA82	8PQ3000-0BA83
8PQ9400-0BA71	8PQ5000-2BA62	8PQ5000-4BA50	–	8PQ3000-0BA82	8PQ3000-0BA83
8PQ9400-0BA71	8PQ5000-2BA62	8PQ5000-4BA50	–	8PQ3000-0BA82	8PQ3000-0BA83
8PQ9400-0BA71	8PQ5000-2BA62	8PQ5000-4BA50	8PQ5000-4BA63 + 8PQ5000-4BA72	8PQ3000-0BA82	8PQ3000-0BA83

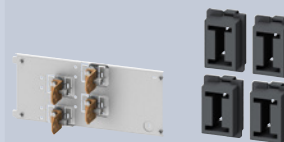
Section expansion

3VA molded case circuit breakers, internal separation – front connection






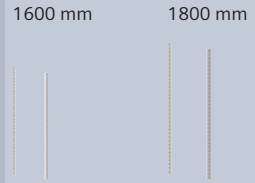


4-pole, width 600 mm

● Cable connection

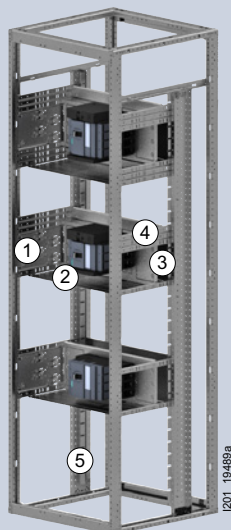


Type	I_n	Height		Operating mechanism			Terminals	
				Direct	Rotary	Motorized		
3VA10	100 A	150 mm	Fixed-mounted	■	■	–	8PQ5000-2BA28	+ 8PQ5000-0BA05
3VA11	160 A	150 mm	Fixed-mounted	■	■	■	8PQ5000-2BA28	+ 8PQ5000-0BA05
			Plug-in	■	■	■	8PQ5000-2BA28	+ 8PQ5000-0BA05
3VA12	250 A	200 mm	Fixed-mounted	■	■	–	8PQ6000-8BA14	
			Plug-in	–	–	■	8PQ6000-8BA15	
		300 mm	Plug-in	■	■	–	8PQ6000-8BA15	
			Withdrawable	–	–	■	8PQ6000-8BA14	
3VA13	400 A	250 mm	Fixed-mounted	■	■	–	8PQ6000-8BA22	
			Plug-in	–	–	■	8PQ6000-8BA21	
3VA14	630 A	250 mm	Fixed-mounted	■	■	–	8PQ6000-8BA22	
			Plug-in	–	–	■	8PQ6000-8BA21	
3VA20	250 A	200 mm	Fixed-mounted	■	■	■	8PQ5000-2BA30	+ 8PQ5000-0BA05
			Plug-in	■	■	–	8PQ5000-2BA30	+ 8PQ5000-0BA05
		300 mm	Withdrawable	–	–	■	8PQ5000-2BA30	+ 8PQ5000-0BA05
3VA21	250 A	200 mm	Fixed-mounted	■	■	■	8PQ5000-2BA30	+ 8PQ5000-0BA05
			Plug-in	■	■	–	8PQ5000-2BA30	+ 8PQ5000-0BA05
		300 mm	Withdrawable	–	–	■	8PQ5000-2BA30	+ 8PQ5000-0BA05
3VA22	250 A	200 mm	Fixed-mounted	■	■	–	8PQ6000-8BA16	
			Plug-in	–	–	■	8PQ6000-8BA17	
		300 mm	Plug-in	■	■	–	8PQ6000-8BA17	
			Withdrawable	–	–	■	8PQ6000-8BA17	
3VA23	400 A	250 mm	Fixed-mounted	■	■	–	8PQ6000-8BA22	
			Plug-in	–	–	■	8PQ6000-8BA21	
		300 mm	Plug-in	■	■	■	8PQ6000-8BA21	
3VA24	630 A	250 mm	Fixed-mounted	■	■	–	8PQ6000-8BA22	
			Plug-in	–	–	■	8PQ6000-8BA21	

		② Horizontal	③ Rear	④ Increase in module height	⑤ Plug-in rails		
							
4th pole	Protective bellows Form 4b					Busbar system	
						Top	Rear or without
	8PQ9400-0BA71	8PQ5000-2BA61	8PQ5000-4BA40	–		8PQ3000-0BA82	8PQ3000-0BA83
	8PQ9400-0BA71	8PQ5000-2BA61	8PQ5000-4BA40	–		8PQ3000-0BA82	8PQ3000-0BA83
	8PQ9400-0BA71	8PQ5000-2BA61	8PQ5000-4BA40	–		8PQ3000-0BA82	8PQ3000-0BA83
	8PQ9400-0BA71	8PQ5000-2BA61	8PQ5000-4BA41	–		8PQ3000-0BA82	8PQ3000-0BA83
	8PQ9400-0BA71	8PQ5000-2BA61	8PQ5000-4BA41	–		8PQ3000-0BA82	8PQ3000-0BA83
	8PQ9400-0BA71	8PQ5000-2BA61	8PQ5000-4BA41	–		8PQ3000-0BA82	8PQ3000-0BA83
	8PQ9400-0BA71	8PQ5000-2BA61	8PQ5000-4BA41	–		8PQ3000-0BA82	8PQ3000-0BA83
	8PQ9400-0BA71	8PQ5000-2BA61	8PQ5000-4BA41	2 × 8PQ5000-4BA60 + 2 × 8PQ5000-4BA68		8PQ3000-0BA82	8PQ3000-0BA83
	8PQ9400-0BA71	8PQ5000-2BA61	8PQ5000-4BA42	–		8PQ3000-0BA82	8PQ3000-0BA83
	8PQ9400-0BA71	8PQ5000-2BA61	8PQ5000-4BA42	–		8PQ3000-0BA82	8PQ3000-0BA83
	8PQ9400-0BA71	8PQ5000-2BA61	8PQ5000-4BA42	–		8PQ3000-0BA82	8PQ3000-0BA83
	8PQ9400-0BA71	8PQ5000-2BA61	8PQ5000-4BA42	–		8PQ3000-0BA82	8PQ3000-0BA83
	8PQ9400-0BA71	8PQ5000-2BA61	8PQ5000-4BA41	–		8PQ3000-0BA82	8PQ3000-0BA83
	8PQ9400-0BA71	8PQ5000-2BA61	8PQ5000-4BA41	–		8PQ3000-0BA82	8PQ3000-0BA83
	8PQ9400-0BA71	8PQ5000-2BA61	8PQ5000-4BA41	–		8PQ3000-0BA82	8PQ3000-0BA83
	8PQ9400-0BA71	8PQ5000-2BA61	8PQ5000-4BA41	–		8PQ3000-0BA82	8PQ3000-0BA83
	8PQ9400-0BA71	8PQ5000-2BA61	8PQ5000-4BA41	2 × 8PQ5000-4BA62 + 2 × 8PQ5000-4BA70		8PQ3000-0BA82	8PQ3000-0BA83
	8PQ9400-0BA71	8PQ5000-2BA61	8PQ5000-4BA41	–		8PQ3000-0BA82	8PQ3000-0BA83
	8PQ9400-0BA71	8PQ5000-2BA61	8PQ5000-4BA41	–		8PQ3000-0BA82	8PQ3000-0BA83
	8PQ9400-0BA71	8PQ5000-2BA61	8PQ5000-4BA41	–		8PQ3000-0BA82	8PQ3000-0BA83
+ 8PQ5000-4BA58	8PQ9400-0BA71	8PQ5000-2BA61	8PQ5000-4BA41	–		8PQ3000-0BA82	8PQ3000-0BA83
+ 8PQ5000-4BA58	8PQ9400-0BA71	8PQ5000-2BA61	8PQ5000-4BA41	–		8PQ3000-0BA82	8PQ3000-0BA83
+ 8PQ5000-4BA58	8PQ9400-0BA71	8PQ5000-2BA61	8PQ5000-4BA41	–		8PQ3000-0BA82	8PQ3000-0BA83
+ 8PQ5000-4BA58	8PQ9400-0BA71	8PQ5000-2BA61	8PQ5000-4BA41	–		8PQ3000-0BA82	8PQ3000-0BA83
+ 8PQ5000-4BA58	8PQ9400-0BA71	8PQ5000-2BA61	8PQ5000-4BA41	2 × 8PQ5000-4BA62 + 2 × 8PQ5000-4BA70		8PQ3000-0BA82	8PQ3000-0BA83
	8PQ9400-0BA71	8PQ5000-2BA61	8PQ5000-4BA42	–		8PQ3000-0BA82	8PQ3000-0BA83
	8PQ9400-0BA71	8PQ5000-2BA61	8PQ5000-4BA42	–		8PQ3000-0BA82	8PQ3000-0BA83
	8PQ9400-0BA71	8PQ5000-2BA61	8PQ5000-4BA42	–		8PQ3000-0BA82	8PQ3000-0BA83
	8PQ9400-0BA71	8PQ5000-2BA61	8PQ5000-4BA42	–		8PQ3000-0BA82	8PQ3000-0BA83
	8PQ9400-0BA71	8PQ5000-2BA61	8PQ5000-4BA42	–		8PQ3000-0BA82	8PQ3000-0BA83

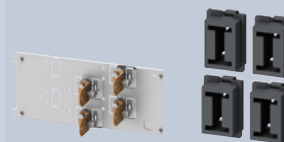
Section expansion

3VA molded case circuit breakers, internal separation – front connection



4-pole, width 800 mm

● Cable connection

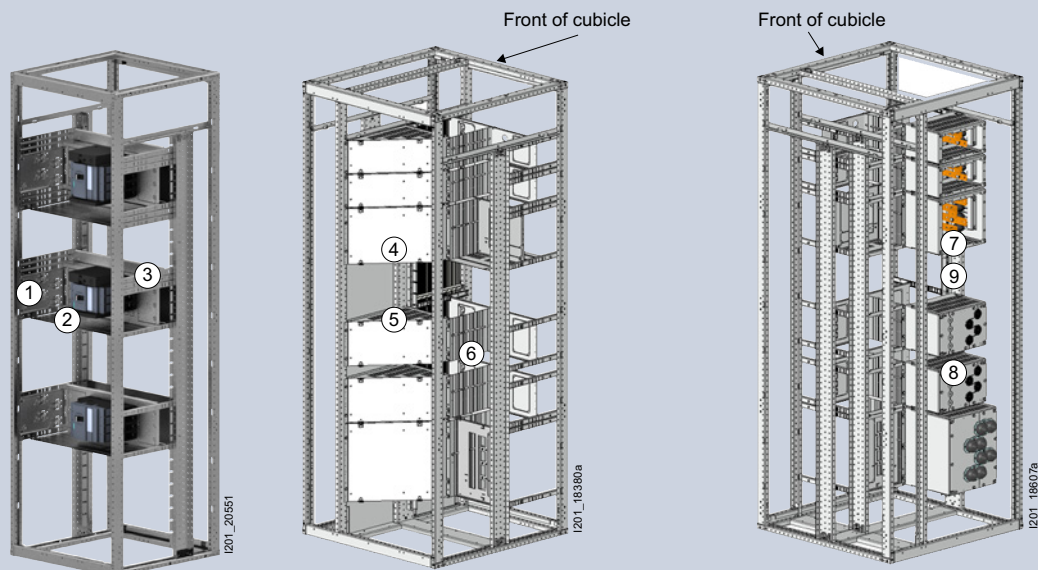


Type	I_n	Height		Operating mechanism			Terminals
				Direct	Rotary	Motorized	
3VA10	100 A	150 mm	Fixed-mounted	■	■	–	8PQ5000-2BA28 + 8PQ5000-0BA05
3VA11	160 A	150 mm	Fixed-mounted	■	■	■	8PQ5000-2BA28 + 8PQ5000-0BA05
			Plug-in	■	■	■	8PQ5000-2BA28 + 8PQ5000-0BA05
3VA12	250 A	200 mm	Fixed-mounted	■	■	–	8PQ6000-8BA14
			Plug-in	–	–	■	8PQ6000-8BA15
		300 mm	Fixed-mounted	–	–	■	8PQ6000-8BA14
			Withdrawable	■	–	■	8PQ6000-8BA14
3VA13	400 A	250 mm	Fixed-mounted	■	■	–	8PQ6000-8BA22
			Plug-in	–	–	■	8PQ6000-8BA21
		300 mm	Fixed-mounted	■	■	■	8PQ6000-8BA21
3VA14	630 A	250 mm	Fixed-mounted	■	■	–	8PQ6000-8BA22
			Plug-in	–	–	■	8PQ6000-8BA21
		300 mm	Fixed-mounted	■	■	■	8PQ6000-8BA21
3VA20	250 A	200 mm	Fixed-mounted	■	■	■	8PQ5000-2BA30 + 8PQ5000-0BA05
			Plug-in	■	■	■	8PQ5000-2BA30 + 8PQ5000-0BA05
		300 mm	Fixed-mounted	■	–	■	8PQ5000-2BA30 + 8PQ5000-0BA05
3VA21	250 A	200 mm	Fixed-mounted	■	■	■	8PQ5000-2BA30 + 8PQ5000-0BA05
			Plug-in	■	■	■	8PQ5000-2BA30 + 8PQ5000-0BA05
		300 mm	Fixed-mounted	■	–	■	8PQ5000-2BA30 + 8PQ5000-0BA05
3VA22	250 A	200 mm	Fixed-mounted	■	■	–	8PQ6000-8BA16
			Plug-in	–	–	■	8PQ6000-8BA17
		300 mm	Fixed-mounted	■	■	–	8PQ6000-8BA16
			Withdrawable	■	–	■	8PQ6000-8BA16
3VA23	400 A	250 mm	Fixed-mounted	■	■	–	8PQ6000-8BA22
			Plug-in	–	–	■	8PQ6000-8BA21
		300 mm	Fixed-mounted	■	■	■	8PQ6000-8BA21
3VA24	630 A	250 mm	Fixed-mounted	■	■	–	8PQ6000-8BA22
			Plug-in	–	–	■	8PQ6000-8BA21

		⊕ Horizontal	⊕ Rear	⊕ Increase in module height	⊕ Plug-in rails		
					1600 mm 	1800 mm 	
4th pole	Protective bellows Form 4b					Busbar system	
						Top	Rear or without
	8PQ9400-0BA71	8PQ5000-2BA62	–	–	8PQ3000-0BA82	8PQ3000-0BA83	
	8PQ9400-0BA71	8PQ5000-2BA62	–	–	8PQ3000-0BA82	8PQ3000-0BA83	
	8PQ9400-0BA71	8PQ5000-2BA62	–	–	8PQ3000-0BA82	8PQ3000-0BA83	
	8PQ9400-0BA71	8PQ5000-2BA62	8PQ5000-4BA48	–	8PQ3000-0BA82	8PQ3000-0BA83	
	8PQ9400-0BA71	8PQ5000-2BA62	8PQ5000-4BA48	–	8PQ3000-0BA82	8PQ3000-0BA83	
	8PQ9400-0BA71	8PQ5000-2BA62	8PQ5000-4BA48	–	8PQ3000-0BA82	8PQ3000-0BA83	
	8PQ9400-0BA71	8PQ5000-2BA62	8PQ5000-4BA48	–	8PQ3000-0BA82	8PQ3000-0BA83	
	8PQ9400-0BA71	8PQ5000-2BA62	8PQ5000-4BA48	2 × 8PQ5000-4BA61 + 2 × 8PQ5000-4BA71	8PQ3000-0BA82	8PQ3000-0BA83	
	8PQ9400-0BA71	8PQ5000-2BA62	8PQ5000-4BA50	–	8PQ3000-0BA82	8PQ3000-0BA83	
	8PQ9400-0BA71	8PQ5000-2BA62	8PQ5000-4BA50	–	8PQ3000-0BA82	8PQ3000-0BA83	
	8PQ9400-0BA71	8PQ5000-2BA62	8PQ5000-4BA50	–	8PQ3000-0BA82	8PQ3000-0BA83	
	8PQ9400-0BA71	8PQ5000-2BA62	8PQ5000-4BA50	8PQ5000-4BA63 + 8PQ5000-4BA72	8PQ3000-0BA82	8PQ3000-0BA83	
	8PQ9400-0BA71	8PQ5000-2BA62	8PQ5000-4BA50	–	8PQ3000-0BA82	8PQ3000-0BA83	
	8PQ9400-0BA71	8PQ5000-2BA62	8PQ5000-4BA50	–	8PQ3000-0BA82	8PQ3000-0BA83	
	8PQ9400-0BA71	8PQ5000-2BA62	8PQ5000-4BA50	8PQ5000-4BA63 + 8PQ5000-4BA72	8PQ3000-0BA82	8PQ3000-0BA83	
	8PQ9400-0BA71	8PQ5000-2BA62	8PQ5000-4BA48	–	8PQ3000-0BA82	8PQ3000-0BA83	
	8PQ9400-0BA71	8PQ5000-2BA62	8PQ5000-4BA48	–	8PQ3000-0BA82	8PQ3000-0BA83	
	8PQ9400-0BA71	8PQ5000-2BA62	8PQ5000-4BA48	2 × 8PQ5000-4BA63 + 2 × 8PQ5000-4BA72	8PQ3000-0BA82	8PQ3000-0BA83	
	8PQ9400-0BA71	8PQ5000-2BA62	8PQ5000-4BA48	–	8PQ3000-0BA82	8PQ3000-0BA83	
	8PQ9400-0BA71	8PQ5000-2BA62	8PQ5000-4BA48	–	8PQ3000-0BA82	8PQ3000-0BA83	
	8PQ9400-0BA71	8PQ5000-2BA62	8PQ5000-4BA48	–	8PQ3000-0BA82	8PQ3000-0BA83	
	8PQ9400-0BA71	8PQ5000-2BA62	8PQ5000-4BA48	2 × 8PQ5000-4BA63 + 2 × 8PQ5000-4BA72	8PQ3000-0BA82	8PQ3000-0BA83	
+ 8PQ5000-4BA58	8PQ9400-0BA71	8PQ5000-2BA62	8PQ5000-4BA48	–	8PQ3000-0BA82	8PQ3000-0BA83	
+ 8PQ5000-4BA58	8PQ9400-0BA71	8PQ5000-2BA62	8PQ5000-4BA48	–	8PQ3000-0BA82	8PQ3000-0BA83	
+ 8PQ5000-4BA58	8PQ9400-0BA71	8PQ5000-2BA62	8PQ5000-4BA48	–	8PQ3000-0BA82	8PQ3000-0BA83	
+ 8PQ5000-4BA58	8PQ9400-0BA71	8PQ5000-2BA62	8PQ5000-4BA48	–	8PQ3000-0BA82	8PQ3000-0BA83	
+ 8PQ5000-4BA58	8PQ9400-0BA71	8PQ5000-2BA62	8PQ5000-4BA48	2 × 8PQ5000-4BA63 + 2 × 8PQ5000-4BA72	8PQ3000-0BA82	8PQ3000-0BA83	
	8PQ9400-0BA71	8PQ5000-2BA62	8PQ5000-4BA50	–	8PQ3000-0BA82	8PQ3000-0BA83	
	8PQ9400-0BA71	8PQ5000-2BA62	8PQ5000-4BA50	–	8PQ3000-0BA82	8PQ3000-0BA83	
	8PQ9400-0BA71	8PQ5000-2BA62	8PQ5000-4BA50	–	8PQ3000-0BA82	8PQ3000-0BA83	
	8PQ9400-0BA71	8PQ5000-2BA62	8PQ5000-4BA50	–	8PQ3000-0BA82	8PQ3000-0BA83	
	8PQ9400-0BA71	8PQ5000-2BA62	8PQ5000-4BA50	–	8PQ3000-0BA82	8PQ3000-0BA83	

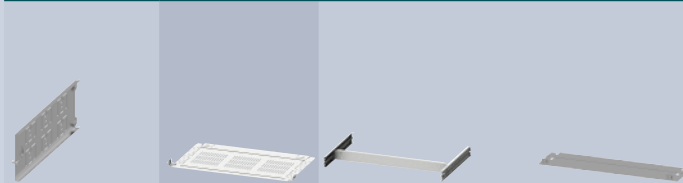
Section expansion

3VA molded case circuit breakers, internal separation – rear connection


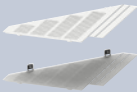
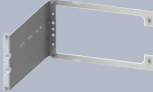
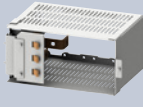

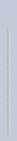



3-pole, width 600 mm

① Lateral ② Horizontal ③ Increase in module height

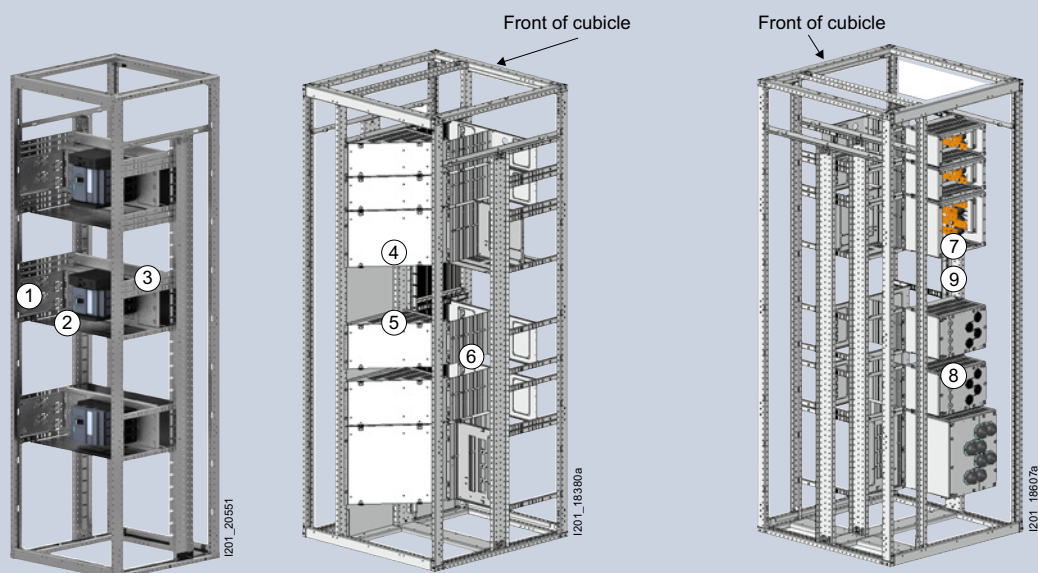


Type	I_n	Height	Operating mechanism	Operating mechanism			8PQ5000-2BA28	8PQ5000-2BA61	
				Direct	Rotary	Motorized			
3VA10	100 A	150 mm	Fixed-mounted	■	■	–	8PQ5000-2BA28	8PQ5000-2BA61	–
3VA11	160 A	150 mm	Fixed-mounted	■	■	–	8PQ5000-2BA28	8PQ5000-2BA61	–
			Plug-in	■	–	–	8PQ5000-2BA28	8PQ5000-2BA61	–
3VA12	250 A	150 mm	Fixed-mounted	■	■	■	8PQ5000-2BA28	8PQ5000-2BA61	–
			Plug-in	■	■	■	8PQ5000-2BA28	8PQ5000-2BA61	–
		250 mm	Withdrawable	■	–	■	8PQ5000-2BA28	8PQ5000-2BA61	2 × 8PQ5000-4BA60 + 2 × 8PQ5000-4BA68
3VA13	400 A	200 mm	Fixed-mounted	■	■	■	8PQ5000-2BA31	8PQ5000-2BA61	–
3VA14	630 A	200 mm	Fixed-mounted	■	■	■	8PQ5000-2BA31	8PQ5000-2BA61	–
3VA20	100 A	200 mm	Fixed-mounted	■	■	■	8PQ5000-2BA30	8PQ5000-2BA61	–
			Plug-in	■	■	■	8PQ5000-2BA30	8PQ5000-2BA61	–
		250 mm	Withdrawable	■	–	■	8PQ5000-2BA30	8PQ5000-2BA61	8PQ5000-4BA62 + 8PQ5000-4BA70
3VA21	160 A	200 mm	Fixed-mounted	■	■	■	8PQ5000-2BA30	8PQ5000-2BA61	–
			Plug-in	■	■	■	8PQ5000-2BA30	8PQ5000-2BA61	–
		250 mm	Withdrawable	■	–	■	8PQ5000-2BA30	8PQ5000-2BA61	8PQ5000-4BA62 + 8PQ5000-4BA70
3VA22	250 A	200 mm	Fixed-mounted	■	■	■	8PQ5000-2BA30	8PQ5000-2BA61	–
			Plug-in	■	■	■	8PQ5000-2BA30	8PQ5000-2BA61	–
		250 mm	Withdrawable	■	–	■	8PQ5000-2BA30	8PQ5000-2BA61	8PQ5000-4BA62 + 8PQ5000-4BA70
3VA23	400 A	200 mm	Fixed-mounted	■	■	■	8PQ5000-2BA31	8PQ5000-2BA61	–
3VA24	630 A	200 mm	Fixed-mounted	■	■	■	8PQ5000-2BA31	8PQ5000-2BA61	–

④ Vertical busbar connection		⑤ Segment covers		⑥ Support plates		⑦ Connection compartments		⑧ Cable entries		⑨ Plug-in rails	
										<div style="display: flex; justify-content: space-around;"> <div style="text-align: center;">1600 mm </div> <div style="text-align: center;">1800 mm </div> </div>	
										Busbar system	
										Top	Rear or without
8PQ5000-3BA52	8PQ5000-3BA63	8PQ5000-4BA73	8PQ6000-5BA13	8PQ5000-4BA80	8PQ3000-0BA82	8PQ3000-0BA83					
8PQ5000-3BA52	8PQ5000-3BA63	8PQ5000-4BA73	8PQ6000-5BA13	8PQ5000-4BA80	8PQ3000-0BA82	8PQ3000-0BA83					
8PQ5000-3BA52	8PQ5000-3BA63	8PQ5000-4BA73	8PQ6000-5BA13	8PQ5000-4BA80	8PQ3000-0BA82	8PQ3000-0BA83					
8PQ5000-3BA52	8PQ5000-3BA63	8PQ5000-4BA73	8PQ6000-5BA15	8PQ5000-3BA71	8PQ3000-0BA82	8PQ3000-0BA83					
8PQ5000-3BA52	8PQ5000-3BA63	8PQ5000-4BA73	8PQ6000-5BA15	8PQ5000-3BA71	8PQ3000-0BA82	8PQ3000-0BA83					
8PQ5000-3BA54	8PQ5000-3BA63	8PQ5000-4BA73	8PQ6000-5BA15	8PQ5000-3BA71	8PQ3000-0BA82	8PQ3000-0BA83					
8PQ5000-3BA53	8PQ5000-3BA63	8PQ5000-4BA74	8PQ6000-5BA18	8PQ5000-3BA73	8PQ3000-0BA82	8PQ3000-0BA83					
8PQ5000-3BA53	8PQ5000-3BA63	8PQ5000-4BA74	8PQ6000-5BA18	8PQ5000-3BA73	8PQ3000-0BA82	8PQ3000-0BA83					
8PQ5000-3BA53	8PQ5000-3BA63	8PQ5000-4BA74	8PQ6000-5BA14	8PQ5000-3BA72	8PQ3000-0BA82	8PQ3000-0BA83					
8PQ5000-3BA53	8PQ5000-3BA63	8PQ5000-4BA74	8PQ6000-5BA14	8PQ5000-3BA72	8PQ3000-0BA82	8PQ3000-0BA83					
8PQ5000-3BA53	8PQ5000-3BA63	8PQ5000-4BA74	8PQ6000-5BA14	8PQ5000-3BA72	8PQ3000-0BA82	8PQ3000-0BA83					
8PQ5000-3BA54	8PQ5000-3BA63	8PQ5000-4BA74	8PQ6000-5BA14	8PQ5000-3BA72	8PQ3000-0BA82	8PQ3000-0BA83					
8PQ5000-3BA53	8PQ5000-3BA63	8PQ5000-4BA74	8PQ6000-5BA14	8PQ5000-3BA72	8PQ3000-0BA82	8PQ3000-0BA83					
8PQ5000-3BA53	8PQ5000-3BA63	8PQ5000-4BA74	8PQ6000-5BA14	8PQ5000-3BA72	8PQ3000-0BA82	8PQ3000-0BA83					
8PQ5000-3BA54	8PQ5000-3BA63	8PQ5000-4BA74	8PQ6000-5BA14	8PQ5000-3BA72	8PQ3000-0BA82	8PQ3000-0BA83					
8PQ5000-3BA53	8PQ5000-3BA63	8PQ5000-4BA74	8PQ6000-8BA30	8PQ5000-3BA72	8PQ3000-0BA82	8PQ3000-0BA83					
8PQ5000-3BA53	8PQ5000-3BA63	8PQ5000-4BA74	8PQ6000-8BA30	8PQ5000-3BA72	8PQ3000-0BA82	8PQ3000-0BA83					
8PQ5000-3BA54	8PQ5000-3BA63	8PQ5000-4BA74	8PQ6000-8BA30	8PQ5000-3BA72	8PQ3000-0BA82	8PQ3000-0BA83					
8PQ5000-3BA53	8PQ5000-3BA63	8PQ5000-4BA74	8PQ6000-5BA18	8PQ5000-3BA73	8PQ3000-0BA82	8PQ3000-0BA83					
8PQ5000-3BA53	8PQ5000-3BA63	8PQ5000-4BA74	8PQ6000-5BA18	8PQ5000-3BA73	8PQ3000-0BA82	8PQ3000-0BA83					

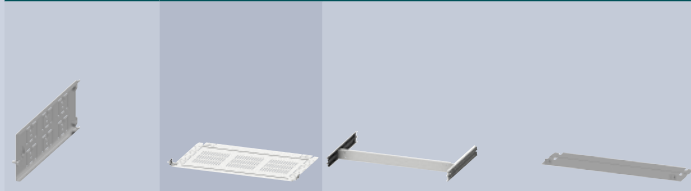
Section expansion

3VA molded case circuit breakers, internal separation – rear connection


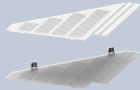
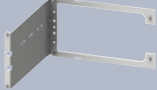
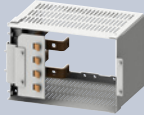





4-pole, width 600 mm

① Lateral ② Horizontal ③ Increase in module height

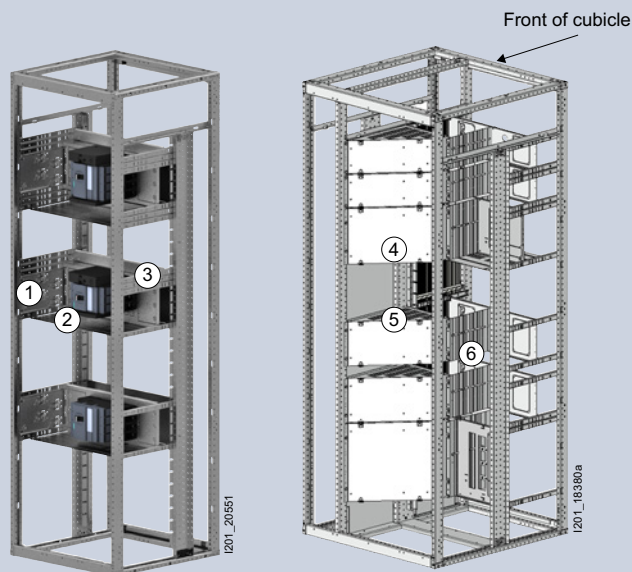


Type	I_n	Height	Operating mechanism	Operating mechanism			8PQ5000-2BA28	8PQ5000-2BA61	
				Direct	Rotary	Motorized			
3VA10	100 A	150 mm	Fixed-mounted	■	■	–	8PQ5000-2BA28	8PQ5000-2BA61	–
3VA11	160 A	150 mm	Fixed-mounted	■	■	■	8PQ5000-2BA28	8PQ5000-2BA61	–
			Plug-in	■	■	–	8PQ5000-2BA28	8PQ5000-2BA61	–
3VA12	250 A	200 mm	Fixed-mounted	■	■	■	8PQ5000-2BA30	8PQ5000-2BA61	–
			Plug-in	■	■	■	8PQ5000-2BA30	8PQ5000-2BA61	–
		300 mm	Withdrawable	■	–	■	8PQ5000-2BA30	8PQ5000-2BA61	2 × 8PQ5000-4BA60 + 2 × 8PQ5000-4BA68
3VA13	400 A	250 mm	Fixed-mounted	■	■	■	8PQ5000-2BA33	8PQ5000-2BA61	–
3VA14	630 A	250 mm	Fixed-mounted	■	■	■	8PQ5000-2BA33	8PQ5000-2BA61	–
3VA20	100 A	200 mm	Fixed-mounted	■	■	■	8PQ5000-2BA30	8PQ5000-2BA61	–
			Plug-in	■	■	■	8PQ5000-2BA30	8PQ5000-2BA61	–
		300 mm	Withdrawable	■	–	■	8PQ5000-2BA30	8PQ5000-2BA61	2 × 8PQ5000-4BA62 + 2 × 8PQ5000-4BA70
3VA21	160 A	200 mm	Fixed-mounted	■	■	■	8PQ5000-2BA30	8PQ5000-2BA61	–
			Plug-in	■	■	■	8PQ5000-2BA30	8PQ5000-2BA61	–
		300 mm	Withdrawable	■	–	■	8PQ5000-2BA30	8PQ5000-2BA61	2 × 8PQ5000-4BA62 + 2 × 8PQ5000-4BA70
3VA22	250 A	200 mm	Fixed-mounted	■	■	■	8PQ5000-2BA30	8PQ5000-2BA61	–
			Plug-in	■	■	■	8PQ5000-2BA30	8PQ5000-2BA61	–
		300 mm	Withdrawable	■	–	■	8PQ5000-2BA30	8PQ5000-2BA61	2 × 8PQ5000-4BA62 + 2 × 8PQ5000-4BA70
3VA23	400 A	250 mm	Fixed-mounted	■	■	■	8PQ5000-2BA33	8PQ5000-2BA61	–
3VA24	630 A	250 mm	Fixed-mounted	■	■	■	8PQ5000-2BA33	8PQ5000-2BA61	–

4 Vertical busbar connection		5 Segment covers		6 Support plates		7 Connection compartments		8 Cable entries		9 Plug-in rails	
										<div style="display: flex; justify-content: space-around;"> <div style="text-align: center;">1600 mm </div> <div style="text-align: center;">1800 mm </div> </div>	
										Busbar system	
										Top	Rear or without
8PQ5000-3BA52	8PQ5000-3BA63	8PQ5000-4BA73	8PQ6000-5BA13	8PQ5000-4BA80	8PQ3000-0BA82	8PQ3000-0BA83					
8PQ5000-3BA52	8PQ5000-3BA63	8PQ5000-4BA73	8PQ6000-5BA13	8PQ5000-4BA80	8PQ3000-0BA82	8PQ3000-0BA83					
8PQ5000-3BA52	8PQ5000-3BA63	8PQ5000-4BA73	8PQ6000-5BA13	8PQ5000-4BA80	8PQ3000-0BA82	8PQ3000-0BA83					
8PQ5000-3BA53	8PQ5000-3BA63	8PQ5000-4BA74	8PQ6000-5BA17	8PQ5000-3BA72	8PQ3000-0BA82	8PQ3000-0BA83					
8PQ5000-3BA53	8PQ5000-3BA63	8PQ5000-4BA74	8PQ6000-5BA17	8PQ5000-3BA72	8PQ3000-0BA82	8PQ3000-0BA83					
8PQ5000-3BA55	8PQ5000-3BA63	8PQ5000-4BA74	8PQ6000-5BA17	8PQ5000-3BA72	8PQ3000-0BA82	8PQ3000-0BA83					
8PQ5000-3BA54	8PQ5000-3BA63	8PQ5000-4BA75	8PQ6000-5BA20	8PQ5000-3BA74	8PQ3000-0BA82	8PQ3000-0BA83					
8PQ5000-3BA54	8PQ5000-3BA63	8PQ5000-4BA75	8PQ6000-5BA20	8PQ5000-3BA74	8PQ3000-0BA82	8PQ3000-0BA83					
8PQ5000-3BA53	8PQ5000-3BA63	8PQ5000-4BA74	8PQ6000-5BA14	8PQ5000-3BA72	8PQ3000-0BA82	8PQ3000-0BA83					
8PQ5000-3BA53	8PQ5000-3BA63	8PQ5000-4BA74	8PQ6000-5BA14	8PQ5000-3BA72	8PQ3000-0BA82	8PQ3000-0BA83					
8PQ5000-3BA55	8PQ5000-3BA63	8PQ5000-4BA74	8PQ6000-5BA14	8PQ5000-3BA72	8PQ3000-0BA82	8PQ3000-0BA83					
8PQ5000-3BA53	8PQ5000-3BA63	8PQ5000-4BA74	8PQ6000-5BA14	8PQ5000-3BA72	8PQ3000-0BA82	8PQ3000-0BA83					
8PQ5000-3BA53	8PQ5000-3BA63	8PQ5000-4BA74	8PQ6000-5BA14	8PQ5000-3BA72	8PQ3000-0BA82	8PQ3000-0BA83					
8PQ5000-3BA55	8PQ5000-3BA63	8PQ5000-4BA74	8PQ6000-5BA14	8PQ5000-3BA72	8PQ3000-0BA82	8PQ3000-0BA83					
8PQ5000-3BA53	8PQ5000-3BA63	8PQ5000-4BA74	8PQ6000-5BA17	8PQ5000-3BA72	8PQ3000-0BA82	8PQ3000-0BA83					
8PQ5000-3BA53	8PQ5000-3BA63	8PQ5000-4BA74	8PQ6000-5BA17	8PQ5000-3BA72	8PQ3000-0BA82	8PQ3000-0BA83					
8PQ5000-3BA55	8PQ5000-3BA63	8PQ5000-4BA74	8PQ6000-5BA17	8PQ5000-3BA72	8PQ3000-0BA82	8PQ3000-0BA83					
8PQ5000-3BA54	8PQ5000-3BA63	8PQ5000-4BA75	8PQ6000-5BA20	8PQ5000-3BA74	8PQ3000-0BA82	8PQ3000-0BA83					
8PQ5000-3BA54	8PQ5000-3BA63	8PQ5000-4BA75	8PQ6000-5BA20	8PQ5000-3BA74	8PQ3000-0BA82	8PQ3000-0BA83					

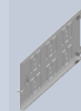
Section expansion

3VA molded case circuit breakers, internal separation – rear connection

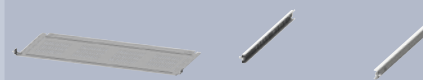


3-pole, width 800 mm


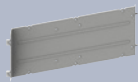

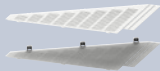

① Lateral



② Horizontal

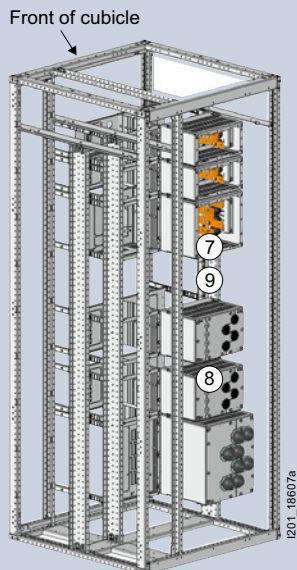


Type	I_n	Height		Operating mechanism				
				Direct	Rotary	Motorized		
3VA10	100 A	150 mm	Fixed-mounted	■	–	–	8PQ5000-2BA28	8PQ5000-2BA62
3VA11	160 A	150 mm	Fixed-mounted	■	–	–	8PQ5000-2BA28	8PQ5000-2BA62
			Plug-in	■	–	–	8PQ5000-2BA28	8PQ5000-2BA62
3VA12	250 A	200 mm	Fixed-mounted	■	■	■	8PQ5000-2BA30	8PQ5000-2BA62
			Plug-in	■	■	■	8PQ5000-2BA30	8PQ5000-2BA62
		250 mm	Withdrawable	■	–	–	8PQ5000-2BA30	8PQ5000-2BA62
3VA13	400 A	250 mm	Fixed-mounted	■	■	■	8PQ5000-2BA33	8PQ5000-2BA62
			Plug-in	■	–	–	8PQ5000-2BA33	8PQ5000-2BA62
		300 mm	Withdrawable	■	–	–	8PQ5000-2BA33	8PQ5000-2BA62
3VA14	630 A	250 mm	Fixed-mounted	■	■	■	8PQ5000-2BA33	8PQ5000-2BA62
			Plug-in	■	–	–	8PQ5000-2BA33	8PQ5000-2BA62
		300 mm	Withdrawable	■	–	–	8PQ5000-2BA33	8PQ5000-2BA62
3VA15	1000 A	300 mm	Fixed-mounted	■	–	–	8PQ5000-2BA62	+ 8PQ5000-2BA63
3VA20	100 A	200 mm	Fixed-mounted	■	■	■	8PQ5000-2BA30	8PQ5000-2BA62
			Plug-in	■	■	■	8PQ5000-2BA30	8PQ5000-2BA62
		250 mm	Withdrawable	■	–	–	8PQ5000-2BA30	8PQ5000-2BA62
3VA21	160 A	200 mm	Fixed-mounted	■	■	■	8PQ5000-2BA30	8PQ5000-2BA62
			Plug-in	■	■	■	8PQ5000-2BA30	8PQ5000-2BA62
		250 mm	Withdrawable	■	–	–	8PQ5000-2BA30	8PQ5000-2BA62
3VA22	250 A	200 mm	Fixed-mounted	■	■	■	8PQ5000-2BA30	8PQ5000-2BA62
			Plug-in	■	■	■	8PQ5000-2BA30	8PQ5000-2BA62
		250 mm	Withdrawable	■	–	–	8PQ5000-2BA30	8PQ5000-2BA62
3VA23	400 A	250 mm	Fixed-mounted	■	■	■	8PQ5000-2BA33	8PQ5000-2BA62
			Plug-in	■	■	■	8PQ5000-2BA33	8PQ5000-2BA62
		300 mm	Withdrawable	■	–	–	8PQ5000-2BA33	8PQ5000-2BA62
3VA24	630 A	250 mm	Fixed-mounted	■	■	■	8PQ5000-2BA33	8PQ5000-2BA62
			Plug-in	■	■	■	8PQ5000-2BA33	8PQ5000-2BA62
		300 mm	Withdrawable	■	–	–	8PQ5000-2BA33	8PQ5000-2BA62
3VA25	1000 A	300 mm	Fixed-mounted	■	–	–	8PQ5000-2BA62	+ 8PQ5000-2BA63
3VA26	1250 A	300 mm	Fixed-mounted	■	–	–	8PQ5000-2BA62	+ 8PQ5000-2BA63
3VA27	1600 A	300 mm	Fixed-mounted	■	–	–	8PQ5000-2BA62	+ 8PQ5000-2BA63
			Withdrawable	■	–	–	8PQ5000-2BA62	+ 8PQ5000-2BA63

③ Increase in module height		④ Vertical busbar connection		Distribution busbar	⑤ Segment covers	⑥ Support plates
						
-		8PQ5000-3BA57			8PQ5000-3BA64	8PQ5000-4BA76
-		8PQ5000-3BA57			8PQ5000-3BA64	8PQ5000-4BA76
-		8PQ5000-3BA57			8PQ5000-3BA64	8PQ5000-4BA76
-		8PQ5000-3BA58			8PQ5000-3BA64	8PQ5000-4BA77
-		8PQ5000-3BA58			8PQ5000-3BA64	8PQ5000-4BA77
8PQ5000-4BA61	+ 8PQ5000-4BA71	8PQ5000-3BA58			8PQ5000-3BA64	8PQ5000-4BA77
-		8PQ5000-3BA60			8PQ5000-3BA64	8PQ5000-4BA78
-		8PQ5000-3BA60			8PQ5000-3BA64	8PQ5000-4BA78
8PQ5000-4BA63	+ 8PQ5000-4BA72	8PQ5000-3BA60			8PQ5000-3BA64	8PQ5000-4BA78
-		8PQ5000-3BA60			8PQ5000-3BA64	8PQ5000-4BA78
-		8PQ5000-3BA60			8PQ5000-3BA64	8PQ5000-4BA78
8PQ5000-4BA63	+ 8PQ5000-4BA72	8PQ5000-3BA60			8PQ5000-3BA64	8PQ5000-4BA78
-		8PQ5000-5BA77	+ 8PQ6001-4BA64		8PQ5000-3BA64	8PQ5000-5BA75
-		8PQ5000-3BA58			8PQ5000-3BA64	8PQ5000-4BA77
-		8PQ5000-3BA58			8PQ5000-3BA64	8PQ5000-4BA77
8PQ5000-4BA63	+ 8PQ5000-4BA72	8PQ5000-3BA58			8PQ5000-3BA64	8PQ5000-4BA77
-		8PQ5000-3BA58			8PQ5000-3BA64	8PQ5000-4BA77
-		8PQ5000-3BA58			8PQ5000-3BA64	8PQ5000-4BA77
8PQ5000-4BA63	+ 8PQ5000-4BA72	8PQ5000-3BA58			8PQ5000-3BA64	8PQ5000-4BA77
-		8PQ5000-3BA58			8PQ5000-3BA64	8PQ5000-4BA77
-		8PQ5000-3BA58			8PQ5000-3BA64	8PQ5000-4BA77
8PQ5000-4BA63	+ 8PQ5000-4BA72	8PQ5000-3BA58			8PQ5000-3BA64	8PQ5000-4BA77
-		8PQ5000-3BA60			8PQ5000-3BA64	8PQ5000-4BA78
-		8PQ5000-3BA60			8PQ5000-3BA64	8PQ5000-4BA78
8PQ5000-4BA63	+ 8PQ5000-4BA72	8PQ5000-3BA60			8PQ5000-3BA64	8PQ5000-4BA78
-		8PQ5000-3BA60			8PQ5000-3BA64	8PQ5000-4BA78
-		8PQ5000-3BA60			8PQ5000-3BA64	8PQ5000-4BA78
8PQ5000-4BA63	+ 8PQ5000-4BA72	8PQ5000-3BA60			8PQ5000-3BA64	8PQ5000-4BA78
-		8PQ5000-5BA77	+ 8PQ6001-4BA64		8PQ5000-3BA64	8PQ5000-5BA75
-		8PQ5000-5BA77	+ 8PQ6001-4BA64		8PQ5000-3BA64	8PQ5000-5BA75
-		8PQ5000-5BA77	+ 8PQ6001-4BA65		8PQ5000-3BA64	8PQ5000-5BA75
-		8PQ5000-5BA77	+ 8PQ6001-4BA66		8PQ5000-3BA64	8PQ5000-5BA76

Section expansion

3VA molded case circuit breakers, internal separation – rear connection



3-pole, width 800 mm

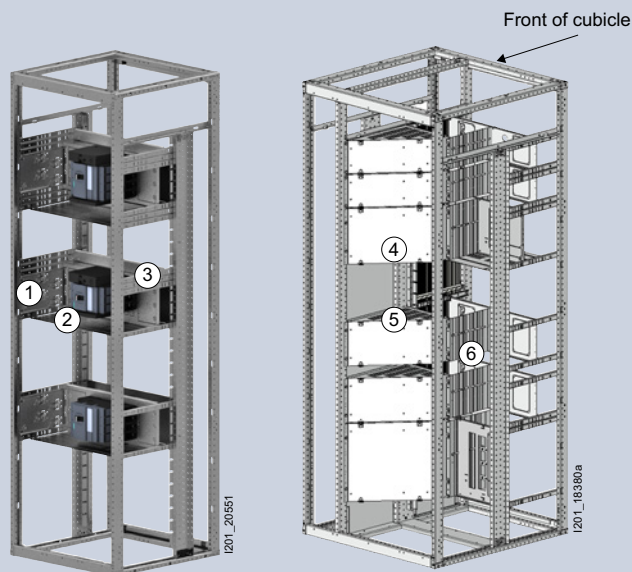
7 Connection compartments



Type	I_n	Height	Operating mechanism	Operating mechanism					
				Direct	Rotary	Motorized			
3VA10	100 A	150 mm	Fixed-mounted	■	–	–	8PQ6000-5BA13		
3VA11	160 A	150 mm	Fixed-mounted	■	–	–	8PQ6000-5BA13		
			Plug-in	■	–	–	8PQ6000-5BA13		
3VA12	250 A	200 mm	Fixed-mounted	■	■	■	8PQ6000-5BA17		
			Plug-in	■	■	■	8PQ6000-5BA17		
		250 mm	Withdrawable	■	–	–	8PQ6000-5BA17		
3VA13	400 A	250 mm	Fixed-mounted	■	■	■	8PQ6000-5BA20		
			Plug-in	■	–	–	8PQ6000-5BA20		
		300 mm	Withdrawable	■	–	–	8PQ6000-5BA20		
3VA14	630 A	250 mm	Fixed-mounted	■	■	■	8PQ6000-5BA20		
			Plug-in	■	–	–	8PQ6000-5BA20		
		300 mm	Withdrawable	■	–	–	8PQ6000-5BA20		
3VA15	1000 A	300 mm	Fixed-mounted	■	–	–	–	8PQ5000-5BA80	8PQ6001-4BA33
3VA20	100 A	200 mm	Fixed-mounted	■	■	■	8PQ6000-5BA14		
			Plug-in	■	■	■	8PQ6000-5BA14		
		250 mm	Withdrawable	■	–	–	8PQ6000-5BA14		
3VA21	160 A	200 mm	Fixed-mounted	■	■	■	8PQ6000-5BA14		
			Plug-in	■	■	■	8PQ6000-5BA14		
		250 mm	Withdrawable	■	–	–	8PQ6000-5BA14		
3VA22	250 A	200 mm	Fixed-mounted	■	■	■	8PQ6000-8BA30		
			Plug-in	■	■	■	8PQ6000-8BA30		
		250 mm	Withdrawable	■	–	–	8PQ6000-8BA30		
3VA23	400 A	250 mm	Fixed-mounted	■	■	■	8PQ6000-5BA20		
			Plug-in	■	■	■	8PQ6000-5BA20		
		300 mm	Withdrawable	■	–	–	8PQ6000-5BA20		
3VA24	630 A	250 mm	Fixed-mounted	■	■	■	8PQ6000-5BA20		
			Plug-in	■	■	■	8PQ6000-5BA20		
		300 mm	Withdrawable	■	–	–	8PQ6000-5BA20		
3VA25	1000 A	300 mm	Fixed-mounted	■	–	–	–	8PQ5000-5BA80	+ 8PQ6001-4BA33
3VA26	1250 A	300 mm	Fixed-mounted	■	–	–	–	8PQ5000-5BA80	+ 8PQ6001-4BA33
3VA27	1600 A	300 mm	Fixed-mounted	■	–	–	–	8PQ5000-5BA81	+ 8PQ6001-4BA34
			Withdrawable	■	–	–	–	8PQ5000-5BA81	+ 8PQ6001-4BA35

Section expansion

3VA molded case circuit breakers, internal separation – rear connection

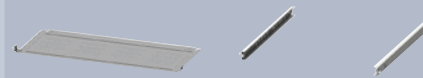


4-pole, width 800 mm

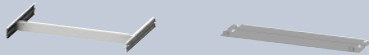
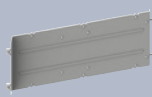

① Lateral



② Horizontal

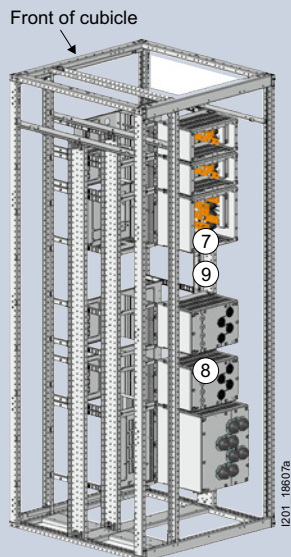


Type	I_n	Height		Operating mechanism					
				Direct	Rotary	Motorized			
3VA10	100 A	150 mm	Fixed-mounted	■	■	–	8PQ5000-2BA28	8PQ5000-2BA62	
3VA11	160 A	150 mm	Fixed-mounted	■	■	■	8PQ5000-2BA28	8PQ5000-2BA62	
			Plug-in	■	■	■	8PQ5000-2BA28	8PQ5000-2BA62	
3VA12	250 A	200 mm	Fixed-mounted	■	■	■	8PQ5000-2BA30	8PQ5000-2BA62	
			Plug-in	■	■	■	8PQ5000-2BA30	8PQ5000-2BA62	
			Withdrawable	■	–	–	8PQ5000-2BA30	8PQ5000-2BA62	
3VA13	400 A	250 mm	Fixed-mounted	■	■	■	8PQ5000-2BA33	8PQ5000-2BA62	
			Plug-in	■	–	–	8PQ5000-2BA33	8PQ5000-2BA62	
			Withdrawable	■	–	–	8PQ5000-2BA33	8PQ5000-2BA62	
3VA14	630 A	250 mm	Fixed-mounted	■	■	■	8PQ5000-2BA33	8PQ5000-2BA62	
			Plug-in	■	–	–	8PQ5000-2BA33	8PQ5000-2BA62	
			Withdrawable	■	–	–	8PQ5000-2BA33	8PQ5000-2BA62	
3VA15	1000 A	300 mm	Fixed-mounted	■	–	–	8PQ5000-2BA62	+ 8PQ5000-2BA63	
3VA20	100 A	200 mm	Fixed-mounted	■	■	■	8PQ5000-2BA30	8PQ5000-2BA62	
			Plug-in	■	■	■	8PQ5000-2BA30	8PQ5000-2BA62	
			Withdrawable	■	–	–	8PQ5000-2BA30	8PQ5000-2BA62	
3VA21	160 A	200 mm	Fixed-mounted	■	■	■	8PQ5000-2BA30	8PQ5000-2BA62	
			Plug-in	■	■	■	8PQ5000-2BA30	8PQ5000-2BA62	
			Withdrawable	■	–	–	8PQ5000-2BA30	8PQ5000-2BA62	
3VA22	250 A	200 mm	Fixed-mounted	■	■	■	8PQ5000-2BA30	8PQ5000-2BA62	
			Plug-in	■	■	■	8PQ5000-2BA30	8PQ5000-2BA62	
			Withdrawable	■	–	–	8PQ5000-2BA30	8PQ5000-2BA62	
3VA23	400 A	250 mm	Fixed-mounted	■	■	■	8PQ5000-2BA33	8PQ5000-2BA62	
			Plug-in	■	■	■	8PQ5000-2BA33	8PQ5000-2BA62	
			Withdrawable	■	–	–	8PQ5000-2BA33	8PQ5000-2BA62	
3VA24	630 A	250 mm	Fixed-mounted	■	■	■	8PQ5000-2BA33	8PQ5000-2BA62	
			Plug-in	■	■	■	8PQ5000-2BA33	8PQ5000-2BA62	
			Withdrawable	■	–	–	8PQ5000-2BA33	8PQ5000-2BA62	
3VA25	1000 A	300 mm	Fixed-mounted	■	–	–	8PQ5000-2BA62	+ 8PQ5000-2BA63	
3VA26	1250 A	300 mm	Fixed-mounted	■	–	–	8PQ5000-2BA62	+ 8PQ5000-2BA63	
3VA27	1600 A	300 mm	Fixed-mounted	■	–	–	–	8PQ5000-2BA62	+ 8PQ5000-2BA63
			Withdrawable	■	–	–	–	8PQ5000-2BA62	+ 8PQ5000-2BA63

③ Increase in module height	④ Vertical busbar connection	Distribution busbar	⑤ Segment covers	⑥ Support plates
				
–	8PQ5000-3BA57		8PQ5000-3BA64	8PQ5000-4BA76
–	8PQ5000-3BA57		8PQ5000-3BA64	8PQ5000-4BA76
–	8PQ5000-3BA57		8PQ5000-3BA64	8PQ5000-4BA76
–	8PQ5000-3BA58		8PQ5000-3BA64	8PQ5000-4BA77
–	8PQ5000-3BA58		8PQ5000-3BA64	8PQ5000-4BA77
2 × 8PQ5000-4BA61 + 2 × 8PQ5000-4BA71	8PQ5000-3BA58		8PQ5000-3BA64	8PQ5000-4BA77
–	8PQ5000-3BA60		8PQ5000-3BA64	8PQ5000-4BA78
–	8PQ5000-3BA60		8PQ5000-3BA64	8PQ5000-4BA78
8PQ5000-4BA63 + 8PQ5000-4BA72	8PQ5000-3BA60		8PQ5000-3BA64	8PQ5000-4BA78
–	8PQ5000-3BA60		8PQ5000-3BA64	8PQ5000-4BA78
–	8PQ5000-3BA60		8PQ5000-3BA64	8PQ5000-4BA78
8PQ5000-4BA63 + 8PQ5000-4BA72	8PQ5000-3BA60		8PQ5000-3BA64	8PQ5000-4BA78
–	8PQ5000-5BA77	+ 8PQ6001-4BA64	8PQ5000-3BA64	8PQ5000-5BA75
–	8PQ5000-3BA58		8PQ5000-3BA64	8PQ5000-4BA77
–	8PQ5000-3BA58		8PQ5000-3BA64	8PQ5000-4BA77
2 × 8PQ5000-4BA63 + 2 × 8PQ5000-4BA72	8PQ5000-3BA58		8PQ5000-3BA64	8PQ5000-4BA77
–	8PQ5000-3BA58		8PQ5000-3BA64	8PQ5000-4BA77
–	8PQ5000-3BA58		8PQ5000-3BA64	8PQ5000-4BA77
2 × 8PQ5000-4BA63 + 2 × 8PQ5000-4BA72	8PQ5000-3BA58		8PQ5000-3BA64	8PQ5000-4BA77
–	8PQ5000-3BA58		8PQ5000-3BA64	8PQ5000-4BA77
–	8PQ5000-3BA58		8PQ5000-3BA64	8PQ5000-4BA77
2 × 8PQ5000-4BA63 + 2 × 8PQ5000-4BA72	8PQ5000-3BA58		8PQ5000-3BA64	8PQ5000-4BA77
–	8PQ5000-3BA60		8PQ5000-3BA64	8PQ5000-4BA78
–	8PQ5000-3BA60		8PQ5000-3BA64	8PQ5000-4BA78
2 × 8PQ5000-4BA63 + 2 × 8PQ5000-4BA72	8PQ5000-3BA60		8PQ5000-3BA64	8PQ5000-4BA78
–	8PQ5000-3BA60		8PQ5000-3BA64	8PQ5000-4BA78
–	8PQ5000-3BA60		8PQ5000-3BA64	8PQ5000-4BA78
2 × 8PQ5000-4BA63 + 2 × 8PQ5000-4BA72	8PQ5000-3BA60		8PQ5000-3BA64	8PQ5000-4BA78
–	8PQ5000-5BA77	+ 8PQ6001-4BA64	8PQ5000-3BA64	8PQ5000-5BA75
–	8PQ5000-5BA77	+ 8PQ6001-4BA64	8PQ5000-3BA64	8PQ5000-5BA75
–	8PQ5000-5BA77	+ 8PQ6001-4BA65	8PQ5000-3BA64	8PQ5000-5BA75
–	8PQ5000-5BA77	+ 8PQ6001-4BA66	8PQ5000-3BA64	8PQ5000-5BA76

Section expansion

3VA molded case circuit breakers, internal separation – rear connection



4-pole, width 800 mm

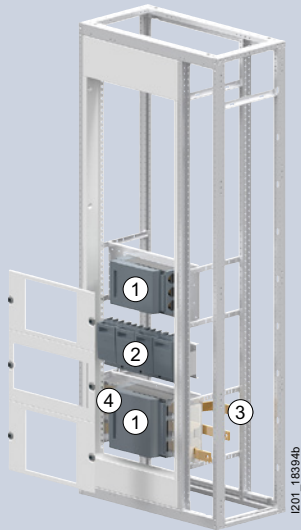
7 Connection compartments



Type	I_n	Height	Operating mechanism	Operating mechanism			
				Direct	Rotary	Motorized	
3VA10	100 A	150 mm	Fixed-mounted	■	■	–	8PQ6000-5BA13
3VA11	160 A	150 mm	Fixed-mounted	■	■	■	8PQ6000-5BA13
			Plug-in	■	■	■	8PQ6000-5BA13
3VA12	250 A	200 mm	Fixed-mounted	■	■	■	8PQ6000-5BA17
			Plug-in	■	■	■	8PQ6000-5BA17
		300 mm	Withdrawable	■	–	–	8PQ6000-5BA17
3VA13	400 A	250 mm	Fixed-mounted	■	■	■	8PQ6000-5BA20
			Plug-in	■	–	–	8PQ6000-5BA20
		300 mm	Withdrawable	■	–	–	8PQ6000-5BA20
3VA14	630 A	250 mm	Fixed-mounted	■	■	■	8PQ6000-5BA20
			Plug-in	■	–	–	8PQ6000-5BA20
		300 mm	Withdrawable	■	–	–	8PQ6000-5BA20
3VA15	1000 A	300 mm	Fixed-mounted	■	–	–	8PQ5000-5BA80 + 8PQ6001-4BA33
3VA20	100 A	200 mm	Fixed-mounted	■	■	■	8PQ6000-5BA14
			Plug-in	■	■	■	8PQ6000-5BA14
		300 mm	Withdrawable	■	–	–	8PQ6000-5BA14
3VA21	160 A	200 mm	Fixed-mounted	■	■	■	8PQ6000-5BA14
			Plug-in	■	■	■	8PQ6000-5BA14
		300 mm	Withdrawable	■	–	–	8PQ6000-5BA14
3VA22	250 A	200 mm	Fixed-mounted	■	■	■	8PQ6000-5BA17
			Plug-in	■	■	■	8PQ6000-5BA17
		300 mm	Withdrawable	■	–	–	8PQ6000-5BA17
3VA23	400 A	250 mm	Fixed-mounted	■	■	■	8PQ6000-5BA20
			Plug-in	■	■	■	8PQ6000-5BA20
		350 mm	Withdrawable	■	–	–	8PQ6000-5BA20
3VA24	630 A	250 mm	Fixed-mounted	■	■	■	8PQ6000-5BA20
			Plug-in	■	■	■	8PQ6000-5BA20
		350 mm	Withdrawable	■	–	–	8PQ6000-5BA20
3VA25	1000 A	300 mm	Fixed-mounted	■	–	–	8PQ5000-5BA80 + 8PQ6001-4BA33
3VA26	1250 A	300 mm	Fixed-mounted	■	–	–	8PQ5000-5BA80 + 8PQ6001-4BA33
3VA27	1600 A	300 mm	Fixed-mounted	■	–	–	8PQ5000-5BA81 + 8PQ6001-4BA34
			Withdrawable	■	–	–	8PQ5000-5BA81 + 8PQ6001-4BA35

Section expansion

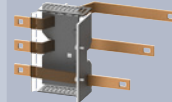
3NP1 fuse switch disconnectors, 3-pole



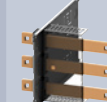
1 Horizontal



2 Section busbars



3 Cable connection



Switching device	Fuse	I_n	Width	Device holders	Covers	Form 3	Form 3
3NP1143	NH1	250 A	600 mm	8PQ6000-3BA75	8PQ2025-6BA16	8PQ6000-5BA68	8PQ6000-5BA72
3NP1153	NH2	400 A	600 mm	8PQ6000-3BA75	8PQ2025-6BA17	8PQ6000-5BA70	8PQ6000-5BA73
3NP1163	NH3	630 A	600 mm	8PQ6000-3BA77	8PQ2030-6BA22	8PQ6000-5BA71	8PQ6000-5BA74

3NP1 fuse switch disconnectors see page 8/84

 Vertical


Switching device	Fuse	I_n	Width	No. of switches/ breakers	Device holders	Covers
3NP1123	NH000	160 A	600 mm	4	8PQ6000-3BA78	8PQ2025-6BA18
			800 mm	6	8PQ6000-3BA82	8PQ2025-8BA10
3NP1133	NH00	160 A	600 mm	4	8PQ6000-3BA78	8PQ2030-6BA23
			800 mm	5	8PQ6000-3BA82	8PQ2030-8BA11

Section expansion

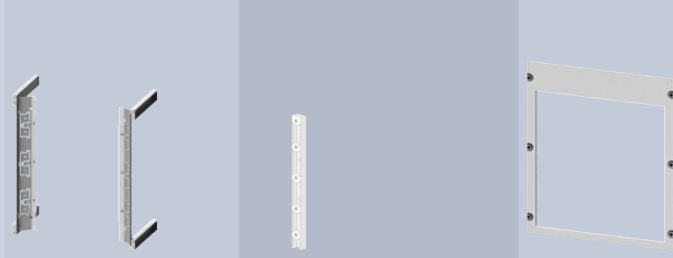
3NJ4 fuse switch disconnectors, 3-pole



Device holders

Busbar supports

Covers



Fuse	I_n	Width	No. of switches/breakers	Device holders	Busbar supports	Covers
NH1 – NH3	630 A	600 mm	4 × 100 mm	8PQ6000-2BA48	2 × 3NJ5974-0AB	8PQ2000-6BA06
		800 mm	6 × 100 mm	8PQ6000-2BA48	2 × 3NJ5974-0AB	8PQ2000-8BA06

Accessories

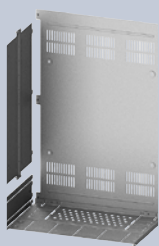
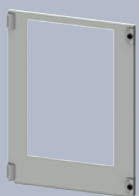
Blanking covers

Size	Width	Article No.
NH00	50 mm	3NJ4912-2AA00
NH1 – NH3	100 mm	3NJ4912-2BA00

3NJ4 fuse switch disconnectors see page 8/102

Compartment doors

Separation



Form 3b

horizontal

8PQ2080-6BA10

8PQ5000-1BA70

8PQ5000-2BA61

+ 8PQ5000-2BA63

8PQ2080-8BA05

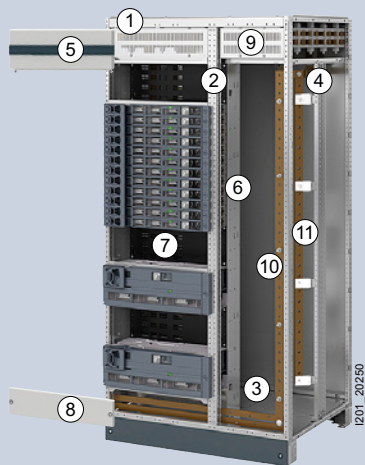
8PQ5000-1BA71

8PQ5000-2BA62

+ 8PQ5000-2BA63

Section expansion

3NJ6 switch disconnectors with fuses, 3 and 4-pole



1 Frames	2 Exterior intermediate uprights	3 Floor plate partition cross-bars	4 Uprights	5 Head compartment covers	6 3NJ6 device holder	7 Cover Distribution busbar
----------	----------------------------------	------------------------------------	------------	---------------------------	----------------------	-----------------------------



Width	Depth	Device compartment					3NJ6 device holder		Cover	
Device compartment 600 mm + cabling compartment 400 mm										
1000 mm	400 mm	8PQ1201-4BA02	8PQ3000-1BA43	1 × 8PQ3000-1BA38	8PQ3000-0BA65	8PQ2022-6BA01	8PQ3000-1BA48 +	6 × 3NJ6916-4EA00		
	600 mm	8PQ1201-6BA02	8PQ3000-1BA43	1 × 8PQ3000-1BA40	8PQ3000-0BA01	8PQ2022-6BA01	8PQ3000-1BA48 +	6 × 3NJ6916-4EA00		
	800 mm	8PQ1201-8BA03	8PQ3000-1BA43	2 × 8PQ3000-1BA38	8PQ3000-0BA02	8PQ2022-6BA01	8PQ3000-1BA48 +	6 × 3NJ6916-4EA00		
	800 mm duplex	8PQ1201-8BA03	8PQ3000-1BA43	2 × 8PQ3000-1BA38	8PQ3000-0BA02	8PQ2022-6BA01	8PQ3000-1BA48 +	6 × 3NJ6916-4EA00		
Device compartment 600 mm + cabling compartment 600 mm										
1200 mm	400 mm	8PQ1202-4BA02	8PQ3000-1BA43	1 × 8PQ3000-1BA38	8PQ3000-0BA65	8PQ2022-6BA01	8PQ3000-1BA48 +	6 × 3NJ6916-4EA00		
	600 mm	8PQ1202-6BA02	8PQ3000-1BA43	1 × 8PQ3000-1BA40	8PQ3000-0BA01	8PQ2022-6BA01	8PQ3000-1BA48 +	6 × 3NJ6916-4EA00		
	800 mm	8PQ1202-8BA02	8PQ3000-1BA43	2 × 8PQ3000-1BA38	8PQ3000-0BA02	8PQ2022-6BA01	8PQ3000-1BA48 +	6 × 3NJ6916-4EA00		
	800 mm duplex	8PQ1202-8BA02	8PQ3000-1BA43	2 × 8PQ3000-1BA38	8PQ3000-0BA02	8PQ2022-6BA01	8PQ3000-1BA48 +	6 × 3NJ6916-4EA00		

Accessories

Device compartments



Height	Article No.
200 mm	8PQ3000-1BA50
400 mm	8PQ3000-1BA51



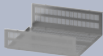



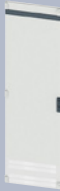
Blanking covers



Height	Article No.
50 mm	3NJ6900-4CB00

Technical specifications, distribution busbar

Cross-section	Rated operational current I_n , ventilated in A						
	20 °C	25 °C	30 °C	35 °C	40 °C	45 °C	50 °C
60 × 10 mm	1680	1640	1600	1560	1520	1480	1430
80 × 10 mm	2260	2210	2155	2100	2045	1985	1925

Device compartment		Cabling compartment						
⑧ Base compartment covers	⑨ Separation main busbar	⑩ Separation main busbar	⑪ PE elevation	⑫ N/PEN connection	⑬ Section doors with double-bit lock		⑭ for profile semicylinder	
								
					left	right	left	right
8PQ2000-6BA07	8PQ3000-1BA44	8PQ3000-0BA67	8PQ4000-2BA23	8PQ4000-2BA22	8PQ2197-4BA08	8PQ2197-4BA11	8PQ2197-4BA06	8PQ2197-4BA07
8PQ2000-6BA07	8PQ3000-1BA45	8PQ3000-0BA52	8PQ4000-2BA23	8PQ4000-2BA22	8PQ2197-4BA08	8PQ2197-4BA11	8PQ2197-4BA06	8PQ2197-4BA07
8PQ2000-6BA07	8PQ3000-1BA46	8PQ3000-0BA55	8PQ4000-2BA23	8PQ4000-2BA22	8PQ2197-4BA08	8PQ2197-4BA11	8PQ2197-4BA06	8PQ2197-4BA07
8PQ2000-6BA07	8PQ3000-1BA47	8PQ3000-0BA58	8PQ4000-2BA23	8PQ4000-2BA22	8PQ2197-4BA08	8PQ2197-4BA11	8PQ2197-4BA06	8PQ2197-4BA07
8PQ2000-6BA07	8PQ3000-1BA44	8PQ3000-0BA68	8PQ4000-2BA23	8PQ4000-2BA22	8PQ2197-6BA06	8PQ2197-6BA13	8PQ2197-6BA04	8PQ2197-6BA05
8PQ2000-6BA07	8PQ3000-1BA45	8PQ3000-0BA53	8PQ4000-2BA23	8PQ4000-2BA22	8PQ2197-6BA06	8PQ2197-6BA13	8PQ2197-6BA04	8PQ2197-6BA05
8PQ2000-6BA07	8PQ3000-1BA46	8PQ3000-0BA56	8PQ4000-2BA23	8PQ4000-2BA22	8PQ2197-6BA06	8PQ2197-6BA13	8PQ2197-6BA04	8PQ2197-6BA05
8PQ2000-6BA07	8PQ3000-6BA07	8PQ3000-0BA60	8PQ4000-2BA23	8PQ4000-2BA22	8PQ2197-6BA06	8PQ2197-6BA13	8PQ2197-6BA04	8PQ2197-6BA05

Terminal covers, form 4b

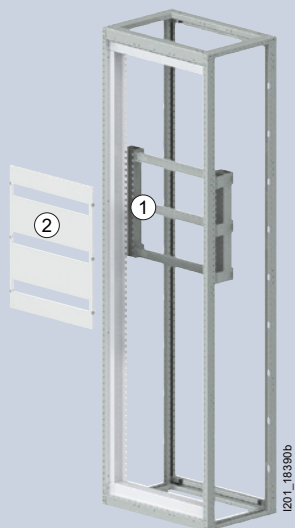


Size	Article No.
NH00	3NJ6923-1DA00
NH1	3NJ6933-1DA01
NH2 – NH3	3NJ6943-1DA00
4th pole for all sizes	3NJ6904-1DA00

3NJ63 switch disconnectors with fuses see page 8/136

Section expansion

Modular installation devices



Internal covers

1 Device holders

2 Covers



Width	MW	Tier spacing	Height	Device holders	Covers
600 mm	1 × 24	150 mm	150 mm	1 × 8PQ6000-3BA36	8PQ2015-6BA07
		200 mm	200 mm	1 × 8PQ6000-3BA36	8PQ2020-6BA12
800 mm	1 × 35	150 mm	150 mm	1 × 8PQ6000-3BA37	8PQ2015-8BA03
		200 mm	200 mm	1 × 8PQ6000-3BA37	8PQ2020-8BA05

1 Device holders

2 Covers



Width	MW	Tier spacing	Height	Device holders	Covers
600 mm	2 × 24	150 mm	300 mm	2 × 8PQ6000-3BA36	8PQ2030-6BA07
		200 mm	400 mm	2 × 8PQ6000-3BA36	8PQ2040-6BA10
800 mm	2 × 35	150 mm	300 mm	2 × 8PQ6000-3BA37	8PQ2030-8BA03
		200 mm	400 mm	2 × 8PQ6000-3BA37	8PQ2040-8BA10

1 Device holders

2 Covers



Width	MW	Tier spacing	Height	Device holders	Covers
600 mm	3 × 24	150 mm	450 mm	3 × 8PQ6000-3BA36	8PQ2045-6BA04
		200 mm	600 mm	3 × 8PQ6000-3BA36	8PQ2060-6BA04
800 mm	3 × 35	150 mm	450 mm	3 × 8PQ6000-3BA37	8PQ2045-8BA02
		200 mm	600 mm	3 × 8PQ6000-3BA37	8PQ2060-8BA02

Compartment doors

1 Device holders

2 Covers



Width	MW	Tier spacing	Height	Device holders	Covers
600 mm	1 × 24	200 mm	200 mm	1 × 8PQ6000-6BA52	8PQ2020-6BA28
800 mm	1 × 35	200 mm	200 mm	1 × 8PQ6000-6BA53	8PQ2020-8BA14

Accessories

Cable duct fastening



Version	Article No.
Mounting brackets	8PQ6000-0BA16

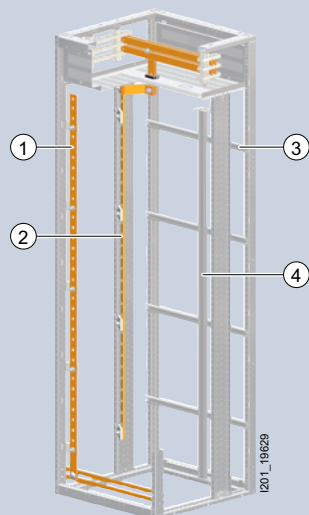
Blanking strips



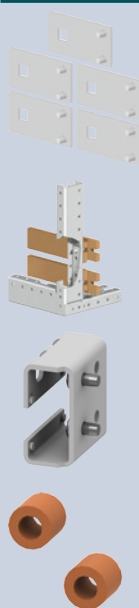
Types	Article No.
Length 1 m	8GK9910-0KK01

Section expansion

Cable section



1 PE bars



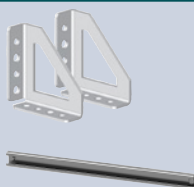
Version	Scope of supply	Article No.
Busbar supports	5 units	8PQ4000-2BA23
Frame connection	6 units	8PQ4000-0BA82
PE connection, cable	6 units	8PQ4000-2BA58
Spacer	2 units	8PQ4000-3BA01

2 N/PEN connection



Version	Article No.
Busbar supports and connection terminals	8PQ4000-2BA22

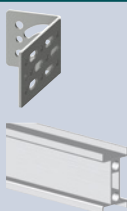
3 Cable clamping rail



Version	Scope of supply	Article No.
Holders	10 units	8PQ3000-0BA73

Version	Width	Depth	Scope of supply	Article No.
C 30 x 15 mm	400 mm	–	5 units	8PQ3000-0BA41
	600 mm	–	5 units	8PQ3000-0BA42
	800 mm	–	5 units	8PQ3000-0BA43
	–	400 mm	5 units	8PQ3000-0BA38

4 DIN rail outgoing terminals

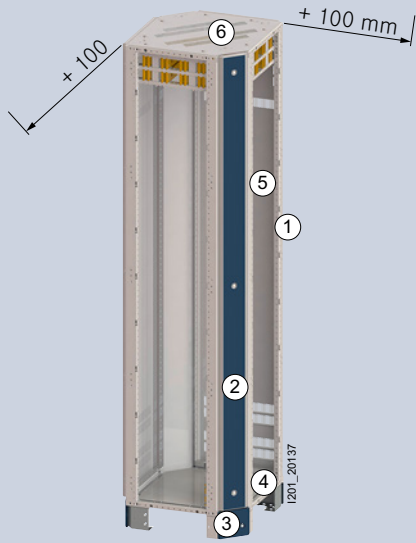


Version	Scope of supply	Article No.
Universal brackets	10 units	8PQ9400-0BA01

Length	DIN rail	Article No.
1600 mm	35 mm	8PQ9600-0BA01

Section expansion

Corner sections



Position of main busbar

At top

1 Frames

2 Conversion kits

3 Base corner pieces

4 Floor plates

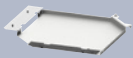


Depth			Height		IP55
			100 mm	200 mm	
400 mm	8PQ1204-4BA01	+ 8PQ1200-0BA03	8PQ1010-0BA04	8PQ1024-4BA01	8PQ2304-4BA12
600 mm	8PQ1206-6BA01	+ 8PQ1200-0BA03	8PQ1010-0BA05	8PQ1026-6BA01	8PQ2306-6BA12
800 mm	8PQ1208-8BA01	+ 8PQ1200-0BA03	8PQ1018-8BA01	8PQ1028-8BA01	8PQ2308-8BA08

At bottom

⊖ Rear panels

⊖ Roof plates



IP20

IP40

IP55

IP40

IP55

IPX1

8PQ2300-4BA25

2 × 8PQ2420-4BA02

2 × 8PQ2420-4BA01

8PQ2304-4BA10

8PQ2304-4BA08

8PQ2304-4BA11

8PQ2300-6BA27

2 × 8PQ2420-6BA02

2 × 8PQ2420-6BA01

8PQ2306-6BA10

8PQ2306-6BA08

8PQ2306-6BA11

8PQ2300-8BA14

2 × 8PQ2420-8BA02

2 × 8PQ2420-8BA01

8PQ2308-8BA06

8PQ2308-8BA05

8PQ2308-8BA07

Section expansion

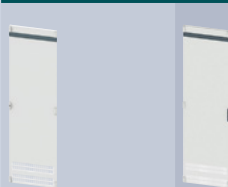
Mounting plates



Position of main busbar

At rear
Without

1 Doors



2 Inner doors

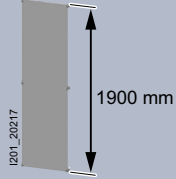

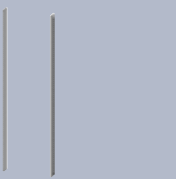
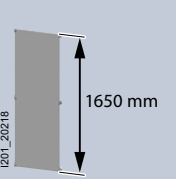
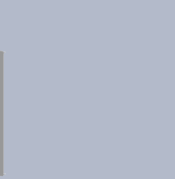




Degree of protection	Width	Door with double-bit lock	Door for profile semicylinders	Inner door struts	Inner doors	Inner door struts
IP40	400 mm	8PQ2197-4BA08	8PQ2197-4BA06	8PQ2197-0BA10	–	–
	600 mm	8PQ2197-6BA06	8PQ2197-6BA04	8PQ2197-0BA10	8PQ2000-6BA05	2 × 8PQ2080-0BA07
	800 mm	8PQ2197-8BA06	8PQ2197-8BA04	8PQ2197-0BA10	8PQ2000-8BA05	2 × 8PQ2080-0BA07
	1000 mm	8PQ2197-1BA06	8PQ2197-1BA07	8PQ2197-0BA10	8PQ2000-1BA01	2 × 8PQ2080-0BA07
	1000 mm – Double doors	8PQ2197-1BA14	8PQ2197-1BA16	8PQ2197-0BA10	–	–
	1200 mm – Double doors	8PQ2197-2BA11	8PQ2197-2BA13	8PQ2197-0BA10	–	–
IP55	400 mm	8PQ2197-4BA05	8PQ2197-4BA03	8PQ2197-0BA10	–	–
	600 mm	8PQ2197-6BA03	8PQ2197-6BA01	8PQ2197-0BA10	8PQ2000-6BA05	2 × 8PQ2080-0BA07
	800 mm	8PQ2197-8BA03	8PQ2197-8BA01	8PQ2197-0BA10	8PQ2000-8BA05	2 × 8PQ2080-0BA07
	1000 mm	8PQ2197-1BA03	8PQ2197-1BA04	8PQ2197-0BA10	8PQ2000-1BA01	2 × 8PQ2080-0BA07
	1000 mm – Double doors	8PQ2197-1BA13	8PQ2197-1BA15	8PQ2197-0BA10	–	–
	1200 mm – Double doors	8PQ2197-2BA10	8PQ2197-2BA12	8PQ2197-0BA10	–	–

Modular mounting plates



Height	Width		
	400 mm	600 mm	800 mm
150 mm	8PQ3000-2BA60	8PQ3000-2BA62	8PQ3000-2BA64
200 mm	8PQ3000-2BA17	8PQ3000-1BA56	8PQ3000-1BA58
250 mm	–	8PQ3000-3BA63	8PQ3000-3BA64
300 mm	8PQ3000-2BA66	8PQ3000-2BA51	8PQ3000-2BA53
400 mm	8PQ3000-2BA18	8PQ3000-1BA61	8PQ3000-1BA63
500 mm	–	8PQ3000-3BA76	8PQ3000-3BA77
550 mm	8PQ3000-3BA65	8PQ3000-3BA07	8PQ3000-3BA08
600 mm	8PQ3000-2BA21	8PQ3000-1BA65	8PQ3000-1BA67
700 mm	–	8PQ3000-3BA78	8PQ3000-3BA80
800 mm	8PQ3000-2BA23	8PQ3000-1BA26	8PQ3000-1BA28

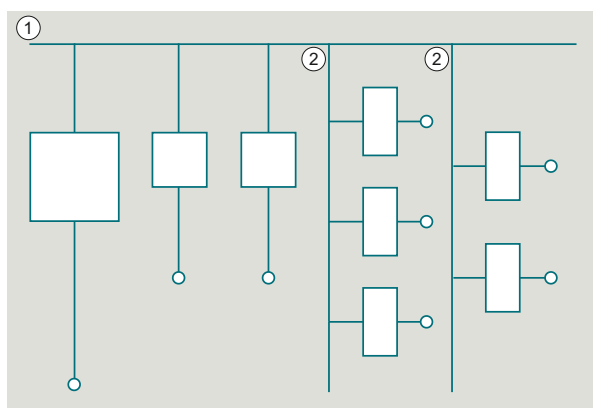
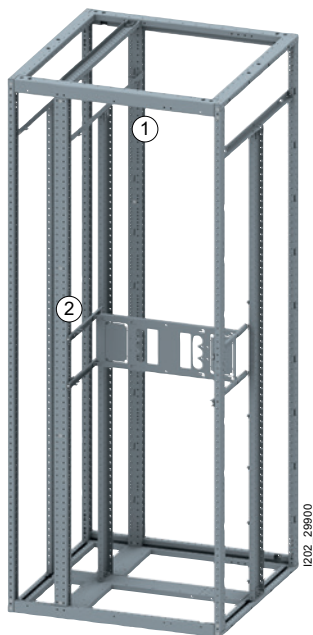
⊖ Mounting plates			At top			
⊖ Mounting plates		⊖ Uprights	⊖ Mounting plates		⊖ Uprights	
						
Mounting plates	Connecting panels	Depth 600 mm, 800 mm	Mounting plates	Connecting panels	Depth 600 mm	Depth 800 mm
8PQ3000-0BA32	8PQ3000-1BA08	8PQ3000-0BA03	8PQ3000-0BA33	8PQ3000-1BA10	8PQ3000-0BA01	8PQ3000-0BA02
8PQ3000-0BA34	8PQ3000-1BA08	8PQ3000-0BA03	8PQ3000-0BA35	8PQ3000-1BA10	8PQ3000-0BA01	8PQ3000-0BA02
8PQ3000-0BA36	8PQ3000-1BA08	8PQ3000-0BA03	8PQ3000-0BA37	8PQ3000-1BA10	8PQ3000-0BA01	8PQ3000-0BA02
8PQ3000-1BA04	8PQ3000-1BA08	8PQ3000-0BA03	8PQ3000-1BA06	8PQ3000-1BA10	8PQ3000-0BA01	8PQ3000-0BA02
8PQ3000-1BA04	8PQ3000-1BA08	8PQ3000-0BA03	–	–	–	–
8PQ3000-1BA05	8PQ3000-1BA08	8PQ3000-0BA03	–	–	–	–
8PQ3000-0BA32	8PQ3000-1BA08	8PQ3000-0BA03	8PQ3000-0BA33	8PQ3000-1BA10	8PQ3000-0BA01	8PQ3000-0BA02
8PQ3000-0BA34	8PQ3000-1BA08	8PQ3000-0BA03	8PQ3000-0BA35	8PQ3000-1BA10	8PQ3000-0BA01	8PQ3000-0BA02
8PQ3000-0BA36	8PQ3000-1BA08	8PQ3000-0BA03	8PQ3000-0BA37	8PQ3000-1BA10	8PQ3000-0BA01	8PQ3000-0BA02
8PQ3000-1BA04	8PQ3000-1BA08	8PQ3000-0BA03	8PQ3000-1BA06	8PQ3000-1BA10	8PQ3000-0BA01	8PQ3000-0BA02
8PQ3000-1BA04	8PQ3000-1BA08	8PQ3000-0BA03	–	–	–	–
8PQ3000-1BA05	8PQ3000-1BA08	8PQ3000-0BA03	–	–	–	–

Internal separation

Quick selection guide

Form 1

No internal separation



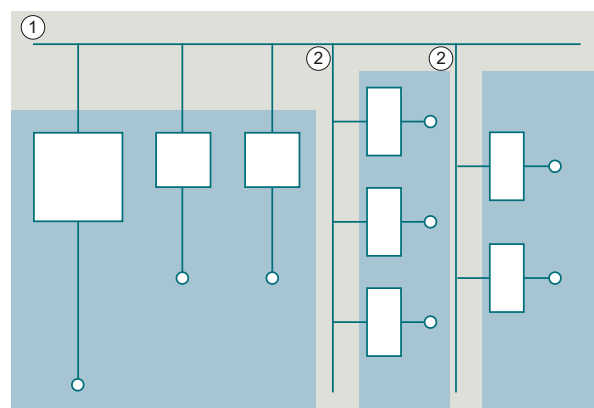
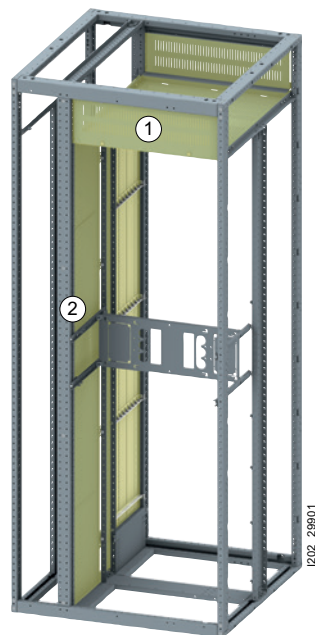
 Functional unit  Connection

Form 2b

Separation

+ Main busbar ①

+ Vertical busbar ②

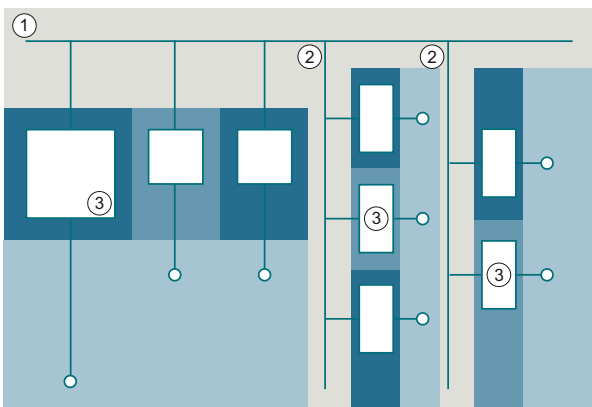
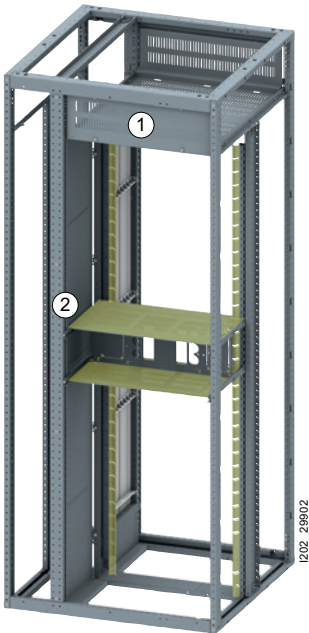


 Functional unit  Connection

Form 3b

Separation

- + Main busbar ①
- + Vertical busbar ②
- + Device compartments (functional units) ③



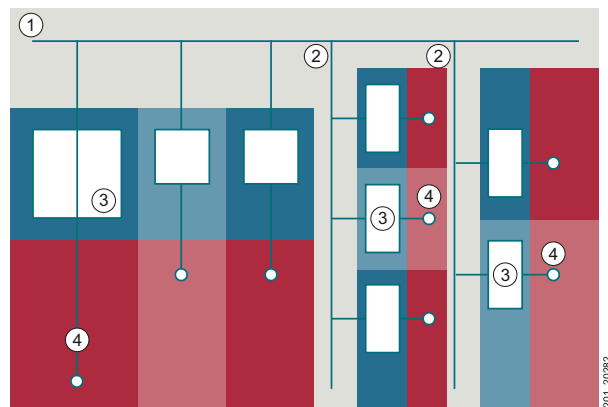
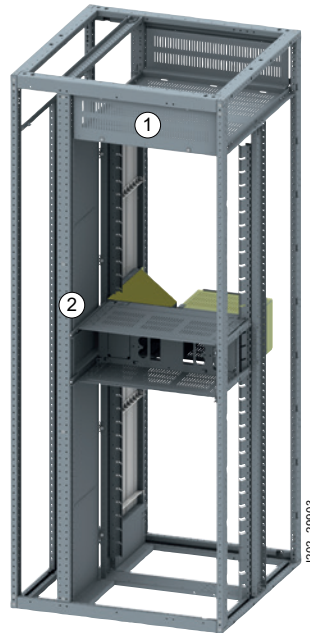
 Functional unit


 Connection

Form 4b

Separation

- + Main busbar ①
- + Vertical busbar ②
- + Device compartments (functional units) ③
- + Connections ④

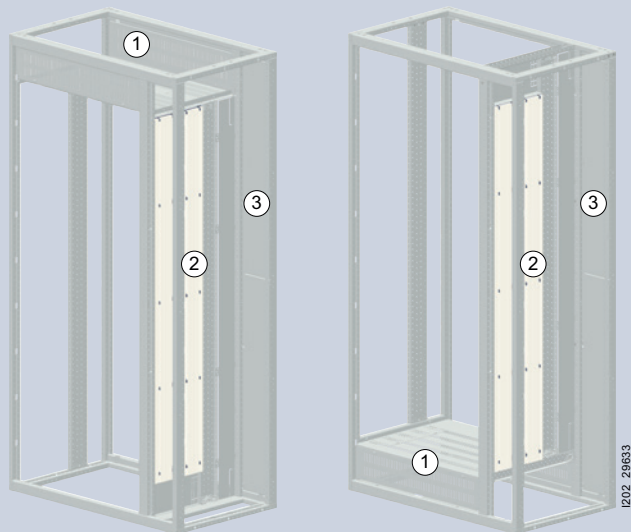


 Functional unit

 Connection

Internal separation

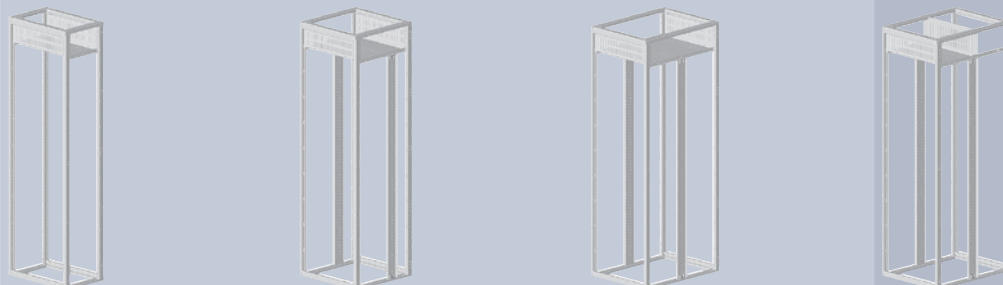
Main busbar at top/at bottom, form 2b



Position of main busbar

At top

① Main busbars



Width	Depth		Depth	
	400 mm	600 mm	800 mm	800 mm
200 mm	8PQ3000-1BA52	8PQ3000-1BA53	8PQ3000-1BA55	8PQ3000-1BA54
400 mm	8PQ3000-0BA67	8PQ3000-0BA52	8PQ3000-0BA58	8PQ3000-0BA55
600 mm	8PQ3000-0BA68	8PQ3000-0BA53	8PQ3000-0BA60	8PQ3000-0BA56
800 mm	8PQ3000-0BA70	8PQ3000-0BA54	8PQ3000-0BA61	8PQ3000-0BA57
1000 mm	8PQ3000-1BA13	8PQ3000-1BA14	8PQ3000-1BA20	8PQ3000-1BA17
1200 mm	8PQ3000-1BA15	8PQ3000-1BA16	8PQ3000-1BA21	8PQ3000-1BA18

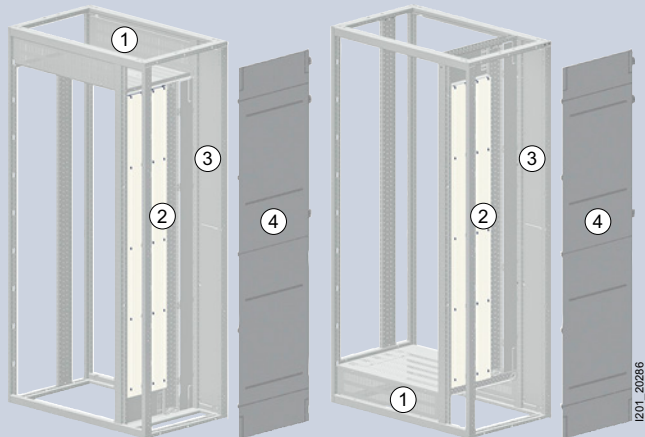
At bottom



Depth 400 mm	600 mm	800 mm
–	–	–
8PQ3000-3BA14	8PQ3000-3BA23	8PQ3000-3BA32
8PQ3000-3BA15	8PQ3000-3BA24	8PQ3000-3BA33
8PQ3000-3BA16	8PQ3000-3BA25	8PQ3000-3BA34
8PQ3000-3BA18	8PQ3000-3BA27	8PQ3000-3BA36
8PQ3000-3BA20	8PQ3000-3BA28	8PQ3000-3BA37

Internal separation

Main busbar at top/at bottom, form 2b

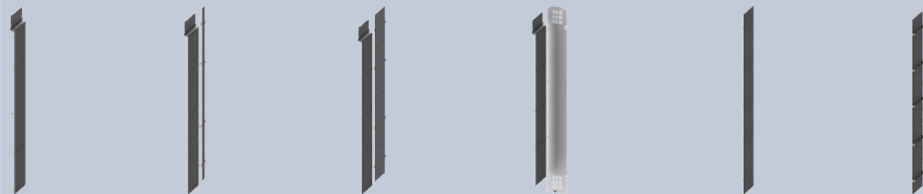


Position of main busbar






At top

Without

Vertical busbar

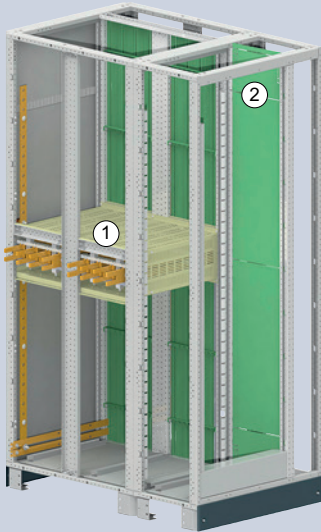


Width	Depth			Depth		
	400 mm	600 mm	800 mm	800 mm	400 mm	600 mm
200 mm	8PQ4000-OBA05	8PQ4000-OBA07	8PQ4000-OBA64	8PQ4000-OBA02	8PQ4000-OBA06	8PQ4000-OBA03
400 mm	8PQ4000-OBA05	8PQ4000-OBA07	8PQ4000-OBA64	8PQ4000-OBA01	8PQ4000-OBA06	8PQ4000-OBA03

Touch protection		Vertical partition between sections		
				
800 mm	Rear	Depth 400 mm	600 mm	800 mm
8PQ4000-0BA76	8PQ3000-2BA50	8PQ3000-0BA15	8PQ3000-0BA16	2 × 8PQ3000-0BA15
8PQ4000-0BA76	8PQ3000-0BA51	8PQ3000-0BA15	8PQ3000-0BA16	2 × 8PQ3000-0BA15

Internal separation

Main busbar at rear, form 2b



Position of main busbar

At top

Center

① Main busbar



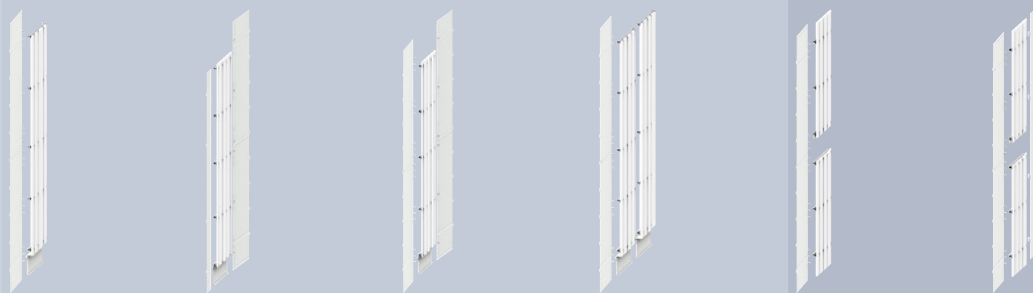
Width	At top				Center	
	Depth 800 mm	1000 mm	1200 mm	1200 mm duplex	Depth 800 mm	1000 mm
600 mm	8PQ3000-0BA60	8PQ3000-0BA53	8PQ3000-0BA60	8PQ3000-0BA60	8PQ3000-3BA53	8PQ3000-3BA53
800 mm	8PQ3000-0BA61	8PQ3000-0BA54	8PQ3000-0BA61	8PQ3000-0BA61	8PQ3000-3BA54	8PQ3000-3BA54

Position of vertical busbar

At top

Center

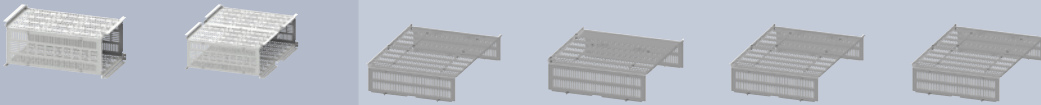
② Vertical busbar



Width	At top				Center	
	Depth 800 mm	1000 mm	1200 mm	1200 mm duplex	Depth 800 mm	1000 mm
200 mm	8PQ4000-2BA51	8PQ4000-2BA53	8PQ4000-2BA55	8PQ4000-2BA57	8PQ4000-2BA60	8PQ4000-2BA61

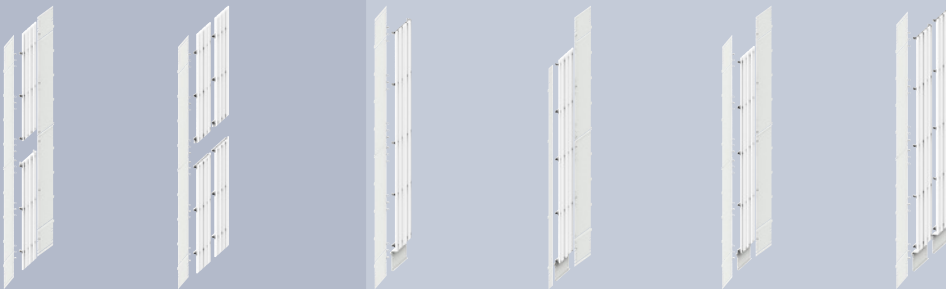
15

At bottom



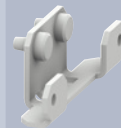
Depth	1200 mm duplex	Depth	800 mm	1000 mm	1200 mm	1200 mm duplex
8PQ3000-3BA53	8PQ3000-3BA58	8PQ3000-3BA33	8PQ3000-3BA24	8PQ3000-3BA33	8PQ3000-3BA33	8PQ3000-3BA33
8PQ3000-3BA54	8PQ3000-3BA60	8PQ3000-3BA34	8PQ3000-3BA25	8PQ3000-3BA34	8PQ3000-3BA34	8PQ3000-3BA34

At bottom



Barrier supports

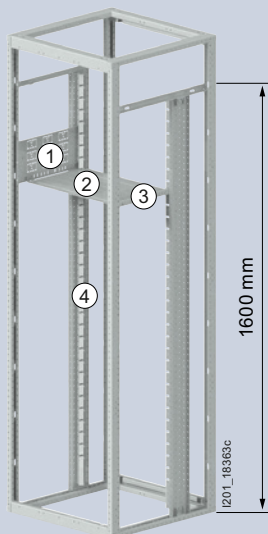
1 set = 6 units



Depth	1200 mm	1200 mm duplex	Depth	800 mm	1000 mm	1200 mm	1200 mm duplex	Depth	1200 mm duplex
8PQ4000-2BA62	8PQ4000-2BA56	8PQ4000-2BA51	8PQ4000-2BA53	8PQ4000-2BA55	8PQ4000-2BA57	8PQ3000-3BA67			

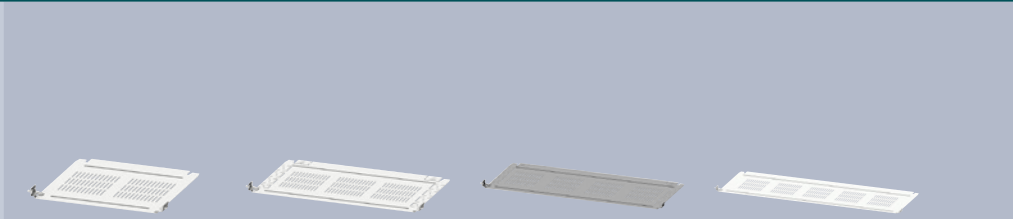
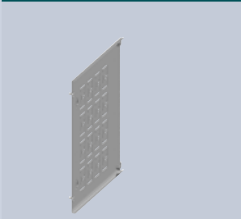
Internal separation

Modular kits, form 3b



① Lateral

② Horizontal

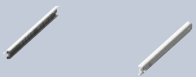


Height	Assembly kits	Width 400 mm	600 mm	800 mm	1000 mm
100 mm	8PQ5000-2BA27	8PQ5000-3BA44	8PQ5000-2BA61	8PQ5000-2BA62	8PQ5000-5BA56
150 mm	8PQ5000-2BA28	8PQ5000-3BA44	8PQ5000-2BA61	8PQ5000-2BA62	8PQ5000-5BA56
200 mm	8PQ5000-2BA30	8PQ5000-3BA44	8PQ5000-2BA61	8PQ5000-2BA62	8PQ5000-5BA56
250 mm	8PQ5000-2BA32	8PQ5000-3BA44	8PQ5000-2BA61	8PQ5000-2BA62	8PQ5000-5BA56
300 mm	8PQ5000-2BA34	8PQ5000-3BA44	8PQ5000-2BA61	8PQ5000-2BA62	8PQ5000-5BA56
350 mm	8PQ5000-2BA36	8PQ5000-3BA44	8PQ5000-2BA61	8PQ5000-2BA62	8PQ5000-5BA56
400 mm	8PQ5000-2BA37	8PQ5000-3BA44	8PQ5000-2BA61	8PQ5000-2BA62	8PQ5000-5BA56
450 mm	8PQ5000-2BA38	8PQ5000-3BA44	8PQ5000-2BA61	8PQ5000-2BA62	8PQ5000-5BA56
550 mm	8PQ5000-2BA41	8PQ5000-3BA44	8PQ5000-2BA61	8PQ5000-2BA62	8PQ5000-5BA56

③ Support rails

④ Plug-in rails

Rear



Width

Height
1600 mm

1800 mm

Width
600 mm

800 mm

8PQ5000-2BA63	8PQ3000-0BA82	8PQ3000-0BA83	8PQ5000-2BA52	8PQ5000-2BA68
8PQ5000-2BA63	8PQ3000-0BA82	8PQ3000-0BA83	8PQ5000-4BA40	8PQ5000-5BA55
8PQ5000-2BA63	8PQ3000-0BA82	8PQ3000-0BA83	8PQ5000-4BA41	8PQ5000-4BA48
8PQ5000-2BA63	8PQ3000-0BA82	8PQ3000-0BA83	8PQ5000-4BA42	8PQ5000-4BA50
8PQ5000-2BA63	8PQ3000-0BA82	8PQ3000-0BA83	8PQ5000-4BA43	–
8PQ5000-2BA63	8PQ3000-0BA82	8PQ3000-0BA83	8PQ5000-4BA44	8PQ5000-4BA51
8PQ5000-2BA63	8PQ3000-0BA82	8PQ3000-0BA83	8PQ5000-4BA45	8PQ5000-4BA52
8PQ5000-2BA63	8PQ3000-0BA82	8PQ3000-0BA83	8PQ5000-4BA46	8PQ5000-4BA53
8PQ5000-2BA63	8PQ3000-0BA82	8PQ3000-0BA83	8PQ5000-4BA47	–

Accessories

Connecting terminals



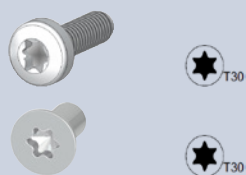
I_n	Busbar	Scope of supply	Article No.
–	–	4 units	8PQ5000-0BA05
250 A	2 × 25 × 5 mm	2 units	8PQ5000-0BA72
400 A	30 × 10 mm	4 units	8PQ5000-0BA73
630 A	40 × 10 mm	4 units	8PQ5000-0BA74

Protective bellows



Version	Scope of supply	Article No.
For connecting terminal	4 units	8PQ9400-0BA71

Self-tapping screws – frame



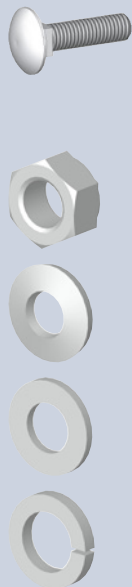
Type	Version	Scope of supply	Article No.
Cylinder-head screws	M6 × 10 mm	100 units	8PQ9500-0BA34
	M6 × 16 mm	100 units	8PQ9500-0BA32
	M6 × 20 mm	100 units	8PQ9500-0BA31
Countersunk screws	M6 × 12 mm	100 units	8PQ9500-1BA07

Cover cap



Version	Scope of supply	Article No.
For M6, RAL 7035	100 units	8PQ9400-0BA14

Standardized parts - electrical connections

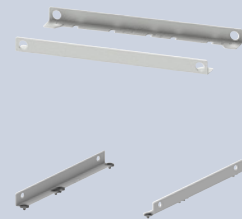


Type	Version	Scope of supply	Article No.
Saucer-head bolts	M10 × 35 mm	50 units	8PQ9500-0BA14
	M10 × 45 mm	50 units	8PQ9500-0BA16
	M10 × 55 mm	50 units	8PQ9500-1BA36
	M10 × 65 mm	50 units	8PQ9500-1BA25
Hexagonal nuts	M10	50 units	8PQ9500-0BA05
Spring washers	For M10	50 units	8PQ9500-0BA60
Plain washers	For M10	50 units	8PQ9500-0BA67
Lock washers	For M10	50 units	8PQ9500-0BA50

Lifting eyebolts (Transport aids)

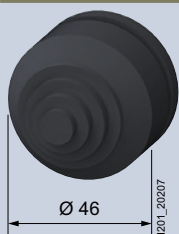


Version	Application	Scope of supply	Article No.
M12 acc. to DIN 580	<ul style="list-style-type: none"> Max. supported weight = 240 kg at load angle $\leq 45^\circ$ Max. section depth 800 mm 	4 units	8PQ9400-0BA11

Lifting brackets **new**

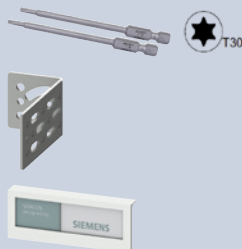
Width	Depth	Scope of supply	Article No.
800 mm	–	2 units	8PQ3000-1BA01
850 mm	–	2 units	8PQ3000-2BA38
1000 mm	–	2 units	8PQ3000-1BA02
1200 mm	–	2 units	8PQ3000-1BA03
–	800 mm	2 units	8PQ3000-1BA01
–	1000 mm	2 units	8PQ3000-1BA70
–	1200 mm	2 units	8PQ3000-1BA71

Cable entries



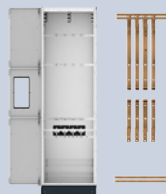
Version	Scope of supply	Article No.
Ø cable = 14 ... 38 mm Ø installation = 46 mm	6 units	8PQ9400-0BA33

Other



Version	Scope of supply	Article No.
Screwdriver insert, Length 200 mm	2 units	8PQ9400-0BA10
Universal mounting brackets	10 units	8PQ9400-0BA01
Cubicle ID plate – SIVACON designed by Siemens	1 unit	BQ9400-0BA06

Extended delivery options



Version	Description	Article No.
Pre-assembled solutions	Based on SIMARIS configuration <ul style="list-style-type: none"> In various expansion stages Mechanically with or without copper insert 	8PQ9998-0BA20-Z
Copper for system sections	Drawings from SIMARIS	8PQ9998-0BA30-Z

System overview

Distribution boards, assembly kits and accessories

ALPHA UNIVERSAL 800



ALPHA UNIVERSAL 630



Unequipped distribution boards



ALPHA 800



ALPHA 630

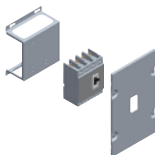


ALPHA 125

Assembly kits



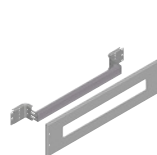
For molded case circuit breakers



For switch disconnectors



For fuse switch disconnectors



For modular installation devices



For front cover with cutout

Note:

You will find a detailed range of accessories with the basic units and in the Accessories section.

ALPHA UNIVERSAL 125



Busbars



Cu busbars



Busbar supports

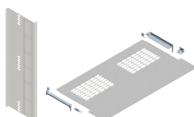
Accessories



Bases



Crossbars



Partitions



Front covers



Locking systems

Note:

You will find a detailed range of accessories with the basic units and in the Accessories section.


Special colors for ALPHA

Additional options

To specify the options, add "-Z" to the complete article number and indicate the appropriate order code(s).

8GK.....-.....-..... -Z

Order code

	RAL 1003, signal yellow	Semi-gloss				C	2	7
	RAL 2000, yellow orange	Semi-gloss				C	2	5
	RAL 3000, flame red	Silky gloss				C	3	1
	RAL 5005, signal blue	Semi-gloss				C	2	3
	RAL 5010, gentian blue	Semi-gloss				C	2	4
	RAL 5017, traffic blue	Silky gloss				C	2	2
	RAL 6018, yellow green	Semi-gloss				C	2	6
	RAL 7032, pebble gray	Semi-gloss				C	1	3
	RAL 7033, cement gray	Semi-gloss				C	2	8
	RAL 7035, light gray	Semi-gloss		Smooth		C	1	1
				Surface structure		C	1	2
	RAL 7038, agate gray	Semi-gloss				C	1	4
	RAL 9001, cream	Semi-gloss				C	2	1
	RAL 9002, gray white	Semi-gloss				C	1	9
		Silky gloss				C	2	9
	RAL 9003, signal white	Semi-gloss				C	2	0
	RAL 9005, jet black	Semi-gloss				C	1	7
	RAL 9010, pure white	Semi-gloss		Smooth		C	1	5
				Surface structure		C	3	0
	RAL 9016, traffic white	Semi-gloss				C	1	0

ALPHA 800 UNIVERSAL floor-mounted distribution boards

Rated current 800 A

Unequipped distribution boards

Degree of protection IP30/IP55



Height Outside	Inside	Depth Outside	Width Outside	Inside	Protection class I
1850 mm	1800 mm	400 mm	350 mm	300 mm	8GK2420-6KK14
			650 mm	600 mm	8GK2420-6KK24
			950 mm	900 mm	8GK2420-6KK34
2050 mm	2000 mm	400 mm	350 mm	300 mm	8GK2420-7KK14
			650 mm	600 mm	8GK2420-7KK24
			950 mm	900 mm	8GK2420-7KK34

Accessories

Unequipped distribution boards

Sheet-steel doors

Types	Width	Cubicle height	Cubicle width	Article No.
Standard	-	1800 mm	300 mm	8GK9515-8KK11
			600 mm	8GK9515-8KK21
			900 mm	8GK9515-8KK31
		2000 mm	300 mm	8GK9515-8KK12
			600 mm	8GK9515-8KK22
			900 mm	8GK9515-8KK32
For cabling compartment	250 mm	1800 mm	900 mm	8GK9515-8KK41
		2000 mm	900 mm	8GK9515-8KK42

Transparent doors

Types	Cubicle height	Cubicle width	Article No.
Standard	1800 mm	300 mm	8GK9505-8KK12
		600 mm	8GK9505-8KK21
		900 mm	8GK9505-8KK31
	2000 mm	300 mm	8GK9505-8KK10
		600 mm	8GK9505-8KK22
		900 mm	8GK9505-8KK32
Giugiaro design	1800 mm	600 mm	8GK9507-8KK21
		900 mm	8GK9507-8KK31
		900 mm	8GK9507-8KK32
	2000 mm	600 mm	8GK9507-8KK22
		900 mm	8GK9507-8KK31
		900 mm	8GK9507-8KK32

Double doors

Types	Width	Cubicle height	Cubicle width	Article No.
Made of sheet steel	600 + 250 mm	1800 mm	900 mm	8GK9515-8KK21 + 8GK9515-8KK41
		2000 mm	900 mm	8GK9515-8KK22 + 8GK9515-8KK42
Transparent door + sheet-steel door	600 + 250 mm	1800 mm	900 mm	8GK9505-8KK21 + 8GK9515-8KK41
		2000 mm	900 mm	8GK9505-8KK22 + 8GK9515-8KK42
Transparent door in Giugiaro design + sheet-steel door	600 + 250 mm	1800 mm	900 mm	8GK9507-8KK21 + 8GK9515-8KK41
		2000 mm	900 mm	8GK9507-8KK22 + 8GK9515-8KK42

Accessories

Unequipped
distribution boards

Vertical profile bars for cabling compartment/busbars



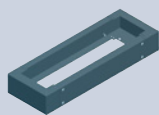
Cubicle height	Cubicle width	Article No.
1800 mm	300/600/900 mm	8GK9200-8KK00
2000 mm	300/600/900 mm	8GK9200-8KK01

Front covers for cabling compartment



Height	Width	Cubicle height	Cubicle width	Article No.
800 + 1000 mm	250/300 mm	1800 mm	300 mm	8GK9607-5KK10 + 8GK9607-7KK10
			900 mm	8GK9606-5KK10 + 8GK9606-7KK10
1000 + 1000 mm	250/300 mm	2000 mm	300 mm	8GK9607-7KK10 + 8GK9607-7KK10
			900 mm	8GK9606-7KK10 + 8GK9606-7KK10

Bases



Color	Height	Cubicle height	Cubicle width	Article No.
Blue-green	100 mm	1800/2000 mm	300 mm	8GK9906-0KK15
			600 mm	8GK9906-0KK25
			900 mm	8GK9906-0KK35

Side panels



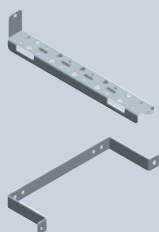
Color	Cubicle height	Cubicle width	Article No.
RAL 7035 (pair)	1800 mm	300/600/900 mm	8GK9200-8KK04
	2000 mm	300/600/900 mm	8GK9200-8KK05
Blue-green	1800 mm	300/600/900 mm	8GK9200-8KK07
	2000 mm	300/600/900 mm	8GK9200-8KK08

Supports



Types	Height	Article No.
Mounting stays (pair)	1600 mm	8GK6850-0KK02
	1800 mm	8GK6850-0KK03
	2000 mm	8GK6850-0KK04
Rear universal supports	1800 mm	8GK6850-0KK05
	2000 mm	8GK6850-0KK06

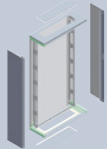


Crossbars



Types	Article No.
Upper crossbar	8GK6850-0KK00
Lateral crossbar	8GK6850-0KK01
Adapter for installation of assembly kits in the cabling compartment, width 250 mm (2 units)	8GK9920-0KK01

ALPHA 630 UNIVERSAL wall-mounted distribution boards

Rated current 630 A

					Flat pack	Unequipped distribution boards	Distribution boards with built-in distribution board panels
					Degree of protection		
					IP43	IP30/IP55	IP55
							
Height	Depth	Width			Protection class I	Protection class I	Protection class I
Outside	Outside	Outside	Outside	Inside			
450 mm	250 mm	650 mm	400 mm	600 mm	8GK2100-0KS23	–	–
650 mm	250 mm	650 mm	600 mm	600 mm	8GK2100-1KS23	8GK2124-1KK23	–
850 mm	250 mm	650 mm	800 mm	600 mm	8GK2100-2KS23	8GK2124-2KK23	8GK9988-0KL00
1050 mm	250 mm	650 mm	1000 mm	600 mm	8GK2100-3KS23	8GK2124-3KK23	8GK9988-0KL01
				900 mm	8GK2100-3KL23	8GK2124-3KK33	–
1250 mm	250 mm	650 mm	1200 mm	600 mm	8GK2100-4KS23	8GK2124-4KK23	8GK9988-0KL02
				900 mm	8GK2100-4KL23	8GK2124-4KK33	–

Accessories

Sheet-steel doors

Types	Cubicle height	Cubicle width	Flat pack IP43	Unequipped distribution boards IP55
			Article No.	Article No.
Standard	400 mm	600 mm	8GK9515-3KK20	–
	600 mm	600 mm	8GK9515-4KK20	8GK9515-4KK20
	800 mm	600 mm	8GK9515-5KK20	8GK9515-5KK23
	1000 mm	600 mm	8GK9515-6KK20	8GK9515-6KK23
		900 mm	8GK9515-6KK30	8GK9515-6KK33
	1200 mm	600 mm	8GK9515-7KK20	8GK9515-7KK23
For cabling compartment	1000 mm	900 mm	8GK9515-7KK30	8GK9515-7KK33
		900 mm	8GK9515-7KK40	8GK9515-7KK43
	1200 mm	900 mm	8GK9515-6KK40	8GK9515-6KK43
		600 + 300 mm	–	8GK9515-7KK43

Transparent doors

Types	Cubicle height	Cubicle width	Flat pack IP43	Unequipped distribution boards IP55
			Article No.	Article No.
Standard	400 mm	600 mm	8GK9505-3KK20	–
	600 mm	600 mm	8GK9505-4KK20	8GK9505-4KK20
	800 mm	600 mm	8GK9505-5KK20	8GK9505-5KK23
	1000 mm	600 mm	8GK9505-6KK20	8GK9505-6KK23
		900 mm	8GK9505-6KK30	8GK9505-6KK33
	1200 mm	600 mm	8GK9505-7KK20	8GK9505-7KK23
Giugiaro design	400 mm	600 mm	8GK9505-7KK30	8GK9505-7KK33
		900 mm	8GK9505-7KK40	8GK9505-7KK43
	600 mm	600 mm	8GK9507-2KK23	–
		600 mm	8GK9507-4KK23	8GK9507-4KK23
	800 mm	600 mm	8GK9507-5KK23	8GK9507-5KK23
	1000 mm	600 mm	8GK9507-7KK23	8GK9507-7KK23
900 mm		8GK9507-7KK33	8GK9507-7KK33	
1200 mm	600 mm	8GK9507-8KK23	8GK9507-8KK23	
	900 mm	8GK9507-8KK33	8GK9507-8KK33	

15





Accessories

					Flat pack IP43	Unequipped distribution boards IP55	
Double doors							
	Types	Width	Cubicle height	Cubicle width	Article No.	Article No.	
	Made of sheet steel	600 + 250 mm ¹⁾	1000 mm	900 mm	8GK9515-6KK20 + 8GK9515-6KK40	8GK9515-6KK23 + 8GK9515-6KK43	
			1200 mm	900 mm	8GK9515-7KK20 + 8GK9515-7KK40	8GK9515-7KK23 + 8GK9515-7KK43	
	Transparent door + sheet-steel door	600 + 250 mm	1000 mm	900 mm	8GK9505-6KK20 + 8GK9515-6KK40	8GK9505-6KK23 + 8GK9515-6KK43	
			1200 mm	900 mm	8GK9505-7KK20 + 8GK9515-7KK40	8GK9505-7KK23 + 8GK9515-7KK43	
	Transparent door in Giugiaro design + sheet-steel door	600 + 250 mm ¹⁾	1600 mm	900 mm	8GK9507-7KK23 + 8GK9515-6KK40	8GK9507-7KK23 + 8GK9515-6KK43	
			1800 mm	900 mm	8GK9507-8KK23 + 8GK9515-7KK40	8GK9507-8KK23 + 8GK9515-7KK43	
	Vertical profile bars for cabling compartment						
				Cubicle height	Cubicle width	Article No.	Article No.
			1000 mm	900 mm	8GK9125-7KK01	8GK9125-7KK01	
			1200 mm	900 mm	8GK9127-8KK01	8GK9127-8KK01	
Front covers for cabling compartment							
	Height	Width	Cubicle height	Cubicle width	Article No.	Article No.	
	1000 mm	250/300 mm	1000 mm	900 mm	8GK9606-7KK10	8GK9606-7KK10	
	600 + 600 mm	250/300 mm	1200 mm	900 mm	8GK9606-4KK10 + 8GK9606-4KK10	8GK9606-4KK10 + 8GK9606-4KK10	
Bases							
	Color	Height	Cubicle height	Cubicle width	Article No.	Article No.	
	Blue-green	100 mm	600/1200 mm	600 mm	8GK9906-0KK23	8GK9906-0KK23	
			1000/1200 mm	900 mm	8GK9906-0KK33	8GK9906-0KK33	
Covers for cable entry and cable duct							
			Cubicle height	Cubicle width	Article No.	Article No.	
			600/1200 mm	600 mm	8GK9920-0KK41	8GK9920-0KK41	
			1000/1200 mm	900 mm	8GK9920-0KK42	8GK9920-0KK42	
Side panels							
	Color		Cubicle height	Cubicle width	Article No.	Article No.	
	Blue-green		600 mm	600 mm	–	8GK9122-4KK01	
			800 mm	600 mm	–	8GK9122-5KK01	
			1000 mm	600/900 mm	–	8GK9122-6KK01	
			1200 mm	600/900 mm	–	8GK9122-7KK01	

¹⁾ For distribution boards with a width of 900 mm with double door and vertical profile bar

ALPHA 630 UNIVERSAL floor-mounted distribution boards

Rated current 630 A

					Flat pack	Unequipped distribution boards	Control cabinet with built-in assembly kits for modular installation devices	With assembly kit for 3VL molded case circuit breakers
					Degree of protection			
					IP43	IP30/IP55	IP55	IP55
								
Height	Depth	Width	Protection class I		Protection class I	Protection class I	Protection class I	Protection class I
Outside	Inside	Outside	Outside	Inside				
1650 mm	1600 mm	250 mm	350 mm	300 mm	8GK2300-5KL13	8GK2325-5KK13	–	–
			650 mm	600 mm	8GK2300-5KL23	8GK2325-5KK23	–	–
			950 mm	900 mm	8GK2300-5KL43	8GK2325-5KK43	–	–
1850 mm	1800 mm	250 mm	350 mm	300 mm	8GK2300-6KL13	8GK2325-6KK13	–	–
			650 mm	600 mm	8GK2300-6KL23	8GK2325-6KK23	8GK2348-7KL00	8GK2348-7KL01
			950 mm	900 mm	8GK2300-6KL43	8GK2325-6KK43	–	–
2050 mm	2000 mm	250 mm	350 mm	300 mm	8GK2300-7KL13	8GK2325-7KK13	–	–
			650 mm	600 mm	8GK2300-7KL23	8GK2325-7KK23	–	–
			950 mm	900 mm	8GK2300-7KL43	8GK2325-7KK43	–	–

ALPHA 630 UNIVERSAL floor-mounted distribution boards

Rated current 630 A

Accessories

Sheet-steel doors

					Flat pack	Unequipped distribution boards
Types	Width	Cubicle height	Cubicle width	Article No.	Article No.	
Standard	–	1600 mm	300 mm	8GK9515-8KK10	8GK9515-8KK10	
			600 mm	8GK9515-8KK20	8GK9515-8KK20	
			900 mm	8GK9515-8KK30	8GK9515-8KK30	
	1800 mm	–	300 mm	8GK9515-8KK11	8GK9515-8KK11	
			600 mm	8GK9515-8KK21	8GK9515-8KK21	
			900 mm	8GK9515-8KK31	8GK9515-8KK31	
	2000 mm	–	300 mm	8GK9515-8KK12	8GK9515-8KK12	
			600 mm	8GK9515-8KK22	8GK9515-8KK22	
			900 mm	8GK9515-8KK32	8GK9515-8KK32	
For cabling compartment	250 mm	1600 mm	900 mm	8GK9515-8KK40	8GK9515-8KK40	
		1800 mm	900 mm	8GK9515-8KK41	8GK9515-8KK41	
		2000 mm	900 mm	8GK9515-8KK42	8GK9515-8KK42	

Transparent doors

Types	Cubicle height	Cubicle width	Article No.	Article No.	
Standard	1600 mm	300 mm	8GK9505-8KK11	8GK9505-8KK11	
		600 mm	8GK9505-8KK20	8GK9505-8KK20	
		900 mm	8GK9505-8KK30	8GK9505-8KK30	
	1800 mm	–	300 mm	8GK9505-8KK12	8GK9505-8KK12
			600 mm	8GK9505-8KK21	8GK9505-8KK21
			900 mm	8GK9505-8KK31	8GK9505-8KK31
	2000 mm	–	300 mm	8GK9505-8KK10	8GK9505-8KK10
			600 mm	8GK9505-8KK22	8GK9505-8KK22
			900 mm	8GK9505-8KK32	8GK9505-8KK32
Giugiaro design	1600 mm	600 mm	8GK9507-8KK20	8GK9507-8KK20	
		900 mm	8GK9507-8KK30	8GK9507-8KK30	
	1800 mm	600 mm	8GK9507-8KK21	8GK9507-8KK21	
		900 mm	8GK9507-8KK31	8GK9507-8KK31	
	2000 mm	600 mm	8GK9507-8KK22	8GK9507-8KK22	
		900 mm	8GK9507-8KK32	8GK9507-8KK32	

Double doors

Types	Width	Cubicle height	Cubicle width	Article No.	Article No.
Made of sheet steel	600 + 250 mm	1600 mm	900 mm	8GK9515-8KK20 + 8GK9515-8KK40	8GK9515-8KK20 + 8GK9515-8KK40
		1800 mm	900 mm	8GK9515-8KK21 + 8GK9515-8KK41	8GK9515-8KK21 + 8GK9515-8KK41
		2000 mm	900 mm	8GK9515-8KK22 + 8GK9515-8KK42	8GK9515-8KK22 + 8GK9515-8KK42
Transparent door + sheet-steel door	600 + 250 mm	1600 mm	900 mm	8GK9505-8KK20 + 8GK9515-8KK40	8GK9505-8KK20 + 8GK9515-8KK40
		1800 mm	900 mm	8GK9505-8KK21 + 8GK9515-8KK41	8GK9505-8KK21 + 8GK9515-8KK41
		2000 mm	900 mm	8GK9505-8KK22 + 8GK9515-8KK42	8GK9505-8KK22 + 8GK9515-8KK42
Transparent door in Giugiaro design + sheet-steel door	600 + 250 mm	1600 mm	900 mm	8GK9507-8KK20 + 8GK9515-8KK40	8GK9507-8KK20 + 8GK9515-8KK40
		1800 mm	900 mm	8GK9507-8KK21 + 8GK9515-8KK41	8GK9507-8KK21 + 8GK9515-8KK41
		2000 mm	900 mm	8GK9507-8KK22 + 8GK9515-8KK42	8GK9507-8KK22 + 8GK9515-8KK42

Vertical profile bars for cabling compartment

Cubicle height	Cubicle width	Article No.	Article No.
1600 mm	900 mm	8GK9125-8KK11	8GK9125-8KK11
1800 mm	900 mm	8GK9125-8KK12	8GK9125-8KK12
2000 mm	900 mm	8GK9125-8KK13	8GK9125-8KK13

Accessories

Front covers for cabling compartment

Height	Width	Cubicle height	Cubicle width	Flat pack		Unequipped distribution boards	
				Article No.	Article No.	Article No.	Article No.
800 + 800 mm	250/300 mm	1600 mm	300 mm	8GK9607-5KK10 + 8GK9607-5KK10	8GK9607-5KK10 + 8GK9607-5KK10	8GK9607-5KK10 + 8GK9607-5KK10	8GK9607-5KK10 + 8GK9607-5KK10
			900 mm	8GK9606-5KK10 + 8GK9606-5KK10	8GK9606-5KK10 + 8GK9606-5KK10	8GK9606-5KK10 + 8GK9606-5KK10	8GK9606-5KK10 + 8GK9606-5KK10
800 + 1000 mm	250/300 mm	1800 mm	300 mm	8GK9607-5KK10 + 8GK9607-7KK10	8GK9607-5KK10 + 8GK9607-7KK10	8GK9607-5KK10 + 8GK9607-7KK10	8GK9607-5KK10 + 8GK9607-7KK10
			900 mm	8GK9606-5KK10 + 8GK9606-7KK10	8GK9606-5KK10 + 8GK9606-7KK10	8GK9606-5KK10 + 8GK9606-7KK10	8GK9606-5KK10 + 8GK9606-7KK10
1000 + 1000 mm	250/300 mm	2000 mm	300 mm	8GK9607-7KK10 + 8GK9607-7KK10	8GK9607-7KK10 + 8GK9607-7KK10	8GK9607-7KK10 + 8GK9607-7KK10	8GK9607-7KK10 + 8GK9607-7KK10
			900 mm	8GK9606-7KK10 + 8GK9606-7KK10	8GK9606-7KK10 + 8GK9606-7KK10	8GK9606-7KK10 + 8GK9606-7KK10	8GK9606-7KK10 + 8GK9606-7KK10

Bases

Color	Height	Cubicle height	Cubicle width	Article No.	Article No.
Blue-green	100 mm	1600/2000 mm	300 mm	8GK9906-0KK13	8GK9906-0KK13
		1600/2000 mm	600 mm	8GK9906-0KK23	8GK9906-0KK23
		1600/2000 mm	900 mm	8GK9906-0KK33	8GK9906-0KK33

Covers for cable entry and cable duct





Cubicle height	Cubicle width	Article No.	Article No.
1600/2000 mm	300 mm	8GK9920-0KK40	8GK9920-0KK40
1600/2000 mm	600 mm	8GK9920-0KK41	8GK9920-0KK41
1600/2000 mm	900 mm	8GK9920-0KK42	8GK9920-0KK42

Side panels

Color	Cubicle height	Cubicle width	Article No.	Article No.
RAL 7035 (pair)	1600 mm	300/600/900 mm	8GK9120-8KK00	8GK9122-8KK03
	1800 mm	300/600/900 mm	8GK9120-8KK01	8GK9122-8KK04
	2000 mm	300/600/900 mm	8GK9120-8KK02	8GK9122-8KK05

ALPHA UNIVERSAL 125 distribution boards

Rated current 125 A

						Surface-mounting distribution boards		Flush-mounting distribution boards	
						With sheet-steel door	With transparent door	With sheet-steel door	With transparent door
Degree of protection						IP43	IP43	IP31D	IP31D
									
Height	Depth	Width	Tiers	Protection class I	Protection class I	Protection class I	Protection class I	Protection class I	Protection class I
Outside	Inside	Outside	Outside	Inside	(MW = 18 mm)				
450 mm	400 mm	140 mm	660 mm	600 mm	48 (2 × 24)	8GK2042-0KL21	8GK2042-0KM21	–	–
650 mm	600 mm	140 mm	660 mm	600 mm	72 (3 × 24)	8GK2042-1KL21	8GK2042-1KM21	–	–
800 mm	850 mm	140 mm	660 mm	600 mm	96 (4 × 24)	8GK2042-2KL21	8GK2042-2KM21	–	–
1050 mm	1000 mm	140 mm	660 mm	600 mm	120 (5 × 24)	8GK2042-3KL21	8GK2042-3KM21	–	–
1250 mm	1200 mm	140 mm	660 mm	600 mm	144 (6 × 24)	8GK2042-4KL21	8GK2042-4KM21	–	–
508 mm	400 mm	140 mm	718 mm	600 mm	48 (2 × 24)	–	–	8GK2043-0KL21	8GK2043-0KM21
708 mm	600 mm	140 mm	718 mm	600 mm	72 (3 × 24)	–	–	8GK2043-1KL21	8GK2043-1KM21
908 mm	800 mm	140 mm	718 mm	600 mm	96 (4 × 24)	–	–	8GK2043-2KL21	8GK2043-2KM21
1108 mm	1000 mm	140 mm	718 mm	600 mm	120 (5 × 24)	–	–	8GK2043-3KL21	8GK2043-3KM21
1308 mm	1200 mm	140 mm	718 mm	600 mm	144 (6 × 24)	–	–	8GK2043-4KL21	8GK2043-4KM21

Accessories

Front covers

- With quick-lock screws and integrated grounding connection

Type	Height	Width	Article No.
Closed	50 mm	600 mm	8GK9620-1KK20
	100 mm	600 mm	8GK9621-1KK20
	150 mm	600 mm	8GK9622-1KK20
	200 mm	600 mm	8GK9623-1KK20
	400 mm	600 mm	8GK9622-2KK20
	600 mm	600 mm	8GK9622-4KK20
	800 mm	600 mm	8GK9622-5KK20
For modular installation devices	150 mm	600 mm	8GK9608-1KK22
	200 mm	600 mm	8GK9608-1KK20
	300 mm	600 mm	8GK9608-2KK22
	400 mm	600 mm	8GK9608-2KK20
	450 mm	600 mm	8GK9608-3KK22
	600 mm	600 mm	8GK9608-4KK20

DIN rails for modular installation devices

Width	Article No.
600 mm	8GK9920-0KK11

Holders for cable duct

Width	Article No.
600 mm	8GK9920-0KK20

Grounding bars, PE

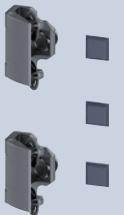
Width	Article No.
600 mm (20 × 5 mm ²)	8GK9920-0KK10

Hinges for front covers



Version	Article No.
For hinged covers	8GK9120-0KK11

Hinges for masking frames



Version	Scope of supply	Article No.
Hinge, incl. fixing accessories	1 set	8PQ2000-0BA08

Rotary handles



Version	Color	Article No.
Plastic	Black	8GK9560-0KK04
Lockable	Black	8GK9560-0KK13

Profile semicylinders E012



Version	Article No.
Insert and key 8GK9560	8GK9560-0KK07

Rotary handles for profile semicylinders



Version	Article No.
For 40 mm profile semicylinders	8GK9560-0KK06

Quick-lock screws for ALPHA cabinets with ¼ turn



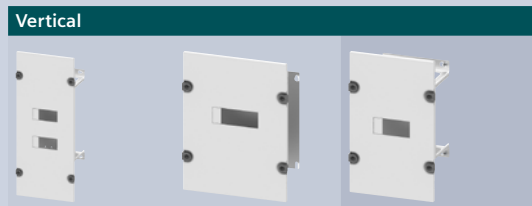
Scope of supply	Article No.
20 units	8GK9562-0KK00

Assembly kits

For 3VA molded case circuit breakers



Switches/breakers				Distribution board		With RCD module	Without RCD module
Type	Rated current	Quantity	Rotary operating mechanism	Height outside	Width outside	Infeed side	
3VA10.. and 3VA11..	100 A/160 A	1	–	200 mm	600 mm	8GK6735-2KK23	8GK6730-2KK23
			■	200 mm	600 mm	8GK6735-2KK33	8GK6730-2KK33
			■	200 mm	900 mm	–	8GK6733-2KK23
3VA12..	250 A	1	–	200 mm	600 mm	8GK6736-2KK23	8GK6721-2KK23
			■	200 mm	600 mm	8GK6736-2KK33	8GK6721-2KK33
			■	200 mm	900 mm	–	8GK6734-2KK23
3VA20.. and 3VA22..	100 A/250 A	1	–	200 mm	600 mm	8GK6725-2KK23	8GK6720-2KK23
			■	200 mm	600 mm	8GK6725-2KK33	8GK6720-2KK33
			■	200 mm	900 mm	–	8GK6723-2KK23
3VA23.. and 3VA24..	400 A/630 A	1	–	400 mm	600 mm	–	8GK6740-4KK23
			■	400 mm	900 mm	8GK6745-4KK23	8GK6740-4KK33

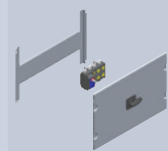


Switches/breakers		Quantity	Motorized operating mechanism	Distribution board		With RCD module		Without RCD module				
Type	Rated current			Height outside	Width outside	Infeed side	At side					
3VA10.. and 3VA11..	100 A/160 A	1	–	200 mm	300 mm	–	–	8GK6731-2KK13				
				400 mm	250 mm	–	–	8GK6730-4KK43				
					300 mm	–	8GK6731-6KK13	8GK6730-4KK13				
					600 mm	250 mm	8GK6735-4KK43	–	–			
						300 mm	8GK6735-6KK13	–	–			
						400 mm	300 mm	–	8GK6738-6KK13	8GK6734-4KK13		
	3	–	–	–	600 mm	300 mm	8GK6736-6KK13	–	–			
					200 mm	600 mm	–	–	8GK6731-2KK23			
					400 mm	600 mm	–	8GK6731-6KK23	8GK6730-4KK23			
						900 mm	–	–	8GK6731-6KK33			
						600 mm	600 mm	8GK6735-6KK23	–	–		
							200 mm	600 mm	–	–	8GK6734-4KK23	
		■	–	–	–	400 mm	600 mm	–	8GK6737-6KK23	–		
							900 mm	–	8GK6737-6KK33	–		
							600 mm	600 mm	8GK6736-6KK23	–	–	
								200 mm	900 mm	–	–	8GK6731-2KK33
								400 mm	900 mm	–	–	8GK6730-4KK33
								200 mm	900 mm	–	–	8GK6734-4KK33
5	–	–	–	600 mm	900 mm	8GK6736-6KK33	–	–				
						400 mm	300 mm	–	–	8GK6721-4KK13		
						600 mm	250 mm	8GK6732-6KK13	–	8GK6730-6KK13		
							300 mm	–	8GK6722-6KK13	8GK6721-6KK13		
						3	–	–	–	8GK6721-4KK23		
						600 mm	600 mm	–	8GK6724-6KK23	8GK6721-6KK23		
	■	–	–	–	400 mm	600 mm	–	–	8GK6722-6KK23			
						600 mm	600 mm	–	8GK6723-6KK23	–		
							400 mm	900 mm	–	–	8GK6721-4KK33	
							600 mm	900 mm	–	8GK6724-6KK33	8GK6721-6KK33	
							400 mm	900 mm	–	–	8GK6722-6KK33	
							600 mm	900 mm	–	8GK6723-6KK33	–	
3VA12..	250 A	1	–	400 mm	300 mm	–	–	8GK6721-4KK13				
					600 mm	250 mm	8GK6732-6KK13	–	8GK6730-6KK13			
						300 mm	–	8GK6722-6KK13	8GK6721-6KK13			
						3	–	–	–	8GK6721-4KK23		
						600 mm	600 mm	–	8GK6724-6KK23	8GK6721-6KK23		
						400 mm	600 mm	–	–	8GK6722-6KK23		
	■	–	–	–	600 mm	600 mm	–	8GK6723-6KK23	–			
							400 mm	900 mm	–	–	8GK6721-4KK33	
							600 mm	900 mm	–	8GK6724-6KK33	8GK6721-6KK33	
							400 mm	900 mm	–	–	8GK6722-6KK33	
							600 mm	900 mm	–	8GK6723-6KK33	–	
							400 mm	900 mm	–	–	8GK6724-4KK33	
3VA20.. and 3VA22..	100 A/250 A	1	–	400 mm	300 mm	–	–	8GK6720-4KK13				
					600 mm	300 mm	8GK6725-6KK13	–	–			
						3	–	–	–	8GK6720-4KK23		
						600 mm	600 mm	–	8GK6725-6KK23	–		
						400 mm	600 mm	–	–	8GK6724-4KK23		
						600 mm	600 mm	–	–	8GK6720-4KK33		
	■	–	–	–	400 mm	900 mm	–	–	8GK6720-4KK33			
							600 mm	900 mm	8GK6725-6KK33	–	–	
							400 mm	900 mm	–	–	8GK6724-4KK33	
							3	–	–	–	8GK6740-6KK13	
							600 mm	600 mm	8GK6745-6KK23	–	8GK6740-6KK23	
							600 mm	900 mm	8GK6745-6KK33	–	8GK6740-6KK33	
3VA23.. and 3VA24..	400 A/630 A	1	–	600 mm	300 mm	–	–	8GK6740-6KK13				
		2	–	600 mm	600 mm	8GK6745-6KK23	–	8GK6740-6KK23				
		3	–	600 mm	900 mm	8GK6745-6KK33	–	8GK6740-6KK33				

Assembly kits

For 3KA7 switch disconnectors

Vertical



Switches/breakers Type	Description	Quantity	Distribution board				
			Height outside	Width outside	Depth		
3KA7	3KA711 size 1 max. 125 A	1	200 mm	600 mm	–	8GK6400-2KK20	
			400 mm	250 mm ¹⁾	–	8GK6400-4KK10	
				300 mm ²⁾	–	8GK6400-4KK11	
			3	200 mm	900 mm	–	8GK6400-2KK30
	3KA712 size 2 max. 250 A	1	400 mm	250 mm ¹⁾	–	8GK6401-4KK10	
				300 mm ²⁾	–	8GK6401-4KK12	
				600 mm	–	8GK6400-4KK20	
			3	400 mm	900 mm	–	8GK6400-4KK30
	3KA713 size 3 max. 400 A	1	400 mm	600 mm	–	8GK6401-4KK20	
			3	400 mm	900 mm	–	8GK6400-4KK31
3KA7/3KL7	3KA7/3KL711 size 1 max. 125 A	1	400 mm	250 mm	250 mm	8GK6430-4KK03	
				300 mm	250 mm	8GK6430-4KK14	
			2	200 mm	600 mm	250 mm	8GK6430-4KK24
					900 mm	250 mm	8GK6430-4KK34
	3KA7/3KL712 size 2 max. 250 A	1	400 mm	250 mm	400 mm	8GK6431-4KK04	
				300 mm	400 mm	8GK6431-4KK14	
				2	400 mm	600 mm	250 mm
					900 mm	250 mm	8GK6431-4KK34
	3KA7/3KL713 size 3 max. 400 A	1	400 mm	600 mm	400 mm	8GK6432-4KK24	
					900 mm	400 mm	8GK6432-4KK34
	3KA7/3KL714 size 4 max. 630 A	1	400 mm	600 mm	400 mm	8GK6433-4KK24	
					400 mm	900 mm	400 mm

¹⁾ In order to use box width 250 mm in the ALPHA 630 UNIVERSAL as a switchgear compartment, the following bars are required:

8GF9655 (height 1000 mm),
8GF9656 (height 1200 mm),
8GF9650 (height 1600 mm),
8GF9658 (height 1800 mm),
8GF9654 (height 2000 mm).

In order to use box width 250 mm in the ALPHA 800 UNIVERSAL as a switchgear compartment, you must order side supports and, for each assembly kit, a pair of crossbars 8GK9920-0KK01.

²⁾ In order to use cubicle width 300 mm in the ALPHA 630 UNIVERSAL as a switchgear compartment, you require the following inner supports:

8GK9126-8KK03 (height 1600 mm),
8GK9126-8KK04 (height 1800 mm),
8GK9126-8KK05 (height 2000 mm).

In order to use cubicle width 300 mm in the ALPHA 800 UNIVERSAL as a switchgear compartment, you must order the following side supports:

8GK6850-0KK02 (height 1600 mm),
8GK6850-0KK03 (height 1800 mm),
8GK6850-0KK04 (height 2000 mm).

For 3KF switch disconnectors with fuses

Vertical



Switches/breakers Type	Rated current	Operating mechanism in center	Door-coupling rotary operating mechanism	Distribution board			
				Height	Width	Depth	
2 × 3KF1	80 A	■	–	200 mm	600 mm	250 mm	8GK6431-2KK23
					900 mm	250 mm	8GK6431-2KK33
2 × 3KF2	160 A	■	–	200 mm	600 mm	250 mm	8GK6432-2KK23
					900 mm	250 mm	8GK6432-2KK33
2 × 3KF1/3KF2 or 1 × 3KF3/3KF4	400 A	–	■	400 mm	600 mm	400 mm	8GK6431-4KK33
					900 mm	400 mm	8GK6432-4KK33

For 3KD switch disconnectors

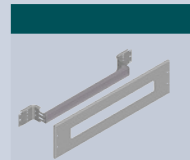
Vertical



Switches/breakers Size	Rated current	Quantity	Door-coupling rotary operating mechanism	Distribution board		
				Height outside	Width outside	
1/2/3	63 A/250 A/400 A	1/1	■	400 mm	250 mm	8GK6430-4KK13
1/2/3/4	63 A/250 A/400 A/630 A	2/1	■	400 mm	600 mm	8GK6430-4KK23
1/2/3/4	63 A/250 A/400 A/630 A	2	■	400 mm	900 mm	8GK6430-4KK33

Assembly kits

For modular installation devices



Switches/breakers		Distribution board		
No. of tiers	MW	Height outside	Width outside	
1	12	200 mm	300 mm	8GK6352-2KK13
	24	150 mm	600 mm	8GK6302-1KK23
		200 mm	600 mm	8GK6352-2KK23
	36	150 mm	900 mm	8GK6302-1KK33
		200 mm	900 mm	8GK6352-2KK33

Accessories

DIN rails



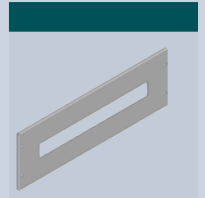
Version	Width	No. of tiers	Article No.
For mounting modular devices at various depths	600 mm	1	8GF9670
	900 mm	1	8GF9671

Depth adapters 9 mm



Version	Width	No. of tiers	MW	Article No.
For linking 5SY and 5SJ on DIN rails, L 360 mm	600 mm	1	20	8GF9670-1

For front cover with cutout



Switches/breakers No. of tiers	MW	Distribution board			
		Height outside	Width outside		
1	24	150 mm	600 mm	8GK9608-1KK22	
	24	200 mm	600 mm	8GK9608-1KK20	
	36	150 mm	900 mm	8GK9608-1KK32	
		200 mm	900 mm	8GK9608-1KK30	
2	48	300 mm	600 mm	8GK9608-2KK22	
		400 mm	600 mm	8GK9608-2KK20	
	72	300 mm	900 mm	8GK9608-2KK32	
		400 mm	900 mm	8GK9608-2KK30	
	108	450 mm	600 mm	8GK9608-3KK22	
		600 mm	600 mm	8GK9608-4KK20	
		600 mm	600 mm	900 mm	8GK9608-4KK30
			900 mm	900 mm	

Accessories

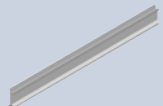
DIN rails

Version	Width	No. of tiers	Article No.
For mounting modular devices at various depths	600 mm	1	8GF9670
	900 mm	1	8GF9671



Depth adapters 9 mm

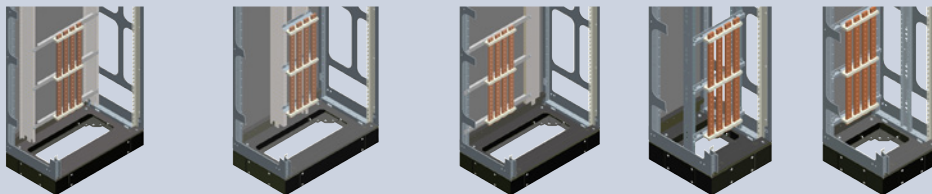
Version	Width	No. of tiers	MW	Article No.
For linking 5SY and 5SJ on DIN rails, L 360 mm	600 mm	1	20	8GF9670-1



Busbars

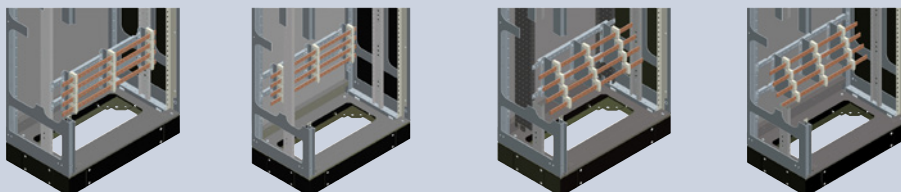
For ALPHA 800/630 UNIVERSAL distribution boards

Vertical installation of rear busbars (single bars only)



Version	Width 600/900 mm	For a spacing of 150 mm, width 600/900 mm	Recessed, width 600/900 mm	Width 300 mm	Recessed, width 300 mm
Busbar supports:	8GF5764/65 (width 600 mm) 8GF5766/67 (width 900 mm)	8GF5762/63	8GF5764/65 (width 600 mm) 8GF5766/67 (width 900 mm)	8GF5768/70	8GF5768/70
Supplements:	Rear universal supports	8GK6850-0KK05/06 (2 units)	8GK6850-0KK05/06 (1 unit)	–	–

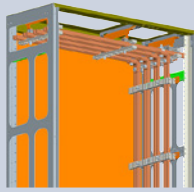
Horizontal busbars (single bars only)



Version	Front	Recessed	Front, with steps	Recessed, with steps
Busbar supports:	8GF5762/63	8GF5762/63	8GF5760/61	8GF5760/61
Supplements:	Holders 8GF9652 (width 600 mm) 8GF9653 (width 900 mm)	8GF9652 (width 600 mm) 8GF9653 (width 900 mm)	8GK9920-0KK35 (width 600 mm) 8GK9920-0KK36 (width 900 mm)	8GF9652 (width 600 mm) 8GF9653 (width 900 mm)
	Rear universal supports	–	8GK6850-0KK05/06 (2 units)	–

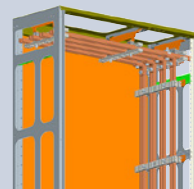
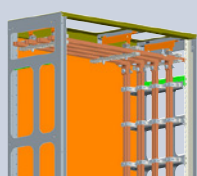
For ALPHA 800 UNIVERSAL distribution boards

Horizontal busbars at top (double bars only)




Version		
Busbar supports	With support plate	8GK9750-0KK02
	Without support plate	8PQ4000-1BA12
Supplements	If there is no support 8GK9750-0KK02 mounted onto the side of the cabling compartment, you will need to order an upper crossbar 8GK6850-0KK00.	


Vertical busbars, for sides




Version		Double busbar with steps	Single busbar with steps	Double busbar	Busbar
Busbar supports:		8GK9750-0KK01	8GF5760/61	8GK9750-0KK02	8GF5762/63
Supplements	Lateral crossbar	8GK6850-0KK01	8GK6850-0KK01	8GK6850-0KK01	8GK6850-0KK01

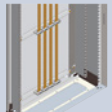
Busbars


		ALPHA 630	ALPHA 800
Copper busbars			
	Busbar cross-section	Length	Article No.
	15 × 5 mm	2000 mm	8GF5751
		1300 mm	8GF5771
	20 × 5 mm	2000 mm	8GF5737
		1300 mm	8GF5772
	30 × 5 mm	2000 mm	8GF5742
	1300 mm	8GF5773	
30 × 10 mm	2000 mm	8GF5752	
	1300 mm	8GF5774	

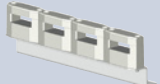
		ALPHA 630	ALPHA 800
Copper grounding bars			
	Busbar cross-section	Length	Width
	20 × 5 mm	1300/2000 mm	600 mm
			900 mm
			Article No.
			Article No.
			8GK9920-0KK10
			8GK9920-0KK13

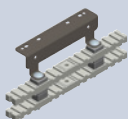
Busbar supports

		ALPHA 630	ALPHA 800
Vertical, at side/horizontal, at front, graded			
	Busbar cross-section	Width	Number of poles
	15/20/30 × 5 mm	600/900 mm	4-pole
	30 × 10 mm	600/900 mm	4-pole
	15/20/30 × 10 mm	600/900 mm	4-pole
	20/30 × 10 mm	600/900 mm	4-pole
		Busbar center-to-center spacing	Article No.
		50 mm	8GF5760
		50 mm	8GF5761
		50 mm	–
		50 mm	8GK9750-0KK01
		50 mm	–
		50 mm	8GK9750-0KK02

		ALPHA 630	ALPHA 800
Vertical			
	Busbar cross-section	Width	Number of poles
	15/20/30 × 5 mm	300 mm	4-pole
	30 × 10 mm	300 mm	4-pole
		Busbar center-to-center spacing	Article No.
		50 mm	8GF5768
		50 mm	8GF5770



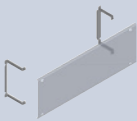


		ALPHA 630	ALPHA 800
Vertical, at rear			
	Busbar cross-section	Width	Number of poles
	15/20/30 × 5 mm	600 mm	4-pole
		900 mm	4-pole
	30 × 10 mm	600 mm	4-pole
		900 mm	4-pole
		Busbar center-to-center spacing	Article No.
		50 mm	8GF5764
		50 mm	8GF5766
		50 mm	8GF5765
		50 mm	8GF5767

		ALPHA 630	ALPHA 800
Horizontal, at front¹⁾			
	Busbar cross-section	Width	Number of poles
	15/20/30 × 5 mm	300/600/900 mm	4-pole
	30 × 10 mm	300/600/900 mm	4-pole
		600/900 mm	4-pole
		Busbar center-to-center spacing	Article No.
		50 mm	8GF5762
		50 mm	8GF5763
		50 mm	–
		50 mm	8GK9608-1KK22

		ALPHA 630	ALPHA 800
Horizontal, at top			
	Busbar cross-section	Width	Number of poles
	20/30 × 10 mm	600/900 mm	4-pole
		Busbar center-to-center spacing	Article No.
		50 mm	–
		50 mm	8GK9750-0KK02
		50 mm	8PQ4000-1BA12

¹⁾ Can be mounted directly on device holders with a clearance of 525 mm (width 600 mm) and 825 mm (width 900 mm).

Other accessories

				ALPHA 630	ALPHA 800
Set of screws/bolts for slotted bars					
	Cross-section	Outer thread	Tightening torque	Article No.	Article No.
	15/20/30 × 5 mm	M6	8 Nm	8GF5891	8GF5891
	30 × 10 mm	M8	20 Nm	8GF5892	8GF5892
Crossbars for installation of support					
	Version	Width		Article No.	Article No.
	Für 8GF5762, 8GF5760, 8GF5763, 8GK9608-1KK22	600 mm		8GF9652	8GF9652
		900 mm		8GF9653	8GF9653
	Für 8GF5760	600 mm		8GK9920-0KK35	8GK9920-0KK35
		900 mm		8GK9920-0KK36	8GK9920-0KK36
	Für 8GK9750-0KK02	400 mm		–	8GK6850-0KK00
Für 8GF5760, 8GF5768, 8GF5761, 8GF5770, 8GK9750-0KK01, 8GK9750-0KK02	400 mm		–	8GK6850-0KK01	
Transparent cover					
	Version	Width		Article No.	Article No.
	For horizontal busbars, at front	600 mm		8GK9920-0KK37	8GK9920-0KK37
		900 mm		8GK9920-0KK38	8GK9920-0KK38
Connection kit for double bars					
	Version	Current		Article No.	Article No.
	Connection kit for upper horizontal bars – vertical busbars	800 A		–	8GK9790-0KK00
	Connection kit for upper horizontal busbars	800 A		–	8GK9790-0KK01
Holder for grounding bar					
				Article No.	Article No.
				–	8GK9750-0KK00

Accessories

Covers and holders

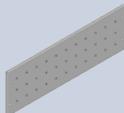
125 630 800

Covers for mounting measuring instruments




Measuring devices	Type	Height	Width	Article No.	125	630	800
72 × 72	2 instruments + 2 selectors	200 mm	600 mm	8GK9610-1KK20	■	■	■
			900 mm	8GK9610-1KK30	■	■	■
	4 instruments + 1 selector	200 mm	600 mm	8GK9611-1KK20	■	■	■
			900 mm	8GK9611-1KK30	■	■	■
96 × 96	2 instruments + 2 selectors	200 mm	600 mm	8GK9612-1KK20	■	■	■
			900 mm	8GK9612-1KK30	■	■	■
	4 instruments + 1 selector	200 mm	600 mm	8GK9613-1KK20	■	■	■
			900 mm	8GK9613-1KK30	■	■	■

Covers for pushbuttons and indicator lights



Height	Width	Article No.	125	630	800
200 mm	600 mm	8GK9630-1KK20	■	■	■
	900 mm	8GK9631-1KK20	■	■	■

Non-transparent covers

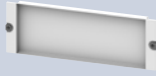


Height	Width	Article No.	125	630	800
50 mm	600 mm	8GK9620-1KK20	■	■	■
	900 mm	8GK9620-1KK30	■	■	■
100 mm	600 mm	8GK9621-1KK20	■	■	■
	900 mm	8GK9621-1KK30	■	■	■
150 mm	600 mm	8GK9622-1KK20	■	■	■
		8GK9622-1KK30	■	■	■
	300 mm	8GK9607-1KK10	■	■	■
		8GK9623-1KK20	■	■	■
200 mm	600 mm	8GK9623-1KK30	■	■	■
		8GK9606-2KK10	■	■	■
	300 mm	8GK9607-2KK10	■	■	■
		8GK9622-2KK20	■	■	■
400 mm	250 mm	8GK9622-2KK30	■	■	■
		8GK9606-4KK10	■	■	■
	300 mm	8GK9607-4KK10	■	■	■
		8GK9622-4KK20	■	■	■
600 mm	600 mm	8GK9622-4KK30	■	■	■
		8GK9606-5KK10	■	■	■
	900 mm	8GK9607-5KK10	■	■	■
		8GK9622-5KK20	■	■	■
800 mm	250 mm	8GK9622-5KK30	■	■	■
		8GK9606-7KK10	■	■	■
	300 mm	8GK9607-7KK10	■	■	■
		8GK9607-7KK10	■	■	■
1000 mm	250 mm	8GK9606-7KK10	■	■	■
	300 mm	8GK9607-7KK10	■	■	■

Deep-drawn covers 25 mm

Height	Width	Article No.	125	630	800
800 mm	600 mm	8GK9635-5KK20	■	■	■
	900 mm	8GK9635-5KK30	■	■	■
1000 mm	600 mm	8GK9636-7KK20	■	■	■
	900 mm	8GK9636-7KK30	■	■	■

Deep-drawn front covers 35 mm

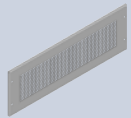


Height	Width	Article No.	125	630	800
200 mm	600 mm	8GK9605-1KK20	■	■	■
	900 mm	8GK9605-1KK30	■	■	■
400 mm	600 mm	8GK9605-2KK20	■	■	■
	900 mm	8GK9605-2KK30	■	■	■
600 mm	600 mm	8GK9605-4KK20	■	■	■
	900 mm	8GK9605-4KK30	■	■	■

Covers and holders

125 630 800

Covers with ventilation openings IP30



Height	Width	Article No.	125	630	800
200 mm	600 mm	8GK9632-1KK20	■	■	■
	900 mm	8GK9633-1KK20	■	■	■

Holders for horizontal cable ducts/horizontal busbars (pair)



Width	Article No.	125	630	800
600 mm	8GF9652	■	■	■
900 mm	8GF9653	■	■	■

Horizontal crossbars with steps (pair)



Width	Article No.	125	630	800
600 mm	8GK9920-0KK35	■	■	■
900 mm	8GK9920-0KK36	■	■	■

Support rails (pair)

- ALPHA 630 UNIVERSAL vertical/horizontal busbar support, with steps
- Vertical side terminal strip (not suitable for use in ALPHA 800 UNIVERSAL)



Height	Article No.	125	630	800
1000 mm	8GF9655	■	■	■
1200 mm	8GF9656	■	■	■
1600 mm	8GF9650	■	■	■
1800 mm	8GF9658	■	■	■
2000 mm	8GF9654	■	■	■

Inner supports

- For using cubicle B 300 as a switchgear compartment in ALPHA 630 UNIVERSAL (not suitable for use in ALPHA 800 UNIVERSAL)



Height	Article No.	125	630	800
1600 mm	8GK9126-8KK03	■	■	■
1800 mm	8GK9126-8KK04	■	■	■
2000 mm	8GK9126-8KK05	■	■	■

Accessories

Mounting plates and inner separations

125 630 800

Modular mounting plates



- ALPHA 800 UNIVERSAL: for mounting on side supports or on the base of the cabinet

Height	Width	Article No.	125	630	800
200 mm	600 mm	8GF7155	■	■	■
	900 mm	8GF7158	■	■	■
400 mm	600 mm	8GF7156	■	■	■
	900 mm	8GF7160	■	■	■
600 mm	600 mm	8GF7157	■	■	■
	900 mm	8GF7161	■	■	■

Recessed modular mounting plates



- ALPHA 800 UNIVERSAL: for mounting on two rear supports or on the rear panel of the cabinet with one rear support

Height	Width	Article No.	125	630	800
200 mm	600 mm	8GF9676	■	■	■
	900 mm	8GF9680	■	■	■
400 mm	600 mm	8GF9677	■	■	■
	900 mm	8GF9681	■	■	■
600 mm	600 mm	8GF9678	■	■	■
	900 mm	8GF9682	■	■	■

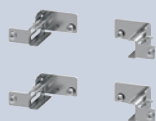
2 mm mounting plates for electrotechnical use with height and width of the cabinet



- ALPHA 800 UNIVERSAL: Plates that are not as high as the cabinet can be mounted using side supports and holders 8GF9652/3

Height	Width	Article No.	125	630	800
600 mm	600 mm	8GK9535-4KK21	■	■	■
800 mm	600 mm	8GK9535-5KK21	■	■	■
1000 mm	600 mm	8GK9536-7KK21	■	■	■
	900 mm	8GK9536-7KK31	■	■	■
1200 mm	600 mm	8GK9537-8KK21	■	■	■
	900 mm	8GK9537-8KK31	■	■	■
1600 mm	600 mm	8GK9535-8KK23	■	■	■
	900 mm	8GK9535-8KK26	■	■	■
1800 mm	600 mm	8GK9535-8KK24	■	■	■
	900 mm	8GK9535-8KK34	■	■	■
2000 mm	600 mm	8GK9535-8KK25	■	■	■
	900 mm	8GK9535-8KK35	■	■	■

Adjustable depth brackets for mounting plates



Distribution board depth	Article No.	125	630	800
250 mm	8GK9930-0KK03		■	

Partitions for ALPHA 630 UNIVERSAL



Mounting	Height	Width	Article No.	125	630	800
Horizontal	-	250 mm	8GK9525-0KK03		■	
		300 mm	8GK9525-0KK13		■	
		600 mm	8GK9525-0KK23		■	
		900 mm	8GK9525-0KK33		■	
Vertical	800 mm	-	8GK9525-5KK03		■	
	1000 mm	-	8GK9525-6KK03		■	
	1200 mm	-	8GK9525-7KK03		■	
	1600 mm	-	8GK9525-8KK03		■	
	1800 mm	-	8GK9525-8KK13		■	
	2000 mm	-	8GK9525-8KK23		■	

Mounting plates and inner separations

125 630 800

Partitions for ALPHA 800 UNIVERSAL in cabinets in form 2b

Mounting	Height	Width	Article No.	125	630	800
 Horizontal separation between devices	–	300 mm	8GK9526-0KK06			■
		600 mm	8GK9526-0KK07			■
		900 mm	8GK9526-0KK08			■
 Horizontal separation between upper busbar compartment and devices	–	250 mm	8GK9527-0KK05			■
		300 mm	8GK9526-0KK03			■
		600 mm	8GK9526-0KK04			■
		900 mm	8GK9526-0KK05			■
 Vertical separation between the switchgear compartment and busbar compartment	1600 mm	600 mm	8GK9526-0KK00			■
	1800 mm	600 mm	8GK9526-0KK01			■
	2000 mm	600 mm	8GK9526-0KK02			■

Transparent covers

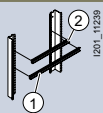
Width	Article No.	125	630	800
 250 mm	8GK9527-0KK03	■	■	■
300 mm	8GK9527-0KK00	■	■	■
600 mm	8GK9527-0KK01	■	■	■
900 mm	8GK9527-0KK02	■	■	■

Accessories

Holders for terminal strips and locking systems

125 630 800

DIN rails for terminal blocks



Type	Height	Width	Article No.	125	630	800
Horizontal	–	600 mm	8GF9672	■	■	■
		900 mm	8GF9674	■	■	■
Horizontal, recessed	–	600 mm	8GF9673	■	■	■
		900 mm	8GF9675	■	■	■
Vertical with 3 mounting rails	200 mm	600 mm	8GF7175	■	■	■
	400 mm	600 mm	8GF7176	■	■	■
Vertical with 5 mounting rails	–	900 mm	8GF7178	■	■	■
	400 mm	900 mm	8GF7180	■	■	■

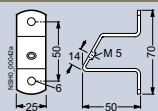
Holder for vertical terminal strips in side compartment L = 900 mm



- ALPHA 800 UNIVERSAL: Each holder must be mounted onto a lateral crossbar

Width	Article No.	125	630	800
600/900 mm	8GF9683	■	■	■

Mounting brackets



Version	Width	Article No.	125	630	800
For angular mounting of the terminal blocks	600/900 mm	8WA746	■	■	■

Holders for DIN rails

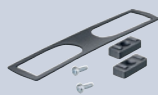
Version	Scope of supply	Width	Article No.	125	630	800
For mounting the terminal strip vertically in the cabling compartment	4 units	600/900 mm	8GK9920-0KK28	■	■	■

Standard locking devices for wall-mounted distribution boards



Material	Width	Article No.	125	630	800
Made of plastic, black (spare part)	600/900 mm	8GK9560-0KK04	■	■	■

Seals for standard locking devices



Degree of protection	Width	Article No.	125	630	800
IP55	600/900 mm	8GK9560-0KK05	■	■	■

Rotary handle locking mechanism



- For wall-mounted distribution boards, IP43 and IP55, semicylinder insert possible for E012

Width	Article No.	125	630	800
600/900 mm	8GK9560-0KK06	■	■	■

Profile semicylinders E012

- Insert and key



Width	Article No.	125	630	800
600/900 mm	8GK9560-0KK07	■	■	■

Locking systems for floor-mounted distribution boards



Type	Width	Article No.	125	630	800
Espagnolette lock with pushbutton (spare part)	600/900 mm	8GK9561-0KK01	■	■	■
Insert for profile semicylinder with key	600/900 mm	8GK9561-0KK02	■	■	■
Profile semicylinder, 40 mm with lock E012 (for use only with espagnolette lock)	600/900 mm	8GK9561-0KK00	■	■	■


Further accessories

125 630 800

Assembly kits for mounting flat pack cabinets for self-assembly, IP43

	Height	Article No.			
	400 mm	8GK9126-3KK00	■	■	■
600 mm	8GK9126-4KK00	■	■	■	
800 mm	8GK9126-5KK00	■	■	■	
1000 mm	8GK9126-6KK00	■	■	■	
1200 mm	8GK9126-7KK00	■	■	■	
1600 mm	8GK9126-8KK00	■	■	■	
1800 mm	8GK9126-8KK01	■	■	■	
2000 mm	8GK9126-8KK02	■	■	■	


Z-shaped crossbar for lifting the flat pack for self-assembly

	Height	Article No.			
	600 mm	8GK9127-0KK01	■	■	■
900 mm	8GK9127-0KK02	■	■	■	
1200 mm	8GK9127-0KK03	■	■	■	
1500 mm	8GK9127-0KK04	■	■	■	
1800 mm	8GK9127-0KK05	■	■	■	

Z-shaped crossbar for mounting and vertical linking of wall-mounted distribution boards

	Height	Article No.			
	1200 mm	8GK9920-0KK43	■	■	■
1400 mm	8GK9920-0KK44	■	■	■	
1600 mm	8GK9920-0KK45	■	■	■	
1800 mm	8GK9920-0KK46	■	■	■	


Flange plates for flat pack delivery (optional)

	Height	Article No.			
	300 mm	8GK9120-0KK10	■	■	■
600 mm	8GK9120-0KK20	■	■	■	


Ventilation grilles – side panels

	Scope of supply	Article No.			
	4 units	8GK9120-0KK30	■	■	■


Spare part hinges for doors for wall/floor-mounted distribution boards

	Scope of supply	Article No.			
	2 units	8GK9920-0KK24	■	■	■

Hinges for front covers

	Scope of supply	Article No.			
	10 units	8GK9120-0KK11	■	■	■

Hinges for masking frames

	Article No.			
	8PQ2000-0BA08	■	■	■

Accessories

Further accessories

125 630 800

Quick-lock screws for ALPHA cabinets with ¼ turn



Scope of supply

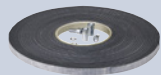
20 units

Article No.

8GK9562-0KK00

■ ■ ■

Mounting kit for modular distribution boards, IP55 (incl. seal)



Article No.

8GK9920-0KK31

■ ■ ■

Self-tapping screws M6 × 10



Scope of supply

10 units

Article No.

8GF9662

■ ■ ■

Captive nuts M6

Scope of supply

100 units

Article No.

8GF9643

■ ■ ■

Transport eyebolts



Scope of supply

4 units

Article No.

8GF9660

■ ■ ■

Key for double-bit interlocking mechanism



Article No.

8GD9290

■ ■ ■

Siemens nameplate

Material	Version	Color
Aluminum	Self-adhesive	Petrol
Sticker, foil	Self-adhesive	Petrol

Article No.

8GD9084

■ ■ ■

8GF9661

■ ■ ■

Circuit diagram pockets



Types	Depth
DIN A3, made of sheet steel	10 mm
DIN A4, transparent sleeve, adhered all-over	10 mm
DIN A4, made of plastic	30 mm
DIN A4, large pack, made of plastic	30 mm

Article No.

8GK9910-0KK22

■ ■ ■

8GK9910-0KK23

■ ■ ■

8GD9132

■ ■ ■

8GK9910-1KK24

■ ■ ■

Blanking cover for modular installation devices



Version

For 12 modular widths (1 MW = 18 mm)

Article No.

8GK9910-0KK00

■ ■ ■

Cover strips



Length

1 m

Article No.

8GK9910-0KK01

■ ■ ■

Spare brackets for flat pack assembly

Scope of supply

2 units

Article No.

8GK9920-0KK26

■ ■ ■

Failsafe kit ALPHA

- Self-tapping screws, captive nuts, hinges for covers, covers etc.

Article No.

8GK9920-0KK32

■ ■ ■

Wall-mounting brackets

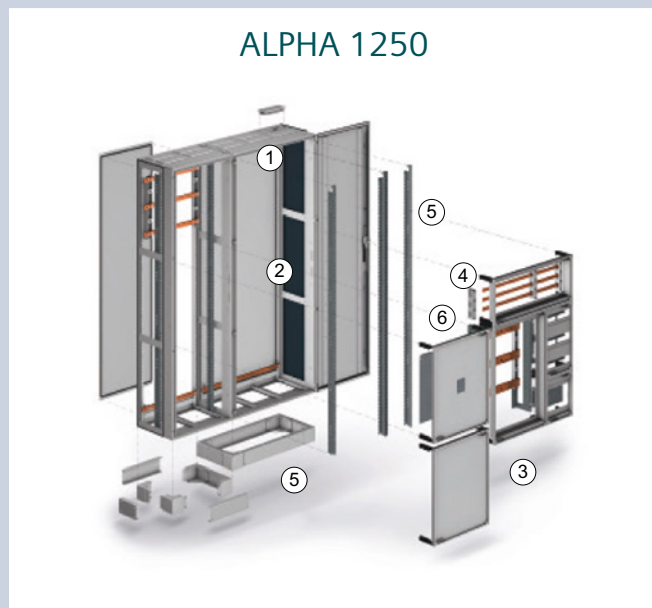
Article No.

8GK9920-0KK33

■ ■ ■

System overview

Distribution boards, assembly kits and accessories



1 Unequipped distribution boards



ALPHA 1250



ALPHA 630



ALPHA 630



ALPHA 400



ALPHA 160



ALPHA SIMBOX XL and WP

2 Quick-assembly kits



ALPHA 1250/630/400



ALPHA 160

3 Assembly kits



For modular installation devices



For terminal blocks



For fuse switch disconnectors



For switch disconnectors



For molded case circuit breakers



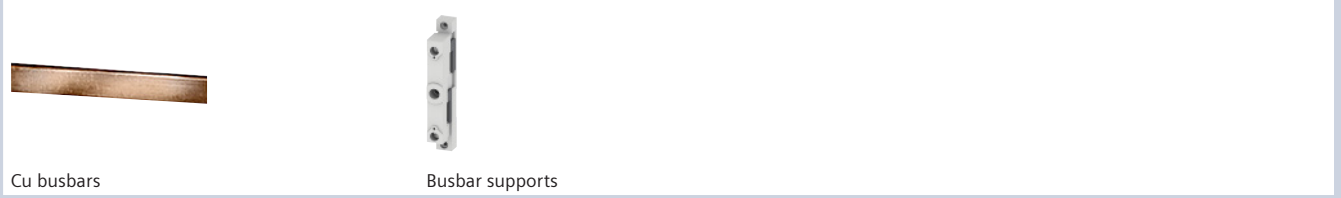
For busbar-adaptable units

Note:

You will find a detailed range of accessories with the basic units and in the Accessories section.



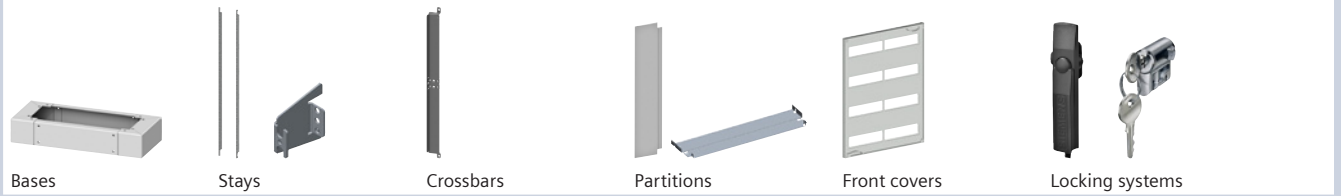
4 Busbars



Cu busbars

Busbar supports

5 Mechanical accessories



Bases

Stays

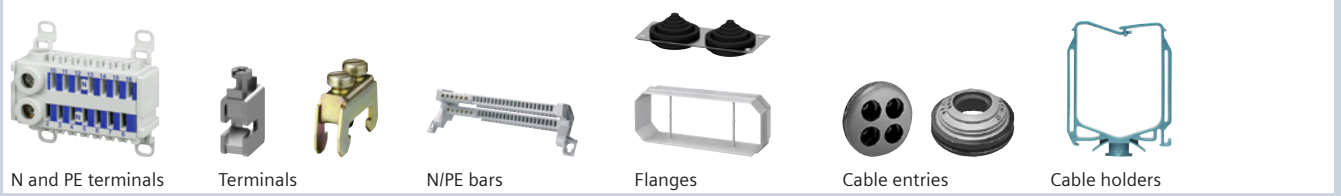
Crossbars

Partitions

Front covers

Locking systems

6 Electrical accessories



N and PE terminals

Terminals

N/PE bars

Flanges

Cable entries

Cable holders

Note:
You will find a detailed range of accessories with the basic units and in the Accessories section.


Special colors for ALPHA

Additional options

To specify the options, add "-Z" to the complete article number and indicate the appropriate order code(s).




8GK.....-.....-..... -Z

Order code

	RAL 1003, signal yellow	Semi-gloss				C	2	7
	RAL 2000, yellow orange	Semi-gloss				C	2	5
	RAL 3000, flame red	Silky gloss				C	3	1
	RAL 5005, signal blue	Semi-gloss				C	2	3
	RAL 5010, gentian blue	Semi-gloss				C	2	4
	RAL 5017, traffic blue	Silky gloss				C	2	2
	RAL 6018, yellow green	Semi-gloss				C	2	6
	RAL 7032, pebble gray	Semi-gloss				C	1	3
	RAL 7033, cement gray	Semi-gloss				C	2	8
	RAL 7035, light gray	Semi-gloss		Smooth		C	1	1
				Surface structure		C	1	2
	RAL 7038, agate gray	Semi-gloss				C	1	4
	RAL 9001, cream	Semi-gloss				C	2	1
	RAL 9002, gray white	Semi-gloss				C	1	9
		Silky gloss				C	2	9
	RAL 9003, signal white	Semi-gloss				C	2	0
	RAL 9005, jet black	Semi-gloss				C	1	7
	RAL 9010, pure white	Semi-gloss		Smooth		C	1	5
				Surface structure		C	3	0
	RAL 9016, traffic white	Semi-gloss				C	1	0

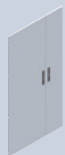
ALPHA 1250 floor-mounted distribution boards

Rated current 1250 A

		Unequipped distribution boards With open side panel		Degree of protection		Unequipped distribution boards for isolating transformers With open side panel		Unequipped distribution boards for isolating transformers With closed side panel	
				IP55		IP30		IP30	
									
Height	Depth	Tiers	Width	Protection class I		Protection class I		Protection class I	
Outside	Inside	Outside (MW = 18 mm)	Outside	Inside					
1950 mm	1800 mm	400 mm	max. 12 MW	300 mm	250 mm	8GK1423-8KK15	8GK1483-8KP15	8GK1483-8KN15	
				550 mm	500 mm	8GK1423-8KK25	8GK1483-8KP25	8GK1483-8KN25	
				800 mm	750 mm	8GK1423-8KK35	8GK1483-8KP35	8GK1483-8KN35	
				1050 mm	1000 mm	8GK1423-8KK45	8GK1483-8KP45	8GK1483-8KN45	
				1300 mm	1250 mm	8GK1423-8KK55	–	–	

Accessories

Spare part doors



Height	Cubicle width	Door version	Door width	Article No.	
1950 mm	300 mm	Complete	300 mm	8GK9513-8KK10	
	550 mm	Complete	550 mm	8GK9513-8KK20	
	800 mm		Left	525 mm	8GK9513-8KK30
			Right	275 mm	8GK9513-8KK40
	1050 mm		Left	525 mm	8GK9513-8KK30
			Right	525 mm	8GK9513-8KK50
	1300 mm		Left	775 mm	8GK9513-8KK60
			Right	525 mm	8GK9513-8KK50

Side panels, modular distribution board



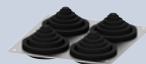
Depth	Article No.
400 mm	8GK9520-0KK05

Assembly kits for masking frame for front cover



		Article No.
<ul style="list-style-type: none"> For mounting the mounting stays at the rear of the modular distribution board 		
Height	Width	Article No.
1800 mm	250 mm	8GK9913-0KK10
	500 mm	8GK9913-0KK20
	750 mm	8GK9913-0KK30
	1000 mm	8GK9913-0KK40
	1250 mm	8GK9913-0KK50

Flange plates with rubber sleeve



		Article No.
<ul style="list-style-type: none"> For lower flange opening (sheet steel closed) 		
Number of rubber sleeves		Article No.
1		8GK9100-0KK14
2		8GK9100-0KK15
3		8GK9100-0KK16
4		8GK9100-0KK17

Busbar supports



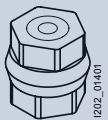
- Busbar spacing 100/185 mm

Type	Article No.
With matching support plate for mounting on the rear panel	8GK9720-0KK00
Without support plate for mounting on the busbar (no fixing to the cabinet enclosure)	8GK9720-0KK01

PEN bar holders and N/PE busbar supports

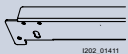
Type	Article No.
PEN bar holder	8GK9721-0KK00

Pin insulator for N busbar



Version	Article No.
1P with M10 female thread and holder	8GK9110-0KK00

Crossbar N/PEN pin insulators and/or holders for PEN bars



Width	Article No.
250 mm	8GK4854-0KK10
500 mm	8GK4854-0KK20
750 mm	8GK4854-0KK30
1000 mm	8GK4854-0KK40
1250 mm	8GK4854-0KK50

Longitudinal stays



Height	Depth	Article No.
1800 mm	250/320/400 mm	8GK4853-8KK02

ALPHA 1250 marshaling boxes

Rated current 630 A

Marshaling boxes

Degree of protection IP55



Height Outside	Depth Outside	Width Outside	Inside	Protection class I
500 mm	400 mm	300 mm	250 mm	8GK1383-1KK15
		550 mm	500 mm	8GK1383-1KK25
		800 mm	750 mm	8GK1383-1KK35
		1050 mm	1000 mm	8GK1383-1KK45
		1300 mm	1250 mm	8GK1383-1KK55
650 mm	400 mm	300 mm	250 mm	8GK1383-2KK15
		550 mm	500 mm	8GK1383-2KK25
		800 mm	750 mm	8GK1383-2KK35
		1050 mm	1000 mm	8GK1383-2KK45
		1300 mm	1250 mm	8GK1383-2KK55

ALPHA 630 floor-mounted distribution boards

Rated current 630 A

Unequipped distribution boards

Welded and riveted

Degree of protection IP44



Height Outside	Inside	Depth Outside	Tiers/MW	Width Outside	Inside	Protection class I	Protection class II	
1950 mm	1800 mm	210 mm	12/144	300 mm	250 mm	8GK1322-8KA12	8GK1332-8KA12	
			24/288	550 mm	500 mm	8GK1322-8KA22	8GK1332-8KA22	
			36/432	800 mm	750 mm	8GK1322-8KA32	8GK1332-8KA32	
			48/576	1050 mm	1000 mm	8GK1322-8KA42	8GK1332-8KA42	
			60/720	1300 mm	1250 mm	8GK1322-8KA52	8GK1332-8KA52	
		250 mm	12/144	300 mm	250 mm	–	–	
			24/288	550 mm	500 mm	–	–	
			36/432	800 mm	750 mm	–	–	
			48/576	1050 mm	1000 mm	–	–	
			60/720	1300 mm	1250 mm	–	–	
			320 mm	12/144	300 mm	250 mm	–	–
				24/288	550 mm	500 mm	–	–
36/432	800 mm	750 mm		–	–			
48/576	1050 mm	1000 mm		–	–			
60/720	1300 mm	1250 mm		–	–			

Accessories

Spare part doors

Height	Cubicle width	Door version	Door width	Article No.	
1950 mm	300 mm	Complete	300 mm	8GK9513-8KK10	
	550 mm	Complete	550 mm	8GK9513-8KK20	
	800 mm		Left	525 mm	8GK9513-8KK30
			Right	275 mm	8GK9513-8KK40
	1050 mm		Left	525 mm	8GK9513-8KK30
			Right	525 mm	8GK9513-8KK50
	1300 mm		Left	775 mm	8GK9513-8KK60
			Right	525 mm	8GK9513-8KK50

Side panels, modular distribution board

Depth	Article No.
250/320 mm	8GK9520-0KK03

Assembly kits for masking frame for front cover

Height	Width	Article No.
1800 mm	250 mm	8GK9913-0KK10
	500 mm	8GK9913-0KK20
	750 mm	8GK9913-0KK30
	1000 mm	8GK9913-0KK40
	1250 mm	8GK9913-0KK50

With closed side panel		With open side panel		Flat pack	
IP55		IP55		IP43	
Protection class I		Protection class II		Protection class I	
Protection class I		Protection class II		Protection class I	
–	–	–	–	8GK1302-8KK12	8GK1312-8KK12
–	–	–	–	8GK1302-8KK22	8GK1312-8KK22
–	–	–	–	8GK1302-8KK32	8GK1312-8KK32
–	–	–	–	8GK1302-8KK42	8GK1312-8KK42
–	–	–	–	8GK1302-8KK52	8GK1312-8KK52
8GK1323-8KN13	8GK1333-8KN13	8GK1323-8KP13	–	–	–
8GK1323-8KN23	8GK1333-8KN23	8GK1323-8KP23	–	–	–
8GK1323-8KN33	8GK1333-8KN33	8GK1323-8KP33	–	–	–
8GK1323-8KN43	8GK1333-8KN43	8GK1323-8KP43	–	–	–
8GK1323-8KN53	8GK1333-8KN53	8GK1323-8KP53	–	–	–
8GK1323-8KN14	8GK1333-8KN14	8GK1323-8KP14	–	–	–
8GK1323-8KN24	8GK1333-8KN24	8GK1323-8KP24	–	–	–
8GK1323-8KN34	8GK1333-8KN34	8GK1323-8KP34	–	–	–
8GK1323-8KN44	8GK1333-8KN44	8GK1323-8KP44	–	–	–
8GK1323-8KN54	8GK1333-8KN54	8GK1323-8KP54	–	–	–

ALPHA 630 marshaling boxes

Rated current 630 A



Height Outside	Depth Outside	Width		Protection class I		
		Outside	Inside			
350 mm	210 mm ¹⁾	300 mm	250 mm	8GK1382-0KK12	–	
		550 mm	500 mm	8GK1382-0KK22	–	
		800 mm	750 mm	8GK1382-0KK32	–	
		1050 mm	1000 mm	8GK1382-0KK42	–	
		1300 mm	1250 mm	8GK1382-0KK52	–	
	250 mm	300 mm	250 mm	–	8GK1383-0KK13	
		550 mm	500 mm	–	8GK1383-0KK23	
		800 mm	750 mm	–	8GK1383-0KK33	
		1050 mm	1000 mm	–	8GK1383-0KK43	
		1300 mm	1250 mm	–	8GK1383-0KK53	
	320 mm	300 mm	250 mm	–	8GK1383-0KK14	
		550 mm	500 mm	–	8GK1383-0KK24	
		800 mm	750 mm	–	8GK1383-0KK34	
		1050 mm	1000 mm	–	8GK1383-0KK44	
		1300 mm	1250 mm	–	8GK1383-0KK54	
500 mm	250 mm	300 mm	250 mm	–	8GK1383-1KK13	
		550 mm	500 mm	–	8GK1383-1KK23	
		800 mm	750 mm	–	8GK1383-1KK33	
		1050 mm	1000 mm	–	8GK1383-1KK43	
		1300 mm	1250 mm	–	8GK1383-1KK53	
	320 mm	300 mm	250 mm	–	8GK1383-1KK14	
		550 mm	500 mm	–	8GK1383-1KK24	
		800 mm	750 mm	–	8GK1383-1KK34	
		1050 mm	1000 mm	–	8GK1383-1KK44	
		1300 mm	1250 mm	–	8GK1383-1KK54	
	650 mm	250 mm	300 mm	250 mm	–	8GK1383-2KK13
			550 mm	500 mm	–	8GK1383-2KK23
			800 mm	750 mm	–	8GK1383-2KK33
			1050 mm	1000 mm	–	8GK1383-2KK43
			1300 mm	1250 mm	–	8GK1383-2KK53
320 mm		300 mm	250 mm	–	8GK1383-2KK14	
		550 mm	500 mm	–	8GK1383-2KK24	
		800 mm	750 mm	–	8GK1383-2KK34	
		1050 mm	1000 mm	–	8GK1383-2KK44	
		1300 mm	1250 mm	–	8GK1383-2KK54	

¹⁾ For flat pack distribution boards only

ALPHA 400 distribution boards

Rated current 400 A

Surface-mounting distribution boards

Flat pack

Degree of protection IP43



Height		Depth Outside	Tiers (MW = 18 mm)	Width		Protection class I	Protection class II
Outside	Inside			Outside	Inside		
500 mm	450 mm	210 mm	12 + 1 MW mountable	300 mm	250 mm	–	–
				550 mm	500 mm	–	–
650 mm	600 mm	210 mm	12 + 1 MW mountable	300 mm	250 mm	8GK1102-2KK12	8GK1112-2KK12
				550 mm	500 mm	8GK1102-2KK22	8GK1112-2KK22
				800 mm	750 mm	8GK1102-2KK32	8GK1112-2KK32
				1050 mm	1000 mm	8GK1102-2KK42	8GK1112-2KK42
800 mm	750 mm	210 mm	12 + 1 MW mountable	300 mm	250 mm	8GK1102-3KK12	8GK1112-3KK12
				550 mm	500 mm	8GK1102-3KK22	8GK1112-3KK22
				800 mm	750 mm	8GK1102-3KK32	8GK1112-3KK32
				1050 mm	1000 mm	8GK1102-3KK42	8GK1112-3KK42
950 mm	900 mm	210 mm	12 + 1 MW mountable	300 mm	250 mm	8GK1102-4KK12	8GK1112-4KK12
				550 mm	500 mm	8GK1102-4KK22	8GK1112-4KK22
				800 mm	750 mm	8GK1102-4KK32	8GK1112-4KK32
				1050 mm	1000 mm	8GK1102-4KK42	8GK1112-4KK42
				1300 mm	1250 mm	8GK1102-4KK52	8GK1112-4KK52
1100 mm	1050 mm	210 mm	12 + 1 MW mountable	300 mm	250 mm	8GK1102-5KK12	8GK1112-5KK12
				550 mm	500 mm	8GK1102-5KK22	8GK1112-5KK22
				800 mm	750 mm	8GK1102-5KK32	8GK1112-5KK32
				1050 mm	1000 mm	8GK1102-5KK42	8GK1112-5KK42
				1300 mm	1250 mm	8GK1102-5KK52	8GK1112-5KK52
1250 mm	1200 mm	210 mm	12 + 1 MW mountable	300 mm	250 mm	8GK1102-6KK12	8GK1112-6KK12
				550 mm	500 mm	8GK1102-6KK22	8GK1112-6KK22
				800 mm	750 mm	8GK1102-6KK32	8GK1112-6KK32
				1050 mm	1000 mm	8GK1102-6KK42	8GK1112-6KK42
				1300 mm	1250 mm	8GK1102-6KK52	8GK1112-6KK52
1400 mm	1350 mm	210 mm	12 + 1 MW mountable	300 mm	250 mm	8GK1102-7KK12	8GK1112-7KK12
				550 mm	500 mm	8GK1102-7KK22	8GK1112-7KK22
				800 mm	750 mm	8GK1102-7KK32	8GK1112-7KK32
				1050 mm	1000 mm	8GK1102-7KK42	8GK1112-7KK42
				1300 mm	1250 mm	8GK1102-7KK52	8GK1112-7KK52

Unequipped distribution boards		Flush-mounting distribution boards Unequipped distribution boards		
IP44		IP55		IP31
Protection class I	Protection class II	Protection class I	Protection class II	Protection class I
8GK1122-1KA12	–	–	–	–
8GK1122-1KA22	–	–	–	–
8GK1122-2KA12	8GK1132-2KA12	–	–	–
8GK1122-2KA22	8GK1132-2KA22	–	–	–
8GK1122-2KA32	8GK1132-2KA32	–	–	–
8GK1122-2KA42	8GK1132-2KA42	–	–	–
8GK1122-3KA12	8GK1132-3KA12	–	–	–
8GK1122-3KA22	8GK1132-3KA22	–	–	8GK1121-3KK22
8GK1122-3KA32	8GK1132-3KA32	–	–	8GK1121-3KK32
8GK1122-3KA42	8GK1132-3KA42	–	–	–
8GK1122-4KA12	8GK1132-4KA12	8GK1123-4KA12	8GK1133-4KA12	–
8GK1122-4KA22	8GK1132-4KA22	8GK1123-4KA22	8GK1133-4KA22	8GK1121-4KK22
8GK1122-4KA32	8GK1132-4KA32	8GK1123-4KA32	8GK1133-4KA32	8GK1121-4KK32
8GK1122-4KA42	8GK1132-4KA42	8GK1123-4KA42	8GK1133-4KA42	–
8GK1122-4KA52	8GK1132-4KA52	8GK1123-4KA52	8GK1133-4KA52	–
8GK1122-5KA12	8GK1132-5KA12	8GK1123-5KA12	8GK1133-5KA12	–
8GK1122-5KA22	8GK1132-5KA22	8GK1123-5KA22	8GK1133-5KA22	–
8GK1122-5KA32	8GK1132-5KA32	8GK1123-5KA32	8GK1133-5KA32	–
8GK1122-5KA42	8GK1132-5KA42	8GK1123-5KA42	8GK1133-5KA42	–
8GK1122-5KA52	8GK1132-5KA52	8GK1123-5KA52	8GK1133-5KA52	–
8GK1122-6KA12	8GK1132-6KA12	8GK1123-6KA12	8GK1133-6KA12	–
8GK1122-6KA22	8GK1132-6KA22	8GK1123-6KA22	8GK1133-6KA22	8GK1121-6KK22
8GK1122-6KA32	8GK1132-6KA32	8GK1123-6KA32	8GK1133-6KA32	8GK1121-6KK32
8GK1122-6KA42	8GK1132-6KA42	8GK1123-6KA42	8GK1133-6KA42	–
8GK1122-6KA52	8GK1132-6KA52	8GK1123-6KA52	8GK1133-6KA52	–
8GK1122-7KA12	8GK1132-7KA12	8GK1123-7KA12	8GK1133-7KA12	–
8GK1122-7KA22	8GK1132-7KA22	8GK1123-7KA22	8GK1133-7KA22	8GK1121-7KK22
8GK1122-7KA32	8GK1132-7KA32	8GK1123-7KA32	8GK1133-7KA32	8GK1121-7KK32
8GK1122-7KA42	8GK1132-7KA42	8GK1123-7KA42	8GK1133-7KA42	–
8GK1122-7KA52	8GK1132-7KA52	8GK1123-7KA52	8GK1133-7KA52	–

ALPHA 400 distribution boards

Rated current 400 A

Accessories

Spare part doors



Height	Cubicle width	Door version	Door width	Article No.
950 mm	300 mm	Complete	300 mm	8GK9510-6KK10
		Complete	550 mm	8GK9510-6KK20
	550 mm	Left	525 mm	8GK9510-6KK31
		Right	275 mm	8GK9510-6KK42
	800 mm	Left	525 mm	8GK9510-6KK31
		Right	525 mm	8GK9510-6KK52
	1050 mm	Left	775 mm	8GK9510-6KK51
		Right	525 mm	8GK9510-6KK52
1100 mm	300 mm	Complete	300 mm	8GK9510-7KK10
		Complete	550 mm	8GK9510-7KK20
	550 mm	Left	525 mm	8GK9510-7KK31
		Right	275 mm	8GK9510-7KK32
	800 mm	Left	525 mm	8GK9510-7KK31
		Right	525 mm	8GK9510-7KK42
	1050 mm	Left	775 mm	8GK9510-7KK41
		Right	525 mm	8GK9510-7KK42
1250 mm	300 mm	Complete	300 mm	8GK9510-8KK10
		Complete	550 mm	8GK9510-8KK20
	550 mm	Left	525 mm	8GK9510-8KK31
		Right	275 mm	8GK9510-8KK32
	800 mm	Left	525 mm	8GK9510-8KK31
		Right	525 mm	8GK9510-8KK52
	1050 mm	Left	775 mm	8GK9510-8KK41
		Right	525 mm	8GK9510-8KK52
1400 mm	300 mm	Complete	300 mm	8GK9510-8KK16
		Complete	550 mm	8GK9510-8KK26
	550 mm	Left	525 mm	8GK9510-8KK37
		Right	275 mm	8GK9510-8KK38
	800 mm	Left	525 mm	8GK9510-8KK37
		Right	525 mm	8GK9510-8KK58
	1050 mm	Left	775 mm	8GK9510-8KK47
		Right	525 mm	8GK9510-8KK58

ALPHA 160 distribution boards

Rated current 160 A

Surface-mounting distribution boards
Unequipped distribution boards

Degree of protection IP44







Height Outside	Inside	Depth Outside	Tiers/MW (MW = 18 mm)	Width		Protection class II
				Outside	Inside	
500 mm	450 mm	140 mm	3/36	300 mm	250 mm	8GK1032-1KK11
			3/72	550 mm	500 mm	8GK1032-1KK21
			3/108	800 mm	750 mm	8GK1032-1KK31
650 mm	600 mm	140 mm	4/48	300 mm	250 mm	8GK1032-2KK11
			4/96	550 mm	500 mm	8GK1032-2KK21
			4/144	800 mm	750 mm	8GK1032-2KK31
			4/192	1050 mm	1000 mm	8GK1032-2KK41
800 mm	750 mm	140 mm	5/60	300 mm	250 mm	8GK1032-3KK11
			5/120	550 mm	500 mm	8GK1032-3KK21
			5/180	800 mm	750 mm	8GK1032-3KK31
			5/240	1050 mm	1000 mm	8GK1032-3KK41
950 mm	900 mm	140 mm	6/72	300 mm	250 mm	8GK1032-4KK11
			6/144	550 mm	500 mm	8GK1032-4KK21
			6/216	800 mm	750 mm	8GK1032-4KK31
			6/288	1050 mm	1000 mm	8GK1032-4KK41
1100 mm	1050 mm	140 mm	7/84	300 mm	250 mm	8GK1032-5KK11
			7/168	550 mm	500 mm	8GK1032-5KK21
			7/252	800 mm	750 mm	8GK1032-5KK31
			7/336	1050 mm	1000 mm	8GK1032-5KK41





Flush-mounting distribution boards
Unequipped distribution boards

Degree of protection IP31



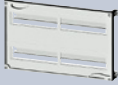

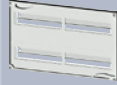

Height Outside	Inside	Depth Outside	Tiers/MW (MW = 18 mm)	Width		Protection class II
				Outside	Inside	
558 mm	450 mm	120 mm	3/36	358 mm	250 mm	8GK1031-1KK10
			3/72	608 mm	500 mm	8GK1031-1KK20
708 mm	600 mm	120 mm	4/48	358 mm	250 mm	8GK1031-2KK10
			4/96	608 mm	500 mm	8GK1031-2KK20
			4/144	858 mm	750 mm	8GK1031-2KK30
858 mm	750 mm	120 mm	5/60	358 mm	250 mm	8GK1031-3KK10
			5/120	608 mm	500 mm	8GK1031-3KK20
			5/180	858 mm	750 mm	8GK1031-3KK30
			5/240	1108 mm	1000 mm	8GK1031-3KK40
1008 mm	900 mm	120 mm	6/72	358 mm	250 mm	8GK1031-4KK10
			6/144	608 mm	500 mm	8GK1031-4KK20
			6/216	858 mm	750 mm	8GK1031-4KK30
			6/288	1108 mm	1000 mm	8GK1031-4KK40
1158 mm	1050 mm	120 mm	7/84	358 mm	250 mm	8GK1031-5KK10
			7/168	608 mm	500 mm	8GK1031-5KK20
			7/252	858 mm	750 mm	8GK1031-5KK30

Distribution boards with built-in distribution board panels			
Tier spacing 125 mm with N/PE plug-in terminal	Tier spacing 150 mm without N/PE plug-in terminal	Tier spacing 150 mm terminal blocks at top	Tier spacing 125 mm multimedia field
IP44 	IP44 	IP44 	IP44 
Protection class II	Protection class II	Protection class II	Protection class II
8GK1052-1KK11	8GK1062-1KK11	–	–
8GK1052-1KK21	8GK1062-1KK21	–	–
8GK1052-1KK31	8GK1062-1KK31	–	–
8GK1052-2KK11	8GK1062-2KK11	–	–
8GK1052-2KK21	8GK1062-2KK21	–	8GK1072-2KK21
8GK1052-2KK31	8GK1062-2KK31	–	–
8GK1052-2KK41	8GK1062-2KK41	–	–
8GK1052-3KK11	8GK1062-3KK11	8GK1082-3KK11	–
8GK1052-3KK21	8GK1062-3KK21	8GK1082-3KK21	–
8GK1052-3KK31	8GK1062-3KK31	8GK1082-3KK31	8GK1072-3KK31
8GK1052-3KK41	8GK1062-3KK41	8GK1082-3KK41	–
8GK1052-4KK11	8GK1062-4KK11	8GK1082-4KK11	–
8GK1052-4KK21	8GK1062-4KK21	8GK1082-4KK21	–
8GK1052-4KK31	8GK1062-4KK31	8GK1082-4KK31	–
8GK1052-4KK41	8GK1062-4KK41	8GK1082-4KK41	–
8GK1052-5KK11	8GK1062-5KK11	8GK1082-5KK11	–
8GK1052-5KK21	8GK1062-5KK21	8GK1082-5KK21	–
8GK1052-5KK31	8GK1062-5KK31	8GK1082-5KK31	–
8GK1052-5KK41	8GK1062-5KK41	8GK1082-5KK41	–

Distribution boards with built-in distribution board panels			
Tier spacing 125 mm with N/PE plug-in terminal	Tier spacing 150 mm without N/PE plug-in terminal	Tier spacing 150 mm terminal blocks at top	Tier spacing 125 mm multimedia field
IP31 	IP31 	IP31 	IP31 
Protection class II	Protection class II	Protection class II	Protection class II
8GK1051-1KK10	8GK1061-1KK10	–	–
8GK1051-1KK20	8GK1061-1KK20	–	–
8GK1051-2KK10	8GK1061-2KK10	–	–
8GK1051-2KK20	8GK1061-2KK20	–	–
8GK1051-2KK30	8GK1061-2KK30	–	–
8GK1051-3KK10	8GK1061-3KK10	8GK1081-3KK10	–
8GK1051-3KK20	8GK1061-3KK20	8GK1081-3KK20	8GK1072-3KK20
8GK1051-3KK30	8GK1061-3KK30	8GK1081-3KK30	8GK1072-3KK30
8GK1051-3KK40	8GK1061-3KK40	8GK1081-3KK40	–
8GK1051-4KK10	8GK1061-4KK10	8GK1081-4KK10	–
8GK1051-4KK20	8GK1061-4KK20	8GK1081-4KK20	–
8GK1051-4KK30	8GK1061-4KK30	8GK1081-4KK30	8GK1072-4KK30
8GK1051-4KK40	8GK1061-4KK40	8GK1081-4KK40	–
8GK1051-5KK10	8GK1061-5KK10	8GK1081-5KK10	–
8GK1051-5KK20	8GK1061-5KK20	8GK1081-5KK20	–
8GK1051-5KK30	8GK1061-5KK30	8GK1081-5KK30	–

Assembly kits

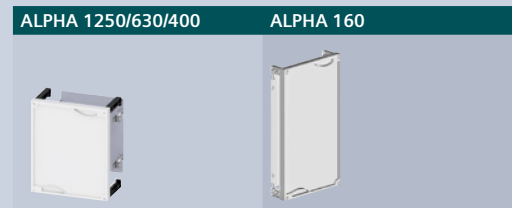
For modular installation devices

				ALPHA 1250/630/400		ALPHA 160	
				Tier spacing		Tier spacing	
				125 mm	150 mm	125 mm	150 mm
							
No. of tiers	MW	Height Outside	Width Outside				
1	12	150 mm	250 mm	–	8GK4351-1KK12	–	8GK4351-1KK11
	24	150 mm	500 mm	–	8GK4351-1KK22	–	8GK4351-1KK21
	36	150 mm	750 mm	–	8GK4351-1KK32	–	–
2	24	300 mm	250 mm	8GK4301-2KK12	8GK4351-2KK12	8GK4301-2KK11	8GK4351-2KK11
	48	300 mm	500 mm	8GK4301-2KK22	8GK4351-2KK22	8GK4301-2KK21	8GK4351-2KK21
	72	300 mm	750 mm	–	8GK4351-2KK32	–	–
3	36	450 mm	250 mm	8GK4301-3KK12	8GK4351-3KK12	8GK4301-3KK11	8GK4351-3KK11
	72	450 mm	500 mm	8GK4301-3KK22	8GK4351-3KK22	8GK4301-3KK21	8GK4351-3KK21
	108	450 mm	750 mm	–	8GK4351-3KK32	–	–
4	48	600 mm	250 mm	8GK4301-4KK12	8GK4351-4KK12	8GK4301-4KK11	8GK4351-4KK11
	96	600 mm	500 mm	8GK4301-4KK22	8GK4351-4KK22	8GK4301-4KK21	8GK4351-4KK21
	144	600 mm	750 mm	–	8GK4351-4KK32	–	–

For terminal blocks

		ALPHA 1250/630/400		ALPHA 160
				
Height Outside	Width Outside	Horizontal	Vertical	Horizontal
150 mm	250 mm	8GK4401-1KK12	–	8GK4401-1KK11
	500 mm	–	–	8GK4401-1KK21
300 mm	250 mm	8GK4401-2KK12	8GK4402-2KK12	8GK4401-2KK11
	500 mm	8GK4401-2KK22	8GK4402-2KK22	8GK4401-2KK21
	750 mm	8GK4401-2KK32	8GK4402-2KK32	–
450 mm	250 mm	8GK4401-3KK12	8GK4402-3KK12	–
	500 mm	8GK4401-3KK22	8GK4402-3KK22	–
	750 mm	8GK4401-3KK32	8GK4402-3KK32	–
600 mm	250 mm	–	8GK4402-4KK12	–
	500 mm	–	8GK4402-4KK22	–
	750 mm	–	8GK4402-4KK32	–

With mounting plates



Mounting plates			Assembly kits			
Height	Width	Front cover	Height outside	Width outside		
245 mm	207.5 mm	Closed	300 mm	250 mm	8GK4451-2KK12	8GK4451-2KK11
	457.5 mm	Closed	300 mm	500 mm	8GK4451-2KK22	–
	707.5 mm	Closed	300 mm	750 mm	8GK4451-2KK32	–
395 mm	207.5 mm	Closed	450 mm	250 mm	8GK4451-3KK12	8GK4451-3KK11
	457.5 mm	Closed	450 mm	500 mm	8GK4451-3KK22	–
	707.5 mm	Closed	450 mm	750 mm	8GK4451-3KK32	–
545 mm	207.5 mm	Closed	600 mm	250 mm	8GK4451-4KK12	8GK4451-4KK11
	457.5 mm	Closed	600 mm	500 mm	8GK4451-4KK22	–
	707.5 mm	Closed	600 mm	750 mm	8GK4451-4KK32	–

With mounting plates, perforated



Mounting plates			Assembly kits			
Height	Width	Front cover	Height outside	Width outside		
149 mm	245 mm	–	150 mm	250 mm	8GK4452-1KK12	–
299 mm	245 mm	–	300 mm	250 mm	8GK4452-2KK12	–
449 mm	243 mm	–	450 mm	250 mm	8GK4452-3KK12	–
899 mm	243 mm	–	900 mm	250 mm	8GK4452-6KK12	–

For unequipped panels



Height Outside	Width Outside	ALPHA 1250/630/400			ALPHA 160
		Standard	With inspection window	With deep-drawn cover 40 mm	Standard
75 mm	250 mm	8GK4501-0KK12	–	–	–
	500 mm	8GK4501-0KK22	–	–	–
150 mm	250 mm	8GK4501-1KK12	–	–	8GK4501-1KK11
	500 mm	8GK4501-1KK22	–	–	8GK4501-1KK21
	750 mm	8GK4501-1KK32	–	–	–
300 mm	250 mm	8GK4501-2KK12	8GK4500-2KK12	8GK4501-2KK13	8GK4501-2KK11
	500 mm	8GK4501-2KK22	8GK4500-2KK22	8GK4501-2KK23	8GK4501-2KK21
	750 mm	8GK4501-2KK32	–	8GK4501-2KK33	–
450 mm	250 mm	8GK4501-3KK12	8GK4500-3KK12	8GK4501-3KK13	8GK4501-3KK11
	500 mm	8GK4501-3KK22	8GK4500-3KK22	8GK4501-3KK23	8GK4501-3KK21
	750 mm	8GK4501-3KK32	–	8GK4501-3KK33	–
600 mm	250 mm	8GK4501-4KK12	8GK4500-4KK12	–	8GK4501-4KK11
	500 mm	8GK4501-4KK22	8GK4500-4KK22	–	8GK4501-4KK21
	750 mm	8GK4501-4KK32	–	–	–
750 mm	250 mm	8GK4501-5KK12	–	–	–
	500 mm	8GK4501-5KK22	–	–	–
	750 mm	8GK4501-5KK32	–	–	–

Assembly kits

For 3NP1 fuse switch disconnectors

ALPHA 1250/630/400



LV HRC fuse Size	Switches/breakers Quantity	Distribution board		Mounting	
		Height Outside	Width Outside	on support plate	on busbars ¹⁾
00/000	2	300 mm	250 mm	8GK4550-2KK12	8GK4650-2KK12
		450 mm	250 mm	–	8GK4650-3KK12
	4	300 mm	500 mm	8GK4550-2KK22	8GK4650-2KK22
		450 mm	500 mm	–	8GK4650-3KK22
1	1	450 mm	250 mm	8GK4550-3KK12	8GK4651-3KK12
	2	450 mm	500 mm	8GK4550-3KK22	8GK4651-3KK22
2	1	450 mm	250 mm	8GK4551-3KK12	8GK4652-3KK12
3	1	450 mm	500 mm	8GK4551-3KK22	–

¹⁾ For busbar support 8GK9711-0KK03

Accessories

Cover 3NP1123 ... size 000



- Required for size 000 fuse switch disconnectors

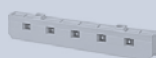
Article No.

8GK9912-0KK00

Busbar supports



Busbar center-to-center spacing	Number of poles	Article No.
60 mm	1-pole	8GK9710-0KK00
	2-pole	8GK9710-0KK01
	3-pole	8GK9711-0KK03
	4-pole	8GK9670-0KK00
40 mm	5-pole	8GK9650-0KK00



For 3NJ4 fuse switch disconnectors in in-line design



Switches/breakers Size	Number of 3NJ4 disconnectors		Distribution board		Distribution board depth min. 320 mm	
	With screw fixing	With fixing claws	Height Outside	Width Outside		
Assembly kits for 3NJ4 fuse switch disconnectors						
NH00	4	3	600 mm	250 mm	8GK4751-4KK13	–
	9	8	600 mm	500 mm	8GK4751-4KK23	–
	14	13	600 mm	750 mm	8GK4751-4KK33	–
NH1 – NH3	2	–	750 mm	250 mm	–	8GK4752-5KK15
	4	3	750 mm	500 mm	–	8GK4752-5KK25
	7	6	750 mm	750 mm	–	8GK4752-5KK35

Accessories

Blanking covers

Switching device size	Busbar center-to-center spacing	Height	Width	Article No.
NH00	100 mm	299 mm	50 mm	3NJ4912-2CA00
NH1 – NH3	185 mm	699 mm	50 mm	3NJ4912-2AA00
			100 mm	3NJ4912-2BA00

Ready-to-install copper bars


Switching device size	Distribution board width outside	Article No.
NH00	250 mm	8GK9735-1KK10
	500 mm	8GK9735-1KK20
	750 mm	8GK9735-1KK30
NH1 – NH3	250 mm	8GK9735-2KK10
	500 mm	8GK9735-2KK20
	750 mm	8GK9735-2KK30

Support plate for busbar supports

Switching device size	Installation	Article No.
NH00	Left or right	8GK9800-0KK06
NH1 – NH3	Left or right	8GK9800-0KK07

Assembly kits

For SR60 busbar-adaptable units

		ALPHA 1250/630/400
		Busbar center-to-center spacing 60 mm
		
Height Outside	Width Outside	
300 mm	250 mm	8GK4801-2KK13
	500 mm	8GK4801-2KK23
	750 mm	8GK4801-2KK33
450 mm	250 mm	8GK4801-3KK13
	500 mm	8GK4801-3KK23
	750 mm	8GK4801-3KK33

Accessories

Supports for blanking covers



Article No.

8US1922-2EA00

Blanking covers



Article No.

8US1922-2EB00

Blanking covers



Width

56 mm

Article No.

8GK9910-0KK08

For bus-mounting fuse bases, for mounting on busbar systems

Number of poles		Height Outside		Width Outside		ALPHA 1250/630/400	
						SR60, 60 mm	8US, 60 mm
3P	4P	■	300 mm	250 mm	8GK4801-2KK12	–	
			450 mm	250 mm	8GK4801-3KK12	–	
■	■	■	300 mm	250 mm	–	8GK4800-2KK12	
			500 mm	–	–	8GK4800-2KK22	
			750 mm	–	–	8GK4800-2KK32	

Accessories

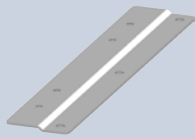
Blanking covers



Width
56 mm

Article No.
8GK9910-0KK08

Holding plates





- For 4-pole busbar supports for mounting in section with height of 300 mm


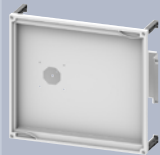
Article No.
8GK9711-0KK07

Assembly kits

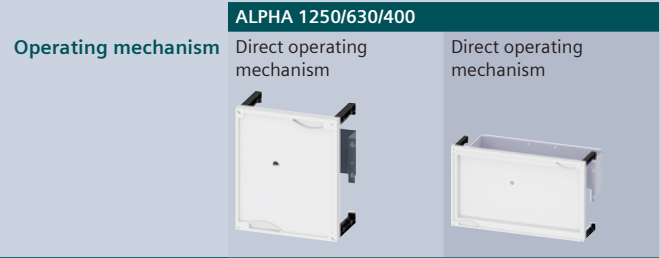
For 3KF switch disconnectors with fuses

								ALPHA 1250/630/400	
								Operating mechanism	
								Front operating mechanism, center	Door-coupling rotary operating mechanism (mounted in the front cover)
									
Switches/breakers			Distribution board						
Size	Rated current	3P	4P	Height Outside	Width Outside	Depth Outside			
3KF1	80 A	■	■	300 mm	250 mm	≥ 210 mm	8GK4722-2KK10	–	
3KF2	160 A	■	■	300 mm	500 mm	≥ 210 mm	8GK4723-2KK10	–	
3KF3 ... 3KF4	400 A	■	■	300 mm	500 mm	≥ 320 mm	–	8GK4722-2KK20	

For 3KD switch disconnectors

								ALPHA 1250/630/400	
								Operating mechanism	
								Direct operating mechanism	Door-coupling rotary operating mechanism (mounted in the front cover)
									
Switches/breakers			Distribution board						
Size	Rated current	Quantity	3P	4P	Height Outside	Width Outside	Depth Outside		
1	16 ... 63 A	2	■	–	300 mm	250 mm	210 mm	8GK4720-2KK10	–
2	80 ... 200 A	1	■	■	300 mm	250 mm	210 mm	8GK4720-2KK10	–
3	200 ... 400 A	1	■	■	300 mm	250 mm	210 mm	8GK4721-2KK10	–
3 ... 4	200 ... 800 A	1	■	■	450 mm	500 mm	≥ 250 mm	–	8GK4720-3KK20

For 3KA switch disconnectors on support plate



Switches/breakers					Distribution board			
Size	Rated current	Quantity	3P	4P	Height Outside	Width Outside		
3KA 50/51/52/53	63 A/80 A/ 125 A/160 A	1	■	–	300 mm	250 mm	8GK4707-3KK17	–
3KA 55/57/58	250 A/400 A/ 630 A	1	■	■	300 mm	500 mm	–	8GK4707-4KK27

Assembly kits

For 3VL molded case circuit breakers

ALPHA 1250/630/400



Switches/breakers		Rated current	Quantity			Distribution board		Standard
Size	Type			3P	4P	Height Outside	Width Outside	
3VL1	3VL160X	16 ... 160 A	1	■	■	300 mm	250 mm	8GK4701-2KK12
				■	■	450 mm	250 mm	8GK4701-3KK12
3VL2	3VL160	50 ... 160 A	1	■	■	300 mm	250 mm	8GK4701-2KK12
				■	■	450 mm	250 mm	8GK4701-3KK12
3VL3	3VL250	200 ... 250 A	1	■	■	450 mm	250 mm	8GK4701-3KK12
3VL4	3VL400	200 ... 400 A	1	■	■	600 mm	250 mm	8GK4702-4KK12
				■	■	750 mm	250 mm	–
3VL5	3VL630	315 ... 630 A	1	■	–	600 mm	250 mm	8GK4703-4KK13
				■	■	600 mm	500 mm	8GK4704-4KK13
				■	–	600 mm	500 mm	–
				–	■	600 mm	500 mm	–
3VL6	3VL800	800 A	1	■	–	600 mm	250 mm	8GK4704-4KK15
				■	■	600 mm	500 mm	8GK4704-4KK25
3VL7	3VL1250	1000 ... 1250 A	1	■	■	600 mm	500 mm	8GK4705-4KK25
3VL8	3VL1600	1600 A	1	■	■	600 mm	500 mm	8GK4705-4KK25



With RCD module mounted

For installation with front-operated rotary operating mechanism

–	–
8GK4720-3KK10	8GK4722-3KK10
–	–
8GK4721-3KK10	8GK4722-3KK10
8GK4721-3KK10	8GK4722-3KK10
–	8GK4722-4KK10
8GK4720-5KK10	–
–	–
–	–
–	8GK4723-4KK10
–	8GK4721-4KK20
–	–
–	–
–	–
–	–

Assembly kits

For 3VA molded case circuit breakers, 3-pole and 4-pole

ALPHA 1250/630/400






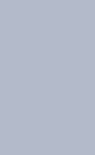
Switches/breakers						Distribution board		
Size	Rated current	Quantity	Direct operating mechanism	Rotary operating mechanism	Motorized operating mechanism	Height Outside	Width Outside	
3VA10..., 3VA11..	100 ... 160 A	1	■	–	■	300 mm ¹⁾	250 mm	8GK4731-2KK12 ⁴⁾
			–	■	–	450 mm	250 mm	8GK4730-2KK12 ⁴⁾
			–	–	■	300 mm ¹⁾	250 mm	8GK4733-2KK12
			–	–	■	300 mm ¹⁾	250 mm	–
		3	■	–	–	300 mm ¹⁾	500 mm	8GK4731-2KK22
			–	■	–	450 mm	500 mm	8GK4730-2KK22
			–	–	■	300 mm ¹⁾	500 mm	8GK4733-2KK22
			–	–	■	300 mm ¹⁾	500 mm	–
3VA12	250 A	1	■	–	–	300 mm	250 mm	8GK4732-2KK12
			–	■	–	450 mm	250 mm	8GK4733-3KK10
			–	–	■	300 mm	250 mm	8GK4735-2KK12
			–	–	■	300 mm	250 mm	–
		3	■	–	–	450 mm	250 mm	–
			–	■	–	600 mm	250 mm	–
			–	–	■	300 mm	500 mm	8GK4732-2KK22
			–	–	■	450 mm	500 mm	8GK4731-3KK20
		3	■	–	–	300 mm	500 mm	8GK4735-2KK22
			–	■	–	300 mm	500 mm	8GK4735-2KK22
			–	–	■	300 mm	500 mm	–
			–	–	■	300 mm	500 mm	–
3VA20..., 3VA22..	100 ... 250 A	1	■	–	–	300 mm	250 mm	8GK4730-3KK10
			–	■	–	300 mm	250 mm	8GK4736-2KK12
			–	–	■	600 mm	250 mm	–
		3	■	–	–	300 mm	500 mm	8GK4730-3KK20
			–	■	–	300 mm	500 mm	8GK4736-2KK22
			–	–	■	600 mm	500 mm	–
3VA23..., 3VA24..	400 ... 630 A	1	■	–	–	450 mm	250 mm	8GK4730-4KK12
			–	■	–	500 mm	8GK4730-4KK22	
			–	–	■	450 mm	500 mm	8GK4733-4KK22
		3	■	–	–	450 mm	500 mm	8GK4733-4KK22
			–	■	–	450 mm	250 mm	–
			–	–	■	450 mm	250 mm	–
–	–	■	500 mm	–	–			
–	–	■	600 mm	250 mm	–			
–	–	■	500 mm	–	–			

¹⁾ For insulated connection only

²⁾ Distribution board depth at least 250 mm

³⁾ Distribution board depth at least 320 mm

⁴⁾ With side mounted motorized operating mechanism


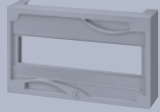
				
	With RCD module Infeed side	At side	With RCD module Infeed side	At side
–	–	–	–	–
–	–	–	–	–
–	–	–	–	–
8GK4734-2KK12 ²⁾	–	–	–	–
–	8GK4731-3KK12 ⁴⁾	8GK4731-3KK10	8GK4734-3KK12 ²⁾	–
–	–	–	–	–
–	–	–	–	–
–	–	–	–	–
8GK4734-2KK22 ²⁾	–	–	–	–
–	8GK4731-3KK22	–	8GK4734-3KK22 ²⁾	–
–	–	–	–	–
–	–	–	–	–
–	–	–	–	–
8GK4735-3KK10 ²⁾	–	–	–	–
–	–	–	–	8GK4733-4KK10 ²⁾
–	8GK4732-4KK10	–	8GK4736-4KK12	–
–	–	–	–	–
–	–	–	–	–
–	–	–	–	–
8GK4732-3KK20 ²⁾	–	–	–	–
–	–	–	–	–
–	–	–	–	–
–	8GK4735-4KK12	–	–	–
–	–	–	–	–
–	–	–	–	–
–	8GK4735-4KK22	–	8GK4736-4KK22 ³⁾	–
–	–	–	–	–
–	–	–	–	–
–	–	–	–	–
8GK4734-4KK12 ³⁾	–	–	–	–
8GK4734-4KK22 ³⁾	–	–	–	–
–	8GK4731-4KK12	–	–	–
–	8GK4731-4KK22	–	–	–

Assembly kits

For meter mounting without top and bottom terminal compartment

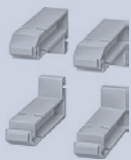
		ALPHA 630
		
Height Outside	Width Outside	
450 mm	250 mm	8GE3713-4

For meter mounting with top and bottom terminal compartment

		ALPHA ZS	
		Meter support plate	Covers
			
Height	Width	Top/bottom terminal compartment	
150 mm	250 mm	–	8GS4006-0
300 mm	250 mm	–	8GS4006-5
450 mm	250 mm	8GS4007-4	–

Accessories

Supports for front cover



Article No.
8GS4018-8

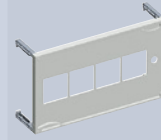
DIN rails



Article No.
8GS4010-6

Front covers for measuring devices

ALPHA 1250/630/400



Use	Height Outside	Width Outside	Cutout dimensions	
1 × measuring device 96 × 96 mm	300 mm	500 mm	92 × 92 mm	8GK4500-2KK20

For cable connections to the door

ALPHA 1250/630/400



Height	Width	Diameter	
150 mm	250 mm	M20	8GK4500-1KK12
	500 mm	M20	8GK4500-1KK22

Quick-assembly kits

For modular installation devices and terminal blocks

Tier spacing ALPHA 1250/630/400
125 mm




Height Outside	Width Outside	No. of tiers	Terminals	MW	With N/PE bar	With 2 N/PE bars
For modular installation devices						
450 mm	250 mm	3	–	36	–	–
600 mm	250 mm	4	–	48	8GK4001-4KK11	–
	500 mm	8	–	96	8GK4001-4KK22	–
750 mm	250 mm	5	–	60	8GK4001-5KK11	–
	500 mm	10	–	120	8GK4001-5KK22	–
900 mm	250 mm	6	–	72	8GK4001-6KK11	8GK4003-6KK11
	500 mm	12	–	144	8GK4001-6KK22	–
1050 mm	250 mm	7	–	84	8GK4001-7KK11	8GK4003-7KK11
	500 mm	14	–	168	8GK4001-7KK22	–
1200 mm	250 mm	8	–	96	8GK4001-8KK12	8GK4003-8KK12
	500 mm	16	–	192	8GK4001-8KK22	–
1350 mm	250 mm	9	–	108	8GK4002-8KK12	8GK4003-8KK13
	500 mm	18	–	216	8GK4002-8KK22	–
For modular installation devices and terminal blocks						
900 mm	250 mm	2	4	48	–	–
	500 mm	4	8	96	–	–
	750 mm	6	12	144	–	–
1050 mm	250 mm	2	5	60	–	–
	500 mm	4	10	120	–	–
	750 mm	6	15	180	–	–
1200 mm	250 mm	2	6	72	–	–
	500 mm	4	12	144	–	–
	750 mm	6	18	216	–	–
1350 mm	250 mm	3	6	72	–	–
	500 mm	6	12	144	–	–
	750 mm	9	18	216	–	–

ALPHA 160		
150 mm	125 mm	150 mm
Without N/PE bar	With N/PE bar	Without N/PE bar
–	8GK4001-3KK11	8GK4051-3KK11
–	8GK4001-4KK11	8GK4051-4KK11
–	–	–
–	8GK4001-5KK11	8GK4051-5KK11
–	–	–
8GK4051-6KK11	8GK4001-6KK11	8GK4051-6KK11
8GK4101-6KK22	–	–
8GK4051-7KK11	8GK4001-7KK11	8GK4051-7KK11
8GK4101-7KK22	–	–
8GK4101-8KK12	–	–
8GK4101-8KK22	–	–
8GK4102-8KK12	–	–
8GK4102-8KK22	–	–
8GK4100-6KK12	–	–
8GK4100-6KK22	–	–
8GK4100-6KK32	–	–
8GK4100-7KK12	–	–
8GK4100-7KK22	–	–
8GK4100-7KK32	–	–
8GK4100-8KK12	–	–
8GK4100-8KK22	–	–
8GK4100-8KK32	–	–
8GK4110-8KK12	–	–
8GK4110-8KK22	–	–
8GK4110-8KK32	–	–

Busbars




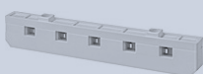
For ALPHA 1250/630/400 distribution boards

Cu busbars



Cross-section	Current	Length	Article No.
12 × 5 mm	250 A	250 mm	8GK9731-0KK10
		500 mm	8GK9731-0KK20
		750 mm	8GK9731-0KK30
		1000 mm	8GK9731-0KK40
		1250 mm	8GK9731-0KK50
20 × 5 mm	320 A	250 mm	8GK9733-0KK10
		500 mm	8GK9733-0KK20
		750 mm	8GK9733-0KK30
		1000 mm	8GK9733-0KK40
		1250 mm	8GK9733-0KK50
30 × 5 mm	450 A	250 mm	8GK9735-0KK10
		500 mm	8GK9735-0KK20
		750 mm	8GK9735-0KK30
		1000 mm	8GK9735-0KK40
		1250 mm	8GK9735-0KK50
30 × 10 mm	630 A	250 mm	8GK9736-0KK10
		500 mm	8GK9736-0KK20
		750 mm	8GK9736-0KK30
		1000 mm	8GK9736-0KK40
		1250 mm	8GK9736-0KK50


Busbar supports

Version	Use	Busbar center-to-center spacing	Article No.
1-pole	For Cu busbars 12 × 5 (10) mm, 20 × 5 (10) mm, 30 × 5 (10) mm	–	8GK9710-0KK00
2-pole	For Cu busbars 12 × 5 (10) mm, 20 × 5 (10) mm, 30 × 5 (10) mm	60 mm	8GK9710-0KK01
3-pole	For Cu busbars 12 × 5 (10) mm, 20 × 5 (10) mm, 30 × 5 (10) mm, Bus-mounting fuse bases and 3NP4076 switch disconnectors in conjunction with assembly kits	60 mm	8GK9711-0KK03
4-pole	For Cu busbars 12 × 5 (10) mm, 30 × 5 (10) mm	60 mm	8GK9670-0KK00
5-pole	For Cu busbars 12 × 5 (10) mm 3NP fuse switch disconnectors	40 mm	8GK9650-0KK00

Accessories

For ALPHA 1250/630/400/160 distribution boards

				1250	630	400	160
Wall-mounting rails							
	• For all wall-mounted distribution boards						
	Length			Article No.			
	250 mm					■	■
	500 mm					■	■
	750 mm					■	■
	1000 mm					■	■
	1250 mm					■	■
Cabinet mounting lugs, flat							
	Use			Article No.			
	For mounting and fixing a distribution board directly against the wall without a clearance (1 set = 4 units)			8GK9910-0KK36		■	■
	For connecting 2 distribution boards and for mounting and fixing a distribution board directly against the wall without a clearance (8GK9910-0KK36 additionally required for the ends) 1 set = 2 units			8GK9910-0KK37		■	■
Wall mounting lug, standard							
	• 1 set = 4 units						
				Article No.			
				8GK9920-0KK33	■	■	■
Hollow wall set							
	Use			Article No.			
	For mounting flush-mounting distribution boards in hollow walls			8GK9910-0KK28		■	■
M12 transport eyebolts							
				Article No.			
				8GK9918-0KK00	■	■	■
Ventilation grilles for side panel							
				Article No.			
				8GK9120-0KK30	■	■	■
Bases for flat pack floor-mounted distribution boards							
	Height outside	Depth	Width	Article No.			
	100 mm	210 mm	300 mm	8GK9901-0KK12		■	
			550 mm	8GK9901-0KK22		■	
			800 mm	8GK9901-0KK32		■	
			1050 mm	8GK9901-0KK42		■	
			1300 mm	8GK9901-0KK52		■	

Accessories

For ALPHA 1250/630/400/160 distribution boards

				1250	630	400	160
Bases for pre-assembled (welded) floor-mounted distribution boards							
	Height outside	Depth	Width	Article No.			
	100 mm	210 mm	300 mm	8GK9901-0KA12	■	■	
			550 mm	8GK9901-0KA22	■	■	
			800 mm	8GK9901-0KA32	■	■	
			1050 mm	8GK9901-0KA42	■	■	
			1300 mm	8GK9901-0KA52	■	■	
		250 mm	300 mm	8GK9900-0KK13	■	■	
			550 mm	8GK9900-0KK23	■	■	
			800 mm	8GK9900-0KK33	■	■	
			1050 mm	8GK9900-0KK43	■	■	
			1300 mm	8GK9900-0KK53	■	■	
		320 mm	300 mm	8GK9900-0KK14	■	■	
			550 mm	8GK9900-0KK24	■	■	
			800 mm	8GK9900-0KK34	■	■	
			1050 mm	8GK9900-0KK44	■	■	
			1300 mm	8GK9900-0KK54	■	■	
		400 mm	300 mm	8GK9902-0KK13	■	■	
			550 mm	8GK9902-0KK23	■	■	
			800 mm	8GK9902-0KK33	■	■	
			1050 mm	8GK9902-0KK43	■	■	
			1300 mm	8GK9902-0KK53	■	■	
Partitions, vertical							
• For the visual and spatial separation of different potentials							
	Cubicle depth	Height	Article No.				
	140 mm	450 mm	8GK9001-3KK01				■
		600 mm	8GK9001-4KK01				■
		750 mm	8GK9001-5KK01				■
		900 mm	8GK9001-6KK01				■
		1050 mm	8GK9001-7KK01				■
	210 mm	300 mm	8GK9301-2KK01		■	■	
		450 mm	8GK9301-3KK01		■	■	
		600 mm	8GK9101-4KK01		■	■	
		750 mm	8GK9101-5KK01		■	■	
		900 mm	8GK9101-6KK01		■	■	
		1050 mm	8GK9101-7KK01		■	■	
		1200 mm	8GK9101-8KK01		■	■	
		1350 mm	8GK9102-8KK01		■	■	
		1800 mm	8GK9520-8KK01		■		
250/320 mm	1800 mm	8GK9520-8KK00		■			
	400 mm	1800 mm	8GK9521-8KK00	■			

1250 630 400 160

Partitions, horizontal

- For the visual and spatial separation of different potentials



Cubicle depth	Width	Article No.	1250	630	400	160
140 mm	250 mm	8GK9002-0KK10				■
210 mm	250 mm	8GK9103-0KK10		■	■	
	500 mm	8GK9103-0KK20		■	■	
	750 mm	8GK9103-0KK30		■	■	
250/320 mm	250 mm	8GK9520-0KK10		■		
	500 mm	8GK9520-0KK20		■		
400 mm	250 mm	8GK9520-0KK30	■			

Mounting plates



Cubicle Height	Width	Mounting plates		Article No.	1250	630	400	160
		Height	Width					
600 mm	250 mm	596 mm	243 mm	8GK9531-4KK10			■	
	500 mm	596 mm	493 mm	8GK9531-4KK20			■	
750 mm	250 mm	685 mm	243 mm	8GK9531-5KK10			■	
	500 mm	685 mm	493 mm	8GK9531-5KK20			■	
900 mm	250 mm	835 mm	243 mm	8GK9531-6KK10			■	
	500 mm	835 mm	493 mm	8GK9531-6KK20			■	
1050 mm	250 mm	985 mm	243 mm	8GK9531-7KK10			■	
	500 mm	985 mm	493 mm	8GK9531-7KK20			■	
1200 mm	250 mm	1135 mm	243 mm	8GK9531-8KK10			■	
	500 mm	1135 mm	493 mm	8GK9531-8KK20			■	
1350 mm	250 mm	1285 mm	243 mm	8GK9532-8KK10			■	
	500 mm	1285 mm	493 mm	8GK9532-8KK20			■	
1800 mm	250 mm	1680 mm	242 mm	8GK9533-0KK10	■	■		
	500 mm	1680 mm	492 mm	8GK9533-0KK20	■	■		
	750 mm	1680 mm	742 mm	8GK9533-0KK30	■	■		
	1000 mm	1680 mm	992 mm	8GK9533-0KK40	■	■		
	1250 mm	1680 mm	1242 mm	8GK9533-0KK50	■	■		

Mounting plates for telecommunication units

- Made of perforated steel plate
- With insert nuts and quick-locking technology

Cubicle Height	Width	Mounting plates		Article No.	1250	630	400	160
		Height	Width					
900 mm	250 mm	835 mm	243 mm	8GS4016-1			■	
1050 mm	250 mm	985 mm	243 mm	8GS4016-2			■	
1200 mm	250 mm	1135 mm	243 mm	8GS4016-3			■	
1350 mm	250 mm	1285 mm	243 mm	8GS4016-4			■	

Longitudinal stays









- In order to mount the assembly kits in unequipped distribution boards, 2 longitudinal stays are required for each assembly kit width
- 1 set = 2 stays

Cubicle depth	Length	Article No.	1250	630	400	160
210 mm	300 mm	8GK4855-2KK02		■		
	450 mm	8GK4851-3KK00				■
	600 mm	8GK4851-4KK00			■	■
	750 mm	8GK4851-5KK00			■	■
	900 mm	8GK4851-6KK00			■	■
	1050 mm	8GK4851-7KK00			■	■
	1200 mm	8GK4851-8KK00			■	
	1350 mm	8GK4852-8KK00			■	
1800 mm	8GK4853-8KK00			■		
250 mm, 320 mm, 400 mm	1800 mm	8GK4853-8KK02	■	■		

Accessories

For ALPHA 1250/630/400/160 distribution boards

					1250	630	400	160	
Stay supports									
	<ul style="list-style-type: none"> For depth of 210 mm when mounting stays are to be shifted forward by 55 mm Necessary whenever DIN rails are mounted directly on the stays 				Article No.				
					8GK9910-0KK38			■	
Universal brackets									
					Article No.				
					8GK9910-0KK05	■	■		
Connection kits for longitudinal stays									
	Depth				Article No.				
	250/320 mm				8GK9910-0KK32	■	■	■	
Crossbars									
	Width				Article No.				
	500 mm				8GK4853-0KK20	■	■	■	
	750 mm				8GK4853-0KK30	■	■	■	
Front cover, closed									
	Tier spacing	Height	Width	Article No.					
	150 mm	75 mm	250 mm	8GK9601-0KK10	■	■	■	■	
		150 mm	250 mm	8GK9601-1KK10	■	■	■	■	
		500 mm	250 mm	8GK9601-1KK20	■	■	■	■	
	300 mm	750 mm	250 mm	8GK9601-1KK30	■	■	■	■	
		250 mm	500 mm	8GK9601-2KK10	■	■	■	■	
		500 mm	500 mm	8GK9601-2KK20	■	■	■	■	
	450 mm	750 mm	250 mm	8GK9601-2KK30	■	■	■	■	
		250 mm	500 mm	8GK9601-3KK10	■	■	■	■	
		500 mm	500 mm	8GK9601-3KK20	■	■	■	■	
	600 mm	750 mm	250 mm	8GK9601-3KK30	■	■	■	■	
		250 mm	500 mm	8GK9601-4KK10	■	■	■	■	
		500 mm	500 mm	8GK9601-4KK20	■	■	■	■	
	750 mm	250 mm	8GK9601-4KK30	■	■	■	■		
Front cover with cutout									
	Height	Width	Tiers	MW	Article No.				
	150 mm	250 mm	1	12	8GK9601-1KK11	■	■	■	■
		500 mm	1	24	8GK9601-1KK21	■	■	■	■
		750 mm	1	36	8GK9601-1KK31	■	■	■	■
	300 mm	250 mm	2	24	8GK9601-2KK11	■	■	■	■
		500 mm	2	48	8GK9601-2KK21	■	■	■	■
		750 mm	2	72	8GK9601-2KK31	■	■	■	■
	450 mm	250 mm	3	36	8GK9601-3KK11	■	■	■	■
		500 mm	3	72	8GK9601-3KK21	■	■	■	■
		750 mm	3	108	8GK9601-3KK31	■	■	■	■
	600 mm	250 mm	4	48	8GK9601-4KK11	■	■	■	■
		500 mm	4	96	8GK9601-4KK21	■	■	■	■
		750 mm	4	144	8GK9601-4KK31	■	■	■	■

1250 630 400 160

Supports for front cover



- Plastic

Version	Length	Mounting	Article No.	1250	630	400	160
Spare part	117 mm	Standard	8GK9910-0KK30	■	■	■	
	54 mm	Standard	8GK9910-0KK20				■
Large pack	117 mm	For 15 mm DIN rail directly onto the DIN-rail holder	8GK9910-0KK31	■	■	■	
	61.5 mm	For 15 mm DIN rail directly onto the stays	8GK9910-0KK24	■	■	■	

Assembly tool for supports



- For short and long version
- With ergonomic handle

Version	Article No.	1250	630	400	160
	8GK9910-0KK27	■	■	■	■

Support extensions



Length	Article No.	1250	630	400	160
7.5 mm	8GK9911-0KK03	■	■	■	■

Quick-lock screws for front cover



Material	Color	Article No.	1250	630	400	160
Plastic	RAL 7035 (light gray)	8GK9910-0KK26	■	■	■	■

Spare part door hinges



- For wall/floor-mounted distribution boards
- 1 set = 2 units

Version	Article No.	1250	630	400	160
Door hinges prior to 2019 (1 piece)	8GK9920-0KK24	■	■	■	■
Door hinges from 2019 onwards (2 pieces)	8GK9920-1KK24	■	■	■	■

Circuit diagram pockets



Version	Format	Depth	Article No.	1250	630	400	160
Sheet steel	DIN A3	10 mm	8GK9910-0KK22	■	■	■	■



Transparent sleeve, adhered all-over	DIN A4		8GK9910-0KK23	■	■	■	■
--------------------------------------	--------	--	---------------	---	---	---	---



Plastic	DIN A4	30 mm	8GD9132	■	■	■	■
Plastic, large pack	DIN A4	30 mm	8GK9910-1KK24	■	■	■	■

Siemens nameplate


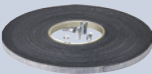


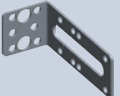

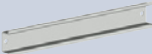



Material	Version	Color	Article No.	1250	630	400	160
Aluminum	Self-adhesive	Petrol	8GD9084	■	■	■	■
Sticker	Self-adhesive	Petrol	8GF9661	■	■	■	■

Accessories

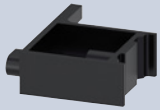



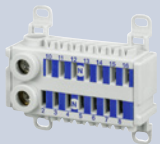

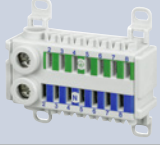
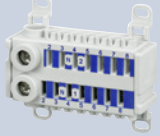
For ALPHA 1250/630/400/160 distribution boards

			1250	630	400	160
IP44/IP55 locking systems for wall-mounted distribution boards						
	Version	Article No.				
	Standard locking device with rotary handle	8GK9560-0KK04			■	■
	Retrofit kit for standard locking device with degree of protection IP44	8GK9560-0KK05			■	■
	Rotary handle locking device for profile cylinders (E012 or Senat tumbler)	8GK9560-0KK06			■	■
	Rotary handle, lockable, incl. E012 lock and two keys	8GK9560-0KK13			■	■
	Rotary handle incl. double-bit interlocking mechanism	8GK9561-0KK04			■	
Locking systems for floor-mounted distribution boards						
	Version	Article No.				
	Rotary handle, recessable, with pushbutton technique	8GK9561-0KK01	■	■		
	Lock insert for installation of profile semicylinder	8GK9561-0KK02	■	■		
Profile semicylinder for locks						
	Use	Version	Article No.			
	Wall-mounted distribution boards	With E012 lock and two keys	8GK9560-0KK07		■	■
		With Senat tumbler and two keys	8GK9560-0KK08		■	■
		With 3-mm pin as double-bit lock	8GK9560-0KK10		■	■
	Floor-mounted distribution boards	With E012 lock and two keys	8GK9561-0KK00	■	■	
		With Senat tumbler and two keys	8GK9560-0KK03	■	■	

			1250	630	400	160
Spare keys						
	Version	Article No.				
	For double-bit interlocking mechanism	8GD9290	■	■		
	For E012 lock	8GF9390-2	■	■	■	■
Connecting kits for distribution boards, IP44/IP55						
	<ul style="list-style-type: none"> For side-by-side mounting of enclosures Comprising: screws, washers, nuts and 5 m roll of sealing strip 					
	Article No.					
	8GK9920-0KK31			■	■	
8GK9920-0KK50			■			
Extra-deep brackets						
	<ul style="list-style-type: none"> For recessed installation of DIN rails 					
	Article No.					
8GK9910-0KK34			■	■	■	
Extra-deep brackets, depth-adjustable						
	Article No.					
	8GK9911-0KK01			■	■	■
Drop-down brackets, universal						
	Article No.					
	8GK9911-0KK02			■	■	■
DIN rails, lowered						
	Width	Article No.				
	250 mm	8GK9910-0KK35	■	■	■	
	500 mm	8GK9910-0KK40	■	■	■	
	750 mm	8GK9910-0KK41	■	■	■	
15 mm DIN rails						
	Width	Article No.				
	250 mm	8GK9910-1KK10	■	■		
	500 mm	8GK9910-1KK20	■	■		
	750 mm	8GK9910-1KK30	■	■		
	1000 mm	8GK9910-1KK40	■	■		
1250 mm		8GK9910-1KK50	■	■		
DIN-rail holders for 15 mm DIN rail						
<ul style="list-style-type: none"> Comprising a left and a right holder 						
	Version	Type	Article No.			
	Long	For 1 DIN rail	8GK9910-1KK81	■	■	■
		For 2 DIN rails	8GK9910-1KK83	■	■	■
		For 3 DIN rails	8GK9910-1KK84	■	■	■
		For 4 DIN rails	8GK9910-1KK85	■	■	■





Accessories

For ALPHA 1250/630/400/160 distribution boards





		1250	630	400	160		
Iso supports							
	<ul style="list-style-type: none"> For insulated DIN-rail assembly 						
	Type	Article No.					
	4 mm	8GK9911-0KK07	■	■	■	■	
	31.5 mm	8GK9911-0KK05	■	■	■		
	55.5 mm	8GK9911-0KK06	■	■	■		
Torx-slotted screws M5 × 10, self-tapping							
	<ul style="list-style-type: none"> Large pack: 500 units 						
		Article No.					
		8GK9911-0KK00	■	■	■	■	
Crossbars for mounting vertical busbar systems							
	Width	Article No.					
	250 mm	8GK9911-1KK00	■	■	■		
	500 mm	8GK9911-1KK01	■	■	■		
	750 mm	8GK9911-1KK02	■	■	■		
Blanking strips							
	Type	Color	Article No.				
	For 12 MW (1 MW = 18 mm)	RAL 7035 (light gray)	8GK9910-0KK00	■	■	■	■
	Length 1 m w/o pressure-relief joint, to cut to length	RAL 7035 (light gray)	8GK9910-0KK01	■	■	■	
Blanking plugs							
	Diameter	Article No.					
	6 mm	8GK9910-0KK06	■	■	■	■	
	11 mm	8GK9910-0KK07	■	■	■	■	
N terminals							
	<ul style="list-style-type: none"> For snap-on mounting onto the DIN rail For distributing the neutral conductor when using several RCCBs 2 × screw terminal, conductor cross-section max. 16 mm² 14 × plug-in terminal, conductor cross-section max. 4 mm² 						
		Article No.					
		8GS4034-1	■	■	■	■	
PE terminals							
	<ul style="list-style-type: none"> For snap-on mounting onto the DIN rail 2 × screw terminal, conductor cross-section max. 16 mm² 14 × plug-in terminal, conductor cross-section max. 4 mm² 						
		Article No.					
		8GS4034-2	■	■	■	■	
N/PE terminals							
	<ul style="list-style-type: none"> For snap-on mounting onto the DIN rail For distributing the neutral conductor when using several RCCBs 1 × screw terminal, conductor cross-section max. 16 mm², per PE and N potential 7 × plug-in terminal, conductor cross-section max. 4 mm², per PE and N potential 						
		Article No.					
		8GS4034-3	■	■	■	■	
N/N terminals							
	<ul style="list-style-type: none"> For snap-on mounting onto the DIN rail For distributing the neutral conductor when using several RCCBs 1 × screw terminal, conductor cross-section max. 16 mm², per PE and N potential 7 × plug-in terminal, conductor cross-section max. 4 mm², per PE and N potential 						
		Article No.					
		8GS4034-4	■	■	■	■	

1250 630 400 160


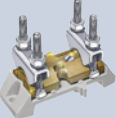

Terminals for circular conductors

	Busbar thickness		Conductor cross-section		Article No.	1250	630	400	160
	5 mm		1.5 ... 16 mm ²						
			1.5 ... 16 mm ²		8US1921-2AA00	■	■	■	
			1.5 ... 35 mm ²		8US1921-2AB00	■	■	■	
			16 ... 70 mm ²		8US1921-2AC00	■	■	■	
			16 ... 120 mm ²		8US1921-2AD00	■	■	■	

Terminals for circular conductors

	Busbar thickness		Conductor cross-section		Article No.	1250	630	400	160
	10 mm		1.5 ... 16 mm ²						
			1.5 ... 16 mm ²		8US1921-2BA00	■	■	■	
			1.5 ... 35 mm ²		8US1921-2BB00	■	■	■	
			16 ... 70 mm ²		8US1921-2BC00	■	■	■	
			16 ... 120 mm ²		8US1921-2BD00	■	■	■	

Terminals with bases made of glass-fiber reinforced polyester resin


	Incoming cables		Outgoing cables		Article No.	1250	630	400	160
	Quantity	Cross-section	Quantity	Cross-section					
	1	6 ... 70 mm ²	1	6 ... 70 mm ²	8JK401	■	■	■	
		50 ... 240 mm ²	1	50 ... 240 mm ²	8JK4061	■	■	■	
	2	50 ... 240 mm ²	2	50 ... 185 mm ²	8JK406	■	■	■	

Accessories


For ALPHA 1250/630/400/160 distribution boards

1250 630 400 160


Incoming and outgoing terminal for busbars

Image	Busbar		Conductor cross-section	Description	Article No.	1250	630	400	160
	Dimensions	Quantity							
	20 × 8 mm	1 or 2	50 ... 240 mm ²	1 conductor per clamping point	8JK3171	■	■	■	
				2 conductors per clamping point	8JK3172	■	■	■	


N/PE bars as plug-in terminals

Image	N/PE bars as plug-in terminals		Article No.	1250	630	400	160
	Type	Connections					
	• For mounting on longitudinal stays at a 30° inclination						
	PE bar	6 screw connections 2.5 ... 16 mm ² and 21 screw connections 1.5 ... 4 mm ²	8GK9910-0KK11				■
	PE + N bar	PE bar: 6 screw connections 2.5 ... 16 mm ² and 21 screw connections 1.5 ... 4 mm ² N bar: 2 screw connections 2.5 ... 16 mm ² and 10 screw connections 1.5 ... 4 mm ²	8GK9910-0KK12				■


Cable clamping rail

Image	Cable clamping rail		Article No.	1250	630	400	160
	Width						
	• For strain relief • C profile 30 × 15 mm						
	250 mm		8GK9911-0KK10	■	■	■	
	500 mm		8GK9911-0KK20	■	■	■	
	750 mm		8GK9911-0KK30	■	■	■	
	1000 mm		8GK9911-0KK40	■	■	■	
	1250 mm		8GK9911-0KK50	■	■	■	



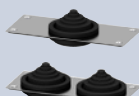
Cable holders

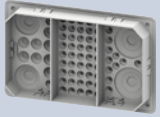



Image	Cable holders		Article No.	1250	630	400	160
	Use	Version					
	For DIN rail	Height 45 mm, width 40 mm	8GK9910-0KK80	■	■	■	
	For mounting in 5-mm hole	Clip with cable tie	8GK9910-0KK81	■	■	■	

Cable flange for cable entry

Image	Cable flange for cable entry				1250	630	400	160
	Type	Degree of protection	Cable routing	Article No.				
	1-component flange	IP44	Bottom	8GK9100-0KK00	■	■	■	
	2-component flange		Top/bottom	8GK9000-0KK02				■
	2-component flange	IP55	Top/bottom	8GK9100-0KK01	■	■	■	
	Bushing flange		Busbar system	8GK9100-0KK10	■	■	■	

Cable flange for cable entry (only protection class I)

Image	Cable flange for cable entry (only protection class I)				1250	630	400	160
	Version	Degree of protection	Cable diameter	Article No.				
	Blank flange	IP44		8GK9100-0KK02	■	■	■	
		IP55		8GK9100-0KK03	■	■	■	
	Sheet steel, without knockouts	IP55		8GK9100-0KK04	■			
	Flange, incl. 1 cable support sleeve	IP55	14 ... 65 mm	8GK9100-0KK05	■	■	■	
		IP55	14 ... 65 mm	8GK9100-0KK06	■	■	■	

				1250	630	400	160
Flange for cable entry, IP55							
	Type	Cable diameter	Article No.				
	2-component flange	58 × 5 ... 10 mm/2 × 16 ... 35 mm 8 × 11 ... 16 mm/2 × 15 ... 45 mm	8GK9101-0KK00	■ ¹⁾	■	■	
	2-component flange, pack of 10	58 × 5 ... 10 mm/2 × 16 ... 35 mm 8 × 11 ... 16 mm/2 × 15 ... 45 mm	8GK9101-0KK01	■ ¹⁾	■	■	
	Sheet steel closed, 214 mm × 136 mm		8GK9101-0KK02	■	■	■	
	Sheet steel incl. 1 cable support sleeve 8HC6900	14 ... 65 mm	8GK9101-0KK05	■	■	■	
	Sheet steel incl. 2 cable support sleeves 8HC6900	14 ... 65 mm	8GK9101-0KK06	■	■	■	
Rubber cable entries							
	<ul style="list-style-type: none"> For inserting in 38 mm diameter knockouts (= Pg29) Degree of protection IP65 						
	Quantity	Cable diameter	Article No.				
	1	12 ... 29 mm	8HP1805	■	■	■	■
	2	6 ... 15 mm	8HP1806	■	■	■	■
	3	4 ... 12.5 mm	8HP1807	■	■	■	■
	4	4 ... 12 mm	8HP1808	■	■	■	■
Cable entries for cable entry plate							
	<ul style="list-style-type: none"> For 8HP1520 cable entry plates 						
	Cable diameter	Article No.					
	14 ... 65 mm	8HC6900	■	■	■	■	
Breathers, PG 16							
	<ul style="list-style-type: none"> For distribution boards in an outdoor climate to avoid condensate Degree of protection IP54 						
		Article No.					
		8HE8541	■	■	■	■	

¹⁾ Roof plate only

System overview

Small distribution boards ALPHA

SIMBOX XL



SIMBOX WP



ALPHA SIMBOX XL



Flush-mounting and hollow-wall distribution boards



Surface-mounting distribution boards



Multimedia distribution boards

Accessories



Terminal strips



RCCB terminals



Door locking kit



Mounting aid for flush mounting

ALPHA SIMBOX WP



Surface-mounting distribution boards

Accessories



Covers



N/PE terminal strips



Inner partitions



Safety cylinder locks

Note:

You will find a detailed range of accessories with the basic units.

ALPHA SIMBOX XL small distribution boards

Flush-mounting and hollow-wall distribution boards, rated current up to 63 A

Recess dimensions			Type	Complete supply	Project supply	Expansion package
Width	Depth	Height		IP30	IP30	
Flush-mounting distribution boards						
359 mm	88 mm	393 mm	1-tier	8GB5012-1KM	8GB5212-1KM01	8GB5212-3KM01
		518 mm	2-tier	8GB5024-1KM	8GB5224-1KM01	8GB5224-3KM01
		643 mm	3-tier	8GB5036-1KM	8GB5236-1KM01	8GB5236-3KM01
		768 mm	4-tier	8GB5048-1KM	8GB5248-1KM01	8GB5248-3KM01
Hollow-wall distribution boards						
323 mm	88 mm	360 mm	1-tier	8GB5012-4KM	8GB5212-2KM01	8GB5212-4KM01
		485 mm	2-tier	8GB5024-4KM	8GB5224-2KM01	8GB5224-4KM01
		610 mm	3-tier	8GB5036-4KM	8GB5236-2KM01	8GB5236-4KM01
		735 mm	4-tier	8GB5048-4KM	8GB5248-2KM01	8GB5248-4KM01

Accessories

Terminal strips with plug-in terminals

Type	Potential 1	Potential 2	Article No.
N/PE	N = 3 × 25 + 14 × 4 mm ²	PE = 3 × 25 + 14 × 14 mm ²	8GB5016-5KM
N/N	N1 = 3 × 25 + 14 × 4 mm ²	N2 = 3 × 25 + 14 × 14 mm ²	8GB5017-5KM
N	N = 6 × 25 + 28 × 4 mm ²		8GB5020-5KM
PE	PE = 6 × 16 + 28 × 5 mm ²		8GB5021-5KM

Terminal strips with screw terminals

Type	Potential 1	Potential 2	Article No.
N/PE	N = 3 × 16 + 14 × 10 mm ²	PE = 3 × 16 + 14 × 10 mm ²	8GB5008-5KM
N/N	N1 = 3 × 16 + 14 × 10 mm ²	N2 = 3 × 16 + 14 × 10 mm ²	8GB5015-5KM
N	N = 6 × 16 + 28 × 10 mm ²		8GB5010-5KM
PE	PE = 6 × 16 + 28 × 10 mm ²		8GB5011-5KM

RCCB terminals

Use	Potential	Article No.
For distributing the neutral conductor to two RCCBs	N = 3 × 16 + 2 × 10 mm ²	8GB5005-5KM

Door locking kit

Use	Feature	Article No.
For snapping into door handle	With two keys	8GB5006-5KM


Blanking strips

Width	Feature	Color	Article No.
12 MW	Increased flame protection up to 850 °C	White	8GB4683

Mounting aid for flush mounting

Use	Article No.
For flush-mounting and hollow-wall distribution boards	8GB5013-5KM

Surface-mounting distribution boards, rated current up to 63 A

				Distribution boards without door	Metal doors, white	Plastic doors, white
Degree of protection				IP30	IP30	IP30
						
External dimensions				Protection class II	Protection class II	Protection class II
Width	Depth	Height	Type			
Surface-mounting distribution boards						
305 mm	99 mm	250 mm	1-tier	8GB5012-0KM	8GB5001-5KM	8GB5001-5KM01
		375 mm	2-tier	8GB5024-0KM	8GB5002-5KM	8GB5002-5KM01
		515 mm	3-tier	8GB5036-0KM	8GB5003-5KM	8GB5003-5KM01
		640 mm	4-tier	8GB5048-0KM	8GB5004-5KM	8GB5004-5KM01

Accessories

Terminal strips with plug-in terminals



Type	Potential 1	Potential 2	Article No.
N/PE	N = 3 × 25 + 14 × 4 mm ²	PE = 3 × 25 + 14 × 14 mm ²	8GB5016-5KM
N/N	N1 = 3 × 25 + 14 × 4 mm ²	N2 = 3 × 25 + 14 × 14 mm ²	8GB5017-5KM
N	N = 6 × 25 + 28 × 4 mm ²		8GB5020-5KM
PE	PE = 6 × 16 + 28 × 5 mm ²		8GB5021-5KM

Terminal strips with screw terminals



Type	Potential 1	Potential 2	Article No.
N/PE	N = 3 × 16 + 14 × 10 mm ²	PE = 3 × 16 + 14 × 10 mm ²	8GB5008-5KM
N/N	N1 = 3 × 16 + 14 × 10 mm ²	N2 = 3 × 16 + 14 × 10 mm ²	8GB5015-5KM
N	N = 6 × 16 + 28 × 10 mm ²		8GB5010-5KM
PE	PE = 6 × 16 + 28 × 10 mm ²		8GB5011-5KM

RCCB terminals



Use	Potential	Article No.
For distributing the neutral conductor to two RCCBs	N = 3 × 16 + 2 × 10 mm ²	8GB5005-5KM

Door locking kit



Use	Feature	Article No.
For snapping into door handle	With two keys	8GB5006-5KM

Blanking strips



Width	Feature	Color	Article No.
12 MW	Increased flame protection up to 850 °C	White	8GB4683

ALPHA SIMBOX XL small distribution boards

Multimedia distribution boards, rated current up to 63 A

Surface-mounting distribution boards

Degree of protection IP30



Recess dimensions			Type	Protection class II
Width	Depth	Height		
Flush-mounting and hollow-wall distribution boards				
323 mm	88 mm	605 mm	3-tier	8GB5036-3KM01
		730 mm	4-tier	8GB5048-3KM01
Surface-mounting distribution boards				
323 mm	88 mm	605 mm	3-tier	8GB5036-3KM00
		730 mm	4-tier	8GB5048-3KM00

Accessories

Connecting lugs

Use	Article No.
For installing several distribution boards in a row, vertically or horizontally	8GB5025-5KM

ALPHA SIMBOX WP small distribution boards

Surface-mounting distribution boards, rated current up to 63 A

Unequipped surface-mounting distribution boards

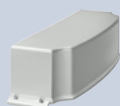
Degree of protection IP65



Type	External dimensions			Protection class II
	Height	Width	Depth	
Surface-mounting distribution boards				
1-tier	210 mm	143 mm	100 mm	8GB1371-0
		215 mm	100 mm	8GB1371-1
	260 mm	298 mm	140 mm	8GB1371-2
	285 mm	410 mm	140 mm	8GB1371-3
2-tier	420 mm	298 mm	140 mm	8GB1372-2
	463 mm	410 mm	140 mm	8GB1372-3
3-tier	655 mm	410 mm	140 mm	8GB1373-3
4-tier	878 mm	410 mm	160 mm	8GB1374-3

Accessories

Covers



- For connection of conduit and cable duct entries
- Snap-on mounting

MW	Article No.
12	8GB2051-0
18	8GB2051-1

N/PE terminal strips



- For snapping onto device holder

MW	Potential 1	Potential 2	Article No.
8	$N = 1 \times 25 + 7 \times 10 \text{ mm}^2$	$PE = 1 \times 25 + 7 \times 10 \text{ mm}^2$	8GB2052-0
12	$N = 3 \times 25 + 10 \times 10 \text{ mm}^2$	$PE = 3 \times 25 + 10 \times 10 \text{ mm}^2$	8GB2052-1
18	$N = 5 \times 25 + 14 \times 10 \text{ mm}^2$	$PE = 5 \times 25 + 14 \times 10 \text{ mm}^2$	8GB2052-2

Inner partitions, horizontal



MW	Article No.
12	8GB2053-0
18	8GB2053-1

Front covers

MW	Article No.
12	8GB2054-0
18	8GB2054-1

Safety cylinder locks

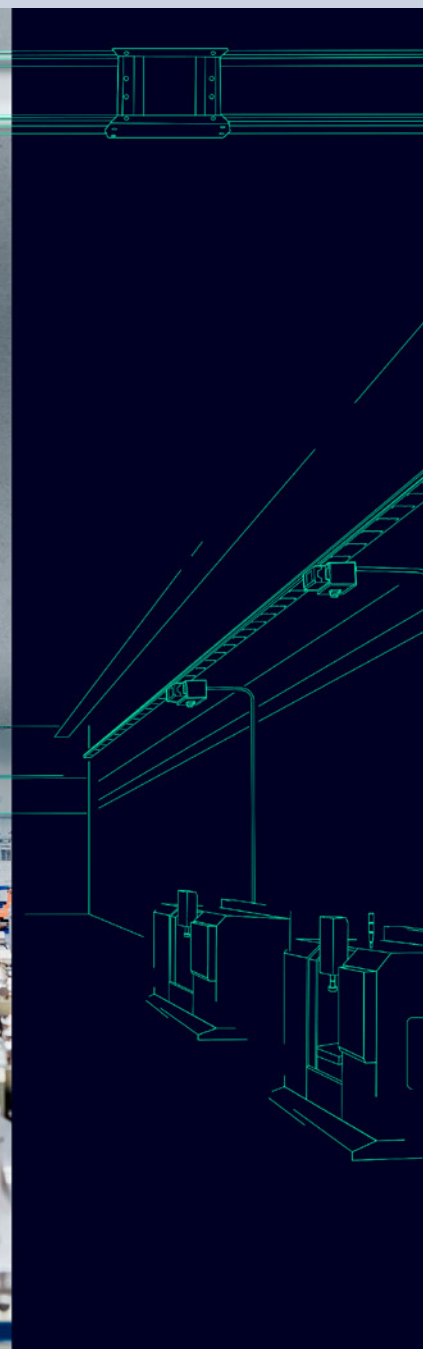


Material	Scope of supply	Article No.
Metal	With key	8GB2055-0

Blanking strips



Type	Color	Article No.
For 12 MW (1 MW = 18 mm)	RAL 7035 (light gray)	8GK9910-0KK00



Power distribution in the age of digitalization

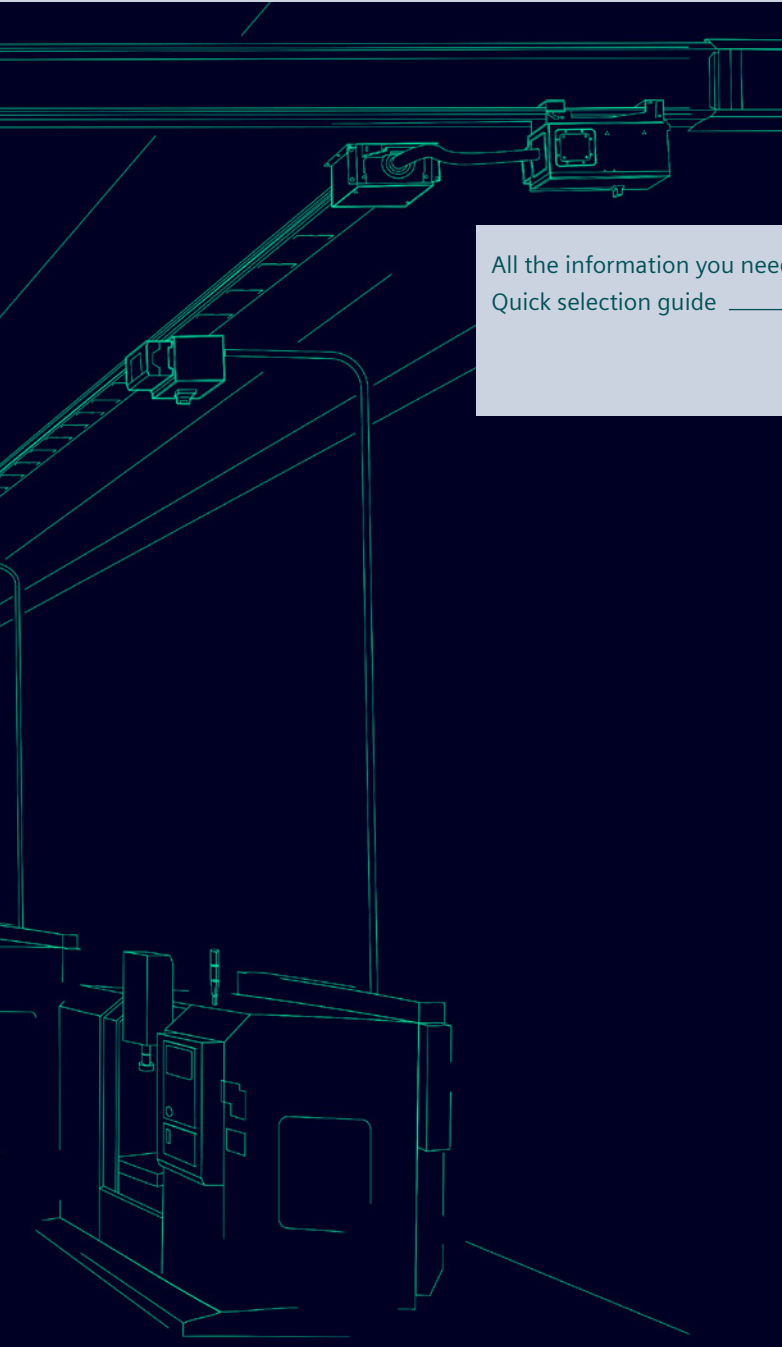
Take advantage of the benefits of digitalization at every step of the project with the SIVACON 8PS busbar trunking systems – from planning to installation on up to operation.

SIMARIS software tools provide efficient support for your planning: among other advantages, you can configure the SIVACON 8PS busbars with SIMARIS busbarplan. A digital twin of the busbar runs is created from the BIM data. The BusbarCheck app assists you during installation.

Energy data and power with plug-and-work: Our innovative powerline technology makes this possible for SIVACON 8PS busbar trunking systems – efficient and reliable.

Energy data is simply transferred to the automation and energy management systems, as well as to cloud-based systems (IoT). Data and electricity travel the same path via the conductor circuits and phases of the BD2, LD, LData and LI busbar trunking systems.

Busbar Trunking Systems



All the information you need	16/2
Quick selection guide	16/4
SIVACON 8PS busbar trunking systems	16/4
Planning and installation tools	16/6

A multitude of additional information ...

Information + ordering

All the important things at a glance

For information about busbar trunking systems, please visit our website www.siemens.com/sivacon-8PS

Your product in detail

The SiePortal platform (knowledge base) provides comprehensive information

www.siemens.com/lowvoltage/product-support

- Brochure
 - Energy and data successfully put on track (109747761)
- Catalog
 - LV 70 · 2023 – SIVACON 8PS busbar trunking systems – BD01, BD2 up to 1250 A (109744546)

The relevant tender specifications can be found at www.siemens.com/tenderspecifications

Use our conversion tool for quick and easy conversion to Siemens products www.siemens.com/conversion-tool

Siemens YouTube channel

- Power distribution – SIVACON (general) sie.ag/6wacV9

Everything you need for your order

Refer to SiePortal to find an overview of your products (product catalog)

SIVACON 8PS sie.ag/2lXpCT1

- Planning software sie.ag/2m3oFbS

Direct forwarding to the individual products in SiePortal by clicking on the article number in the catalog or entering this web address incl. article number www.siemens.com/product_catalog_SIEP?Article No.

Order support for SIVACON 8PS – BD01 and BD2 www.siemens.com/LV70

Configurators

Configure your SIVACON 8PS BD01 or BD2 busbar trunking system in [SiePortal](#)

The fast track to the experts

Contact persons in your region

We offer a comprehensive portfolio of services.

You can find your local contacts at

www.siemens.com/sivacon8PS-contact

You will find further information on services at

www.siemens.com/service-offers

Competent expert advice on technical questions with a wide range of demand-optimized services for all our products and systems.

Assistance with technical queries is provided at

www.siemens.com/support-request

... can be found in our online services

Commissioning + operation

SIMARIS planning tools

The SIMARIS planning tools effectively assist you in your planning process. Project-specific IFC data (Building Information Modeling) for cross-package planning is also possible.

www.siemens.com/simaris

Manuals

Manuals can be found in SiePortal at www.siemens.com/lowvoltage/manuals

- Planning Manual
 - Planning with SIVACON 8PS (109478425)

Your product in detail

The SiePortal platform (knowledge base) provides detailed technical information

www.siemens.com/lowvoltage/product-support

- Operating instructions
- Certificates

Online Support app available for download from the [App Store](#) and [Play Store](#)

You will find further information at www.siemens.com/support-app

Engineering data for CAD or CAE systems are available in the CAx Download Manager at www.siemens.com/cax

Face-to-face or online training

Our training courses can be found at www.power-academy.siemens.com

Technical overview – Busbar trunking systems

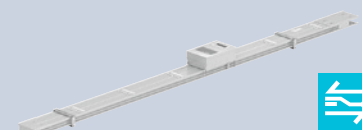
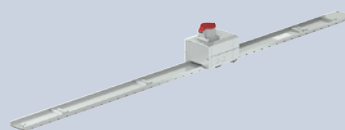


The fast way to get you to our online services

This page provides you with comprehensive information and links on busbar trunking systems

www.siemens.com/lowvoltage/product-support (109769090)

SIVACON 8PS busbar trunking systems

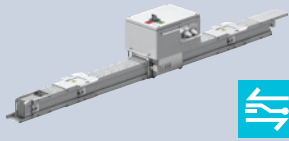


Busbar trunking systems	BD01	BD2
Basic data		
System description	Flexible power supply in workshops and production plants for skilled trades and businesses and commercial enterprises	The universal solution for high power levels in a small space, especially in offices and in industrial transfer lines
Typical applications	<ul style="list-style-type: none"> Workshops and production plants Supermarkets Data centers High-rise buildings Trade fair buildings Automotive industry Marine applications eMobility 	<ul style="list-style-type: none"> Workshops and production plants Production industry Do-it-yourself centers Data centers High-rise buildings Foodstuffs industry Trade fair buildings Hospitals Automotive industry Marine applications eMobility
Technical specifications		
Rated insulation voltage U_i	400 V AC	690 V AC
Rated operational voltage U_e	400 V AC	690 V AC
Degree of protection	IP54, IP55	IP54, IP55
Rated current I_{nA}	40 ... 160 A	160 ... 1250 A
Rated peak withstand current I_{pk}	Up to 15.3 kA	Up to 90 kA
Rated short-time withstand current I_{cw} (1 s)	Up to 2.5 kA	Up to 34 kA
Number of conductors	5 (PE = enclosure)	5
Connection technology	Connecting flange with built-in expansion compensation	With built-in expansion compensation, bolt-type terminal
Outgoing feeders and junctions		
Tap-off point	On one side every 0.5 or 1 m	On one side every 0.5 m, on two sides offset every 0.25 m
Tap-off unit	Up to 63 A	Up to 550 A
Material		
Conductors	Aluminum or copper	Aluminum or copper
Enclosures (trunking unit, feeder unit)	Sheet steel, tin-coated and powder-coated	Sheet steel, tin-coated and powder-coated
Communication		
Data transmission	data line	powerline, data line
Certificates		
	<ul style="list-style-type: none"> DNV GL Environmental Product Declaration (EPD) 	<ul style="list-style-type: none"> DNV GL Environmental Product Declaration (EPD)

¹⁾ IP66 for pure energy transfer runs without outgoing feeders.



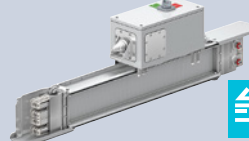
Data transfer with powerline technology



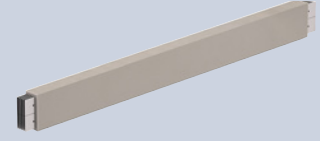
LD



LData



LI



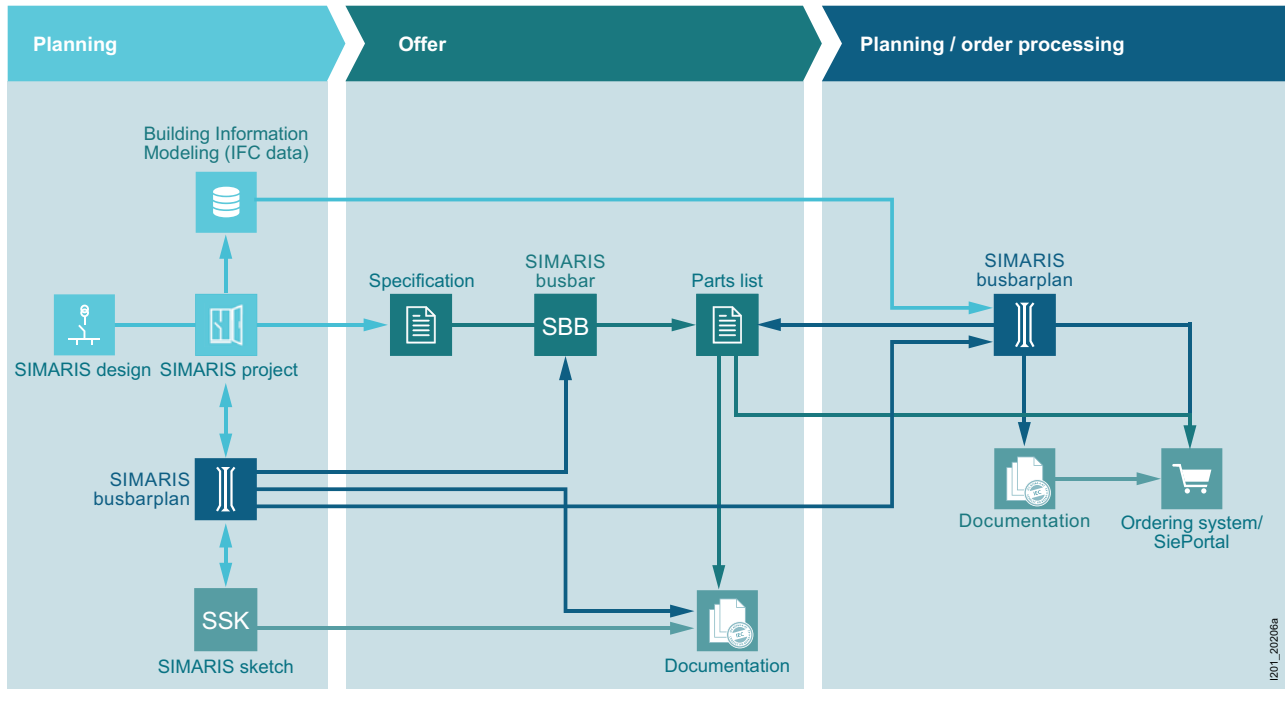
LR

LD	LData	LI	LR
The proven high-current busbar for industry and special applications	Efficient and reliable power supply for today and tomorrow's data centers	An integrated solution for safe and efficient infrastructure power supply – for example in multi-story buildings and industrial applications	The reliable busbar for a high degree of protection in harsh environments, for example for networking of building sections outdoors or for power supply in tunnels
<ul style="list-style-type: none"> Automotive industry Production industry Foodstuffs industry Trade fair buildings Wind power plants Semiconductor production Marine applications eMobility DC applications 	<ul style="list-style-type: none"> Data centers 	<ul style="list-style-type: none"> High-rise buildings Data centers Production industry Chemicals industry Airports Trade fair buildings Hospitals Do-it-yourself centers Shopping malls Supermarkets eMobility 	<ul style="list-style-type: none"> Chemicals industry Oil and gas Tunnels and subways Outdoor applications Marine applications
1000 V AC	600 V AC	1000 V AC	1000 V AC
1000 V AC	600 V AC	1000 V AC	1000 V AC
IP34, IP54	Trunking units: IP21 Tap-off units: IP21, IP41	IP55, IP66 ¹⁾	IP68
1100 ... 5000 A	1000 ... 2500 A	800 ... 6300 A	400 ... 6300 A
Up to 286 kA	Min. 84 kA	Up to 330 kA	Up to 275 kA
Up to 116 kA	Min. 40 kA	Up to 150 kA	Up to 125 kA
4 or 5	5	4 ... 6 (incl. 200% N or add. clean earth)	4 or 5
Bolt-type terminal connection with hook and bolt connection	Direct hook and bolt connection (LD technology)	Hook and bolt connection with shear nut	Bolt terminal block
On one side every 1 m	Can be plugged in anywhere along the system	Up to 3 for every 3 m (per side)	On one side every 1 m
Up to 1250 A	Up to 250 A	Up to 1250 A	On request
Aluminum or copper	Aluminum	Aluminum or copper	Aluminum or copper
Sheet steel, tin-coated and powder-coated	Sheet steel, tin-coated and powder-coated	Aluminum, powder-coated	Epoxy resin
powerline, data line	powerline, data line	powerline, data line	–
<ul style="list-style-type: none"> DNV GL Environmental Product Declaration (EPD) 	–	<ul style="list-style-type: none"> SEISMIC Qualification Certificate (earthquake test) Environmental Product Declaration (EPD) 	<ul style="list-style-type: none"> DNV GL SEISMIC Qualification Certificate (earthquake test) ATEX Product Environmental Profile (PEP)

Planning and installation tools

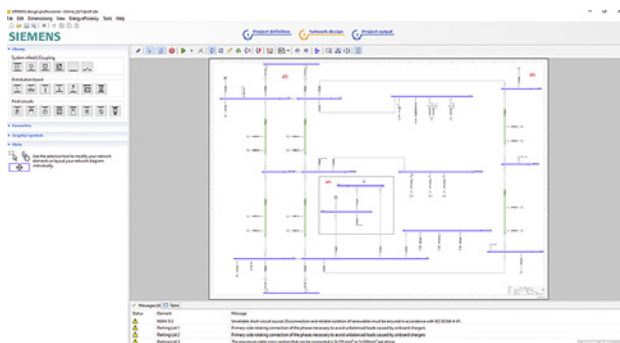
For planning, visualization and installation of busbar trunking systems

From planning to commissioning



1201_20206a

SIMARIS design



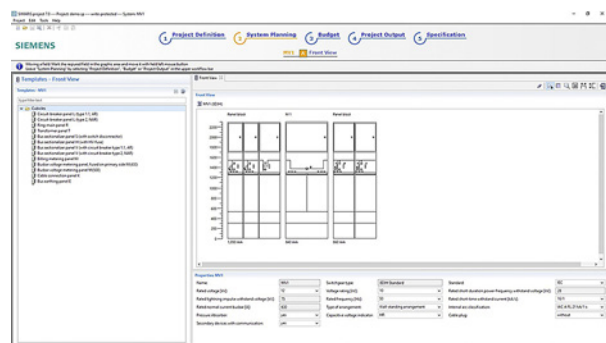
SIMARIS design is a planning tool for fast and efficient grid calculation and dimensioning of electrical power distribution for special-purpose and industrial buildings.

- Dimensioning of electrical networks on the basis of real products according to acknowledged rules of technology and the applicable standards (VDE, IEC)
- Automatic selection of the appropriate components from the stored product database

SIMARIS design forms part of SIMARIS Suite.

Free download of the SIMARIS Suite and further information at: www.siemens.com/simarisdg

SIMARIS project



SIMARIS project is a planning tool used to quickly determine the necessary space requirements and the budget for electrical energy distribution for special-purpose and industrial buildings and for automatic generation of specifications.

- Import into projects created with SIMARIS design
- Export of 3D data in IFC 4.x format for BIM (Building Information Modeling)

SIMARIS project forms part of SIMARIS Suite.

Free download of the SIMARIS Suite and further information at: www.siemens.com/simariproject

SIMARIS Toolbox (online)



The SIMARIS Toolbox is a platform for provision of online tools for assisting electrical installation planners. It includes, for example:

- EMC Busbar (tool for calculating magnetic field strength in the vicinity of SIVACON 8PS busbar trunking systems)

SIMARIS Toolbox forms part of SIMARIS Suite.

Free download of the SIMARIS Suite and further information at: www.siemens.com/simaristoolbox

SIMARIS busbarplan



The SIMARIS busbarplan planning tool supports BIM-compliant 3D configuration of SIVACON 8PS busbar trunking systems.

- Plugin based on the BIM Autodesk REVIT software
- Version for planners and for Siemens project engineers

SIMARIS busbarplan forms part of SIMARIS Suite.

Free download of the SIMARIS Suite and further information at: www.siemens.com/simaribusbarplan

Planning and installation tools

For planning, visualization and installation of busbar trunking systems

BusbarCheck app



BusbarCheck is an installation app to use for easy and high-quality installation and documentation.

- Interface to SIMARIS busbarplan
- Detailed explanation of all steps
- Written record and proper documentation for better and easier evaluation of the installation
- Can be used by all installation companies and SIVACON 8PS busbar trunking installations in Germany and another 23 European countries

Free download from:
[App Store](#) and [Play Store](#)

SIMARIS sketch



The new SIMARIS sketch is a software tool for quick and easy planning and visualization of busbar trunking systems.

- Simple creation of busbar routing and building structures in 3D
- Interface to SIMARIS busbarplan and rejection in IFC format possible
- Creation of order parts lists for the BD01 and BD2 systems

SIMARIS sketch forms part of SIMARIS Suite.
Free download of the SIMARIS Suite and further information at: www.siemens.com/simarissketch

IFC data



BIM simplifies the planning process. While the simple exchange of relevant building data between the planners and the facility manager ensures high quality and reduces costs, the digital twin for power distribution fits in seamlessly with the overall structure – for efficient planning, performance and maintenance.

www.siemens.com/bim-eplanning

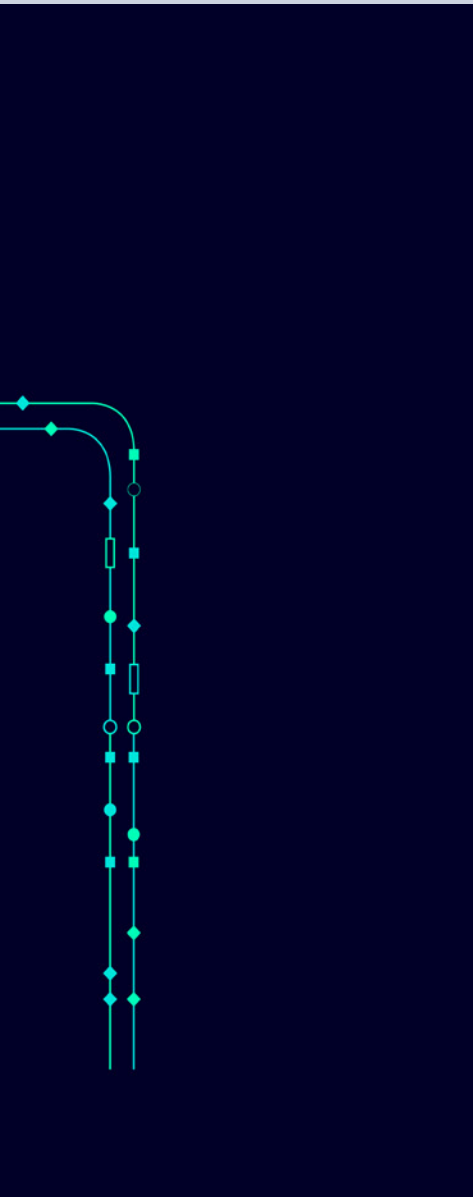
Equipped for all applications

Maximum flexibility and minimum space requirement – these are the key prerequisites for high-performance switchgear and control cabinets in industrial environments. Switchgear cabinet manufacturers have to respond increasingly rapidly to their efficiency-conscious customers' requirements. Simplified configuration, planning and implementation bring you additional competitive advantages. The SIVACON 8MF1 system cubicles were rigorously designed to meet the increased demands placed on control cabinet construction.

The SIVACON 8MF1 modular system enables custom-tailored solutions to be configured for virtually all industrial sectors and applications. Whether fully assembled, adapted according to your specifications, or developed individually, the system cubicles support the individual creation of added value in control cabinet construction. With SIVACON 8MF1, you can also be sure of absolute compliance with relevant standards: The switchgear enclosures meet all currently applicable standards and regulations. Special versions, and control cabinets with various special certifications and specific approvals, as well as variants adapted to specific sectors, can be individually developed.



System Cubicles, System Lighting and System Air-Conditioning



All the information you need	17/2
System overview	17/4
SIVACON 8MF1 basic cubicles	17/7
Quick selection guide	17/7
Online configurator highlights	17/8
Structure of the article numbers	17/9
SIVACON 8MF1 configurable enclosures	17/10
Quick selection guide	17/10
Frame	17/11
Door, door halves, compartment door	17/14
Side/rear walls and partition	17/18
Roof	17/20
Floor	17/22
Mounting panels	17/23
Mounting plates	17/24
Mounting rails	17/25
General accessories interior installation	17/26
19-inch expansion	17/30
SIVACON 8MF/8MR system lighting	17/32
Quick selection guide	17/32
LED lights	17/34
Slimline lights	17/36
SIVACON 8MR system air-conditioning	17/38
Quick selection guide	17/38
Filter fans and outlet filters	17/39
Roof filter fans and roof outlet filters	17/41
Air conditioners/cooling devices, heat exchangers	17/42
Heater units	17/43
Fan heaters	17/44
Thermostats	17/45
Hygrostats and hygrotherms	17/47

A multitude of additional information ...

Information + ordering

All the important things at a glance

For information about system cubicles, system lighting and system air-conditioning, please visit our website www.siemens.com/sivacon-8mf

Your product in detail

The SiePortal platform (knowledge base) provides comprehensive information www.siemens.com/lowvoltage/product-support

- Brochure
 - SIVACON 8MF1 system cubicles –
As versatile as your requirements ([109744677](https://www.siemens.com/109744677))

The relevant tender specifications can be found at www.siemens.com/tenderspecifications

Use our conversion tool for quick and easy conversion to Siemens products www.siemens.com/conversion-tool

Everything you need for your order

Refer to SiePortal to find an overview of your products (product catalog)

- System cubicles sie.ag/339cQB9

Direct forwarding to the individual products in SiePortal by clicking on the article number in the catalog or entering this web address incl. article number www.siemens.com/product_catalog_SIEP?Article No.

Configurators

The configurator reduces the time and effort required in the planning and ordering process, and allows for individual adaptations. Configure your SIVACON 8MF1 system cubicle at www.siemens.com/lowvoltage/8mf1-configurator

The following are additionally available for your configured SIVACON 8MF1 system cubicle:

- Parts lists
- 2D data
- 3D data

The fast track to the experts

Contact persons in your region

We offer a comprehensive portfolio of services. You can find your local contacts at www.siemens.com/lowvoltage/systems/contact

You will find further information on services at www.siemens.com/service-offers

Competent expert advice on technical questions with a wide range of demand-optimized services for all our products and systems.

Assistance with technical queries is provided at www.siemens.com/support-request

... can be found in our online services

Commissioning + operation

SIMARIS therm

The SIMARIS therm calculation tool helps you to easily and precisely dimension the heat dissipation of your control panels, simply by entering the ambient air temperature and selecting the relevant devices in the panel. If necessary, you can immediately select the necessary cooling devices and air conditioners. You can also define the necessary heating power for anti-condensation heating
www.siemens.com/simaristherm

Ihr Produkt im Detail

The SiePortal platform (knowledge base) provides detailed technical information
www.siemens.com/lowvoltage/product-support

- Operating instructions
- Certificates

Online Support app available for download from the [App Store](#) and [Play Store](#)
 You will find further information at
www.siemens.com/support-app

Provision of 3D data (step and u3d data formats)

- SiePortal (product catalog)
www.siemens.com/lowvoltage/product-catalog
- Image database
www.siemens.com/lowvoltage/picturedb

Engineering data for CAD or CAE systems are available in the CAx Download Manager at
www.siemens.com/cax

Technical overview – System cubicles, system lighting and system air-conditioning



The fast way to get you to our online services

This page provides you with comprehensive information and links on system cubicles, system lighting and system air-conditioning
www.siemens.com/lowvoltage/product-support (109769091)

System overview

System cubicles, system lighting and system air-conditioning

For a complete and valid configuration of your system cubicle, please use our online configurator at www.siemens.com/lowvoltage/8mf1-configurator

SIVACON 8MF1 basic cubicles



Basic cubicles, IP40



Basic cubicles, IP55



Ventilated cubicles, IP20



Data cubicles, IP40



Earthquake-resistant cubicles, IP40

SIVACON 8MF1 configurable enclosures – Frames



Standard frames



Corner frames

Frame accessories



Bases



Separators



Trim strips



Transport eyebolts



Transport brackets



Cubicle suites

SIVACON 8MF1 configurable enclosures – Enclosures



Doors



Ventilated doors



Glass doors



Door halves



Compartment doors



Side walls/rear walls



Rooves



Floors

Enclosure accessories



Roof trays



Covers



Grilles



Strips



Hinges



Rotary handles



Door position switches

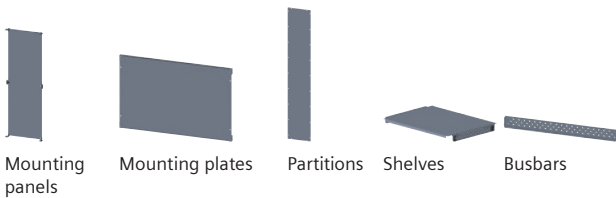


Door stays

Note:

You will find a detailed range of accessories with the basic units and in the Accessories section.

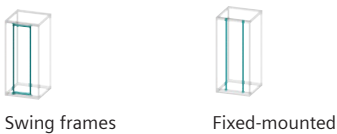
SIVACON 8MF1 configurable enclosures – Interior installation



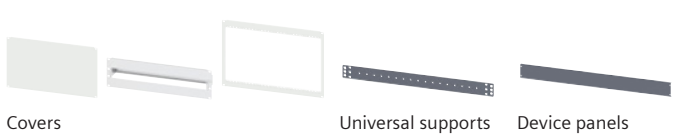
Interior installation accessories



SIVACON 8MF1 configurable enclosures – 19-inch expansion



19-inch expansion accessories



SIVACON 8MF/8MR system lighting – LED lights



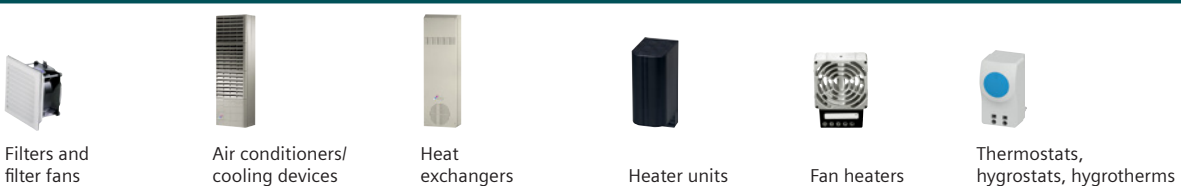
LED lights accessories



SIVACON 8MF/8MR system lighting – Slimline lights



SIVACON 8MR system air-conditioning



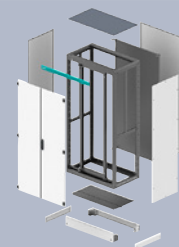
Note:
You will find a detailed range of accessories with the basic units and in the Accessories section.

System overview

SIVACON 8MF1 system cubicles



Standard types



Individual types

Available dimensions			
Height	mm	1800 2000 2200	Special dimensions available on request (max. 2400 mm)
Width	mm	400 600 800 900 1000 1200	Special dimensions available on request (max. 1600 mm)
Depth	mm	400 500 600 800 1000	Special dimensions available on request (max. 1200 mm)
Approvals			
Standards		IEC 62208	IEC 62208
Protection			
Degree of protection		IP20 IP40 IP55 Shock resistance IK09 Glass doors IK08	IP20 IP21 IP40 IP41 IP42 IP55 Shock resistance IK09 Glass doors IK08
Protection class		I	I
Enclosure			
Material		Sheet steel	Sheet steel
Surface		Zinc-plated Powder-coated	Zinc-plated Powder-coated
Color		RAL 7035 (light gray)	All RAL colors available, other color palettes available on request
Corrosivity category acc. to EN ISO 12944-2		C3 medium, paint thickness 100 µm (±25 µm)	Up to C5-M very high (marine), paint thickness 150 µm (±25 µm)
Material thickness			
Frame		2.5 mm	2.5 mm
Enclosure (without doors)		1.5 mm	≤ 2.5 mm
Mounting panels		2.5 mm	≤ 3.0 mm
Mounting plates		2.0 mm	≤ 3.0 mm
Doors		1.5 mm	≤ 2.0 mm
EMC attenuation			
EMC attenuation		www.siemens.com/lowvoltage/product-support	www.siemens.com/lowvoltage/product-support
Installable module heights (HU = 1 3/4" = 44.45 mm)			
		19" fixed-mounted	19" swing frame
Height 1800 mm		36 HU	34 HU
Height 2000 mm		41 HU	38 HU
Height 2200 mm		45 HU	43 HU
			On request
			On request
			On request

Quick selection guide

Two installation types



Stand-alone installation

- With side panels
(lockable in the case of data cubicles)



Suite installation

- Without side panels

Four versions



Basic version

- IP40 or IP55



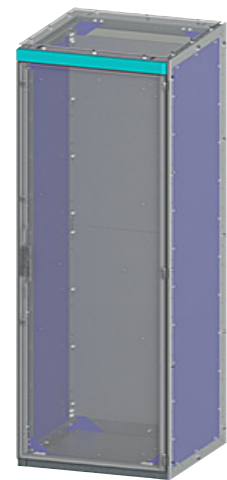
Ventilated cubicles

- IP20
- Door and roof with ventilation fins



Data cubicles

- IP40
- Glass door at front
- Section door at rear
- Roof with cable entry
- 19" fixed-mounted



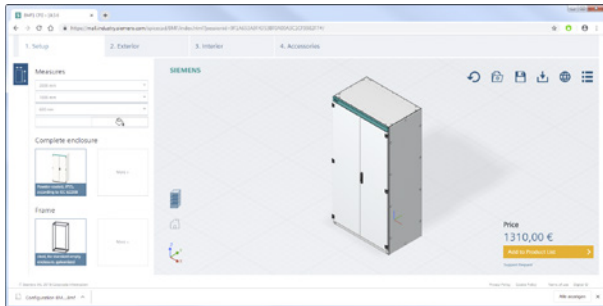
Earthquake-resistant version

- IP40
- Increased stability

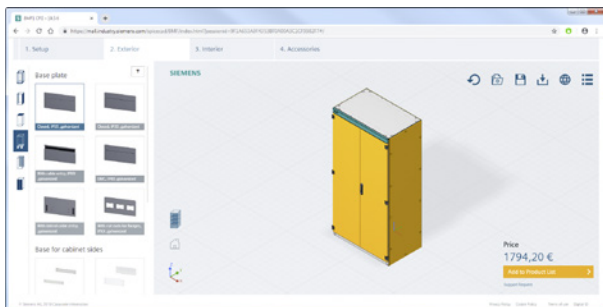
Online configurator highlights

www.siemens.com/lowvoltage/8mf1-configurator

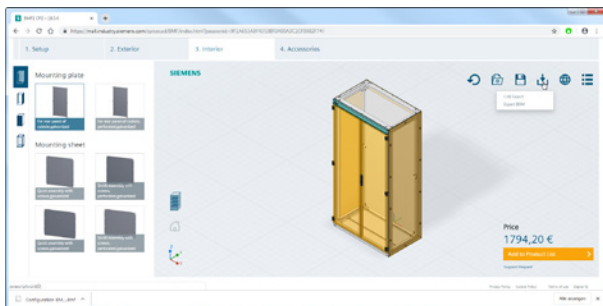
Graphical configuration directly on the 3D model



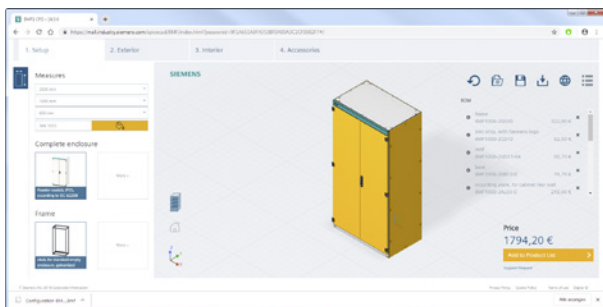
Customization of the control cabinet with cutouts and color



Exporting of parts lists and 3D and 2D data



Dynamic and interactive parts lists



Structure of the article numbers

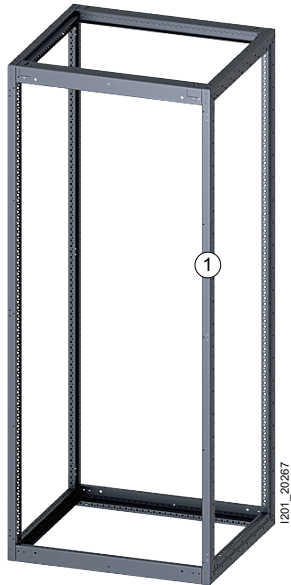
The structure shown below is intended as an overview of each position and its meaning. For a complete and valid configuration of your system cubicle, please use our online configurator at www.siemens.com/lowvoltage/8mf1-configurator

		5	6	7	8	9	10	11
8MF1					3			
Height	1800 mm	8						
	2000 mm	0						
	2200 mm	2						
Width	400 mm		4					
	600 mm		6					
	800 mm		8					
	900 mm		9					
	1000 mm		0					
	1200 mm		2					
Depth	400 mm			4				
	500 mm			5				
	600 mm			6				
	800 mm			8				
	1000 mm			0				
Version	Basic					B		
	Ventilated					V		
	Data					D		
	Earthquake-resistant					E		
Installation	Stand-alone						S	
	Side by side						R	
Degree of protection	Basic cubicles, data cubicles	IP40						4
		IP55						5
	Ventilated cubicles	IP20						4
	Earthquake-resistant cubicles	IP40						5

Quick selection guide

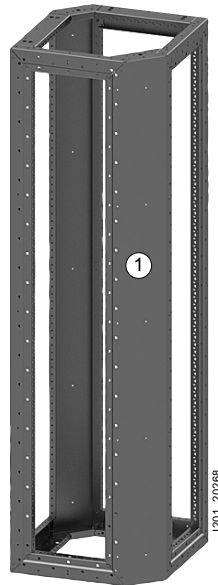
Frame

For standard enclosure



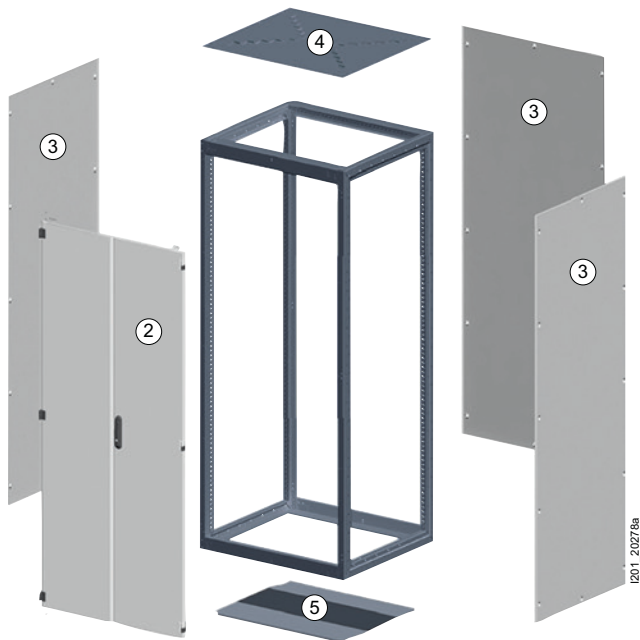
① Frame

For corner enclosure



① Frame

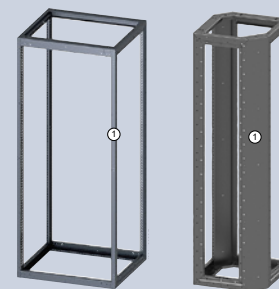
Enclosure



② Door, door half, compartment door
③ Side panels, rear panel

④ Roof
⑤ Floor

① Frame



The structure shown below is intended as an overview of each position and its meaning.
For a complete and valid configuration of your system cubicle, please use our online configurator at www.siemens.com/lowvoltage/8mf1-configurator

For standard enclosure

		8MF1	5	6	7	8	9	10	11	12
Height	1800 mm		8							
	2000 mm		0							
	2200 mm		2							
Width	400 mm			4						
	600 mm			6						
	800 mm			8						
	900 mm			9						
	1000 mm			0						
	1200 mm			2						
Depth	400 mm				4					
	500 mm				5					
	600 mm				6					
	800 mm				8					
	1000 mm				0					
Material, surface	Zinc-plated								3	
	Powder-coated, RAL 7035								4	

For corner enclosure

		8MF1	5	6	7	8	9	10	11	12
Height	1800 mm		8							
	2000 mm		0							
	2200 mm		2							
Width	400 mm			4						
	600 mm			6						
	800 mm			8						
	1000 mm			0						
Depth	400 mm				5					
	600 mm				7					
	800 mm				0					
	1000 mm				1					
Material, surface	Zinc-plated								3	

① Frame

Accessories

The structure shown below is intended as an overview of each position and its meaning. For a complete and valid configuration of your system cubicle, please use our online configurator at www.siemens.com/lowvoltage/8mf1-configurator

Base



		5	6	7	8	9	10
		8MF1					
Height	100 mm	0					
	200 mm	2					
Width	400 mm		4				
	600 mm		6				
	800 mm		8				
	900 mm		9				
	1000 mm		0				
	1200 mm		2				
Version	Base for cubicles with door at the front and the rear					C	R
	Base and feet for cubicles with door at the front					C	S
	Base for corner cubicle					E	S

Base cover



		5	6	7	8	9	10
		8MF1					
Height	100 mm	0					
	200 mm	2					
Depth	400 mm			4			
	500 mm			5			
	600 mm			6			
	800 mm			8			
	1000 mm			0			
Version	Base covers for cubicle sides						T

The structure shown below is intended as an overview of each position and its meaning.
For a complete and valid configuration of your system cubicle, please use our online configurator at
www.siemens.com/lowvoltage/8mf1-configurator

Trim strip



		5	6	7	8	9	10	11	12
8MF1		0		0	2	C	D		
Width	400 mm	4							
	600 mm	6							
	800 mm	8							
	900 mm	9							
	1000 mm	0							
	1200 mm	2							
Version	Trim strip petrol	Without Siemens logo, above the door		Without cutout		0	0		
		With Siemens logo, left, above the door		Without cutout		1	0		
		With Siemens logo, right, above the door		With cutout, left		1	6		
		With Siemens logo, left, above the door		With cutout, right		1	7		
	Trim strip RAL 7035	Without Siemens logo, below the door		Without cutout		0	8		

Separator

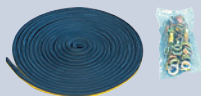
Separator for vertical division of the enclosure



Height	Article No.
1800 mm	8MF1165-2AT30
2000 mm	8MF1185-2AT30
2200 mm	8MF1205-2AT30

Mounting accessories

Accessories for cubicle suites



Version	Degree of protection	Article No.
Screw set	IP40	8MF1000-2CA
Sealing strip	IP40 to IP55	8MF1000-2CB
Side-by-side installation kit	IP40 EMC (IP55 not available)	8MF1000-2CE

Kit for stabilization of corner connections



Scope of supply	Article No.
8 units	8MF1000-2HF

Transport accessories

Transport eyebolts



Load bearing capacity	Article No.
Up to 500 kg	8MF1000-2CK

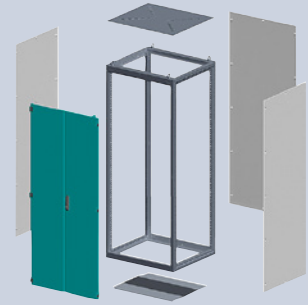
Transport brackets



Width	Article No.
400 mm	8MF1040-2CW
600 mm	8MF1060-2CW
800 mm	8MF1080-2CW
900 mm	8MF1090-2CW
1000 mm	8MF1000-2CW
1200 mm	8MF1020-2CW

② Door, door halves, compartment door

Door, door halves



The structure shown below is intended as an overview of each position and its meaning. For a complete and valid configuration of your system cubicle, please use our online configurator at www.siemens.com/lowvoltage/8mf1-configurator

		5	6	7	8	9	10	11	12	13	14	15	16			
		8MF1		0	2	U	T									
Height	1800 mm	8														
	2000 mm	0														
	2200 mm	2														
Width	300 mm		3													
	400 mm		4													
	450 mm		7													
	500 mm		5													
	600 mm		6													
	800 mm		8													
	900 mm		9													
	1000 mm		0													
1200 mm		2														
Door type	Door/inner door							1								
	Door halves (only available with hinging on the left)							2								
Hinge position	Left							5								
	Right							4								
Door version	IP20	With ventilation openings								1	B	A	2			
	IP40	Closed								0	C	A	1			
		With ventilation slits									2	B	A	2		
	IP55	Closed									0	B	A	2		
		With inspection window <i>Strips for door reinforcement cannot be mounted</i>										0	B	E	2	
	IPxx	With cutout 292 × 292 mm (up to IP55) for filter fan										3	B	A	2	
	–	Inner door, closed (up to 800 mm wide)											4	B	A	2




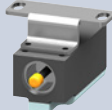



Compartment door


The structure shown below is intended as an overview of each position and its meaning. For a complete and valid configuration of your system cubicle, please use our online configurator at www.siemens.com/lowvoltage/8mf1-configurator

		5	6	7	8	9	10	11	12	13	14	15	16
8MF1				0	2	U	T	3	4	0	B	A	2
Compartment height	300 mm	3											
	400 mm	4											
	500 mm	5											
	600 mm	6											
	700 mm	7											
	800 mm	8											
	900 mm	9											
	1000 mm	0											
	1100 mm	1											
1200 mm	2												
Width	600 mm		6										
	800 mm		8										




② Door, door halves, compartment door

Accessories

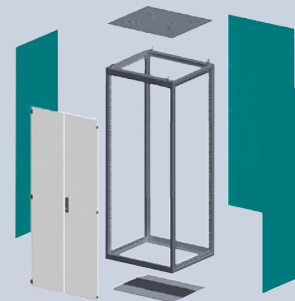
Door shelves					
	<ul style="list-style-type: none"> Multi-purpose door bars required for mounting Shelf: RAL 7035 				
	For door width	Mounting location			Article No.
		Door	Door halves	Compartment door	
600 mm	■	■	–	8MF1060-2VP	
800 mm	■	■	–	8MF1080-2VP	
Grilles					
	<ul style="list-style-type: none"> To upgrade degree of protection from IP2x to IP4x Surface: zinc-plated 				
	Width	Mounting location			Article No.
		Door	Door halves	Compartment door	
	300 mm	■	■	–	8MF1030-2HM
	400 mm	■	■	–	8MF1040-2HM
	450 mm	■	■	–	8MF1070-2HM
	500 mm	■	■	–	8MF1050-2HM
	600 mm	■	■	–	8MF1060-2HM
800 mm	■	■	–	8MF1080-2HM	
900 mm	■	■	–	8MF1090-2HM	
Strips					
	<ul style="list-style-type: none"> For door reinforcement Surface: zinc-plated Cannot be used for glass doors 				
	Height	Mounting location			Article No.
		Door	Door halves	Compartment door	
	1800 mm	■	■	–	8MF1008-2VM
2000 mm	■	■	–	8MF1000-2VM	
2200 mm	■	■	–	8MF1002-2VM	
Door position switches					
	Version	Mounting location			Article No.
		Door	Door halves	Compartment door	
	1 NO + 1 NC (incl. 3SE5232-0HC05)	■	■	■	8MF1000-2VL
1 NO + 2 NC (incl. 3SE5232-0LC05)	■	■	■	8MF1000-2VR	
Circuit diagram pockets					
	<ul style="list-style-type: none"> Cannot be used for glass doors 				
	Version	Mounting location			Article No.
		Door	Door halves	Compartment door	
Plastic	■	■	–	8MF1000-2VK	
Steel, zinc-plated	■	■	–	8MF1000-2VU	
Limit plates					
	For a number n of compartment doors, n–1 limit plates are additionally required. Please order separately.				
	Width	Mounting location			Article No.
		Door	Door halves	Compartment door	
600 mm	–	–	■	8MF1060-2AK14-0	
800 mm	–	–	■	8MF1080-2AK14-0	
Door stays					
	<ul style="list-style-type: none"> With variable opening angle: 90°, 120° and 150° Surface: zinc-plated 				
	Mounting location			Article No.	
	Door	Door halves	Compartment door		
■	■	–	8MF1000-2VG		

Rotary handles					
	Version	Mounting location			Article No.
		Door	Door halves	Compartment door	
	With button insert and eye for padlock (Lock not included in 8MF portfolio)	■	–	–	8MF1000-2VN
Rotary handle inserts					
	• Not suitable for door halves				
	Version	Mounting location			Article No.
		Door	Door halves	Compartment door	
	Double-bit key 3 mm	■	–	–	8MF1000-2VA
	Square key 8 mm	■	–	–	8MF1000-2VC
	Triangular key 8 mm	■	–	–	8MF1000-2VD
	Daimler	■	–	–	8MF1000-2VE
	Cylinder lock	■	–	–	8MF1000-2VF

Spare part door

Hinge sets					
	Version	Mounting location			Article No.
		Door	Door halves	Compartment door	
	For left-hand hinge (1 set = 3 units)	■	■	■	8MF1000-2VT
	For right-hand hinge (1 set = 3 units)	■	■	■	8MF1000-2VW
Rotary handles					
	Version	Mounting location			Article No.
		Door	Door halves	Compartment door	
	With button insert	■	–	–	8MF1000-2VP
Grounding cables for doors					
	Cable cross-section	Mounting location			Article No.
		Door	Door halves	Compartment door	
	6 mm ²	■	■	■	8MF1010-2HD3

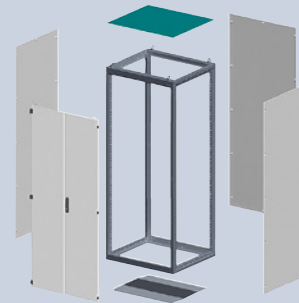
③ Side/rear walls and partition



The structure shown below is intended as an overview of each position and its meaning. For a complete and valid configuration of your system cubicle, please use our online configurator at www.siemens.com/lowvoltage/8mf1-configurator

		5	6	7	8	9	10	11	12	13	14
		8MF1			2	U	W				
Height	1800 mm	8									
	2000 mm	0									
	2200 mm	2									
Width	300 mm		3								
	400 mm		4								
	450 mm		7								
	500 mm		5								
	600 mm		6								
	800 mm		8								
	900 mm		9								
	1000 mm/ <i>No selection available for partitions</i>		0								
	1200 mm		2								
Depth	No value			0							
	400 mm			4							
	500 mm			5							
	600 mm			6							
	800 mm			8							
1000 mm/ <i>No selection available for side panels</i>			0								
Side wall/ rear wall	IP40	Closed	Without seal					6	0	1	C
			EMC seal				6	2	1	B	
	Flat				6	3	1	C			
IP55	Closed	Foamed seal					6	1	1	C	
Partition	Closed	Without seal					7	0	3	C	

④ Roof



The structure shown below is intended as an overview of each position and its meaning.
For a complete and valid configuration of your system cubicle, please use our online configurator at www.siemens.com/lowvoltage/8mf1-configurator

For standard systems

8MF1				5	6	7	8	9	10	11	12	13	14
				0			2	U	D				
Width	400 mm			4									
	600 mm			6									
	800 mm			8									
	900 mm			9									
	1000 mm			0									
	1200 mm			2									
Depth	400 mm					4							
	500 mm					5							
	600 mm					6							
	800 mm					8							
	1000 mm					0							
Version	IP20	Perforated	Without seal							2	0	0	A
			With seal						1	0	0	A	
	IP40	Closed	Without seal							1	2	0	A
			EMC seal						3	0	0	A	
			With ventilation fins	Without seal						1	1	0	A
	IP55	Closed	Foamed seal							1	1	0	A

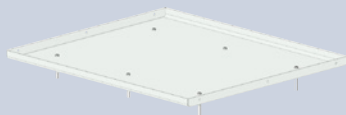
For corner enclosure

8MF1				5	6	7	8	9	10	11	12	13	14
				0	0		2	U	E				
Width/depth	400/400 mm					4							
	600/600 mm					6							
	800/800 mm					8							
	1000/1000 mm					0							
Version	For corner cubicle	IP20	With ventilation openings							2	0	0	A
			Closed						1	0	0	A	
		IP40	With ventilation openings							3	0	0	A
			Closed							1	1	0	A

Accessories

Roof trays

Roof trays for increasing the degree of protection, IPX1



Width	Depth	Article No.
400 mm	400 mm	8MF1044-2VH
	500 mm	8MF1045-2VH
	600 mm	8MF1046-2VH
	800 mm	8MF1048-2VH
	1000 mm	8MF1040-2VH
600 mm	400 mm	8MF1064-2VH
	500 mm	8MF1065-2VH
	600 mm	8MF1066-2VH
	800 mm	8MF1068-2VH
	1000 mm	8MF1060-2VH
800 mm	400 mm	8MF1084-2VH
	500 mm	8MF1085-2VH
	600 mm	8MF1086-2VH
	800 mm	8MF1088-2VH
	1000 mm	8MF1080-2VH
900 mm	400 mm	8MF1094-2VH
	500 mm	8MF1095-2VH
	600 mm	8MF1096-2VH
	800 mm	8MF1098-2VH
	1000 mm	8MF1090-2VH
1000 mm	400 mm	8MF1004-2VH
	500 mm	8MF1005-2VH
	600 mm	8MF1006-2VH
	800 mm	8MF1008-2VH
	1000 mm	8MF1000-2VH
1200 mm	400 mm	8MF1024-2VH
	500 mm	8MF1025-2VH
	600 mm	8MF1026-2VH
	800 mm	8MF1028-2VH
	1000 mm	8MF1020-2VH

Roof tray rims

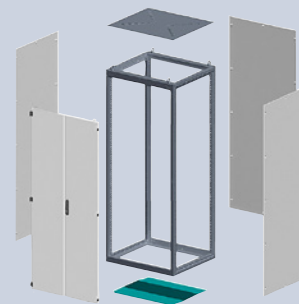
Roof tray rims for cubicle side, IPX1



Each cubicle or cubicle group with a roof tray requires two roof tray rims.
(1 set = 2 units)

Depth	Article No.
400 mm	8MF1004-2VB
500 mm	8MF1005-2VB
600 mm	8MF1006-2VB
800 mm	8MF1008-2VB
1000 mm	8MF1000-2VB

⑤ Floor



The structure shown below is intended as an overview of each position and its meaning.
For a complete and valid configuration of your system cubicle, please use our online configurator at www.siemens.com/lowvoltage/8mf1-configurator

For standard enclosure

		5	6	7	8	9	10	11	12	13
		0			2	U	B			
8MF1										
Width	400 mm		4							
	600 mm		6							
	800 mm		8							
	900 mm		9							
	1000 mm		0							
	1200 mm		2							
Depth	400 mm			4						
	500 mm			5						
	600 mm			6						
	800 mm			8						
	1000 mm			0						
Version	IP30 Closed, divided							2	2	0
	IP40 Closed EMC seal							4	2	0
	IP55 Closed Foamed seal							1	2	0
	IPxx With cable entry							3	2	0
	With cable entry, lateral and rear ¹⁾							5	1	2
With cut-outs for flanges							5	2	0	

¹⁾ Version available from width ≥ 600 mm and depth ≥ 600 mm

For corner enclosure

		5	6	7	8	9	10	11	12	13
		0	0		2	U	E		1	0
8MF1										
Depth	400 mm			4						
	600 mm			6						
	800 mm			8						
	1000 mm			0						
Degree of protection	IP40							2		
	IP55							1		

Mounting panels



The structure shown below is intended as an overview of each position and its meaning.
For a complete and valid configuration of your system cubicle, please use our online configurator at www.siemens.com/lowvoltage/8mf1-configurator

		5	6	7	8	9	10	11	12	13
		8MF1			2	A				0
Cubicle height	1800 mm	8								
	2000 mm	0								
	2200 mm	2								
Cubicle width	400 mm		4							
	600 mm		6							
	800 mm		8							
	900 mm		9							
	1000 mm/No selection available for installation on side of cubicle		0							
	1200 mm		2							
Depth	400 mm			4						
	500 mm			5						
	600 mm			6						
	800 mm			8						
	1000 mm/No selection available for installation on cubicle width			0						
Installation location	Cubicle width						L			
	Cubicle side						K			
Version	Smooth							0		
	Perforated							1		
Material	2.5 mm sheet steel									3

Accessories

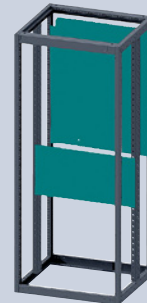
Mounting panel adapters



- For connecting side-by-side mounting panels
- Surface: zinc-plated

Height	Article No.
1800 mm	8MF1800-2CH
2000 mm	8MF1000-2CH
2200 mm	8MF1200-2CH

Mounting plates

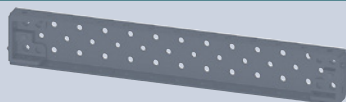


The structure shown below is intended as an overview of each position and its meaning. For a complete and valid configuration of your system cubicle, please use our online configurator at www.siemens.com/lowvoltage/8mf1-configurator

		5	6	7	8	9	10	11	12	13
		8MF1		0	2	A				0
Height	100 mm	1								
	200 mm	2								
	300 mm	3								
	400 mm	4								
	600 mm	6								
	800 mm	8								
Width	400 mm		4							
	600 mm		6							
	800 mm		8							
	900 mm		9							
	1000 mm		0							
	1200 mm		2							
Installation location	Fixed with zinc die-cast parts between the bars of the frame						M			
	Fixed directly to the frame						A			
Version	Smooth							0		
	Perforated							1		
Material	2.0 mm sheet steel									2

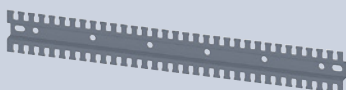
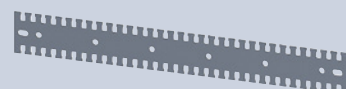
Mounting rails

Mounting rails (50)



Length	Version	Article No.
250 mm	Suitable for cubicle depth 400 mm	8MF1025-2AS30
325 mm	Suitable for cubicle width 400 mm	8MF1032-2AS30
350 mm	Suitable for cubicle depth 500 mm	8MF1035-2AS30
425 mm	–	8MF1042-2AS30
450 mm	Suitable for cubicle depth 600 mm	8MF1045-2AS30
525 mm	Suitable for cubicle width 600 mm	8MF1052-2AS30
550 mm	–	8MF1055-2AS30
625 mm	–	8MF1062-2AS30
650 mm	Suitable for cubicle depth 800 mm	8MF1065-2AS30
725 mm	Suitable for cubicle width 800 mm	8MF1072-2AS30
750 mm	–	8MF1075-2AS30
825 mm	Suitable for cubicle width 900 mm	8MF1082-2AS30
850 mm	Suitable for cubicle depth 1000 mm	8MF1085-2AS30
925 mm	Suitable for cubicle width 1000 mm	8MF1092-2AS30
1050 mm	–	8MF1105-2AS30
1125 mm	Suitable for cubicle width 1200 mm	8MF1112-2AS30
1250 mm	–	8MF1125-2AS30
1350 mm	–	8MF1135-2AS30
1450 mm	–	8MF1145-2AS30
1550 mm	–	8MF1155-2AS30
1650 mm	Suitable for cubicle height 1800 mm	8MF1165-2AS30
1750 mm	–	8MF1175-2AS30
1850 mm	Suitable for cubicle height 2000 mm	8MF1185-2AS30
1950 mm	–	8MF1195-2AS30
2050 mm	Suitable for cubicle height 2200 mm	8MF1205-2AS30
2150 mm	–	8MF1215-2AS30
2250 mm	–	8MF1225-2AS30

Mounting rails, serrated



Version	Article No.
Flat	8MF1060-2HC13-0
	8MF1080-2HC13-0
	8MF1090-2HC13-0
	8MF1000-2HC13-0
	8MF1020-2HC13-0
U-shape	8MF1060-2HC03-0
	8MF1080-2HC03-0
	8MF1090-2HC03-0
	8MF1000-2HC03-0
	8MF1020-2HC03-0

Mounting rails, compact



Version	Length	Article No.
Suitable for cubicle width	600 mm	8MF1056-2AS30
	1000 mm	8MF1096-2AS30
	1200 mm	8MF1006-2AS30
Suitable for door width	300 mm	8MF1016-2AS30
	400 mm	8MF1026-2AS30
	450 mm	8MF1031-2AS30
	500 mm	8MF1036-2AS30
	600 mm	8MF1046-2AS30
	800 mm	8MF1066-2AS30
	900 mm	8MF1076-2AS30
	1000 mm	8MF1086-2AS30

Mounting rails, heavy duty



- Can be installed in the cubicle depth and width (the length corresponds to the appropriate cubicle dimension)

Length	Article No.
600 mm	8MF1060-2AH60
800 mm	8MF1080-2AH60
900 mm	8MF1090-2AH60
1000 mm	8MF1000-2AH60
1200 mm	8MF1020-2AH60

General accessories interior installation

Telescopic rails



- For withdrawable shelves

For cubicle depth	Article No.
400 mm and 600 mm	8MF1003-2HF
800 mm and 1000 mm	8MF1006-2HF

Mounting brackets



- For mounting expansion elements

Article No.
8MF1000-2CP

Earthquake assembly kits



For stabilization of	Article No.
Corner connections	8MF1000-2HA



Intermediate panel	8MF1000-2HW
--------------------	-------------



19" fixed-mounted	8MF1000-2HE
-------------------	-------------

Grounding plates



- For fixing to the frame (although fixing points for ground connection are already provided on the frame)

Article No.
8MF1000-2HK

Grounding bars



Version	Width	Article No.
30 × 10 mm ²	600 mm	8MF1060-2HD2
	800 mm	8MF1080-2HD2
	900 mm	8MF1090-2HD2
	1000 mm	8MF1000-2HD2
	1200 mm	8MF1020-2HD2
30 × 5 mm ²	600 mm	8MF1060-2HD1
	800 mm	8MF1080-2HD1
	900 mm	8MF1090-2HD1
	1000 mm	8MF1000-2HD1
	1200 mm	8MF1020-2HD1

Grounding screws



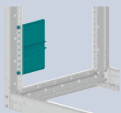
Thread	Article No.
M12	8MF1000-2HB

Grounding straps



Cross-section	Length	Perforation	Article No.
16 mm ²	300 mm	6.5 mm on both sides	8MF1000-2HK1
16 mm ²	300 mm	6.5 mm and 8.5 mm	8MF1000-2HK2

Universal sheets

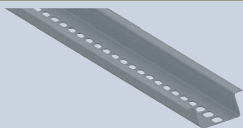


- Incl. DIN rail; e.g. for mounting a heater unit

Article No.

8MF1000-2HG

DIN rails



- For mounting modular installation devices

Height

Article No.

7.5 mm

8MF1500-2HS

15 mm

8MF1100-2HS

Insulated supports



Thread

Dimensions

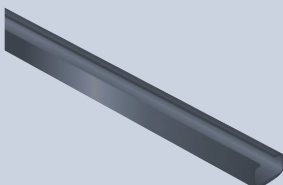
Article No.

M8

D 40 × 50 mm

8MF1000-2VY

Cable clamping rails



Height

Width

Depth

Article No.

30 mm

600 mm

–

8MF1360-2HH

800 mm

–

8MF1380-2HH

900 mm

–

8MF1390-2HH

1000 mm

–

8MF1310-2HH

1200 mm

–

8MF1320-2HH

–

400 mm

8MF1304-2HH

600 mm

8MF1306-2HH

800 mm

8MF1308-2HH

1000 mm

8MF1301-2HH

40 mm

600 mm

–

8MF1460-2HH

800 mm

–

8MF1480-2HH

900 mm

–

8MF1490-2HH

1000 mm

–

8MF1410-2HH

1200 mm

–

8MF1420-2HH

–

400 mm

8MF1404-2HH

600 mm

8MF1406-2HH

800 mm

8MF1408-2HH

1000 mm

8MF1401-2HH

50 mm

600 mm

–

8MF1560-2HH

800 mm

–

8MF1580-2HH

900 mm

–

8MF1590-2HH

1000 mm

–

8MF1510-2HH

1200 mm

–

8MF1520-2HH

–

400 mm

8MF1504-2HH

600 mm

8MF1506-2HH

800 mm

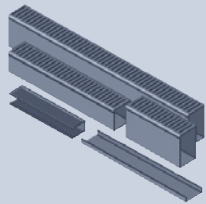
8MF1508-2HH

1000 mm

8MF1501-2HH

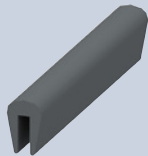
General accessories interior installation

Cable ducts



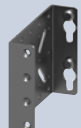
Version	Color	Height	Width	Article No.
Halogen-free	RAL 7035	37.5 mm	25 mm	8MF1120-2HL7
		50 mm	25 mm	8MF1220-2HL7
			37.5 mm	8MF1240-2HL7
			50 mm	8MF1250-2HL7
			75 mm	8MF1260-2HL7
		75 mm	50 mm	8MF1350-2HL7
			75 mm	8MF1360-2HL7
			100 mm	8MF1370-2HL7
			125 mm	8MF1380-2HL7
			100 mm	75 mm
Standard	RAL 7030		37.5 mm	25 mm
		50 mm	25 mm	8MF1220-2HL6
			37.5 mm	8MF1240-2HL6
			50 mm	8MF1250-2HL6
			75 mm	8MF1260-2HL6
		75 mm	50 mm	8MF1350-2HL6
			75 mm	8MF1360-2HL6
			100 mm	8MF1370-2HL6
			125 mm	8MF1380-2HL6
			100 mm	75 mm

Edge protection



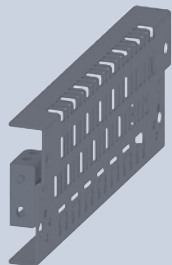
Dimensions	Article No.
9.5 × 6.5 mm	8MF1000-2CD

Mounting plates


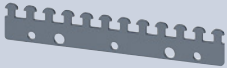





Dimensions	Version	Article No.
122 × 91 mm	Standard	8MF1000-2HH
122 × 92 mm	With DIN rail	8MF1000-2HH1

Buses for improving EMC

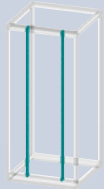


Installation in	Width	Depth	Article No.
Cubicle width	400 mm	–	8MF1040-2HN
	600 mm	–	8MF1060-2HN
	800 mm	–	8MF1080-2HN
	900 mm	–	8MF1090-2HN
	1000 mm	–	8MF1000-2HN
	1200 mm	–	8MF1020-2HN
Cubicle depth	–	400 mm	8MF1004-2HN
	–	600 mm	8MF1006-2HN
	–	800 mm	8MF1008-2HN
	–	1000 mm	8MF1001-2HN

Brackets		
	• For variable mounting of cable clamping rails	
		Article No. 8MF1000-2HH5
Toothed bars		
	• For installation on mounting rail	
	Length 100 mm	Article No. 8MF1000-2HC
Contact washers		
	• Size 6	
	Scope of supply 100 units	Article No. 8MF1000-2VJ
Screws		
	• M6 × 12	
	Scope of supply 100 units	Article No. 8MF1000-2VS
Adapters for wiring systems		
	Version	Article No.
	For Lütze wiring system	8MF1000-2HL
	For Promet wiring system	8MF1000-2HP

19-inch expansion

Cubicle frames



- For the installation of 19" devices, screwed
- In combination with 2 mounting rails, heavy duty in cubicle width (order mounting rail separately, [see page 17/25](#))
- For cubicle width ≥ 600 mm

Surface	Height	For mounting height	Article No.
Zinc-plated	400 mm	7 HU	8MF1100-2AN30
	600 mm	12 HU	8MF1200-2AN30
	800 mm	16 HU	8MF1300-2AN30
	1000 mm	21 HU	8MF1400-2AN30
	1200 mm	25 HU	8MF1500-2AN30
	1400 mm	30 HU	8MF1600-2AN30
	1800 mm	36 HU	8MF1700-2AN30
	2000 mm	41 HU	8MF1800-2AN30
	2200 mm	45 HU	8MF1900-2AN30

Swing frames



- For the installation of 19" devices, screwed
- Left-hand/right-hand hinge
- In combination with 2 mounting rails, heavy duty in cubicle width (order mounting rail separately)
- For cubicle width ≥ 800 mm

Version	Surface	Height	For mounting height	Article No.
Screwed ¹⁾	Zinc-plated	1800 mm	34 HU	8MF1800-2AR02-4
		2000 mm	38 HU	8MF1000-2AR02-4
		2200 mm	43 HU	8MF1200-2AR02-4
	Powder-coated	1800 mm	34 HU	8MF1800-2AR02-3
		2000 mm	38 HU	8MF1000-2AR02-3
		2200 mm	43 HU	8MF1200-2AR02-3
Welded ²⁾	Powder-coated	1800 mm	34 HU	8MF1800-2AR02-2
		2000 mm	38 HU	8MF1000-2AR02-2
		2200 mm	43 HU	8MF1200-2AR02-2

¹⁾ Interlocking with 3 mm double-bit key




²⁾ Spring interlocking at top and bottom

Accessories




Universal supports







Version	For mounting height	Article No.
For cable channel, DIN rail and C rail	1 HU	8MF1000-2HH2
	2 HU	8MF1000-2HH3
For cable channel, DIN rail, C rail and lamp		8MF1000-2HH4


Covers				
Version	Surface	For mounting height	Article No.	
	Closed	RAL 7035	1 HU	8MF1000-2AB01
			2 HU	8MF1000-2AB02
			3 HU	8MF1000-2AB03
			4 HU	8MF1000-2AB04
			5 HU	8MF1000-2AB05
			6 HU	8MF1000-2AB06
			7 HU	8MF1000-2AB07
	With ventilation openings	RAL 7035	2 HU	8MF1000-2AB32
			3 HU	8MF1000-2AB33
	For modular installation devices, for 24 modular widths	RAL 7035	3 HU	8MF1000-2AB31

Frames				
Version	Surface	For mounting height	Article No.	
	For mounting test switches, 19"	RAL 7035	7 HU	8MF1000-2AB30

Covers for frames				
Version	Surface	Article No.		
	For mounting 7XP 1/6 standard devices	RAL 7035	8MF1000-2AB34	
	For mounting 7XP 2/6 standard devices	RAL 7035	8MF1000-2AB35	
	For mounting 7XP 3/6 standard devices	RAL 7035	8MF1000-2AB36	

Shelves					
Version	Surface	For mounting height	Depth	Article No.	
	Non-adjustable	Zinc-plated	3 HU	230 mm	8MF1000-2AB12
				400 mm	8MF1000-2AB14
	Withdrawable	RAL 7035	1 HU	8MF1000-2HF12	

Slide rails				
Version	Depth	Article No.		
	For 19" fixed-mounted (double mounting at front and rear)	400 mm	8MF1004-2HG12	
		600 mm	8MF1006-2HG12	
		800 mm	8MF1008-2HG12	
		1000 mm	8MF1000-2HG12	
	For 19" fixed-mounted and for 19" swing frame		8MF1000-2HS12	

Device panels					
Version	Surface	Height	Width	Article No.	
	Zinc-plated	1800 mm	100 mm	8MF1810-2AB00	
			150 mm	8MF1850-2AB00	
			200 mm	8MF1820-2AB00	
		2000 mm	100 mm	8MF1010-2AB00	
			150 mm	8MF1050-2AB00	
			200 mm	8MF1020-2AB00	
		2200 mm	100 mm	8MF1210-2AB00	
			150 mm	8MF1250-2AB00	
			200 mm	8MF1220-2AB00	

Quick selection guide

Standard LED lights

The LED lights offer optimum lighting conditions for installation and maintenance. The LED technology is energy-efficient and maintenance-free. The connection is established via a 2-pin plug with lock. Through-wiring is possible.

Magnetic fixing

Easy installation at any point on the steel cubicle

Screw fixing

Fixed installation in the case of impact loads or high vibration levels

Clip fixing

The lamp is snapped into the clip bracket and can be turned in both directions

With motion detector

The lights switch on when the door is opened, enabling work in the cubicle to be started immediately



With On/Off switch

Particularly suitable for operation in cubicles and enclosures with a high density of built-in electrical/electronic components



Ecoline LED lights **new**

The Ecoline LED lights do not differ from the standard LED lights in terms of luminosity and mounting system. The connection is made via a 2-pole clamping terminal.

Magnetic fixing

Easy installation at any point on the steel cubicle

Screw fixing

Fixed installation in the case of impact loads or high vibration levels

Clip fixing

The lamp is snapped into the clip bracket and can be turned in both directions

With motion detector

The lights switch on when the door is opened, enabling work in the cubicle to be started immediately



With On/Off switch

Particularly suitable for operation in cubicles and enclosures with a high density of built-in electrical/electronic components



Without switching function

Prepared for the use of an external switch



Slimline lights

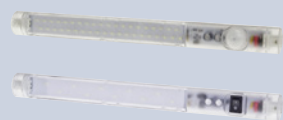
The Slimline lights are an alternative with an energy-saving lamp and are available as a version with an integrated socket.

	Screw fixing	Magnetic fixing
With motion detector and socket The lights switch on when the door is opened, enabling work in the cubicle to be started immediately		
With On/Off switch and socket Particularly suitable for operation in cubicles and enclosures with a high density of built-in electrical/electronic components		

LED lights

Standard

Magnetic fixing



Version	Voltage	Standard	Article No.
With motion detector	100 ... 240 V AC, 50/60 Hz	VDE	8MR2200-0A
	24 ... 48 V DC	VDE	8MR2201-0A
With On/Off switch	100 ... 240 V AC, 50/60 Hz	VDE, UL	8MR2200-1A
	24 ... 48 V DC	VDE, UL	8MR2201-1A

Screw fixing



Version	Voltage	Standard	Article No.
With motion detector	100 ... 240 V AC, 50/60 Hz	VDE	8MR2200-0B
	24 ... 48 V DC	VDE	8MR2201-0B
With On/Off switch	100 ... 240 V AC, 50/60 Hz	VDE, UL	8MR2200-1B
	24 ... 48 V DC	VDE, UL	8MR2201-1B

Clip fixing



Version	Voltage	Standard	Article No.
With motion detector	100 ... 240 V AC, 50/60 Hz	VDE	8MR2200-0C
	24 ... 48 V DC	VDE	8MR2201-0C
With On/Off switch	100 ... 240 V AC, 50/60 Hz	VDE	8MR2200-1C
	24 ... 48 V DC	VDE	8MR2201-1C

Accessories

Cables

Connecting cables with socket and open end

- For connection of an LED light (switch side)
- Length 2 m



Version	Cross-section	Standard	Article No.
AC connecting cable	2 × 1.5 mm ²	VDE	8MR2210-1B
	AWG 16	VDE, UL	8MR2210-2B
DC connecting cable	2 × 1.5 mm ²	VDE	8MR2210-3B
	AWG 16	VDE, UL	8MR2210-4B

Extension cables with socket and plug

- For looping through to another LED light
- Length 1 m



Version	Cross-section	Standard	Article No.
AC plastic-sheathed cable	2 × 1.5 mm ²	VDE	8MR2210-1C
	AWG 16	VDE, UL	8MR2210-2C
DC plastic-sheathed cable	2 × 1.5 mm ²	VDE	8MR2210-3C
	AWG 16	VDE, UL	8MR2210-4C

Individual plugs or sockets for self-assembly of cables

For connection of an LED light (switch side)



Version	Application	Standard	Color	Article No.
AC socket	For input side	VDE	White	8MR2210-1A
DC socket	For input side	VDE	Blue	8MR2210-3A

For looping through to another LED light



Version	Application	Standard	Color	Article No.
AC connector	For output side	VDE	White	8MR2210-2A
DC connector	For output side	VDE	Blue	8MR2210-4A

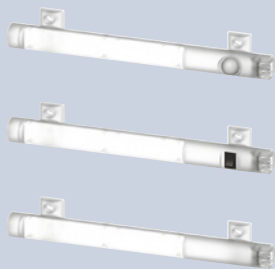
Ecoline **new**

Magnetic fixing



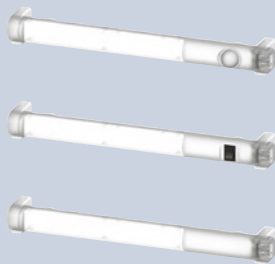
Version	Voltage		Article No.
With motion detector	AC 100 ... 240 V, 50/60 Hz	90 ... 110 V DC	8MR2303-0A
	24 ... 48 V DC		8MR2301-0A
With On/Off switch	AC 100 ... 240 V, 50/60 Hz	90 ... 110 V DC	8MR2303-1A
	24 ... 48 V DC		8MR2301-1A
Without switching function	AC 100 ... 240 V, 50/60 Hz	90 ... 110 V DC	8MR2303-3A
	24 ... 48 V DC		8MR2301-3A

Screw fixing






Version	Voltage		Article No.
With motion detector	100 ... 240 V, 50/60 Hz AC	90 ... 110 V DC	8MR2303-0B
	24 ... 48 V DC		8MR2301-0B
With On/Off switch	100 ... 240 V, 50/60 Hz AC	90 ... 110 V DC	8MR2303-1B
	24 ... 48 V DC		8MR2301-1B
Without switching function	100 ... 240 V, 50/60 Hz AC	90 ... 110 V DC	8MR2303-3B
	24 ... 48 V DC		8MR2301-3B

Clip fixing



Version	Voltage		Article No.
With motion detector	100 ... 240 V, 50/60 Hz AC	90 ... 110 V DC	8MR2303-0C
	24 ... 48 V DC		8MR2301-0C
With On/Off switch	100 ... 240 V, 50/60 Hz AC	90 ... 110 V DC	8MR2303-1C
	24 ... 48 V DC		8MR2301-1C
Without switching function	100 ... 240 V, 50/60 Hz AC	90 ... 110 V DC	8MR2303-3C
	24 ... 48 V DC		8MR2301-3C

Slimline lights

	Without magnet	With magnet (approx. 30 N)
		
Slimline lights with motion detector and socket, acc. to VDE 230 V AC, 50/60 Hz	8MF5910-1A	8MF5910-1C
Slimline lights with On/Off switch and socket, acc. to VDE 230 V AC, 50/60 Hz	8MF5900-1A	8MF5900-1C

Quick selection guide

Solutions to provide protection against heat

Cooling devices



Heat exchangers



Filter fans/outlet fans

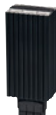


Thermostats



Solutions to provide protection against cold

Heater units



Fan heaters



Thermostats



Solutions to provide protection against corrosion and condensation

Heater units/ fan heaters



Filter fans/outlet filters



Thermostats



Hygrostats/ hygrotherms



SIMARIS therm

SIEMENS | Project definition | System planning | Calculation | Project outputs

Devices	Nominal current [A]	Order number	Description	Quantity	Number of connected poles	Rated current [A]	RDF (rated dissipation)	Power loss, pole of
6000 49L3210-34E11-8A...	6000	6000 49L3210-34E11-8A...	SIEMENS 6000...	1	0	0	0,00	-
6000 49L3210-34E11-8A...	6000	6000 49L3210-34E11-8A...	SIEMENS 6000...	1	0	0	0,00	-
80000 39W1208...	80000	80000 39W1208...	AIR CIRCULAT. BHE...	1	3	3	500,00	2
50000 39A2210-28D32-G...	50000	50000 39A2210-28D32-G...	MICR. REC. F510...	1	3	3	250,00	1
61000 39A2796-4B...	61000	61000 39A2796-4B...	MOCKED CARD...	1	3	3	63,00	-

Busbars

Amperage [A]	Cross-section [mm ²]	Length [mm]	Resistance [mΩ]	Number of poles	Calculated power L

Power loss, devices [W] 145,4 with RDF 60 % (Einsätze Geräte können ebenso abweichenden Ausstattungsgrößen haben)

Power loss, wiring [W] 43,6

Power loss, busbars [W] 0,0

Disippatable power loss for cooling [W] selection of devices: 6000A23-50000

Total power loss [W] -453,0

Disippatable power loss [W] at the maximum 238,0 corresponds to 20 K at 75% height of the enclosure




The effective power losses of all circuits can be dissipated by the enclosure.

The SIMARIS therm calculation tool helps you to easily and precisely dimension the heat dissipation of your control panels, simply by selecting the relevant devices in the panel. If necessary, you can immediately select the necessary cooling devices and air conditioners. You can also define the heating power that may be required for anti-condensation heating.

For a free download and further information, visit:
www.siemens.com/simaristherm



Filter fans and outlet filters

Filter fans


Cutout	Voltage	Input rating at 50 Hz	Standard	Color	Degree of protection IP54		Degree of protection IP55	
					Air current, free-blowing at 50 Hz	Article No.	Air current, free-blowing at 50 Hz	Article No.
Filter fans with EC technology								
	125 x 125 mm	115 V AC, 50/60 Hz	4.4 W	VDE	RAL 7035	62 m³/h	8MR6411-5LE25	–
		230 V AC, 50/60 Hz	4.4 W	VDE	RAL 7035	62 m³/h	8MR6423-5LE25	–
	177 x 177 mm	115 V AC, 50/60 Hz	4.4 W	VDE	RAL 7035	120 m³/h	8MR6411-5LE30	–
		230 V AC, 50/60 Hz	4.4 W	VDE	RAL 7035	120 m³/h	8MR6423-5LE30	–
Standard filter fans								
	92 x 92 mm	115 V AC, 50/60 Hz	12 W	VDE	RAL 7035	25 m³/h	8MR6411-5LV10	–
		230 V AC, 50/60 Hz	12 W	VDE, UL	RAL 7032	25 m³/h	8MR6423-2LV10	–
				VDE, UL	RAL 7035	25 m³/h	8MR6423-5LV10	–
		24 V DC	2.2 W	VDE	RAL 7035	25 m³/h	8MR6402-5LV10 new	–
	125 x 125 mm	115 V AC, 50/60 Hz	20 W	VDE, UL	RAL 7035	63 m³/h	8MR6411-5LV25	58 m³/h 8MR6511-5LV25
		230 V AC, 50/60 Hz	20 W	VDE, UL	RAL 7032	63 m³/h	8MR6423-2LV25	–
				VDE, UL	RAL 7035	63 m³/h	8MR6423-5LV25	58 m³/h 8MR6523-5LV25
		24 V DC	4.1 W	VDE	RAL 7035	63 m³/h	8MR6402-5LV25 new	–
	177 x 177 mm	115 V AC, 50/60 Hz	20 W	VDE, UL	RAL 7035	115 m³/h	8MR6411-5LV30	105 m³/h 8MR6511-5LV30
		230 V AC, 50/60 Hz	20 W	VDE, UL	RAL 7035	115 m³/h	8MR6423-5LV30	105 m³/h 8MR6523-5LV30
		24 V DC	4.1 W	VDE	RAL 7035	115 m³/h	8MR6402-5LV30 new	–
	223 x 223 mm	115 V AC, 50/60 Hz	18 W	VDE, UL	RAL 7035	160 m³/h	8MR6411-5LV45	147 m³/h 8MR6511-5LV45
			43 W	VDE, UL	RAL 7035	250 m³/h	8MR6411-5LV41	230 m³/h 8MR6511-5LV41
		24 V DC	6.5 W	VDE	RAL 7035	160 m³/h	8MR6402-5LV45 new	–
		230 V AC, 50/60 Hz	18 W	VDE, UL	RAL 7032	160 m³/h	8MR6423-2LV45	–
				VDE, UL	RAL 7035	160 m³/h	8MR6423-5LV45	147 m³/h 8MR6523-5LV45
			45 W	VDE, UL	RAL 7032	250 m³/h	8MR6423-2LV41	–
			VDE, UL	RAL 7035	250 m³/h	8MR6423-5LV41	230 m³/h 8MR6423-5LV41	
	24 V DC	16 W	VDE, UL	RAL 7032	250 m³/h	8MR6402-2LV41	–	
			VDE	RAL 7035	250 m³/h	8MR6402-5LV41 new	–	
	292 x 292 mm	115 V AC, 50/60 Hz	64 W	VDE, UL	RAL 7035	580 m³/h	8MR6411-5LV60	531 m³/h 8MR6511-5LV60
			115 W	VDE, UL	RAL 7035	930 m³/h	8MR6411-5LV80	850 m³/h 8MR6511-5LV80
		230 V AC, 50/60 Hz	64 W	VDE, UL	RAL 7032	580 m³/h	8MR6423-2LV60	–
				VDE, UL	RAL 7035	580 m³/h	8MR6423-5LV60	531 m³/h 8MR6523-5LV60
		135 W	VDE, UL	RAL 7035	930 m³/h	8MR6423-5LV80	850 m³/h 8MR6523-5LV80	
EMC filter fans								
	177 x 177 mm	115 V AC, 50/60 Hz	20 W	VDE, UL	RAL 7035	115 m³/h	8MR6411-6LV30	105 m³/h 8MR6511-6LV30
		230 V AC, 50/60 Hz	20 W	VDE, UL	RAL 7035	115 m³/h	8MR6423-6LV30	105 m³/h 8MR6523-6LV30
	223 x 223 mm	115 V AC, 50/60 Hz	18 W	VDE, UL	RAL 7035	160 m³/h	8MR6411-6LV45	147 m³/h 8MR6511-6LV45
			43 W	VDE, UL	RAL 7035	250 m³/h	8MR6411-6LV41	230 m³/h 8MR6511-6LV41
		230 V AC, 50/60 Hz	18 W	VDE, UL	RAL 7035	160 m³/h	8MR6423-6LV45	147 m³/h 8MR6523-6LV45
			45 W	VDE, UL	RAL 7035	250 m³/h	8MR6423-6LV41	230 m³/h 8MR6523-6LV41

Filter fans and outlet filters

Outlet filters without fan



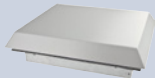
	Cutout	External dimensions W × H	Mounting depth	Cover grille height	Color	Standard	Degree of protection IP54		Degree of protection IP55		
							Article No.	Article No.			
	Standard outlet filters										
	68 × 68 mm	80 × 80 mm	11 mm	4 mm	RAL 7035	VDE	8MR6400-5GV08	new	–	–	
	92 × 92 mm	105 × 105 mm	12 mm	4.5 mm	RAL 7032	VDE, UL	8MR6400-2GV10	–	–		
							RAL 7035	VDE, UL	8MR6400-5GV10	–	
	116 × 116 mm	130 × 130 mm	24 mm	5 mm	RAL 7035	VDE	8MR6400-5GV20	new	–		
	125 × 125 mm	148 × 148 mm	23 mm	5.5 mm	RAL 7032	VDE, UL	8MR6400-2GV25	–	–		
							RAL 7035	VDE, UL	8MR6400-5GV25	8MR6500-5GV25	
	177 × 177 mm	204 × 204 mm	26 mm	6 mm	RAL 7035	VDE, UL	8MR6400-5GV30	–	8MR6500-5GV30		
	223 × 223 mm	250 × 250 mm	32 mm	6 mm	RAL 7032	VDE, UL	8MR6400-2GV45	–	–		
							RAL 7035	VDE, UL	8MR6400-5GV45	8MR6500-5GV45	
292 × 292 mm	323 × 323 mm	33 mm	6.5 mm	RAL 7032	VDE, UL	8MR6400-2GV67	–	–			
						RAL 7035	VDE, UL	8MR6400-5GV67	8MR6500-5GV67		
	EMC outlet filters										
	177 × 177 mm	204 × 204 mm	26 mm	6 mm	RAL 7035	VDE, UL	8MR6400-6GV30	–	8MR6500-6GV30		
	223 × 223 mm	250 × 250 mm	32 mm	6 mm	RAL 7035	VDE, UL	8MR6400-6GV45	–	8MR6500-6GV45		

Filter mats for filter fans and outlet filters



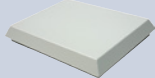
	Degree of protection IP54			Degree of protection IP55			
	Dimensions W × H	Standard	Article No.	Dimensions W × H	Standard	Article No.	
	Standard filter mats						
	65 × 65 mm	VDE	8MR6000-0AM08	new	VDE	–	
	92 × 92 mm	VDE	8MR6000-0AM10	–	VDE	–	
	112 × 112 mm	VDE	8MR6000-0AM20	new	VDE	–	
	125 × 125 mm	VDE	8MR6000-0AM25	–	116 × 116 mm	VDE	8MR6000-OCF25
	177 × 177 mm	VDE	8MR6000-0AM30	–	169 × 169 mm	VDE	8MR6000-OCF30
	223 × 223 mm	VDE	8MR6000-0AM45	–	215 × 215 mm	VDE	8MR6000-OCF45
	292 × 292 mm	VDE	8MR6000-0AM67	–	281 × 281 mm	VDE	8MR6000-OCF67

Roof filter fans and roof outlet filters

Roof filter fans



	Air current, free-blowing at 50 Hz	External dimensions W × H × D	Voltage	Input rating	Standard	Degree of protection IP44	Degree of protection IP54		
	For cutout 223 × 223 mm, color RAL 7035								
	71 m ³ /h	287 × 287 × 104 mm	230 V AC, 50/60 Hz	40 W	VDE, UL	–	8MR6423-5VL44		
			115 V AC, 50/60 Hz	48 W	VDE	–	8MR6411-5VL44		
			24 V DC	8.8 W	VDE, UL	–	8MR6402-5VL44		
	240 m ³ /h	287 × 287 × 174 mm	230 V AC, 50/60 Hz	45 W	VDE, UL	–	8MR6423-5VL41		
			115 V AC, 50/60 Hz	43 W	VDE	–	8MR6411-5VL41		
			24 V DC	16 W	VDE, UL	–	8MR6402-5VL41		
	300 m ³ /h	287 × 287 × 174 mm	230 V AC, 50/60 Hz	45 W	VDE, UL	–	8MR6423-5VL55		
		For cutout 292 × 292 mm, color RAL 7035							
232 m ³ /h		361 × 361 × 114 mm	230 V AC, 50/60 Hz	68 W	VDE, UL	–	8MR6423-5VL64		
			115 V AC, 50/60 Hz	68 W	VDE	–	8MR6411-5VL64		
			24 V DC	14 W	VDE, UL	–	8MR6402-5VL64		
550 m ³ /h		361 × 361 × 211 mm	230 V AC, 50/60 Hz	64 W	VDE, UL	–	8MR6423-5VL60		
			115 V AC, 50/60 Hz	64 W	VDE	–	8MR6411-5VL60		
			24 V DC	55 W	VDE, UL	–	8MR6402-5VL60		
840 m ³ /h		361 × 361 × 203 mm	230 V AC, 50/60 Hz	135 W	VDE, UL	–	8MR6423-5VL80		
			115 V AC, 50/60 Hz	115 W	VDE	–	8MR6411-5VL80		
			24 V DC	105 W	VDE, UL	–	8MR6402-5VL80		
		For cutout 345 × 265 mm, color RAL 7035, metal							
		405 m ³ /h	420 × 340 × 108 mm	115 V AC, 50/60 Hz	40/45 W	VDE, UL	8MR6311-5DL40	–	
	230 V AC, 50/60 Hz			40/45 W	VDE, UL	8MR6323-5DL40	–		
	690 m ³ /h	420 × 340 × 108 mm	115 V AC, 50/60 Hz	100/130 W	VDE, UL	8MR6311-5DL42	–		
230 V AC, 50/60 Hz			100/130 W	VDE, UL	8MR6323-5DL42	–			

Roof outlet filters without fan


	External dimensions W × H × D	Standard	Degree of protection IP44	Degree of protection IP54
	For cutout 223 × 223 mm, color RAL 7035			
	287 × 287 × 85 mm	VDE, UL	–	8MR6400-5VE45
	For cutout 292 × 292 mm, color RAL 7035			
	361 × 361 × 96 mm	VDE, UL	–	8MR6400-5VE67
	For cutout 345 × 265 mm, color RAL 7035, metal			
	420 × 340 × 83 mm	VDE, UL	8MR6000-5DE40	–

Air conditioners/cooling devices

For door or side mounting, degree of protection inside IP54/outside IP34, color RAL 7035


	Cooling capacity	Rated power	Dimensions W × H × D	Air capacity		Design	Mounting		Standard	Article No.	
				Inside	Outside		Undrilled	Part			
	230 V, 50/60 Hz										
	380 W	280 W	285 × 460 × 180 mm	280 m³/h	280 m³/h	■	■	–	VDE	8MR6423-5EG04	
	640 W	400 W	360 × 606 × 212 mm	330 m³/h	570 m³/h	■	■	–	VDE	8MR6423-5EG06	
	820 W	440 W	348 × 783 × 215 mm	330 m³/h	570 m³/h	■	■	–	VDE	8MR6423-5EG08	
	1050 W	570 W	348 × 783 × 215 mm	570 m³/h	860 m³/h	■	■	■	VDE	8MR6423-5SK10	
	1550 W	880 W	400 × 950 × 233 mm	570 m³/h	1050 m³/h	■	■	■	VDE	8MR6423-5SK15	
	2050 W	1080 W	400 × 1265 × 236 mm	860 m³/h	1050 m³/h	■	■	■	VDE	8MR6423-5SK20	
	400 V, 50/60 Hz										
	2900 W	1220 W	500 × 1270 × 336 mm	860 m³/h	1450 m³/h	■	■	–	VDE	8MR6440-5EG30	
	3850 W	1780 W	500 × 1270 × 336 mm	1450 m³/h	1450 m³/h	■	■	–	VDE	8MR6440-5EG40	
	5800 W	2340 W	600 × 2000 × 380 mm	1450 m³/h	2900 m³/h	■	■	–	VDE	8MR6440-5EG60	

For roof mounting, degree of protection inside IP54/outside IP34, color RAL 7035




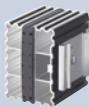
	Cooling capacity	Rated power	Dimensions W × H × D	Air capacity		Design	Mounting		Standard	Article No.	
				Inside	Outside		Undrilled	Part			
	230 V, 50/60 Hz										
	410 W	270 W	259 × 264 × 486 mm	235 m³/h	330 m³/h	■	■	–	VDE	8MR6423-5DE04	
	820 W	510 W	340 × 340 × 600 mm	330 m³/h	570 m³/h	■	■	–	VDE	8MR6423-5DE08	
	1150 W	550 W	401 × 415 × 567 mm	570 m³/h	1010 m³/h	■	■	–	VDE	8MR6423-5DE12	
	1550 W	810 W	401 × 415 × 567 mm	860 m³/h	1820 m³/h	■	■	–	VDE	8MR6423-5DE15	
	2050 W	1190 W	401 × 415 × 567 mm	1050 m³/h	1820 m³/h	■	■	–	VDE	8MR6423-5DE20	
	400 V, 50/60 Hz										
	2900 W	1210 W	492 × 496 × 797 mm	860 m³/h	3410 m³/h	■	■	–	VDE	8MR6440-5DE30	
	3850 W	1630 W	492 × 496 × 797 mm	1450 m³/h	3410 m³/h	■	■	–	VDE	8MR6440-5DE40	

Heat exchangers

Air/air heat exchangers, degree of protection IP54, color RAL 7035



	Thermal power	Rated power	Dimensions W × H × D	Air capacity		Design	Mounting		Standard	Article No.	
				Inside	Outside		Undrilled	Part			
	230 V, 50/60 Hz										
	36 W/K	140 W	316 × 771 × 103 mm	570 m³/h	570 m³/h	■	■	–	VDE	8MR6423-5ML36	
	80 W/K	240 W	317 × 1260 × 148 mm	1050 m³/h	1050 m³/h	■	■	–	VDE	8MR6423-5ML80	

Heater units




	Rated value	Rated power	Shutdown temperature	Standard	Article No.
	Heater units with PTC thermistor, UL-approved				
	120 ... 240 V AC/DC	15 W	–	VDE, UL	8MR2130-1A
		30 W	–	VDE, UL	8MR2130-3A
		45 W	–	VDE, UL	8MR2130-4A
		60 W	–	VDE, UL	8MR2130-6A
		75 W	–	VDE, UL	8MR2130-7A
		100 W	–	VDE, UL	8MR2130-0A
150 W		–	VDE, UL	8MR2130-5A	
	Semiconductor heater units without thermostat, compact design, UL-approved				
	120 ... 240 V AC/DC	50 W	–	VDE	8MR2131-4A
		100 W	–	VDE	8MR2131-0A
150 W		–	VDE	8MR2131-5A	
	Semiconductor heater units with thermostat, compact design				
	120 ... 240 V AC/DC	50 W	15 °C	VDE	8MR2132-1A
			25 °C	VDE	8MR2132-1AB
		100 W	15 °C	VDE	8MR2132-0A
			25 °C	VDE	8MR2132-0AB
		150 W	15 °C	VDE	8MR2132-5A
25 °C			VDE	8MR2132-5AB	
	Semiconductor heater units				
	12 ... 30 V AC/DC	15 W	–	VDE	8MR2130-1BA
		30 W	–	VDE	8MR2130-3BA
		45 W	–	VDE	8MR2130-4BA
		60 W	–	VDE	8MR2130-4BA
–			VDE	8MR2130-6BA	

Fan heaters

Fan heaters





	Version	Voltage	Continuous heat output	Parameter	Standard	Article No.	
	Standard version						
	Without fan	230 V AC	100 W	–	VDE, UL	8MR2140-0A	
			150 W	–	VDE, UL	8MR2140-1A	
			200 W	–	VDE, UL	8MR2140-2A	
			300 W	–	VDE, UL	8MR2140-3A	
	With fan	230 V AC	400 W	–	VDE, UL	8MR2140-4A	
			100 W	–	VDE, UL	8MR2140-0B	
			150 W	–	VDE, UL	8MR2140-1B	
			200 W	–	VDE, UL	8MR2140-2B	
			300 W	–	VDE, UL	8MR2140-3B	
400 W			–	VDE, UL	8MR2140-4B		
Compact fan heater							
Without fan			230 V AC	250 W	–	VDE, UL	8MR2122-4A
	400 W	–		VDE, UL	8MR2122-8A		
	120 V AC	250 W	–	VDE, UL	8MR2122-4B		
		400 W	–	VDE, UL	8MR2122-8B		
With fan	24 V DC	250 W	–	VDE, UL	8MR2122-4AB		
	48 V DC	250 W	–	VDE, UL	8MR2122-4AC		
		400 W	–	VDE, UL	8MR2122-8AA		
	With integrated thermostat						
	For floor mounting	230 V AC	950 W	0 ... +60 °C	VDE, UL	8MR2150-0A	
	For wall mounting	230 V AC	950 W	0 ... +60 °C	VDE, UL	8MR2150-0C	
	With integrated hygrostat						
	For wall mounting	230 V AC	950 W	65% R.H.	VDE, UL	8MR2150-0CA	

Semiconductor fan heaters

	Mounting	Voltage	Continuous heat output	Version	Standard	Article No.		
	Fan heaters							
	Clip fixing	230 V AC	150 W	–	VDE, UL	8MR2150-2C		
			250 W	–	VDE, UL	8MR2150-5A		
			400 W	–	VDE, UL	8MR2150-4A		
			120 V AC	250 W	–	VDE, UL	8MR2150-5AA	
			400 W	–	VDE, UL	8MR2150-4AA		
			Screw fixing	230 V AC	150 W	–	VDE, UL	8MR2150-2D
					250 W	–	VDE, UL	8MR2150-5B
					400 W	–	VDE, UL	8MR2150-4B
			120 V AC	250 W	–	VDE, UL	8MR2150-5AB	
400 W				–	VDE, UL	8MR2150-4AB		
	PTC fan heaters for wall mounting							
	Screw fixing	230 V AC	1200 W	With thermostat 0 ... +60 °C	VDE, UL	8MR2150-3A		
			1200 W	Without thermostat	VDE, UL	8MR2150-3B		
	Clip fixing	120 V AC	1200 W	With thermostat +32 ... +140 °F	VDE, UL	8MR2151-3A		
			1200 W	Without thermostat	VDE, UL	8MR2151-3B		
		PTC fan heaters for floor mounting						
Screw fixing		230 V AC	1200 W	With thermostat 0 ... +60 °C	VDE, UL	8MR2150-2A		
			1200 W	Without thermostat	VDE, UL	8MR2150-2B		
Clip fixing		120 V AC	1200 W	With thermostat +32 ... +140 °F	VDE, UL	8MR2151-2A		
	1200 W		Without thermostat	VDE, UL	8MR2151-2B			



Thermostats

Adjustable thermostats

	Version	Max. switching power	Temperature range	Standard	Article No.
	Mini thermostat new				
	NC with red adjusting knob	250 V AC, 10 (2) A	0 ... +60 °C	VDE	8MR2170-1KA
			-10 ... +50 °C	VDE	8MR2170-1KB
			+20 ... +80 °C	VDE	8MR2170-1KC
			+32 ... +140 °F	VDE	8MR2170-1KD
			+14 ... +122 °F	VDE	8MR2170-1KE
	NO with blue adjusting knob	250 V AC, 10 (2) A	0 ... +60 °C	VDE	8MR2170-2KA
			-10 ... +50 °C	VDE	8MR2170-2KB
			+20 ... +80 °C	VDE	8MR2170-2KC
			+32 ... +140 °F	VDE	8MR2170-2KD
+14 ... +122 °F			VDE	8MR2170-2KE	
	Mechanical thermostat				
	CO	250 V AC, 10 (4) A	+5 ... +60 °C	VDE, UL	8MR2170-1A
			-20 ... +30 °C	VDE, UL	8MR2170-1B
	Electronic thermostat				
	CO	230 V AC, 8 (1.6) A	-20 ... +60 °C	VDE	8MR2170-1GA
		120 V AC, 8 (1.6) A	-4 ... +140 °F	VDE	8MR2170-1GB
		24 V DC, 16 A	0 ... +60 °C	VDE	8MR2170-2A
	CO, integrated	230 V AC, 8 (1.6) A	-20 ... +60 °C	VDE	8MR2170-1GC
	Zwillings-Thermostat				
	NC and NO	250 V AC, 10 (2) A	0 ... +60 °C	VDE, UL	8MR2170-1E
NO and NO	250 V AC, 10 (2) A	0 ... +60 °C	VDE, UL	8MR2170-1EA	



Thermostats

Tamper-proof thermostats


	Version	Max. switching power	Shutdown temperature	Article No.
	Tamper-proof thermostat, acc. to VDE, UL			
	NC	250 V AC, 5 (1.6) A	15 °C	8MR2171-1BA
			25 °C	8MR2171-2BA
	NO	250 V AC, 5 (1.6) A	35 °C	8MR2171-3BB
			50 °C	8MR2171-1BB
60 °C			8MR2171-2BB	
	Twin thermostat, acc. to VDE, UL			
	NC and NO	250 V AC, 5 (1.6) A	15 °C 50 °C (NC NO)	8MR2172-1A
			25 °C 60 °C (NC NO)	8MR2172-2A
	NO and NO	250 V AC, 5 (1.6) A	50 °C 60 °C (NO NO)	8MR2172-1AB

Hygrostats and hygrotherms

Hygrostats

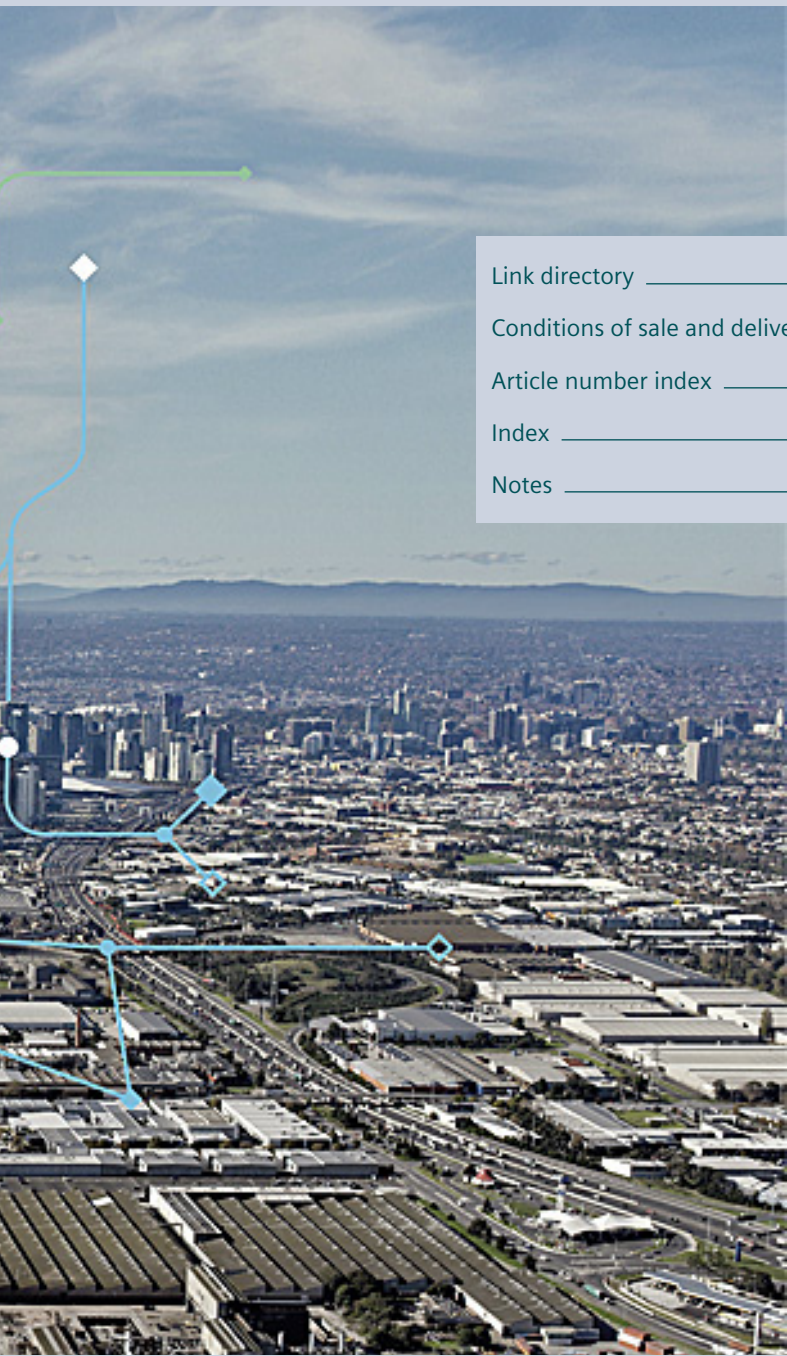
	Version	Relative air humidity	Voltage	Max. switching power	Article No.
	Mechanical hygrostat, acc. to VDE, UL				
	CO	35 ... 95%	230 V AC	250 V AC, 5 (0.2) A/20 W DC	8MR2170-1C
	Electronic hygrostat, acc. to VDE				
	CO	40 ... 90%	230 V AC	240 V AC, 8 (1.6) A	8MR2170-1AF
			120 V AC	240 V AC, 8 (1.6) A	8MR2170-2AF
		65%	230 V AC	240 V AC	8MR2170-1BF
			120 V AC	120 V AC	8MR2170-2BF

Hygrotherms

	Version	Relative air humidity	Temperature range	Voltage	Max. switching power	Article No.
	Electronic hygrotherm, acc. to VDE, UL					
	NC and NO	50 ... 90%	+32 ... +140 °F	100 ... 240 V AC	NC: 120 V AC, 6 (1) A NO: 120 V AC, 8 (1.6) A	8MR2170-4F
			0 ... +60 °C	100 ... 240 V AC	NC: 100 ... 240 V AC, 6 (1) A NO: 100 ... 240 V AC, 8 (1.6) A	8MR2170-4E



Appendix



Link directory	A/2
Conditions of sale and delivery	A/8
Article number index	A/10
Index	A/17
Notes	A/21

Link directory

Catalog LV 10

General information

Information on low-voltage power distribution and electrical installation technology	www.siemens.com/lowvoltage
Tender specifications	www.siemens.com/tenderspecifications
Conversion tool	www.siemens.com/conversion-tool
Image database	www.siemens.com/lowvoltage/picturedb
CAX download manager	www.siemens.com/cax
Newsletter system	www.siemens.com/lowvoltage/newsletter
Siemens YouTube channel	www.youtube.com/Siemens
Catalog LV 10	www.siemens.com/lv10
Catalog LV 13	www.siemens.com/lv13
Catalog LV 18	www.siemens.com/lv18
Brochures/catalogs	www.siemens.com/lowvoltage/catalogs
Operating instructions/manuals	www.siemens.com/lowvoltage/manuals
SiePortal (knowledge base)	www.siemens.com/lowvoltage/product-support
SiePortal (product catalog)	www.siemens.com/lowvoltage/product-catalog
My Documentation Manager (MDM)	www.siemens.com/lowvoltage/mdm
Configurators	www.siemens.com/lowvoltage/configurators
Direct forwarding to SiePortal	www.siemens.com/product_catalog_SIEP?Article No.
Training	www.siemens.com/sitrain-lowvoltage
Local contacts	www.siemens.com/lowvoltage/contact www.siemens.com/lowvoltage/components/contact www.siemens.com/lowvoltage/systems/contact www.siemens.com/lowvoltage/software/contact
Technical Support	www.siemens.com/support-request
Information on services	www.siemens.com/service-offers
Control panels for the North American market	www.siemens.com/northamerican-standards
Integrated Control Panels	www.siemens.com/controlpanel
Energy savings and amortization	www.automation.siemens.com/sinasave
SIMATIC Energy Suite	www.siemens.com/energysuite
SITOP power supplies	www.siemens.com/sitop
Power distribution with Totally Integrated Power	www.siemens.com/tip
TIA Selection Tool	www.siemens.com/tst
Electrical Product Finder	www.siemens.com/electrical-product-finder
Sustainability	www.siemens.com/sustainability

Information + ordering

Technical overviews	
Air circuit breakers	www.siemens.com/lowvoltage/produkt-support (109781188)
Molded case circuit breakers	www.siemens.com/lowvoltage/product-support (109767421)
Miniature circuit breakers	www.siemens.com/lowvoltage/product-support (109769082)
Residual current protective devices/arc fault detection devices	www.siemens.com/lowvoltage/product-support (109769082)
Switching devices	www.siemens.com/lowvoltage/product-support (109769083)
Overvoltage protection devices	www.siemens.com/lowvoltage/product-support (109769084)
Fuse systems	www.siemens.com/lowvoltage/product-support (109769085)
Switch disconnectors	www.siemens.com/lowvoltage/product-support (109764946)
Transfer switching equipment and load transfer switches	www.siemens.com/lowvoltage/product-support (109770919)
Measuring devices, power monitoring and digitalization solutions	www.siemens.com/lowvoltage/product-support (109764480)
Monitoring devices	www.siemens.com/lowvoltage/product-support (109769086)
Transformers, power supply units and socket outlets	www.siemens.com/lowvoltage/product-support (109778781)
Busbar systems	www.siemens.com/lowvoltage/product-support (109769087)

Technical overviews	
Terminal blocks	www.siemens.com/lowvoltage/product-support (109769088)
Switchboards, distribution boards and small distribution boards	www.siemens.com/lowvoltage/product-support (109769089)
Busbar trunking systems	www.siemens.com/lowvoltage/product-support (109769090)
System cubicles, system lighting and system air-conditioning	www.siemens.com/lowvoltage/product-support (109769091)
All the important things at a glance	
Air circuit breakers	www.siemens.com/3WA
Molded case circuit breakers	www.siemens.com/3VA
Miniature circuit breakers	www.siemens.com/mcb www.siemens.com/circuit-protection
Residual current protective devices/arc fault detection devices	www.siemens.com/rccb www.siemens.com/circuit-protection
Switching devices	www.siemens.com/switching-devices
Overvoltage protection devices	www.siemens.com/overvoltage-protection
Fuse systems	www.siemens.com/fuses
Switch disconnectors	www.siemens.com/switching-devices
Transfer switching equipment and load transfer switches	www.siemens.com/switching-devices sie.ag/2XBonli
Measuring devices, power monitoring and digitalization solutions	www.siemens.com/sentron-measuring-devices www.siemens.com/sentron-digital
Monitoring devices	www.siemens.com/lowvoltage
Transformers, power supply units and socket outlets	www.siemens.com/lowvoltage
Busbar systems	www.siemens.com/lowvoltage
Terminal blocks	www.siemens.com/distribution-components
Switchboards, distribution boards and small distribution boards	www.siemens.com/sivacon-S8 www.siemens.com/distributionsystems
Busbar trunking systems	www.siemens.com/sivacon-8PS
System cubicles, system lighting and system air-conditioning	www.siemens.com/sivacon-8mf
Your product in detail	
Brochure – 3WA air circuit breakers	www.siemens.com/lowvoltage/product-support (109800077)
Brochure – Energy and data successfully put on track	www.siemens.com/lowvoltage/product-support (109747761)
Brochure – SENTRON Powermanager – update and benefit	www.siemens.com/lowvoltage/product-support (109805178)
Brochure – SIVACON 8MF1 system cubicles – As versatile as your requirements	www.siemens.com/lowvoltage/product-support (109744677)
Brochure – SIVACON S8 ^{plus} – The plus for your business: Intelligent. Flexible. Safe.	www.siemens.com/lowvoltage/product-support (109747937)
Catalog – LV 70 · 2023 – SIVACON 8PS busbar trunking systems – BD01, BD2 up to 1250 A	www.siemens.com/lowvoltage/product-support (109744546)
Quick Selection Guide – 3WA air circuit breakers	www.siemens.com/lowvoltage/product-support (109781967)
Quick Selection Guide – 3WL air circuit breakers	www.siemens.com/lowvoltage/product-support (109751638)
Quick Selection Guide – 3VA molded case circuit breaker	www.siemens.com/lowvoltage/product-support (109757591)
Quick Selection Guide – SENTRON portfolio for power monitoring	www.siemens.com/lowvoltage/product-support (109744725)
Technology Primer – Miniature circuit breakers	www.siemens.com/lowvoltage/product-support (109482304)
Technology Primer – Residual current protective devices	www.siemens.com/lowvoltage/product-support (109482301)
Technology Primer – Overvoltage protection devices	www.siemens.com/lowvoltage/product-support (109756965)
Technology Primer – Fuse systems	www.siemens.com/lowvoltage/product-support (109482303)
Siemens YouTube channel	
3WA air circuit breaker – Teaserfilm	sie.ag/2Myvit
3WA air circuit breaker – Highlightfilm	sie.ag/3dy65A
3VA molded case circuit breakers (general)	sie.ag/2gSX4K
Miniature circuit breakers (general)	sie.ag/59PC9j
Residual current protective devices (general)	sie.ag/58TyMb
Siemens fuse systems	sie.ag/2J9ihb
Power monitoring (general)	sie.ag/7N6g4g
Siemens ALPHA FIX terminal blocks – 8WH2 terminal with spring-loaded-connection	sie.ag/6FTjPN

Link directory

Catalog LV 10

Siemens YouTube channel	
SIVACON power distribution (general)	sie.ag/6wacV9
Siemens SIVACON S4 power distribution boards up to 4000 A	sie.ag/6v6kNm
Everything you need for your order	
Air circuit breakers	sie.ag/2lXiZjB
Molded case circuit breakers	sie.ag/2mmLcAk
Miniature circuit breakers	sie.ag/41HWeiL
Residual current protective devices	sie.ag/2m55Y7j
Arc fault detection devices	sie.ag/3KPJpNn
Switching devices	sie.ag/2m4eG5M
Overvoltage protection devices	sie.ag/3ZMwRuw
Fuse systems	sie.ag/2kW3pnU
Switch disconnectors	sie.ag/36HDiZp
Transfer switching equipment and load transfer switches	sie.ag/2mmMw6g
Measuring devices and power monitoring	sie.ag/2kTH9Lz
Digitalization solutions	sie.ag/2olliNi
Configuring and visualizing for SIMATIC	sie.ag/2kpbwcs
Software and apps	sie.ag/2kTJjuF
Monitoring devices	sie.ag/2m3no4A
Transformers, power supply units and socket outlets	sie.ag/2mmSHHu
Busbar systems	sie.ag/2lXoUFl
Terminal blocks	sie.ag/2kW8Zxo
SIVACON S4 (NF)	sie.ag/2JUQwE4
Distribution boards	sie.ag/2kURLd8
Switchboards	sie.ag/3ler6zp
SIVACON S8 Power distribution boards and motor control centers	sie.ag/3EbN0kC
Small distribution boards	sie.ag/3l4DUYm
Planning software	sie.ag/2m3oFbS
SIVACON 8PS	sie.ag/2lXpCT1 www.siemens.com/sivacon8PS-contact
System cubicles	sie.ag/339cQB9
SIVACON S8	www.siemens.com/sivacon-partnerfinder www.siemens.com/sivaconS8-contact
Order support	
3WA air circuit breakers – Made for makers. Simply reliable.	www.siemens.com/lowvoltage/catalogs (109800074)
3VA molded case circuit breakers – One system. Global use.	www.siemens.com/lowvoltage/catalogs (109765994)
3KD switch disconnectors – End-to-end safety for user and systems	www.siemens.com/lowvoltage/catalogs (109750228)
3LD2 main control and EMERGENCY-STOP-switching equipment – End-to-end safety for user and systems	www.siemens.com/lowvoltage/catalogs (109755626)
3NP1 fuse switch disconnectors – End-to-end safety for user and systems	www.siemens.com/lowvoltage/catalogs (109755624)
3KF switch disconnectors with fuses – End-to-end safety for user and systems	www.siemens.com/lowvoltage/catalogs (109750229)
3NJ63 switch disconnectors with fuses – End-to-end safety for user and systems	www.siemens.com/lowvoltage/catalogs (109755619)
3KC automatic transfer switching equipment (ATSE) – End-to-end safety for user and systems	www.siemens.com/lowvoltage/catalogs (109755620)
Configurators	
3KC remotely operated transfer switching equipment (RTSE) – End-to-end safety for user and systems	www.siemens.com/lowvoltage/catalogs (109755627)
3KC manual transfer switching equipment (MTSE) – End-to-end safety for user and systems	www.siemens.com/lowvoltage/catalogs (109750227)
SIVACON 8PS – BD01 and BD2	www.siemens.com/LV70

Configurators	
3WA air circuit breakers	www.siemens.com/lowvoltage/3wa-configurator
3WL air circuit breakers	www.siemens.com/lowvoltage/3wl-configurator
3WL10 air circuit breakers	www.siemens.com/lowvoltage/3wl10-configurator
3VA molded case circuit breakers	www.siemens.com/lowvoltage/3va-configurator
3VA27 molded case circuit breakers	www.siemens.com/lowvoltage/3va27-configurator
SITOR semiconductor fuses	www.siemens.com/lowvoltage/sitor-configurator
3NJ63 switch disconnectors	www.siemens.com/lowvoltage/3nj63-configurator
3LD switch disconnectors	www.siemens.com/lowvoltage/3ld-configurator
3KD switch disconnectors	www.siemens.com/lowvoltage/3kd-configurator
3KF switch disconnectors with fuses	www.siemens.com/lowvoltage/3kf-configurator
3NP1 fuse switch disconnectors	www.siemens.com/lowvoltage/3np1-configurator
SIVACON 8MF1 system cubicle	www.siemens.com/lowvoltage/8mf1-configurator
7KM PAC and 7KT PAC measuring device	www.siemens.com/lowvoltage/pac-configurator

Commissioning + operation

Tools/software	
SIMARIS configuration	www.siemens.com/simarisconfig
SENTRON Powerconfig	www.siemens.com/powerconfig
SIMARIS planning tools	www.siemens.com/simaris
SIMARIS therm	www.siemens.com/simaristherm
Manuals	
Application Manual – SIVACON S4 Power distribution boards up to 6300 A	www.siemens.com/lowvoltage/manuals (25909512)
Communication Manual – 3WL air circuit breakers via COM35 – PROFINET IO, Modbus TCP	www.siemens.com/lowvoltage/manuals (109757987)
Communication Manual – 3WL10 air circuit breakers & 3VA27 molded case circuit breakers	www.siemens.com/lowvoltage/manuals (109760220)
Communication Manual – 3VA molded case circuit breakers with IEC and UL certification	www.siemens.com/lowvoltage/manuals (98746267)
Communication Manual – SENTRON PAC5100/5200 7KM5212/5412	www.siemens.com/lowvoltage/manuals (109477870)
Configuration Manual – 3VA selectivity	www.siemens.com/lowvoltage/manuals (109743975)
Configuration manual – 3WL1 air circuit breakers	www.siemens.com/lowvoltage/manuals (35681108)
Configuration Manual – Miniature circuit breakers	www.siemens.com/lowvoltage/manuals (45302792)
Configuration Manual – Residual protective devices/ arc fault detection devices	www.siemens.com/lowvoltage/manuals (45303255)
Configuration Manual – Switching devices	www.siemens.com/lowvoltage/manuals (45315361)
Configuration Manual – Overvoltage protection devices	www.siemens.com/lowvoltage/manuals (45315289)
Configuration Manual – Fuse systems	www.siemens.com/lowvoltage/manuals (45314810)
Configuration Manual – Switch disconnectors	www.siemens.com/lowvoltage/manuals (109769744)
Configuration Manual – Transfer switching equipment and load transfer switches	www.siemens.com/lowvoltage/manuals (109769745)
Configuration Manual – Measuring devices and power monitoring	www.siemens.com/lowvoltage/manuals (45315973)
Configuration Manual – Monitoring devices	www.siemens.com/lowvoltage/manuals (45316099)
Configuration Manual – Transformers, power supply units and socket outlets	www.siemens.com/lowvoltage/manuals (45315886)
Configuration Manual – Low-voltage protection devices selectivity tables	www.siemens.com/lowvoltage/manuals (109748621)
Configuration Manual – 8US busbar systems	www.siemens.com/lowvoltage/manuals (109769746)
Equipment Manual – 3WA1 air circuit breakers	www.siemens.com/lowvoltage/manuals (109763061)

Link directory

Catalog LV 10

Manuals	
Equipment Manual – 3VA molded case circuit breakers with IEC certificate	www.siemens.com/lowvoltage/manuals (90318775)
Equipment Manual – 3VA27 molded case circuit breakers & 3WL10 air circuit breakers	www.siemens.com/lowvoltage/manuals (109753821)
Equipment Manual – 3KD switch disconnecter	www.siemens.com/lowvoltage/manuals (109758120)
Equipment Manual – 3KC3 and 3KC6 transfer switching equipment	www.siemens.com/lowvoltage/manuals (109754954)
Equipment Manual – 3KC0 manual transfer switching equipment	www.siemens.com/lowvoltage/manuals (109763232)
Equipment Manual – 3KC4 and 3KC8 transfer switching equipment	www.siemens.com/lowvoltage/manuals (109738725)
Equipment Manual – 3KC ATC3100 transfer control device	www.siemens.com/lowvoltage/manuals (100341671)
Equipment Manual – 3KC ATC6300 transfer control device	www.siemens.com/lowvoltage/manuals (109755149)
Equipment Manual – 3KC ATC6500 transfer control device	www.siemens.com/lowvoltage/manuals (109758018)
Equipment Manual – 7KT PAC1600 energy meter	www.siemens.com/lowvoltage/manuals (109759827)
Equipment Manual – 7KT PAC1600 multimeter	www.siemens.com/lowvoltage/manuals (109760293)
Equipment Manual – 7KM PAC2200 power monitoring device	www.siemens.com/lowvoltage/manuals (109746835)
Equipment Manual – 7KM PAC3200T power monitoring device	www.siemens.com/lowvoltage/manuals (109746833)
Equipment Manual – SENTRON PAC5100/5200 7KM5212/5412	www.siemens.com/lowvoltage/manuals (109477872)
Equipment Manual – 7KM PAC3120 and 7KM PAC3220	www.siemens.com/lowvoltage/manuals (109767307)
Equipment Manual – 7KN Powercenter 3000	www.siemens.com/lowvoltage/manuals (109763838)
Equipment Manual – 7KM PAC2200CLP power monitoring device	www.siemens.com/lowvoltage/manuals (109783220)
Installation Manual – Circuit protection devices with communication and measuring function	www.siemens.com/lowvoltage/manuals (109791805)
Planning Manual – Planning with SIVACON 8PS	www.siemens.com/lowvoltage/manuals (109478425)
Planning Manual – SIVACON S8 – Technical planning information	www.siemens.com/lowvoltage/manuals (107113936)
Quick Installation Guide – 7KN Powercenter 3000	www.siemens.com/lowvoltage/manuals (109766001)
SEM3™ – Embedded Micro Metering Module™	www.siemens.com/lowvoltage/manuals (109748928)
System Manual – 3WA air circuit breaker communication	www.siemens.com/lowvoltage/manuals (109792368)
System Manual – 3WL/3VL circuit breakers with communication capability – Modbus	www.siemens.com/lowvoltage/manuals (39850157)
System Manual – 3WL/3VL circuit breakers with communication capability – PROFIBUS	www.siemens.com/lowvoltage/manuals (12560390)
System Manual – SENTRON 3NJ62 in-line plug-in switch disconnectors with fuses	www.siemens.com/lowvoltage/manuals (31753460)
System Manual – SENTRON 3NP1 fuse switch disconnecter	www.siemens.com/lowvoltage/manuals (33515690)
System Manual – 7KT multichannel current measuring system	www.siemens.com/lowvoltage/manuals (109483442)
System Manual – SENTRON PAC4200 power monitoring device	www.siemens.com/lowvoltage/manuals (34261595)
System Manual – SENTRON PAC4220 power monitoring device	www.siemens.com/lowvoltage/manuals (109823026)
System Manual – Circuit protection devices with communication and measuring function	www.siemens.com/lowvoltage/manuals (109791806)
Face-to-face or online training	
Video tutorial on the 3WL air circuit breaker	www.lowvoltage.siemens.com/wcms/3wl-tutorial
3WA air circuit breakers	www.siemens.com/sitrain-lowvoltage (WT-LV3WA)
3WL10 air circuit breaker, size 0	www.siemens.com/sitrain-lowvoltage (WT-LVA3WL0)
3WL air circuit breakers, sizes 1-3	www.siemens.com/sitrain-lowvoltage (WT-LVA3WL)
Protection systems in low-voltage power distribution	www.siemens.com/sitrain-lowvoltage (WT-LVAPS)
Maintenance and operation of 3WA circuit breakers	www.siemens.com/sitrain-lowvoltage (LV-3WAMAIN)
Maintenance and operation of 3WL circuit breakers	www.siemens.com/sitrain-lowvoltage (LV-3WLMAIN)
Certification: Maintenance and operation of 3WL and 3WA circuit breakers	www.siemens.com/sitrain-lowvoltage (LV-CBCERT)
3WL and 3WA air circuit breakers protection technology and communication	www.siemens.com/sitrain-lowvoltage (LV-COPR)
3VA molded case circuit breaker	www.siemens.com/sitrain-lowvoltage (WT-LVA3VA)

Face-to-face or online training

SENTRON circuit protection devices with measuring and communication function	www.siemens.com/sitrain-lowvoltage (WT-LVBCOM)
Basic principles of electrical engineering	www.siemens.com/sitrain-lowvoltage (WT-LVBGET)
Protection concept	www.siemens.com/sitrain-lowvoltage (WT-LVBPC)
5SM6/5SV6 arc fault detection devices	www.siemens.com/sitrain-lowvoltage (WT-LVBAFDD)
Digitalization in power distribution boards	www.siemens.com/sitrain-lowvoltage (WT-LVDIGI)
Power Monitoring with SENTRON	www.siemens.com/sitrain-lowvoltage (WT-LVAEM)
Energy Management with SENTRON Powermanager – User training	www.siemens.com/sitrain-lowvoltage (LV-PM)
SENTRON Powermanager graphic module – User training	www.siemens.com/sitrain-lowvoltage (LV-PMG)
SIMARIS configuration	www.siemens.com/sitrain-lowvoltage (WT-LVASIMC)
SIVACON 8PS	www.power-academy.siemens.com

Further links

SIRIUS

Industrial Controls – SIRIUS	www.siemens.com/sirius
SiePortal – SIRIUS	www.siemens.com/sirius-sieportal
Product Support	www.siemens.com/online-support
Catalog IC 10	www.siemens.com/ic10
Brochures/catalogs	www.siemens.com/sirius/catalogs
SIRIUS Control for controlling and protecting	www.siemens.com/sirius-control
SIRIUS Command for commanding, signaling and detecting applications	www.siemens.com/sirius-command
SIRIUS Hybrid for starting motors	www.siemens.com/sirius-hybrid
SIRIUS Monitor for monitoring and responding	www.siemens.com/sirius-monitor
Control and signaling devices SIRIUS ACT – Performance in Action	www.siemens.com/sirius-act
SIRIUS modular system	www.siemens.com/sirius-control
IO-Link – the new communication standard	www.siemens.com/io-link
Systematic industrial safety technology: Safety Integrated	www.siemens.com/safety-integrated
SIMOCODE pro motor management	www.siemens.com/simocode
Explosion protection (ATEX)	www.siemens.com/sirius-atex
Configurators – SIRIUS	www.siemens.com/sirius/configurators
SIRIUS Media	www.siemens.com/sirius-media
SIRIUS Explained	www.siemens.com/sirius-explained

Conditions of sale and delivery

1. General Provisions

By using this catalog you can purchase hard- and software products as well as services (together hereinafter referred to as "products") described therein from Siemens Aktiengesellschaft subject to the following Terms and Conditions of Sale and Delivery (hereinafter referred to as "T&C"). Note, for products purchased from any Siemens entity having a registered office outside of Germany, the respective terms and conditions of sale and delivery of the respective Siemens entity apply exclusively. The following T&C apply exclusively for orders placed with Siemens Aktiengesellschaft, Germany.

1.1 For customers with a seat or registered office in European Union

For customers with a seat or registered office in European Union, the following terms and conditions apply subordinate to T&C:

- for products, which include specific terms and conditions in the text of the product description, these specific terms and conditions shall apply and subordinate thereto,
- for stand-alone software products and software products forming a part of a product or project, the "General Conditions for Software Products for Infrastructure & Industry Business (German law)"¹⁾ and/or
- for consulting services the "Allgemeine Geschäftsbedingungen für Beratungsleistungen für Infrastructure & Industry Geschäft (Deutsches Recht)"¹⁾ (available only in German) and/or
- for other services, the "Supplementary Terms and Conditions for Services for Infrastructure & Industry Business (German Law) ("BL")"¹⁾ and/or
- for other products the "General Conditions for the Supply of Products and Services of the Electrical and Electronics Industry"¹⁾.

In case such products should contain Open Source Software, the conditions of which shall prevail over the "General Conditions for the Supply of Products and Services of the Electrical and Electronics Industry"¹⁾, the Product will be given a note as to which special conditions apply to this open source software. This shall apply mutatis mutandis for notices referring to other third-party software components.

1.2 For customers with a seat or registered office outside European Union

For customers with a seat or registered office outside European Union, the following terms and conditions apply subordinate to T&C:

- for products, which include specific terms and conditions in the description text, these specific terms and conditions shall apply and subordinate thereto,
- for consulting services the "Standard Terms and Conditions for Consulting Services for Infrastructure & Industry Business (Swiss Law)"¹⁾ and/or
- for other services the "International Terms & Conditions for Services"¹⁾ supplemented by "Software Licensing Conditions"¹⁾ and/or
- for other products the "International Terms & Conditions for Products"¹⁾ supplemented by "Software Licensing Conditions"¹⁾

1.3 For customers with master or framework agreement

To the extent products offered are covered by an existing master or framework agreement, the terms and conditions of that agreement shall apply instead of T&C.

2. Additional Terms and Conditions

The dimensions are in mm. In Germany, according to the German law on units in measuring technology, data in inches apply only to devices for export.

Illustrations are not binding.

Insofar as there are no remarks on the individual pages of this catalog – especially with regard to data, dimensions and weights given – these are subject to change without prior notice.

¹⁾ The text of the Terms and Conditions of Siemens AG can be downloaded at https://mall.industry.siemens.com/legal/ww/en/terms_of_trade_en.pdf

3. Export Control and Sanctions Compliance

3.1 General

Customer shall comply with all applicable sanctions, embargoes and (re-)export control laws and regulations, and, in any event, with those of the European Union, the United States of America and any locally applicable jurisdiction (collectively "Export Regulations").

3.2 Checks for Products

Prior to any transaction by customer concerning products (including hardware, documentation and technology) delivered by Siemens, or products (including maintenance and technical support) performed by Siemens with a third party, customer shall check and certify by appropriate measures that

- (i) the customer's use, transfer, or distribution of such products, the brokering of contracts or the provision of other economic resources in connection with products will not be in violation of any Export Regulations, also taking into account any prohibitions to circumvent these (e.g., by undue diversion)
- (ii) the products are not intended or provided for prohibited or unauthorized non-civilian purposes (e.g. armaments, nuclear technology, weapons, or any other usage in the field of defense and military);
- (iii) customer has screened all direct and indirect parties involved in the receipt, use, transfer, or distribution of the products against all applicable restricted party lists of the Export Regulations concerning trading with entities, persons and organizations listed therein and
- (iv) products within the scope of items-related restrictions, as specified in the respective annexes to the Export Regulations, will not, unless permitted by the Export Regulations, be (a) exported, directly or indirectly (e.g., via Eurasian Economic Union (EAEU) countries), to Russia or Belarus, or (b) resold to any third party business partner that does not take a prior commitment not to export such products to Russia or Belarus.

3.3 Non-Acceptable Use of Software and Cloud Services

Customer shall not, unless permitted by the Export Regulations or respective governmental licenses or approvals,

- (i) download, install, access or use the products from or in any location prohibited by or subject to comprehensive sanctions or subject to license requirements according to the Export Regulations;
 - (ii) grant access to, transfer, (re-)export (including any "deemed (re-)exports"), or otherwise make available the products to any entity, person, or organization identified on a restricted party list of the Export Regulations;
 - (iii) use the products for any purpose prohibited by the Export Regulations (e.g. use in connection with armaments, nuclear technology or weapons);
 - (iv) upload to a products platform any customer content unless it is non-controlled (e.g. in the EU: AL = N; in the U.S.: ECCN = N or EAR99);
 - (v) facilitate any of the afore mentioned activities by any user.
- Customer shall provide all users with all information necessary to ensure compliance with the Export Regulations.

3.4 Semiconductor Development

Customer will not, without advance written authorization from Siemens, use offerings for the development or production of integrated circuits at any semiconductor fabrication facility located in China meeting the criteria specified in the U.S. Export Administration Regulations, 15 C.F.R. 744.23.

3.5 Information

Upon request by Siemens, customer shall promptly provide Siemens with all information pertaining to users, the intended use and the location of use or the final destination (in the case of hardware, documentation and technology) of the products. Customer will notify Siemens prior to customer disclosing any information to Siemens that is defense-related or requires controlled or special data handling pursuant to applicable government regulations, and will use the disclosure tools and methods specified by Siemens.

3.6 Reservation

Siemens shall not be obligated to fulfill this agreement if such fulfillment is prevented by any impediments arising out of national or international foreign trade or customs requirements or any embargoes or other sanctions. Customer acknowledges that Siemens may be obliged under the Export Regulations to limit or suspend access by customer and/or users to products.

4. Miscellaneous

Errors excepted and subject to change without prior notice.

Article number index

Article No.	Page
3K	
3KC03	9/24 – 9/25
3KC04	9/24 – 9/25
3KC34	9/8, 9/16
3KC43	9/16
3KC44	9/16
3KC64	9/8, 9/17
3KC83	9/17
3KC84	9/17
3KC90	9/32, 9/34
3KC91	9/26 – 9/27, 9/29
3KC92	9/26 – 9/27
3KC93	9/26 – 9/27, 9/29
3KC94	9/26 – 9/27, 9/29
3KC95	9/26 – 9/27, 9/29
3KC96	9/16, 9/18 – 9/19, 9/21
3KC97	9/19
3KC98	9/18 – 9/23
3KD01	8/72 – 8/74
3KD02	8/72 – 8/74
3KD03	8/72 – 8/74
3KD04	8/72 – 8/74
3KD05	8/72 – 8/74
3KD06	8/72 – 8/74
3KD16	8/72, 8/74 – 8/75
3KD22	8/72, 8/74 – 8/75
3KD26	8/72, 8/74 – 8/75
3KD28	8/72, 8/74 – 8/75
3KD30	8/72, 8/74 – 8/75
3KD32	8/72, 8/74 – 8/75
3KD34	8/72, 8/74 – 8/75
3KD36	8/72, 8/74 – 8/75
3KD38	8/72, 8/74 – 8/75
3KD40	8/72, 8/74 – 8/75
3KD42	8/72, 8/74 – 8/75
3KD44	8/72, 8/74 – 8/75
3KD46	8/72, 8/74 – 8/75
3KD48	8/72, 8/74 – 8/75
3KD50	8/72, 8/74 – 8/75
3KD52	8/72, 8/74 – 8/75
3KD54	8/72, 8/74 – 8/75
3KD56	8/72, 8/74 – 8/75
3KD90	8/76 – 8/80
3KD91	8/76 – 8/77, 8/79 – 8/81, 8/133 – 8/134, 9/26, 9/29
3KD92	8/76 – 8/77, 8/80 – 8/81, 9/26
3KD93	8/76 – 8/77, 8/80 – 8/81, 8/134, 9/28 – 9/29
3KD94	8/76 – 8/77, 8/80 – 8/81, 8/134, 9/28 – 9/29
3KD95	8/76 – 8/77, 8/80 – 8/81, 8/134, 9/28 – 9/29
3KF13	8/128 – 8/130
3KF14	8/128 – 8/129
3KF23	8/128 – 8/130
3KF24	8/128 – 8/129
3KF33	8/128 – 8/130
3KF34	8/128 – 8/129

Article No.	Page
3KF43	8/128 – 8/130
3KF44	8/128 – 8/129
3KF53	8/128 – 8/130
3KF54	8/128 – 8/129
3KF90	7/94, 8/134
3KF91	8/80 – 8/81, 8/131, 8/133, 8/135, 9/29
3KF92	8/80, 8/131, 8/134 – 8/135
3KF93	8/131, 8/134 – 8/135
3KF94	8/80, 8/131, 8/134 – 8/135
3KF95	8/80, 8/131, 8/135
3L	
3LD20	8/26 – 8/29, 8/32 – 8/35, 8/38 – 8/41, 8/48 – 8/51, 8/53
3LD21	8/26 – 8/29, 8/32 – 8/35, 8/38 – 8/41, 8/48 – 8/51, 8/53, 9/30 – 9/31
3LD22	8/26 – 8/29, 8/32 – 8/35, 8/38 – 8/42, 8/48 – 8/53, 9/30 – 9/31
3LD23	8/26 – 8/29, 8/32 – 8/35, 8/38 – 8/41, 9/30 – 9/31
3LD24	8/26 – 8/29, 8/32 – 8/35, 8/38 – 8/41, 9/30 – 9/31
3LD25	8/26 – 8/29, 8/32 – 8/35, 8/38 – 8/41, 8/48 – 8/51, 8/53, 9/30 – 9/31
3LD27	8/26 – 8/29, 8/32 – 8/35, 8/38 – 8/41, 8/48 – 8/51, 8/53, 9/30 – 9/31
3LD28	8/26 – 8/29, 8/32 – 8/35, 8/38 – 8/41, 8/48 – 8/51, 8/53
3LD30	8/14 – 8/19
3LD31	8/14 – 8/19
3LD32	8/14 – 8/19
3LD33	8/14 – 8/19
3LD34	8/14 – 8/19
3LD50	8/56, 8/58 – 8/63
3LD52	8/58 – 8/63
3LD54	8/56, 8/58 – 8/63
3LD56	8/58 – 8/63
3LD58	8/58 – 8/63
3LD92	8/26 – 8/41, 8/43 – 8/45, 8/48 – 8/51, 8/54 – 8/55, 8/58 – 8/60, 8/62 – 8/65, 9/30 – 9/31
3LD93	8/14 – 8/17, 8/20 – 8/23
3N	
3NA30	7/44, 7/46
3NA31	7/44, 7/46
3NA32	7/45, 7/47, 7/50
3NA33	7/47
3NA34	7/47
3NA36	7/47
3NA38	7/44, 7/46
3NA61	7/36, 7/38 – 7/39
3NA62	7/37, 7/39
3NA68	7/36, 7/38
3NA71	7/40, 7/42 – 7/43
3NA72	7/41, 7/43
3NA78	7/40, 7/42
3NB10	7/74
3NB11	7/70 – 7/71, 7/73 – 7/74
3NB12	7/70 – 7/74
3NB13	7/71 – 7/73, 7/75

Article No.	Page	Article No.	Page
3NB17	7/71, 7/74	3NH30	7/10, 7/22 – 7/23
3NB23	7/72 – 7/73	3NH31	7/10, 7/22
3NB33	7/59	3NH32	7/10, 7/22, 7/27
3NC10	7/25, 7/78, 7/80, 7/90	3NH33	7/10, 7/22
3NC12	7/78	3NH34	7/10, 7/22
3NC14	7/25, 7/78, 7/80, 7/82, 7/89, 7/91	3NH35	7/22
3NC18	7/79	3NH40	7/10, 7/23
3NC22	7/25, 7/78, 7/81, 7/83	3NH42	7/10, 7/23
3NC23	7/25, 7/76, 7/78, 7/83	3NH50	7/25, 7/55, 7/60, 7/79, 7/81, 7/83
3NC24	7/58 – 7/59, 7/62, 7/64	3NH53	7/25
3NC26	7/79, 7/83	3NH54	7/25, 7/58 – 7/59, 7/62 – 7/65, 7/71, 7/73
3NC32	7/65 – 7/66	3NH57	7/25, 7/79
3NC33	7/65, 7/67	3NH75	7/23
3NC34	7/65, 7/67	3NJ41	8/104, 8/106 – 8/107, 8/109, 8/111, 8/113
3NC55	7/68	3NJ49	8/106, 8/108, 8/110, 8/112, 15/42, 15/44, 15/138, 15/213
3NC58	7/68	3NJ56	8/104
3NC73	7/69	3NJ59	8/104, 8/106, 8/108, 15/138
3NC84	7/58 – 7/59, 7/64	3NJ63	8/143
3ND13	7/48	3NJ69	8/140 – 8/143, 10/38, 15/140 – 15/141
3ND18	7/48	3NP11	8/88 – 8/89, 15/136 – 15/137, 15/212
3ND21	7/48	3NP19	8/90 – 8/96
3ND22	7/48	3NP40	15/226
3ND23	7/48	3NP50	8/100, 13/31
3NE10	7/54, 7/56	3NP52	8/100
3NE12	7/54, 7/57 – 7/58, 7/85	3NP53	8/100
3NE13	7/54, 7/57, 7/59, 7/85	3NP54	8/100
3NE14	7/54, 7/57, 7/59, 7/85	3NW10	7/86
3NE18	7/54	3NW11	7/86
3NE32	7/58, 7/62	3NW12	7/86
3NE33	7/63	3NW13	7/86
3NE34	7/64	3NW20	7/86
3NE35	7/69	3NW21	7/86
3NE36	7/64 – 7/66	3NW22	7/86
3NE41	7/57, 7/61, 7/68 – 7/69	3NW23	7/86
3NE43	7/63, 7/69	3NW30	7/86
3NE53	7/59, 7/63	3NW31	7/86
3NE54	7/64 – 7/65	3NW32	7/86
3NE56	7/64	3NW33	7/86
3NE64	7/68	3NW60	7/52, 7/84
3NE74	7/64	3NW61	7/52
3NE76	7/64 – 7/65	3NW62	7/52
3NE80	7/55 – 7/56, 7/60 – 7/61	3NW63	7/52
3NE82	7/61 – 7/62	3NW66	7/84
3NE83	7/61	3NW70	7/24, 7/26, 7/84
3NE87	7/55, 7/60	3NW71	7/24, 7/89, 7/91
3NE88	7/56, 7/61	3NW72	7/24
3NE93	7/63	3NW73	7/24
3NE94	7/68	3NW74	7/11, 7/24, 7/28 – 7/29, 7/86, 13/23
3NE96	7/65	3NW75	7/28 – 7/29, 7/90
3NG10	7/23, 8/95, 8/135	3NW76	7/26, 7/84
3NG11	7/23	3NW79	7/24
3NG12	7/23, 8/95, 8/135	3NW80	7/53
3NG13	7/23, 8/95, 8/135	3NW81	7/53
3NG14	7/23, 8/95, 8/135	3NW82	7/53
3NG15	7/23	3NX10	7/23, 7/94

Article number index

Article No.	Page
3NX20	7/22
3NX31	7/22
3NY10	8/101
3NY11	8/100 – 8/101
3NY12	8/100 – 8/101
3NY13	8/101
3NY14	8/101
3NY19	8/100 – 8/101
3NY30	8/100
3NY40	8/101

3R

3RV10	13/28, 13/34
3RV19	13/28, 13/34
3RV27	13/28, 13/34
3RV28	13/28, 13/34
3RV29	13/28, 13/34

3S

3SE52	17/16
3SU14	8/79, 8/134, 9/26

3V

3VA90	2/34, 2/62, 2/64 – 2/67
3VA91	E/7, 2/30 – 2/31, 2/37, 2/39, 2/41, 2/43, 2/45, 2/47, 2/49 – 2/54, 2/57 – 2/58, 2/62, 2/64, 2/66 – 2/67
3VA92	2/30 – 2/33, 2/37, 2/39, 2/41, 2/43, 2/45, 2/47, 2/49, 2/51 – 2/54, 2/57, 2/64, 2/66 – 2/67
3VA93	2/39, 2/41, 2/47, 2/49, 2/51 – 2/54, 2/57 – 2/58, 2/62, 2/64 – 2/65, 2/67
3VA94	2/30 – 2/33, 2/37, 2/39, 2/41, 2/43, 2/45, 2/47, 2/49, 2/51, 2/54, 2/57, 2/65
3VA95	2/41, 2/65, 2/67
3VA96	2/30, 2/32 – 2/34, 2/39, 2/43, 2/45 – 2/47, 2/49, 2/51, 2/53, 2/55, 2/62, 2/67
3VA99	2/28 – 2/29, 2/31 – 2/32, 2/34, 2/36, 2/53, 2/55, 2/57, 2/60, 2/62 – 2/65, 11/9, 11/11
3VL12	15/218
3VL16	15/218
3VL94	11/9
3VW81	1/132, 2/78
3VW90	1/61, 1/113, 1/133 – 1/141, 2/63, 2/79 – 2/88, 15/32, 15/36
3VW97	1/137, 2/83 – 2/84, 2/86 – 2/87

3W

3WA12	1/47
3WA91	1/46, 1/60 – 1/71, 1/111, 1/115 – 1/116, 15/32, 15/34, 15/36, 15/38, 15/40, 15/80, 15/82, 15/84, 15/86, 15/88, 15/90, 15/92, 15/94
3WL12	1/48
3WL91	1/34, 1/38, 1/42, 1/66, 1/110 – 1/119, 1/121 – 1/124, 1/140, 2/88
3WL93	1/110

Article No.	Page
3Z	
3ZW10	1/119
3ZX18	1/119

4A

4AC24	12/10
4AC32	12/6 – 12/7
4AC37	12/8 – 12/9

4N

4NC51	10/38 – 10/39
4NC52	10/38 – 10/39
4NC53	10/38 – 10/39
4NC54	10/38 – 10/39
4NC59	10/39

5S

5SA26	7/33
5SA27	7/33
5SA28	7/33
5SB26	7/33
5SB27	7/33
5SB28	7/33
5SB40	7/33
5SB41	7/33
5SB42	7/33
5SB43	7/33
5SD74	6/6 – 6/20
5SD80	7/33
5SE13	7/34
5SE20	7/32
5SE22	7/32
5SE23	7/32
5SF10	7/18
5SF12	7/18 – 7/19
5SF42	7/19
5SF50	7/18
5SF52	7/18
5SF60	7/9, 7/20, 13/23
5SF62	7/9, 7/20, 13/23
5SG13	7/8, 7/16, 7/89
5SG15	7/17
5SG16	7/17
5SG17	7/8, 7/16, 7/89
5SG18	7/17
5SG53	7/8, 7/16, 7/89
5SG55	7/17
5SG56	7/17
5SG57	7/8, 7/16, 7/89
5SG62	7/9, 7/20, 13/9, 13/22
5SG71	7/13, 8/145
5SG72	7/14, 8/117, 8/119, 8/145, 13/24

Article No.	Page	Article No.	Page
5SG76	7/12, 8/115	5SM60	3/17, 3/23, 3/25, 3/27, 3/35, 3/40, 3/42, 3/48, 3/59, 4/41, 4/43, 4/45, 4/49, 4/53 – 4/54, 4/58
5SH11	7/18	5SP32	3/45
5SH12	7/18	5SP33	3/45
5SH20	7/20, 13/23	5SP34	3/45
5SH22	7/20, 13/23	5SP37	3/44 – 3/45
5SH34	7/19	5SP38	3/44 – 3/45
5SH35	13/13, 13/17, 15/113	5SP41	3/28
5SH37	7/19	5SP42	3/28
5SH41	7/16	5SP43	3/29
5SH43	7/16	5SP44	3/29
5SH50	7/16	5SP51	3/30
5SH51	7/17	5SP52	3/30
5SH52	7/17, 7/20, 13/22	5ST10	3/48, 4/47, 4/58, 4/60 – 4/61
5SH53	7/89, 7/92	5ST11	14/58
5SH54	7/16 – 7/17	5ST21	3/61, 4/70, 7/88, 7/92
5SH55	7/13 – 7/14, 8/145, 13/24	5ST25	3/84 – 3/87
5SJ41	3/38	5ST26	7/24, 7/29
5SJ42	3/39	5ST30	3/13, 3/15, 3/17, 3/21, 3/23, 3/25, 3/27, 3/29, 3/31, 3/33, 3/35, 3/37, 3/39 – 3/40, 3/42, 3/46, 3/48, 3/50 – 3/54, 3/56 – 3/58, 3/60, 4/15, 4/17, 4/19, 4/21, 4/23, 4/25, 4/29, 4/31, 4/35, 4/37, 4/39, 4/41, 4/43, 4/45, 4/49, 4/51, 4/53 – 4/56, 4/58, 4/60 – 4/64, 4/66 – 4/69, 5/13, 5/15, 5/17, 7/13, 8/145
5SJ43	3/39	5ST36	3/63 – 3/66, 3/68, 3/70 – 3/72, 3/74 – 3/75, 3/77 – 3/78, 3/80, 4/73, 4/75 – 4/76, 4/78, 4/81, 7/92 – 7/93
5SJ61	3/18	5ST37	3/64 – 3/72, 3/75 – 3/78, 3/80, 3/82, 4/73 – 4/76, 4/79 – 4/81, 7/88 – 7/93
5SJ62	3/18	5ST38	3/15, 3/17, 3/23, 3/25, 3/27, 3/29, 3/31, 3/33, 3/35, 3/37, 3/40, 3/42, 3/46, 3/50, 3/52 – 3/54, 3/56 – 3/58, 3/60, 4/15, 4/17, 4/19, 4/21, 4/23, 4/25, 4/29, 4/31, 4/35, 4/37, 4/39, 4/41, 4/43, 4/45, 4/49, 4/53, 4/60, 4/62 – 4/64, 4/66 – 4/69, 5/7, 5/13, 5/15
5SJ63	3/18	5SU11	4/41
5SJ65	3/18	5SU13	4/40 – 4/42, 4/44 – 4/51
5SK91	3/47	5SU14	4/45
5SL30	3/20	5SU16	4/40 – 4/41, 4/44 – 4/45, 4/47, 4/49 – 4/51
5SL31	3/12	5SU18	4/50
5SL32	3/12	5SV13	4/52 – 4/53
5SL33	3/12	5SV16	4/52 – 4/53
5SL34	3/13	5SV31	4/14
5SL35	3/12	5SV33	4/14 – 4/16, 4/20 – 4/22, 4/26, 4/28, 4/30
5SL36	3/13	5SV34	4/14 – 4/15, 4/20 – 4/21, 4/26
5SL41	3/16	5SV36	4/14 – 4/16, 4/20 – 4/22, 4/26, 4/28, 4/30
5SL42	3/16	5SV37	4/20, 4/26, 4/30
5SL43	3/17	5SV38	4/21
5SL44	3/17	5SV41	4/18
5SL45	3/16	5SV43	4/18, 4/24
5SL46	3/17	5SV44	4/18, 4/24
5SL60	3/22, 3/40, 3/42	5SV46	4/18, 4/24
5SL61	3/14	5SV47	4/24
5SL62	3/14	5SV60	4/55 – 4/56
5SL63	3/15	5SV80	11/6
5SL64	3/15	5SV81	11/8 – 11/11
5SL65	3/14	5SV82	11/6
5SL66	3/15		
5SM21	4/34		
5SM23	4/34 – 4/36, 4/38 – 4/39		
5SM24	4/34, 4/36, 4/38		
5SM26	4/34 – 4/36, 4/38 – 4/39		
5SM27	4/34, 4/36, 4/38		
5SM28	4/34 – 4/36, 4/38 – 4/39		
5SM33	4/32		
5SM34	4/32		
5SM36	4/32		

Article number index

Article No.	Page
5SV87	11/7, 11/9 – 11/11
5SV89	11/7, 11/9, 11/11
5SW30	3/61, 4/69
5SW33	4/60 – 4/61
5SY17	3/46
5SY41	3/26
5SY42	3/26
5SY43	3/27
5SY44	3/27
5SY45	3/26
5SY46	3/27
5SY51	3/32
5SY52	3/32
5SY54	3/32
5SY61	3/24
5SY62	3/24
5SY63	3/24
5SY64	3/25
5SY65	3/24
5SY66	3/25
5SY71	3/34
5SY72	3/34
5SY73	3/35
5SY74	3/35
5SY75	3/34
5SY76	3/35
5SY81	3/36
5SY82	3/36
5SY83	3/36
5SY84	3/37
5SY85	3/36
5SY86	3/37
5SZ92	4/70
5T	
5TE25	5/16
5TE48	5/8 – 5/9
5TE58	5/10
5TE68	12/12 – 12/13
5TE81	5/6, 5/12
5TE82	5/12
5TE91	5/18, 12/12 – 12/13
5TG80	5/7, 5/9, 5/11
5TG82	3/60, 5/7, 5/13, 5/15, 5/29 – 5/30, 5/34, 11/22 – 11/23
5TL11	5/14 – 5/15
5TL12	5/14 – 5/15
5TL13	5/14 – 5/15
5TL14	5/14 – 5/15
5TL16	5/14 – 5/15
5TT31	5/49, 7/12 – 7/14, 7/17, 7/19 – 7/20, 7/94, 11/17, 11/23
5TT34	5/37, 11/12 – 11/15, 11/18 – 11/20, 11/22
5TT41	5/20 – 5/22
5TT42	5/28 – 5/29

Article No.	Page
5TT44	5/24
5TT49	5/21, 5/23, 5/25 – 5/27
5TT50	5/30
5TT52	11/21
5TT58	5/32
5TT59	5/31, 5/34, 5/36
5TT61	11/16
6A	
6AV66	10/24
6G	
6GK19	1/46, 1/68
6M	
6MF28	1/72, 1/120, 2/60
7K	
7KM10	10/26
7KM22	10/26
7KM31	10/26 – 10/27
7KM32	10/26 – 10/27
7KM42	10/27
7KM52	10/3, A/5 – A/6
7KM54	10/27
7KM92	10/29
7KM93	2/60, 10/28 – 10/29
7KM99	10/28
7KN11	3/40 – 3/43, 3/55, 4/56 – 4/57, 4/65, 7/50, 10/20
7KN13	10/18
7KN27	1/60, 10/14, 10/25
7KT12	10/31, 10/33 – 10/35, 10/39
7KT16	10/30
7KT55	10/36
7KT56	10/36
7KT58	10/36 – 10/37
7KT90	10/36
7L	
7LF45	5/38 – 5/41
7LF49	5/40 – 5/42
7LF53	5/44 – 5/47
7LF63	5/48
7LF90	3/61, 5/42, 5/45, 5/47
7LQ23	11/24
7LQ29	11/24
8G	
8GB13	15/243
8GB20	15/243
8GB45	3/61
8GB46	15/240 – 15/241
8GB50	15/240 – 15/242

Article No.	Page
8GB52	15/240
8GD60	15/24
8GD90	15/190, 15/231
8GD91	15/190, 15/231
8GD92	15/190, 15/233
8GE37	15/222
8GF57	15/180 – 15/183
8GF58	15/183
8GF71	15/186, 15/188
8GF93	14/58, 15/233
8GF96	15/176, 15/178 – 15/180, 15/183, 15/185 – 15/186, 15/188, 15/190, 15/231
8GK10	15/208 – 15/209
8GK11	15/204 – 15/205
8GK13	15/198, 15/200 – 15/202
8GK14	15/196
8GK20	15/172
8GK21	15/166
8GK23	15/168
8GK24	15/164
8GK40	15/224 – 15/225
8GK41	15/225
8GK43	15/210
8GK44	15/210 – 15/211
8GK45	15/211 – 15/212, 15/223
8GK46	15/212
8GK47	15/213, 15/216 – 15/221
8GK48	15/31, 15/42, 15/44, 15/46, 15/197, 15/214 – 15/215, 15/229 – 15/230
8GK63	15/178
8GK64	15/176 – 15/177
8GK67	15/174 – 15/175
8GK68	15/165, 15/176, 15/180 – 15/181, 15/183
8GK90	15/228 – 15/229, 15/236
8GK91	15/24, 15/167, 15/170 – 15/171, 15/173, 15/176, 15/185, 15/189, 15/196 – 15/197, 15/227 – 15/229, 15/236 – 15/237
8GK92	15/165
8GK93	15/228
8GK95	15/164, 15/166 – 15/167, 15/170, 15/173, 15/186 – 15/188, 15/190, 15/196, 15/200, 15/206, 15/228 – 15/229, 15/232
8GK96	15/165, 15/167, 15/171 – 15/172, 15/179, 15/182 – 15/185, 15/212, 15/226, 15/230
8GK97	15/181 – 15/183, 15/197, 15/212 – 15/213, 15/215, 15/226
8GK98	15/213
8GK99	15/47, 15/52, 15/114, 15/142, 15/165 – 15/167, 15/171 – 15/172, 15/176, 15/180, 15/182 – 15/183, 15/185 – 15/186, 15/188 – 15/190, 15/196, 15/200, 15/212, 15/214 – 15/215, 15/227 – 15/228, 15/230 – 15/231, 15/233 – 15/234, 15/236, 15/243
8GS40	15/222, 15/229, 15/234
8H	
8HC69	15/24, 15/237
8HE85	15/237

Article No.	Page
8HP15	15/237
8HP18	15/24, 15/237
8J	
8JK31	15/236
8JK40	15/235
8L	
8LK10	15/22 – 15/23, 15/52 – 15/53
8LK12	15/22
8LK20	15/25 – 15/27, 15/32 – 15/41, 15/49, 15/52
8LK21	15/26 – 15/27, 15/35, 15/39, 15/41
8LK23	15/24 – 15/25
8LK24	15/23
8LK25	15/23
8LK30	15/22 – 15/23, 15/30 – 15/46, 15/48 – 15/49, 15/53
8LK32	15/24
8LK40	15/28 – 15/29, 15/43, 15/45
8LK50	15/31 – 15/32, 15/35 – 15/36, 15/39, 15/41, 15/43, 15/45, 15/50
8LK60	15/28, 15/31, 15/33, 15/35, 15/37, 15/39, 15/41, 15/50, 15/52
8LK94	15/24, 15/53
8M	
8MF10	17/13, 17/16 – 17/17, 17/21, 17/23, 17/25 – 17/31
8MF11	17/13, 17/25, 17/27 – 17/28, 17/30
8MF12	17/13, 17/23, 17/25, 17/28, 17/30 – 17/31
8MF13	17/27 – 17/28, 17/30
8MF14	17/27 – 17/28, 17/30
8MF15	17/27, 17/30
8MF16	17/30
8MF17	17/30
8MF18	17/23, 17/30 – 17/31
8MF19	17/30
8MF59	17/36
8MR21	17/43 – 17/47
8MR22	17/34
8MR23	17/35
8MR60	17/40 – 17/41
8MR63	17/41
8MR64	17/39 – 17/42
8MR65	17/39 – 17/40
8P	
8PQ10	15/62, 15/64, 15/66, 15/144
8PQ12	15/56, 15/58, 15/60, 15/88, 15/90, 15/92, 15/94, 15/140, 15/144
8PQ20	15/72 – 15/76, 15/80 – 15/86, 15/88 – 15/95, 15/98, 15/100, 15/102 – 15/112, 15/115, 15/136 – 15/142, 15/146, 15/173, 15/189
8PQ21	15/68 – 15/70, 15/141, 15/146
8PQ23	15/62 – 15/63, 15/66 – 15/67, 15/144 – 15/145
8PQ24	15/63, 15/145
8PQ25	15/63, 15/66

Article number index

Article No.	Page
8PQ30	15/56 – 15/60, 15/77, 15/85, 15/88, 15/90, 15/92, 15/94, 15/96, 15/99, 15/101 – 15/102, 15/104, 15/117, 15/119, 15/121, 15/123, 15/125, 15/127, 15/131, 15/135, 15/140 – 15/141, 15/143, 15/146 – 15/147, 15/150 – 15/151, 15/153 – 15/155, 15/157, 15/159
8PQ40	15/77 – 15/79, 15/141, 15/143, 15/152 – 15/155, 15/181 – 15/182
8PQ50	15/76, 15/81, 15/83, 15/85, 15/87 – 15/95, 15/99, 15/101, 15/111, 15/116 – 15/135, 15/139, 15/156 – 15/158
8PQ60	15/81, 15/83, 15/85 – 15/87, 15/89, 15/91, 15/93, 15/95 – 15/96, 15/99, 15/101 – 15/112, 15/114 – 15/116, 15/118, 15/120, 15/122, 15/125, 15/127, 15/129 – 15/130, 15/133 – 15/134, 15/136 – 15/138, 15/142
8PQ94	8/143, 15/27, 15/52, 15/60, 15/68, 15/70, 15/73, 15/76 – 15/78, 15/117, 15/119, 15/121, 15/123, 15/131, 15/135, 15/143, 15/158 – 15/159
8PQ95	15/52, 15/60, 15/78, 15/158
8PQ96	15/143
8PQ99	15/159

8U

8UC60	8/37, 8/78 – 8/79, 8/133, 9/28
8UC71	8/36
8UC72	8/36
8UD11	8/77, 8/132, 9/27
8UD17	2/32, 8/62, 8/65, 8/78, 8/132, 9/27
8UD18	2/84, 8/78, 8/132, 9/27
8UD19	2/32 – 2/34, 2/84, 8/63, 8/65, 8/78 – 8/79, 8/133, 9/28
8US12	8/100, 13/11, 13/17, 13/27 – 13/28, 13/31, 13/33 – 13/34, 15/113
8US13	13/31, 15/113
8US16	13/10 – 13/11
8US17	13/11
8US19	13/6 – 13/7, 13/9 – 13/14, 13/17, 13/19, 13/21, 13/27, 13/31, 13/33, 13/35, 15/28, 15/52, 15/77, 15/113, 15/214, 15/235

8W

8WA18	14/12, 14/58 – 14/60
8WA28	14/58
8WA75	14/58
8WC50	13/12
8WC51	13/6 – 13/7, 13/12
8WH10	8/54 – 8/55, 14/42 – 14/53
8WH12	14/17, 14/19
8WH20	14/22 – 14/23, 14/25 – 14/30, 14/32 – 14/33
8WH21	14/24
8WH30	14/38 – 14/40
8WH50	14/34
8WH51	14/35
8WH60	14/6 – 14/14, 14/16 – 14/21
8WH81	14/15, 14/55 – 14/57
8WH82	3/61, 4/69, 14/55
8WH90	3/47, 14/6 – 14/13, 14/15 – 14/30, 14/32 – 14/36, 14/38 – 14/40, 14/42 – 14/54, 14/58 – 14/59

Article No.	Page
8WH91	14/8, 14/16 – 14/20, 14/36, 14/44 – 14/45, 14/48, 14/51, 14/53 – 14/54, 14/58

US

US2:	10/32 – 10/33, 10/35
------	----------------------

Index

Keyword	Page	Keyword	Page
0 – 9			
19-inch expansion	17/30	5SV6 COM AFDD/MCB	4/56
3KC ATC transfer control devices	9/32	5SV8 modular residual current device	11/6 – 11/11
3KC0 manual transfer switching	9/24	5SY17 circuit breakers for equipment	3/46
3KC3 and 3KC4 remote transfer switching	9/16	5SY4 miniature circuit breakers	3/26
3KC6 and 3KC8 automatic transfer switching	9/17	5SY5 miniature circuit breakers	3/32 – 3/33
3KD switch disconnectors System overview	8/66 – 8/81	5SY6 miniature circuit breakers	3/24 – 3/25
3KF switch disconnectors with fuses	8/120 – 8/134	5SY7 miniature circuit breakers	3/34 – 3/35
3LD switch disconnectors System	8/12 – 8/65	5SY8 miniature circuit breakers	3/36 – 3/37
3LD2 load transfer switches	9/30	5TE DC isolator	5/16 – 5/17
3NA COM LV HRC	7/50 – 7/51	5TE busbars	5/18
3NJ4	8/102 – 8/113	5TE48 pushbuttons	5/8 – 5/9
3NJ63	8/136 – 8/143	5TE58 light indicators	5/10 – 5/11
3NP1	8/84 – 8/96	5TE6 socket outlet for modular installation	12/12 – 5/13
3NP5	8/98 – 8/101	5TE8 control switches	5/6 – 5/7
3VA1	2/8 – 2/11	5TE81/82 On/Off switches	5/12
3VA10 – 3VA26	2/20 – 2/67	5TL1 On/Off switches	5/14
3VA2 2/5	12 – 2/1	5TT3 fuse monitors	11/12 – 11/15, 11/17 – 11/20, 11/22 – 11/23
3VA27	2/68 – 2/88	5TT4 auxiliary switches	5/26 – 11/27
3VL	2/89	5TT41 remote control switches	5/20 – 5/23
3WA1	1/4 – 1/27	5TT42 switching relays	5/28 – 5/29
3WA11 – 3WA13	1/28 – 1/73	5TT44 remote control switches	5/24 – 5/25
3WL1	1/74 – 1/89	5TT5 EMERGENCY STOP modules	5/36, 11/21
3WL10	1/126 – 1/141	5TT50 Insta contactors	5/30 – 5/31
3WL11 – 3WL13	1/90 – 1/125	5TT58 Insta contactors	5/32 – 5/34
40 mm 8US busbar system	13/6	5TT6 current relays	11/16
4AC2	12/10 – 12/11	60 mm 8US busbar system	13/12 – 13/35
4AC32	12/6 – 12/7	60 mm 8US compact busbar system	13/7 – 13/11
4AC37	12/8 – 12/9	7KM PAC measuring devices	10/26 – 10/29
5SD74	6/10 – 6/20	7KT PAC measuring devices	10/30 – 10/31
5SG switch disconnectors with fuses	8/144	7LF4 digital time switches	5/38 – 5/40
5SG76 fuse switch disconnectors System	8/114	7LF5 mechanical time switches	5/42 – 5/45
5SJ4..HG.. miniature circuit breakers	3/38	7LF6 timers for buildings	5/48
5SJ6...-KS miniature circuit breakers	3/18	7LQ2 twilight switches	11/24
5SK9 circuit breakers for equipment	3/47	8WH	14/42 – 14/611
5SL3 miniature circuit breakers	3/12	8WH2	14/22 – 14/33
5SL30 miniature circuit breakers	3/20	8WH3	14/38 – 14/40
5SL4 miniature circuit breakers	3/16	8WH5	14/34 – 14/37
5SL6 COM miniature circuit breakers	3/40, 3/42	8WH6	14/8 – 14/23
5SL6 miniature circuit breakers	3/14	8WH6 iPo plug-in terminals	14/6, 14/8, 14/10, 14/12, 14/14
5SL60 miniature circuit breakers	3/22	A	
5SM2 RC units	4/34, 4/36, 4/38	ALPHA 1250 floor-mounted	15/196 – 15/199
5SM3 RCCBs	4/32	ALPHA 160 distribution boards	15/208 – 15/209
5SM6 arc fault detection units	4/54	ALPHA 3200 Eco power distribution boards	15/20 – 15/53
5SP3 selective main miniature	3/44	ALPHA 400 distribution boards	15/204 – 15/206
5SP4 miniature circuit breakers	3/28	ALPHA 630 UNIVERSAL floor-mounted	15/168, 15/170 – 15/171
5SP5 miniature circuit breakers	3/30	ALPHA 630 UNIVERSAL wall-mounted	15/166 – 15/167
5SU1 RCBOs	4/40 – 4/51	ALPHA 630 floor-mounted	15/200 – 15/201
5SV RCCBs	4/14 – 4/26	ALPHA 630 marshaling boxes	15/202
5SV1 RCBOs	4/52 – 4/53	ALPHA 800 UNIVERSAL floor-mounted	15/164 – 15/165
5SV3 RCCBs (SEQUENCE)	4/28 – 4/31	ALPHA SIMBOX WP small distribution boards	15/243
5SV6 AFDD/MCB	4/55	ALPHA SIMBOX XL small distribution boards	15/240 – 15/242
		ALPHA UNIVERSAL 125 distribution boards	15/172 – 15/173

Index

Keyword	Page
ALPHA UNIVERSAL distribution boards (NF technology)	15/160 – 15/191
ALPHA distribution boards (DIN technology)	15/192 – 15/237
Accessories	3/48 – 3/87, 4/58 – 4/81, 7/89, 7/91, 7/93, 7/95, 9/26, 9/28, 10/10, 15/52, 15/158, 15/184, 15/186, 15/188, 15/190, 15/227 – 15/228, 15/230, 15/232, 15/234, 15/236
Accessories For remote transfer switching equipment (RTSE) and	9/18, 9/20, 9/22
Accessories and spare parts	1/60, 1/62, 1/64, 1/66, 1/68, 1/70, 1/72, 1/110, 1/112, 1/114, 1/116, 1/118, 1/120, 1/122, 1/124, 1/136, 1/138, 1/140
Accessories for 3KF LV HRC and 3KF SITOR switch disconnectors	8/131
Accessories for 3LD2 main control and EMERGENCY–STOP switches	8/43
Accessories for 3LD2 switch disconnectors in enclosure	8/55
Accessories for 8WH terminal blocks	14/55 – 14/56, 14/58, 14/60
Accessories for busbars	3/78, 3/80, 3/82
Accessories for connection and insulation	2/82
Accessories for transfer control devices	9/34
Accessory options	1/46, 1/48, 1/50, 1/52, 1/54, 1/96, 1/98, 1/100, 1/102, 1/104, 1/106, 1/130, 2/76
Air Circuit Breakers	1/1 – 1/141
Air conditioners/cooling devices	17/42
All the information you need	1/2 – 1/3, 2/2 – 2/3, 3/2 – 3/3, 4/2 – 4/3, 5/2 – 5/3, 6/2 – 6/3, 7/3, 8/3, 9/2 – 9/3, 10/2 – 10/3, 11/2 – 11/3, 12/2 – 12/3, 13/2 – 13/3, 14/2 – 14/3, 15/2 – 15/3, 16/2 – 16/3, 17/2 – 17/3
Appendix	A/1 – A/22
Applications	9/6
Arc fault detection devices (AFDDs)	4/12
Arc fault detection devices Miniature circuit breakers	4/59
Circuit breakers for equipment Switching devices	
Article number index	A/10 – A/16
Assembly kits	15/174, 15/176, 15/178, 15/210, 15/212, 15/214, 15/216, 15/218, 15/220, 15/222
Auxiliary releases, closing coils	2/85 – 2/86

B

Basic assemblies	13/6 – 13/7, 13/12, 13/14
Basic units	3/12 – 3/47, 4/14 – 4/57, 6/6 – 6/21
Built-in components	13/22, 13/24
Bus–mounting bases	7/20
Busbar Systems	13/1 – 13/35, 15/28, 15/77 – 15/78
Busbar Trunking Systems	16/1 – 16/9
Busbars	15/182, 7/88, 7/90, 7/92, 15/180, 15/226

C

Circuit breakers for equipment	3/10
Class CC fuse holders	7/29
Class CC fuse links	7/86
Class J fuse holders	7/28

Keyword	Page
Communication	1/27, 2/58, 2/60, 2/62
Compact busbars	3/73 – 3/74, 3/76, 4/77 – 4/78, 4/80
Conditions of sale and delivery	A/8 – A/9
Connection technology	2/38 – 2/50
Connection	1/26, 1/88
Control cabinets/System cubicles	I/26 – I/27
Cover frame and mounting	2/66
Current transformers	10/38 – 10/39
Cylindrical fuse holders	7/24
Cylindrical fuse links	7/52

D

DIAZED fuse bases	7/18
DIAZED fuse links	7/33
Design	15/17 – 15/19
Device adapters	13/10
Device adapters and device holders	13/26, 13/28, 13/30, 13/32, 13/34 – 13/35
Devices for all applications	3/4
Distribution blocks for DIN–rail mounting	3/84, 3/86
Distribution systems	I/24 – I/25, 15/4, 15/6, 15/8
Door, door halves, compartment door	17/16
Door, door halves	17/14

E

ETU electronic trip units and accessories	1/133 – 1/134
ETU electronic trip units	1/84, 1/86
ETU300 electronic trip unit	1/19
ETU600 electronic trip unit	1/20, 1/22, 1/24
Electrical accessories	3/50, 3/52, 3/54, 3/56, 3/58, 4/60, 4/62, 4/64, 4/66, 4/68
Electronic trip unit ETU and accessories	2/79, 2/80
Electronic trip unit	1/18
Enclosure	15/62 – 15/76
Examples of digitalization in industry	I/11
Examples of digitalization in infrastructure	I/10

F

Fan heaters	17/44
Filter fans and outlet filters	17/39 – 17/40
Floor	17/22
Frame and enclosure	15/22, 15/24, 15/26
Frame	15/56, 15/58, 15/60, 17/11 – 17/12
Fuse Systems	7/1
Fuse holders and bases	7/9 – 7/29
Fuse links	7/31 – 7/87
Fuse switch disconnectors 8/82 – 8/145	
Fuseless switch disconnectors	8/6 – 8/81

G

General accessories interior installation	17/26 – 17/28
General information	8/85, 8/99, 8/103, 8/121, 8/137

Keyword	Page
Guide frames for AC	1/56, 1/108
Guide frames for DC	1/58, 1/109
Guide frames	1/132, 2/78
H	
Hardware components	10/6 – 10/8
Heater units	17/43
Hygrostats and hygrotherms	17/47
I	
Index	A/17 – A/20
Infeeds and connection methods	13/8, 13/16, 13/18, 13/20
Installation switching devices	5/6 – 5/37
Internal accessories	2/28
Internal separation	15/148 – 15/156
Introduction to the topic of digitalization	I/12 – I/13
Introduction	4/5
L	
LED lights	17/34
LV HRC fuse bases	7/22
LV HRC fuse links	7/36 – 7/49
LV HRC signal detectors, electronic fuse monitoring	7/94
Link directory	A/2 – A/7
Load transfer switches	9/30 – 9/31
Locking provisions and interlocks	2/87 – 2/88
Locking, blocking and interlocking	2/64
M	
MINIZED fuse switch disconnectors	7/12
MINIZED switch disconnectors with fuses	7/13
Manual operators	2/30 – 2/34
Measuring Devices, Power Monitoring and Digitalization Solutions	10/2 – 10/39
Measuring devices	10/1 – 10/37
Mechanical accessories	3/60, 4/69
Miniature Circuit Breakers	3/1 – 3/87
Molded Case Circuit Breakers	2/1 – 2/89
Molded case circuit breakers and switch disconnectors for all applications	2/4 – 2/5
Molded case circuit breakers, switch disconnectors and accessories	2/6
Monitoring Devices	11/1 – 11/25
Monitoring devices for electrical values	11/6 – 11/20
Monitoring devices for plants and equipment	11/21 – 11/25
Motor operators and manual operators	2/84
Motor operators	2/36
Mounting concept and accessories	8/13, 8/25, 8/47, 8/57, 9/12 – 9/15
Mounting panels	17/23
Mounting plates	17/24
Mounting rails	17/25

Keyword	Page
N	
NEOZED bus-mounting switch	7/14
NEOZED fuse bases	7/16
NEOZED fuse links	7/32
New products	I/3
O	
Online configurator highlights	1/30, 1/90, 1/126, 2/18, 17/8
Operating mechanism, auxiliary release,	1/89
Overview of fuse systems according to IEC	7/6 – 7/7
Overview of protection, switching, measuring and monitoring tasks	I/14 – I/21
Overview of the modular system	3/48
Miniature circuit breakers	
Overview of the modular system Residual current protective devices	4/58
Overvoltage Protection Devices	6/1 – 6/21
P	
PAC/3WL/3VA SIMATIC PCS 7 library	10/25
Photovoltaic fuse links	7/84
Planning and installation tools	16/6 – 16/9
Plug-in and withdrawable technology	2/52 – 2/55
Power monitoring	10/4
Power supply units	12/10 – 12/11
Products and their applications in industry	I/9
Products and their applications in infrastructure	I/8 – I/9
Q	
Quick selection guide of fuse links	7/30
Quick selection guide of fuse holders, bases and D0 fuse switching devices	7/8 – 7/11
Quick selection guide	2/6 – 2/19, 3/6 – 3/11, 4/6 – 4/13, 8/4, 8/5, 9/6 – 9/11, 10/4 – 10/11, 13/5, 14/4 – 14/5, 15/4 – 15/15, 16/4 – 16/9, 17/7, 17/10, 17/32, 17/38
Quick-assemble kits	15/224
R	
RC units	4/8
RCBOs	4/10
RCCB protective socket outlets	4/70
RCCBs	4/6
Residual current devices RCD	2/56
Residual Current Protective Devices/ Arc Fault Detection Devices (AFDDs)	4/1 – 4/81
Roof	17/20
Roof filter fans and roof outlet filters	17/41

Index

Keyword	Page
S	
SEM3 multichannel current measuring system	10/32
SEM3T multichannel temperature measuring	10/34
SETRON Powercenter	10/18 – 10/21
SETRON Powerconfig	10/12
SETRON Powermanager	10/14 – 10/17
SETRON Powermind	10/22 – 10/24
Sid/rear walls and partition	17/18
SIKclip wiring system	3/87
SILIZED fuse links	7/34
SIMARIS planning tools	1/23, 15/14
SITOR semiconductor fuse links	7/54 – 7/82
SIVACON 8MF/8MR system lighting	17/32 – 17/37
SIVACON 8MF1 basic cubicles	17/7 – 17/9
SIVACON 8MF1 configurable enclosures	17/10 – 17/31
SIVACON 8MR system air-conditioning	17/38 – 17/47
SIVACON 8PS busbar trunking systems	16/4
SIVACON S4 power distribution boards	15/54 – 15/159
SIVACON S8 power distribution boards and motor control centers	15/16 – 15/17
SIVACON S8 power distribution boards and motor control centers	15/18 – 15/19
Section expansion	15/30 – 15/146
Slimline lights	17/36
Small distribution boards	15/238 – 15/243
Socket outlets	12/12 – 12/13
Software and digitalization solutions	10/12 – 10/25
Special colors for ALPHA	15/162, 15/194
Standard busbars	3/62 – 4/76
Structure of the article numbers	1/32 – 1/44, 1/92 – 1/94, 1/128, 2/24 – 2/26, 2/72 – 2/74, 17/9
Summary of power consumption data	1/55
Switch Disconnectors	8/1 – 8/145
Switch disconnectors with fuses	8/116 – 8/145
Switchboards, Distribution Boards and Small Distribution Boards	15/1 – 15/243
Switching Devices	5/1 – 5/49
System Cubicles, System Lighting and System Air-Conditioning	17/1 – 17/47
System overview	2/20 – 2/22, 2/68 – 2/70, 3/5, 4/4, 5/4, 6/4 – 6/5, 7/4 – 7/5, 9/4 – 9/5, 11/4 – 11/5, 12/4 – 12/5, 13/4, 15/10, 15/12, 15/16, 15/20, 15/54, 15/160, 15/192, 15/238, 17/4 – 17/6

T	
Terminal Blocks	14/1 – 14/61
The fast route to the product	1/4 – 1/7
Thermostats	17/45 – 17/46
Time and pulse counters	10/36
Timers	5/38 – 5/49
Transfer Switching Equipment and Load Transfer Switches	9/1 – 9/35

Keyword	Page
Transfer control devices	9/32 – 9/35
Transformers, Power Supply Units and Socket Outlets	12/1 – 12/13
Transformers	12/6 – 12/9
Trip units	2/16
Tripping characteristics	1/18 – 1/21

Catalogs and further information



LV 10
Low-Voltage Power Distribution and Electrical Installation Technology
SENTRON • SIVACON • ALPHA
PDF (E86060-K8280-A101-B8-7600)



ET D1
Switches and Socket Outlets
DELTA
PDF (SIEP-C10409-00-7600)



LV 13
3WA Air Circuit Breakers
SENTRON
PDF (E86060-K8280-B101-A2-7600)



SiePortal
Information and Ordering Platform on the Internet:
sieportal.siemens.com



LV 18
Air Circuit Breakers and Molded Case Circuit Breakers with UL Certification
SENTRON
PDF (E86060-K8280-E347-B1-7600)



SITRAIN
Digital Industry Academy
www.siemens.com/sitrain



IC 10
Industrial Controls
SIRIUS
PDF (E86060-K1010-A101-B6-7600)



Siemens TIA Selection Tool
for the selection, configuration and ordering of TIA products and devices
www.siemens.com/tst

The catalogs listed above and additional catalogs are available in PDF format at www.siemens.com/lowvoltage/catalogs

Further information on low-voltage power distribution and electrical installation technology is available on the Internet at www.siemens.com/lowvoltage

Get more information

www.siemens.com/lowvoltage

Published by
Siemens AG

Smart Infrastructure
Electrical Products
Siemensstraße 10
93055 Regensburg, Germany

For the U.S. published by
Siemens Industry Inc.

100 Technology Drive
Alpharetta, GA 30005
United States

PDF (E86060-K8280-A101-B8-7600)
KG 1223 1284 En
Produced in Germany
© Siemens 2023

Cybersecurity information

Siemens provides products and solutions with industrial cybersecurity functions that support the secure operation of plants, systems, machines and networks.

In order to protect plants, systems, machines and networks against cyber threats, it is necessary to implement – and continuously maintain – a holistic, state-of-the-art industrial cybersecurity concept. Siemens' products and solutions constitute one element of such a concept.

Customers are responsible for preventing unauthorized access to their plants, systems, machines and networks. Such systems, machines and components should only be connected to an enterprise network or the internet if and to the extent such a connection is necessary and only when appropriate security measures (e. g. firewalls and/or network segmentation) are in place.

For additional information on industrial cybersecurity measures that may be implemented, please visit www.siemens.com/cybersecurity-industry.

Siemens' products and solutions undergo continuous development to make them more secure. Siemens strongly recommends that product updates are applied as soon as they are available and that the latest product versions are used. Use of product versions that are no longer supported, and failure to apply the latest updates may increase customer's exposure to cyber threats.

To stay informed about product updates, subscribe to the Siemens Industrial Cybersecurity RSS Feed under www.siemens.com/cert.

Subject to changes and errors. The information given in this document only contains general descriptions and/or performance features which may not always specifically reflect those described, or which may undergo modification in the course of further development of the products. The requested performance features are binding only when they are expressly agreed upon in the concluded contract.

All product designations may be trademarks or other rights of Siemens AG, its affiliated companies or other companies whose use by third parties for their own purposes could violate the rights of the respective owner.