

Xboard Optimal switchgear enclosure



Moeller is Eaton

EATON

Powering Business Worldwide



xCommand
Control and Indication



xStart
Switching, protecting and actuating motors



xCommand
xSystem
Automation, control and visualization



Matching of Voltage and Current



xEnergy
Xpole
Energy distribution, switching and protection



Xboard
Optimal switchgear enclosure



SmartWire-Darwin Communication System



Foot and palm switches FAK, pilot devices RMO, signal towers SL

Position switches LS, pressure switches MCS, sensors

Cam switches T, switch-disconnectors P up to 315 A



Mini contactor relays, contactor relay, contactors DIL

Overload relay Z..., ZEB, ZEV, EMT6

Motor protective circuit breaker PKZ and PKE

MSC motor-starter combinations

DS, DM soft starters

Frequency inverters M-Max™, H-Max™



Timing relays DILET, ETR; measuring relays EMR and monitoring relays EMR

Easy control relay MFD-Titan multi-function display

Safety relay easySafety, safety-related control relay ESR5

Automation solutions, SPS, I/O systems, visualisation

Transformers STN, UTI; universal power supply units AING



Busbar system SASY – accessories for control panel building

Compact circuit-breakers NZM, compact switch-disconnectors N up to 1600 A

IZM circuit-breakers, IN switch-disconnectors up to 6300 A

Circuit-breakers, fuses



Insulated enclosures CI, small enclosures CI-K

CS sheet steel wall-mounting enclosure



Commercial and logistic notes, approvals, After Sales Service, type / alphabetical index

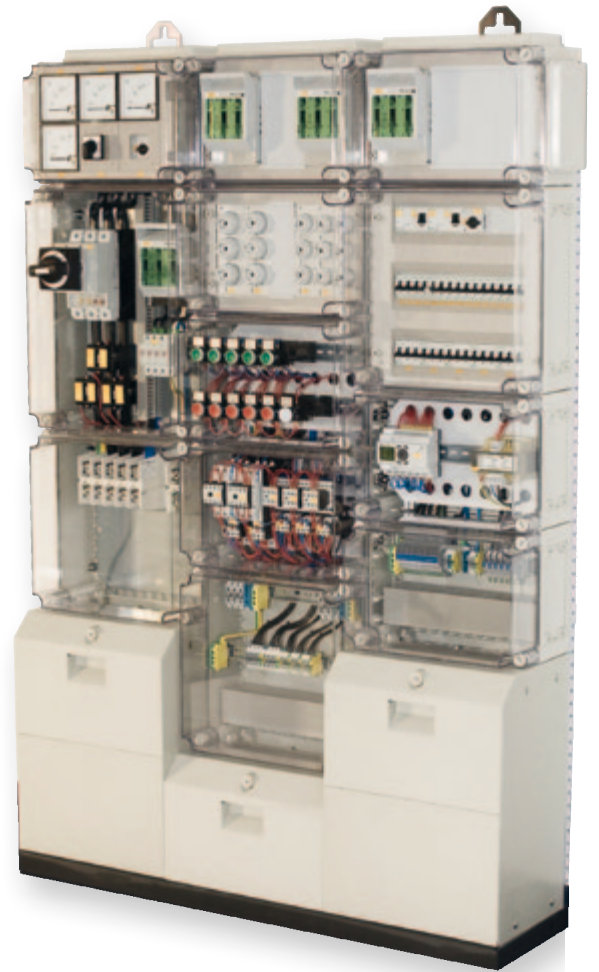
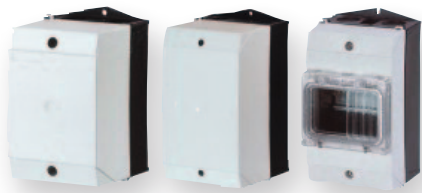

CI insulated enclosures

Exposed areas place high demands on housing systems for energy and control distribution, to guarantee operational safety.

Complete insulating encapsulation of all operating equipment up to 1600 A offers personnel and operational safety and protects against corrosion. The high protection type IP65 permits universal application. Transparent covers ease maintenance and visual checks.

totally insulated

Individual enclosures E - C/...

Integrated pressure relief when switching off short-circuits +++ Metric cable entry knockouts in all side walls +++ Faster installation of individual housing to distribution board enclosure → Page 20/6

Basic enclosures for NZM... circuit-breaker/N... - CCB... switch-disconnector

Ready to accept circuit-breakers +++ Circuit-breakers switchable from outside +++ Protects against sprayed water, dust, aggressive vapors → Page 20/34

CI distribution board terminal enclosure – K.../KST...

Connection terminals pre-mounted to mounting plate +++ Housing with sectional gland plate +++ Cable installs easily from the front → Page 20/38

Cover fasteners with cylinder lock – DVZ... - C/

Spring loaded enclosure bolts +++ Fitted by user for each CI cover +++ With closed condition display → Page 20/18

Enclosure cover for socket devices – D... - STV...

Ready for Mennekes socket devices +++ for CEE and Schuko sockets up to 125 A +++ Sealable cover fasteners → Page 20/19

Prefabricated energy and control distribution

Our system partner switchgear systems operate prefabricated energy and control distributions worldwide

www.moeller-systempartner-schaltanlagen.net



Moeller
Systempartner
Schaltanlagen

CI insulated enclosures, CI-K small enclosures

CI insulated enclosures

System overview

Technical overview – CI insulated enclosures	20/2
System overview - CI insulated enclosures	20/4

Ordering

Basic enclosures

Individual enclosures	20/6
Individual enclosure for North America	20/9
Distribution board enclosure without gland plates fitted	20/10
Panel enclosure with gland plates fitted	20/10

Distribution board enclosures for North America	20/14
---	-------

Enclosure bases	20/16
-----------------	-------

Enclosure cover

Without apertures	20/17
Lockable, without apertures	20/18
For socket devices	20/19
With door	20/20

Enclosure covers for North America	20/21
------------------------------------	-------

Accessories	20/22
-------------	-------

Accessories for North America	20/25
-------------------------------	-------

Mounting systems	20/26
------------------	-------

Fitting of meters	20/28
-------------------	-------

Accessories for enclosure assembly	20/29
------------------------------------	-------

Prepared enclosures

MCB individual enclosures	20/31
---------------------------	-------

Enclosures for miniature circuit-breakers	20/32
---	-------

Modular MCB enclosure system	20/33
------------------------------	-------

Enclosures for circuit-breakers, switch-disconnectors	20/34
---	-------

Meter enclosures	20/36
------------------	-------

Distribution board terminal enclosure	20/38
---------------------------------------	-------

Busbar housing	20/40
----------------	-------

Accessories for busbar enclosures	20/41
-----------------------------------	-------

Modular busbar system	20/44
-----------------------	-------

Module for fuse enclosures	20/46
----------------------------	-------

Corner enclosures	20/48
-------------------	-------

Enclosures with devices fitted

Individual fuse enclosures without/with door in cover	20/50
---	-------

Panel enclosures for fuses	20/52
----------------------------	-------

Individual enclosures with LV h.b.c. fuse bases	20/54
---	-------

Distribution board enclosure with LV h.b.c. fuse bases	20/57
--	-------

Individual enclosure with LV h.b.c. fuse switch-disconnectors	20/59
---	-------

Distribution board enclosure with LV h.b.c. fuse switch-disconnector	20/62
--	-------

distribution board assembly

Mounting frames	20/64
Accessories	20/67

Engineering

Basic enclosures	20/71
------------------	-------

Modular busbar system	20/73
-----------------------	-------

Mounting frame selection	20/77
--------------------------	-------

Socket combinations, energy distributor for construction site	20/80
---	-------

Selection of wiring	20/81
---------------------	-------

Technical data

Standards, measured values	20/84
----------------------------	-------

Radiated heat dissipation	20/86
---------------------------	-------

Dimensions

CI insulated enclosures	20/87
-------------------------	-------

CI-K small enclosures

System overview

CI-K small enclosures	20/92
-----------------------	-------

Ordering

CI-K basic enclosures	20/93
-----------------------	-------

CI-K accessories	20/96
------------------	-------

CI small enclosures	20/98
---------------------	-------

Technical data

CI-K small enclosures	20/99
-----------------------	-------



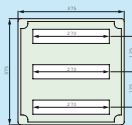
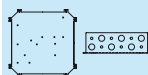
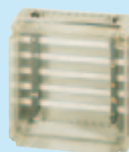
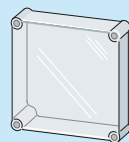
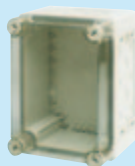

Dimensions

CI-K small enclosures	20/100
-----------------------	--------

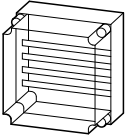
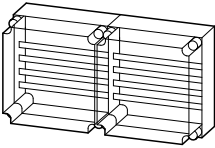

SKA..., E...I(U), RSK..., RPEN..., RS..., GS...

Prepared enclosures	Enclosures with components fitted	Enclosures with components fitted
Busbar enclosures -250 A, 400 A, 630 A → Page 20/40	Fuse enclosure - With PE/N terminals - DII/E27, D02/E18, DIII/E33 → Page 20/50	Enclosures with LV h.b.c. fuse bases GS Enclosures with LV h.b.c. fuse switch-disconnectors GSTA... - With PE/N terminals - 5th terminal can be retrofitted NH00, NH1, NH2 GS, GSTA: → Page 20/54
Corner enclosures - E...I, in corner: → Page 20/48 - E...U, around corner: → Page 20/48		
Distribution boards back-to-back RSK..., RPEN...: → Page 20/49		

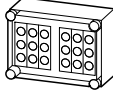
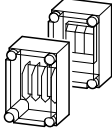
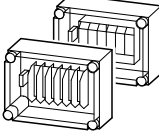
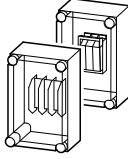
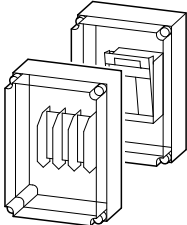
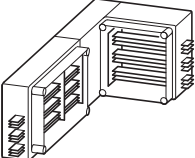
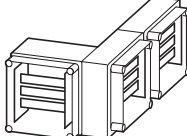
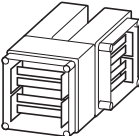
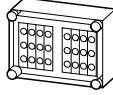
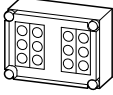
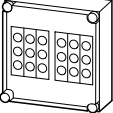
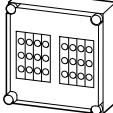
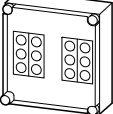
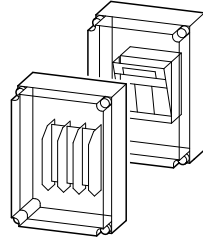
 <p>SKA254-144 250 A, 4 pole SKA404-144 400 A, 4 pole SKA634-144 630 A, 4 pole SKA255-144 250 A, 5 pole SKA405-144 400 A, 5 pole SKA635-144 630 A, 5 pole</p>  <p>SKA254-2144 250 A, 4 pole SKA404-2144 400 A, 4 pole SKA634-2144 630 A, 4 pole SKA255-2144 250 A, 5 pole SKA405-2144 400 A, 5 pole SKA635-2144 630 A, 5 pole</p>	 <p>RS27/123E RS27/123-125 RS27/123-150 3 x 3 x 25 A DII/E27</p>  <p>RS18/123E RS18/123-125 RS18/123-150 4 x 3 x 63 A D02/E18</p>  <p>RS33/123E RS33/123-125 RS33/123-150 2 x 3 x 63 A DIII/E33</p>  <p>RS27/143E RS27/143-125 RS27/143-200 6 x 3 x 25 A DII/E27</p>	 <p>GS00/123E 1 x 100 A, 1 X NH00 GSTA00/123E 1 x 100 A, 1 X NH00</p>  <p>2GS00/143E 2 x 100 A, 2 X NH00 2GSTA00/143E 2 x 100 A, 2 X NH00</p>  <p>GS00-160/143E-G 1 x 160 A, 1 X NH00 GSTA00-160/143E-G 1 x 160 A, 1 X NH00</p>	 <p>GS1/145E 1 x 250 A, 1 X NH1 GSTA1/145E 1 x 250 A, 1 X NH1</p>
 <p>ESKI... 250-1600 A 3 main conductors 1 or 2 PE/N EPENI... 1000-1600 A 1 or 2 PE/N</p>  <p>ESKU... 250-1600 A 3 main conductors 1 or 2 PE/N EPENU... 1000-1600 A 1 or 2 PE/N</p>  <p>RSK... 250-1600 A 3 main conductors 1 or 2 PE/N</p>	 <p>RS18/143E RS18/143-125 RS18/143-200 8 x 3 x 63 A D02/E18</p>  <p>RS33/143E RS33/143-125 RS33/143-200 4 x 3 x 63 A DIII/E33</p>  <p>RS27/144E 6 x 3 x 25 A DII/E27</p>  <p>RS18/144E 8 x 3 x 63 A D02/E18</p>  <p>RS33/144E 4 x 3 x 63 A DIII/E33</p>	 <p>GS2/145E 1 x 400 A, 1 X NH2 GSTA2/145E 1 x 400 A, 1 X NH2</p>	



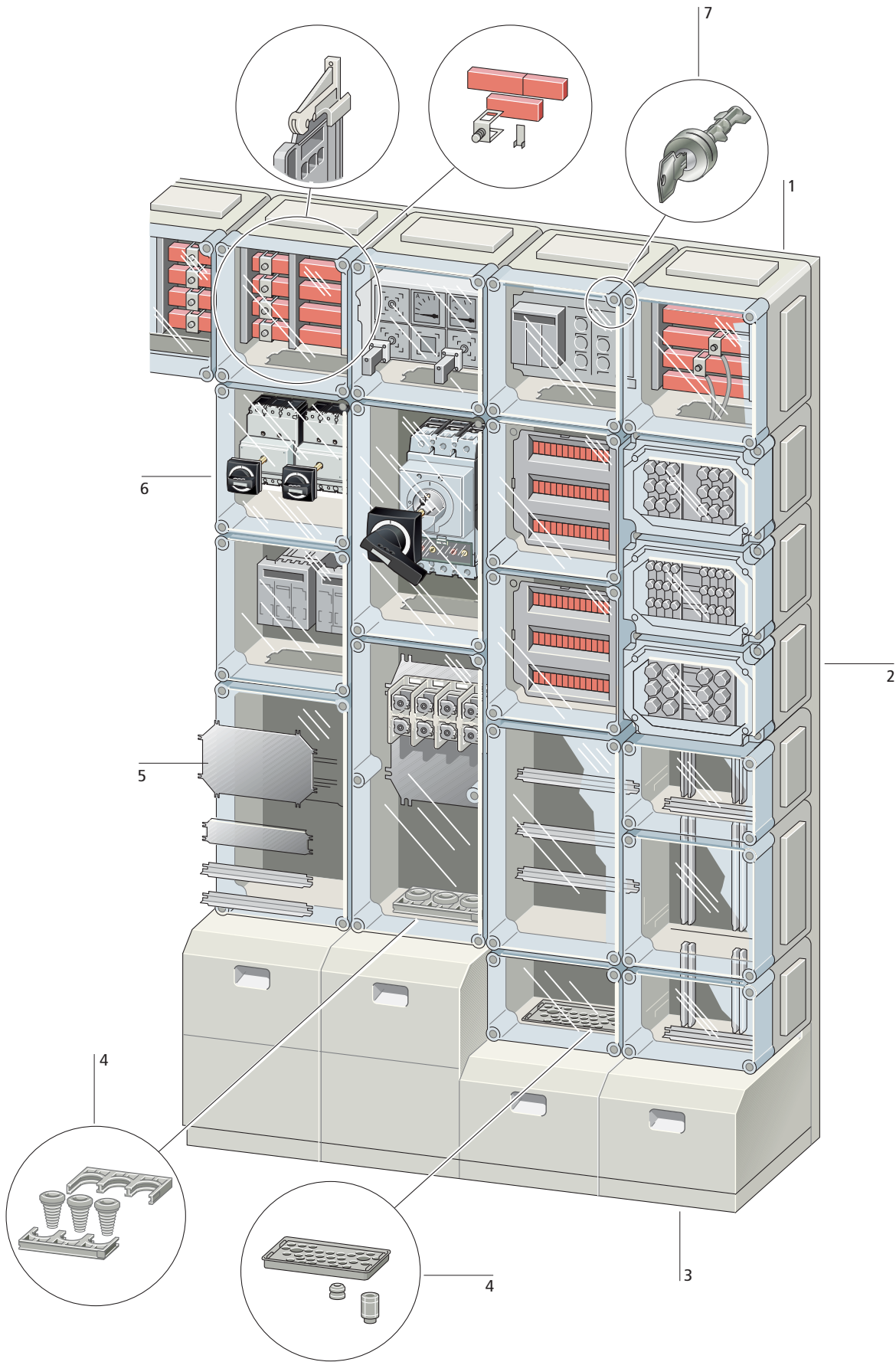

Basic enclosures	
Five sizes can be combined	
Width $\geq 187.5 \leq 375$ mm	
Height $\geq 250 \leq 750$ mm	
Depth $\geq 150 \leq 275$ mm	
Metric cable entry knockouts in the sides	
Cover fasteners with I/O status indication, sealable, pressure relief through built-in spring	
Cover transparent, with/without door	
Non-transparent, RAL 7032	
→ Page 20/17	

Product features	
<ul style="list-style-type: none"> • Totally insulated • Protection type IP65 • Safety class 2 • Distribution board system with 25 mm grid • Modular system • Captive, sponge-rubber gaskets • Insulating wedge-lock fastener for connecting the enclosures with each other • Enclosure of self-extinguishing, -halogen free polycarbonate 	

Standards	
<ul style="list-style-type: none"> • IEC/EN 60439-1 • VDE 0660 Part 500 • BS 5486 Part 1 • NF EN 60439-1 • SN EN 60439-1 	

Busbar systems	1
5-conductor systems	
Rated operational current up to 630 A	
Tinned copper busbars up to 630 A	
Busbar terminals	
→ Page 20/40	

Fixing	2
Support frames for wall-mounted and floor-standing distribution boards	
Wall fixing bracket	
Fixing straps	
→ Page 20/64	

Cable compartment	3
Plinths	
Cable compartment cladding	
→ Page 20/68 → Page 20/70	

Cable entries	4
Gland plates for large cross-sections	
Flanges	
Metric cable glands/cable grommets	
→ Page 20/23 → Page 20/29	
Terminals, copper band	
→ Chapter 16, Accessories for control panel building	

Mounting systems for basic enclosures	5
Sheet steel mounting plates and insulating material	
Pre-drilled mounting plate for surface mounting standard devices	
→ Online catalogue	
Mounting rails and module mounting rails to IEC/EN 60715	
Mounting depths 125 to 250 mm	
Meter equipment	
→ Page 20/26	

Enclosures with components fitted/ service distribution boards (TTA)	6
MCB enclosures	
Fuse enclosures	
→ Page 20/52	
Enclosures with LV h.b.c. fuse bases	
→ Page 20/57	
Enclosures with LV h.b.c. fuse switch-disconnectors	
→ Page 20/62	

CI enclosures for NZM1, 2, 3 circuit-breakers and N1, 2, 3, PN1, 2, 3 switch-disconnectors	
→ Page 20/34	
Meter enclosures	
→ Page 20/37	

Cover fasteners	7
Fixable or with cylinder lock	
→ Page 20/22	

Enclosure styles

The enclosure cover is identical for all three construction types.

CI...E-... individual enclosure

- Metric cable entry knockouts in all sides
- All enclosure sides can also be knocked out
- Also for use in CI distribution board systems

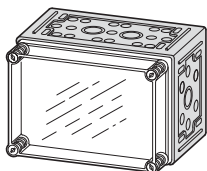

CI...X-... individual enclosure

- All four enclosure side plates walls smooth without knockouts

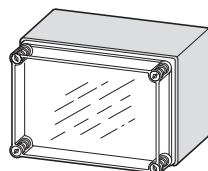

CI...-... panel enclosure

- Horizontal enclosure sides open
- Vertical enclosure sides with large knockouts
- Suitable for surface mounting CI distribution board systems

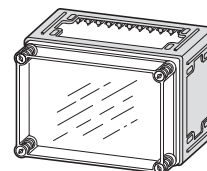

Ordering

Dimensions	Enclosure depth: Dimensions from top: 1. Mounting depth for mounting plate 2. Mounting depth for mounting rail 7.5 mm height 3. Enclosure depth for mounting rail 15 mm height 4. Enclosure depth	Type cover / Type Enclosure base	Part no. Article no.	Price See price list	Std. pack
mm	mm				
Individual enclosures E and X					
<ul style="list-style-type: none"> Protection type IP65 Cover transparent or non-transparent (RAL 7032, pebble grey) Fixing straps for wall fixing Sealable cover fasteners 					
E individual enclosures					
<ul style="list-style-type: none"> With metric knockouts in all enclosure side plates; see illustrations A to F Full-area knockouts in the sides Can be converted to distribution board enclosure 					
X individual enclosures					
<ul style="list-style-type: none"> Smooth side plates, without knockouts 					
		Transparent /knockout	CI23E-125 019570		1 off
		Non-transparent /knockout	CI23E-125-RAL7032 090152		
		Transparent /plain	CI23X-125 010408		
		Transparent /knockout	CI23E-150 021943		
		Non-transparent /knockout	CI23E-150-RAL7032 090153		
		Transparent /plain	CI23X-150 015154		
		Transparent /knockout	CI43E-125 093133		1 off
		Non-transparent /knockout	CI43E-125-RAL7032 090154		
		Transparent /plain	CI43X-125 019900		
		Transparent /knockout	CI43E-150 095506		
		Non-transparent /knockout	CI43E-150-RAL7032 090155		
		Transparent /plain	CI43X-150 024646		
		Transparent /knockout	CI43E-200 097879		
		Non-transparent /knockout	CI43E-200-RAL7032 090156		
		Transparent /plain	CI43X-200 029392		



HPL20007EN

Dimensions	Enclosure depth: Dimensions from top: 1. Mounting depth for mounting plate 2. Mounting depth for mounting rail 7.5 mm height 3. Enclosure depth for mounting rail 15 mm height 4. Enclosure depth	Type cover / Type Enclosure base	Part no. Article no.	Price See price list	Std. pack	
mm	mm					
		Transparent /knockout	CI44E-125 031436		1off	
		Non-transparent /knockout	CI44E-125-RAL7032 090157			
		Transparent /plain	CI44X-125 031765			
		Transparent /knockout	CI44E-150 033809			
		Non-transparent /knockout	CI44E-150-RAL7032 090158			
		Transparent /plain	CI44X-150 034138			
		Transparent /knockout	CI44E-200 036182			
		transparent with transparent door /knockout	CI44E-200-T 090147			
		Non-transparent /knockout	CI44E-200-RAL7032 090159			
			Transparent /plain	CI44X-200 036511		

Notes

A



- 1 x M32/20
- 6 x M20
- 2 x M16

B

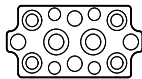

- 2 x M32/20
- 4 x M25/16
- 4 x M20
- 4 x M16

C

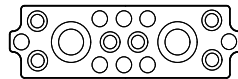

- 2 x M50/20
- 6 x M25/16
- 8 x M20

D

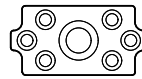

- 1 x M50/32
- 6 x M25/16

E

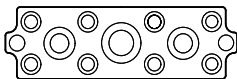

- 1 x M50/32
- 2 x M40/25
- 8 x M25/16
- 2 x M20

F

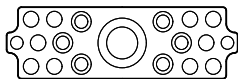

- 1 x M63/40
- 6 x M25/16
- 10 x M20
- 2 x M16



Dimensions	Enclosure depth: Dimensions from top: 1. Mounting depth for mounting plate 2. Mounting depth for mounting rail 7.5 mm height 3. Enclosure depth for mounting rail 15 mm height 4. Enclosure depth	Type cover / Type Enclosure base	Part no. Article no.	Price See price list	Std. pack
mm	mm				

Individual enclosures E and X

- Protection type IP65
 - Cover transparent or non-transparent (RAL 7032, pebble grey)
 - Fixing straps for wall fixing
 - Sealable cover fasteners
- E individual enclosures
- With metric knockouts in all enclosure side plates; see illustrations A to F
 - Full-area knockouts in the sides
 - Can be converted to distribution board enclosure
- X individual enclosures
- Smooth side plates, without knockouts

		Transparent /knockout	CI44E-250 038555		1 off
		Transparent /plain	CI44X-250 038884		
		Transparent /knockout	CI45E-200 001891		
		Non-transparent /knockout	CI45E-200-RAL7032 090160		
		Transparent /plain	CI45X-200 098469		

Notes

<p>A</p> <p>1 x M32/20 6 x M20 2 x M16</p>	<p>B</p> <p>2 x M32/20 4 x M25/16 4 x M20 4 x M16</p>	<p>C</p> <p>2 x M50/20 6 x M25/16 8 x M20</p>	<p>D</p> <p>1 x M50/32 6 x M25/16</p>
<p>E</p> <p>1 x M50/32 2 x M40/25 8 x M25/16 2 x M20</p>	<p>F</p> <p>1 x M63/40 6 x M25/16 10 x M20 2 x M16</p>		



HPL20009EN

CI...X...-NA

Dimensions		Mounting depth	Part no. Article no.	Price See price list	Std. pack	
Width mm	Height mm					Depth mm
Individual enclosures						
<ul style="list-style-type: none"> Protection type IP65 Enclosure base RAL 7032 with smooth sides Fixing straps for wall fixing 						
Individual enclosures without/with door in cover						
<ul style="list-style-type: none"> Transparent cover, cover locks can be sealed 						
187.5	250	150	125	C123X-125-NA 002209	1 off 	
		175	150	C123X-150-NA 002212		
375	250	150	125	C143X-125-NA 002213		
		175	150	C143X-150-NA 002232		
		225	200	C143X-200-NA 002217		
	375	150	125	C144X-125-NA 002218		
		175	150	C144X-150-NA 002219		
		225	200	C144X-200-NA 002220		
500	225	275	250	C144X-250-NA 002224		
		200	200	C145X-200-NA 264023		
Individual enclosures with cover and doors						
<ul style="list-style-type: none"> Transparent cover with door, cover fasteners can be sealed Transparent door, with handle latches and 180° door opening angle Door hinges can be subsequently changed to left, right, top or bottom. 						
187.5	250	166	125	C123X-125/T-NA 002210		1 off
		191	150	C123X-150/T-NA 002211		
375	250	166	125	C143X-125/T-NA 002214		
		191	150	C143X-150/T-NA 002215		
		241	200	C143X-200/T-NA 002216		
	375	241	200	C144X-200/T-NA 002221		
		191	150	C144X-150/T-NA 002222		
		291	200	C144X-250/T-NA 002223		
166	125			C144X-125/T-NA 002233		

Notes

Information relevant for export to North America

Product Standards	UL 508A; CSA-C22.2 No.94; IEC/EN 60529; CE marking
UL File No.	E54120, E337418
UL CCN	NITW
CSA File No.	27130
CSA Class No.	3211-07
NA Certification	UL Listed, CSA certified
Specially designed for NA	Yes
Suitable for	Industrial Control Panels
Degree of Protection	IEC: IP65; UL/CSA Types 1, 12, 13, 4X, indoor only

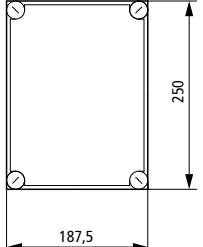
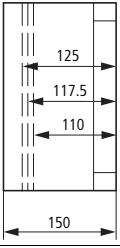
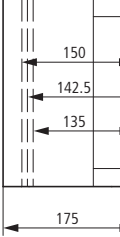
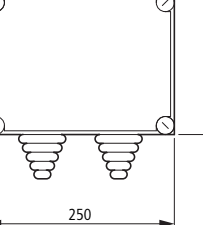
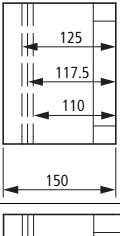
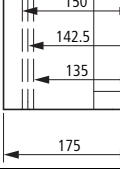
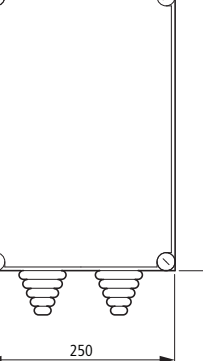
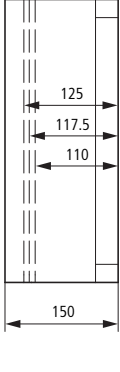

Dimensions mm	Enclosure depth: Dimensions from top: 1. Mounting depth for mounting plate 2. Mounting depth for mounting rail 7.5 mm height 3. Enclosure depth for mounting rail 15 mm height 4. Enclosure depth mm	Cable entry outer diameter mm	Part no. Article no.	Price See price list	Std. pack
Distribution board with/without gland plates fitted					
<ul style="list-style-type: none"> Transparent cover, cover fasteners can be sealed. 					
CI distribution board enclosure without cable gland plates					
<ul style="list-style-type: none"> Protection type IP65 Sides closed, but with full area knockout, open top and bottom 					
KST distribution board enclosure with cable gland plates fitted					
<ul style="list-style-type: none"> Protection type IP65 (from bottom) Sides closed, but with full area knockout, open at top Mounting of cable supports in the distribution board with wedge-lock fastener Gland plate can be split, cables can be inserted from the front 					
		-	CI23-125 098208		1 off
		-	CI23-150 012781		
		2 x 14 - 54	KST32-125 069774		
		2 x 14 - 54	KST32-150 072147		
		2 x 14 - 54	KST34-125 076893		

HPL20011EN

CI..., KST...

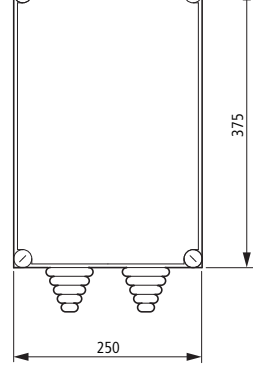
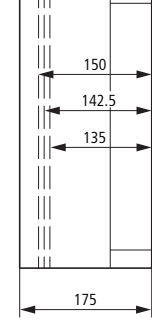
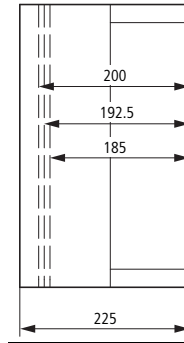
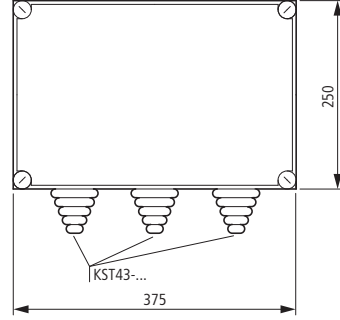
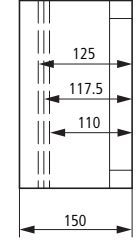
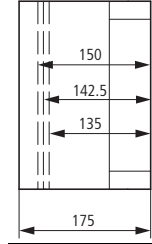
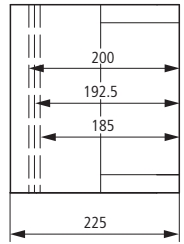

Dimensions	Enclosure depth: Dimensions from top: 1. Mounting depth for mounting plate 2. Mounting depth for mounting rail 7.5 mm height 3. Enclosure depth for mounting rail 15 mm height 4. Enclosure depth	Cable entry outer diameter	Part no. Article no.	Price See price list	Std. pack
mm	mm	mm			
		2 x 14 - 54	KST34-150 074520		1 off
		2 x 14 - 54	KST34-200 079266		
		-	CI43-125 017527		
		3 x 14 - 68	KST43-125 081639		
		-	CI43-150 022273		
		3 x 14 - 68	KST43-150 084012		
		-	CI43-200 027019		
		3 x 14 - 68	KST43-200 086385		



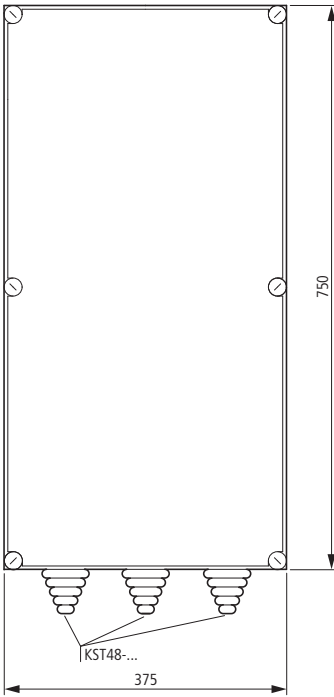
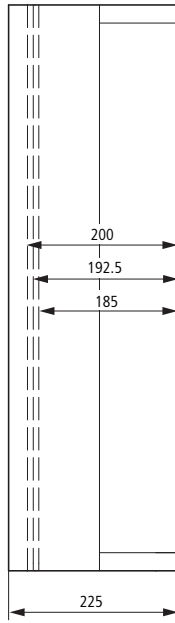

Dimensions	Enclosure depth: Dimensions from top: 1. Mounting depth for mounting plate 2. Mounting depth for mounting rail 7.5 mm height 3. Enclosure depth for mounting rail 15 mm height 4. Enclosure depth	Cable entry outer diameter	Part no. Article no.	Price See price list	Std. pack
mm	mm	mm			
		<p>–</p> <p>3 x 14 - 68</p>	<p>CI44-125 012452</p> <p>KST44-125 088758</p>		1 off
		<p>–</p> <p>3 x 14 - 68</p>	<p>CI44-150 017198</p> <p>KST44-150 091131</p>		
		<p>–</p> <p>3 x 14 - 68</p>	<p>CI44-200 021944</p> <p>KST44-200 093504</p>		
		<p>–</p> <p>3 x 14 - 68</p>	<p>CI44-250 026690</p> <p>KST44-250 095877</p>		
		<p>–</p>	<p>CI45-200 001896</p>		

HPL20013EN

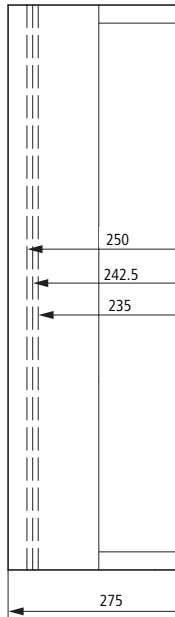
CI..., KST...

Dimensions	Enclosure depth: Dimensions from top: 1. Mounting depth for mounting plate 2. Mounting depth for mounting rail 7.5 mm height 3. Enclosure depth for mounting rail 15 mm height 4. Enclosure depth	Cable entry outer diameter	Part no. Article no.	Price See price list	Std. pack
mm	mm	mm			
Distribution board with/without gland plates fitted					
<ul style="list-style-type: none"> Transparent cover, cover fasteners can be sealed. 					
CI distribution board enclosure without cable gland plates					
<ul style="list-style-type: none"> Protection type IP65 Sides closed, but with full area knockout, open top and bottom 					
KST distribution board enclosure with cable gland plates fitted					
<ul style="list-style-type: none"> Protection type IP65 (from bottom) Sides closed, but with full area knockout, open at top Mounting of cable supports in the distribution board with wedge-lock fastener Gland plate can be split, cables can be inserted from the front 					
		-	CI48-200 078896		1 off
		3 x 14 - 68	KST48-200 098250		
		-	CI48-250 083642		
		3 x 14 - 68	KST48-250 010450		



Dimensions			Mounting depth mm	Part no. Article no.	Price See price list	Std. pack	
Width mm	Height mm	Depth mm					
<ul style="list-style-type: none"> Protection type IP65 Base color RAL7032, fitted with removable smooth flanges on all four sides Fixing straps for wall fixing 							
Panel enclosures with cover and flanges							
<ul style="list-style-type: none"> Transparent cover, cover fasteners can be sealed. 							
234	296	150	125	CI23-125-NA 002234		1 off 	
234	296	175	150	CI23-150-NA 002237			
421	296	150	125	CI43-125-NA 002238			
421	296	175	150	CI43-150-NA 002241			
421	296	225	200	CI43-200-NA 002242			
421	421	150	125	CI44-125-NA 002245			
421	421	175	150	CI44-150-NA 002246			
421	421	225	200	CI44-200-NA 002249			
421	421	275	225	CI44-250-NA 002250			
421	546	225	200	CI45-200-NA 264024			
421	796	225	200	CI48-200-NA¹⁾ 002253			
421	796	275	250	CI48-250-NA¹⁾ 002254			
Panel enclosures with door and flanges¹⁾							
<ul style="list-style-type: none"> Transparent cover with door, cover fasteners can be sealed Transparent door with quick-release fasteners and 180° door opening angle Door hinges can be subsequently changed to left, right, top or bottom. 							
234	296	166	125	CI23-125/T-NA 002235		1 off 	
234	296	191	150	CI23-150/T-NA 002236			
421	296	166	125	CI43-125/T-NA 002239			
421	296	191	150	CI43-150/T-NA 002240			
421	296	241	200	CI43-200/T-NA 002243			
421	421	166	125	CI44-125/T-NA 002244			
421	421	191	150	CI44-150/T-NA 002247			
421	421	241	200	CI44-200/T-NA 002248			
421	421	291	250	CI44-250/T-NA 002251			
421	796	241	200	CI48-200/T-NA 002252			
421	796	291	250	CI48-250/T-NA 002255			
421	796	241	200	CI48-200/2T-NA 002256			
421	796	291	250	CI48-250/2T-NA 002257			

Notes

Information relevant for export to North America



Product Standards	UL 508A; CSA-C22.2 No.94; IEC/EN 60529; CE marking
UL File No.	E54120, E337418
UL CCN	NITW
CSA File No.	27130
CSA Class No.	3211-07
NA Certification	UL Listed, CSA certified
Specially designed for NA	Yes
Suitable for	Industrial Control Panels
Degree of Protection	IEC: IP65; UL/CSA Types 1, 12, 13, 4X, indoor only ¹⁾ IEC: IP65; UL/CSA Types 1, 12,13, indoor only

HPL20015EN

CI...-NA

Dimensions		Mounting depth		Part no. Article no.	Price See price list	Std. pack
Width mm	Height mm	Depth mm	Base design mm			
Distribution board enclosures with cover and preassembled side walls						
<ul style="list-style-type: none"> Protection type IP65 Base RAL 7032, with different side plates on all four sides Transparent cover, cover fasteners can be sealed. 						
234	296	175	150	1 × without knockouts 1 × side plates knockout 2 × side plates with knockout	CI23-2210-150-NA 234059	1 off
421	296	175	150	2 × without knockouts 2 × side plates with knockout	CI43-2200-150-NA 234060	
421	296	175	150	3 × without knockouts 1 × side plates with knockout	CI43-2000-150-NA 234061	
421	296	175	150	1 × without knockouts 3 × side plates with knockout	CI43-2022-150-NA 234062	
421	296	225	200	2 × without knockouts 2 × side plates with knockout	CI43-2200-200-NA 234063	
421	421	175	150	2 × without knockouts 2 × side plates with knockout	CI44-2200-150-NA 234064	
421	421	175	150	1 × without knockouts 3 × side plates with knockout	CI44-2220-150-NA 234065	
421	421	225	200	2 × without knockouts 2 × side plates with knockout	CI44-2200-200-NA 234066	
421	421	275	225	2 × without knockouts 2 × side plates with knockout	CI44-2200-250-NA 234067	

Notes

Ordering example:

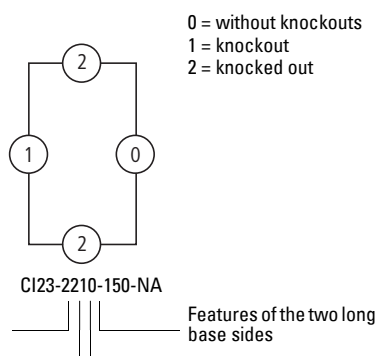

Information relevant for export to North America

	Product Standards	UL 508A; CSA-C22.2 No.94; IEC/EN 60529; CE marking
	UL File No.	E54120, E337418
	UL CCN	NITW
	CSA File No.	27130
	CSA Class No.	3211-07
	NA Certification	UL Listed, CSA certified
	Specially designed for NA	Yes
	Suitable for	Industrial Control Panels
	Degree of Protection	IEC: IP65; UL/CSA Types 1, 12, 13, 4X, indoor only

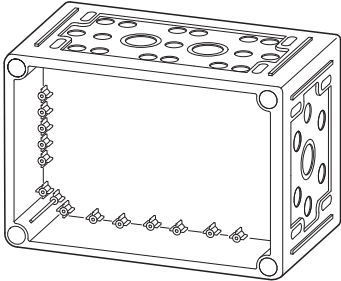
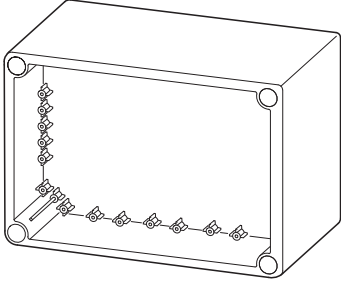
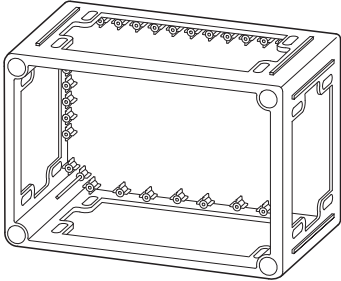
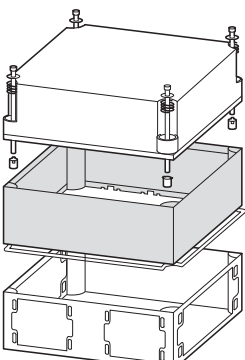

	Dimensions		Cable entry		Part no. Article no.	Price See price list	Std. pack
	Width	Height	Top and bottom	Sideways			
	mm	mm					
Bases for E-type individual enclosures							
<ul style="list-style-type: none"> Metric cable entry knockouts in all sides Full-area knockouts in the sides 							
	187.5	250	1 x M32/20 6 x M20 2 x M16	2 x M32/20 4 x M25/16 4 x M20 4 x M16	U-CI23E 038793		1 off
	375	250	2 x M50/32 6 x M25/16 8 x M20	1 x M50/32 6 x M25/16	U-CI43E 064896		
		375	1 x M50/32 2 x M40/25 8 x M25/16 2 x M20	1 x M63/40 6 x M25/16 10 x M20 2 x M16	U-CI44E 069642		
		500	1 x M50/32 2 x M40/25 8 x M25/16 2 x M20	On each 2: 1 x M50/32 6 x M25/16	U-CI45E 001893		
Bases for X type individual enclosures							
<ul style="list-style-type: none"> Smooth side plates, without knockouts 							
	187.5	250	Drill as required	Drill as required	U-CI23X 057909		1 off
	375	250			U-CI43X 062655		
		375			U-CI44X 067401		
		500			U-CI45X 098470		
Bases for panel enclosures							
<ul style="list-style-type: none"> Sides closed, but with full area knockout Open top and bottom 							
	187.5	250	Via FL2... flange	Via FL3... flange	U-CI23 060282		1 off
	375	250	Via FL4... flange	Via FL3... flange	U-CI43 065028		
		375	Via FL4... flange	Via FL4... flange	U-CI44 067269		
		500	Via FL4... flange	Via FL3... flange	U-CI45 001894		
		750	Via FL4... flange	Via FL4... flange	U-CI48 083880		
Notes Flange → Page 20/23							
Enclosure intermediate frame							
<ul style="list-style-type: none"> For increased mounting depth Smooth side plates, without knockouts Color RAL 7032, pebble grey Screw-fitting cover fastener Equipment supplied: gasket, mounting accessories 							
	Dimensions		Mounting depth ¹⁾	For use with	Part no. Article no.	Price See price list	Std. pack
	Width	Height	mm				
	375	500	275	U-CI45... D200-CI45 CI45...	U-CI45-DR 110103		1 off
Notes ¹⁾ with cover D200-CI45							

HPL20017EN

Enclosure cover

D...-CI...

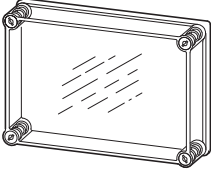
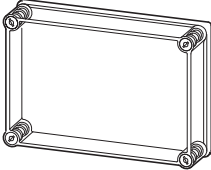
	Dimensions		Mounting depth mm	For use with	Part no. Article no.	Price See price list	Std. pack
	Width mm	Height mm					
Enclosure covers without openings							
<ul style="list-style-type: none"> • Sealable cover fasteners • Sealing 							
Cover, transparent							
	187.5	250	125	U-CI23...	D125-CI23 014830		10 off
			150	U-CI23...	D150-CI23 024322		4 off
	375	250	125	U-CI43...	D125-CI43 017203		5 off
			150		D150-CI43 038560		2 off
			200		D200-CI43 074155		2 off
		375	125	U-CI44...	D125-CI44 019576		5 off
					D150-CI44 040933		2 off
					D200-CI44 076528		2 off
					D250-CI44 081274		1 off
	500	200	U-CI45...	D200-CI45 001895		2 off	
			U-CI48...	D200-CI48 078901		2 off	
			U-CI48...	D250-CI48 083647		1 off	
	750	200	U-CI48...	D200-CI48 078901		2 off	
			U-CI48...	D250-CI48 083647		1 off	
Enclosure covers without openings							
Cover, non-transparent ; color RAL 7032, pebble grey							
	187.5	250	125	U-CI23...	D125-CI23-RAL7032 098471		10 off
			150	U-CI23...	D150-CI23-RAL7032 098472		4 off
	375	250	125	U-CI43...	D125-CI43-RAL7032 002843		5 off
			200		D200-CI43-RAL7032 005216		2 off
			150		D150-CI43-RAL7032 098473		2 off
		375	125	U-CI44...	D125-CI44-RAL7032 007589		5 off
					D200-CI44-RAL7032 009962		2 off
					D150-CI44-RAL7032 098474		2 off
					D250-CI44-RAL7032 098475		1 off
	500	200	U-CI45...	D200-CI45-RAL7032 098476		2 off	
			U-CI48...	D200-CI48-RAL7032 098477		2 off	
	750	200	U-CI48...	D200-CI48-RAL7032 098477		2 off	
	750	250	U-CI48...	D250-CI48-RAL7032 098478		1 off	



Enclosure cover

D...-CI...-DVZ

HPL20018EN

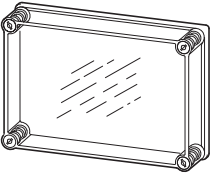
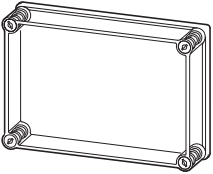
	Dimensions		Mounting depth mm	For use with	Number Cylindrical locks	Part no. Article no.	Price See price list	Std. pack
	Width mm	Height mm						
Lockable enclosure covers without openings								
<ul style="list-style-type: none"> Two or four lockable cover fasteners, diagonal with cylinder lock Cylindrical locks, uniformly locking Two diagonal lead-sealable cover locks. When also replacing all DV...-CI with DVZ...-CI, the sealing function is not available. Equipment supplied: gasket, key 								
Transparent cover								
	187.5	250	125	U-CI23...	2	D125-CI23-DVZ 138354		4 off
	187.5	250	150	U-CI23...	2	D150-CI23-DVZ 138355		4 off
	375	250	125	U-CI43...	2	D125-CI43-DVZ 138356		2 off
			150	U-CI43...	2	D150-CI43-DVZ 138357		
			200	U-CI43...	2	D200-CI43-DVZ 138358		
	375	250	125	U-CI44...	2	D125-CI44-DVZ 138359		2 off
			150	U-CI44...	2	D150-CI44-DVZ 138520		
			200	U-CI44...	2	D200-CI44-DVZ 138521		
			250	U-CI44...	2	D250-CI44-DVZ 138522		
	500	200		U-CI45...	2	D200-CI45-DVZ 138523		
	750	200		U-CI48...	4	D200-CI48-DVZ 138524		
	750	250		U-CI48...	4	D250-CI48-DVZ 138525		
	Non-transparent cover RAL7032							
	187.5	250	125	U-CI23...	2	D125-CI23-RAL7032-DVZ 138526		4 off
	187.5	250	150	U-CI23...	2	D150-CI23-RAL7032-DVZ 138527		4 off
	375	250	125	U-CI43...	2	D125-CI43-RAL7032-DVZ 138528		2 off
			150	U-CI43...	2	D150-CI43-RAL7032-DVZ 138529		
			200	U-CI43...	2	D200-CI43-RAL7032-DVZ 138530		
	375	250	125	U-CI44...	2	D125-CI44-RAL7032-DVZ 138531		2 off
			150	U-CI44...	2	D150-CI44-RAL7032-DVZ 138532		
			200	U-CI44...	2	D200-CI44-RAL7032-DVZ 138533		
			250	U-CI44...	2	D250-CI44-RAL7032-DVZ 138534		
	500	200		U-CI45...	2	D200-CI45-RAL7032-DVZ 138535		
	750	200		U-CI48...	4	D200-CI48-RAL7032-DVZ 138536		
	750	250		U-CI48...	4	D250-CI48-RAL7032-DVZ 138537		





HPL20019EN

Enclosure cover

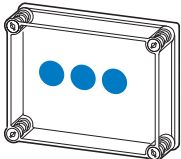
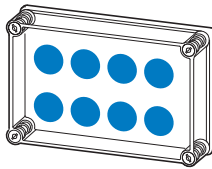
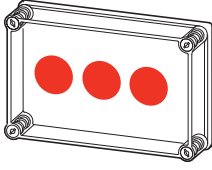
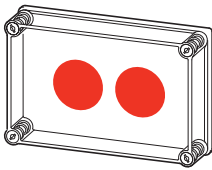
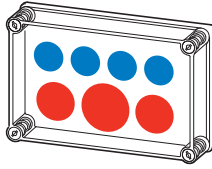
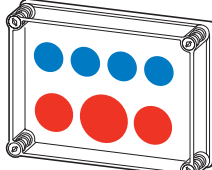
D...-CI...-RAL7032-STV...



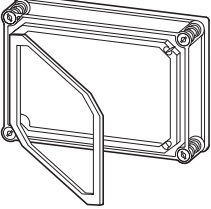
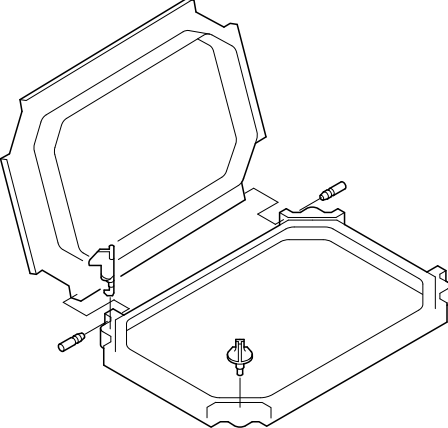

For use with	Dimensions		Mounting depth mm	Plug-in units Number of openings	For use with	Part no. Article no.	Price See price list	Std. pack	
	Width	Height							
	mm	mm							
Enclosure cover prepared for 16 to 125 A plug-in units									
<ul style="list-style-type: none"> For individual enclosures or in distribution boards For distribution board applications observe the characteristic data of the other apparatus. Cover with knockouts for standardized 5-pole plug-in units Plug-in units not included as standard Order plug-in units separately, e.g. from Mennekes Sealable cover fasteners For retrofitting for various lockable covers, order also DVZ...-CI Protection type IP44, gasket 									
	Schuko socket 16 A	187.5	250	125	3	U-CI23...	D125-CI23-RAL7032-STV3/16A 138545	4 off	
	Schuko socket 16 A	187.5	250	150	3	U-CI23...	D150-CI23-RAL7032-STV3/16A 138546	4 off	
	Schuko socket 16 A	375	250	125	8	U-CI43...	D125-CI43-RAL7032-STV8/16A 138547	2 off	
				150		U-CI43...	D150-CI43-RAL7032-STV8/16A 138548	2 off	
				200		U-CI43...	D200-CI43-RAL7032-STV8/16A 138549	2 off	
	CEE 16 A	375	250	125	3	U-CI43...	D125-CI43-RAL7032-STV3/16A 138550	2 off	
				150		U-CI43...	D150-CI43-RAL7032-STV3/16A 138551	2 off	
				200		U-CI43...	D200-CI43-RAL7032-STV3/16A 138552	2 off	
	CEE 32 A	375	250	125	3	U-CI43...	D125-CI43-RAL7032-STV3/32A 138553	2 off	
				150		U-CI43...	D150-CI43-RAL7032-STV3/32A 138554	2 off	
				200		U-CI43...	D200-CI43-RAL7032-STV3/32A 138555	2 off	
	CEE 63 A	375	250	125	3	U-CI43...	D125-CI43-RAL7032-STV3/63A 138556	2 off	
				150		U-CI43...	D150-CI43-RAL7032-STV3/63A 138557	2 off	
				200		U-CI43...	D200-CI43-RAL7032-STV3/63A 138558	2 off	
		CEE 125 A	375	250	125	2	U-CI43...	D125-CI43-RAL7032-STV2/125A 138559	2 off
					150		U-CI43...	D150-CI43-RAL7032-STV2/125A 138560	2 off
					200		U-CI43...	D200-CI43-RAL7032-STV2/125A 138561	2 off
	4 x Schuko sockets 16 A 2 x CEE 16 A 1 CEE 32 A	375	250	125	7	U-CI43...	D125-CI43-RAL7032-STV7/16-32A	2 off	
				150		U-CI43...	D150-CI43-RAL7032-STV7/16-32A	2 off	
				200		U-CI43...	D200-CI43-RAL7032-STV7/16-32A 138564	2 off	
	4 x Schuko sockets 16 A 2 x CEE 16 A 1 CEE 32 A	375	375	125	7	U-CI44...	D125-CI44-RAL7032-STV7/16-32A	2 off	
				150		U-CI44...	D150-CI44-RAL7032-STV7/16-32A	2 off	
				200		U-CI44...	D200-CI44-RAL7032-STV7/16-32A	2 off	
				250		U-CI44...	D250-CI44-RAL7032-STV7/16-32A	2 off	

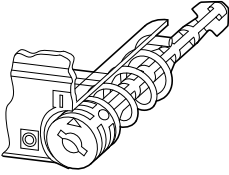
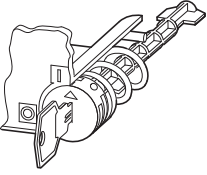
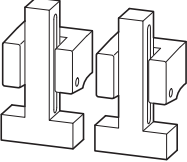

	Mounting depth mm	For use with	Part no. Article no.	Price See price list	Std. pack
Enclosure covers with door					
<ul style="list-style-type: none"> Protection type IP65 Transparent door, with quick-release fasteners and 180° door opening angle Door hinges can be subsequently changed to left, right, top or bottom. 					
	125	U-CI23...	D125-CI23/T 072476		10 off
	150	U-CI23...	D150-CI23/T 074849		4 off
	125	U-CI43...	D125-CI43/T 077222		2 off
	150	U-CI43...	D150-CI43/T 079595		2 off
	200	U-CI43...	D200-CI43/T 081968		2 off
	125	U-CI44...	D125-CI44/T 084341		2 off
	150	U-CI44...	D150-CI44/T 086714		2 off
	200	U-CI44...	D200-CI44/T 089087		2 off
	250	U-CI44...	D250-CI44/T 091460		1 off
Doors					
<ul style="list-style-type: none"> Protection type IP65 Door opening angle to 180° Door hinges can be subsequently changed to right, left, top or bottom. Adhesive film for marking the cutout Fixing screws Transparent 					
		CI23..., D...-CI23	T-CI23 093833		2 off
		CI43..., D...-CI43 CI45..., D...-CI45	T-CI43 096206		1 off
		CI44..., D...-CI44 CI48..., D...-CI48	T-CI44 098579		
	Hinged flaps				
<ul style="list-style-type: none"> For positioning on cover, change as required Protection type IP55 Opening angle to 180° Hinge on one side cannot be changed Transparent 					
		D...-CI... 145 x 80 mm	K-A 043372		
		D...-CI... 185 x 90 mm	KG-A 055244		

For use with	Mounting depth mm	Part no. Article no.	Price See price list	Std. pack	Information relevant for export to North America	
Cover						
<ul style="list-style-type: none"> • Transparent • Sealable cover fasteners • Gaskets 						
U-CI23...	125	D125-CI23-NA 014286		10 off 	Product Standards UL File No. UL CCN CSA File No. CSA Class No. NA Certification Specially designed for NA Suitable for UL 508A; CSA-C22.2 No.94; IEC/EN 60529; CE marking E54120, E337418 NITW 27130 3211-07 UL Listed, CSA certified Yes Refer to main component information	
	150	D150-CI23-NA 014334		4 off 		
U-CI43...	125	D125-CI43-NA 014433		5 off 		
	150	D150-CI43-NA 014480		2 off 		
	200	D200-CI43-NA 014771		2 off 		
U-CI44...	125	D125-CI44-NA 014838		5 off 		
	150	D150-CI44-NA 010937		2 off 		
	200	D200-CI44-NA 010985		2 off 		
	250	D250-CI44-NA 011049		1 off 		
U-CI45...	200	D200-CI45-NA 264022		2 off 		
U-CI48...	200	D200-CI48-NA 011878		1 off 		
	250	D250-CI48-NA 011906		1 off 		
Covers with door						
<ul style="list-style-type: none"> • Transparent • Protection type IP65 						
U-CI23...	125	D125-CI23/T-NA 012038		1 off 	Product Standards UL File No. UL CCN CSA File No. CSA Class No. NA Certification Specially designed for NA Suitable for UL 508A; CSA-C22.2 No.94; IEC/EN 60529; CE marking E54120, E337418 NITW 27130 3211-07 UL Listed, CSA certified Yes Refer to main component information	
	150	D150-CI23/T-NA 012097				
U-CI43...	125	D125-CI43/T-NA 012115				
	150	D150-CI43/T-NA 012147				
	200	D200-CI43/T-NA 012195				
U-CI44...	125	D125-CI44/T-NA 012335				
	150	D150-CI44/T-NA 012357				
	200	D200-CI44/T-NA 012780				
	250	D250-CI44/T-NA 012809				
U-CI48...	200	D200-CI48/T-NA 012842				
	250	D250-CI48/T-NA 012863				
	200	D200-CI48/2T-NA 012392				
	250	D250-CI48/2T-NA 012411				

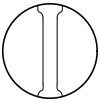
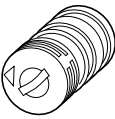

	For use with	Part no. Article no.	Price See price list	Std. pack
Cover fasteners for CI enclosures				
	CI23: 4 off CI43: 4 off CI44: 4 off	DV125-CI 001923		10 off
	CI23: 4 off CI43: 4 off CI44: 4 off CI45: 4 off CI48: 6 off	DV150-250-CI 001924		10 off
Cover fasteners with cylinder lock for CI enclosures¹⁾				
<ul style="list-style-type: none"> • Lockable cover fasteners with cylinder lock, uniform locking • Key 				
	CI23... max. 4 off CI43... max. 4 off CI44... max. 4 off	DVZ125-CI 133100		2 off
	CI23... max. 4 off CI43... max. 4 off CI44... max. 4 off CI45... max. 4 off CI48... max. 6 off	DVZ150-250-CI 133101		2 off
Set of cover hinges				
<ul style="list-style-type: none"> • For CI...E, CI...X individual enclosures • For CI... panel enclosure on the sides if a flange is not installed 				
	CI23: 1 set CI43: 1 set CI44: 1 set CI45: 1 set CI48: 1 set Each set consists of 2 hinges.	DSCH-CI 034224		5 off 
Handgrip				
<ul style="list-style-type: none"> • Quick-release fastener for opening enclosures manually • Higher cover in conjunction with the extension for the handle 				
	CI23(...)-125, 150: 4 off CI43(...)-125, 150: 4 off CI44(...)-125, 150: 4 off	HG-CI 046382		20 off
Extension for handle				
<ul style="list-style-type: none"> • Can be fitted to cover 				
	CI43-200/(D200-CI43): 4 off CI44-200/(D200-CI44): 4 off CI48-200/(D200-CI48): 6 off	VHG50-CI 044880		8 off
Sealing kit				
<ul style="list-style-type: none"> • At the top edge of cover with D200-... 				
	Use one set diagonally per enclosure. One set consists of 2 sealable locks.	PLV200-CI 044881		5 off

Notes

¹⁾ For sealing, use at least one cover fastener DV125-CI or DV150-250-CI.







Information relevant for export to North America



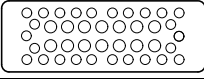
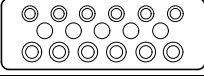
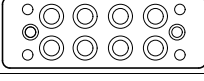
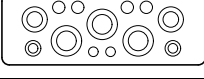

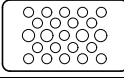
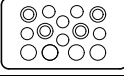
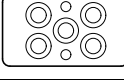
Product Standards	UL 508A; CSA-C22.2 No.94; IEC/EN 60529; CE marking
UL File No.	E54120, E337418
UL CCN	NITW
CSA File No.	27130
CSA Class No.	3211-07
NA Certification	UL Listed, CSA certified
Specially designed for NA	Yes
Suitable for	Industrial Control Panels
Degree of Protection	IEC: IP65; UL/CSA Types 1, 12, 13, 4X, indoor only



HPL20023EN



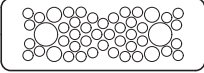
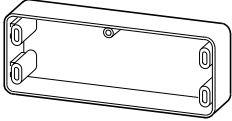
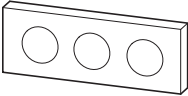
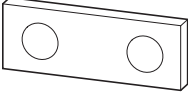
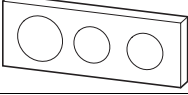
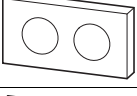

Cable entry	Part no. Article no.	Price See price list	Std. pack
Flanges			
<ul style="list-style-type: none"> • Captive, sponge-rubber gaskets • Quick mounting using wedge lock fasteners (included as standard) 			
For enclosure dimension 375 mm			
	Drill as required	FL4-X 024355	10 off
	26 x M16, 14 x M20	FL4-2 014863	
	5 x M25, 6 x M25/16, 6 x M32/20	FL4-3 017236	
	4 x M16, 2 x M25/16, 8 x M40/25	FL4-4 019609	
	2 x M16, 4 x M20, 2 x M25/16, 2 x M40/25, 3 x M50/32	FL4-5 021982	
For enclosure dimension 250 mm			
	Drill as required	FL3-X 093171	10 off
	18 x M16, 4 x M20	FL3-1 088425	
	6 x M20, 4 x M25, 4 x M25/16	FL3-2 090798	
	1 x M16, 5 x M40/25	FL3-3 022644	
For enclosure dimension 187.5 mm			
	Drill as required	FL2-X 086052	10 off
	10 x M16, 3 x M20	FL2-2 017898	
	6 x M20, 2 x M25/16	FL2-3 020271	
For enclosure dimension 125 mm			
	Drill as required	FL1-X 078933	10 off





	External diameter of cable mm	For use with	Part no. Article no.	Price See price list	Std. pack	
Sponge-rubber flange IP54						
<ul style="list-style-type: none"> Protection type IP54 For enclosure dimension 375 mm 						
	42 x 10 - 13 4 x 15 - 19 2 x 20 - 30	NY, NYM 3 x 1.5 mm ² - 5 x 2.5 mm ² NY, NYM 4 x 4 mm ² - 5 x 10 mm ² NY, NYM 4 x 10 mm ² - 4 x 50 mm ²	FL4-D 044879		10 off	
Spacers						
<ul style="list-style-type: none"> To enlarge the connection compartment by 25 mm 						
	–	For fitting to enclosure side, 250 mm for FL3-... flange	ZRF3 067734		2 off	
	–	For fitting to enclosure side, 375 mm for FL4-... flange	ZRF4 070107		2 off	
	For use with enclosure size	Plug-in units Number of openings	For use with	Part no. Article no.	Price See price list	Std. pack
Flanges prepared for Schuko or high-voltage sockets up to 32 A						
<ul style="list-style-type: none"> Flange non-transparent RAL7032 Captive, sponge-rubber gaskets Quick mounting using wedge lock fasteners (included as standard) Flanges milled out and predrilled for standardized 5-pole plug-in units Order plug-in units separately, e.g. from Mennekes Protection type IP44 						
	375 mm	3	Schuko sockets 16 A	FL4-STV3/16A 138569		2 off
	375 mm	2	Schuko sockets 16 A	FL4-STV2/16A 138570		
	375 mm	3	1 x CEE 32 A 2 x Schuko sockets 16 A	FL4-STV3/16-32A 138571		
	250 mm	2	Schuko sockets 16 A	FL3-STV2/16A 138572		
	250 mm	1	1 x CEE 16 A	FL3-STV/1/16A 138573		



HPL20025EN

For use with	Mounting depth mm	Part no. Article no.	Price See price list	Std. pack	Information relevant for export to North America
					
Doors					
<ul style="list-style-type: none"> • Protection type IP65 • Door opening angle 180° • Door hinges can be subsequently changed to left, right, top or bottom. • Adhesive film for marking the cutout • Fixing screws • Transparent 					
Mounting on all enclosure covers D...-CI23-NA		T-CI23-NA 011925		1 off 	Product Standards UL 508A; CSA-C22.2 No.94; IEC/EN 60529; CE marking E54120, E337418 UL File No. E54120, E337418 UL CCN NITW CSA File No. 27130 CSA Class No. 3211-07 NA Certification UL Listed, CSA certified Specially designed for NA Yes Suitable for Refer to main component information
Mounting on all enclosure covers D...-CI43-NA		T-CI43-NA 011957			
Mounting on all enclosure covers D...-CI44-NA and D...-CI48-NA		T-CI44-NA 012001			
					
For use with enclosure size		Part no. Article no.	Price See price list	Std. pack	Information relevant for export to North America
Flanges					
187.5 mm		FL2-X-NA 208310		10 off 	Product Standards UL 508A; CSA-C22.2 No.94; IEC/EN 60529; CE marking E54120, E337418 UL File No. E54120, E337418 UL CCN NITW CSA File No. 27130 CSA Class No. 3211-07 NA Certification UL Listed, CSA certified Specially designed for NA Yes Suitable for Refer to main component information
250 mm		FL3-X-NA 012462			
375 mm		FL4-X-NA 208309			
Spacers					
For enlarging the cable entry space, in conjunction with flange FL3-X-NA		ZRF3-NA 012479		2 off 	Product Standards UL 508A; CSA-C22.2 No.94; IEC/EN 60529; CE marking E54120, E337418 UL File No. E54120, E337418 UL CCN NITW CSA File No. 27130 CSA Class No. 3211-07 NA Certification UL Listed, CSA certified Specially designed for NA Yes Suitable for Refer to main component information

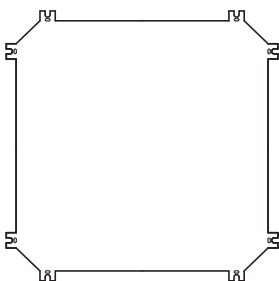

	For use with	Thread	Part no. Article no.	Price See price list	Std. pack
Mounting plates					
Including 4 captive fixing screws					
Galvanized steel, 3 mm thick					
	CI23	–	M3-CI23 019709		5 off
	CI43...: 1 x CI45...: 2 x	–	M3-CI43 029201		
	CI44	–	M3-CI44 031574		
	CI45	–	M3-CI45 003036		
	CI48	–	M3-CI48 036320		
Glass-fibre reinforced insulating material, 4 mm thick					
Devices are secured using hank nuts					
	CI23	–	IM4-CI23 086081		5 off
	CI43...: 1 x CI45...: 2 x	–	IM4-CI43 088454		
	CI44	–	IM4-CI44 090827		
	CI48	–	IM4-CI48 093200		
Hank nuts for insulating material mounting plate					
		M4	EM4-CI 002293		100 off
	–	M5	EM5-CI 002294		
	–	M6	EM6-CI 002295		

Notes

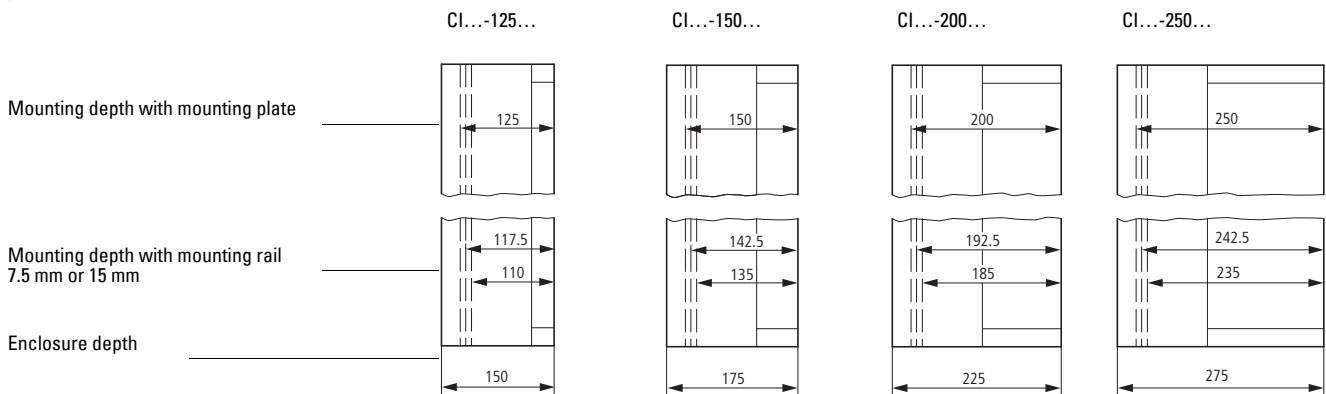

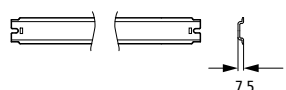
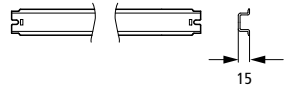
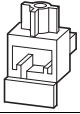
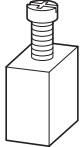
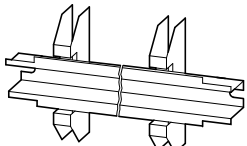

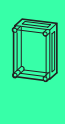
For use with	Part no. Article no.	Price See price list	Std. pack
Module mounting rail			
<ul style="list-style-type: none"> Useful length 330 mm for enclosure dimension 375 mm Galvanized steel, 3 mm thick Including fixing screws 			
	Horizontal CI43 CI44 CI45 CI48 Vertical CI44	ML4 041069	10 off
Mounting rails according to IEC/EN 60715			
<ul style="list-style-type: none"> Galvanized sheet steel Including 2 captive fixing screws 			
Height 7.5 mm			
	Useful length 145 mm for enclosure dimension 187.5 mm	CL2 029064	20 off
	Useful length 207 mm for enclosure dimension 250 mm	CL3 033810	
	Useful length 332 mm for enclosure dimension 375 mm	CL4 038556	
Height 15 mm			
	Useful length 145 mm for enclosure dimension 187.5 mm	CL2-15 031437	10 off
	Useful length 207 mm for enclosure dimension 250 mm	CL3-15 036183	
	Useful length 332 mm for enclosure dimension 375 mm	CL4-15 040929	
Accessories for mounting systems			
Spacers <ul style="list-style-type: none"> For raising the mounting systems (4 off required for mounting plate, 2 off required for mounting rail) 			
	by 25 mm	HS25-CI 002291	25 off
	by 50 mm	HS50-CI 002292	25 off
	by 10 mm	ADT200-190 002289	10 off
	by 15 mm	ADT125-110 002290	10 off
Captive screw <ul style="list-style-type: none"> For fixing the mounting systems Spare parts 			
-	Mounting plates, pre-drilled mounting plates, mounting rails, module mounting rails	UBS4.8 002288	25 off
Mounting rail support			
	CL4-15 Weight without TS... ≤ 4 kg, with TS... ≤ 10 kg, without TS... with HS25... ≤ 3 kg, without TS... with HS50... ≤ 1.5 kg	TSCL4-15 098480	10 off

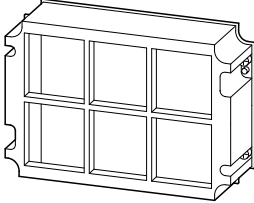
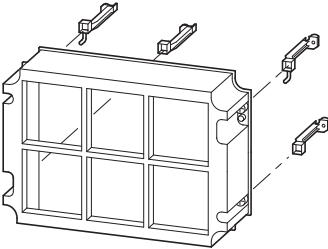
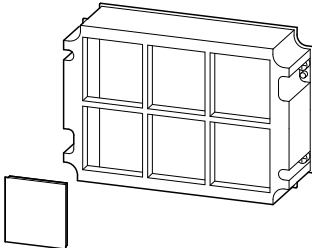
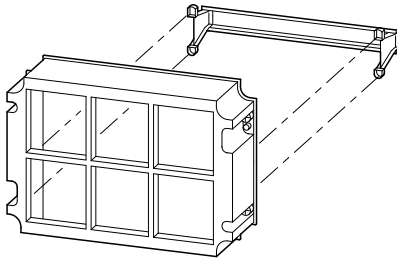



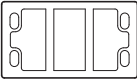

	For use with	Part no. Article no.	Price See price list	Std. pack
Meter covers				
In CI43E-200, CI44E-250 enclosures For up to six 96 × 96 mm snap-on metering devices. The meter shroud is secured using AH-GA support brackets.				
	CI43E-200, CI44E-200 enclosures	GA-MS-I43 053502		1 off
	CI44E-250 enclosure	GA-MS-I44 055875		1 off
Set of support brackets				
	For meter and protective shrouds (order meter shroud GA-MS-I43 separately). Each set consists 4 brackets.	AH-GA 002305		10 off
Retaining frame				
	To cover unused spaces: Also required as an adapter with snap-on 72 × 72 mm meters and when fitting PKZM0 (voltmeters) as well as T0-... (meter changeover switch). (Order GA-MS-I43 meter shroud separately)	HBA-4344 002316		10 off
Fixing kits				
	For mounting up to two PKZM0, T0 Fitting parallel to 250 mm side of the enclosure. (Order GA-MS-I43 meter shroud separately)	BFS-PT3 002317		5 off
	For mounting up to three PKZM0, T0 Fitting parallel to 375 mm side of the enclosure. (Order GA-MS-I43 meter shroud separately)	BFS-PT4 002318		5 off

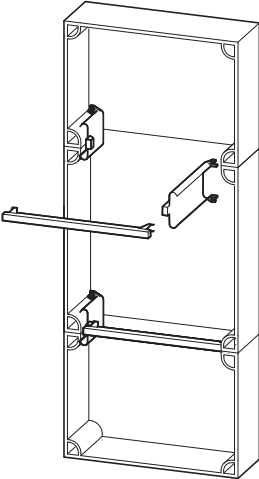
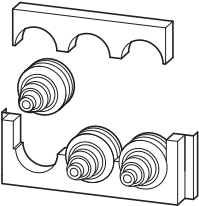

HPL20029EN

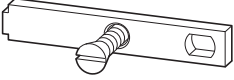
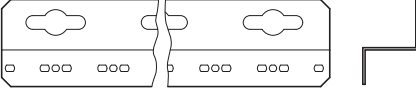
	For use with For use with enclosure size	Part no. Article no.	Price See price list	Std. pack
Connection kits				
Insulating wedge-lock fastener for connecting the enclosures with each other				
	187.5 mm	BS2-CI 090750		10 off
	250 mm 500 mm Use two off	BS3-CI 097869		
	375 mm 750 mm Use two off	BS4-CI 014815		
Flange adapters				
For connecting enclosures with sides of different lengths				
	-	FT-CI 002319		10 off
Cross strut kits				
Enables fitting of cables or busbars from the front				
	250 mm	STB3-CI 219217		1 off
	375 mm	STB4-CI 034223		1 off
Stepped cable grommets				
Enables fitting of cables or busbars from the front				
	250 mm For 2 cables of 14 – 54 mm	KS3-CI 057621		1 off
	375 mm For 3 cables of 14 – 68 mm	KS4-CI 062367		1 off

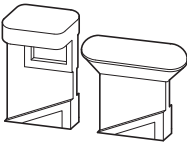
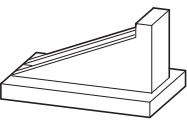

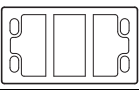
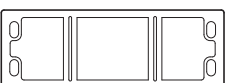
	For use with	Part no. Article no.	Price See price list	Std. pack
Fixing strap kits				
<ul style="list-style-type: none"> For securing CI enclosures directly to the wall For max. 4 CI43... enclosures 				
	Each set contains 4 straps.	BL-CI 036168		5 off
	Steel type V2A Each set contains 4 straps.	BL-CI-VA 038541		5 off
Wall fixing bracket				
<ul style="list-style-type: none"> For securing CI enclosures directly to the wall with a clearance of 50 mm Fit one wall fixing bracket to every second enclosure across the width, for transport purposes add more brackets at the bottom 				
	Section length 2125 mm, cut to fit.	W16/32 090146		1 off
	Max. 2 × CI43 one above the other	W4/8 048755		
	Max. 2 × CI44 one above the other	W6/12 051128		
	Max. 4 × CI43 one above the other	W8/16 053501		
	Max. 5 × CI43 one above the other	W10/20 055874		
Fixing screw				
	For securing CI enclosures to wall fixing brackets W... For fixing CI enclosures on WS..., WW... profiles	LT284-M6X20-C 050325		100 off
Coupling piece				
	Enclosure assembly and flange connection, K-CI required	VS-CI 002315		100 off
	For attaching gland plates, K-CI required	VS-KS-CI 038460		25 off
Wedge				
	With VS-CI or VS-KS-CI for enclosure assembly and attaching flanges and gland plates	K-CI 002314		100 off
Bracket				
	Enclosure assemblies, enclosure dimension 375 mm	KD4-CI 002313		25 off
Gaskets				
For enclosure assembly				
	Enclosure dimension 187.5 mm	D2-CI 002310		20 off
	Enclosure dimension 250 mm	D3-CI 002311		
	Enclosure dimension 375 mm	D4-CI 002312		



HPL20031EN

AE/I...

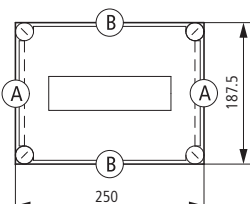
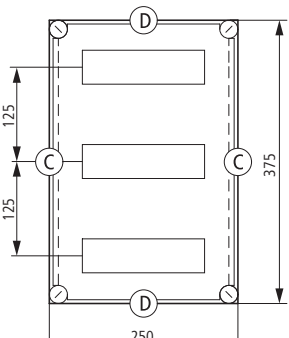
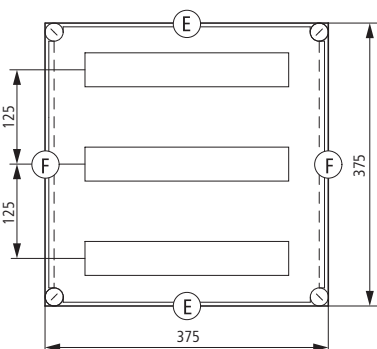
Dimensions mm	Single-pole miniature circuit-breakers (space unit)	PE and N terminals Number x cross-section	Model		Part no. Article no.	Price See price list	Std. pack
	Number	mm ²	Type cover	Type door			
	9	On each 2 x (6 - 16) On each 7 x (1 - 4)	Transparent	–	AE/I23E 029766		1 off
	9	On each 2 x (6 - 16) On each 7 x (1 - 4)	–	Transparent			
	27	On each 4 x (6 - 35) On each 20 x (1 - 4)	Transparent	–	AE/I43E 000239		
	27	On each 4 x (6 - 35) On each 20 x (1 - 4)	–	Transparent	AE/I43E/T 002612		
	45	On each 4 x (6 - 35) On each 20 x (1 - 4)	Transparent	–	AE/I44E 004985		
	45	On each 4 x (6 - 35) On each 20 x (1 - 4)	–	Transparent	AE/I44E/T 061937		

Notes



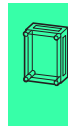
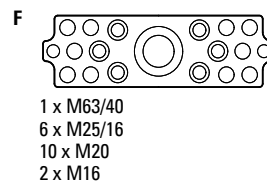
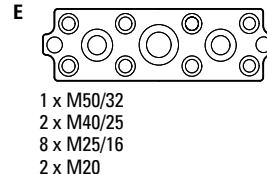
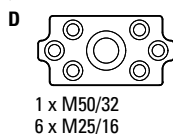
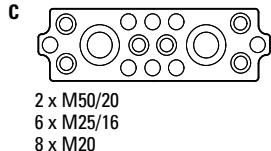
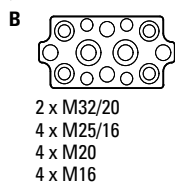
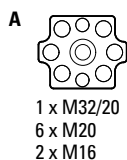

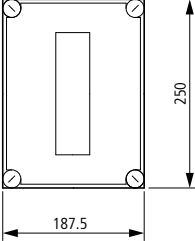
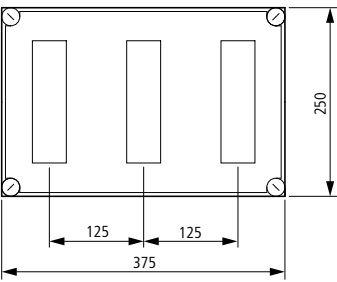
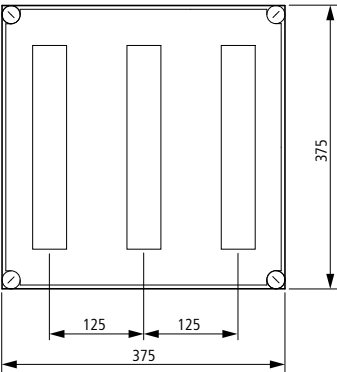
--- PE/N bars

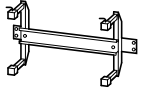
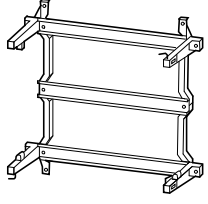
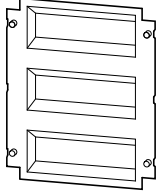
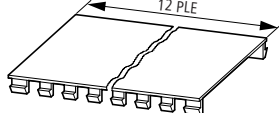

Dimensions mm	Enclosure depth mm	Single-pole miniature circuit-breakers (space unit) Number	Part no. Article no.	Price See price list	Std. pack
Enclosures for miniature circuit-breakers					
<ul style="list-style-type: none"> Sides closed, but with full area knockout, open top and bottom Protection type IP65 For flush mounting devices with size 1 to DIN 43880 Transparent cover with quick-release fasteners Mounting rails for snap-fitting the devices Blanking strip for unused locations, protective shroud with inscription label Fixing straps for wall mounting, cover fasteners can be sealed 					
	150	9	AV/I23-125 036089		1 off
	175	9	AV/I23-150 043208		
	150	27	AV/I43-125 047954		
	225	27	AV/I43-200 045581		
	150	45	AV/I44-125 059819		
	225	45	AV/I44-200 062192		



	For use with	Part no. Article no.	Price See price list	Std. pack	Notes
Mounting rail supports					
One row					
	CI23	TG23 044004		1 off	162 mm busbar lengths For 9 space units
Three rows					
	CI43	TG43 046377		1 off	162 mm busbar lengths for 3 x 9 space units
	CI44	TG44 048750		1 off	270 mm busbar lengths for 3 x 15 space units
Protective shroud					
Busbar tag shroud with inscription label					
	TG23	GA-0/I23 051123		5 off	-
	TG43	GA-0/I43 053496			-
	TG44	GA-0/I44 055869			-
Blanking strips					
For blanking off unused locations					
	GA-0/I...	VST12 002322		10 off	For 12 space units

	PE and N terminals Quantity x Cross-section mm ²	Gauge pin IEC/EN 60947-1	For use with	Part no. Article no.	Price See price list	Std. pack
N bars						
	2 x 6 - 35	B8, A3	TG23	N23AE 058242		1 off
	7 x 1 - 4					
	4 x 6 - 35	B8, A3	TG43	N434AE 060615		1 off
	20 x 1 - 4					
PE (PEN) bars						
	4 x 6 - 35	B8, A3	TG43	PEN434AE 062988		1 off
	20 x 1 - 4					
	2 x 6 - 35	B8, A3	TG23	PEN23AE 065361		1 off
	7 x 1 - 4					



Enclosures for circuit-breakers, switch-disconnectors

MCCB1-..., MCCB2-...

HPL20034EN

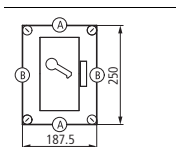
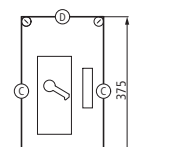
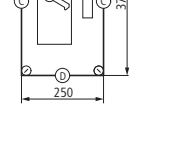
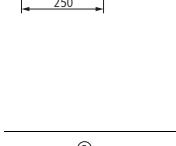
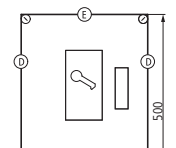
	Rated uninterrupted current I_u A	Can be used for basic device	Can be used with terminals ²⁾	Basic enclosure	Part no. Article no.	Price See price list	Std. pack
Enclosures for NZM... circuit-breakers/N... switch-disconnectors, 3- and 4-pole							
<ul style="list-style-type: none"> For use as individual enclosures¹⁾ or in distribution boards For distribution board applications observe the characteristic data of other apparatus. Protection type IP65, when enclosures closed throughout Metric cable entry knockouts in all sides. Exception: CI48...: Side panels without knockouts, open at bottom Sidewalls with knockouts; can be grouped with other devices With door coupling rotary handle NZM...-XTVD and extension shaft Transparent cover, predrilled Mounting plate predrilled for switches and one PE and N terminal each Mounting plate, 3 mm sheet steel Sealable cover fasteners Fixing material for fixing material Fixing strap BL-CI Can not be combined with remote operator NZM...-XR, plug-in unit NZM...-XSV or withdrawable unit NZM...-XAV. Rated operating voltage 690 V AC 							
	63	NZM1(-4) N1(-4) N(S)1(-4)	K10/1 K25/1 K50/1 K95/1N...	CI23E-150	MCCB1-63/I23E-150 138538		1 off
	125	NZM1(-4) N1(-4) N(S)1(-4)	K10/1 K25/1 K50/1 K95/1N...	CI43E-150	MCCB1-125/I43E-150 138539		
	160	NZM1(-4) N1(-4) N(S)1(-4)	K10/1 K25/1 K50/1 K95/1N...	CI43E-200	MCCB1-160/I43E-200 138540		
	200	NZM2(-4) N2(-4) N(S)2(-4)	K10/1 K25/1 K50/1 K95/1N... K150/1N...	CI43E-200	MCCB2-200/I43E-200 138541		
	250	NZM2(-4) N2(-4) N(S)2(-4)	K10/1 K25/1 K50/1 K95/1N... K150/1N...	CI45E-200	MCCB2-250/I45E-200 138542		



HPL20035EN

MCCB3-...

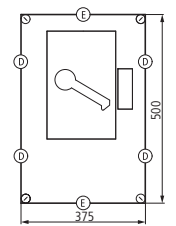
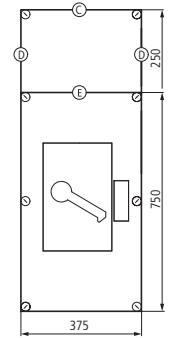
	Rated uninterrupted current I_u A	Can be used for basic device	Can be used with terminals ²⁾	Basic enclosure	Part no. Article no.	Price See price list	Std. pack
	400	NZM3(-4) N3(-4) N(S)3(-4)	K50/1 K95/1N... K150/1N... K240/1N...	CI45E-200	MCCB3-400/145E-200 138543		1 off
	630	NZM3(-4) N3(-4) N(S)3(-4)	K50/1 K95/1N... K150/1N... K240/1N... K2X240/1N...	CI combination of CI48-200 + CI43E-200 + STB4-CI	MCCB3-630/148/143E-200 138544		

Notes

- ¹⁾ Order insulated additional terminal for fourth or fifth pole separately → Chapter 16, Accessories for control panels
- ²⁾ Observe short-circuit values of individual enclosures → Chapter 17: Compact circuit-breakers NZM, compact switch-disconnectors N up to 1600 A

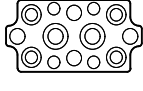
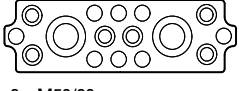
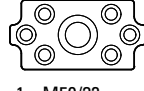
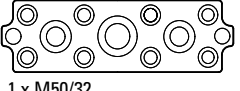
<p>A</p>  <p>1 x M32/20 6 x M20 2 x M16</p>	<p>B</p>  <p>2 x M32/20 4 x M25/16 4 x M20 4 x M16</p>	<p>C</p>  <p>2 x M50/20 6 x M25/16 8 x M20</p>	<p>D</p>  <p>1 x M50/32 6 x M25/16</p>	<p>E</p>  <p>1 x M50/32 2 x M40/25 8 x M25/16 2 x M20</p>
---	--	--	--	---



Dimensions	Enclosure depth: dimensions from top: 1. Meter rail 2. Enclosure depth	Type cover	Part no. Article no.	Price See price list	Std. pack
mm	mm				
Meter enclosures , meter rail					
<ul style="list-style-type: none"> • Metric cable entry knockouts in all sides (exception: ZG/I48-200) • Protection type IP65 • Cover/door transparent • ZG/I48-200 top and bottom with full area knockouts for FL4... flange • Meter rail to DIN 43853 including meter fixing screws and nuts • Fixing straps for wall fixing • Sealable fasteners at the top edge of the cover 					
		Transparent	ZG/I43E-G-150 013151		1 off
		Transparent	ZG/I43E-G-200 015524		
		Transparent	ZG/I44E-150 017897		
		Transparent	ZG/I44E-200 020270		



HPL20037EN

Dimensions	Enclosure depth: dimensions from top: 1. Meter rail 2. Enclosure depth	Type cover/ Type door	Part no. Article no.	Price See price list	Std. pack
mm	mm				
Meter enclosures , meter rail					
		Transparent Transparent	ZG/I45E-200-T 090145 ZG/I45E-200 098479		1 off
		Transparent	ZG/I48-200 022643		
Meter rail					
	-	To DIN 43853, including three counter fixing bolts with nuts to DIN 46300. For fitting on mounting plates, sealing → Page 20/22 → Page 20/26	ZK1 001892		5 off

Notes

C

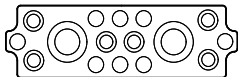

- 2 x M50/20
- 6 x M25/16
- 8 x M20

D

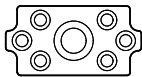

- 1 x M50/32
- 6 x M25/16

E

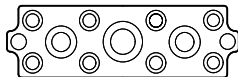

- 1 x M50/32
- 2 x M40/25
- 8 x M25/16
- 2 x M20

F

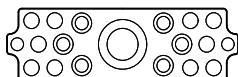

- 1 x M63/40
- 6 x M25/16
- 10 x M20
- 2 x M16

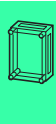

Distribution board terminal enclosure

K...KST

HPL20038EN

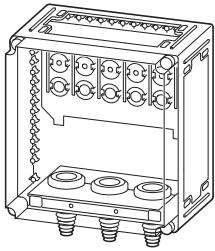

Distribution board terminal enclosure

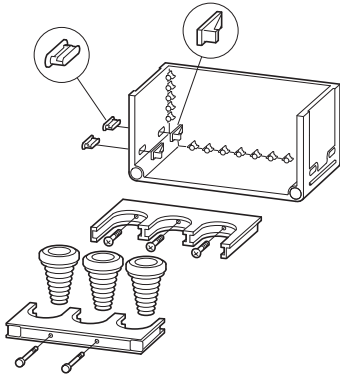

- Distribution board enclosure with terminals and fitted gland plate
- External connection for round and solid sector conductors, internal for copper strip, conversion kits to round and solid sector conductors → Chapter 16: Accessories for control panels
- Large knockouts at top, and apertures for wedge-lock fasteners
- Closed side walls with full area knockouts
- Fitting of cable supports in the distribution board with wedge-lock fastener
- Protection type IP65 (gland plates at bottom)



- Stepped cable grommet
- Split gland plate
- Cables can be inserted from the front
- Enclosure KST... with fitted gland plate
- Subsequent conversion of CI distribution board enclosures and CI individual enclosures possible

	Rated uninterrupted current I_u	Pole	Enclosure depth	Terminal capacity (stranded conductors) mm ² Strip terminal (max.) mm	Basic enclosure Mounting system Devices (Number)	Part no. Article no.	Price See price list	Std. pack
	A		mm	mm ²				
	160	4	225	1 x 16...95 6 x 9 x 0.8	KST34-200 L5-CI43 K95/... (4 or 5)	K95/4/KST34 025031		1 off
		5				K95/5/KST34 027404		
	250	4	225	1 x 35...150 2 x 16...70 6 x 16 x 0.8	KST34-200 L5-CI43 K150/... (4 or 5)	K150/4/KST34 029777		1 off
		5				K150/5/KST34 032150		
	160	4	225	1 x 16...95 6 x 9 x 0.8	KST43-200 L5-CI43 K95/... (4 or 5)	K95/4/KST43 041642		1 off
		5				K95/5/KST43 039269		
	250	4	225	1 x 35...120 2 x 16...70 6 x 16 x 0.8	KST43-200 L5-CI43 K150/... (4)	K150/4/KST43 034523		1 off
		5				K150/5/KST43 034523		
	400	4	225	1 x 50...240 2 x 25 x 120 10 x 16 x 0.8	KST44-200 L5-CI43 K240/... (4 or 5)	K240/4/KST44 044015		1 off
		5				K240/5/KST44 046388		

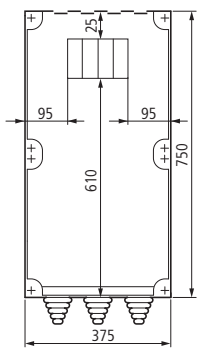
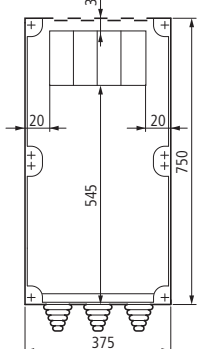
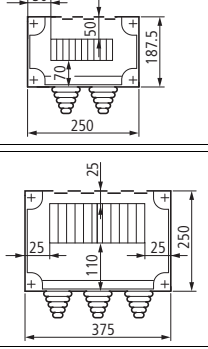
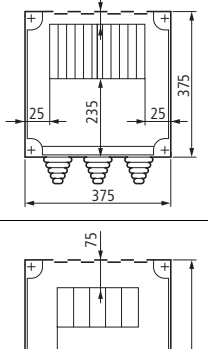
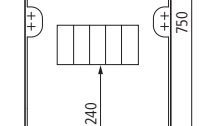
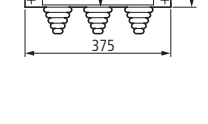

	Rated uninterrupted current I_u	Pole	Enclosure depth	Terminal capacity (stranded conductors) mm ² Strip terminal (max.) mm	Basic enclosure Mounting system Devices (Number)	Part no. Article no.	Price See price list	Std. pack
A			mm	mm ²				
	400	4	225	1 x 50...240 2 x 25 x 120 10 x 16 x 0.8	KST48-200 L5-CI43 K240/... (4 or 5)	K240/4/KST48 048761		1 off
		5						
	630	4	225	1 x 150...300 2 x 50 x 240 11 x 21 x 1.0	KST48-200 L5-CI43 K2x240/... (4 or 5)	K2X240/4/KST48 055880		
		5						
	800	4	225	2 x 120...240 3 x 50 x 185 2 x (21 x 11 x 1)	KST48-200 L5-CI43 K3x185/4	K3X185/4/KST48 058253		
	1000	4	225	2 x 150...300 3 x 50...240 50 x 12	KST48-200 L5-CI43 K3x240/4	K3X240/4/KST48 060626		
	2 x 100	2 x 4	175	1 x 16...50 3 x 9 x 0.8	CI23E-150 L3/5-CI23 K50/1	2K50/4/KST32 067745		
		2 x 5						
	2 x 160	2 x 4	225	1 x 16...95 6 x 9 x 0.8	KST43-200 L3/5-CI23 K95/... (4 or 5)	2K95/4/KST43 074864		
		2 x 5						
	2 x 250	2 x 4	225	1 x 35...150 2 x 16x70 6 x 16 x 0.8	KST44-200 L5-CI43 K150/... (4 or 5)	2K150/4/KST44 077237		
		2 x 5						
	2 x 400	2 x 4	275	1 x 50...240 2 x 25 x 120 10 x 16 x 0.8	KST48-200 L5-CI43 K240/... (4 or 5)	2K240/4/KST48 062999		
		2 x 5						



Dimensions mm	Rated operational current I_e A	Features	Copper factor ¹⁾	Part no. Article no.	Price See price list	Std. pack
Busbar enclosures						
<ul style="list-style-type: none"> • Protection type IP65 • Transparent cover • Top and bottom with full area knockouts • Sides closed, but with full area knockout • Fixing straps for wall fixing • Sealable cover fasteners • Enclosure depth 225 mm • 50 mm between busbar centres 						
	250	L1, L2, L3, PEN		SKA254-144 034221		1 off
	400	L1, L2, L3, PEN		SKA404-144 034220		
	630	L1, L2, L3, PEN		SKA634-144 090135		
	250	L1, L2, L3, PE, N		SKA255-144 034209		
	400	L1, L2, L3, PE, N		SKA405-144 034208		
	630	L1, L2, L3, PE, N		SKA635-144 090138		
	250	L1, L2, L3, PEN		SKA254-2144 034207		1 off
	400	L1, L2, L3, PEN		SKA404-2144 034204		
	630	L1, L2, L3, PEN		SKA634-2144 090141		
	250	L1, L2, L3, PE, N		SKA255-2144 034203		
	400	L1, L2, L3, PE, N		SKA405-2144 034202		
	630	L1, L2, L3, PE, N		SKA635-2144 090144		
Busbar coupling kits						
Including sealing and fixing material						
	250 - 630	L1, L2, L3, PE, N		SVS250630-5 002066		1 off
	1000	L1, L2, L3 for copper busbars 2 × 30 × 10 mm		AVS30L 093842		3 off
	500	PE, N, PEN for copper busbar 30 × 10 mm		AVS30PEN 096215		2 off
	1600	L1, L2, L3 for copper busbars 3 × 40 × 10 mm		AVS40 098588		3 off

Notes

¹⁾ Calculation of additional material cost → Page 23/2

Selection of busbar cross-section and usable device → Page 20/73

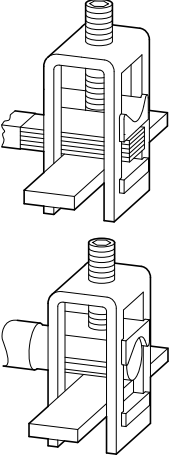
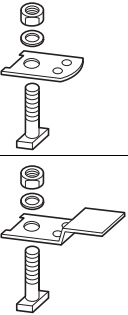

	For use with busbars mm	Terminal capacity for flat strip mm	Operating current of the flat strip I_e A	Terminal capacity Round conductor mm ²	Part no. Article no.	Price See price list	Std. pack	Notes		
Busbar terminals										
For connection of flat strip or round conductor										
	Cu 12 x 5	3 x 9 x 0.8	100	⊖ 16 - 35 ⊕ 16 - 25	K12X5-1 002281		10 off			
	Cu 12 x 5	3 x 9 x 0.8 10 x 16 x 0.8	100 400	⊖ 25 - 120 ⊕ 25 - 95	K12X5-2 002282					
	Cu 20 x 5	3 x 9 x 0.8 6 x 9 x 0.8 4 x 16 x 0.8 6 x 16 x 0.8	100 160 200 250	⊖ 35 - 70 ⊕ 35 - 50	K20X5 002286					
	Cu 20 x 5	3 x 9 x 0.8 6 x 9 x 0.8 4 x 16 x 0.8 6 x 16 x 0.8 10 x 16 x 0.8 11 x 21 x 1	100 160 200 250 400 630	⊖ 35 - 240 ⊕ 35 - 185	K20X10 002283					
	Cu 20 x 10	3 x 9 x 0.8 6 x 9 x 0.8 4 x 16 x 0.8 6 x 16 x 0.8 10 x 16 x 0.8 11 x 21 x 1	100 160 200 250 400 630	⊖ 35 - 185 ⊕ 35 - 95						
	Cu 20 x 15	3 x 9 x 0.8 6 x 9 x 0.8 4 x 16 x 0.8 6 x 16 x 0.8 10 x 16 x 0.8 11 x 21 x 1	100 160 200 250 400 630	⊖ 35 - 70 ⊕ 35 - 50						
	Cu 20 x 10-15	3 x 9 x 0.8	100	⊖ 35 - 300	K20X15					
	Cu 20 x 5-15	11 x 21 x 1	630	⊕ 35 - 240	002284					
	Connection for flat strip and copper busbar									
		Cu 2 x 30 x 10	2 x 50 x 12	–	–	K30X10L 081977			3 off	For main conductor L1, L2, L3
Cu 1 x 30 x 10		50 x 12	–	–	K30X10PEN 084350		2 off	For protective or neutral conductor PE, N, PEN		
Cu 3 x 40 x 10		2 x 50 x 12	–	–	K40X10 086723		3 off	For main conductor L1, L2, L3		
Cu 1 x 30 x 10		3 x 9 x 0.8 - 11 x 21 x 1	100 630	–	AW3040L-K20 089096		5 off	In combination with busbar terminals K20X5, K20X10, K20X15		
Cu 2 x 30 x 10 Cu 2 x 40 x 10		3 x 9 x 0.8 - 11 x 21 x 1	100 630	–	AW30PEN-K20 091469		5 off	In combination with busbar terminals K20X5, K20X10, K20X15		

Notes

- 1) Terminal capacity:
 ⊖ solid
 ⊕ stranded
 ⊕ flexible with ferrule
 Terminals AK... → Chapter 16, Accessories for control panels

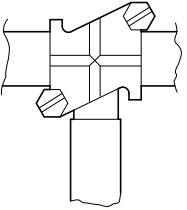

	For use with busbars	Terminal capacity for flat strip	Operating current of the flat strip I_e	Terminal capacity for round conductor ¹⁾	Part no. Article no.	Price See price list	Std. pack
	mm	mm	A	mm ²			
	Cu 12 x 5	3 x 9 x 0.8 6 x 9 x 0.8 4 x 16 x 0.8 6 x 16 x 0.8	100 160 200 250	○ 1.5 - 10 ⊗ 1.5 - 6	K12X5/25 002324		10 off
	Cu 20 x 5	3 x 9 x 0.8 6 x 9 x 0.8 4 x 16 x 0.8 6 x 16 x 0.8	100 160 200 250	○ 1.5 - 10 ⊗ 1.5 - 6	K20X5/25 002327		10 off
	Cu 20 x 5 Cu 20 x 10	3 x 9 x 0.8 6 x 9 x 0.8 4 x 16 x 0.8 6 x 16 x 0.8 10 x 16 x 0.8	100 160 200 250 400	○ 1.5 - 10 ⊗ 1.5 - 6	K20X10/35 002325		10 off
	Cu 20 x 5 Cu 20 x 10	3 x 9 x 0.8 6 x 9 x 0.8 4 x 16 x 0.8 6 x 16 x 0.8 10 x 16 x 0.8	100 160 200 250 400	○ 1.5 - 10 ⊗ 1.5 - 6	K20X15/40 002285		10 off
	Cu 20 x 10 Cu 20 x 15	3 x 9 x 0.8 6 x 9 x 0.8 4 x 16 x 0.8 6 x 16 x 0.8 10 x 16 x 0.8 11 x 21 x 1	100 160 200 250 400 630	○ 1.5 - 10 ⊗ 1.5 - 6	K20X15/40 002285		10 off
	Cu 20 x 15	11 x 21 x 1 2 x (11 x 21 x 1)	630 800	○ 1.5 - 10 ⊗ 1.5 - 6	K20X15/50 002326		5 off

Notes

- ¹⁾ Terminal capacity:
○ solid
⊗ stranded
⊗ flexible with ferrule



HPL20043EN

SH0...

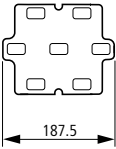
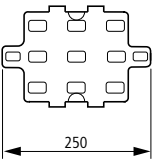
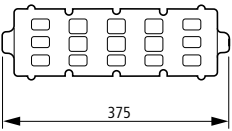
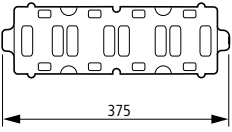
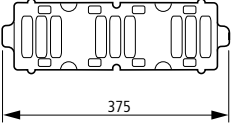
	Rated operational current I_e A	For use with	Part no. Article no.	Price See price list	Std. pack
Busbar support					
For use between two enclosures					
<ul style="list-style-type: none"> • Component mounting possible on busbar, → Page 20/46 • Interval between busbar supports max. 375 mm 					
Interval between busbar centres 40 mm					
	160	L1, L2, L3, PE, N: 12 x 5	SH0165/2 010774		5 off
Interval between busbar centres 50 mm					
	250 400 630	L1, L2, L3, PE, N: 20 x 5 L1, L2, L3: 20 x 10; PE, N, PEN: 20 x 5 L1, L2, L3, PE, N: 20 x 15	SH0635/3 058247		5 off
	250 400 630	L1, L2, L3, PE, N, PEN: 20 x 5 L1, L2, L3: 20 x 10; PE, N, PEN: 20 x 5 L1, L2, L3: 20 x 10 + 20 x 5; PE, N, PEN: 20 x 10	SH0635/4 060620		
	1000	L1, L2, L3: 2 x 30 x 10; PE, N: 30 x 10	SH1005/4 062993		
	1600	L1, L2, L3: 3 x 40 x 10	SH1603/4 065366		

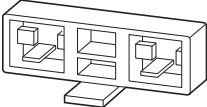
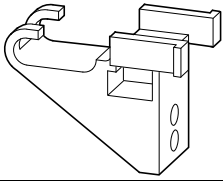
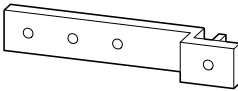

	Rated operational current I_e A	Supplied in lengths of mm	For use with	Copper factor	Dimensions mm	Part no. Article no.	Price See price list	Std. pack
Busbars								
Flat copper busbars								
Tinned	160	1500	SH0165/2		12 x 5	CU12X5 034121		10 off
Tinned	160	2250	SH0165/2		12 x 5	CU12X5-2250 005093		10 off
Tinned	250	1500	SH0635/3		20 x 5	CU20X5 044092		10 off
Tinned	250	2250	SH0635/4 SH0632		20 x 5	CU20X5-2250 007466		10 off
Tinned	400	1500	SH0635/3		20 x 10	CU20X10 041719		5 off
Tinned	400	2250	SH0635/4 SH0632		20 x 10	CU20X10-2250 009839		5 off
Untreated	–	1500	SH1005/4		30 x 10	CU30X10 051211		1 off
Untreated	–	1500	SH1603/4		40 x 10	CU40X10 063076		3 off
PE/N busbar supports								
For relocating PE/N bars from the busbar enclosure to the terminal compartment (floor-standing distribution boards)								
	250 400 630	–	–		20 x 5 20 x 10 20 x 15	SH0632 067739		5 off
Support bracket for busbar supports								
To secure busbar supports in the first and last enclosures when using busbar links and transport splits								
	–	–	SH0635/...		–	HSH-CI 002320		5 off
	–	–	SH0165/2 to SH0632		–	HSH0632 002321		5 off

Notes

Calculation of additional material cost → Page 23/2







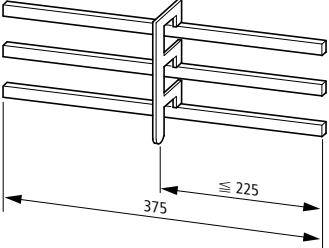
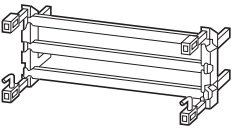
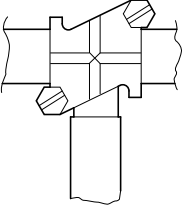



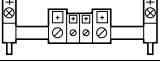

Selection of busbar cross-section and usable device → Page 20/73

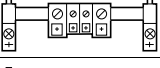

HPL20045EN

	For use with	Part no. Article no.	Price See price list	Std. pack	Notes
Busbar bracing					
Fitting in the centre between two SH0635/... busbar supports when fitting RS...3-50 busbar mounting fuses on 20 x 5 copper busbars					
	—	SVCU20X5 002323		10 off	—
Busbar assemblies					
<ul style="list-style-type: none"> For mounting busbar mounting fuse bases 3 pole, for 250 A rated operational current 					
	CI23	SE-RS-I23 041632		1 off	Set of connecting links → Page 20/47
	CI43	SE-RS-I43 044005			
	CI44	SE-RS-I44 001890			
Cross terminal					
For fuse enclosure and busbar fuse enclosures as well as SE-RS-I43 busbar assemblies					
	CU20X5 CU20X10 CU20X15	K20X15/40-A 012783		10 off	Terminal capacity for flat strip: from 3 x 9 x 0.8 mm Up to 10 x 16 x 0.8 mm Ø 4 - 10 mm ² (solid)
Notes					
LV h.b.c. fuse switch-disconnector, Insulating surround → Chapter 19: Circuit-breakers, fuses Busbar mounting fuse bases, covers for busbar mounting fuse bases → Online Catalog					



	Conductor cross section		For use with	Part no. Article no.	Price See price list	Std. pack
	solid mm ²	stranded mm ²				
N bars						
	2 x 2.5 - 35 6 x 1.5 - 16	2 x 2.5 - 25 6 x 1.5 - 16	SE-RS-I23 (RS18/I23)	N23RS18 055870		1 off
	2 x 2.5 - 35 9 x 0.5 - 6	2 x 2.5 - 25 9 x 0.5 - 4	SE-RS-I23 (RS27/I23)	N23RS27 058243		
	2 x 2.5 - 35 2 x 1.5 - 16	2 x 2.5 - 25 2 x 1.5 - 16	SE-RS-I23 (RS33/I23)	N23RS33 060616		
	2 x 2.5 - 35 12 x 1.5 - 16	2 x 2.5 - 25 12 x 1.5 - 16	SE-RS-I43 (I44) RS18/I43 (I44)	N43RS18 067735		
	2 x 2.5 - 35 18 x 0.5 - 6	2 x 2.5 - 25 18 x 0.5 - 4	SE-RS-I43 (I44) RS27/I43 (I44)	N43RS27 065362		
	2 x 2.5 - 35 4 x 1.5 - 16	2 x 2.5 - 25 4 x 1.5 - 16	SE-RS-I43 (I44) RS33/I43 (I44)	N43RS33 062989		
PE (PEN) bars						
	2 x 2.5 - 35 6 x 1.5 - 16	2 x 2.5 - 25 6 x 1.5 - 16	SE-RS-I23 (RS18/I23)	PEN23RS18 081973		1 off
	2 x 2.5 - 35 9 x 0.5 - 6	2 x 2.5 - 25 9 x 0.5 - 4	SE-RS-I23 (RS27/I23)	PEN23RS27 079600		
	2 x 2.5 - 35 2 x 1.5 - 16	2 x 2.5 - 25 2 x 1.5 - 16	SE-RS-I23 (RS33/I23)	PEN23RS33 077227		
	2 x 2.5 - 35 12 x 1.5 - 16	2 x 2.5 - 25 12 x 1.5 - 16	SE-RS-I43 (I44) RS18/I43 (I44)	PEN43RS18 070108		
	2 x 2.5 - 35 18 x 0.5 - 6	2 x 2.5 - 25 18 x 0.5 - 4	SE-RS-I43 (I44) RS27/I43 (I44)	PEN43RS27 072481		
	2 x 2.5 - 35 4 x 1.5 - 16	2 x 2.5 - 25 4 x 1.5 - 16	SE-RS-I43 (I44) RS33/I43 (I44)	PEN43RS33 074854		



HPL20047EN

GA-..., B-GST00-..., AS...-CI, VBS...

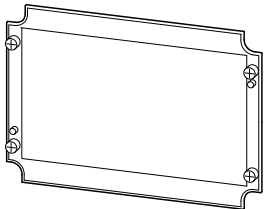
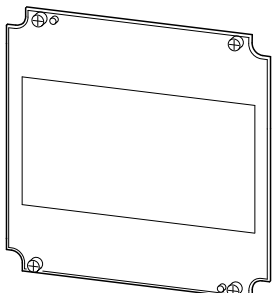
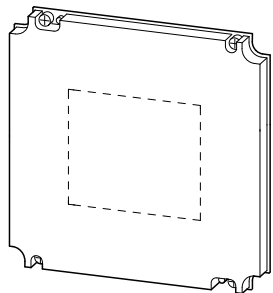
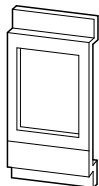
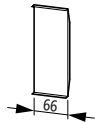
	For use with	Permissible devices	Part no. Article no.	Price See price list	Std. pack
Protective shroud					
Always also order fixing kit AH-GA.					
	CI23...	RS...3-50 busbar mounting fuse base	GA-RS-I23 046378		1 off
	CI43...	RS...3-50 busbar mounting fuse base GSTA00-160-40-60-AOU fuse switch-disconnector	GA-RS-I43 048751		1 off
	CI43...	RS...3-50 busbar mounting fuse base GSTA00-160-40-60-AOU fuse switch-disconnector	GA-RS-I43-G 017907		1 off
	CI44...	RS...3-50 busbar mounting fuse base GSTA00-160-40-60-AOU fuse switch-disconnector	GA-RS-I44 022653		2 off
	CI43...	RS...3-50 busbar mounting fuse base GSTA1 fuse switch-disconnector, with A-GSTA1/...adapter plate	GA-1-I43-G 020280		4 off
	CI44...	Fuse switch-disconnector with A-GSTA1/... adapter plate, GSTA1	GA-1-I44 025026		2 off
	CI44...	Fuse switch-disconnector with A-GSTA2/... adapter plate, GSTA2	GA-2-I44 027399		4 off
Insulating surround for fuse switch-disconnectors					
For compensation between the GA... protective cover and the device (for use in the CI insulated distribution board system)					
	GST00	–	B-GST00-40-60/CI/1 224553		5 off
Blanking strips					
To cover unused spaces					
	GA-RS-I43 GA-RS-I44	–	AS-RS-CI 002304		10 off
Set of connecting links					
For connection of the busbars for RS.../I23, RS.../I43, RS.../I44E, 250 A for L1, L2, L3. Each set contains 3 links					
	RS.../I23E RS.../I43E RS.../I44E	–	VBS-RS 002307		5 off

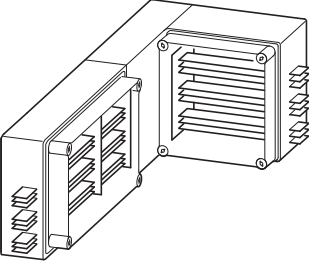
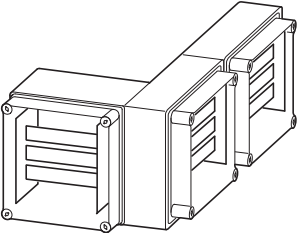

		Rated operational current I_e A	Part no. Article no.	Price See price list	Std. pack	Notes
Corner enclosures						
<ul style="list-style-type: none"> Protection type IP65 Up to 5-pole and up to 1000 A 3 pole 1600 A For 1600 A busbars additional enclosure for PE/N bars 						
 <p>Design "In the corner"¹⁾</p> <ul style="list-style-type: none"> Connection material (transport split) Busbars pre-bent Non-transparent cover 	250	ESKI630-310/144 002144	1 off	For main conductor L1, L2, L3 For protective or neutral conductor PE, PEN		
	400	ESKI630-320/144 002169		For main conductor L1, L2, L3 For protective or neutral conductor PE, N		
	630	ESKI1000-310/144 002171		For main conductor L1, L2, L3 For protective or neutral conductor PE, PEN		
	1000	ESKI1000-320/144 002170		For main conductor L1, L2, L3 For protective or neutral conductor PE, N		
	1600	ESKI1600-300/144 002172		For main conductor L1, L2, L3		
	1000	EPENI1000-010/144 002173		For protective or neutral conductor PE, PEN		
		EPENI1000-020/144 002174		For protective or neutral conductor PE, N		
		1600		EPENI1600-010/144 002176	For protective or neutral conductor PE, PEN	
				EPENI1600-020/144 002175	For protective or neutral conductor PE, N	
		 <p>Design "Around the corner"²⁾</p> <ul style="list-style-type: none"> Connection material (transport split) Busbars pre-bent Transparent cover 		250	ESKU630-310/144 002178	For main conductor L1, L2, L3 For protective or neutral conductor PE, PEN
400			ESKU630-320/144 002179	For main conductor L1, L2, L3 For protective or neutral conductor PE, N		
630	ESKU1000-310/144 002181		For main conductor L1, L2, L3 For protective or neutral conductor PE, PEN			
1000	ESKU1000-320/144 002180		For main conductor L1, L2, L3 For protective or neutral conductor PE, N			
1600	ESKU1600-300/144 002182		For main conductor L1, L2, L3			
1000	EPENU1000-010/144 002183		For protective or neutral conductor PE, PEN			
	EPENU1000-020/144 002184		For protective or neutral conductor PE, N			
1600	EPENU1600-010/144 002186		For protective or neutral conductor PE, PEN			
	EPENU1600-020/144 002185		For protective or neutral conductor PE, N			

Notes

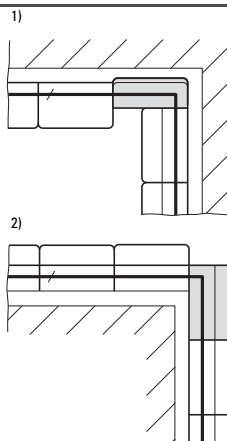

HPL20049EN

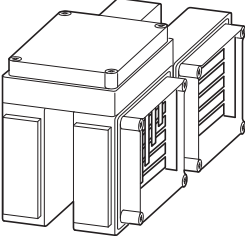
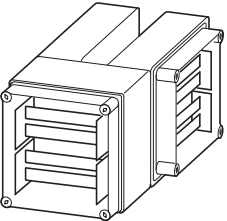
	Rated operational current I_e A	Part no. Article no.	Price See price list	Std. pack	Notes
Design "Back-to-back"					
<ul style="list-style-type: none"> Protection type IP65 Connection material Transparent cover For 1600 A busbars additional enclosure for PE/N bars 					
 <p>630 A busbar¹⁾</p>	250	RSK630-310/144 002154		1 off	For main conductor L1, L2, L3 For protective or neutral conductor PE, PEN
	400				
	630	RSK1000-310/144 002197			For main conductor L1, L2, L3 For protective or neutral conductor PE, PEN
	1000				
 <p>PE/N busbars²⁾</p>	1600	RSK1600-300/144 002198		For main conductor L1, L2, L3	
	1000	RPEN1000-010/144 002199		For protective or neutral conductor PE, PEN	
		RPEN1000-020/144 002200		For protective or neutral conductor PE, N	
	1600	RPEN1600-010/144 002202		For protective or neutral conductor PE, PEN	
RPEN1600-020/144 002201			For protective or neutral conductor PE, N		

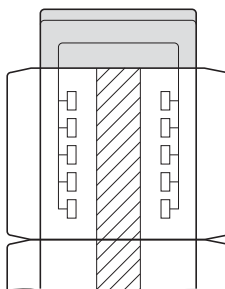

Notes

1)

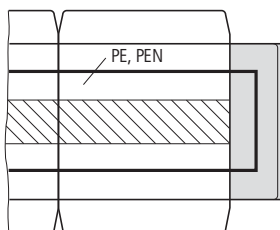

2)

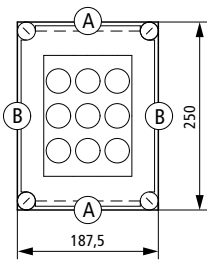

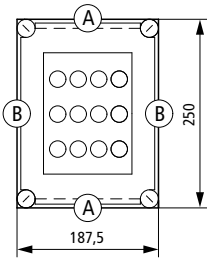
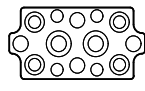
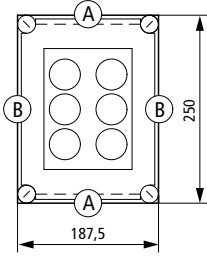
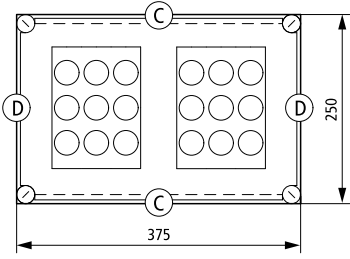
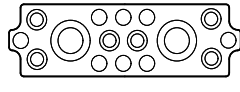
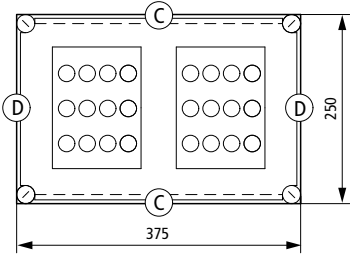
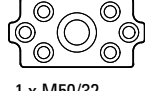
Dimensions	Rated operational current	Rated operating voltage	Max. fuse-link	Fused circuits	PE and N terminals	Part no. Article no.	Price See price list	Std. pack	Notes
mm	I_e A	U_e V AC	A	Number	mm ²				
Individual fuse enclosures (RS...E: cover without opening, RS...T: cover with door)									
<ul style="list-style-type: none"> Metric cable entry knockouts in all sides Protection type IP65 With 3-pole busbar mounting fuse base on busbars, replaceable from front Transparent cover with quick-release fasteners PE/N bars, protective shroud with inscription label Fixing straps for wall fixing Cover fasteners can be sealed, enclosure depth 150 mm 									
	25	500	25, DII/ E27	9 x 1-pole 3 x 3 pole	On each 2 x (6 - 35) On each 9 x (1 - 6)	RS27/ I23E 013156		1 off	A  1 x M32/20 6 x M20 2 x M16
			25, DII/ E27	9 x 1-pole 3 x 3 pole	On each 2 x (6 - 35) On each 9 x (1 - 6)	RS27/ I23E/T 015529			
	63	400	35, D02/ E18	6 x 1-pole 4 x 3 pole	On each 2 x (6 - 35) On each 6 x (4 - 25)	RS18/ I23E 020275			B  2 x M32/20 4 x M25/16 4 x M20 4 x M16
			35, D02/ E18	6 x 1-pole 4 x 3 pole	On each 2 x (6 - 35) On each 6 x (4 - 25)	RS18/ I23E/T 017902			
	63	690	35, DIII/ E33	2 x 3 pole	On each 2 x (6 - 35) On each 2 x (4 - 25)	RS33/ I23E 022648			
			35, DIII/ E33	2 x 3 pole	On each 2 x (6 - 35) On each 2 x (4 - 25)	RS33/ I23E/T 025021			
	25	500	25, DII/ E27	18 x 1-pole 6 x 3 pole	On each 2 x (6 - 35) On each 18 x (1 - 6)	RS27/ I43E 029767			C  2 x M50/20 6 x M25/16 8 x M20
			25, DII/ E27	18 x 1-pole 6 x 3 pole	On each 2 x (6 - 35) On each 18 x (1 - 6)	RS27/ I43E/T 027394			
	63	400	35, D02/ E18	12 x 1-pole 8 x 3 pole	On each 2 x (6 - 35) On each 12 x (4 - 25)	RS18/ I43E 032140			D  1 x M50/32 6 x M25/16
			35, D02/ E18	12 x 1-pole 8 x 3 pole	On each 2 x (6 - 35) On each 12 x (4 - 25)	RS18/ I43E/T 034513			

HPL20051EN

RS...I...E, RS...I...E/T

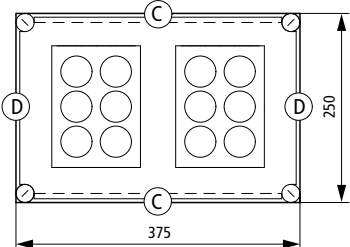
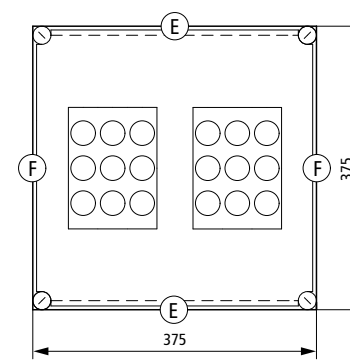
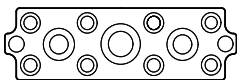
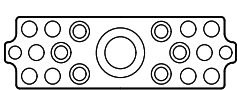
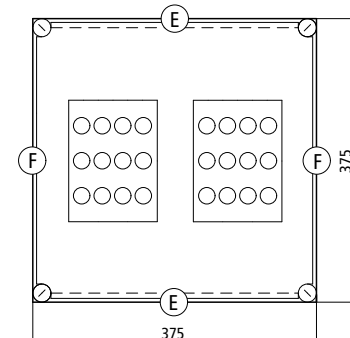
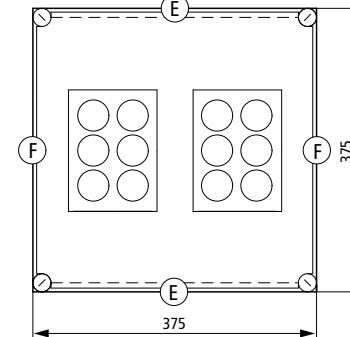
Dimensions	Rated operational current	Rated operating voltage	Max. fuse-link	Fused circuits	PE and N terminals	Part no. Article no.	Price See price list	Std. pack	Notes
mm	I _e A	U _e V AC	A	Number	Number x Cross-section mm ²				
Individual fuse enclosures (RS...E: cover without opening, RS...T: cover with door)									
	63	690	35, DIII/ E33	4 x 3 pole	On each 2 x (6 - 35) On each 4 x (4 - 25)	RS33/ I43E 039259		1 off	
			35, DIII/ E33	4 x 3 pole	On each 2 x (6 - 35) On each 4 x (4 - 25)	RS33/ I43E/T 036886			
	25	500	25, DII/ E27	18 x 1-pole 6 x 3 pole	On each 2 x (6 - 35) On each 18 x (1 - 6)	RS27/ I44E 001884			E  1 x M50/32 2 x M40/25 8 x M25/16 2 x M20
			25, DII/ E27	18 x 1-pole 6 x 3 pole	On each 2 x (6 - 35) On each 18 x (1 - 6)	RS27/ I44E/T 001885			F  1 x M63/40 6 x M25/16 10 x M20 2 x M16
	63	400	63, D02/ E18	12 x 1-pole 8 x 3 pole	On each 2 x (6 - 35) On each 12 x (4 - 25)	RS18/ I44E 001886			---PE/N bars
			63, D02/ E18	12 x 1-pole 8 x 3 pole	On each 2 x (6 - 35) On each 12 x (4 - 25)	RS18/ I44E/T 001887			Accessories for fuse enclosures → Page 20/46
	63	690	63, DIII/ E33	4 x 3 pole	On each 2 x (6 - 35) On each 12 x (4 - 25)	RS33/ I44E 001888			Fuses, fuse adapters and screw-on caps → Chapter 19: Circuit-breakers, fuses
			63, DIII/ E33	4 x 3 pole	On each 2 x (6 - 35) On each 12 x (4 - 25)	RS33/ I44E/T 001889			
Accessories									
Set of connecting links									
For connection of the busbars for RS.../I23, RS.../I43, RS.../I44E, 250 A for L1, L2, L3. Each set contains 3 links									
	250	-	-	-	-	VBS-RS 002307		5 off	

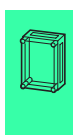

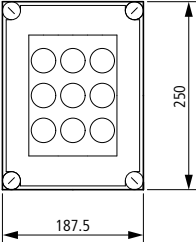
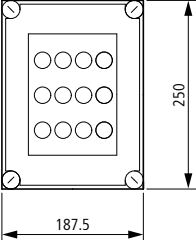
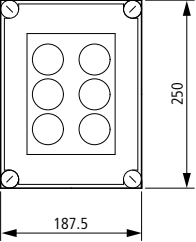
Dimensions	Enclosure depth	Rated operational current	Rated operating voltage	Max. fuse-link	Fused circuits	Part no. Article no.	Price See price list	Std. pack
mm	mm	I _e A	U _e V AC	A	Number			
Panel enclosures for fuses								
<ul style="list-style-type: none"> Sides closed, but with full area knockout, open top and bottom Protection type IP65 With 3-pole busbar mounting fuse base on busbars, replaceable from front Transparent cover with quick-release fasteners Protective shroud with inscription label Sealable cover fasteners 								
	150	25	500	25 A DII/E27	9 x 1-pole 3 x 3 pole	RS27/I23-125 074056		1 off
	175	25	500	25 A DII/E27	9 x 1-pole 3 x 3 pole	RS27/I23-150 005240		
	150	63	400	35 A D02/E18	6 x 1-pole 4 x 3 pole	RS18/I23-125 081175		
	175	63	400	35 A D02/E18	6 x 1-pole 4 x 3 pole	RS18/I23-150 007613		
	150	63	690	35 A DIII/E33	2 x 3 pole	RS33/I23-125 083548		
	175	63	690	35 A DIII/E33	2 x 3 pole	RS33/I23-150 014732		

Notes

Accessories for fuse enclosures → Page 20/46
 Fuses, fuse adapters and screw-on cap
 → Chapter 19: Circuit-breakers, fuses

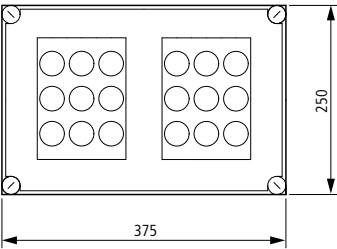
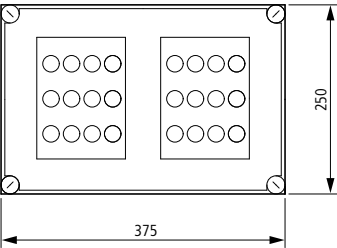
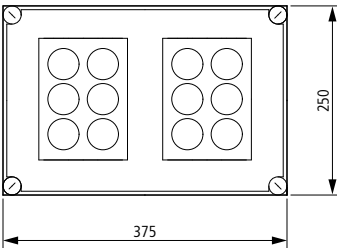

Dimensions	Enclosure depth	Rated operational current	Rated operating voltage	Max. fuse-link	Fused circuits	Part no. Article no.	Price See price list	Std. pack
mm	mm	I _e A	U _e V AC	A	Number			
Panel enclosures for fuses								
	150	25	500	25 A DII/E27	18 x 1-pole 6 x 3 pole	RS27/I43-125 090667		1 off
	225	25	500	25 A DII/E27	18 x 1-pole 6 x 3 pole	RS27/I43-200 024224		
	150	63	400	35 A D02/E18	12 x 1-pole 8 x 3 pole	RS18/I43-125 093040		
	225	63	400	35 A D02/E18	12 x 1-pole 8 x 3 pole	RS18/I43-200 026597		
	150	63	690	35 A DIII/E33	4 x 3 pole	RS33/I43-125 097786		
	225	63	690	35 A DIII/E33	4 x 3 pole	RS33/I43-200 033716		
Accessories								
Set of connecting links								
For connection of the busbars for RS.../I23, RS.../I43, RS.../I44E, 250 A for L1, L2, L3.								
Each set contains 3 links								
-	-	250	-	-	-	VBS-RS 002307		5 off

Notes

Accessories for fuse enclosures → Page 20/46
 Fuses, fuse adapters and screw-on cap
 → Chapter 19: Circuit-breakers, fuses

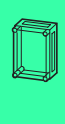

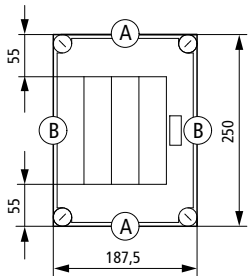
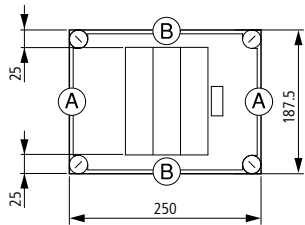
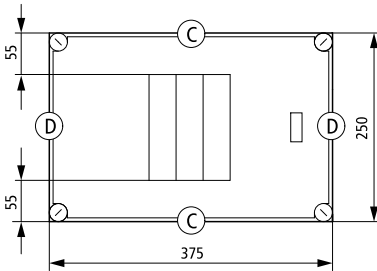
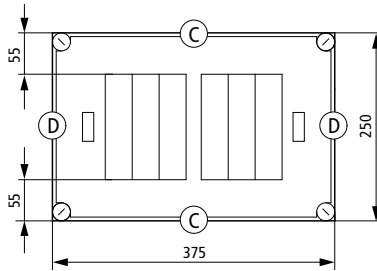
Dimensions	Rated operational current	Rated operational voltage	Fuse-link	5th terminal can be retrofitted (neutral conductor)	Part no. Article no.	Price See price list	Std. pack
mm	I_e A	U_e V AC	Sizes				
Individual enclosures with LV h.b.c. fuse bases							
<ul style="list-style-type: none"> • Metric cable entry knockouts in all sides • Protection type IP65 • Transparent cover • Enclosure depth 150 mm • Terminal for connecting the 4th conductor (PEN) • Fuse base fitted to steel mounting plate • Fixing straps for wall fixing • Sealable cover fasteners 							
	100	690	NH00	K50/1	GS00/I23E 027395		1 off
	100	690	NH00	K50/1	GS00/I23E-G 029768		1 off
	100	690	NH00	K50/1	GS00/I43E 032141		1 off
	160 100	500 690	NH00	K95/1N/BR	GS00-160/I43E 034514		1 off
	2 x 100	690	NH00	K50/1	2GS00/I43E 044006		1 off

Notes

Fuse-links → Chapter 19: Circuit-breakers, fuses

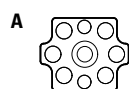

1 x M32/20
6 x M20
2 x M16

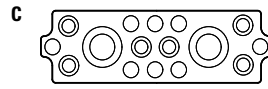

2 x M50/20
6 x M25/16
8 x M20

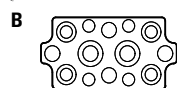

2 x M32/20
4 x M25/16
4 x M20
4 x M16

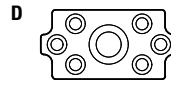

1 x M50/32
6 x M25/16

HPL20055EN

Individual enclosures with LV h.b.c. fuse bases

2GS00/I..., GS00/I...

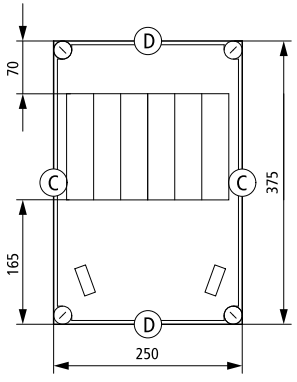
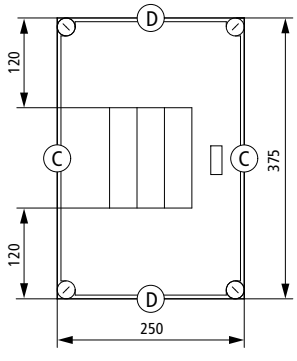
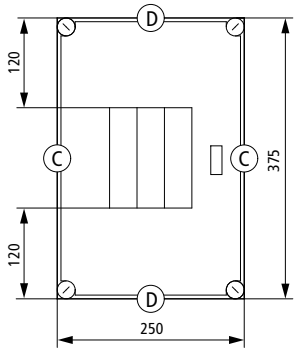
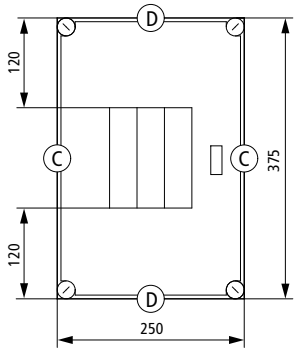
Dimensions	Rated operational current	Rated operational voltage	Fuse-link	5th terminal can be retrofitted (neutral conductor)	Part no. Article no.	Price See price list	Std. pack
mm	I_e A	U_e V AC	Sizes				
Individual enclosures with LV h.b.c. fuse bases							
	2 x 100	690	NH00	K50/1	2GS00/143E-G 041633		1 off
	100	690	NH00	K50/1	GS00/143E-G 039260		1 off
	160	500	NH00	K95/1N/BR	GS00-160/143E-G 036887		1 off
	100	690	NH00	K95/1N/BR	GS00-160/143E-G 036887		1 off

Notes

Fuse-links → Chapter 19: Circuit-breakers, fuses

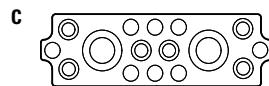

2 x M50/20
6 x M25/16
8 x M20

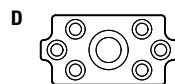

1 x M50/32
6 x M25/16

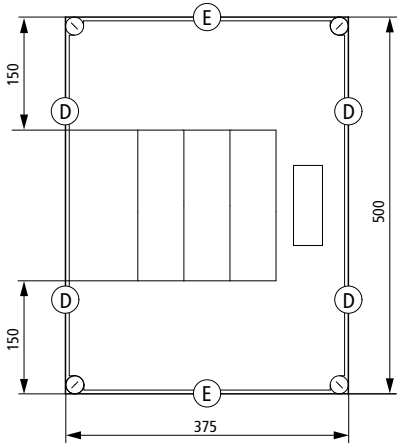
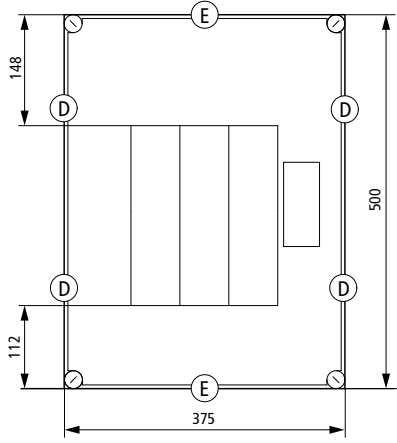
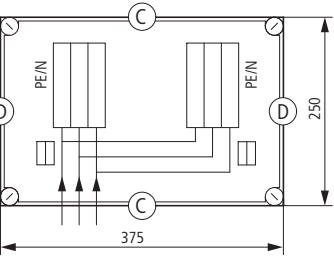

Dimensions	Rated operational current	Rated operational voltage	Fuse-link	5th terminal can be retrofitted (neutral conductor)	Part no. Article no.	Price See price list	Std. pack
mm	I_e A	U_e V AC	Sizes				
Individual enclosures with LV h.b.c. fuse bases							
	250 200	500 690	NH1	K150/1	GS1/145E 090148		1 off
	400 315	500 690	NH2	K240/1	GS2/145E 090149		1 off
Two-way fuse box							
With parallel link between the incoming sides Incoming cable max. 35 mm ² Max. fuse-link 63 A							
	2 x 100	690	NH00	–	2GS00/143E-V2K 046379		1 off

Notes

Fuse-links → Chapter 19: Circuit-breakers, fuses

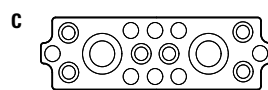

2 x M50/20
6 x M25/16
8 x M20

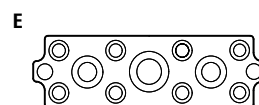

1 x M50/32
2 x M40/25
8 x M25/16
2 x M20

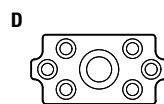

1 x M50/32
6 x M25/16



HPL20057EN

GS00/I..., 2GS00/I..., 3GS00/I...

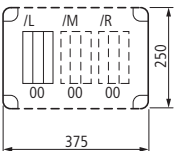
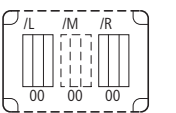
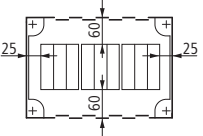
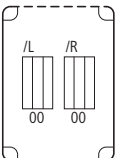
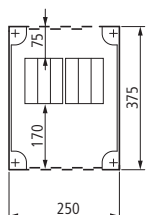
Dimensions	Fuse-link	Rated operational current	Rated operational voltage	Part no. Article no.	Price See price list	Std. pack	NH component	Basic enclosure Mounting system
mm	Sizes	I_e A	U_e V AC				Location	Basic unit W x H x D Other
Distribution board enclosures with LV h.b.c. fuse bases without PE/N terminals								
<ul style="list-style-type: none"> Sides closed, but with full area knockout, open top and bottom Transparent cover, cover fasteners can be sealed. Protection type IP65 Fuse base fitted to steel mounting plate Mounting plate brought forward by 50 mm Terminal for connecting the 4th conductor (PEN) Stepped cable grommets → Page 20/29 								
	NH00	100	690	GS00/143/L 067740		1 off	Left	CI43-200 L3-CI43
				GS00/143/M 070113			Centre	GS00(-160) HS 50-CI
				GS00/143/R 072486			Right	
		160	500	GS00-160/143/L 086724			Left	
				GS00-160/143/M 089097			Centre	
				GS00-160/143/R 091470			Right	
	NH00	2 x 100	690	2GS00/143/L/R 020281			Left	CI43-200
				2GS00/143/L/M 022654			Right	L3-CI43
				2GS00/143/M/R 025027			Left	GS00(-160)
					Centre	HS 50-CI		
		2 x 160	500	2GS00-160/143/L/R 010789			Left	
				2GS00-160/143/L/M 013162			Right	
				2GS00-160/143/M/R 015535			Left	
					Centre			
	NH00	3 x 100	690	3GS00/143 029773			-	CI43-200
				3GS00-160/143 017908			-	L3-CI43
		3 x 160	500				Right	GS00(-160)
							Left	HS 50-CI
		100	690	GS00/143-G/L 074859			Left	CI43-200 (rotated 90°)
				GS00/143-G/R 077232			Right	L3-CI43
		160	500	GS00-160/143-G/L 093843			Left	GS00(-160)
				GS00-160/143-G/R 096216			Right	HS 50-CI
	NH00	2 x 100	690	2GS00/143-G 027400			-	CI43-200 (rotated 90°)
				2GS00-160/143-G 098589			-	L3-CI43
		2 x 160	500				-	GS00(-160)
							-	HS 50-CI

Notes

Fuse-links → Chapter 19: Circuit-breakers, fuses



Dimensions	Fuse-link	Rated operational current	Rated operational voltage	Part no. Article no.	Price See price list	Std. pack	Basic enclosure Mounting system Basic unit W x H x D Other
mm	Sizes	I_e A	U_e V AC				
Distribution board enclosures with LV h.b.c. fuse bases without PE/N terminals <ul style="list-style-type: none"> Sides closed, but with full area knockout, open top and bottom Transparent cover, cover fasteners can be sealed. Protection type IP65 Fuse base fitted to steel mounting plate Mounting plate brought forward by 50 mm Terminal for connecting the 4th conductor (PEN) Stepped cable grommets → Page 20/29 							
	NH1	250 200	500 660 690	GS1/I43 034519		1 off	C143-200 L3-CI43 GS1 HS 50-CI
	NH1	250 200	500 660 690	GS1/I43-G 036892			C143-200 (rotated 90°) L3-CI43 GS1 HS 50-CI
	NH2	315 315	500 660 690	GS2/I44 039265			C144-200 L3-CI43 GS2 HS 50-CI
	NH2	400 315	500 660 690	GS2/I48 041638			C148-200 L3-CI43 GS2 HS 50-CI
	NH3	500 400	500 660 690	GS3/I48 044011			C148-200 L3-CI43 GS3 HS 50-CI

Notes

Fuse-links → Chapter 19: Circuit-breakers, fuses

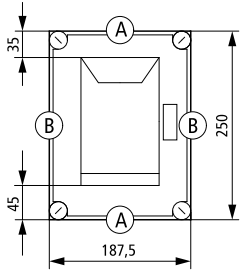
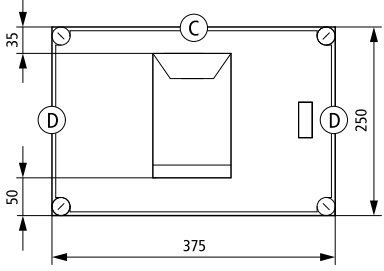
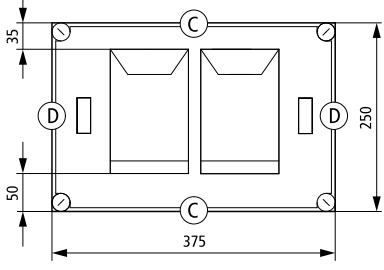

Dimensions	Enclosure depth	Rated operational current	Rated operational voltage	Fuse-link	5th terminal can be retrofitted (neutral conductor)	Part no. Article no.	Price See price list	Std. pack
mm	mm	I _e A	U _e V AC	Sizes				
Individual enclosures with LV h.b.c. fuse switch-disconnector								
<ul style="list-style-type: none"> • Metric cable entry knockouts in all sides • Protection type IP65 • Transparent cover • Terminal for connecting the 4th conductor (PEN) • Fuse switch-disconnector fitted to steel mounting plate • Fixing straps for wall fixing • Sealable cover fasteners 								
	150	100	690	NH00	K50/1	GSTA00/I23E 048752		1 off
	150	100	690	NH00	K50/1	GSTA00/I43E 051125		
	150	160 100	500 690	NH00	K95/1N/BR	GSTA00-160/I43E 053498		
	150	2 x 100	690	NH00	K50/1	2GSTA00/I43E 070109		

Notes

Fuse-links → Chapter 19: Circuit-breakers, fuses

A



1 x M32/20
6 x M20
2 x M16

C

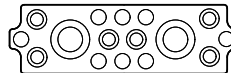

2 x M50/20
6 x M25/16
8 x M20

B

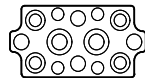

2 x M32/20
4 x M25/16
4 x M20
4 x M16

D

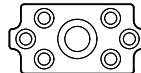

1 x M50/32
6 x M25/16



Dimensions	Enclosure depth	Rated operational current	Rated operational voltage	Fuse-link	5th terminal can be retrofitted (neutral conductor)	Part no. Article no.	Price See price list	Std. pack
mm	mm	I _e A	U _e V AC	Sizes				
Individual enclosures with LV h.b.c. fuse switch-disconnector								
<ul style="list-style-type: none"> • Metric cable entry knockouts in all sides • Protection type IP65 • Transparent cover • Terminal for connecting the 4th conductor (PEN) • Fuse switch-disconnector fitted to steel mounting plate • Fixing straps for wall fixing • Sealable cover fasteners 								
	150	100	690	NH00	K50/1	GSTA00/143E-G 058244		1 off
	150	160 100	500 690	NH00	K95/1N/BR	GSTA00-160/143E-G 055871		
	150	100	690	NH00	K50/1	GSTA00/144E 060617		
	150	160 100	500 690	NH00	K95/1N/BR	GSTA00-160/144E 062990		
	150	2 x 100	690	NH00	K50/1	2GSTA00/144E 067736		
	150	2 x 160 2 x 100	500 690	NH00	K95/1N/BR	2GSTA00-160/144E 065363		



HPL20061EN

GSTA...I...

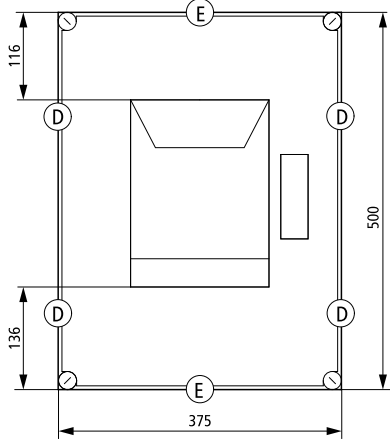
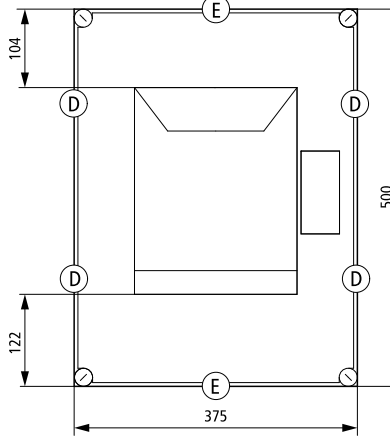
Dimensions	Enclosure depth	Rated operational current	Rated operational voltage	Fuse-link	5th terminal can be retrofitted (neutral conductor)	Part no. Article no.	Price See price list	Std. pack
mm	mm	I _e A	U _e V AC	Sizes				
Individual enclosures with LV h.b.c. fuse switch-disconnector								
	225	250 200	500 690	NH1	K150/1	GSTA1/I45E 090150		1 off
	225	400 315	500 690	NH2	K240/1	GSTA2/I45E 090151		1 off

Notes

Fuse-links → Chapter 19: Circuit-breakers, fuses

C

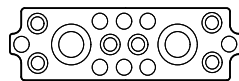

2 x M50/20
6 x M25/16
8 x M20

E

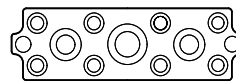

1 x M50/32
2 x M40/25
8 x M25/16
2 x M20

D

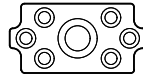

1 x M50/32
6 x M25/16

F

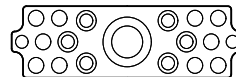

1 x M63/40
6 x M25/16
10 x M20
2 x M16

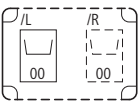
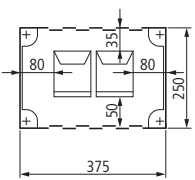
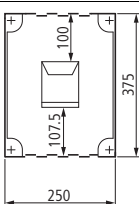
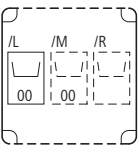
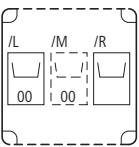
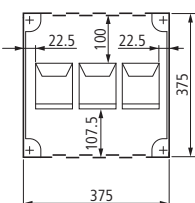

Dimensions	Fuse-link	Rated operational current	Rated operational voltage	Part no. Article no.	Price See price list	Std. pack	NH component Location	Basic enclosure Mounting system Basic unit W x H x D Other
mm	Sizes	I _e A	U _e V AC					
Distribution board enclosures with LV h.b.c. fuse switch-disconnectors								
<ul style="list-style-type: none"> Sides closed, but with full area knockout, open top and bottom Transparent cover, cover fasteners can be sealed. Protection type IP65 Fuse base fitted to steel mounting plate Mounting plate brought forward by 50 mm Terminal for connecting the fourth conductor (PEN) Stepped cable grommets → Page 20/29 								
	NH00	100	660	GSTA00/143/L 046384		1 off	Left	CI43-200 L3-CI43
		100	690	GSTA00/143/R 048757			Right	GSTA00(-160) HS 50-CI
		160	500	GSTA00-160/143/L 034520			Left	
		160	500	GSTA00-160/143/R 036893			Right	
	NH00	2 x 100	660	2GSTA00/143 060622			Left Right	CI43-200 L3-CI43
		2 x 160	500	2GSTA00-160/143 053504			Left Right	GSTA00(-160) HS 50-CI
	NH00	100	660	GSTA00/143-G 058249			Centre	CI43-200 (rotated 90°)
		160	500	GSTA00-160/143-G 055877			Centre	L3-CI43 GSTA00(-160) HS 50-CI
	NH00	100	660	GSTA00/144/L 051130			Left	CI44-200 L3-CI43
				GSTA00/144/M 053503			Centre	GSTA00(-160) HS 50-CI
				GSTA00/144/R 055876			Right	
	160	500	GSTA00-160/144/L 039266		Left			
			GSTA00-160/144/M 041639		Centre			
			GSTA00-160/144/R 044012		Right			
	NH00	2 x 100	660	2GSTA00/144/L/R 062995			Left Right	CI44-200 L3-CI43
				2GSTA00/144/L/M 065368			Left Centre	GSTA00(-160) HS 50-CI
				2GSTA00/144/M/R 067741			Centre Right	
	2 x 160	500	2GSTA00-160/144/L/R 046385		Left Right			
			2GSTA00-160/144/L/M 048758		Left Centre			
			2GSTA00-160/144/M/R 051131		Centre Right			
	NH00	3 x 100	660	3GSTA00/144 070114			Left Centre Right	CI44-200 L3-CI43
	NH00	3 x 160	500	3GSTA00-160/144 058250			Left Centre Right	GSTA00(-160) HS 50-CI

Notes

Fuse-links → Chapter 19: Circuit-breakers, fuses

HPL20063EN

GSTA...I...

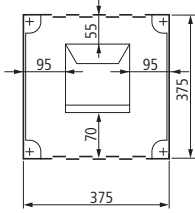
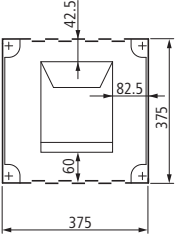
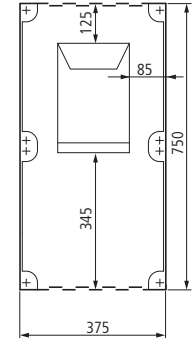
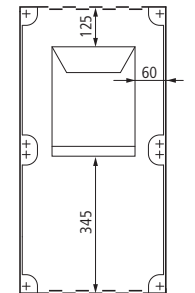
Dimensions	Fuse-link	Rated operational current	Rated operational voltage	Part no. Article no.	Price See price list	Std. pack	Basic enclosure Mounting system Basic unit W x H x D Other
mm	Sizes	I _e A	U _e V AC				
Distribution board enclosures with LV h.b.c. fuse switch-disconnectors							
	NH1	250 200	500 660 690	GSTA1/I44 013163		1 off	C144-200 L3-C143 GSTA1 HS 50-CI
	NH2	315 315	500 660 690	GSTA2/I44 015536			C144-200 L3-C143 GSTA2 HS 50-CI
	NH2	400 315	500 660 690	GSTA2/I48 017909			C148-200 L3-C143 GSTA2 HS 50-CI
	NH3	500 400	500 660 690	GSTA3/I48 020282			C148-200 L3-C143 GSTA3 HS 50-CI

Notes

Fuse-links → Chapter 19: Circuit-breakers, fuses

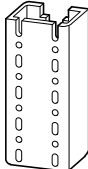
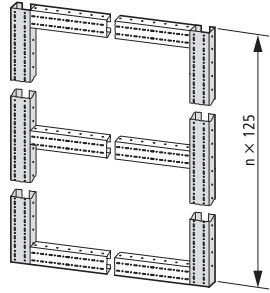
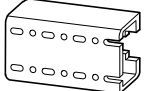
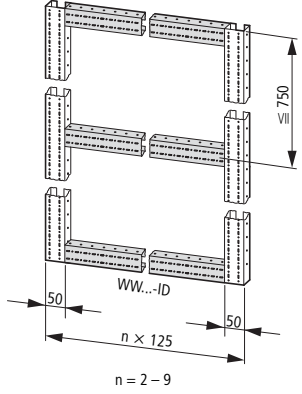
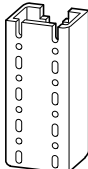
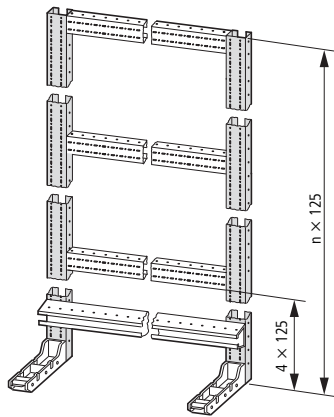

	125 mm grid spacing Quantity	Length mm	For use with	Part no. Article no.	Price See price list	Std. pack		
Section for mounting frames								
<ul style="list-style-type: none"> Galvanized C sections Order fixing screws separately 								
For wall-mounting distribution system								
Vertical section (outside)								
	6 x 125	750		WS6-ID 098594		1 off		
	7 x 125	875		WS7-ID 010794		1 off		
	8 x 125	1000		WS8-ID 013167		1 off		
	9 x 125	1125		WS9-ID 015540		1 off		
	10 x 125	1250		WS10-ID 017913		1 off		
	11 x 125	1375		WS11-ID 020286		1 off		
	12 x 125	1500		WS12-ID 022659		5 off		
	13 x 125	1625		WS13-ID 025032		1 off		
	14 x 125	1750		WS14-ID 027405		1 off		
	15 x 125	1875		WS15-ID 029778		1 off		
	Horizontal profiles							
		2 x 125		150		WW2-ID 041643		5 off
		3 x 125		275		WW3-ID 044016		5 off
		4 x 125		400		WW4-ID 046389		5 off
		5 x 125		525		WW5-ID 048762		5 off
6 x 125		650	WW6-ID 051135			1 off		
7 x 125		775	WW7-ID 053508			5 off		
8 x 125		900	WW8-ID 055881			1 off		
9 x 125		1025	WW9-ID 058254			1 off		
For wall-mounting distribution system supported on the floor								
Vertical section (outside)								
	10 x 125	1250		WS10-ID 017913		1 off		
	11 x 125	1375		WS11-ID 020286		1 off		
	12 x 125	1500		WS12-ID 022659		5 off		
	13 x 125	1625		WS13-ID 025032		1 off		
	14 x 125	1750		WS14-ID 027405		1 off		
	15 x 125	1875		WS15-ID 029778		1 off		
	16 x 125	2000		WS16-ID 032151		1 off		
	17 x 125	2125		WS17-ID 034524		1 off		
	18 x 125	2250		WS18-ID 036897		1 off		
	19 x 125	2375		WS19-ID 039270		1 off		





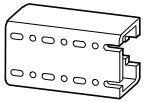
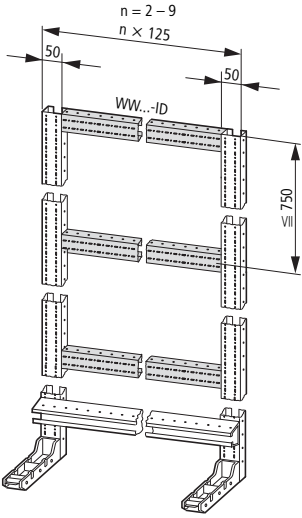
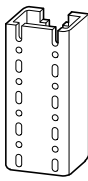
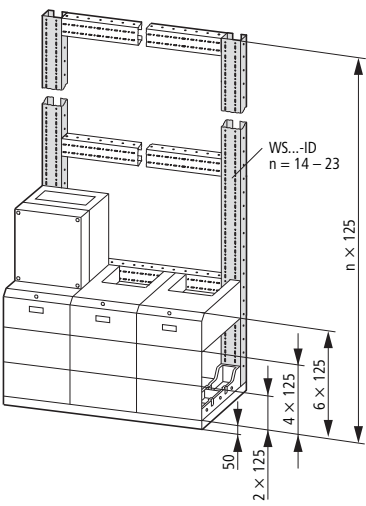
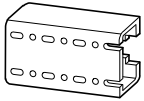
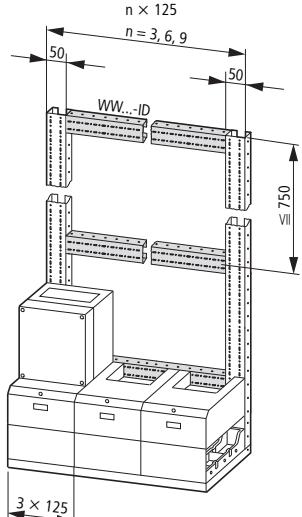

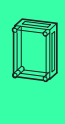
HPL20065EN

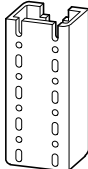
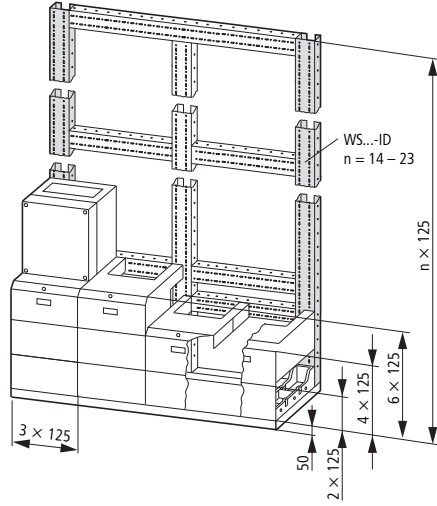
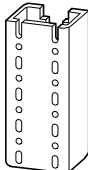
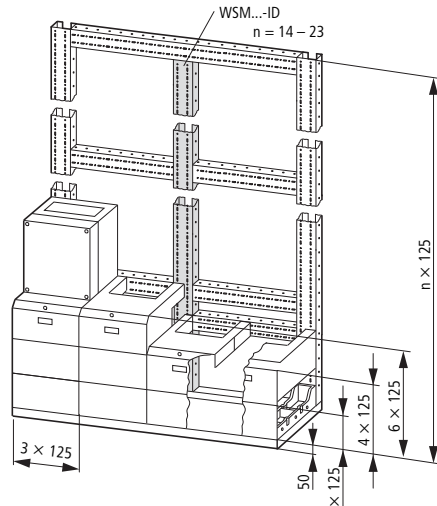
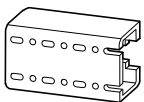
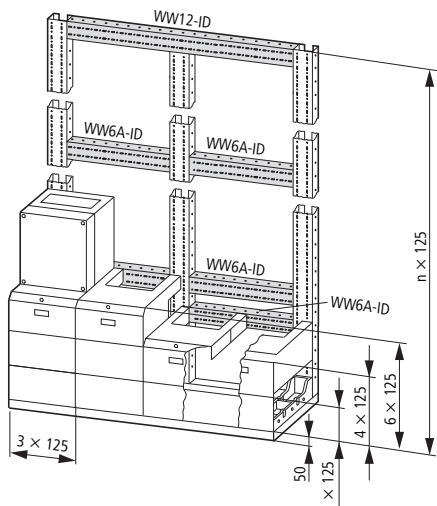

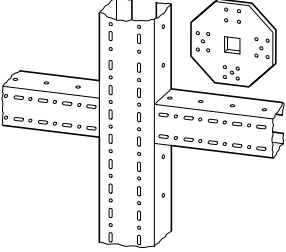
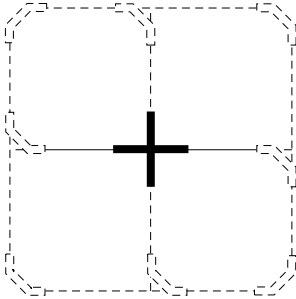

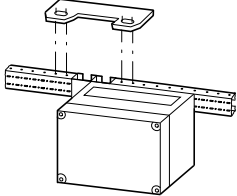
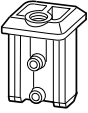
Mounting frames
WS...-ID, WW...-ID

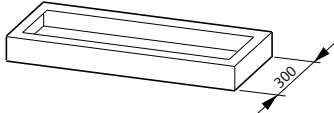
	125 mm grid spacing Quantity	Length mm	For use with	Part no. Article no.	Price See price list	Std. pack
Section for mounting frames						
<ul style="list-style-type: none"> Galvanized C sections Order fixing screws separately 						
Horizontal profiles						
	2 x 125	150		WW2-ID 041643		5 off
	3 x 125	275		WW3-ID 044016		5 off
	4 x 125	400		WW4-ID 046389		5 off
	5 x 125	525		WW5-ID 048762		5 off
	6 x 125	650		WW6-ID 051135		1 off
	7 x 125	775		WW7-ID 053508		5 off
	8 x 125	900		WW8-ID 055881		1 off
	9 x 125	1025		WW9-ID 058254		1 off
	For floor-standing distribution boards, 3 panels wide					
Vertical section (outside)						
	14 x 125	1750		WS14-ID 027405		1 off
	15 x 125	1875		WS15-ID 029778		1 off
	16 x 125	2000		WS16-ID 032151		1 off
	17 x 125	2125		WS17-ID 034524		1 off
	18 x 125	2250		WS18-ID 036897		1 off
	19 x 125	2375		WS19-ID 039270		1 off
	20 x 125	2500		WS20-ID 034525		1 off
	21 x 125	2625		WS21-ID 036898		5 off
	22 x 125	2750		WS22-ID 039271		5 off
	23 x 125	2875		WS23-ID 041644		1 off
Horizontal profiles						
	3 x 125	275		WW3-ID 044016		5 off
	6 x 125	650		WW6-ID 051135		1 off
	9 x 125	1025		WW9-ID 058254		1 off

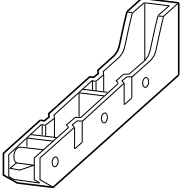
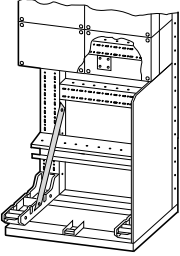

	125 mm grid spacing	Length	For use with	Part no. Article no.	Price See price list	Std. pack		
	Quantity	mm						
Section for mounting frames								
<ul style="list-style-type: none"> Galvanized C sections Order fixing screws separately 								
For floor-standing distribution boards, 4 panels wide								
Vertical section (outside)								
	14 x 125	1750		WS14-ID 027405		1 off		
	15 x 125	1875		WS15-ID 029778		1 off		
	16 x 125	2000		WS16-ID 032151		1 off		
	17 x 125	2125		WS17-ID 034524		1 off		
	18 x 125	2250		WS18-ID 036897		1 off		
	19 x 125	2375		WS19-ID 039270		1 off		
	20 x 125	2500		WS20-ID 034525		1 off		
	21 x 125	2625		WS21-ID 036898		5 off		
	22 x 125	2750		WS22-ID 039271		5 off		
	23 x 125	2875		WS23-ID 041644		1 off		
	Vertical section (centre)							
		14 x 125		1700		WSM14-ID 044017		5 off
		15 x 125		1825		WSM15-ID 046390		5 off
16 x 125		1950	WSM16-ID 048763			5 off		
17 x 125		2075	WSM17-ID 051136			5 off		
18 x 125		2200	WSM18-ID 053509			5 off		
19 x 125		2325	WSM19-ID 055882			5 off		
20 x 125		2450	WSM20-ID 058255			5 off		
21 x 125		2575	WSM21-ID 060628			5 off		
22 x 125		2700	WSM22-ID 063001			5 off		
23 x 125		2825	WSM23-ID 065374			5 off		
Horizontal profiles								
		6 x 125	675			WW6A-ID 067747		1 off
		12 x 125	1400			WW12-ID 070120		1 off

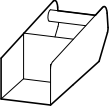
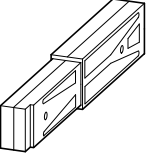
	For use with	For use with	Part no. Article no.	Price See price list	Std. pack
Cross plates for wall-mounting and floor-standing distribution boards					
<ul style="list-style-type: none"> For the connection of horizontal and vertical sections Including fixing material 					
	—		KVB-ID 002300		10 off
Assembly bracket					
<ul style="list-style-type: none"> For the connection of distribution boards and for transport units Including fixing material 					
	Wall-mounting distribution board top and bottom on WW... section Wall-mounting distribution board 2 off, floor-standing distribution board 1 off		ARB-ID 002302		10 off
	For enclosure assembly at transport splits	—	VS-TR-CI 002330		25 off
Lifting eye fixing					
For securing TOR-GG eyebolts, M12 thread					
	Wall-mounting distribution boards, floor-standing distribution boards Mounting in WS... vertical profiles	—	TOB-ID 093848		10 off
Lifting eyes kit					
For lift eye fix, M12 thread					
	Wall-mounting distribution boards, floor-standing distribution boards For fixing using TOB-ID to the vertical sections One set consists of 4 lifting eyes	—	TOR-GG 048276		1 off
Fixing screw					
For securing CI enclosures to the sections					
	For securing CI enclosures to wall fixing brackets W... and to profiles WS..., WW...	—	LT284-M6X20-C 050325		100 off
Plinths					
For mounting floor-standing distribution boards					
	Width 375 mm	—	SS5-ID0375 079611		1 off
	Width 750 mm	—	SS5-ID0750 081984		1 off
	Width 1125 mm	—	SS5-ID1125 084357		1 off
	Width 1500 mm	—	SS5-ID1500 086730		1 off
Spray can for CI enclosure covers					
For painting covers, color RAL 7032 Contents 400 ml/300 g					
		—	SP-CI-RAL7032 005741		1 off

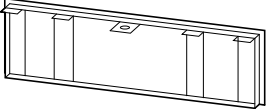
	For use with	Part no. Article no.	Price See price list	Std. pack
Foot				
For fixing to the floor				
	Left and right on base SS5-ID (on SS5-ID1500 also in middle)	FHF-ID 089103		2 off
	Support struts			
For floor-standing distribution boards to support the vertical section on the floor				
	For plinth height 50 cm	STR50-ID 072493		1 off
	For plinth height 75 cm	STR75-ID 074866		1 off
Strap				
For the connection of distribution boards (and with transport splits)				
	In the base, 1 off for base heights ≤ 50 cm 2 off for plinth heights 75 cm	LPS-ID 086731		5 off
Foot prop				
Supports for the front plate (bottom)				
• 1 off per section width				
	Between the externally fitted FHF-ID feet	SLHF-ID 091476		5 off
Support brackets				
Support bracket for the top plate				
• 2 off per section width				
	-	HDP-ID 093849		5 off
Support bracket				
Additional fixing for the HPD-ID holder				
	For SS5-ID0375: 0 off For SS5-ID0750: 1 off For SS5-ID1125: 2 off For SS5-ID1500: 2 off	SWHDP-ID 032152		5 off
Top plate				
• Simultaneous support for the front plate (top)				
• 1 off per section width				
	-	DP-ID 096222		5 off

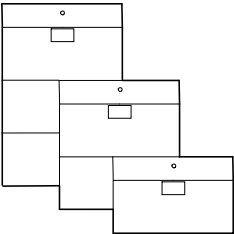
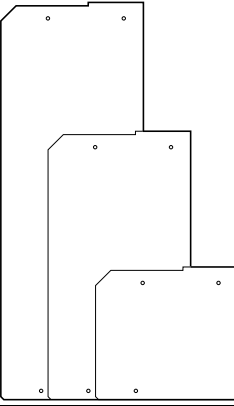
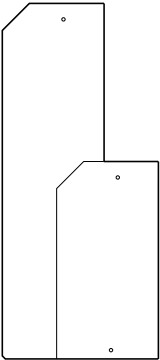
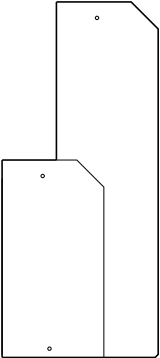

For use with	Part no. Article no.	Price See price list	Std. pack
Cable compartment cladding			
Front plates			
<ul style="list-style-type: none"> For covering the plinth area (cabling area) 1 off per section width 			
	Height 750 mm	FP75-ID 013168	2 off
	Height 500 mm	FP50-ID 010795	4 off
	Height 250 mm	FP25-ID 098595	4 off
Enclosure side plates			
<ul style="list-style-type: none"> Cover for external sides Can be fitted to left or right 			
	Height 750 mm	SWRL75-ID 020287	1 off
	Height 500 mm	SWRL50-ID 017914	1 off
	Height 250 mm	SWRL25-ID 015541	1 off
Intermediate plates			
<ul style="list-style-type: none"> For cover between base of different heights 			
Right side			
	Between plinth heights 750 mm - 250 mm	ZPR50-ID 022660	1 off
	Between plinth heights of 750 mm - 500 mm or 500 mm - 230 mm	ZPR25-ID 025033	1 off
Left side			
	Between plinth heights 750 mm - 250 mm	ZPL50-ID 029779	1 off
	Between plinth heights of 750 mm - 500 mm or 500 mm - 230 mm	ZPL25-ID 027406	1 off



Engineering

Enclosure size selection

Enclosure measurements

Width:
187.5 mm
375 mm

Height:
250 mm
375 mm
500 mm
750 mm

Suitable for distribution board systems with section widths in 375 mm grid. Rotation of enclosure by 90° allows section widths in 250 mm grid.

With various cover depths, four standardized mounting depths can be implemented in a 25 mm grid (upper edge of mounting plate to lower edge of cover):

125 mm
150 mm
200 mm
250 mm

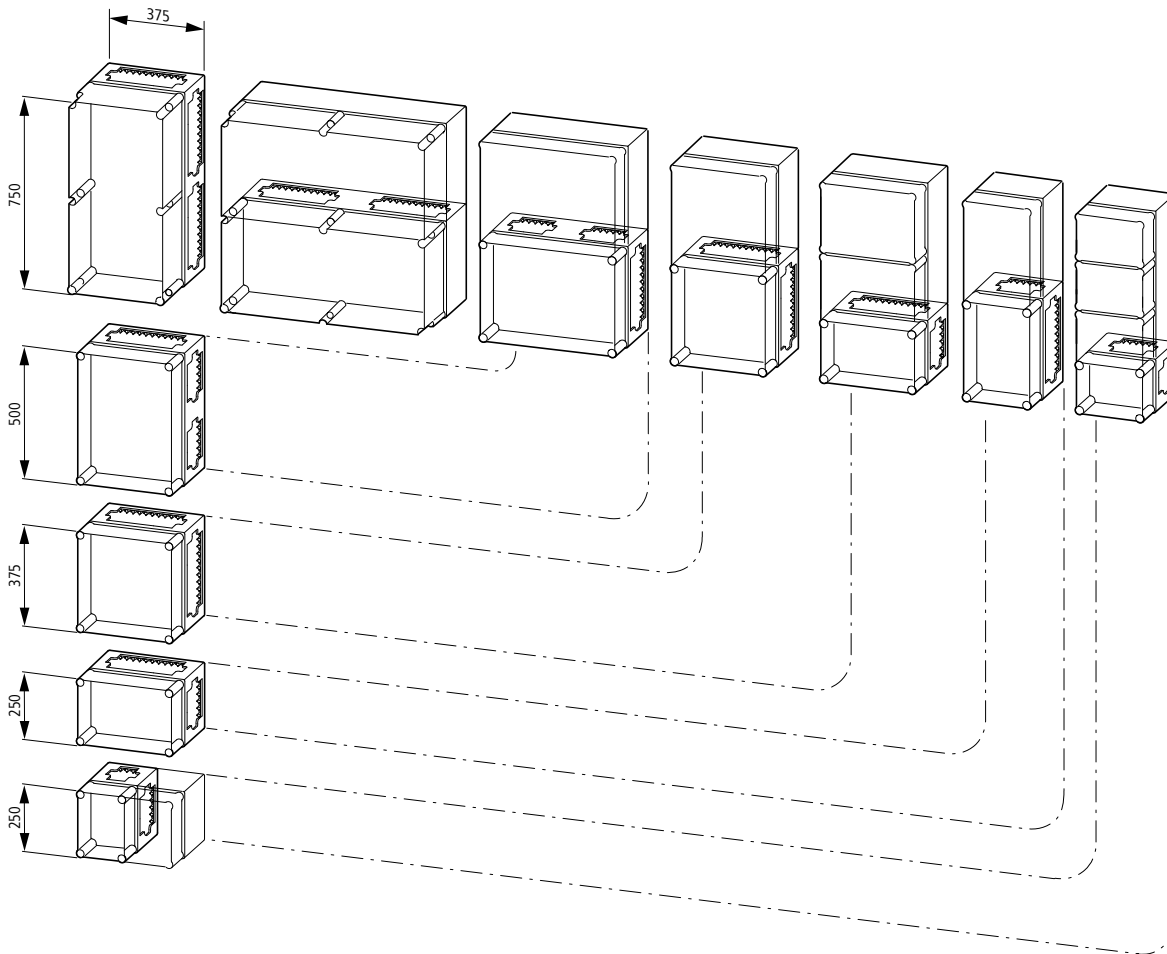







Basic enclosures

CI..., U-CI

Mounting of switchgear in distribution board enclosures

To install LV h.b.c. fuse bases, switch-disconnectors and circuit-breakers, pre-drilled mounting plates are available. In some cases, additional spacers HS50-CI are required.

The following table gives the largest number of devices that can be installed. PE and N terminals for the distribution board enclosures have not been included.

Device	Rated operational current	Max. no. of devices installable in distribution board combinations						Pre-drilled mounting plate or mounting plate	Spacer
									
	A	CI43(E)-200 Number	CI43(E)-200 (rotated by 90°) Number	CI44(E)-200 Number	CI45(E)-200 Number	CI48(E)-200 Number	CI48(E)-250 Number		
LV h.b.c. fuse bases									
GS00-160	100, 160	3	2	3	3			L3-CI43	HS50-CI
GS1	250	1	1	1	1			L3-CI43	HS50-CI
GS2	400	-	-	1	1	1		L3-CI43	HS50-CI
GS3	500	-	-	-	1	1		L3-CI43	HS50-CI
LV h.b.c. fuse switch-disconnectors									
GSTA00-160	100, 160	2	1	3	3			L3-CI43	HS50-CI
GSTA1	250	-	-	1	1			L3-CI43	HS50-CI
GSTA2	400	-	-	1	1	1		L3-CI43	HS50-CI
GSTA3	500	-	-	-	1	1		L3-CI43	HS50-CI
Switch-disconnectors, circuit-breakers¹⁾									
NZM1	160	2	1	2	2			M3-CI...	-
NZM2	250	1	1	2	2			M3-CI...	-
NZM3	630	-	-	-	1	1	1	M3-CI...	-
NZM4	1600	-	-	-	-	-	1	M3-CI...	-

Notes

¹⁾ Switches and accessories → Chapter 17: Compact circuit-breakers NZM, compact switch-disconnectors N up to 1600 A



Overview of busbar systems up to 1600 A (CI..., RS..., SKA...)

Rated operational current I _e A	Busbar cross-section		Busbar center-to-center distance mm	Surface-mounting devices		
	L1, L2, L3 mm	PE, N, PEN mm		RS...3-50	GST...00	GSTA...
160	12 x 5	12 x 5	40	-	●	-
250	20 x 5	20 x 5	50	●	●	●
400	20 x 10	20 x 5	50	●	●	●
630	20 x 15	20 x 10	50	●	●	●
1000	2 x 30 x 10	30 x 10	-	-	-	-
1600	3 x 40 x 10	2 x 20x15	-	-	-	-

- 5-conductor system up to 400 A with 1/1 cross-section possible
- 5-conductor system up to 630 A L1 - L3 with 1/1 cross-section, PE/N with 1/2 cross-section
- 25 A to 400 A fuses for mounting on busbar system up to 630 A
- Tinned copper busbars from 160 A to 630 A

Selection diagrams up to 630 A up to 5-pole (with or without fitted components) (CI..., SKA...)

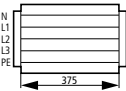
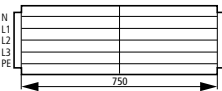
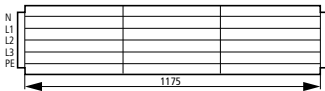
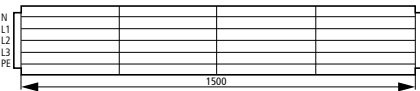
Busbar system in CI enclosure: Assembled from individual components for 1 up to 4 CI enclosures	Rated operational current A	Part no.						
		CI44-200	SH0635/4	CU20X5 ¹⁾	CU20X10 ¹⁾	CU20X15 ¹⁾²⁾	FL4-X	BS4-CI
	250	1	2	1.875	-	-	2	-
	400	1	2	0.75	1.125	-	2	-
	630	1	2	-	0.75	1.125	2	-
	250	2	3	3.75	-	-	2	1
	400	2	3	1.50	2.25	-	2	1
	630	2	3	-	1.50	2.25	2	1
	250	3	4	5.625	-	-	2	2
	400	3	4	2.25	3.375	-	2	2
	630	3	4	-	2.25	3.375	2	2
	250	4	5	7.50	-	-	2	3
	400	4	5	3.00	4.50	-	2	3
	630	4	5	-	3.00	4.50	2	3

Notes

- ¹⁾ In meters; applies for 5-pole system
- ²⁾ Assemble from CU20X10 and CU20X5



3-pole with fitted components

(5-pole without fitted components possible)
630 A-system max. 3 pole
(CI..., SKA...)

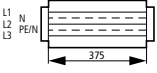
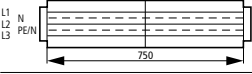
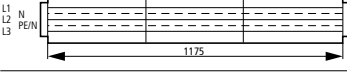
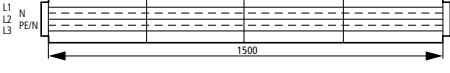
Busbar system in CI enclosure: Assembled from individual components for 1 up to 4 CI enclosures	Rated operational current A	Part no.						
		CI43-200	SH0635/3	CU20X5 ¹⁾	CU20X10 ¹⁾	CU20X15 ¹⁾²⁾	FL4-X	BS4-CI
	250	1	2	1.875	-	-	2	-
	400	1	2	0.75	1.125	-	2	-
	630	1	2	-	-	1.125	2	-
	250	2	3	3.75	-	-	2	1
	400	2	3	1.50	2.25	-	2	1
	630	2	3	-	-	2.25	2	1
	250	3	4	5.625	-	-	2	2
	400	3	4	2.25	3.375	-	2	2
	630	3	4	-	-	3.375	2	2
	250	4	5	7.50	-	-	2	3
	400	4	5	3.00	4.50	-	2	3
	630	4	5	-	-	4.50	2	3

Notes

- ¹⁾ In meters; applies for 5-pole system
- ²⁾ Assemble from CU20X10 and CU20X5 → 630 A system 3-pole only

**Selection diagrams up to 1000 A
up to 5 pole (CI..., SKA...)**

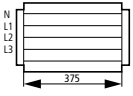
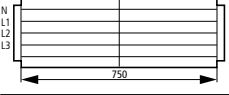
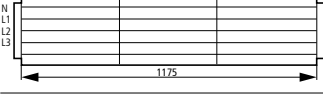
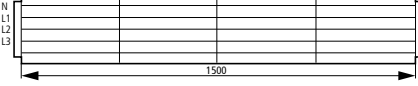
Busbar system in CI enclosure: Assembled from individual components for 1 up to 4 CI enclosures	Rated operational current A	Part no.				
		CI44-200	SH1005/4	CU30X10 ¹⁾	FL4-X	BS4-CI ¹⁾
	1000	1	2	3.00	2	-
	1000	2	3	6.00	2	1
	1000	3	4	9.00	2	2
	1000	4	5	12.00	2	3

Notes

- ¹⁾ In meters; applies for 5-pole system

To achieve even current loading (and heating) of the individual busbars, they must be connected in parallel with busbar terminals at a maximum spacing of 375 mm. Incoming and outgoing terminals are parallel switching points.

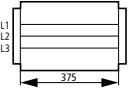
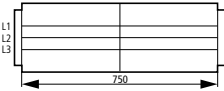
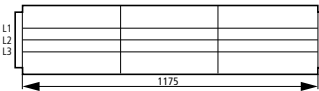
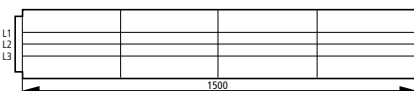

Selection diagrams up to 1600 A
3 pole

Busbar system in CI enclosure: Assembled from individual components for 1 up to 4 CI enclosures	Operating current A	Part no.				
		CI44-200	SH1603/4	CU40X10 ¹⁾	FL4-X	BS4-CI
	1600	1	2	3.375	2	-
	1600	2	3	6.75	2	1
	1600	3	4	10.125	2	2
	1600	4	5	13.50	2	3

Notes ¹⁾ In meters; applies for 5-pole system

To achieve even current loading (and heating) of the individual busbars, they must be connected in parallel with busbar terminals at a maximum spacing of 375 mm. Incoming and outgoing terminals are parallel switching points.

N, PE, PEN at 1600 A

In the 1600 A busbar system, two CU20X15 are each used as N, PE and PEN conductor. For an even current load, connect the busbars in parallel with a spacing of no more than 375 mm.

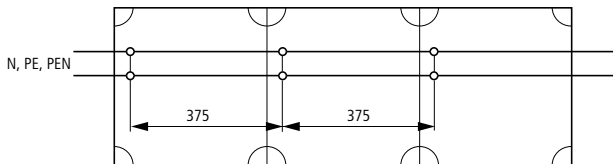

Transport split, busbar connection

With transport splits the busbar supports are offset from the knockouts to the enclosure inner and secured with an additional holder. This reduces the mounting area for components fitted on the busbars by distance 'a' between the busbar supports.

In end enclosures, transport splits should always be fitted to facilitate subsequent expansion.

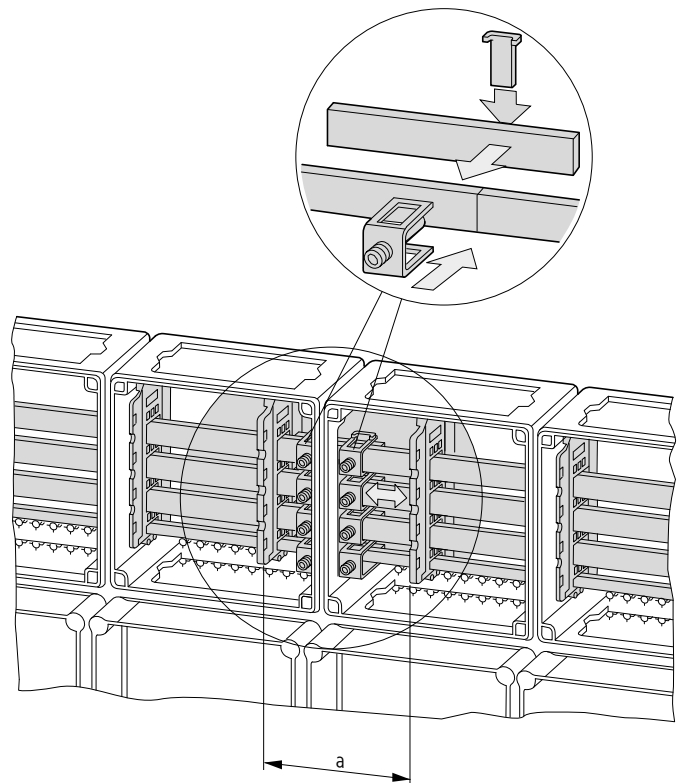

**Clearance between busbar supports
with transport split, busbar coupling kits**

Busbar support	Busbar system	Additional support bracket for busbar support	Clearance between busbar support mm	Terminal L1, L2, L3	N, PE, PEN
SH0165/2	160 A, 5 pole	HSH0632	125	K12X5-1	K12X5-1
SH0635/3	250 A, 5 pole	HSH-CI	175	K20X5	K20X5
	400 A, 5 pole	HSH-CI	175	K20X10	K20X5
	630 A, 3 pole	HSH-CI	125	K20X10	-
SH0635/4	250 A, 5 pole	HSH-CI	125	K20X5	K20X5
	400 A, 5 pole	HSH-CI	125	K20X10	K20X5
	630 A, 5 pole	HSH-CI	125	K20X10	K20X10
SH1005/4	1000 A, 5 pole	HSH-CI	125	AVS30L	AVS30PEN
SH1603/4	1600 A, 3 pole	HSH-CI	125	AVS40	-
SH0632		HSH0632	~170	-	K12X5, K20X5

For fitting a busbar support outside the knockouts, 2 × HSH-CI or 2 × HSH0632 are required. Exception: For SH0632 only 1 × HSH0632 is required.



Mounting frame selection

WW...-ID, WS...-ID

Wall-mounted distributor

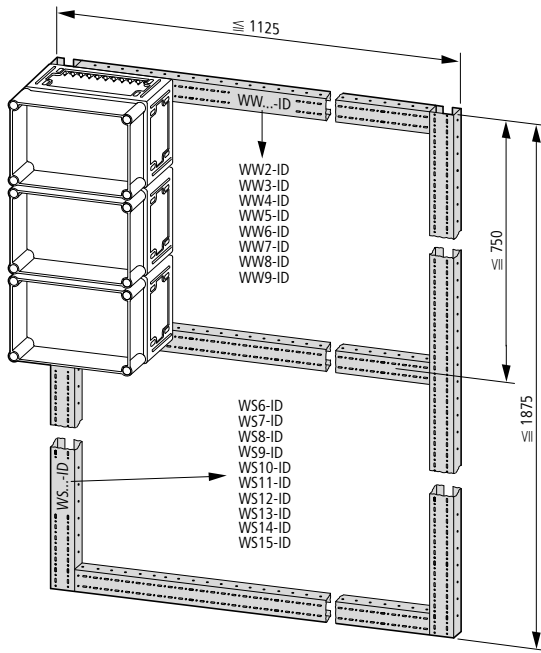

Profiles are selected in a 125 mm grid according to enclosure widths or heights.

Vertical sections:

WS...-ID

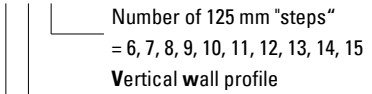

Horizontal section:

WW...-ID

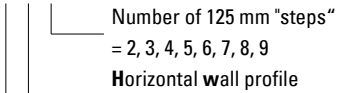

Vertical and horizontal profiles are connected with corner plates EVB-ID and cross plates KVB-ID (order separately).

The vertical profiles of the supporting frame are wall-mounted with two wall fixing brackets WBW...-ID each (order separately).

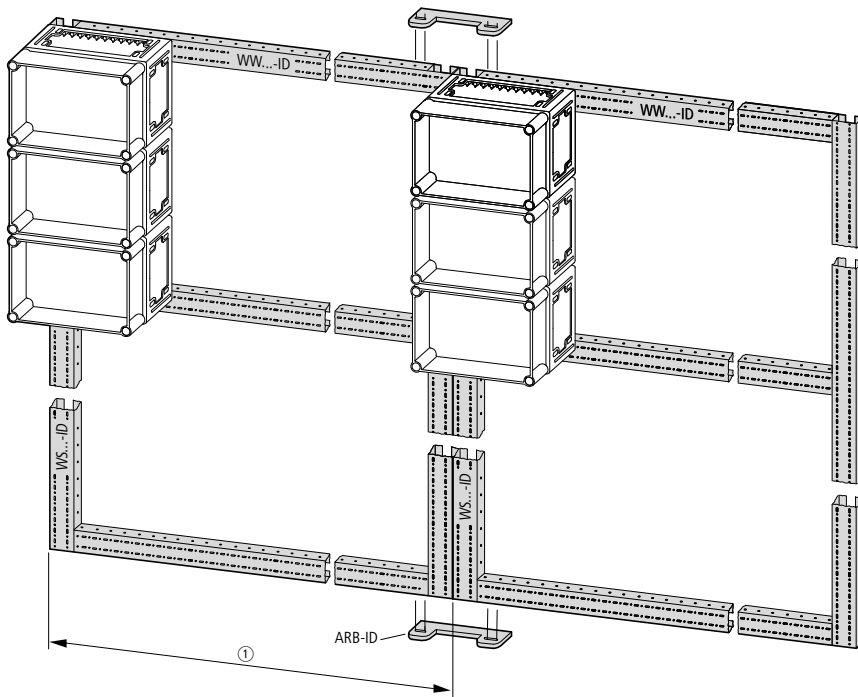

Where wall-mounted distribution boards wider than 1125 mm are required, these are split into several transportation units. The wall-mounted profiles are mechanically interconnected at the top or bottom with the help of an assembly bracket ARB-ID.

① Transport unit

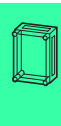

Mounting frame selection

WW...-ID, WS...-ID

Wall-mounting distribution board, supported on the floor

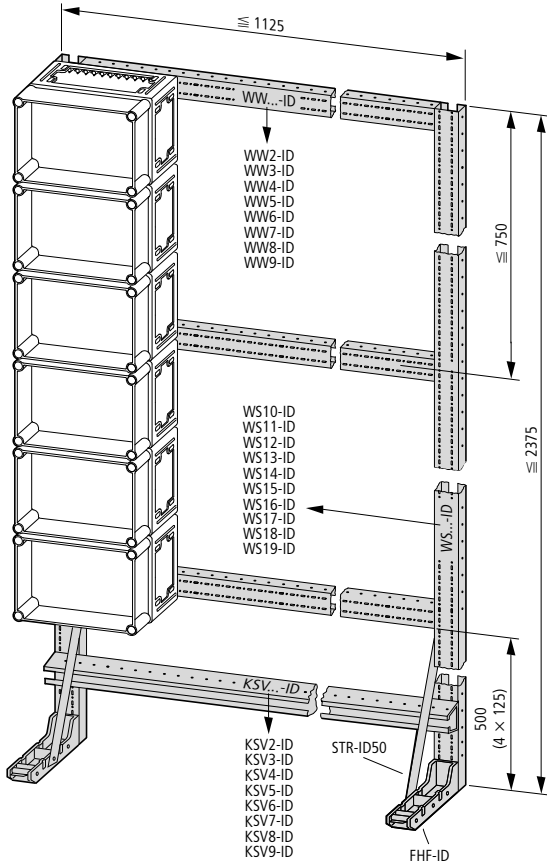

Profiles are selected in a 125 mm grid according to enclosure widths or heights. For vertical profiles, an additional 500 mm (4 x 125 mm) must be added (for KSV...).

Vertical sections:

WS...-ID

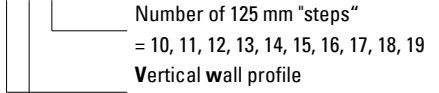

Horizontal section:

WW...-ID

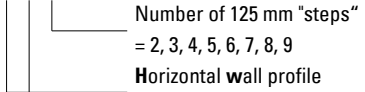

Vertical and horizontal profiles are connected with corner plates EVB-ID and cross plates KVB-ID (order separately).

The vertical profiles of the supporting frame are wall-mounted with two wall fixing brackets WBW...-ID each (order separately).

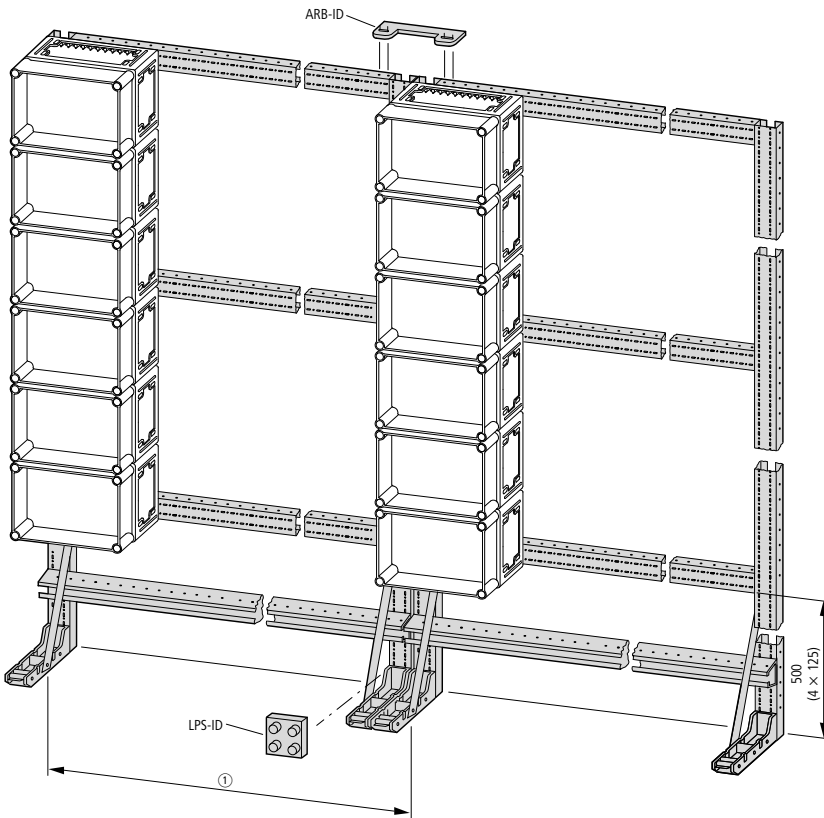

Where larger wall-mounted distribution boards are required, these are split into several transportation units. The wall-mounted profiles are mechanically interconnected with the help of an assembly bracket ARB-ID and straps LPS-ID.

① Transport unit

Floor-standing distributor

Larger distribution systems are assembled on support frames and laid out as floor-standing distribution boards with cable compartment cladding.

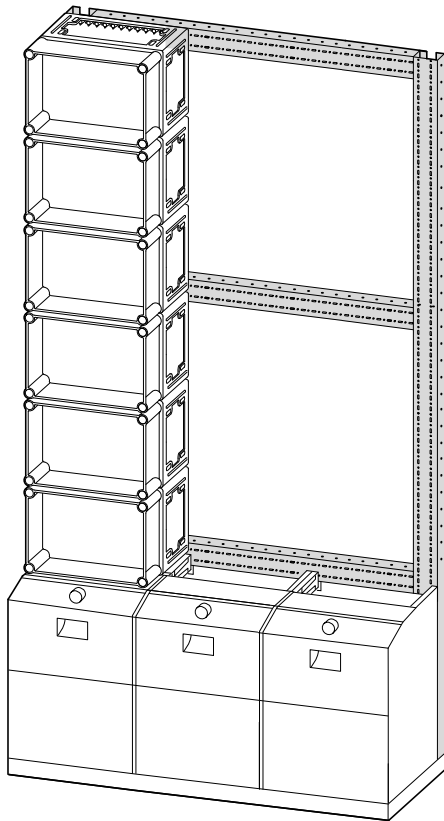

Floor-standing distribution board with 4 section width

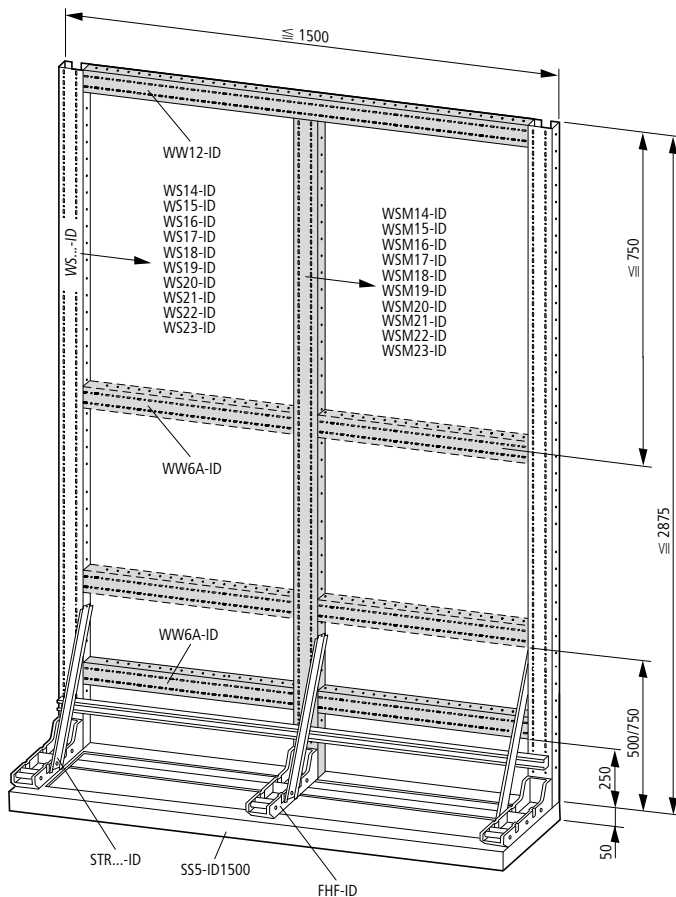

Profiles are selected in a 125 mm grid according to enclosure widths or heights.

Vertical sections:

WS...-ID

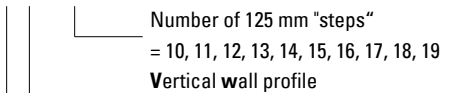

Horizontal section:

WW...-ID

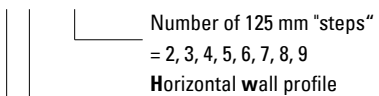

For distribution boards wider than 1500 mm a vertical center profile is required in addition. The horizontal profiles are then correspondingly smaller.

WSM...-ID

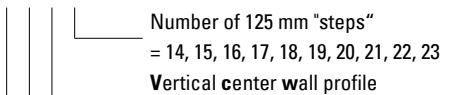

Vertical and horizontal profiles are connected with corner plates EVB-ID and cross plates KVB-ID (order separately).

The vertical profiles of the supporting frame are wall-mounted with two wall fixing brackets WBW...-ID each (order separately).

When mounting very heavy devices, e.g. NZM4, a reinforced framework is recommended. This can be achieved with the addition of a further center profile WSM...-ID and a foot FHF-ID.



Cable compartement cladding for floor-standing distribution board

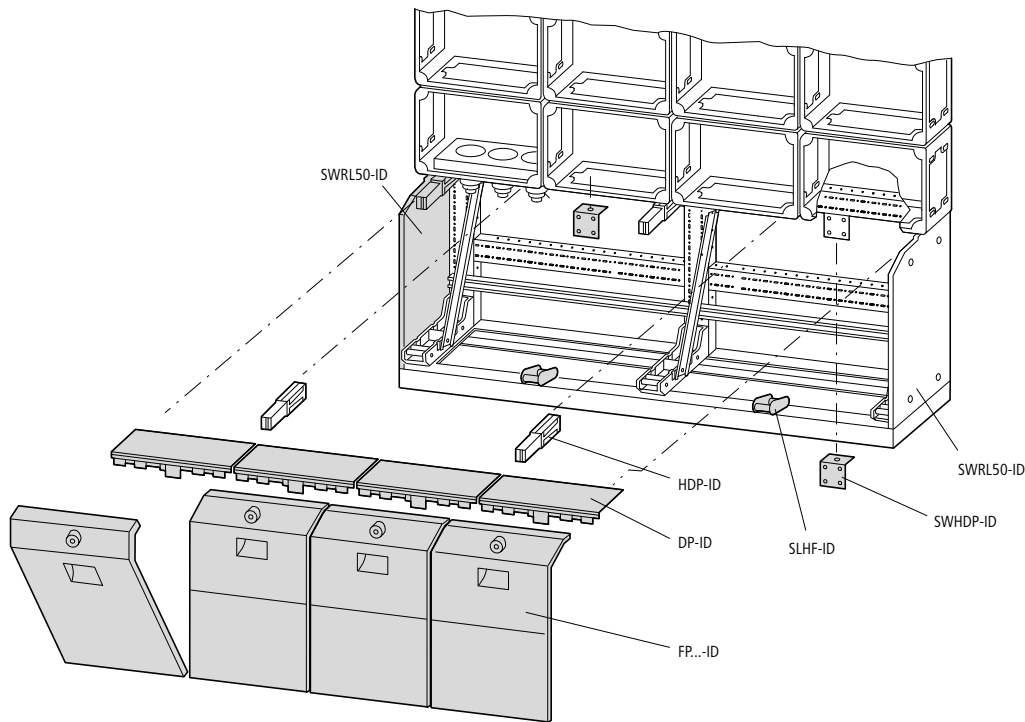

Floor-standing distribution boards are mounted on a base. Three cable compartment heights (250 mm, 500 mm and 750 mm plus 50 mm for the base) are available for inserting, sorting and marshalling cables. In addition, the base contains internal cable anchoring rails for T-foot clips. The front of the cable compartments is closed off with insulating front plates.

Combinability:

In addition, cable compartments of different heights can be combined. The side openings are closed off with intermediate plates. Left and righthand versions are available. The height is the difference of the different front plates.

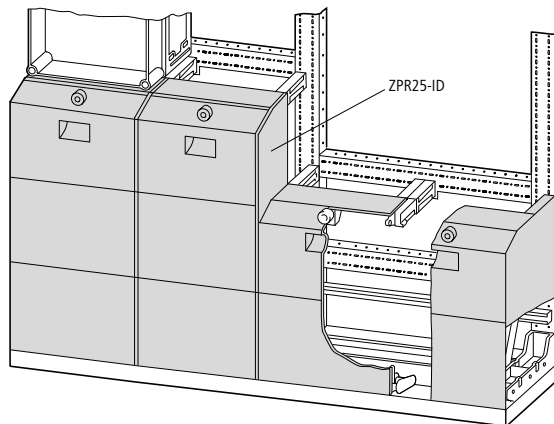
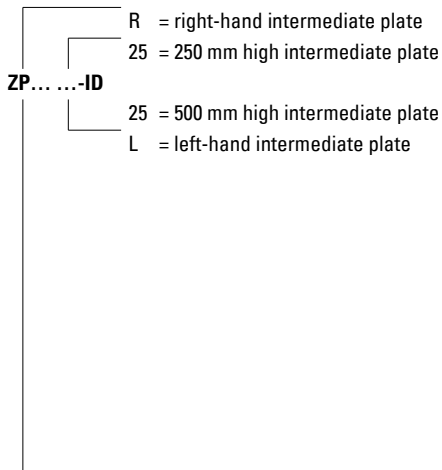

Tested to EN 60 439-4

Individual enclosure CI...X... and distribution board assembled from CI enclosures up to 630 A fulfil the additional requirements of EN 60 439-4. They are therefore suited for socket combinations and as system components for site distribution boards.



Connections to busbars

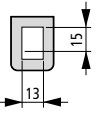
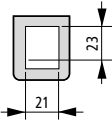
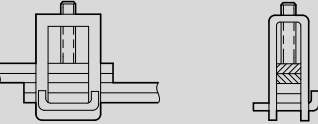
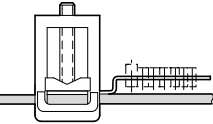
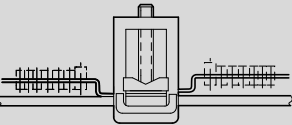
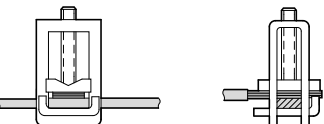
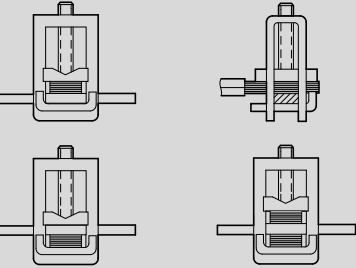
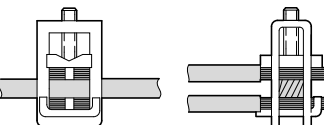
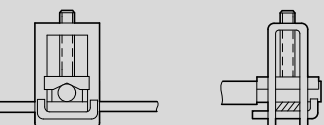





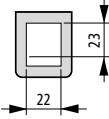
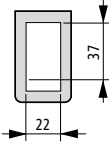
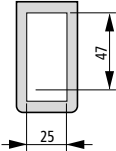



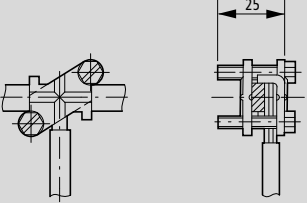
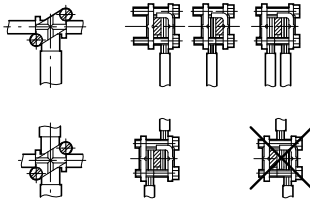
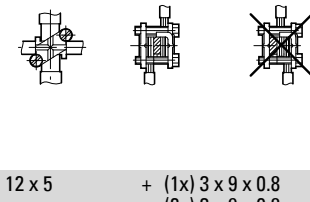
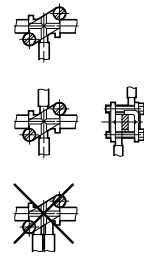
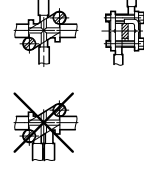
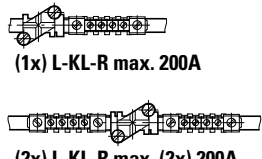

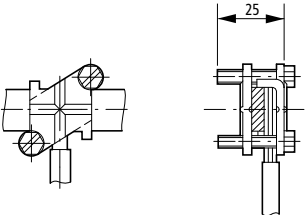
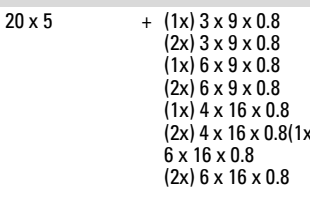
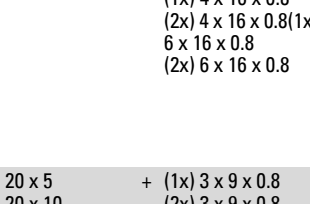

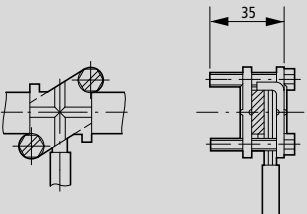
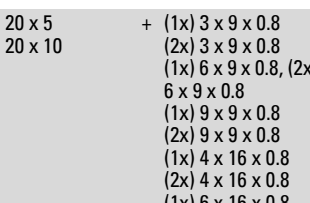
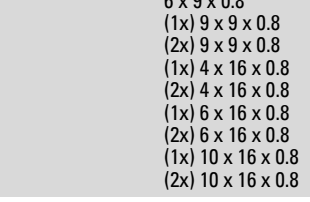

Type of connection	Terminal type K 12 x 5-1		K 12 x 5-2	
Copper busbar with Copper busbar	(2x) 12 x 5		(2x) 12 x 5 (3x) 12 x 5	
				
Copper busbar with (1x) strap L-KL-R (can be fitted with AK 16, AK 35)	(1x) 12 x 5	+ L-KL-R	(1x) 12 x 5 (2x) 12 x 5	+ L-KL-R
				
Copper busbar with (2x) strap L-KL-R (can be fitted with AK 16, AK 35)	-		(1x) 12 x 5 (2x) 12 x 5	+ (2x) L-KL-R
				
Copper busbar with copper strip	12 x 5	+ 3 x 9 x 0.8 6 x 9 x 0.8	12 x 5	3 x 9 x 0.8 6 x 9 x 0.8 9 x 9 x 0.8 4 x 16 x 0.8 6 x 16 x 0.8 10 x 16 x 0.8
				
Copper busbar with (2x) copper strip	-		12 x 5	+ (2x) 3 x 9 x 0.8 (2x) 4 x 16 x 0.8
				
Copper busbar with (4x) copper strip	-		12 x 5	+ (4x) 3 x 9 x 0.8
				
Copper busbar with round copper conductor ¹⁾	12 x 5	+ 16 ² ... 25 ²	12 x 5	+ 25 ²
				

¹⁾ Flexible with ferrule

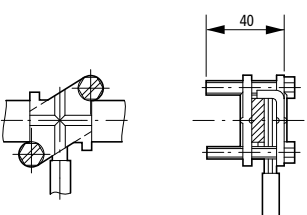
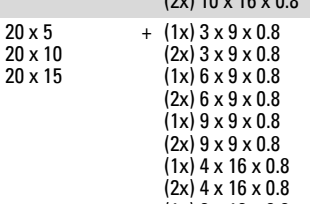
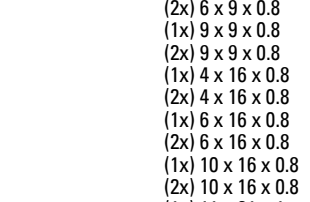
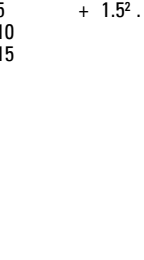

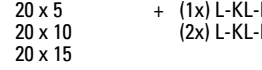
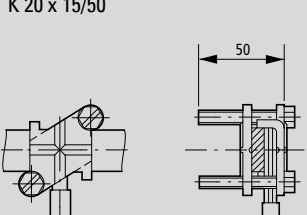
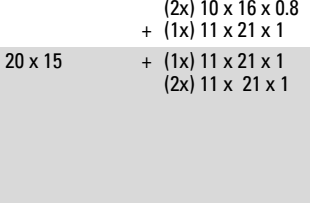
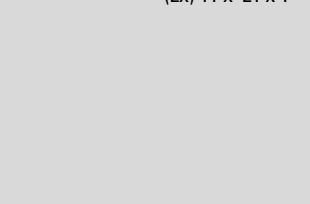
Type of connection	Terminal type K 20 x 5	 K 20 x 10	 K20 x 15	 K20 x 15
Copper busbar with Copper busbar	(2x) 20 x 5 (2x) 20 x 10	(2x) 20 x 5 (2x) 20 x 10 (2x) 20 x 15	(2x) 20 x 10 (2x) 20 x 15	(2x) 20 x 10 (2x) 20 x 15
Copper busbar with (1x) strap L-KL-R (can be fitted with AK 16, AK 35)	(1x) 20 x 5 (2x) 20 x 5 (1x) 20 x 10	+ L-KL-R (1x) 20 x 5 (2x) 20 x 5 (1x) 20 x 10 (2x) 20 x 10 (1x) 20 x 15	+ L-KL-R (2x) 20 x 10 (1x) 20 x 15 (2x) 20 x 15	+ L-KL-R
Copper busbar with (2x) strap L-KL-R (can be fitted with AK 16, AK 35)	(1x) 20 x 5	+ (2x) L-KL-R (1x) 20 x 5 (2x) 20 x 10 (1x) 20 x 15	+ (2x) L-KL-R (2x) 20 x 10 (1x) 20 x 15 (2x) 20 x 15	+ (2x) L-KL-R
Copper busbar with copper strip	20 x 5	+ 3 x 9 x 0.8 6 x 9 x 0.8 9 x 9 x 0.8 4 x 16 x 0.8 6 x 16 x 0.8 10 x 16 x 0.8	20 x 5 20 x 10 20 x 15 + 3 x 9 x 0.8 6 x 9 x 0.8 9 x 9 x 0.8 4 x 16 x 0.8 6 x 16 x 0.8 10 x 16 x 0.8 11 x 21 x 1	20 x 5 20 x 10 20 x 15 + 10 x 16 x 0.8 11 x 21 x 1
Copper busbar with (2x) copper strip	20 x 5	+ 2x) 3 x 9 x 0.8 (2x) 4 x 16 x 0.8	20 x 5 20 x 10 20 x 15 + 2x) 3 x 9 x 0.8 (2x) 6 x 9 x 0.8 (2x) 9 x 9 x 0.8 (2x) 4 x 16 x 0.8 (2x) 6 x 16 x 0.8 (2x) 10 x 16 x 0.8	20 x 5 20 x 10 20 x 15 + (2x) 6 x 9 x 0.8 (2x) 9 x 9 x 0.8 (2x) 6 x 16 x 0.8 (2x) 10 x 16 x 0.8 (2x) 11 x 21 x 1
Copper busbar with (4x) copper strip	20 x 5	+ (4x) 3 x 9 x 0.8	20 x 5 20 x 10 20 x 15 + 4x) 3 x 9 x 0.8 (4x) 6 x 9 x 0.8 (4x) 9 x 9 x 0.8	20 x 5 20 x 10 20 x 15 + (4x) 6 x 9 x 0.8 (4x) 9 x 9 x 0.8



Terminal type	Type of connection		Copper busbar with round conductor ¹⁾	Copper busbar with strap L-KL-R (can be fitted with AK 16, AK 35)
	Copper busbar with copper strip			
K 12 x 5/25 	 	 	 	<p>(1x) L-KL-R max. 200A</p> <p>(2x) L-KL-R max. (2x) 200A</p>
K 12 x 5/25	12 x 5	+ (1x) 3 x 9 x 0.8 (2x) 3 x 9 x 0.8 (1x) 6 x 9 x 0.8 (2x) 6 x 9 x 0.8 (1x) 4 x 16 x 0.8 (2x) 4 x 16 x 0.8 (1x) 6 x 16 x 0.8 (2x) 6 x 16 x 0.8	12 x 5 + 1.5 ² ... 6 ²	12 x 5 + (1x) L-KL-R (2x) L-KL-R
K 20 x 5/25 	 	 	 	<p>(1x) L-KL-R</p> <p>(2x) L-KL-R</p>
K 20 x 5/25	20 x 5	+ (1x) 3 x 9 x 0.8 (2x) 3 x 9 x 0.8 (1x) 6 x 9 x 0.8 (2x) 6 x 9 x 0.8 (1x) 4 x 16 x 0.8 (2x) 4 x 16 x 0.8 (1x) 6 x 16 x 0.8 (2x) 6 x 16 x 0.8	20 x 5 + 1.5 ² ... 6 ²	20 x 5 + (1x) L-KL-R (2x) L-KL-R
K 20 x 10/35 	 	 	 	<p>(1x) L-KL-R</p> <p>(2x) L-KL-R</p>
K 20 x 10/35	20 x 5 20 x 10	+ (1x) 3 x 9 x 0.8 (2x) 3 x 9 x 0.8 (1x) 6 x 9 x 0.8, (2x) 6 x 9 x 0.8 (1x) 9 x 9 x 0.8 (2x) 9 x 9 x 0.8 (1x) 4 x 16 x 0.8 (2x) 4 x 16 x 0.8 (1x) 6 x 16 x 0.8 (2x) 6 x 16 x 0.8 (1x) 10 x 16 x 0.8 (2x) 10 x 16 x 0.8	20 x 10 + 1.5 ² ... 6 ²	20 x 10 + (1x) L-KL-R (2x) L-KL-R
K 20 x 15/40 	 	 	 	<p>(1x) L-KL-R</p> <p>(2x) L-KL-R</p>
K 20 x 15/40	20 x 5 20 x 10 20 x 15	+ (1x) 3 x 9 x 0.8 (2x) 3 x 9 x 0.8 (1x) 6 x 9 x 0.8 (2x) 6 x 9 x 0.8 (1x) 9 x 9 x 0.8 (2x) 9 x 9 x 0.8 (1x) 4 x 16 x 0.8 (2x) 4 x 16 x 0.8 (1x) 6 x 16 x 0.8 (2x) 6 x 16 x 0.8 (1x) 10 x 16 x 0.8 (2x) 10 x 16 x 0.8 + (1x) 11 x 21 x 1	20 x 5 + 1.5 ² ... 6 ² 20 x 10 20 x 15	20 x 5 + (1x) L-KL-R 20 x 10 20 x 15
K 20 x 15/50 	 	 	 	<p>(1x) L-KL-R</p> <p>(2x) L-KL-R</p>
K 20 x 15/50	20 x 15	+ (1x) 11 x 21 x 1 (2x) 11 x 21 x 1	20 x 15 + 1.5 ² ... 6 ²	20 x 15 + (1x) L-KL-R (2x) L-KL-R

¹⁾ Flexible with ferrule

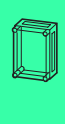

Technical data

	CI23...	CI43...	CI44...	CI45...	CI48...	
General						
Standards	IEC/EN 60529 EN 50262 DIN 43656 DIN 43660 EN 60439-4 for individual CI...X enclosures and distribution boards assembled from CI enclosures up to 680 A. Can therefore be used for socket combinations and as components for site distribution boxes.					
Climatic proofing	Damp heat, constant, to IEC 60068-2-78 Damp heat, cyclic, to IEC 60068-2-30					
Ambient temperature	°C	-40 - 80				
Protection type	IP65					
Radiated heat dissipation	→ Page 20/86					
Additional technical data for UL/CSA approved devices	See UL report File No. E54120 → Chapter 23					
Material properties						
Material						
Base	Glass-fibre reinforced polycarbonate					
Cover	Non-reinforced polycarbonate					
Surface treatment	Corrosion-resistant					
Color						
Base	RAL 7032, pebble grey					
Cover	Transparent, opaque or RAL 7032, pebble grey					
Material properties						
Electrical						
Creepage resistance to IEC 60112						
Base	KB160, KC175					
Cover	KB100, KC200					
Surface treatment to IEC 60093	$\Omega \times 10^{13}$	> 1				
Dielectric strength to IEC 60243-1	kV/mm	30				
Thermal						
Continuous thermal stability						
Housing	°C	-40...120				
Enclosure bolt	°C	85				
Sealing	°C	80				
Mechanical						
IK code to EN 50102	Please enquire					
Load bearing capacity	kg	5	10	20	30	40
Chemical resistance						
Resistant	Acids < 10 %, mineral oil, alcohol, petrol, grease, saline solutions					
Partially resistant	Acids > 10 %					
Non-resistant	Alkalis, paraffin					
Atmospheric						
Saline spray	IEC 60068-2-11					
UV resistance	Beneath protective canopy					
Water absorption to EN ISO 62	%	0.29				
Flammability characteristics						
Glow wire to VDE 0471 Part 2	°C	960				
UL						
Base	UL94V1					
Cover	UL94V2					
Halogen free	Yes (lower section and cover)					



			CI...					
General								
Components			Components of switchgear assemblies are type-tested. They are suitable for self-assembly of switchgear installations, distribution boards and control panels.					
Mounting units			The reference values stated apply to the basic elements of the distribution board. For devices fitted, terminals etc., their reference and rated values apply.					
Standards								
TTA – Type Tested Assemblies			IEC/EN 60439-1, VDE 0660 Part 500					
Low-voltage fuses			IEC/EN 60269, VDE 0636					
Type test			VDE 0660 Part 500, IEC/EN 60439-1					
Creepage and clearance distances			III/3 to IEC/EN 60439-1					
Flammability characteristics - Glow rod test			VDE 0304 Part 3 level IIb, level IIb to IEC 60707					
Regulations for fire-resistance tests of electrical products, their modules and components, glow wire test			VDE 0471 Part 2					
Operating and environmental conditions to VDE 0660 Part 500								
Ambient temperature								
Mean value over 24 hours		°C	35					
Limit values		°C	-5...40					
Indoor installation								
Relative humidity								
at 20 °C		%	90					
at 40 °C		%	50					
Installation altitude		m	max. 2000					
Protection type								
CI enclosure			IP65					
KST cable entry from below			IP65					
KST cable entry from above			IP64					
Cable entry open			IP00					
Modular grid (enclosure basic dimensions)		mm	25 (DIN 43660)					
Color								
Base			RAL 7032, pebble grey					
Cover			Transparent, opaque or RAL 7032, pebble grey					
			CI...-NA: Transparent cover, opaque					
Surface protection with metals			Galvanized, passivated					
Radiated heat dissipation			→ Page 20/86					
Electrical characteristics								
Busbar system								
Rated operating voltage		U_e V AC	690	690	690	690	690	690
Rated insulation voltage								
AC		U_i V AC	690	690	690	690	690	690
DC		U_i V DC	800	800	800	800	800	800
Rated operational current		I_e A	160	250	400	630	1000	1600
Rated short-time withstand current								
t = 0.1 s cos φ = 0.2		I_{cw} kA	20	25	35	40	80	80
Rated short-time withstand current t = 1 s		I_{cw} kA	4	7	14	28	50	66
Rated peak withstand current		I_{pk} kA	40	52.5	73.5	84	176	176
Distance between busbar supports		mm	≤ 375	≤ 375	≤ 375	≤ 375	≤ 375	≤ 375



Radiated heat dissipation

CI...

CI...			
Radiated heat dissipation of the insulated enclosures CI	Part no.	Dimensions W x H x D mm	Heat dissipation W
Max. radiated heat dissipation of the CI insulated enclosures with separate mounting, ambient air temperature +20 °C	CI23...-125	187.5 x 250 x 150	33
	CI23...-150	187.5 x 250 x 175	36
	CI43...-125	375 x 250 x 150	46
	CI43...-150	375 x 250 x 175	50
	CI43...-200	375 x 250 x 225	56
	CI44...-125	375 x 375 x 150	66
	CI44...-150	375 x 375 x 175	68
	CI44...-200	375 x 375 x 225	72
	CI44...-250	375 x 375 x 275	78
	CI45...-200	375 x 500 x 225	89
	CI48...-200	375 x 750 x 225	138
	CI48...-250	375 x 750 x 275	164
	Max. radiated heat dissipation of the CI insulated enclosures with use in distribution boards to VDE 0660 Part 500	CI23-...	187.5 x 250 x 150 187.5 x 250 x 175
CI43-...		375 x 250 x 150 375 x 250 x 175 375 x 250 x 225	42
CI44-...		375 x 375 x 150 375 x 375 x 175 375 x 375 x 225 375 x 375 x 275	54
CI45-...		375 x 500 x 225	67
CI48-...		375 x 750 x 225 375 x 750 x 275	93

Notes

When calculating the heat dissipation, the quadratic relationship of current with the rated diversity factor α must be considered.

$$P_v = I^2 \times R$$

$$P_v' = P_v \times \alpha^2$$

If no data is available concerning the load relationships of the individual circuits, the rated diversity factor is selected conform to VDE 0660 Part 500.



CI..., CL..., ML...

Dimensions

Insulated enclosures

CI123...
RS.../I23...
GS00/I23...
GSTA00/I23E

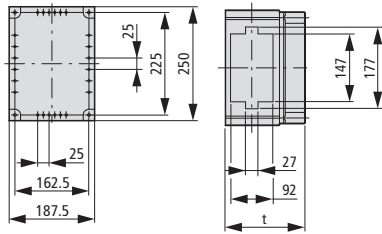

t = 150/175 mm

CI43...
KST43..., Dimension with gland plates → Page 20/11
K...KST43..., Dimension with gland plates → Page 20/38
ZG/I43E-G-...
RS.../I43...
GS00.../I43...
GSTA00.../I43...

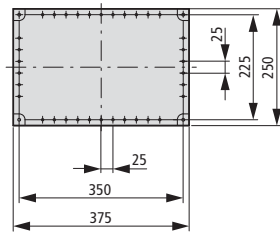

t = 150/175/225 mm

CI44...
KST44..., Dimension with gland plates → Page 20/12
K...KST44..., Dimension with gland plates → Page 20/39
SKA...-I44, ZG/I44E-...
ESK.../I44, EPEN.../I44
RSK.../I44, RS.../I44...
GS2/I44, GSTA.../I44...

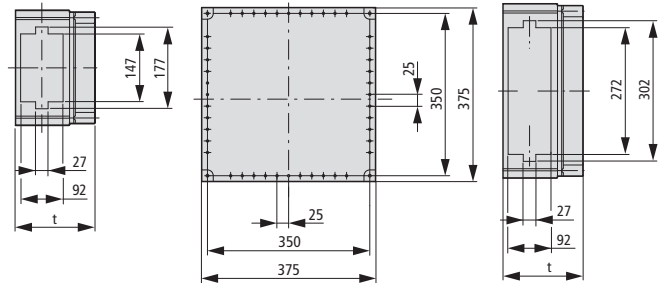

t = 150/175/225//275 mm

CI45...
ZG/I45E-...
GS.../I45E
GSTA.../I45E

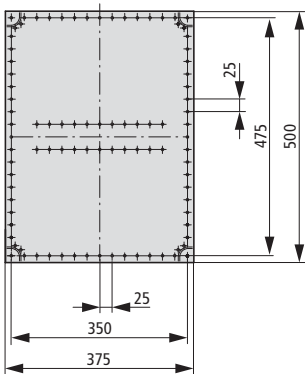

t = 225 mm

CI48...
KST48..., Dimension with gland plates → Page 20/13
K...KST48..., Dimension with gland plates → Page 20/39
ZG/I48-...
GSTA.../I48E GS.../I48E

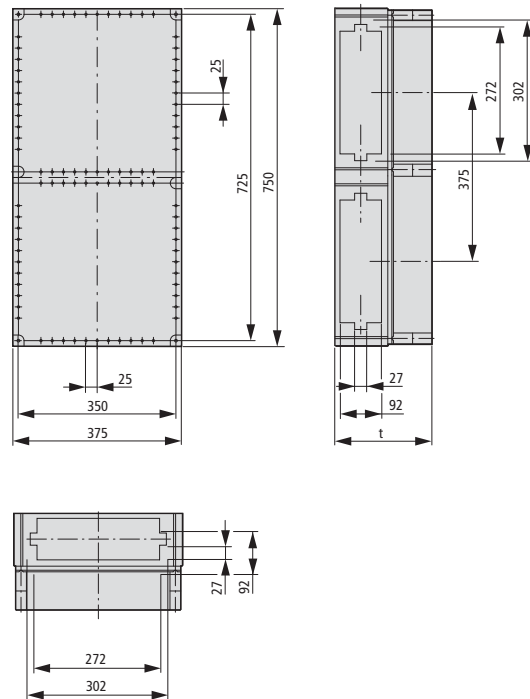

t = 225/275 mm

Mounting rails

CL...

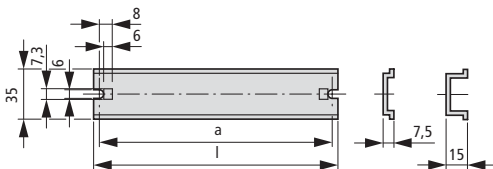

Part no.	l	a
CL2	170.5	162.5
CL3	233	225
CL4	358	350
CL2-15	170.5	162.5
CL3-15	233	225
CL4-15	358	350

Module mounting rail

ML...

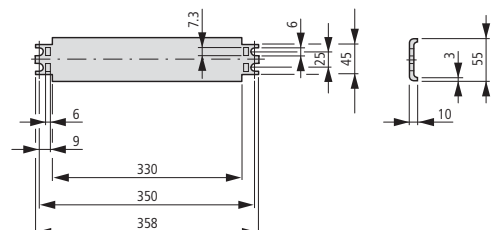

M3-CI..., IM4-CI..., W..., FL..., ZRF..., AE/..., AV/...

Mounting plates

M3-CI-...

IM4-CI-...

M3-CI48

IM4-CI48

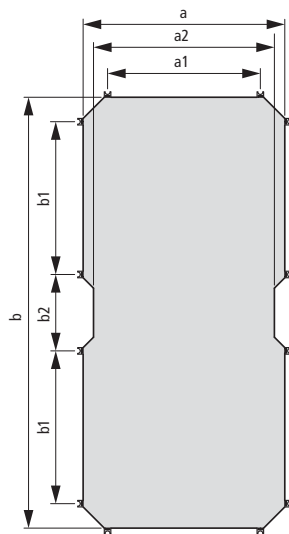
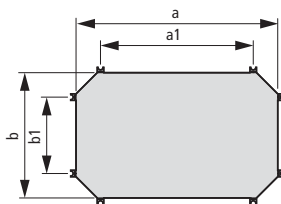

Part no.	a	b	a1	b1	a2	b2
M3-CI23, IM4-CI23	142.5	205	62.5	125	-	-
M3-CI43, IM4-CI43	330	205	250	125	-	-
M3-CI44, IM4-CI44	330	330	250	250	-	-
M3-CI45	330	455	250	375	-	-
M3-CI48, IM4-CI48	330	705	250	250	296	125

Insulated mounting plate IM4-...: 4 mm thick
Mounting plate M3-... 3 mm thick

Wall fixing bracket

W.../...

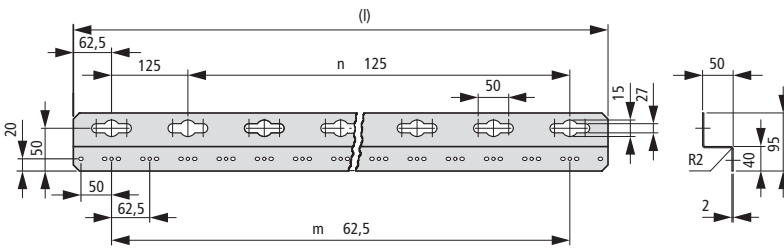

Part no.	l	n	m
W4/8	625	4	8
W6/8	875	6	12
W8/16	1125	8	16
W10/20	1375	10	20
W16/32	2125	16	32

Flanges spacers

FL1-...

FL2-...

FL3-...
ZRF3

FL4-...
ZRF4

FL...

ZRF3
ZRF4

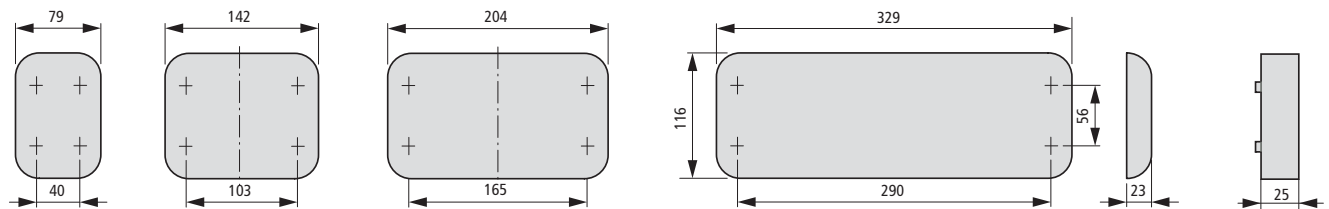

MCB enclosure

MCB distribution board enclosure

AE/I23

AV/I23 Dimensions identical but rotated by 90°

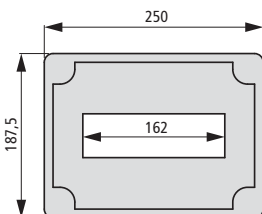

AE/I43

AV/I43 Dimensions identical but rotated by 90°

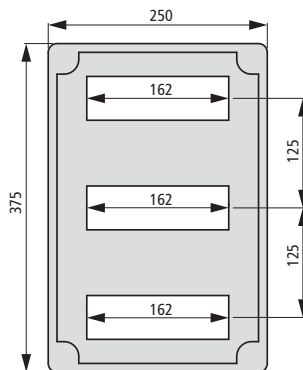

AE/I44

AV/I44 Dimensions identical but rotated by 90°

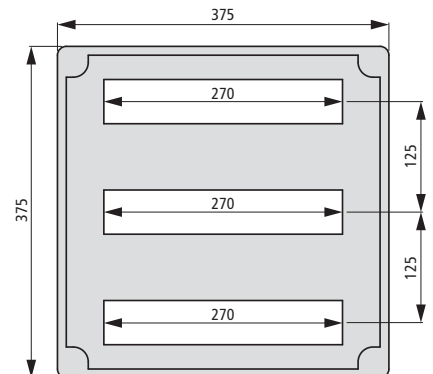

GA-..., MCCB1-..., MCCB2-...

Protective cover

GA-0/I23

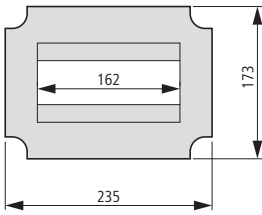

GA-0/I43

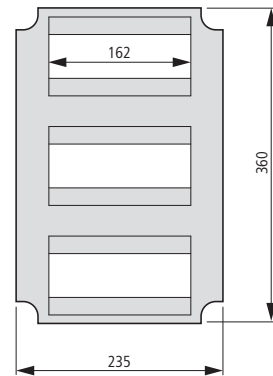

GA-0/I44

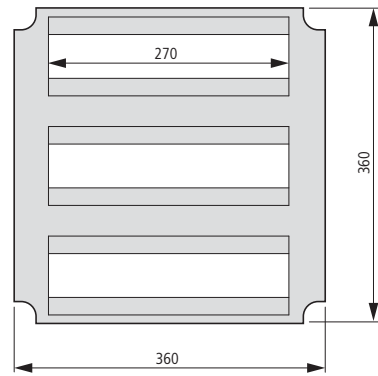

GA-RS-I23

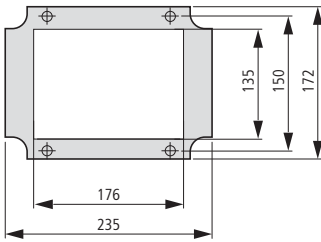

GA-RS-I43

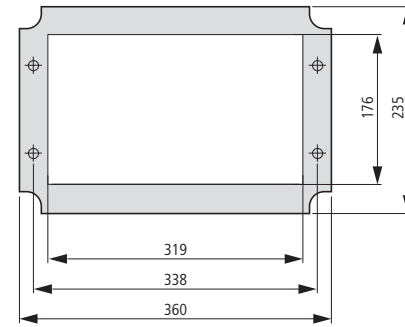

GA-RS-I43-G

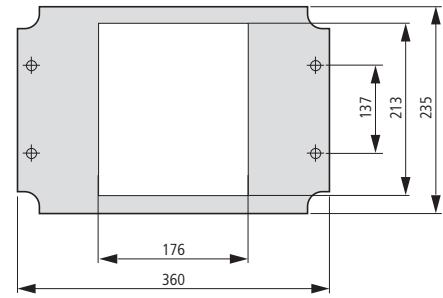

GA-RS-I44

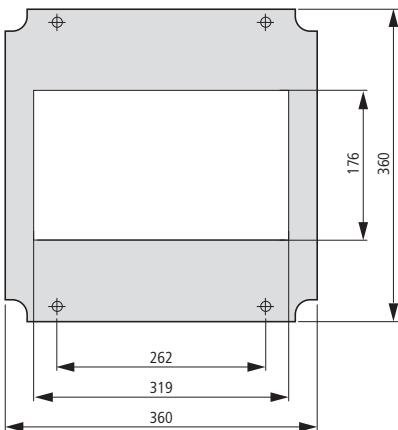

Prepared MCCB enclosures

MCCB1-63/I23E-150

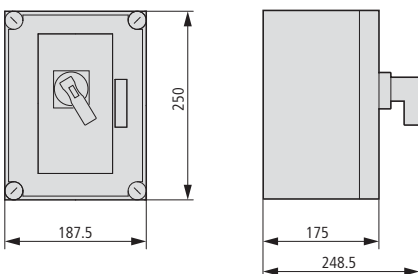

MCCB.../I43E-...

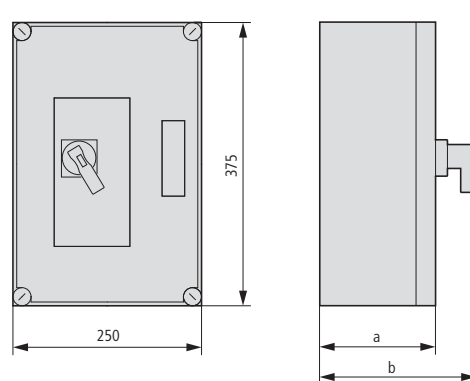

Part no.	a	b
MCCB1-125/I43E-150	175	248.5
MCCB1-160/I43E-200	225	298.5
MCCB2-200/I43E-200	225	298.5

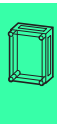

MCCB2-..., MCCB3-..., T-CI..., K...-A

Prepared MCCB enclosures

MCCB.../I45E-200

MCCB3-630/148/143E-200

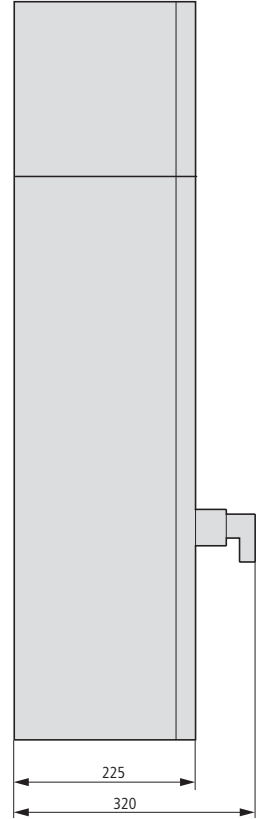
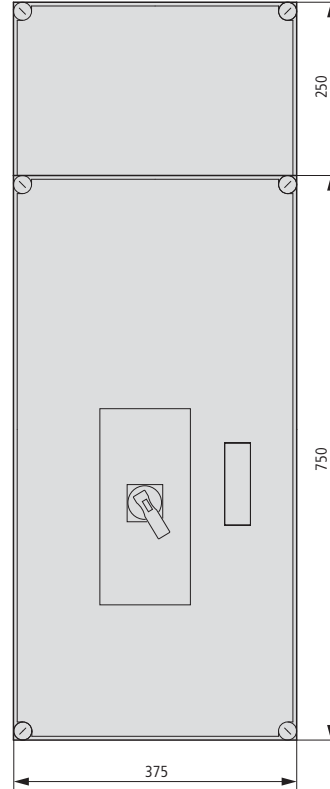
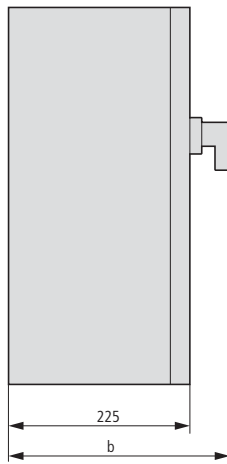
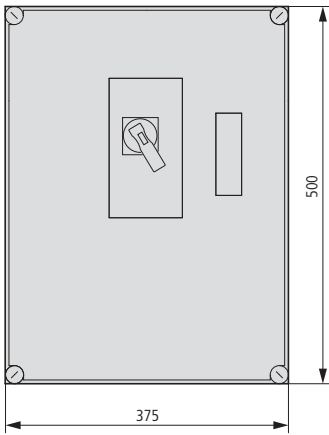

Part no.	b
MCCB2-250/I45E-200	298.5
MCCB3-400/I45E-200	320

Doors

T-CI23

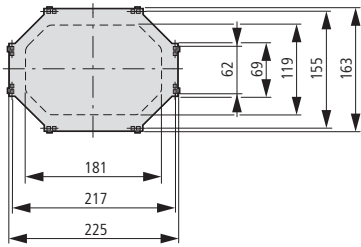

T-CI43

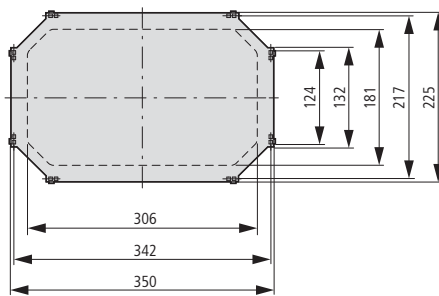

T-CI44

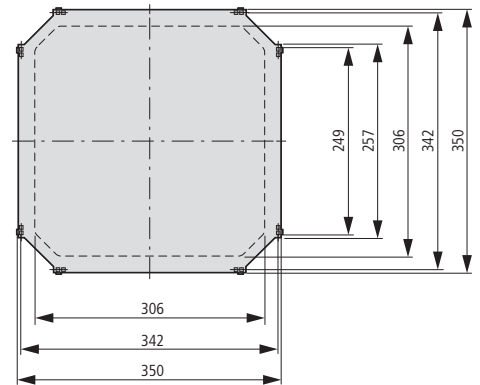

Hinged flaps

K-A

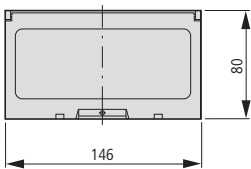

KG-A

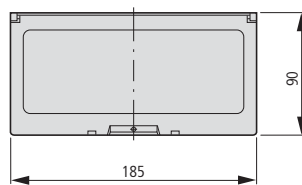

D...-Ci...-RAL7032-STV, FL... STV..., K...

Openings of covers (D...STV) and flanges (FL...) for socket devices

European socket (Schuko) with grounding provisions, 16 A, 5-pole

CEE, 16-125 A, 5-pole

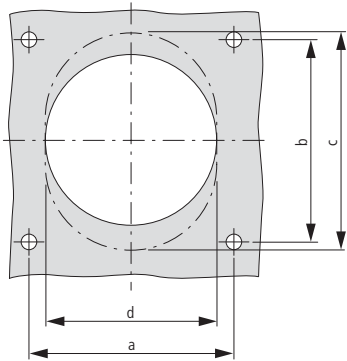

Part no.	a mm	b mm	c mm	d mm
Cover 16 A	45	45	-	47
Flange 16 A	52	52	-	57

Part no.	a mm	b mm	c mm	d mm
16 A	90	90	-	78
32 A	90	90	-	87
63 A	90	90	98	92
125 A	90	90	107	94

Terminals

K.../1

K.../4

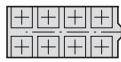

Part no.	a	a1	a2	a3	b	b1	c	a5
K95/1/N	37	-	18.5	3	115	100	88	-
K95/4	130	100	15	3	115	100	88	31
K150/1	37	-	18.5	3	115	100	105	-
K150/4	130	100	15	3	115	100	105	31
K240/1	52	-	26	3	115	100	120	-
K240/4	190	150	20	3	115	100	120	46
K2X240/1	68	-	34	4	140	125	127	-
K2X240/4	254	200	27	4	140	125	127	62

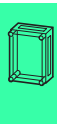
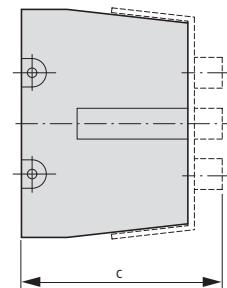
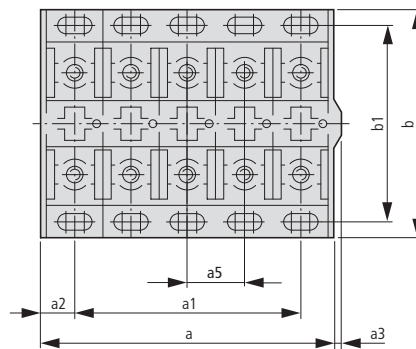

System overview

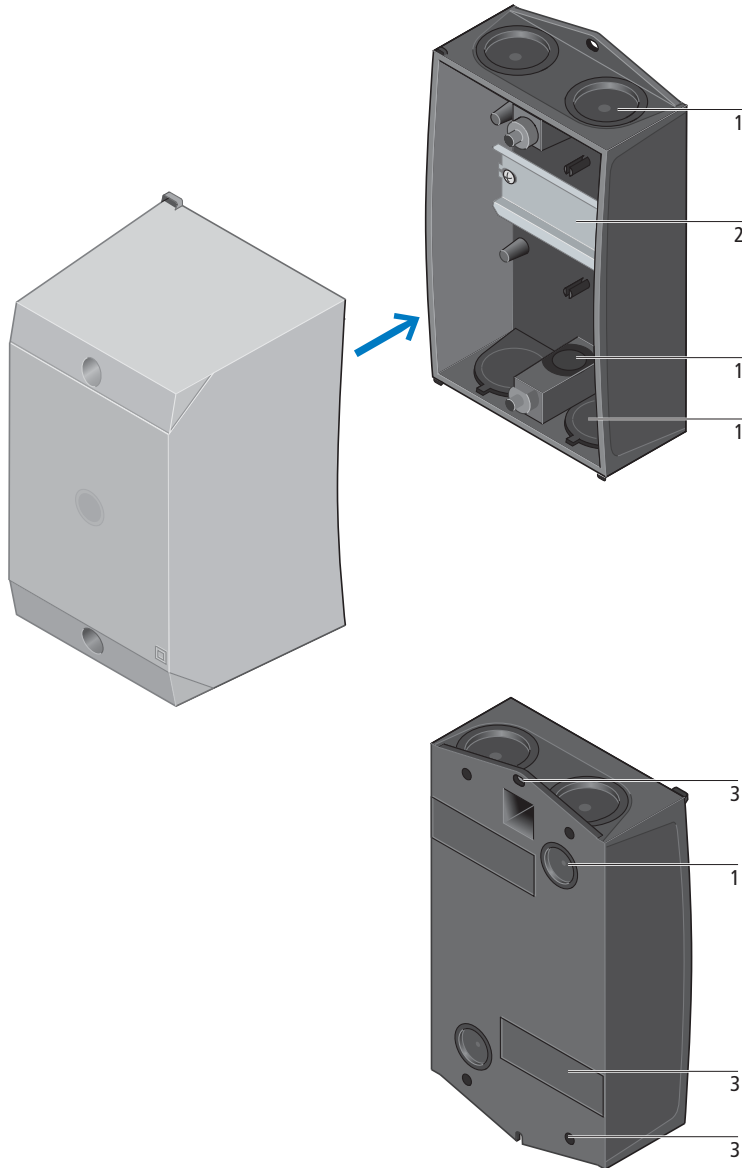

General	
Protection type IP65 (except CI-K2-80-A)	
Five basic sizes (floor area of enclosure lower section)	
Two overall depths per base surface (exception: CI-K1 enclosure depth always 95 mm, CI-K2-80-... enclosure depth always 80 mm)	
Enclosure made of glass-fibre reinforced with self-extinguishing polycarbonate, halogen free	
Captive gasket	
Enclosure base RAL 9005)	
Black (matt)	
Enclosure cover RAL 7035, light grey (matt)	
Metric cable entries	1
CI-K1 and CI-K2:	
metric cable entry knockouts with push-through cable entry diaphragm in the sides, top and bottom and also in the rear wall	
CI-K1H, CI-K2H:	
metric cable entry knockouts in the enclosure sides, top and bottom	
CI-K3 to CI-K5:	
metric cable entry knockouts in the sides, top and bottom and also in the rear wall	
Control cable entry with CI-K2	
Metric cable glands to EN 50 262	
Push-through metric cable grommets	
→ Page 20/95, → Chapter 16: Accessories for control panel building	
Mounting systems for basic enclosures	2
Mounting rails to IEC/EN 60 715	
Sheet steel mounting plates	
Accessories for mounting systems	
→ Page 20/97	
Mounting	3
Horizontal and vertical slot apertures for wall-mounting enclosures	
Captive cover screws	
Rubber feet on the back plate to compensate for uneven walls for CI-K1 and CI-K2	
External fixing bracket for CI-K4 and CI-K5	
→ Page 4/67	
Mounting units	
Miniature circuit breakers (MCB)	
Rotary switches	
Switch-disconnectors	
Contactors	
easy control relays	
Timing relay	
Pilot devices	
• Laser labelling	
We can label the cover surface of the small enclosures CI-K according to your specifications. Washable and permanent with modern laser inscription. Please contact:	
Technical information/product advice	
Tel. +49 (0)228 602-3704	
Fax. +49 (0)228 602-69403	
E-mail: Technik-Bonn@eaton.com	
CI-K-Combination-* → Page 20/94	
Approved enclosures for use in UL/CSA → Page 20/96	
• Cutouts in enclosure covers	
We can drill cutouts in enclosure covers to your requirements. Please contact:	
Technical information/product advice	
Tel. +49 (0)228 602-3704	
Fax. +49 (0)228 602-69403	
E-mail: Technik-Bonn@eaton.com	



HPL20093EN

Ordering

Dimensions mm	Enclosure depth: Dimensions from top: 1. Mounting depth for mounting plate 2. Mounting depth for mounting rail 7.5 mm height 3. Enclosure depth mm	Mounting depth		Features	Part no. Article no.	Price See price list	Std. pack
		For mounting plate mm	For 7.5 mm mounting rail mm				
CI-K basic enclosures							
<ul style="list-style-type: none"> Protection type IP65 (exception: CI-K2-80-A), material characteristic glass-fibre reinforced polycarbonate Enclosure base RAL 9005, black/enclosure top only RAL 7035, light grey Metric cable entry knockouts top, bottom and in the back plate Push-through cable membrane with CI-K1 and CI-K2 Hard metric knockouts with CI-K1H and CI-K2H Hard metric knockouts with CI-K3 to CI-K5 Control cable entry with CI-K2 Indicator light L- can be mounted in base knock out M20/M25 							
		-	72	With mounting rail	CI-K1-95-TS 206881		1 off
		-	72	With mounting rail	CI-K1H-95-TS 105853		1 off
		-	73	With mounting rail	CI-K2-100-TS 206882		1 off
		-	73	With mounting rail	CI-K2H-100-TS 229304		1 off
		79	-	With mounting plate	CI-K2-100-M 206893		1 off
		79	-	With mounting plate	CI-K2H-100-M 229306		1 off
		-	118	With mounting rail	CI-K2-145-TS 206883		1 off
		-	118	With mounting rail	CI-K2H-145-TS 229305		1 off
		124	-	With mounting plate	CI-K2-145-M 206894		1 off
		124	-	With mounting plate	CI-K2H-145-M 229307		1 off
		124	-	With adapter plate for contactor DILE with overload relay ZE	CI-K2-145-AD 207632		1 off
		124	-	With adapter plate for contactor DILE with overload relay ZE	CI-K2H-145-AD 229308		1 off
		-	93	With mounting rail	CI-K3-125-TS 206884		1 off
		98	-	With mounting plate	CI-K3-125-M 206895		1 off
		-	128	With mounting rail	CI-K3-160-TS 206885		1 off
		133	-	With mounting plate	CI-K3-160-M 206896		1 off

Notes Number and size of cable entries → Page 20/95

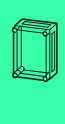

Dimensions	Enclosure depth: Dimensions from top: 1. Mounting depth for mounting plate 2. Mounting depth for mounting rail 7.5 mm height 3. Enclosure depth	Mounting depth		Features	Part no. Article no.	Price See price list	Std. pack
		For mounting plate	For 7.5 mm mounting rail				
mm	mm	mm	mm				
CI-K basic enclosures							
<ul style="list-style-type: none"> Protection type IP65 (exception: CI-K2-80-A), material characteristic glass-fibre reinforced polycarbonate Enclosure base RAL 9005, black/enclosure top only RAL 7035, light grey Metric cable entry knockouts top, bottom and in the back plate Push-through cable membrane with CI-K1 and CI-K2 Hard metric knockouts with CI-K1H and CI-K2H Hard metric knockouts with CI-K3 to CI-K5 Control cable entry with CI-K2 Indicator light L- can be mounted in base knock out M20/M25 							
		-	93	With mounting rail	CI-K4-125-TS 206886		1 off
		98	-	With mounting plate	CI-K4-125-M 206897		1 off
		-	128	With mounting rail	CI-K4-160-TS 206890		1 off
		133	-	With mounting plate	CI-K4-160-M 206898		1 off
		-	93	With mounting rail (Weight of fitted components max. 0.65 kg)	CI-K5-125-TS 206891		1 off
		98	-	With mounting plate (weight of fitted components max. 1.7 kg)	CI-K5-125-M 206899		1 off
		-	128	With mounting rail (Weight of fitted components max. 0.65 kg)	CI-K5-160-TS 206892		1 off
		133	-	With mounting plate (weight of fitted components max. 1.7 kg)	CI-K5-160-M 206900		1 off
Customised cutouts and laser inscriptions							
<ul style="list-style-type: none"> Only with operator only The necessary data (laser data, symbols, text and their respective positions) as well as the position of the cutouts must be provided as a DXF file. 							
						CI-K1-COMBINATION-* 102060	1 off
						CI-K2-COMBINATION-* 102061	1 off
						CI-K3-COMBINATION-* 102062	1 off
						CI-K4-COMBINATION-* 102063	1 off
						CI-K5-COMBINATION-* 102064	1 off

Notes Number and size of cable entries → Page 20/95



Dimensions	Enclosure depth: Dimensions from top: 1. Mounting depth for mounting plate 2. Mounting depth for mounting rail 7.5 mm height 3. Enclosure depth	Mounting depth		Features	Part no. Article no.	Price See price list	Std. pack
		For mounting plate	For 7.5 mm mounting rail				
mm		mm	mm				
CI-K2 basic enclosures							
<ul style="list-style-type: none"> Protection type IP30, material characteristic glass-fibre reinforced polycarbonate Enclosure base RAL 9005, black/enclosure top only RAL 7035, light grey Metric cable entry knockouts top, bottom and in the back plate Push-through cable entry diaphragm with CI-K2 Hard metric knockouts with CI-K2H Control cable entry Indicator light L-. can be mounted in base knock out M20/M25 							
		-	46	With standard cutout dimensions	Standard cutout dimensions and mounting rail for mounting devices requiring 2 to 4 space units. Push-through cable entry membrane. Close off of unused space units (max. 2) using blanking strips VST1, → Page 20/98	CI-K2-80-A 211107	1 off
		-	46	With standard cutout dimensions	Standard cutout dimensions and mounting rail for mounting devices requiring 2 to 4 space units. Hard metric knockouts. Close off of unused space units (max. 2) using blanking strips VST1, → Page 20/98	CI-K2H-80-A 229309	1 off
		-	70	With hinged cover	Transparent hinged cover for mounting devices requiring 2 to 4 space units. Push-through cable entry diaphragm.	CI-K2-80-K 211108	1 off
		-	70	With hinged cover	Transparent hinged cover for mounting devices requiring 2 to 4 space units. Hard metric knockouts.	CI-K2H-80-K 229310	1 off

Notes Diaphragm grommets, cable glands → Chapter 16: Accessories for panel construction

L	M	N	O	P	q	R
Knockouts 2 X M20 or push-through membrane up to max. Ø 12 mm	Knockouts 2 x M25 or push-through membrane up to max. Ø 16 mm CI-K2H: 2 x M25/20	Knockouts 2 x M25/20	Knockouts 2 x M32/25 1 x M20	Knockouts 2 x M50/40/25 1 x M20	Knockouts 2 x M25 or push-through membrane up to max. Ø 16 mm and 1 push-through membrane up to max. Ø 8 mm CI-K2H: 2 x M25/20	Knockouts 2 x M25/20 1 x M20
S	T	U	V	W		
Back plate: 2 x push-through membrane up to max. Ø 8mm	Back plate: 2 x push-through membrane up to max. Ø 11mm (not for CI-K2H)	Back plate: 2 x M25/20	Back plate: 2 x M32/25	Back plate: 2 x M50/40/25		









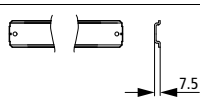

Dimensions		Depth	Mounting depth	Features	Part no. Article no.	Price See price list	Std. pack
Width	Height						
mm	mm	mm	mm				
CI-K basic enclosures							
<ul style="list-style-type: none"> • Protection type IP65 • Enclosure base RAL 9005, black/enclosure top only RAL 7035, light grey • Approved for UL, CSA • CI-K2X...: 4 x ½ inch knockouts • CI-K3X..., CI-K4X..., CI-K5X...: smooth overall with sharp corners 							
100	160	100	73	With mounting rail	CI-K2X-100-TS-NA 231220		1 off 
			79	With mounting plate	CI-K2X-100-M-NA 231228		
		145	118	With mounting rail	CI-K2X-145-TS-NA 231221		
			124	With mounting plate	CI-K2X-145-M-NA 231229		
120	200	125	93	With mounting rail	CI-K3X-125-TS-NA 231222		
			98	With mounting plate	CI-K3X-125-M-NA 231230		
		160	128	With mounting rail	CI-K3X-160-TS-NA 231223		
			133	With mounting plate	CI-K3X-160-M-NA 231231		
160	240	125	93	With mounting rail	CI-K4X-125-TS-NA 231224		
			98	With mounting plate	CI-K4X-125-M-NA 231232		
		160	128	With mounting rail	CI-K4X-160-TS-NA 231225		
			133	With mounting plate	CI-K4X-160-M-NA 231233		
200	280	125	93	With mounting rail	CI-K5X-125-TS-NA 231226		
		160	128	With mounting rail	CI-K5X-160-TS-NA 231227		
	280	125	98	With mounting plate	CI-K5X-125-M-NA 231234		
		160	133	With mounting plate	CI-K5X-160-M-NA 231236		

Information relevant for export to North America

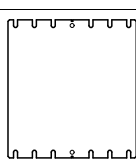

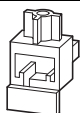

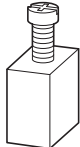



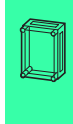

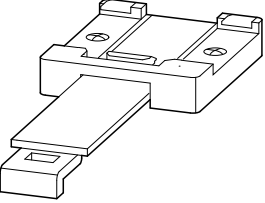

Product Standards	UL 508; CSA-C22.2 No. 14-05; CSA-C22.2 No. 94; IEC/EN 60947-3; CE marking
UL File No.	E54120, E337418
UL CCN	MITW2
CSA File No.	12528
CSA Class No.	3211-07
NA Certification	UL Listed, CSA certified
Specially designed for NA	Yes
Degree of Protection	IEC: IP65; UL/CSA Type 1, 3R, 4X, 12, 13 – indoor and outdoor use

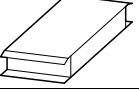

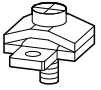

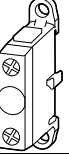

	For use with	Mounting position	Features	Useful length	Part no. Article no.	Price See price list	Std. pack	Information relevant for export to North America 
Mounting rails								
Height 7.5 mm, with fixing screws								
	CI-K1	Crosswise	–	60 mm	TS-CI-K1 206901		10 off 	UL/CSA certification not required
	CI-K2	Crosswise	–	82 mm	TS-CI-K2 206902			
	CI-K3	Lengthwise and crosswise	–	98 mm	TS-CI-K3 206903			
	CI-K4	Crosswise	–	133 mm	TS-CI-K4 206904			
	CI-K5	Lengthwise and crosswise, CI-K4 lengthwise	–	173 mm	TS-CI-K5 206905			
Mounting plates								
2 mm sheet steel with fixing screws								
	CI-K2	–	–	–	M-CI-K2 206906		10 off 	UL/CSA certification not required
	CI-K3	–	–	–	M-CI-K3 206907			
	CI-K4	–	–	–	M-CI-K4 206908			
	CI-K5	–	–	–	M-CI-K5 206909			
Accessories for mounting systems								
Spacers								
<ul style="list-style-type: none"> • For raising the mounting systems • (4 off required for mounting plate, 2 off required for mounting rail) 								
	–	–	by 25 mm	–	HS25-CI 002291		25 off 	UL/CSA certification not required
	–	–	by 50 mm	–	HS50-CI 002292			
	–	–	by 10 mm	–	ADT200-190 002289		10 off 	UL/CSA certification not required
	–	–	by 15 mm	–	ADT125-110 002290			

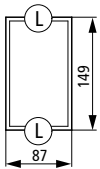
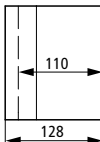

	For use with	Terminal capacity Flexible mm ²	Part no. Article no.	Price See price list	Std. pack	Information relevant for export to North America 
Accessories for small enclosures CI-K						
Set of external fixing brackets To secure CI-K4 and CI-K5 directly on the wall. Each set contains four brackets.						
	T5B-.../14, T5-.../15, P3-63/14, P3-100/15,	-	AB-CI-K4/5 206914		1 off 	UL/CSA certification not required
Mounting rail adapter, screw fixing To secure enclosure on mounting rails to IEC/EN 60715						
	CI-K1	-	TB-CI-K 206918		1 off 	UL/CSA certification not required
Blanking strips To blank off one space unit; cannot be removed from outside						
	CI-K2-80-A	-	VST1 211258		5 off 	UL/CSA certification not required
N terminals, PE terminals Screwed onto support bosses in the enclosure base plate						
	CI-K2-PKZ0- ... CI-K1/2	1 - 4 mm ²	K-CI-K1/2 207451		20 off 	UL/CSA certification not required
Insulated individual terminals • With PE, N adhesive labels • For snap-fitting onto mounting rail						
	CI-K3	1 - 10 mm ²	K-CI-K3 206915		20 off 	UL/CSA certification not required
	CI-K4 T5B-.../14 CI-K4-T5B-... P3-.../14	1.5 - 16 mm ²	K-CI-K4 206916		20 off 	UL/CSA certification not required
	CI-K5 T5-.../15 CI-K5-T5-... P3-.../15	10 - 35 mm ²	K-CI-K5 218488		20 off 	UL/CSA certification not required
Protective covers for push-through cable membrane with CI-K1(2) To cover push-through cable membranes						
-	CI-K1 (M20)	-	SK-CI-K1 226766		100 off	
-	CI-K1 (M25)	-	SK-CI-K2 226767		100 off	

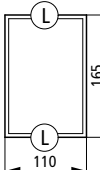
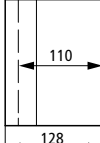
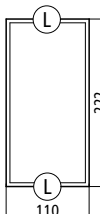
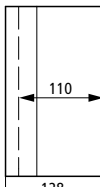

Dimensions	For use with	Enclosure depth: Dimensions from top 1. Mounting depth for mounting plate 2. Mounting depth	Mounting depth	Part no. Article no.	Price See price list	Std. pack	Notes
Dimensions mm		Enclosure depth mm	For mounting plate mm				
CI-B, C, D basic enclosures							
<ul style="list-style-type: none"> • Transparent cover • Metric knockouts top, bottom • With PEN terminal • IP55 individual enclosure with pre-drilled mounting plate 							
	DIL00AM		110	CI-B 024315		1 off	L  Knockouts 2 x M20
	S27		110	CI-C 031434		1 off	
	DIL0AM S27		110	CI-D 038553		1 off	
PE terminal (fifth conductor)							
Rated operational current 25 A for Ø 1.5 - 6 mm ² solid							
	-	CI-B CI-C CI-D	-	-	K6/1 002270	100 off 	

Information relevant for export to North America



UL/CSA certification not required

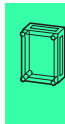

Technical data

	CI-K1	CI-K2	CI-K2...-80-A CI-K2...-80-K	CI-K3	CI-K4	CI-K5	
General							
Standards	IEC/EN 60529 DIN 43660 EN 50262						
Climatic proofing	Damp heat, constant, to IEC 60068-2-78 Damp heat, cyclic, to IEC 60068-2-30						
Ambient temperature	°C	-25 - 70					
Ambient air temperature with push-through cable entry	°C	-25...40					
Protection type	Front IP65		Front IP30	Front IP65			
Protection type with push-through cable entry	The degree of protection specifications do not apply to CI-K2-80-A						
Radiated heat dissipation	IP65		IP30	IP65			
	→ Page 20/101						
Material properties							
Material	Glass-fibre reinforced polycarbonate						
Base, cover	Corrosion-resistant						
Surface treatment	Corrosion-resistant						
Color							
Base	RAL 9005, black (matt)						
Cover	Enclosure cover RAL 7035, light grey (matt)						
Material properties							
Electrical							
Creepage resistance to IEC 60112							
Base	CTI 175						
Cover	CTI 175						
Surface treatment to IEC 60093	$\Omega \times 10^{13}$	> 1					
Dielectric strength to IEC 60243-1	kV/mm	30					
Thermal							
Continuous thermal stability							
Housing	°C	-40...120					
Sealing	°C	-40...80					
Mechanical							
IK code to EN 50102	04	06	06	06	06	06	
Weight of fitted components							
Per mounting rail	kg	0.2	0.7	0.7	0.85	0.75	0.65
With mounting plate	kg	–	–	0.7	0.85	0.9	1
Chemical resistance							
Base, cover							
Resistant	Acids < 10 %, mineral oil, petrol, grease, saline solutions						
Partially resistant	Acids > 10 %, Alcohol						
Non-resistant	Alkalis, benzol						
Push-through membrane (CI-K1/CI-K2) and sealing material							
Resistant	Acids < 10 %, alkalis, alcohol, saline solutions			–	–	–	
Partially resistant	Acids < 10 %, grease, benzene			–	–	–	
Non-resistant	Mineral oil, petrol			–	–	–	
Atmospheric							
Saline spray	IEC 60068-2-11						
UV resistance	Beneath protective canopy						
Water absorption to EN ISO 62	%	0.29					
Flammability characteristics							
Glow-wire test							
Base, cover							
Glow wire to VDE 0471 Part 2	°C	960/1 mm thick					
According to UL 94	V0/1.5 mm thickness						
Push-through membrane (CI-K1/CI-K2) and sealing material							
To VDE 0471 Part 2	°C	650/1 mm thick			–	–	–
According to UL 94	HB			–	–	–	
Halogen free	Yes			–	–	–	
Notes							
The degree of protection specifications do not apply to CI-K2-80-A							



Small enclosures CI-K	CI-K..		
Radiated heat dissipation	Part no.	Dimensions W x H x D mm	Heat dissipation
			W
Max. radiated heat dissipation of the insulated enclosures CI-K with separate mounting, ambient air temperature +20 °C	CI-K1-95	80 x 137 x 95	10
	CI-K2-100	100 x 181 x 100	12.5
	CI-K2-145	100 x 181 x 145	18.5
	CI-K3-125	120 x 222 x 125	21.5
	CI-K3-160	120 x 222 x 160	25.5
	CI-K4-125	160 x 240 x 125	26
	CI-K4-160	160 x 240 x 160	29.5
	CI-K5-125	200 x 280 x 125	35
CI-K5-160	200 x 280 x 160	41	

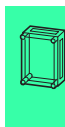

Dimensions

Small insulated material enclosures

CI-K1...-95-TS

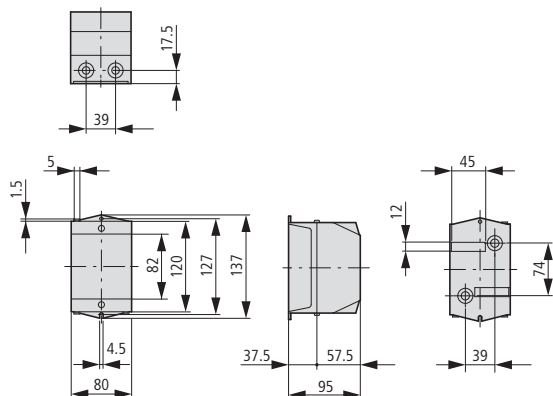

Mounting rails

TS-CI-K1

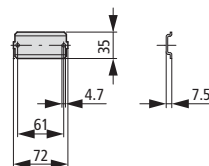

CI-K2...

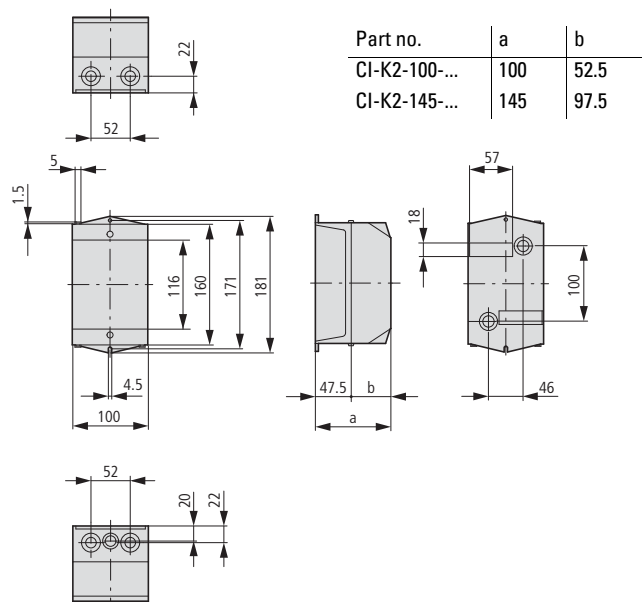

Mounting plates

M-CI-K2

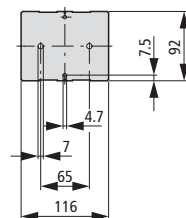

Mounting rails

TS-CI-K2

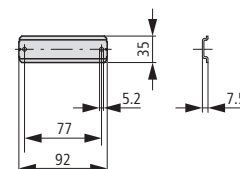

CI-K3...

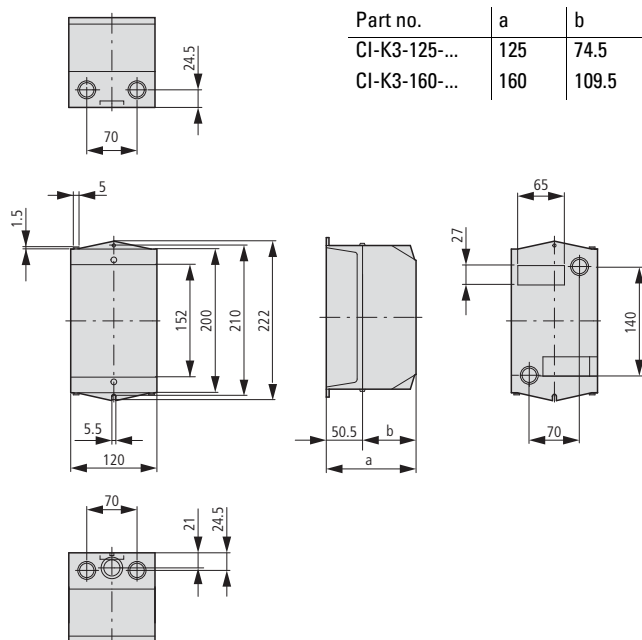

Mounting plates

M-CI-K3

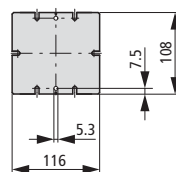

Mounting rails

TS-CI-K3

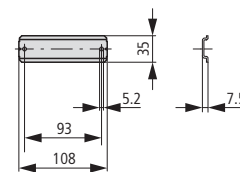

Small insulated material enclosures

CI-K4...

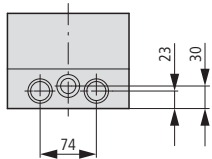

Part no.	a	b
CI-K4-125-...	125	72.5
CI-K4-160-...	160	107.5

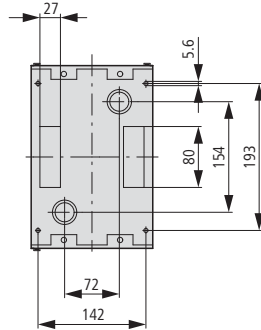
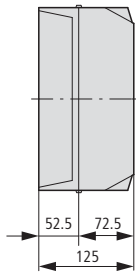
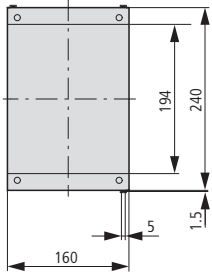

Mounting plates
M-CI-K4

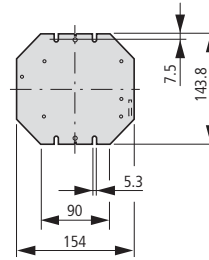

Mounting rails
TS-CI-K4

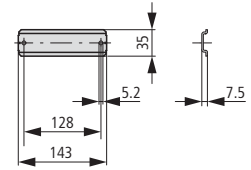

CI-K5...

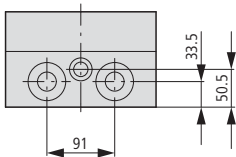

Part no.	a	b
CI-K5-125-...	125	51.5
CI-K5-160-...	160	85.5

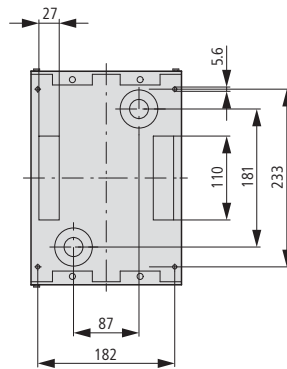
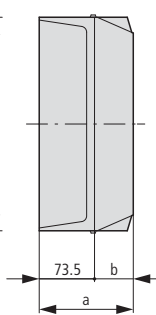
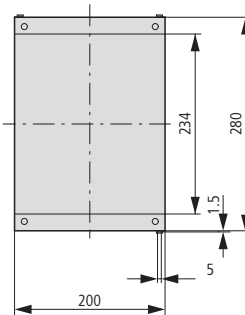

Mounting plates
M-CI-K5

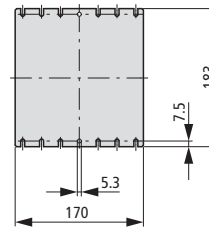

Mounting rails
TS-CI-K5

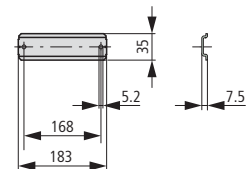

Basic enclosures

CI-B, CI-C, CI-D

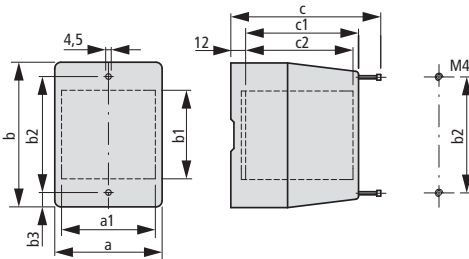

Part no.	a	a1	b	b1	b2	b3	c	c1	c2
CI-B	87	71	149	106	128	10.5	128	115	84.4
CI-C	110	95	165	122	144	10.5	128	115	84.4
CI-D	110	97	222	179	201	10.5	128	115	84.4





CS sheet steel wall-mounting enclosure

The stable CS housing series is used wherever effective protection against contact with active components is required. 45 housing sizes in protection type IP66 and an efficient range of accessories for interior and exterior installation make this housing series a universal genius.



Sheet steel wall-mounting enclosure CS – CS-86/200

Hinge pins with quick-change technology for simple door mounting +++ Base plate with foam gasket, ready-to-mount +++ Fasteners from corrosion-resistant metal → Page 21/4

Sheet steel wall-mounting enclosure CS – CS-1210/300

Mounting plate with 4-fold bevel provides more stability +++ 3-point rod closure for smooth opening +++ Door stabilizer for heavy door installations such as touch panels → Page 21/5

Locks with inserts – LC-DBIT5-CS

Shockproof, corrosion-resistant metal system +++ Easily extended with bar +++ Customized colors and inserts upon request → Page 21/10

Bar accepts profile semi-cylinders – PHZ-A-ADD-ON

For all market-typical profile semi-cylinders +++ Metal system with integrated closing condition display +++ Mount in minutes without drilling, stamping or sawing the door → Page 21/10

Wall fixing bracket – WFB-SET-CS

Horizontal and vertical mounting +++ Housing hangs easily on wall bolts +++ Simple assembly with few individual parts → Page 21/10

Mounting bars for door profile moldings and cable ducts – MTR-D6-CS

Quick and easy cable channel clamping +++ Length matched to door profile +++ For individual removal of door interior side → Page 21/6

Prefabricated energy and control distribution

Our system partner switchgear systems operate prefabricated energy and control distributions worldwide

www.moeller-systempartner-schaltanlagen.net

Moeller
Systempartner
Schaltanlagen

CS sheet steel wall-mounting enclosure

System overview

Sheet steel wall-mounting enclosure CS	21/2
--	------

Ordering

Sheet steel wall-mounting enclosure CS with mounting plate	21/4
--	------

Accessories	21/6
-------------	------

Internal configuration	21/6
------------------------	------

Door detent	21/6
-------------	------

Universal brackets for door position switches, cable conduit holders	21/6
--	------

Mounting bracket, inclined	21/6
----------------------------	------

Mounting rail module for soft starters	21/6
--	------

Quick-C	21/6
---------	------

Mounting bars for door profile moldings and cable ducts	21/6
---	------

Depth adjustment elements for mounting plates	21/7
---	------

Mounting plate, perforated, for cage nuts	21/7
---	------

Cage nuts for perforated mounting plates	21/7
--	------

Mounting plate, without apertures RAL2000	21/8
---	------

Mounting plate, without apertures, galvanized	21/8
---	------

Door for internal partitions	21/9
------------------------------	------

External configuration	21/10
------------------------	-------

Wall fixing brackets	21/10
----------------------	-------

Universal locks	21/10
-----------------	-------

Comfort rotary handle	21/10
-----------------------	-------

Cylinder locks for comfort handles	21/10
------------------------------------	-------

Spare key for cylinder lock	21/10
-----------------------------	-------

Bottom plates with apertures for flanges F3A	21/11
--	-------

Bottom plates without openings	21/11
--------------------------------	-------

Flanges F3A	21/12
-------------	-------

Cable marshalling bases	21/12
-------------------------	-------

Rain protection roofs	21/13
-----------------------	-------

Ventilation gill	21/14
------------------	-------

Mast fastening	21/14
----------------	-------

Lift eye kit with profile bracket	21/14
-----------------------------------	-------

Doors with inspection window	21/15
------------------------------	-------

Doors closed	21/16
--------------	-------

General panel construction	21/17
----------------------------	-------

Door earthing set	21/17
-------------------	-------

Paint RAL 7035	21/17
----------------	-------

Circuit diagram pockets insulating material	21/17
---	-------

Metric cable glands	21/17
---------------------	-------

PG cable glands	21/18
-----------------	-------

Ventilation cable gland	21/18
-------------------------	-------

Pressure equalization plug	21/18
----------------------------	-------

Cable grommets	21/19
----------------	-------

Stepped cable grommets	21/19
------------------------	-------

Pressure compensating grommet	21/19
-------------------------------	-------

Cable ducts	21/20
-------------	-------

Cable duct cover	21/21
------------------	-------

Cable support bracket for cable duct	21/21
--------------------------------------	-------

Clamping brackets for cable ducts	21/21
-----------------------------------	-------

Technical data

Sheet steel wall-mounting enclosure CS, a general dat	21/22
---	-------

Power loss	21/23
------------	-------

Weight of fitted components	21/24
-----------------------------	-------

Dimensions

Internal configuration	21/25
------------------------	-------

External configuration	21/31
------------------------	-------

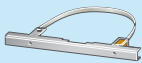
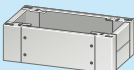
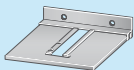

System overview

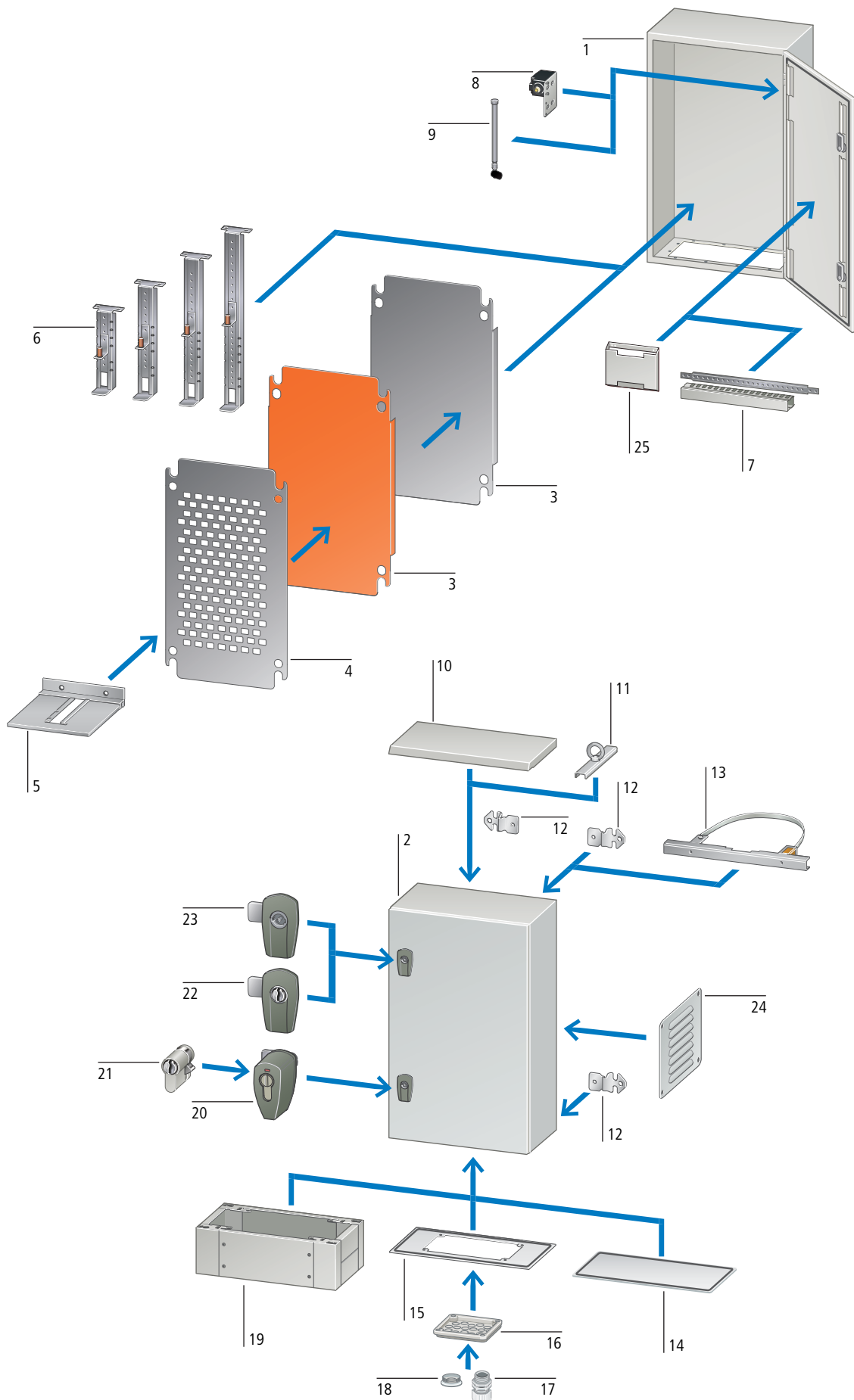

Indoor installation

CS sheet steel wall-mounting enclosure 1

Internal concealed horizontal door hinge pins with quick change technology so that the door can be rapidly taken off its hinges to perform further processing or to change the door stop

Door profile molding with perforation at 25 mm intervals for fastening DIN mounting rails or for fixing cable conduits and leads

The supplied galvanized sheet steel mounting plate permits safe installation of the switchgear and basic EMC protection. Slots facilitate insertion of the equipped mounting plate into the control panel.

In the case of enclosure dimensions larger than 600 x 400 mm bended sides increase the stability of the mounting plates when heavy built-in devices units are being used.

Optional internal door for additional personal and system protection

→ Page 21/4

Mounting plate, unperforated, galvanized or RAL 2000 3

→ Page 21/8

Mounting plate, perforated, galvanized, for cage nuts 4

For quick mounting of switchgear and protective devices without drilling

→ Page 21/7

Mounting rail module for soft starters 5

Allows convenient connection and operation of Eaton soft starter through pivoting in and out

→ Page 21/6

Depth adjustment elements for mounting plates 6

Depth adjustment in a 25 mm grid for tailored surface-mounting on front or back of mounting plate

→ Page 21/7

Mounting bars for door profile moldings and cable ducts 7

For screw- and hole-less mounting of Eaton cable ducts KL...

→ Page 21/6, → 21/21

Universal brackets for door contact switches and cable conduit holders 8

→ Page 21/6

Quick-C hinge pin 9

Door hinge pin with quick-change technology for retrofitting or as spare part

→ Page 21/6

Outdoor installation

CS sheet steel wall-mounting enclosure 2

Degree of protection IP66, resistance of impact IK09, UL/CSA Type 1 and 12

45 enclosure sizes from 250 x 200 x 150 mm to 1200 x 1200 x 250 mm (h x w x d) also with an enclosure depth of 300 mm.

Impact-resistant designer metal locks, standard 3 mm two-way key bit

Rain gutter profile

Foamed polyurethane sealing throughout.

→ Page 21/4

Rain canopy 10

With edge sloping toward rear.

→ Page 21/13

Lift eye kit with profile bracket 11

Stable profile bracket for internal enclosure reinforcement for lifting eye

→ Page 21/14

Wall fixing bracket 12

Elongated holes simplify mounting the equipped enclosures on the wall bolts.

Simple subsequent alignment of enclosure

Vertical and horizontal mounting possible

→ Page 21/10

Mast fastening 13

For stable, reliable fixing on round or rectangular masts

→ Page 21/14

Bottom panels without apertures 14

Sheet steel bottom panels with foamed gasket for assembly by user

Suitable for indoor or outdoor installation.

The enclosure can be turned through 180° for cable entry from above or below.

The flange aperture is in the rear area of the enclosure, enabling easy wiring onto the mounting plate.

→ Page 21/11

Bottom panels with apertures for F3A flanges 15

Sheet steel bottom panels with foamed gasket, preassembled for Eaton F3A flanges

→ Page 21/11

F3A flanges 16

Insulating material flanges with metric knockouts, cable grommets or push-through seals.

→ Page 21/12

Metric cable glands to EN 50262, metric ventilation cable glands 17

Innovative ventilating cable glands

Protection type IP69K

→ Page 21/17, → 21/18

Metric diaphragm grommets, cable grommet 18

Protection type up to IP66

→ Page 21/19

Cable interconnect frame 19

Cable clamp rails can be fitted at an adjustable height and depth

→ Page 21/12

Lock for half-cylinder comfort rotary handle 20

Standard locks can be quickly equipped with cylinder locks.

New and unique on the market: With built-in "closed" position indication; rugged metal design

No complicated drilling, punching or sawing of the door required

The standard lock does not even have to be dismantled.

→ Page 21/10

Cylinder locks 21

High-grade cylinder locks with adjustable hammer

→ Page 21/10

Locks with inserts, lock cylinder 22

Lock for retrofitting

→ Page 21/10

Locks with inserts, two-way key bit 23

Lock for retrofitting with 3 mm or 5 mm two-way key bit

Made completely of pressure-cast zinc, therefore suitable for indoor and outdoor installation

→ Page 21/10

Ventilating louvers 24

For passive control panel ventilation

→ Page 21/14

Circuit diagram pockets insulating material 25

→ Page 21/17



Ordering

Dimensions			Locks	Hinges	Door profile molding	Flange plates		Max. F3A flanges	Mounting plates		Weight	Part no. Article no.	Price See price list	Std. pack
Height mm	Width mm	Depth mm	Number	Number	Number	Width mm	Depth mm	Number	Height mm	Width mm	kg			
CS wall-mounting enclosure with mounting plate														
<ul style="list-style-type: none"> • Protection type IP66. • Foamed polyurethane sealing throughout. • Resistance to impact regarding IK09 to EN 62262. • Sheet steel mounting plate • Bottom panel with foamed gasket. CS-1212/250 with two apertures for bottom panel. • Single door, hinges on the right, door opening angle 120°. • Door hinge pins with quick change technology. • Standardized locking system with two-way key bit. From enclosure height 1000 mm: 3-point locking system. • Equipment supplied: Lock, 3 mm two-way key bit • Powder coating (textured surface) in the colour RAL 7035 inside and outside. 														
250	200	150	1	2	1	112	182	-	220	150	3.4	CS-2520/150 111646		1 off 
300	200	150	1	2	1	112	182	-	270	150	3.9	CS-32/150 111647		
300	300	150	1	2	2	112	232	-	270	250	5.2	CS-33/150 111648		
300	300	200	1	2	2	172	262	1	270	250	6.1	CS-33/200 111649		
300	400	200	1	2	2	172	332	1	270	350	7.4	CS-34/200 111680		
400	300	150	1	2	2	112	232	-	370	250	6.6	CS-43/150 111681		
400	300	200	1	2	2	172	262	1	370	250	7.6	CS-43/200 111682		
400	400	150	1	2	2	112	332	-	370	350	8.7	CS-44/150 111683		
400	400	200	1	2	2	172	332	1	570	350	9.7	CS-44/200 111684		
400	600	200	1	2	2	172	532	2	370	550	13.4	CS-46/200 111685		
400	600	250	1	2	2	172	532	2	370	550	14.3	CS-46/250 111686		
400	600	300	1	2	2	172	532	2	370	550	15.7	CS-46/300 111687		
500	400	150	2	2	2	112	332	-	470	350	10.1	CS-54/150 111688		
500	400	200	2	2	2	172	332	1	470	350	10.9	CS-54/200 111689		
500	400	250	2	2	2	172	332	1	470	350	11.9	CS-54/250 111690		
500	500	250	2	2	2	172	432	1	470	450	14.5	CS-55/250 111691		
600	400	150	2	2	2	112	332	-	570	350	12.4	CS-64/150 111692		
600	400	200	2	2	2	172	332	1	570	350	13.2	CS-64/200 111693		
600	400	250	2	2	2	172	332	1	570	350	14.5	CS-64/250 111694		
600	500	150	2	2	2	112	332	-	570	450	15.4	CS-65/150 111695		
600	500	200	2	2	2	172	432	1	570	450	16.8	CS-65/200 111696		
600	500	250	2	2	2	172	432	1	570	450	17.1	CS-65/250 111697		
600	600	200	2	2	2	172	532	2	570	550	21.8	CS-66/200 111698		
600	600	250	2	2	2	172	532	2	570	550	23.1	CS-66/250 111699		
600	600	300	2	2	2	172	532	2	570	550	24.5	CS-66/300 111700		
600	800	300	2	2	2	172	732	3	570	750	34.8	CS-68/300 111701		
700	500	200	2	2	2	172	432	1	670	450	21.1	CS-75/200 111702		
700	500	250	2	2	2	172	432	1	670	450	21.6	CS-75/250 111703		
800	400	200	2	3	2	172	332	1	770	350	21.7	CS-84/200 111704		



HPL21005EN

CS





Dimensions			Locks	Hinges	Door profile molding	Flange plates		Max. F3A flanges	Mounting plates		Weight	Part no. Article no.	Price See price list	Std. pack
Height mm	Width mm	Depth mm	Number	Number	Number	Width mm	Depth mm	Number	Height mm	Width mm	kg			
CS wall-mounting enclosure with mounting plate														
800	400	250	2	3	2	172	332	1	770	350	23.2	CS-84/250 111705		1 off 
800	600	200	2	3	2	172	532	2	770	550	30.2	CS-86/200 111706		
800	600	250	2	3	2	172	532	2	770	550	32.8	CS-86/250 111707		
800	600	300	2	3	2	172	532	2	770	550	34.9	CS-86/300 111708		
800	800	200	2	3	2	172	732	3	770	750	39.0	CS-88/200 111709		
800	800	300	2	3	2	172	732	3	770	750	42.8	CS-88/300 111710		
800	1000	300	2	3	2	172	932	3	770	950	54.2	CS-810/300 111711		
1000	600	250	1 (3-point)	3	2	172	532	2	970	550	43.2	CS-106/250 111712		
1000	600	300	1 (3-point)	3	2	172	532	2	970	550	45.4	CS-106/300 111713		
1000	800	250	1 (3-point)	3	2	172	732	3	970	750	55.5	CS-108/250 111714		
1000	800	300	1 (3-point)	3	2	172	732	3	970	750	56.1	CS-108/300 111715		
1000	1000	300	1 (3-point)	3	2	172	932	3	970	950	68.0	CS-1010/300 111716		
1200	600	250	1 (3-point)	3	2	172	532	2	1170	550	50.2	CS-126/250 111717		
1200	800	300	1 (3-point)	3	2	172	732	3	1170	750	67.7	CS-128/300 111718		
1200	1000	300	1 (3-point)	3	2	172	932	3	1170	950	83.2	CS-1210/300 111719		
1200	1200	250	1 (3-point)	3	2	2 x 172	532	4 (2x2)	1170	1150	94.2	CS-1212/250 111720		

Information relevant for export to North America

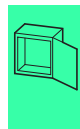

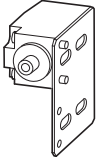
Product Standards UL 508A; CSA-C22.2 No.14; IEC/EN 60529; CE marking
 UL File No. E336299
 UL CCN NITW
 CSA File No. -
 CSA Class No. -
 NA Certification Request filed for UL and CSA
 Conditions of Acceptability Series CS may be provided with metal sub-panel. No back mounted components are allowed between sub-panel and the back sheet metal enclosure
 Suitable for Industrial Control Panels
 Degree of Protection IEC: IP66, indoor and outdoor; UL/CSA Types 1, 12, indoor only.

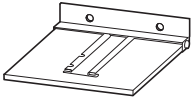

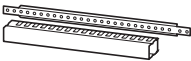
	Dimensions Enclosure Width mm	Part no. Article no.	Price See price list	Std. pack
Door retainer				
<ul style="list-style-type: none"> For retaining the door in a defined position Galvanized sheet steel Including fixing material 	500 600 800 1000 1200	DOOR-RET-CS 138737		1 off
Universal brackets for door contact switches and cable conduit holders				
<ul style="list-style-type: none"> For fixing door contact switches or cable conduit holders Galvanized sheet steel 	300 400 500 600 800 1000 1200	UNI-BRA-CS 140535		2 off
Mounting bracket, inclined				
<ul style="list-style-type: none"> For fitting mounting rails TS35X7.5 or TS35X15 in inclined position Galvanized sheet steel 	–	TS1-BRA-CS 138772		2 off
Mounting rail module for soft starters				
<ul style="list-style-type: none"> Pivoting module for soft starters up to and including construction size DS4 Soft starters pivoted into vertical position require less enclosure depth. Including fixing material for fitting on mounting plate 	–	TS35-DS4-CS 140537		1 off
Quick-C hinge pin				
<ul style="list-style-type: none"> With Quick-Change technology for tool-less removal 	–	QUICK-C-CS 138773		6 off
Mounting bars for door profiles and cable ducts				
<ul style="list-style-type: none"> For fitting to vertical door profiles For screwless mounting of cabling ducts KL... through snap fitting of cable duct covers on rear Fixing holes M6 spaced at 25 mm Galvanized sheet steel 	300 400 500 600 800	MTR-D3-CS 140530 MTR-D4-CS 140531 MTR-D5-CS 140532 MTR-D6-CS 140533 MTR-D8-CS 140534		2 off



HPL21007EN

MPP-CS

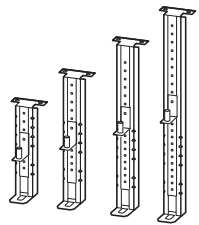
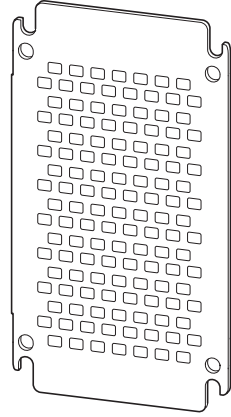
	Dimensions Enclosure			Thread	Part no. Article no.	Price See price list	Std. pack
	Height mm	Width mm	Depth mm				
Depth adjustment elements for mounting plates							
<ul style="list-style-type: none"> • Depth-adjustable in 25 mm grid • Galvanized sheet steel • Including fixing material 							
	–	–	150	–	DAS-SET/150-CS 138656		1 off
	–	–	200	–	DAS-SET/200-CS 138657		
	–	–	250	–	DAS-SET/250-CS 138658		
	–	–	300	–	DAS-SET/300-CS 138659		
Mounting plate, perforated, for cage nuts							
<ul style="list-style-type: none"> • Galvanized sheet steel • Perforated for cage nuts M6 or M8 • without fixing material 							
	250	200	–	–	MPP-2520-CS 138685		1 off
	300	200	–	–	MPP-3020-CS 138686		
	300	300	–	–	MPP-3030-CS 138687		
	300	400	–	–	MPP-3040-CS 138688		
	400	300	–	–	MPP-4030-CS 138689		
	400	400	–	–	MPP-4040-CS 138690		
	400	600	–	–	MPP-4060-CS 138691		
	500	400	–	–	MPP-5040-CS 138692		
	500	500	–	–	MPP-5050-CS 138693		
	600	400	–	–	MPP-6040-CS 138694		
	600	500	–	–	MPP-6050-CS 138695		
	600	600	–	–	MPP-6060-CS 138696		
	600	800	–	–	MPP-6080-CS 138697		
	700	500	–	–	MPP-7050-CS 138698		
	800	400	–	–	MPP-8040-CS 138699		
	800	600	–	–	MPP-8060-CS 138700		
800	800	–	–	MPP-8080-CS 138701			
800	1000	–	–	MPP-80100-CS 138702			
1000	600	–	–	MPP-10060-CS 138703			
1000	800	–	–	MPP-10080-CS 138704			
1000	1000	–	–	MPP-100100-CS 138705			
1200	600	–	–	MPP-12060-CS 138706			
1200	800	–	–	MPP-12080-CS 138707			
1200	1000	–	–	MPP-120100-CS 138708			
1200	1200	–	–	MPP-120120-CS 138709			
Cage nuts for perforated MPP... mounting plates							
–	–	–	M6	CANU-M6-CS 138710		100 off	
–	–	–	M8	CANU-M8-CS 138711			



Indoor installation: Mounting plates

MPL-CS, MPL-RAL2000-CS



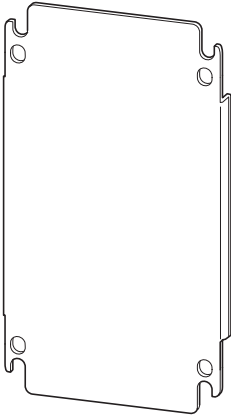

HPL21008EN

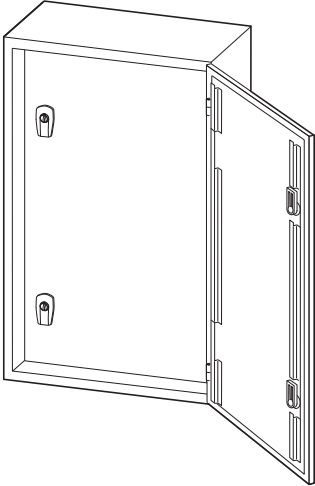
	Dimensions Enclosure		Part no. Article no. without apertures RAL2000 With powder coating	Price See price list	Part no. Article no. without apertures, galvanized	Price See price list	Std. pack
	Height mm	Width mm					
Mounting plates without apertures							
<ul style="list-style-type: none"> • Sheet steel • Without fixing material 							
	250	200	MPL-2520/RAL2000-CS 138712		MPL-2520-CS 138747		1 off
	300	200	MPL-3020/RAL2000-CS 138713		MPL-3020-CS 138748		
	300	300	MPL-3030/RAL2000-CS 138714		MPL-3030-CS 138749		
	300	400	MPL-3040/RAL2000-CS 138715		MPL-3040-CS 138750		
	400	300	MPL-4030/RAL2000-CS 138716		MPL-4030-CS 138751		
	400	400	MPL-4040/RAL2000-CS 138717		MPL-4040-CS 138752		
	400	600	MPL-4060/RAL2000-CS 138718		MPL-4060-CS 138753		
	500	400	MPL-5040/RAL2000-CS 138719		MPL-5040-CS 138754		
	500	500	MPL-5050/RAL2000-CS 138720		MPL-5050-CS 138755		
	600	400	MPL-6040/RAL2000-CS 138721		MPL-6040-CS 138756		
	600	500	MPL-6050/RAL2000-CS 138722		MPL-6050-CS 138757		
	600	600	MPL-6060/RAL2000-CS 138723		MPL-6060-CS 138758		
	600	800	MPL-6080/RAL2000-CS 138724		MPL-6080-CS 138759		
	700	500	MPL-7050/RAL2000-CS 138725		MPL-7050-CS 138760		
	800	400	MPL-8040/RAL2000-CS 138726		MPL-8040-CS 138761		
	800	600	MPL-8060/RAL2000-CS 138727		MPL-8060-CS 138762		
	800	800	MPL-8080/RAL2000-CS 138728		MPL-8080-CS 138763		
	800	1000	MPL-80100/RAL2000-CS 138729		MPL-80100-CS 138764		
	1000	600	MPL-10060/RAL2000-CS 138730		MPL-10060-CS 138765		
	1000	800	MPL-10080/RAL2000-CS 138731		MPL-10080-CS 138766		
1000	1000	MPL-100100/RAL2000-CS 138732		MPL-100100-CS 138767			
1200	600	MPL-12060/RAL2000-CS 138733		MPL-12060-CS 138768			
1200	800	MPL-12080/RAL2000-CS 138734		MPL-12080-CS 138769			
1200	1000	MPL-120100/RAL2000-CS 138735		MPL-120100-CS 138770			
1200	1200	MPL-120120/RAL2000-CS 138736		MPL-120120-CS 138771			

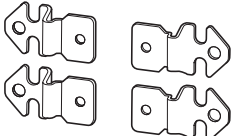
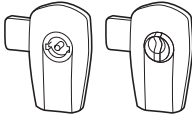

	Dimensions Enclosure		Part no. Article no.	Price See price list	Std. pack
	Height mm	Width mm			
Door for internal partitions					
<ul style="list-style-type: none"> • Sheet steel with powder coating RAL 7035 • Internal door for operator control and display units • Depth adjustment elements for mounting plates required in addition 					
	250	200	DI-2520-CS 138660		1 off
	300	200	DI-3020-CS 138661		
	300	300	DI-3030-CS 138662		
	300	400	DI-3040-CS 138663		
	400	300	DI-4030-CS 138664		
	400	400	DI-4040-CS 138665		
	400	600	DI-4060-CS 138666		
	500	400	DI-5040-CS 138667		
	500	500	DI-5050-CS 138668		
	600	400	DI-6040-CS 138669		
	600	500	DI-6050-CS 138670		
	600	600	DI-6060-CS 138671		
	600	800	DI-6080-CS 138672		
	700	500	DI-7050-CS 138673		
	800	400	DI-8040-CS 138674		
	800	600	DI-8060-CS 138675		
	800	800	DI-8080-CS 138676		
	800	1000	DI-80100-CS 138677		
	1000	600	DI-10060-CS 138678		
	1000	800	DI-10080-CS 138679		
1000	1000	DI-100100-CS 138680			
1200	600	DI-12060-CS 138681			
1200	800	DI-12080-CS 138682			
1200	1000	DI-120100-CS 138683			
1200	1200	DI-120120-CS 138684			





			Part no. Article no.	Price See price list	Std. pack	
Wall fixing brackets sets						
<ul style="list-style-type: none"> For fixing on the wall Vertical or horizontal mounting Bracket material: 3 mm galvanized sheet steel One set contains 4 wall fixing brackets with fixing material and gasket IP66. 						
			WFB-SET-CS 112639		1 off	
Universal locks						
<ul style="list-style-type: none"> Lock label made from high-grade, impact-resistant pressure-cast zinc Metal lock and inserts Powder coated RAL 7037 For indoor and outdoor applications Metal lock nut, notched Compatible with standard latches For standardized door cutouts 22.5 × 20.4 mm 						
			–	3 mm two-way key bit	LC-DBIT3-CS 133102	1 off
			–	5 mm two-way key bit	LC-DBIT5-CS 133103	1 off
Common locking mechanism				Key with two-way key bit	LC-ZSBIT-CS 133104	1 off
Comfort rotary handle						
<ul style="list-style-type: none"> Rotary handle for standardized cylinder locks With built-in "locked" indication As retrofitting or complete kit Handle made from high-grade, impact-resistant pressure-cast zinc Suitable for all universal locks LC-... For standardized door cutouts 22.5 × 20.4 mm Powder coated RAL 7037 Order cylinder locks separately 						
			Complete kit	Cylinder lock	PHZ-A-COMP 133105	1 off
			Retrofitting kit	Cylinder lock	PHZ-A-ADD-ON 133106	1 off
Cylinder locks for comfort handles						
<ul style="list-style-type: none"> For comfort rotary and toggle handles Lock cylinder designed to DIN 18252 and DIN EN 1303 Cylinder locks 10/30 with nickel silver pin tumblers Lock bit with eight adjustment positions, five pin pairs Common locking or individual key mechanism One key included per cylinder 						
			keyed alike	–	PHZ-E10/30-GS 138574	1 off
			keyed different	–	PHZ-E10/30-VS 138575	1 off
Spare key for cylinder lock						
<ul style="list-style-type: none"> For cylinder lock PHZ-E...-GS 						
			keyed alike	Cylinder lock	KEY-E10/30-GS 138576	4 off

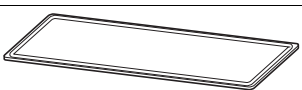

	For enclosure dimensions Width mm	Flange apertures Number	For use with	Part no. Article no.	Price See price list	Std. pack
Bottom panels with flange cutouts						
<ul style="list-style-type: none"> • Not suitable for enclosure CS-.../150 • For flange F3A-... • With foamed gasket, maximum protection type IP66 for proper application with F3A-... • Material: sheet steel with powder coating RAL 7035 • Usable as a top panel by turning the enclosure through 180° 						
	300	1	CS-33/200 CS-43/200	AFP-3-CS 112914		1 off
	400	1	CS-34-200 CS-44/200 CS-54/200 CS-54/250 CS-64/200 CS-64/250 CS-84/200 CS-84/250	AFP-4-CS 112915		1 off
	500	1	CS-55/250 CS-65/200 CS-65/250 CS-75/200 CS-75/250	AFP-5-CS 112916		1 off
	600	2	CS-46/200 CS-46/250 CS-46/300 CS-66/200 CS-66/250 CS-66/300 CS-86/200 CS-86/250 CS-86/300 CS-106/250 CS-106/300 CS-126/250	AFP-6-CS 112917		1 off
	800	3	CS-68/300 CS-88/200 CS-88/300 CS-108/250 CS-108/300 CS-128/300	AFP-8-CS 112918		1 off
	1000	3	CS-810/300 CS-1010/300 CS-1210/300	AFP-10-CS 112919		1 off
	1200	2 x 2	CS-1212/250	AFP-12-CS 112920		1 off

	Dimensions Enclosure		Part no. Article no.	Price See price list	Std. pack
	Width mm	Depth mm			
Bottom panels without apertures					
<ul style="list-style-type: none"> • Enclosure protection type IP66 • With continuous foamed gasket • Gasket protected in deep-drawn area • With powder coating RAL 7035 					
	182	112	SFP-112X182-CS 138738		1 off
	232	112	SFP-112X232-CS 138739		1 off
	332	112	SFP-112X332-CS 138740		1 off
	262	172	SFP-172X262-CS 138741		1 off
	332	172	SFP-172X332-CS 138742		1 off
	432	172	SFP-172X432-CS 138743		1 off
	532	172	SFP-172X532-CS 138744		1 off
	732	172	SFP-172X732-CS 138745		1 off
	932	172	SFP-172X932-CS 138746		1 off

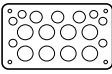
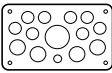
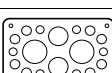
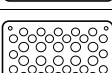
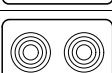
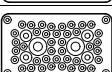

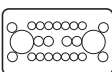
	Material	Features	Cable entry	Part no. Article no.	Price See price list	Std. pack
Flanges						
	Insulation material	Blank plate	-	F3A-0 074182		10 off
	Insulation material	With metric cable entry knockouts	6 x M25/16; 8 x M32/20, 4 x M16	F3A-4 081301		10 off
	Insulation material	With metric cable entry knockouts	2 x M20 8 x M25/16 4 x M32/20 1 x M50/32	F3A-8 091468		10 off
	Insulation material	With metric cable entry knockouts	12 x M20, 2 x M16 2 x M40/25 2 x M50/32	F3A-12 076555		10 off
	Insulation material	With metric cable entry knockouts	24 x M16 13 x M20	F3A-34 078928		10 off
	Insulation material	With cable grommets	2 cables up to 70 mm Ø	F3A-KTD 083674		5 off
	Insulation material	Sponge-rubber flange	40 cables, 10 – 13 mm Ø 4 cables, 17 - 21 mm Ø 2 cables, 27 - 30 mm Ø	F3A-D 010145		10 off
	Sheet steel	Blank plate 2 mm, with powder coating RAL 7035, sponge-rubbed gasket	-	F3A-XP 113426		1 off
	Insulation material	Diaphragm flange for cabling	14 x 11 mm Ø 8 x 15 mm Ø 2 x 28 mm Ø	ZSD-2K/FLA 272166		1 off

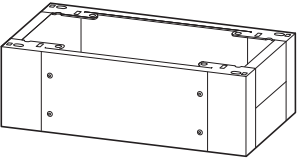
	Dimensions Enclosure		Part no. Article no.	Price See price list	Std. pack
	Width mm	Depth mm			
Cable interconnect frame					
<ul style="list-style-type: none"> • Height 200 mm • Sheet steel, with powder coating RAL 7035 • Including fixing material • Cable clamp rail not included as standard 					
	600	250	PLI-6/250-200-CS 140472		1 off
	600	300	PLI-6/300-200-CS 140473		1 off
	800	250	PLI-8/250-200-CS 140474		1 off
	800	300	PLI-8/300-200-CS 140475		1 off
	1000	300	PLI-10/300-200-CS 140476		1 off
	1200	250	PLI-12/250-200-CS 140477		1 off



	Dimensions Enclosure		Cover Height mm	For use with	Part no. Article no.	Price See price list	Std. pack
	Width mm	Depth mm					
Rain canopies							
<ul style="list-style-type: none"> • For direct fastening to the body of the enclosure • Material properties: sheet steel with powder coating RAL 7035 • Delivery with fixing material and drilling template 							
	200	150	30	CS-2520/150 CS-32/150	CNP-2/150-CS 112890		1 off
	300	150	30	CS-33/150 CS-43/150	CNP-3/150-CS 112891		1 off
	300	200	34	CS-33/200 CS-43/200	CNP-3/200-CS 112892		1 off
	400	150	30	CS-44/150 CS-54/150 CS-64/150	CNP-4/150-CS 112893		1 off
	400	200	34	CS-34/200 CS-44/200 CS-54/200 CS-64/200 CS-84/200	CNP-4/200-CS 112894		1 off
	400	250	38	CS-54/250 CS-64/250 CS-84/250	CNP-4/250-CS 112895		1 off
	500	150	30	CS-65/150	CNP-5/150-CS 112896		1 off
	500	200	34	CS-65/200 CS-75/200	CNP-5/200-CS 112897		1 off
	500	250	38	CS-55/250 CS-65/250 CS-75/250	CNP-5/250-CS 112898		1 off
	600	200	34	CS-46/200 CS-66/200 CS-86/200	CNP-6/200-CS 112899		1 off
	600	250	38	CS-46/250 CS-66/250 CS-86/250 CS-106/250 CS-126/250	CNP-6/250-CS 112900		1 off
	600	300	42	CS-46/300 CS-66/300 CS-86/300 CS-106/300	CNP-6/300-CS 112901		1 off
	800	200	34	CS-88/200	CNP-8/200-CS 112902		1 off
	800	250	38	CS-108/250	CNP-8/250-CS 112903		1 off
	800	300	42	CS-68/300 CS-88/300 CS-108/300 CS-128/300	CNP-8/300-CS 112904		1 off
	1000	300	42	CS-810/300 CS-1010/300 CS-1210/300	CNP-10/300-CS 112905		1 off
1200	250	38	CS-1212/250	CNP-12/250-CS 112906		1 off	

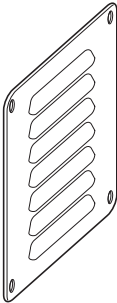
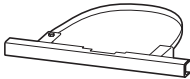
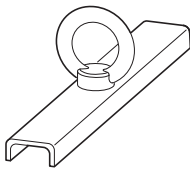

		Dimensions		Part no. Article no.	Price See price list	Std. pack
		Height mm	Width mm			
Ventilating louvers						
<ul style="list-style-type: none"> For direct fastening to the body of the enclosure Protection type IP23 Material: sheet steel with powder coating RAL 7035 Delivery with fixing material 						
	Arrangement of the ventilation slits vertically	157	105	LVP-20V12-CS 112907		1 off
	Arrangement of the ventilation slits horizontally	164	105	LVP-20H12-CS 112908		1 off
	Arrangement of the ventilation slits vertically	180	130	LVP-30V15-CS 112909		1 off
	Arrangement of the ventilation slits horizontally	250	130	LVP-30H15-CS 112910		1 off
Mast fastening						
<ul style="list-style-type: none"> For fixing on round or rectangular masts Set consisting of profiled busbar, clamping strap and clamping screw Sheet steel, galvanized, stainless steel clamping strap For mast diameters from 150 mm to 215 mm 						
			300 400 500 600 800	MAST-FIT-CS 140478		1 off
Lift eye kit with profile bracket						
<ul style="list-style-type: none"> For internal enclosure reinforcement for lifting eye Eyebolts with thread M12 Profile bracket of rigid 3 mm sheet steel For protection type IP66 Each set contains 2 lifting eyes, profiles and gaskets 						
	135	—		TOR-SET/135-CS 140479		2 off

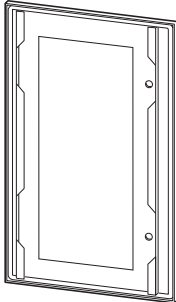
Dimensions Enclosure		Part no. Article no.	Price See price list	Std. pack
Height	Width			
mm	mm			
Doors with inspection window				
<ul style="list-style-type: none"> • Enclosure protection type IP65 • Frame: sheet steel with powder coating, transparent window: safety glass • Without hinges, without lock 				
	250	200	DT-2520-CS 140480	1 off
	300	200	DT-3020-CS 140481	
	300	300	DT-3030-CS 140482	
	300	400	DT-3040-CS 140483	
	400	300	DT-4030-CS 140484	
	400	400	DT-4040-CS 140485	
	400	600	DT-4060-CS 140486	
	500	400	DT-5040-CS 140487	
	500	500	DT-5050-CS 140488	
	600	400	DT-6040-CS 140489	
	600	500	DT-6050-CS 140490	
	600	600	DT-6060-CS 140491	
	600	800	DT-6080-CS 140492	
	700	500	DT-7050-CS 140493	
	800	400	DT-8040-CS 140494	
	800	600	DT-8060-CS 140495	
	800	800	DT-8080-CS 140496	
	800	1000	DT-80100-CS 140497	
	1000	600	DT-10060-CS 140498	
	1000	800	DT-10080-CS 140499	
1000	1000	DT-100100-CS 140500		
1200	600	DT-12060-CS 140501		
1200	800	DT-12080-CS 140502		
1200	1000	DT-120100-CS 140503		
1200	1200	DT-120120-CS 140504		







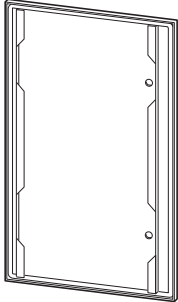

Outdoor installation: Doors closed

DS-CS

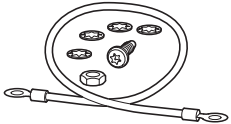

HPL21016EN

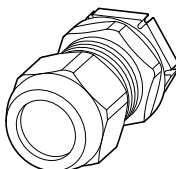
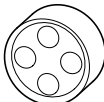
	Dimensions Enclosure		Part no. Article no.	Price See price list	Std. pack
	Height	Width			
	mm	mm			
Doors closed					
<ul style="list-style-type: none"> • Enclosure protection type IP66 • Sheet steel with powder coating • Without hinges, without lock 					
	250	200	DS-2520-CS 140505		1 off
	300	200	DS-3020-CS 140506		
	300	300	DS-3030-CS 140507		
	300	400	DS-3040-CS 140508		
	400	300	DS-4030-CS 140509		
	400	400	DS-4040-CS 140510		
	400	600	DS-4060-CS 140511		
	500	400	DS-5040-CS 140512		
	500	500	DS-5050-CS 140513		
	600	400	DS-6040-CS 140514		
	600	500	DS-6050-CS 140515		
	600	600	DS-6060-CS 140516		
	600	800	DS-6080-CS 140517		
	700	500	DS-7050-CS 140518		
	800	400	DS-8040-CS 140519		
	800	600	DS-8060-CS 140520		
	800	800	DS-8080-CS 140521		
	800	1000	DS-80100-CS 140522		
	1000	600	DS-10060-CS 140523		
	1000	800	DS-10080-CS 140524		
1000	1000	DS-100100-CS 140525			
1200	600	DS-12060-CS 140526			
1200	800	DS-12080-CS 140527			
1200	1000	DS-120100-CS 140528			
1200	1200	DS-120120-CS 140529			





		Features	Part no. Article no.	Price See price list	Std. pack			
Door earthing set								
<ul style="list-style-type: none"> • Cross-section 6 mm² • Including installation accessories 								
			BFZ-DES 101665		1 off			
Paint finish								
<ul style="list-style-type: none"> • Brush bottle • For repairing paint damage 								
-			RAL 7035	BPZ-CPS-7035 286771	1 off			
Circuit diagram pockets								
<ul style="list-style-type: none"> • Plastic with self-adhesive rear side • RAL 7035 light grey 								
			DIN A4 landscape	SPT4 002275	10 off			
			DIN A5 landscape	SPT5 002276				
			DIN A6 landscape	SPT6 002277				
Cable entry	Drilling diameter mm	External diameter of cable mm	For use with NYM/NYY cable, 4-core mm ²	Part no. Article no.	Price See price list	Std. pack		
Metric cable glands to EN 50262								
<ul style="list-style-type: none"> • With lock nut and built-in strain relief • IP68 up to 5 bar, polyamide, halogen-free • Flammability classification V2 according to UL94 • Colour RAL 7035 								
			M12	12.5	3 - 7	H03VV-F3 x 0.75 mm ² , NYM 1 x 2.5 mm ²	V-M12 215078	20 off
			M16	16.5	4.5 - 10	H05VV-F3 x 1.5 mm ² , NYM 1 x 16/3 x 1.5 mm ²	V-M16 215077	20 off
			M20	20.5	6 - 13	H05VV-F4 x 2.5/3 x 4 mm ² , NYM 5 x 1.5/5 x 2.5 mm ²	V-M20 206910	20 off
			M25	25.5	9 - 17	H05VV-F5 x 2.5/5 x 4 mm ² , NYM 5 x 2.5/5 x 6 mm ²	V-M25 206911	20 off
			M32	32.5	13 - 21	NYM 5 x 10 mm ²	V-M32 206912	10 off
			M40	40.5	16 - 28	NYM 5 x 16 mm ²	V-M40 209668	10 off
			M50	50.5	21 - 35	NYM 4 x 35/5 x 25 mm ²	V-M50 206913	5 off
			M63	63.5	34 - 48	NYM 4 x 35 mm ²	V-M63 214835	3 off
Multiple gaskets for V-M... cable glands, metric								
			M25	-	4 x 5 - 6	H03VV-F2 x 0.75/3 x 0.75 mm ²	MFD25 215451	50 off
			M32	-	4 x 3.5 - 7	H03VV-F4 x 0.75 mm ²	MFD32 215452	25 off
Stoppers for unused apertures in MFD... multiple gaskets								
			M25	-	6	-	MFV25-6 215453	50 off
			M32	-	7	-	MFV32-7 215454	50 off

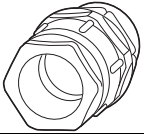
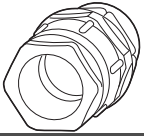
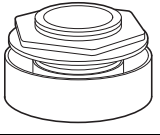
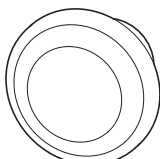

	Part no. Article no.	Price See price list	Std. pack	Information relevant for export to North America 
PG cable glands				
<ul style="list-style-type: none"> • Conduit union and lock nut with earthing screw • Suitable for normal commercial conduit • Suitable for all CI...-NA enclosures → Page 20/9 				
½"	STB1/2ZOLL 045878		1 off 	Product Standards UL 467; UL 514B; CSA-C22.2 No. 18
¾"	STB3/4ZOLL 060116			UL File No. UL CCN CSA File No. CSA Class No. NA Certification Conditions of Acceptability
1"	STB1ZOLL 052997			E23018, E3060 DWTT, KDER LR 2884 4412-03, 4414-04
1 ¼"	STB1-1/4ZOLL 043505			UL Listed, CSA certified Only used in combination with CI-...-NA enclosures
1 ½"	STB1-1/2ZOLL 041132			Yes Conduit, Tubing, and Cable Fittings, Grounding and Bonding Equipment
2"	STB2ZOLL 002203			Refer to main component information
				Specially designed for NA Suitable for
				Degree of Protection
				See also
				Refer to basic component information

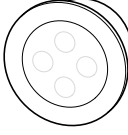
	Cable entry	Drilling diameter mm	External diameter of cable mm	For use with NYM/NYY cable, 4-core mm ²	Part no. Article no.	Price See price list	Std. pack
Ventilation cable gland							
<ul style="list-style-type: none"> • Colour RAL 7035 							
Ventilation cable gland IP69K							
	M20	20.5	6 - 13	H05VV-F 4 x 2.5/3 x 4 mm ² , NYM 5 x 1.5/5 x 2.5 mm ²	V-M20-VENT 120814		1 off
Ventilation cable gland IP56							
<ul style="list-style-type: none"> • Permeable to air, impermeable to dust • For the prevention of condensation For use in the enclosure bottom or sides, polyamide, halogen free							
	M20	20.5	–	–	STB-M20F 224557		20 off
	M25	25.5	–	–	STB-M25F 224558		20 off
Pressure compensating plug							
Pressure compensating plug, IP66, metric							
Colour RAL 7035							
	M40 x 1.5	–	–	–	DAV-M40 107225		2 off
Pressure compensating plug, IP66, PG							
Colour RAL 7032							
	PG29	–	–	–	DA412 079219		2 off

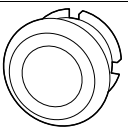
	Cable entry	Drilling diameter mm	External diameter of cable mm	For use with NYM/NYY cables, 4-core mm ²	Part no. Article no.	Price See price list	Std. pack
Cable grommets, metric							
<ul style="list-style-type: none"> • IP66, with integrated push-through diaphragm • PE and thermoplastic elastomer, halogen free • Colour RAL 7035 							
	M16	16.5	1 - 9	H03VV-F3 x 0.75 mm ² , NYM 1 x 16/3 x 1.5 mm ²	KT-M16 216983		100 off
	M20	20.5	1 - 13	H03VV-F3 x 0.75 mm ² , NYM 5 x 1.5/5 x 2.5 mm ²	KT-M20 207602		
	M25	25.5	1 - 18	H03VV-F3 x 0.75 mm ² , NYM 4 x 10 mm ²	KT-M25 207603		
	M32	32.5	1 - 25	H03VV-F3 x 0.75 mm ² , NYM 4 x 16/5 x 10 mm ²	KT-M32 207604		
PG cable grommets							
<ul style="list-style-type: none"> • For wall thickness 2 - 8 mm • Soft PVC, cadmium and lead-free • Colour similar to RAL 7035 							
	PG13.5	21.5	7 - 16	1.5 - 4	KT13.5 019658		100 off
	PG16	23.5	7 - 17	1.5 - 10	KT16 022031		100 off
	PG21	29.5	12.5 - 20	1.5 - 16	KT21 026777		100 off
	PG29	38	12.5 - 31	1.5 - 35	KT29 029150		50 off
	PG36	48	18 - 40	10 - 70	KT36 033896		20 off
	PG42	55	18 - 47	10 - 95	KT42 038642		10 off
Stepped cable grommets							
<ul style="list-style-type: none"> • For wall thickness 2 - 3 mm, • PVC • Colour RAL 7035 							
	–	58	14 - 54		KT3 031523		2 off
	–	75	14 - 68		KT4 036269		3 off
Pressure compensating grommet							
<ul style="list-style-type: none"> • Ventilation grommet with filter • Fitting below or on side of enclosure • PE and PVC • Colour RAL 7035 • Metric and PG 							
	M25	25.5	–		KT-M25F 224556		100 off
	PG16	23.5	–		KT16F 024404		100 off

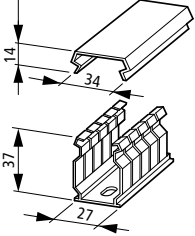
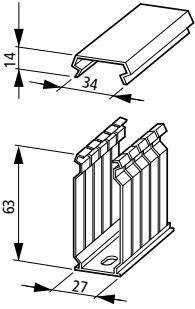
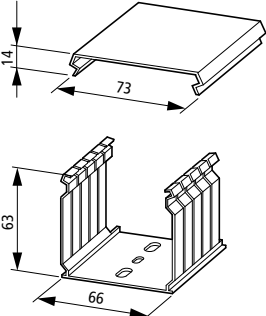
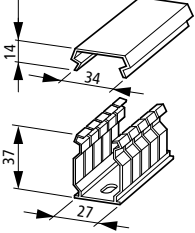

	Length mm	Loading capacity max. no. of cables (recommended value)	Type and cross-section H 0... V-K mm ²	Part no. Article no.	Price See price list	Std. pack			
Cable ducts									
Screwable									
	1500	60 40 25 15	0.75 1.5 2.5 4	KL25/35 012531		60 off			
	1500	100 70 45 30 25	0.75 1.5 2.5 4 6				KL25/60 017277		40 off
	1500	260 180 120 80 65	0.75 1.5 2.5 4 6						
Self-adhesive max. ambient temperature +55°C									
	650	60 40 25 15	0.75 1.5 2.5 4	KL25/35K 014904		50 off			

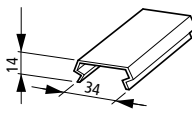
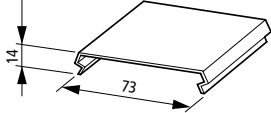
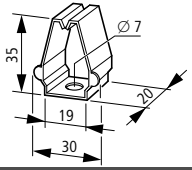
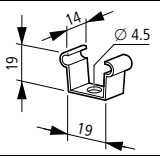
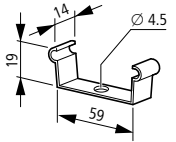

	Length mm	Loading capacity max. no. of cables (recommended value)	Type and cross-section H 0... V-K mm ²	Part no. Article no.	Price See price list	Std. pack
Cable duct cover						
Supplied as spares						
	1500	-	-	KD25 019649		200 off
	1500	-	-	KD60 024395		100 off
Cable support bracket						
<ul style="list-style-type: none"> • Can be used in KL25/35 (K) cable ducts • Screw fixing 						
	-	15	4	KH25/35 078974		20 off
Clamping brackets for cable ducts						
KL25/...: Mounting spacing: ≅ 500 mm						
	-	-	-	KK25 081347		100 off
KL60/60: Mounting spacing: ≅ 300 mm						
	-	-	-	KK60 083720		100 off



Technical data

			CS-...
General			
Standards			IEC/EN 60529, IEC 62262, IEC/EN 62208
RoHS			In accordance with Directive 2002/95/EC of the European Parliament and Council
Climatic proofing			Damp heat constant to IEC 60068-2-78; Damp heat, cyclical to IEC 60068-2-30
Ambient temperature		°C	-40 - +70
Protection type			IP66
Protection type with ventilating louvers			IP23
Installation site conditions			Installation indoor/outdoor
Mounting grid		mm	25
Heat dissipation			See separate table
Material properties			
Material			Sheet steel
Surface treatment			Structured powder spray polyester based paint finish
Colour			RAL 7035, light grey
Surface			Semi-textured
Gloss			Brilliant
Body		mm	≤ CS-65/...: 1.2; ≥ CS-66/...: 1.5
Mounting plate		mm	2; from height 800 × width 400 mm: 3
Door		mm	≤ CS-43/...: 1.0; ≤ CS-64/...: 1.2; ≤ CS-88/...: 1.5; ≤ CS-1212/...: 2.0
Bottom panel		mm	1.5
Material properties			
Mechanical			
Impact resistance			IK09 according to EN 62262
Total assembly weight of switch cabinet			See separate table
Assembly weight of door			See separate table
Assembly weight of mounting plate			See separate table
Assembly weight of wall fixing bracket			See separate table
Description/standard features			
Construction			Canted and seam welded, including two M6 threaded bolts for earth conductor connections inside the enclosure.
Rear panel			9 mm drilling dimensions for wall mounting
Enclosure side panels			Closed
Top plate flanges			Closed
Bottom panel			Enclosed, foamed gasket, can be unscrewed for F3A flanges - ... or for assembly by user
Mounting panel			Basic features, sheet steel, sendzimir galvanized. Distance from back plate 15 mm. Mounted on M8 copper threaded welded studs on inside of back plate. An additional earth conductor connection is therefore not imperative.
Door			Including 1 one threaded welded stud M6 for earth conductor connections in the door. If electrical apparatus is to be installed in the door, a continuous, permanent protective contactor connection must be established with a protective ground cable. The threaded welded studs on the door and on the cabinet side wall must be used as connecting points for the ground leads.
Hinge position			On the right, can be converted by user
Door opening angle		°	120
Locking system			Twist lock with protective insulation. Standard locking 3 mm two-way key bit.
Locks		Number	See Ordering pages



	Part no.	Maximum heat dissipation P _v Individual enclosure for wall mounting P _v W	Starting enclosure for wall mounting P _v W	Middle enclosure for wall mounting P _v W
Heat dissipation				
Dissipatable heat P _v [W] for fully-enclosed CS sheet steel enclosures without internal partitioning walls for wall mounting. Example: max. ambient air temperature 35 °C; overtemperature ΔT = 20 K; relative humidity = 75%.				
	CS-2520/150	11	10	9
	CS-32/150	13	11	10
	CS-33/150	16	15	14
	CS-33/200	19	18	16
	CS-34/200	23	22	21
	CS-43/150	21	19	18
	CS-43/200	24	22	20
	CS-44/150	25	24	22
	CS-44/200	29	27	25
	CS-46/200	39	37	35
	CS-46/250	44	42	39
	CS-46/300	49	46	43
	CS-54/150	30	28	27
	CS-54/200	35	32	30
	CS-54/250	39	36	33
	CS-55/250	45	42	39
	CS-64/150	35	33	31
	CS-64/200	40	37	34
	CS-64/250	45	42	38
	CS-65/150	42	39	37
	CS-65/200	47	44	41
	CS-65/250	55	49	45
	CS-66/200	54	51	48
	CS-66/250	60	56	52
	CS-66/300	65	61	57
	CS-68/300	81	76	72
	CS-75/200	53	50	47
	CS-75/250	59	55	51
	CS-84/200	51	47	44
	CS-84/250	57	53	48
	CS-86/200	68	64	60
	CS-86/250	75	70	65
	CS-86/300	82	76	70
	CS-88/200	85	81	77
	CS-88/300	101	95	89
	CS-810/300	120	113	108
	CS-106/250	91	85	79
	CS-106/300	99	91	84
	CS-108/250	112	106	100
	CS-108/300	121	113	106
	CS-1010/300	143	136	128
	CS-126/250	106	99	92
	CS-128/300	141	132	123
	CS-1210/300	166	158	149
	CS-1212/250	180	173	166



Max. assembly weights				
Part no.	Total assembly weight kg	Assembly weight mounting plate kg	Assembly weight door kg	
WFB-SET-CS 1 set (4 off) wall fixing brackets	–	–	–	500 kg payload, when brackets fitted in all four enclosure corners (vertically or horizontally) and the weights are symmetrically distributed within the enclosure.
CS-2520/150	150	125	25	–
CS-32/150	150	125	25	–
CS-33/150	150	125	25	–
CS-33/200	150	125	25	–
CS-34/200	175	150	25	–
CS-43/150	175	150	25	–
CS-43/200	175	150	25	–
CS-44/150	225	200	25	–
CS-44/200	225	200	25	–
CS-46/200	225	200	25	–
CS-46/250	225	200	25	–
CS-46/300	225	200	25	–
CS-54/150	225	200	25	–
CS-54/200	225	200	25	–
CS-54/250	225	200	25	–
CS-55/250	225	200	25	–
CS-64/150	225	200	25	–
CS-64/200	225	200	25	–
CS-64/250	225	200	25	–
CS-65/150	275	250	25	–
CS-65/200	275	250	25	–
CS-65/250	275	250	25	–
CS-66/200	275	250	25	–
CS-66/250	275	250	25	–
CS-66/300	275	250	25	–
CS-68/300	275	250	25	–
CS-75/200	275	250	25	–
CS-75/250	275	250	25	–
CS-84/200	325	300	25	–
CS-84/250	325	300	25	–
CS-86/200	325	300	25	–
CS-86/250	325	300	25	–
CS-86/300	325	300	25	–
CS-88/200	325	300	25	–
CS-88/300	325	300	25	–
CS-810/300	390	350	40	–
CS-106/250	390	350	40	–
CS-106/300	390	350	40	–
CS-108/250	390	350	40	–
CS-108/300	390	350	40	–
CS-1010/300	390	350	40	–
CS-126/250	390	350	40	–
CS-128/300	390	350	40	–
CS-1210/300	390	350	40	–
CS-1212/250	390	350	40	–



Dimensions

CS wall-mounting enclosures with door and blank plate
CS-...

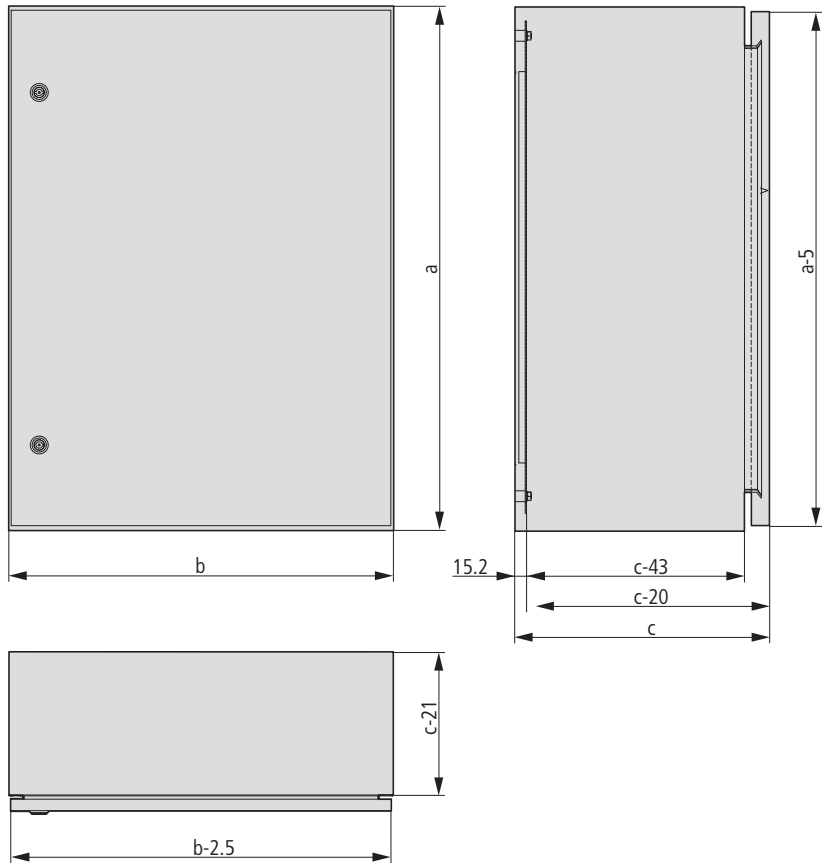
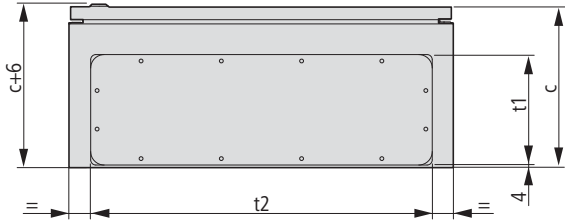

21/26 CS sheet steel wall-mounting enclosure

Indoor installation

CS-..., DT-...-CS, DS-...-CS

CS wall-mounting enclosures without door, without blank plate

CS-...

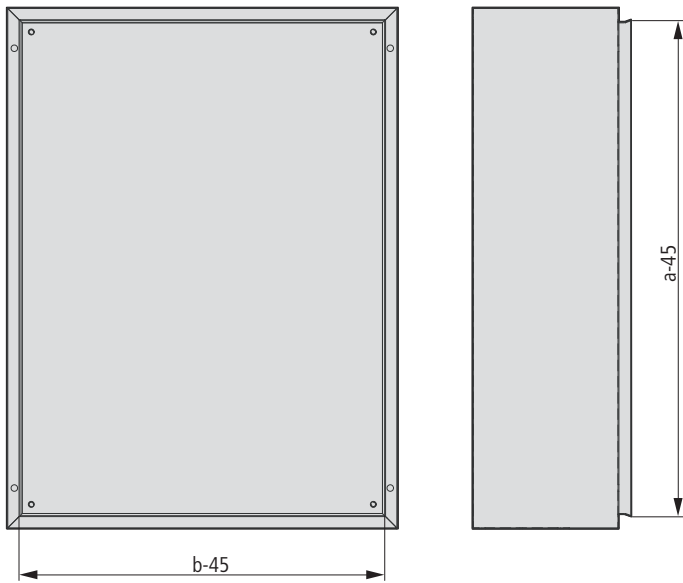
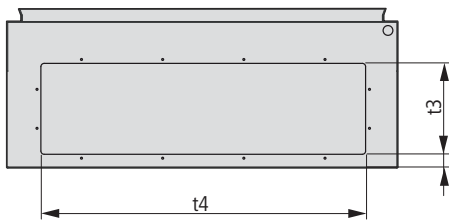

Internal view, door without enclosure

CS-2520/150, CS-32/150
DT-2520-CS, DT-3020-CS
DS-2520-CS, DS-3020-CS

CS-33/..., CS-34/..., CS-4.../...
DT-3030-CS, DT-3040-CS, DT-4...-CS
DS-3030-CS, DS-3040-CS, DS-4...-CS

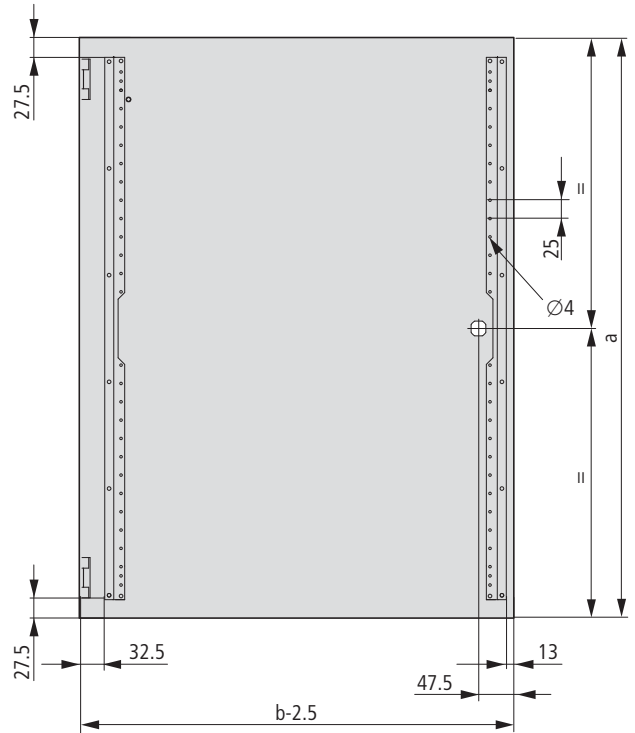
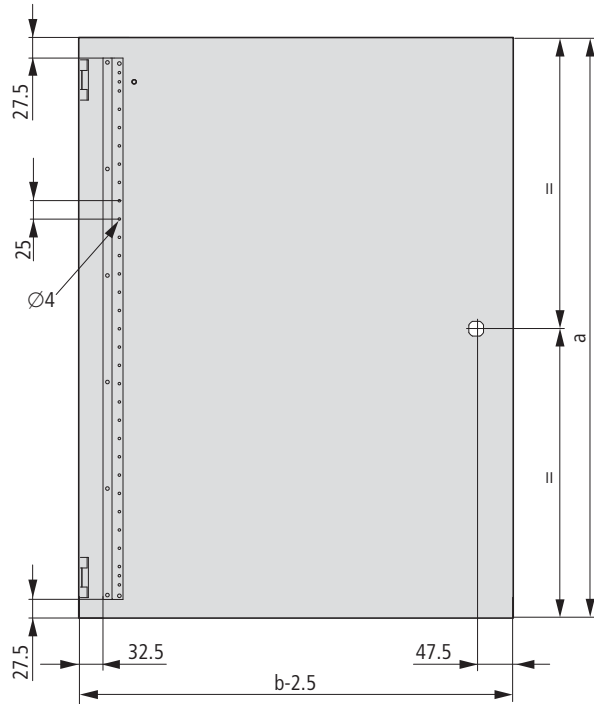

Enclosure dimensions								Door dimensions			
Part no.	a	b	c	t1	t2	t3	t4	Housing		Door	
								Height	Width	Height	Width
CS-2520/150	250	200	150	112	182	80	150	250	200	248	197.5
CS-32/150	300	200	150	112	182	80	150	300	200	298	197.5
CS-33/150	300	300	150	112	232	80	200	300	300	298	297.5
CS-33/200	300	300	200	172	262	140	230	300	400	298	397.5
CS-34/200	300	400	200	172	332	140	300	400	300	398	297.5
CS-43/150	400	300	150	112	232	140	200	400	400	398	397.5
CS-43/200	400	300	200	172	262	140	230	400	600	398	597.5
CS-44/150	400	400	150	112	332	140	300	500	400	498	397.5
CS-44/200	400	400	200	172	332	140	300	500	500	498	497.5
CS-46/200	400	600	200	172	532	140	500	600	400	598	397.5
CS-46/250	400	600	250	172	532	140	500	600	500	598	497.5
CS-46/300	400	600	300	172	532	140	500	600	600	598	597.5
CS-54/150	500	400	150	112	332	80	300	600	800	598	797.5
CS-54/200	500	400	200	172	332	140	300	700	500	698	497.5
CS-54/250	500	400	250	172	332	140	300	800	400	798	397.5
CS-55/250	500	500	250	172	432	140	400	800	600	798	597.5
CS-64/150	600	400	150	112	332	80	300	800	800	798	797.5
CS-64/200	600	400	200	172	332	140	300	800	1000	798	997.5
CS-64/250	600	400	250	172	332	140	300	1000	600	998	597.5
CS-65/150	600	500	150	112	332	80	300	1000	800	998	797.5
CS-65/200	600	500	200	172	432	140	400	1000	1000	998	997.5
CS-65/250	600	500	250	172	432	140	400	1200	600	1198	597.5
CS-66/200	600	600	200	172	532	140	500	1200	800	1198	797.5
CS-66/250	600	600	250	172	532	140	500	1200	1000	1198	997.5
CS-66/300	600	600	300	172	532	140	500	1200	1200	1198	1197.5
CS-68/300	600	800	300	172	732	140	700				
CS-75/200	700	500	200	172	432	140	400				
CS-75/250	700	500	250	172	432	140	400				
CS-84/200	800	400	200	172	332	140	300				
CS-84/250	800	400	250	172	332	140	300				
CS-86/200	800	600	200	172	532	140	500				
CS-86/250	800	600	250	172	532	140	500				
CS-86/300	800	600	300	172	532	140	500				
CS-88/200	800	800	200	172	732	140	700				
CS-88/300	800	800	300	172	732	140	700				
CS-810/300	800	1000	300	172	932	140	900				
CS-106/250	1000	600	250	172	532	140	500				
CS-106/300	1000	600	300	172	532	140	500				
CS-108/250	1000	800	250	172	732	140	700				
CS-108/300	1000	800	300	172	732	140	700				
CS-1010/300	1000	1000	300	172	932	140	900				
CS-126/250	1200	600	250	172	532	140	500				
CS-128/300	1200	800	300	172	732	140	700				
CS-1210/300	1200	1000	300	172	932	140	900				
CS-1212/250	1200	1200	250	2 x 172	532	2 x 140	500				



21/28 CS sheet steel wall-mounting enclosure

Indoor installation

CS-..., DT-...-CS, DS-...-CS

Internal view, door without enclosure

CS-5.../..., CS-6.../..., CS-7.../...

DT-5...-CS, DT-6...-CS, DT-7...-CS

DS-5...-CS, DS-6...-CS, DS-7...-CS

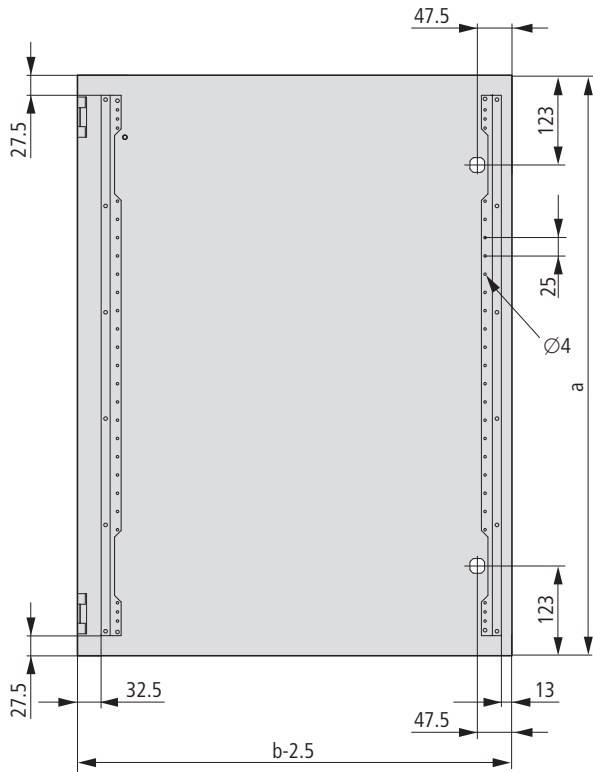

CS-10.../..., CS-12.../...

DT-10...-CS, DT-12...-CS

DS-10...-CS, DS-12...-CS

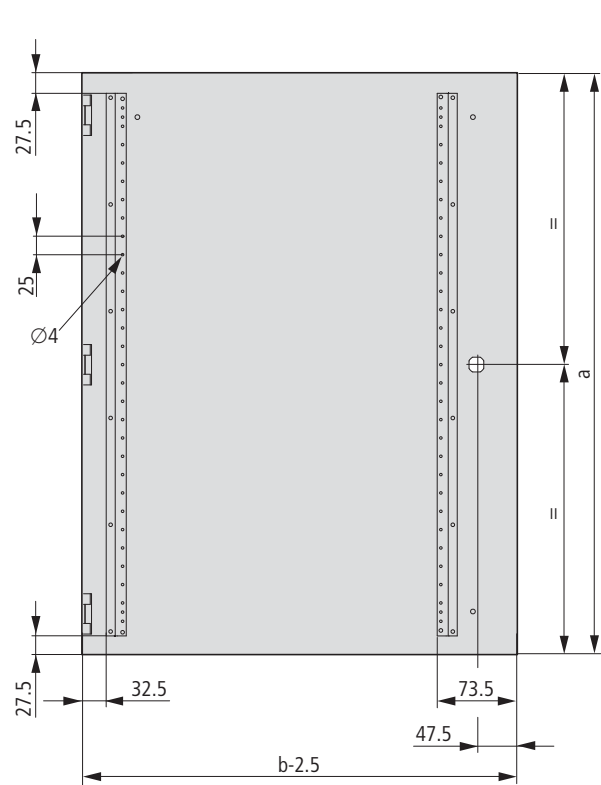

Internal view, door without enclosure

CS-8.../...

DT-8...-CS

DS-8...-CS

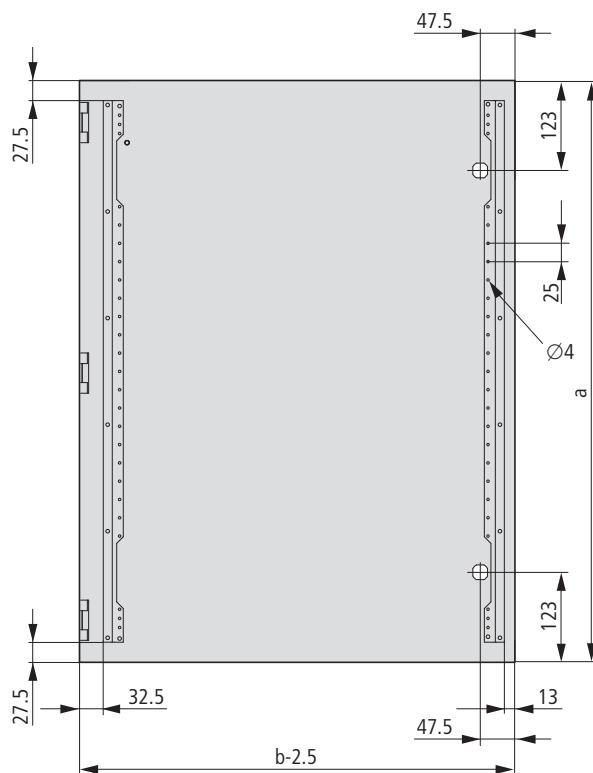

Mounting aperture

CS-...

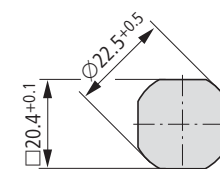

Position of the 4 drilling dimensions for wall fixing in the enclosure rear panel

CS-...

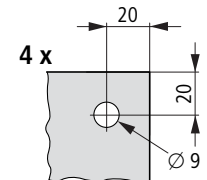

Position of the 4 threaded studs in the enclosure rear panel

CS-...

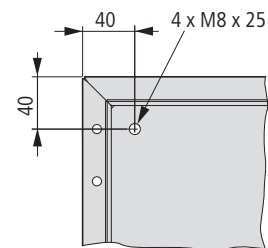

F3A enclosure base with flange apertures

300 x 200

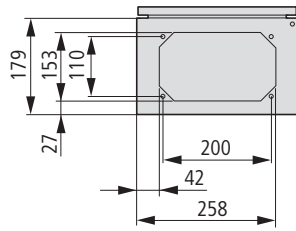

400 x 200

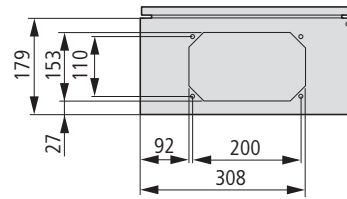

500 x 200

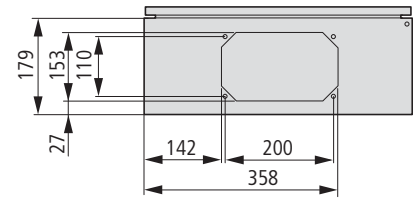

600 x 200

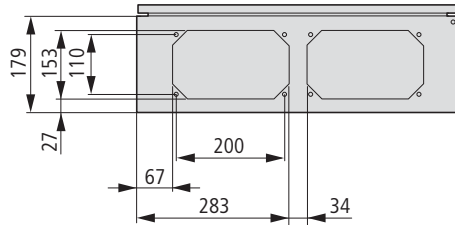

400 x 250

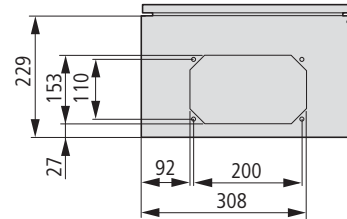

500 x 250

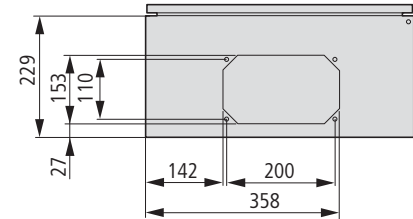

600 x 250

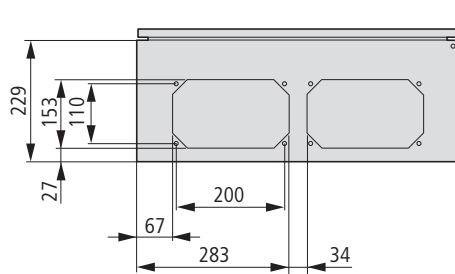

600 x 300

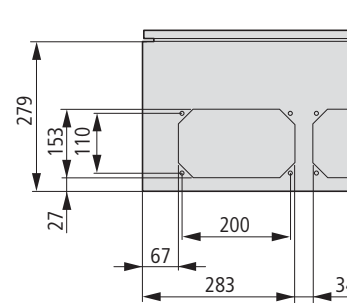

800 x 200

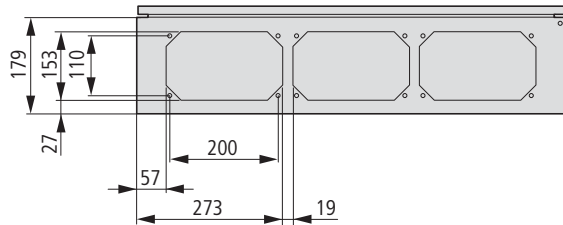

800 x 250

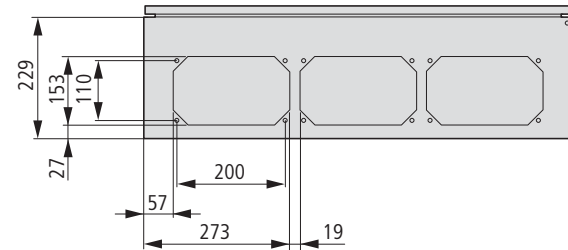

800 x 300

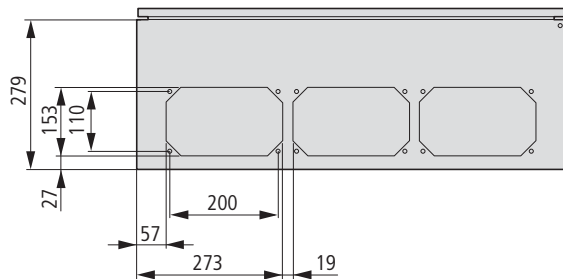

1000 x 300

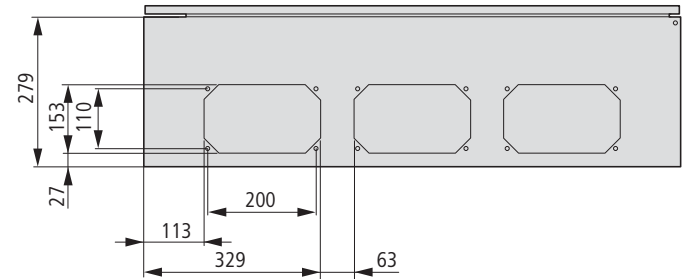

1200 x 250

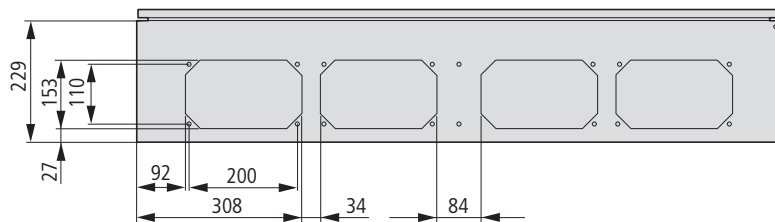

21/30 CS sheet steel wall-mounting enclosure

Indoor installation

CS-..., MPP, MPL, TS

Blank plate (equipment supplied)

300 x 200

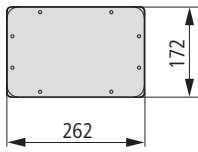

400 x 200

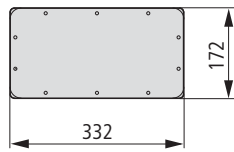

500 x 200

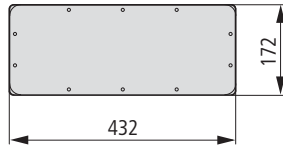

600 x 200

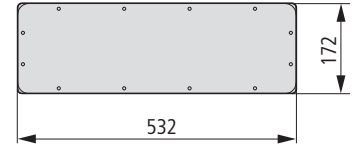

800 x 200

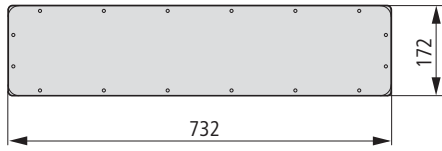

1000 x 200

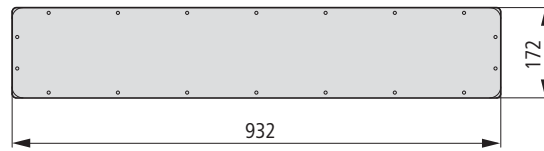

Mounting plates

MPP-...-CS

MPL-.../RAL2000-CS

MPL-...-CS

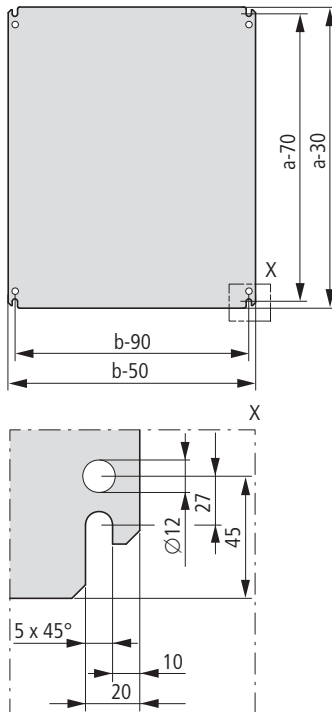

a, b = Enclosure dimensions

Part no.	Mounting plate	
	Height	Width
CS-2520/150	220	150
CS-32/150	270	150
CS-33/150	270	250
CS-33/200	270	250
CS-34/200	270	350
CS-43/150	370	250
CS-43/200	370	250
CS-44/150	370	350
CS-44/200	370	350
CS-46/200	370	550
CS-46/250	370	550
CS-46/300	370	550
CS-54/150	470	350
CS-54/200	470	350
CS-54/250	470	350
CS-55/250	470	450
CS-64/150	570	350
CS-64/200	570	350
CS-64/250	570	350
CS-65/150	570	450
CS-65/200	570	450
CS-65/250	570	450
CS-66/200	570	550
CS-66/250	570	550
CS-66/300	570	550
CS-68/300	550	770
CS-75/200	670	450
CS-75/250	670	450
CS-84/200	770	350
CS-84/250	770	350
CS-86/200	770	550
CS-86/250	770	550
CS-86/300	770	550
CS-88/200	770	750
CS-88/300	770	750
CS-810/300	770	950
CS-106/250	970	550
CS-106/300	970	550
CS-108/250	970	750
CS-108/300	970	750
CS-1010/300	970	950
CS-126/250	1170	550
CS-128/300	1170	750
CS-1210/300	1170	950
CS-1212/250	1170	1150

Mounting rail module for soft starters

TS35-DS4-CS

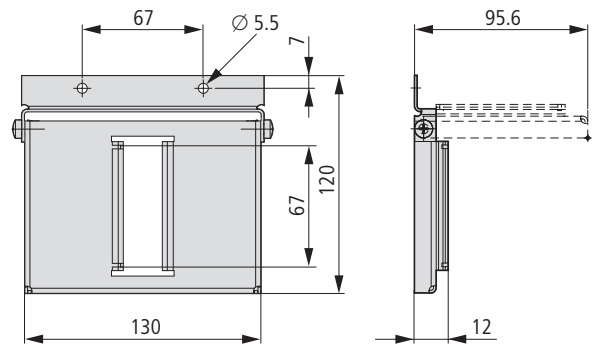

Wall fixing bracket

WFB-SET-CS

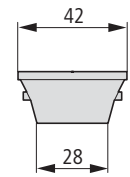
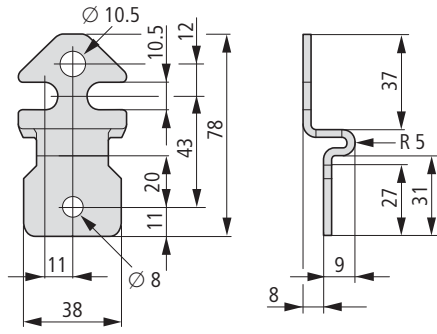

Base panels with flange apertures (for F3A...flange)

AFP-3-CS

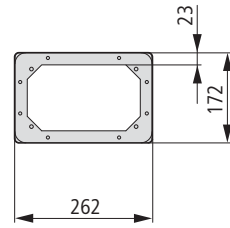

AFP-4-CS

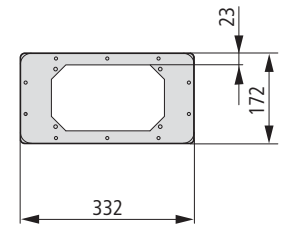

Base panels with flange apertures (for F3A...flange)

AFP-5-CS

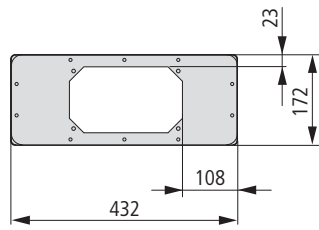

AFP-6-CS

AFP-12-CS = 2 x AFP-6-CS

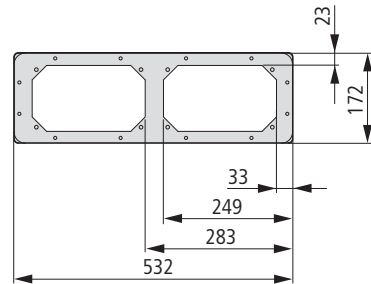

AFP-8-CS

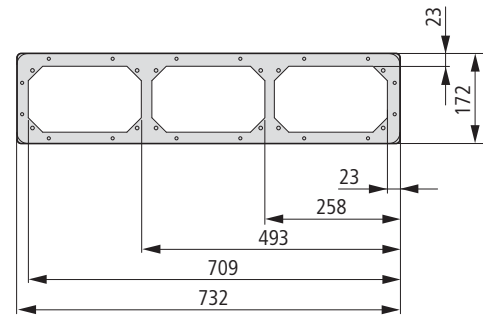

AFP-10-CS

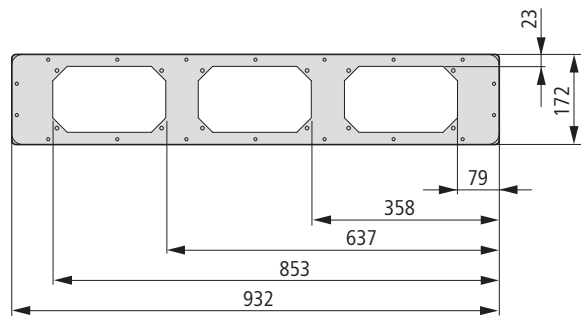

Flanges

F3A-..., ZSD-2K/FLA

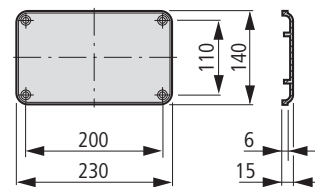

Flange aperture

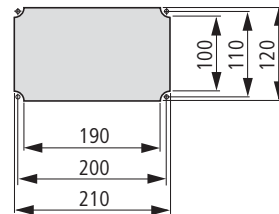

21/32 CS sheet steel wall-mounting enclosure

Outdoor installation

CNP, LVP

Rain canopies

CNP-...-CS

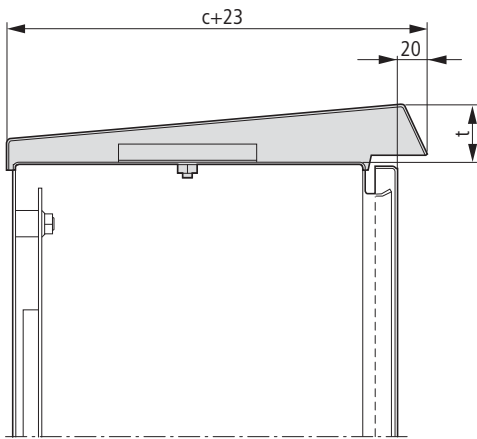

Part no.	c + 23	t
CNP-2/150-CS	173	30
CNP-3/150-CS	173	30
CNP-3/200-CS	223	34
CNP-4/150-CS	173	30
CNP-4/200-CS	223	34
CNP-4/250-CS	273	38
CNP-5/150-CS	173	30
CNP-5/200-CS	223	34
CNP-5/250-CS	273	38
CNP-6/200-CS	223	34
CNP-6/250-CS	273	38
CNP-6/300-CS	323	42
CNP-8/200-CS	223	34
CNP-8/250-CS	273	38
CNP-8/300-CS	323	42
CNP-10/300-CS	323	42
CNP-12/250-CS	273	38

c = Enclosure depth

Ventilating louvers

LVP-20V12-CS

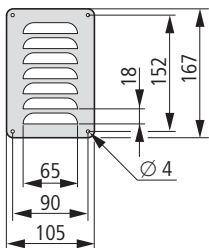

LVP-20H12-CS

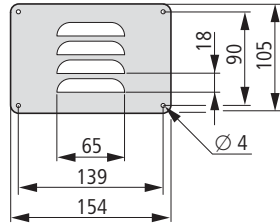

LVP-30V15-CS

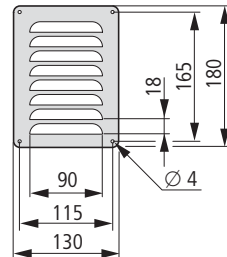

LVP-30H15-CS

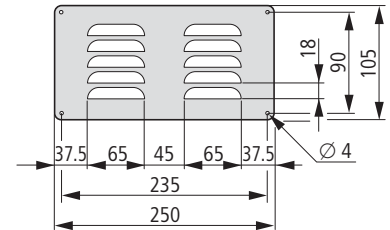

Cable glands, ventilation cable glands, cable grommet

→ See chapter 16, Accessories for panel building

