

SmartWire-Darwin Communication System



Moeller is Eaton

EATON

Powering Business Worldwide



xCommand
Control and Indication



xStart
Switching, protecting and actuating motors



xCommand
xSystem
Automation, control and visualization



Matching of Voltage and Current



xEnergy
Xpole
Energy distribution, switching and protection



Xboard
Optimal switchgear enclosure



SmartWire-Darwin Communication System



Foot and palm switches FAK, pilot devices RMO, signal towers SL

Position switches LS, pressure switches MCS, sensors

Cam switches T, switch-disconnectors P up to 315 A



Mini contactor relays, contactor relay, contactors DIL

Overload relay Z..., ZEB, ZEV, EMT6

Motor protective circuit breaker PKZ and PKE

MSC motor-starter combinations

DS, DM soft starters

Frequency inverters M-Max™, H-Max™



Timing relays DILET, ETR; measuring relays EMR and monitoring relays EMR

Easy control relay MFD-Titan multi-function display

Safety relay easySafety, safety-related control relay ESR5

Automation solutions, SPS, I/O systems, visualisation

Transformers STN, UTI; universal power supply units AING



Busbar system SASY – accessories for control panel building

Compact circuit-breakers NZM, compact switch-disconnectors N up to 1600 A

IZM circuit-breakers, IN switch-disconnectors up to 6300 A

Circuit-breakers, fuses



Insulated enclosures CI, small enclosures CI-K

CS sheet steel wall-mounting enclosure



Commercial and logistic notes, approvals, After Sales Service, type / alphabetical index



SmartWire Darwin communication system

Connect don't wire

For the manufacturer of machinery and installations, nothing is more important than finding the balance between maximum functionality and optimal costs. Designed for further development, SmartWire-Darwin is a communication system for industrial control equipment in control panels and in the periphery: from control, protection and switching to actuation, operation and monitoring.

A technology that will win you profits, now and in the future.

SmartWire-Darwin greatly reduces wiring expenses and helps save costs: from design through construction and commissioning, up to expansions. SmartWire-Darwin relies on the proven Eaton Moeller industrial control equipment and enables these devices to communicate.

- Planning and engineering efficiently
- Fast commissioning
- Maintenance with direct diagnostics
- Connecting error-free
- Convenient operation
- Simple expansion



Information about SmartWire-Darwin

is available in the Online Manual on www.moeller.net/support:

SmartWire Darwin: System (AWB2723-1617de)

SmartWire Darwin: Gateways (AWB2723-1612de)

SmartWire Darwin: Stations (AWB2723-1613de)

SmartWire Darwin products in this catalogue:

Chap. 1- SmartWire Darwin- the complete range

Chap. 2- RMQ-Titan pilot devices, RMQ connections

Chap. 5- contactors, contactor modules

Chap. 7- motor-protective circuit-breaker

Chap. 9- soft starter, DS7

Chap. 17- NZM circuit-breaker to 1600 A, interface module

	SmartWire-Darwin System	
	Description	1/2
	System overview	1/4
	SWD Gateways, I/O modules, power feed modules	
	Ordering	1/6
	SWD connections at RMQ-Titan pilot devices	
	System overview	1/8
	Ordering	1/10
	SWD modules to connect contactors and motor starters.	
	System overview	1/12
	Ordering	1/14
	SWD-capable Soft starter DS7	
	System overview	1/15
	Ordering	1/15
	SWD interface module for NZM circuit-breakers	
	System overview	1/16
	Ordering	1/16
	SWD accessories	
	Ordering	1/17
Engineering		
Power-/current consumption of the SWD stations	1/19	
Technical data		
SWD gateways, Powerfeed modules	1/20	
SWD I/O modules	1/22	
SWD connections at RMQ-Titan pilot devices	1/24	
SWD modules to connect contactors, motor starters and circuit breaker NZM.	1/26	
SWD accessories	1/28	
Dimensions		
SWD modules and RMQ connections	1/30	
Accessories	1/31	



Description

SmartWire-Darwin.

Secures your know-how.

SmartWire-Darwin significantly cuts your wiring requirements and helps you save costs across the entire value chain from design through construction, programming, commissioning to extending your system. Utilizing Eaton's industrial switchgear, SmartWire-Darwin is based on tried-and-tested technology. SmartWire-Darwin makes Eaton industrial switchgear communications-enabled.

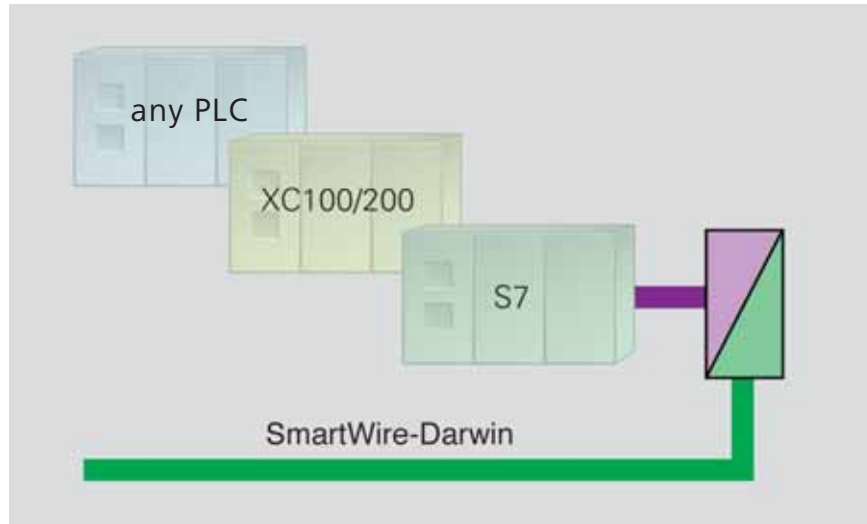

Your user program remains intact

Incorporating the SmartWire-Darwin gateway in the Eaton PLC program is also easy. Only the PLC configuration needs to be modified—the user program remains unchanged making the transition to SmartWire-Darwin, including PLC programming quick and easy. Your software expertise is safe!

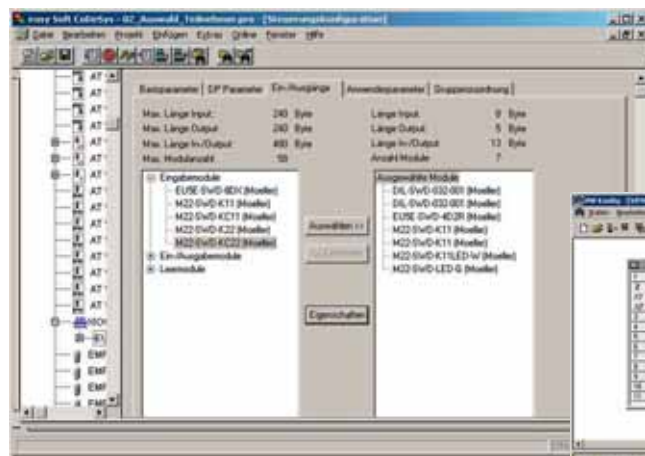

SmartWire-Darwin in the STEP 7 PLC configuration

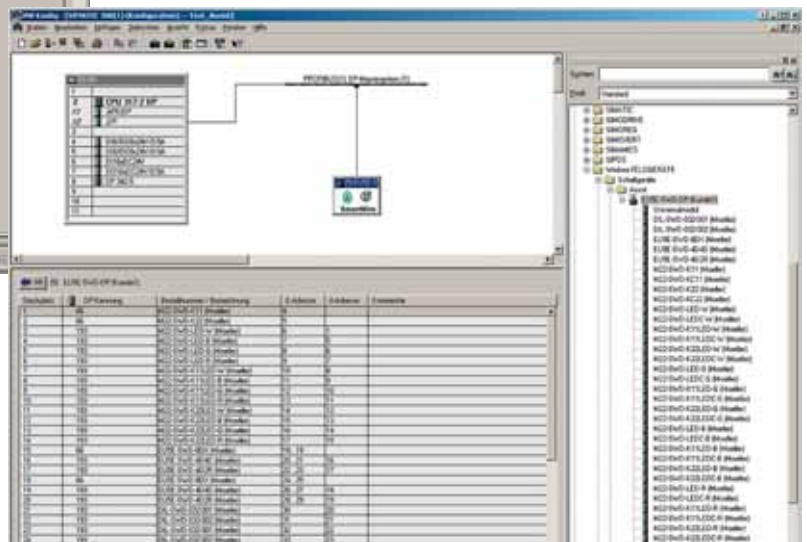

SmartWire-Darwin in the easySoft-CoDeSys PLC configuration



Planning and ordering help (SWD?Assist)

- Easy generation of applications with the SmartWire-Darwin System
- Integrated function for the generation of ordering lists
- Integrated plausibility check
- Online functionality
 - Simple preliminary commissioning of SmartWire-Darwin inputs and outputs and function testing
 - Easy diagnostics of SmartWire-Darwin slaves
- Download
 - Free download under <http://downloadcenter.moeller.net>

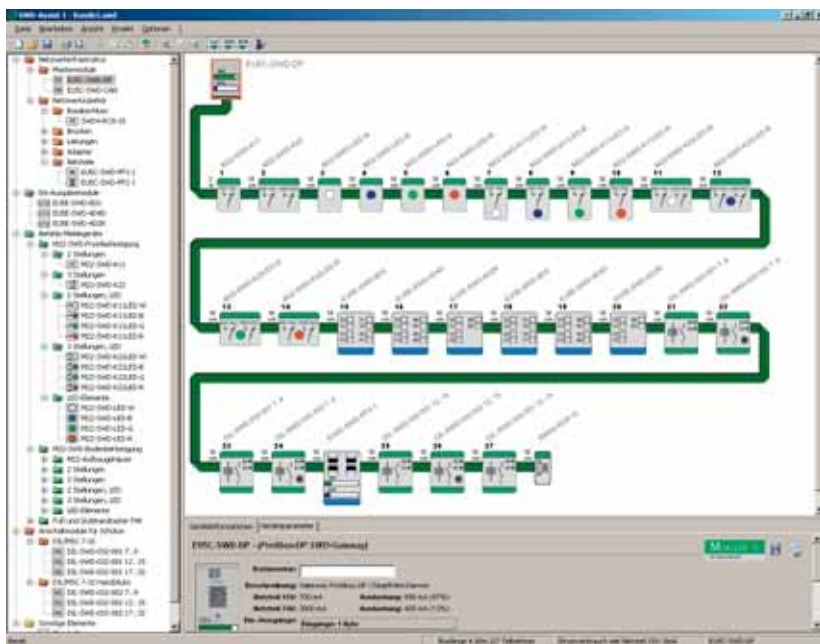

Planning a SmartWire-Darwin string is quick and easy with the SWD-Assist software



System overview

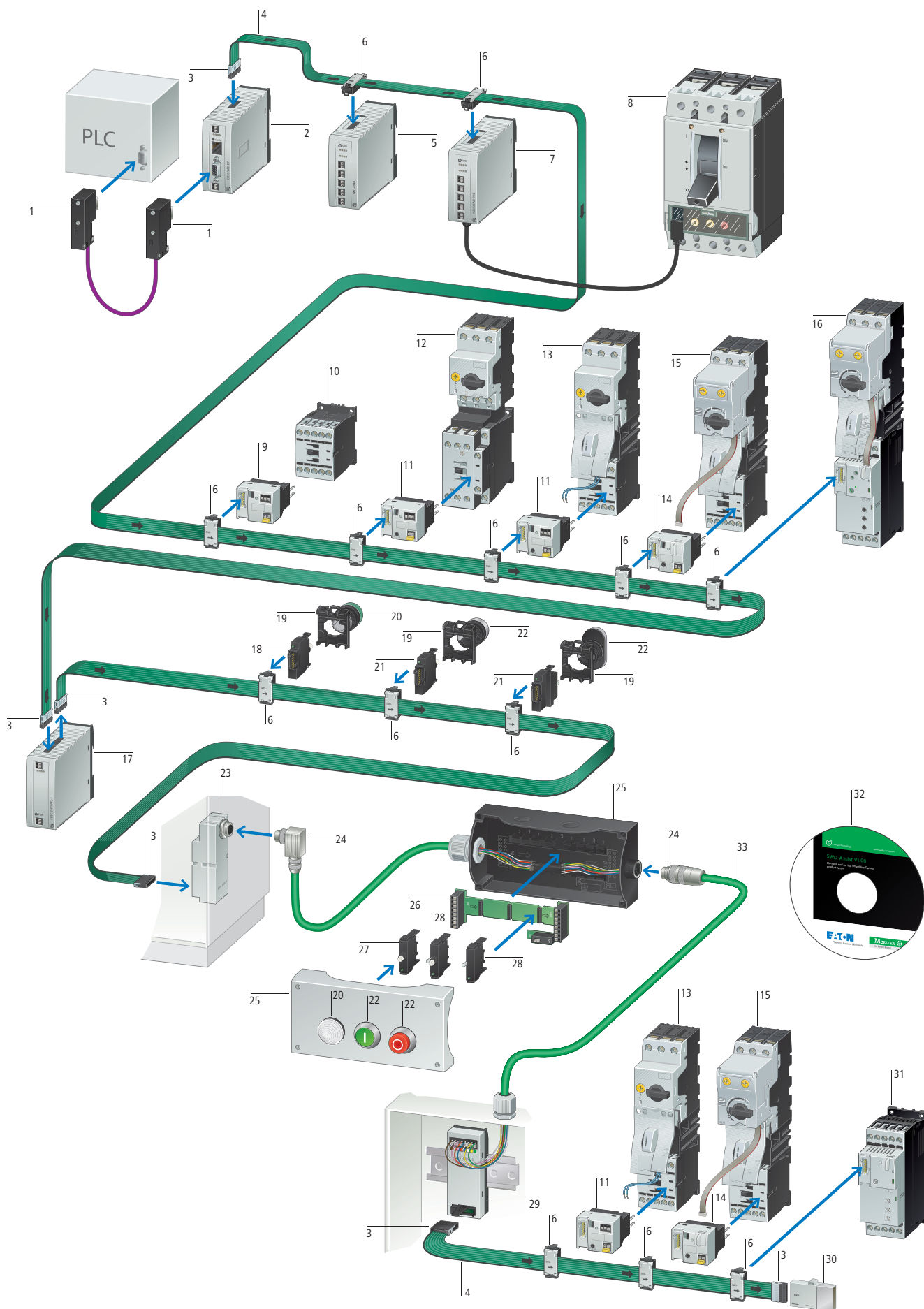

Sub-D data plug, 9 pole	1	SmartWire-Darwin contactor module	9	SmartWire-Darwin powerfeed module	17	RMQ-Titan surface mounting enclosure	25
SmartWire-Darwin gateways	2	DILM contactors	10	SmartWire-Darwin LED elements, front fixing	18	SmartWire-Darwin card for function elements, base fixing	26
SmartWire-Darwin blade terminal 8 pole	3	SmartWire-Darwin contactor module with Manual-0-Automatic switch	11	RMQ-Titan mounting adapter for front mounting	19	SmartWire-Darwin LED elements for base fixing	27
SmartWire-Darwin ribbon cable, 8 pole	4	Motor protective circuit breakers	12	RMQ-Titan indicator light	20	SmartWire-Darwin Function elements for base fixing	28
SmartWire-Darwin input/output modules	5	MSC motor starters	13	SmartWire-Darwin function elements for front fixing	21	SmartWire-Darwin adapter for flat/round cable for top-hat rail mounting	29
SmartWire-Darwin device plug 8 pole	6	SmartWire-Darwin PKE modules	14	SmartWire-Darwin operating elements	22	SmartWire-Darwin network termination for 8 pole ribbon cable	30
SmartWire-Darwin connection for NZM	7	PKE motor starters with electronic motor protection	15	SmartWire-Darwin control panel cable adapter for flat to round cable	23	DS7 soft starters	31
NZM circuit-breakers	8	DS7 soft starter with PKE electronic motor protection	16	SmartWire-Darwin plug connectors	24	SmartWire-Darwin planning and ordering aid, SWD-Assist	32
						SmartWire-Darwin round cable, 8 pole	33

Features

SmartWire-Darwin gateway

- Connection of SmartWire-Darwin to fieldbus.
- Supports the PROFIBUS-DP and CANopen fieldbuses.
- Provides of the supply voltage for the SmartWire-Darwin slaves.
- Supplies the control voltage for the motor starters or contactors.
- Configuration button for automatic addressing of the SmartWire-Darwin slaves.
- Support of up to 99 SmartWire-Darwin slaves.
- Connection of the SmartWire-Darwin ribbon cable via blade terminal.

SmartWire-Darwin input/output module

- Connection to SmartWire-Darwin ribbon cable via device plug.
- Integration of other switching devices without integrated SmartWire-Darwin technology.
- Variant with 8 digital inputs, or 4 digital inputs and 4 non-isolated transistor outputs, or 4 digital inputs and 2 relay outputs 250 V AC.
- SmartWire-Darwin diagnostics LED for signalling of the communication status of the module.

Power feeder module















- Connection to SmartWire-Darwin ribbon cable via blade terminal.
- Provides of the supply voltage for the SmartWire-Darwin slaves.
- Control voltage feeder for the motor starters and contactors.
- Formation of emergency-stop groups.

Planning and ordering help (SWD-Assist)

- Easy generation of applications with the SmartWire-Darwin system.
- Integrated function for the generation of ordering lists.
- Integrated plausibility check.
- Online functionality
 - Simple preliminary commissioning of SmartWire-Darwin inputs and outputs and function testing.
 - Easy diagnostics of SmartWire-Darwin slaves
- Free download under <http://downloadcenter.moeller.net>



Ordering

Description	Part no. Article no.	Price See price list	Std. pack	
SWD gateways				
Gateway to the connection to the fieldbus and for supplying the SmartWire-Darwin (SWD) slaves and switchgear.				
 <p>Connection to PROFIBUS-DP as slave. Automatic baud rate detection from 9.6 kBit/s to 12 Mbit/s. Address range 1 - 126. 9 pole SUB-D socket. Connection of up to 58 SWD slaves.</p>	EU5C-SWD-DP 116308		1 off  	
	EU5C-SWD-CAN 116307		1 off  	
SWD I/O modules				
SmartWire-Darwin slaves for the connection of digital I/O signals.				
 <p>Digital module with 8 digital inputs 24 V DC</p> <p>Digital module with 4 digital inputs 24 V DC and 4 transistor outputs 24 V DC/0.5 A</p> <p>Digital module with 4 digital inputs 24 V DC and 2 relay outputs 250 V AC</p>	EU5E-SWD-8DX 116381		1 off  	
	EU5E-SWD-4D4D 116382			
	EU5E-SWD-4D2R 116383			
SWD powerfeed module				
 <p>For additional control voltage supply of the motor starters and contactors. For the formation of emergency-stop groups for the motor starters and contactors.</p>	EU5C-SWD-PF1-1 116309		1 off  	
	 <p>For the supply of other SWD slaves. For additional control voltage supply of the motor starters and contactors. For the formation of emergency-stop groups for the motor starters and contactors.</p>	EU5C-SWD-PF2-1 116380		1 off  

Information relevant for export to North America



NA Certification Request filed for UL and CSA
UL/CSA approval applied for



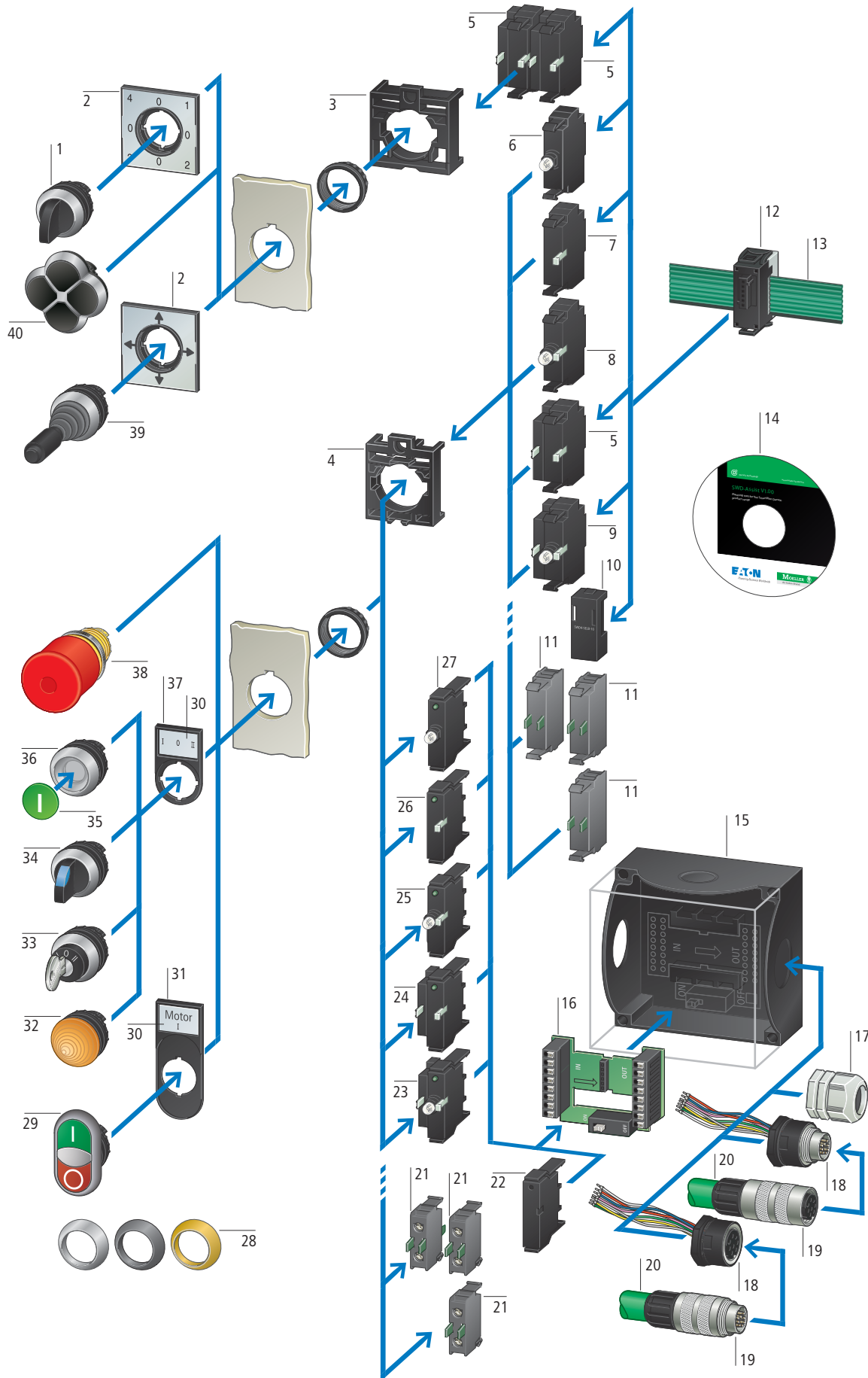



RMQ-Titan, 4-way selector switch → Chapter 2	1	RMQ-Titan, M22 contact elements for front mounting → Chapter 2	11	RMQ-Titan, M22 contact elements with base fixing → Chapter 2	21	RMQ-Titan, insert labels → Chapter 2	30
RMQ-Titan, label with label mount for 4-way selector switch and joystick → Chapter 2	2	SWD device plug → Page 1/17	12	Link for SWD PCB → Page 1/11	22	RMQ-Titan, label mount for double actuator push-buttons → Chapter 2	31
SWD front mounting adapter for 2 × M22-SWD-K22 → Page 1/11	3	SWD ribbon cable → Page 1/17	13	SWD function element with 3 positions and LED for base fixing → Features	23	RMQ-Titan, indicator light → Chapter 2	32
RMQ-Titan, front mounting adapter with three mounting locations → Page 1/11	4	SWD-Assist, Planning and ordering help → Features	14	SWD function element with 3 positions for base fixing → Features	24	RMQ-Titan, key-operated actuator → Chapter 2	33
SWD function element with 3 positions for front mounting → Features	5	RMQ-Titan, surface mounting enclosure → Chapter 2	15	SWD function element with 2 positions and LED for base fixing → Features	25	RMQ-Titan, selector switch actuator → Chapter 2	34
SWD LED element for front mounting → Features	6	SWD PCB for surface mounting enclosure → Features	16	SWD function element with 2 positions for base fixing → Features	26	RMQ-Titan, button plates/button lenses → Chapter 2	35
SWD function element with 2 positions for front mounting → Features	7	Cable gland for SWD round cable → Chapter 2	17	SWD LED element for base fixing → Features	27	RMQ-Titan, pushbutton actuators → Chapter 2	36
SWD function element with 2 positions and LED for front mounting → Features	8	SWD bulkhead plug/socket RJ45 with prefabricated signal cables → Features	18	RMQ-Titan, bezels → Chapter 2	28	RMQ-Titan, label mounts → Chapter 2	37
SWD function element with 3 positions and LED for front mounting → Features	9	SWD socket/plug for round cable → Features	19	RMQ-Titan, double actuators → Chapter 2	29	RMQ-Titan, emergency stop pushbuttons (for safety circuits use only standard contacts M22) → Chapter 2	38
Link for SWD device plugs → Features	10	SWD round cable → Page 1/18	20			RMQ-Titan, joystick → Chapter 2	39
						RMQ-Titan, 4-way pushbutton → Chapter 2	40

Features

SWD-RMQ connection for front fixing → Page 1/10

- Adaptation with standard adapter M22-A or M22-SWD-A4 for 4-way selector switch/pushbutton and joystick.
- Combination with standard pilot devices of the RMQ-Titan M22 serie.
- Types with one or two change over contacts and with/without integrated LED element.
- LED elements in four colors.
- SmartWire-Darwin diagnostics LED for signalling of the communication status of the function element.
- Connection to SmartWire-Darwin ribbon cable with device plug.

Link for device plug → Page 1/11

- Connection to SmartWire-Darwin device plug.
- Suitable for bridging adapted external SmartWire-Darwin device plugs (e.g. as placeholders).

Surface mounting enclosure with PCB → Page 1/11

- Connection of SmartWire-Darwin function elements for base fixing.
- Type with 1, 2, 3, 4 and 6 slots.
- Bridging of free slots with link for base fixing.
- Integrated connectable network terminator.

SWD RMQ connection for base fixing → Page 1/10

- For use with SWD PCB, RMQ-Titan surface mounting enclosure and RMQ-Titan M22 control circuit devices.
- Types with one or two change over contacts and with/without integrated LED element.
- LED elements in four colors.
- SmartWire-Darwin diagnostics LED for signalling of the communication status of the function element.

Housing bushing socket → Page 1/18











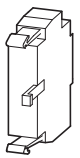

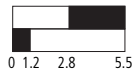
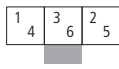

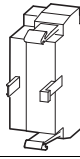

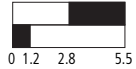
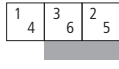

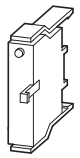

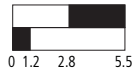
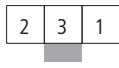

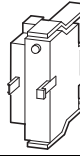

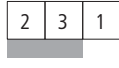

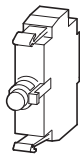

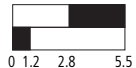
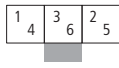





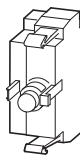

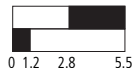
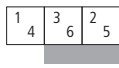





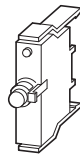

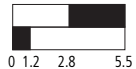
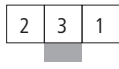

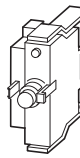

- Use for RMQ-Titan M22 surface mounting enclosure or control panel.
- Type plug/socket.
- Prefabricated signal cable with ferrules for connection to PCB for surface mounting enclosure.

Planning and ordering help (SWD Assist)

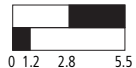
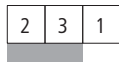
- Easy generation of applications with the SmartWire-Darwin system.
- Integrated function for the generation of ordering lists.
- Integrated plausibility check.
- Online functionality:
 - Simple preliminary commissioning of SmartWire-Darwin inputs and outputs and function testing.
 - Easy diagnostics of SmartWire-Darwin slaves.
- Free download under <http://downloadcenter.moeller.net>



Ordering

	Number of contacts	Circuit symbol	Contact travel diagram in connection with front element	Configuration	Color LED	Part no. Article no.	Price See price list	Std. pack
Function elements								
Front fixing								
	1 change over contact		 0 1.2 2.8 5.5		without LED	M22-SWD-K11 115964		20 off  
	2 change over contacts		 0 1.2 2.8 5.5		without LED	M22-SWD-K22 115965		10 off  
Base fixing								
	1 change over contact		 0 1.2 2.8 5.5		without LED	M22-SWD-KC11 115995		20 off  
	2 change over contacts		 0 1.2 2.8 5.5		without LED	M22-SWD-KC22 115996		10 off  
Front fixing								
	1 change over contact		 0 1.2 2.8 5.5			M22-SWD-K11LED-W 115972		20 off  
						M22-SWD-K11LED-B 115973		
						M22-SWD-K11LED-G 115974		
						M22-SWD-K11LED-R 115975		
	2 change over contacts		 0 1.2 2.8 5.5			M22-SWD-K22LED-W 115978		10 off  
						M22-SWD-K22LED-B 115979		
						M22-SWD-K22LED-G 115980		
						M22-SWD-K22LED-R 115981		
Base fixing								
	1 change over contact		 0 1.2 2.8 5.5			M22-SWD-K11LEDC-W 116003		20 off  
						M22-SWD-K11LEDC-B 116004		
						M22-SWD-K11LEDC-G 116005		
						M22-SWD-K11LEDC-R 116006		
	2 change over contacts		 0 1.2 2.8 5.5			M22-SWD-K22LEDC-W 116009		10 off  
						M22-SWD-K22LEDC-B 116010		
						M22-SWD-K22LEDC-G 116011		
						M22-SWD-K22LEDC-R 116012		

Notes

SWD function elements can be combined with RMQ-Titan operating elements M22... → Chapter "Control circuit devices"













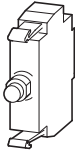







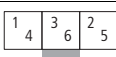



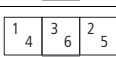



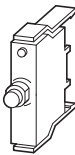
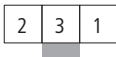



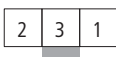



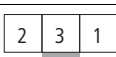







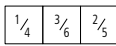



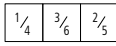

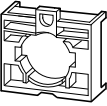
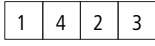

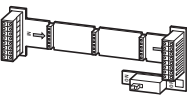



Information relevant for export to North America

NA Certification Request filed for UL and CSA
UL/CSA approval applied for

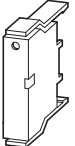

HPL010111EN

		Configuration	Color LED	Part no. Article no.	Price See price list	Std. pack	Information relevant for export to North America  
LED elements							
Front fixing							
				M22-SWD-LED-W 115966		20 off  	NA Certification Request filed for UL and CSA UL/CSA approval applied for.
				M22-SWD-LED-B 115967		20 off  	
				M22-SWD-LED-G 115968		20 off  	
				M22-SWD-LED-R 115969		20 off  	
Base fixing							
				M22-SWD-LEDC-W 115997		20 off  	NA Certification Request filed for UL and CSA UL/CSA approval applied for.
				M22-SWD-LEDC-B 115998		20 off  	
				M22-SWD-LEDC-G 115999		20 off  	
				M22-SWD-LEDC-R 116000		20 off  	
Fixing adapters							
Front fixing							
	For 1 function element M22-SWD-K... or LED element M22-SWD-LED... In addition 1 or 2 contact elements M22-K... possible.			M22-A 216374		50 off  	UL/CSA certification not required
	Sequence number on fixing adapter.			M22-A-GVP 216375		500 off  	UL/CSA certification not required
	For 2 function elements M22-SWD-K22... For use with M22-WR4, -WRJ4, -D4 in conjunction with M22-(SWD)-K			M22-SWD-A4 116016		10 off  	NA Certification Request filed for UL and CSA UL/CSA approval applied for.
Printed circuit boards							
PCBs for surface mounting enclosure M22-I... for mounting base function elements M22-SWD...K. Integrated, connectable SWD network terminator							
	Number of mounting locations:	1		M22-SWD-I1-LP01 115990		1 off  	NA Certification Request filed for UL and CSA UL/CSA approval applied for.
		2		M22-SWD-I2-LP01 115991		1 off  	
		3		M22-SWD-I3-LP01 115992		1 off  	
		4		M22-SWD-I4-LP01 115993		1 off  	
		6		M22-SWD-I6-LP01 115994		1 off  	
Link							
Bridging of open mounting locations on M22-SWD-I...-LP01 PCB							
Base fixing							
				M22-SWD-SEL8-10 116698		5 off  	NA Certification Request filed for UL and CSA UL/CSA approval applied for.

Notes

SWD LED elements can be combined with RMQ-Titan indication elements M22... → Chapter "Control circuit devices"



System overview

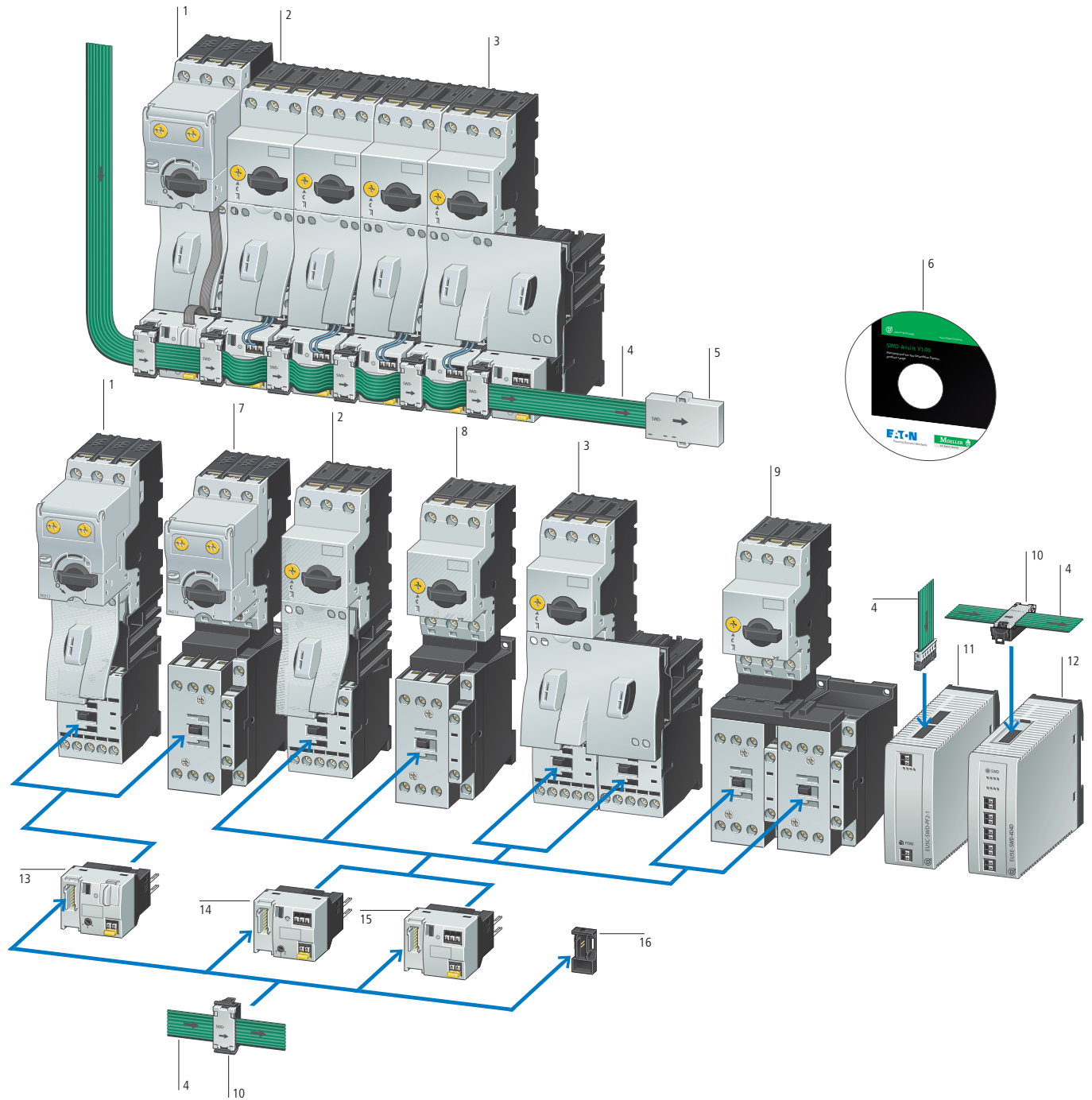

MSC-DEA networkable PKE-based motor starters up to 7 kW → Features	1	Network terminator → Page 1/17	5	MSC-R reversing starters based on PKZM0 up to 15 kW → Chapter 8	9	Modules SWD PKE modules → Features	13
MSC-D DOL starters based on PKZM0 up to 7 kW → Chapter 8	2	Planning and ordering help, SWD assist → Features	6	SWD device plug → Page 1/17	10	SWD contactor module with manual/auto functionality → Features	14
MSC-R reversing starters based on PKZM0 up to 7 kW → Chapter 8	3	MSC-DEA networkable PKE-based motor starters up to 15 kW → Features	7	Power feeder module → Features	11	SWD contactor module → Features	15
SWD ribbon cable → Page 1/17	4	MSC-D DOL starters based on PKZM0 up to 15 kW → Chapter 8	8	SWD input/output module with relay outputs → Features	12	Link for device plug → Page 1/17	16

Features

MSC-DEA networkable PKE-based motor starter → Chapter 8

- Plug & play-capable motor starter combination up to 15 kW, consisting of PKE basic unit, contactor DILM and PKE trip block PKE-XTUA.
- Exchangeable trip blocks for cover of current ranges.
- Wide-range overload protection ratio 4:1.
- Adjustable time-lag classes (CLASS 5, 10, 15, 20) for different tripping characteristics.
- Networkable via SWD PKE module.

Powerfeed module → Page 1/6

- Provision of SmartWire-Darwin supply voltage.
- Provision of 24 V DC supply voltage for activating the contactors.
- Formation of emergency-stop groups.

SWD PKE module → Page 1/14

- Pluggable onto contactors in the xStart range.
- Suitable for motor starters MSC-DEA... (24 V DC) or DILM(C)7 -DILM(C)32 in combination with PKE12/32 and trip block PKE-XTUA-...
- Use of the standard switchgear of the xStart range.
- Use of the standard accessories in the xStart range.
- Integrated mechanical contactor switching state indication.
- Integrated contactor switching state scanning.
- Transmission of PKE-specific data (switch position PKE, relative motor current, thermal motor image, trip indications (overload, short-circuit,...), type PKE trip block, set value of overload release and time-lag class).
- Communication cable (PKE32-COM) for connection to PKE trip block included as standard.
- Contactor actuation.
- Selectable ZMR functionality (contactor opening on overload).
- SWD diagnostics LED for signalling the communication status of the modules and signalling of the switch command via SmartWire-Darwin.
- Manual/Auto functionality for automatic or manual switching on of the connected contactor.
- Connection to SmartWire-Darwin ribbon cable via device plug.

SWD contactor module → Page 1/14

- Pluggable onto contactors in the xStart range.
- Suitable for contactors DILM7 DILM38 (24VDC), DILMC7...DILMC32 (24 VDC), DILA DILMP20 DILMP45 (24 VDC RDC24) or motor starter MSC-... (24 VDC).
- Use of the standard switchgear of the xStart range.
- Use of the standard accessories in the xStart range.
- Suitable for contactor combinations with PKZ or with Z overload relays.
- Integrated switch position scanning.
- Integrated mechanical switch position indication.
- Contactor actuation.
- SWD diagnostics LED for signalling the communication status of the modules and signalling of the switch command via SmartWire-Darwin.
- Two digital inputs for scanning floating contacts, such as motor-protective circuit-breaker auxiliary contacts.
- For DIL-SWD-32-002 built-in Manual/Auto functionality for automatic or manual switching on of the connected contactor.
- Connection to SmartWire-Darwin ribbon cable via device plug.

SWD input/output modules → Page 1/6

- Digital module with four 24 V DC digital inputs and two relay outputs for actuating contactors DILM40-DILM72.
- Connection to SmartWire-Darwin through device plug.

Link for device plug → Page 1/17

- Connection to SmartWire-Darwin device plug.
- Suitable for the bridging of already adapted device plugs (e.g. as a placeholder).

Planning and ordering help (SWD assist)

- Easy generation of applications with the SmartWire-Darwin system.
- Integrated function for the generation of ordering lists.
- Integrated plausibility check.
- Online functionality.
 - Simple preliminary commissioning of SmartWire-Darwin inputs and outputs and function testing.
 - Simple diagnostics of SmartWire-Darwin slaves.
- Free download under <http://downloadcenter.moeller.net>

Safety engineering

- Emergency-stop disconnection to IEC/EN 954-1, switching category 3; EN ISO 13849-1 PL d; IEC 62061 SIL 2
- Central switch off of the control voltage at the gateway or power feeder module.
- Combination with safety-related switchgears possible.







Design note

"The number of motor starters or DILM contactors that can be connected is dependent upon the power consumption of the magnet systems per SmartWire Darwin line. To increase the number of SmartWire-Darwin modules that can be connected power feeder modules can be used."

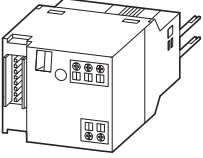
24 V DC	DILM(C)7, DILA	DILM(C)9	DILM(C)12, DILMP20	DILM(C)15	DILM(C)17	DILM(C)25	DILM(C)32, DILMP32	DILM38, DILMP45
Pick-up power [W]	3	3	4.5	4.5	12	12	12	12
Holding power [W]	3	3	4.5	4.5	0.5	0.5	0.5	0.5

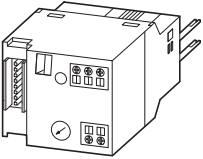

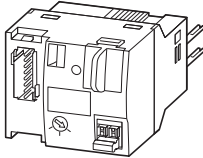
Ordering

Description	For use with	Part no. Article no.	Price See price list	Std. pack
SWD contactor modules¹⁾				
SmartWire-Darwin module for surface-mounting on contactors. Per contactor 1 module.				
	Two digital inputs for floating contacts. 1 electrical interlock for the surface mounting of reversing starters. Messages: contactor switch status, status of the digital inputs 1 and 2. Commands: contactor actuation	DILM(C)7... - DILM(C)32 DILM38 DILA MSC-D(E)-...(24VDC)	DIL-SWD-32-001 118560	5 off 
	Two digital inputs for floating contacts. 1 electrical interlock for the surface mounting of reversing starters. 1-0-A switch for manual or automatic operation. Messages: contactor switch status, status of the digital inputs 1 and 2, switch position 1-0-A switch. Commands: contactor actuation	DILM(C)7... - DILM(C)32 DILM38 DILA MSC-D(E)-...(24VDC)	DIL-SWD-32-002 118561	5 off 
SWD PKE module¹⁾²⁾				
SmartWire-Darwin module for connection of motor starter combination, model "extended" 24 V DC (MSC-DEA-...) up to 15 kW. One module per contactor and PKE.				
	Surface-mounting to contactors. Interface for connection of PKE trip block PKE-XTUA-... Connecting cable between module and trip block PKE-XTUA-... included as standard. 1 electrical interlock for the surface mounting of reversing starters. 1-0-A switch for manual or automatic operation. Selectable overload relay function (ZMR) for disconnecting the contactor on overload. Messages: - Switch position contactor/PKE/1-0-A switch - Motor current in % - Thermal motor image in % - Trip-indicating auxiliary contact (overload, short-circuit,...) - Set value of overload release - Set value of time lag (CLASS), type of trip block Commands: contactor actuation, activation of overload relay function (ZMR)	DILM(C)7... - DILM(C)32 MSC-DEA	PKE-SWD-32 126895	4 off 

Notes

- Take into account the max. current consumption of the contactor coils per SmartWire-Darwin line.
 - A2 connections must not be bridged.
 - Wiring sets DILM 12-XRL and PKZM0-XRM12 cannot be used.
 - Connection terminals for electrical interlocking are not suitable for safety technology.
- Additional SWD contactor module required for actuation of reversing starter.

Information relevant for export to North America



NA Certification Request filed for UL and CSA
UL/CSA approval applied for



HPL01015EN

System overview

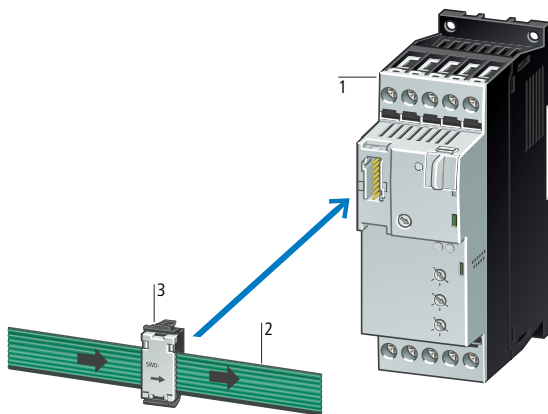

DS7 smartWire-Darwin soft starters	1
SWD ribbon cable	2
SWD device plug	3

Short description

The DS7-...-D soft starters are designed for connection to SmartWire-Darwin. These two-phase-controlled soft starters control three-phase motors for applications with normal operating frequency in the 4 to 200 A rating range (1.5 to 110 kW at 400 V mains voltage). Due to Eaton's special control method the true running behavior of a DS7 can be compared with that of three-phase soft starters. SmartWire-Darwin provides a direct connection to the DS7 without control signal wiring. Through SmartWire-Darwin the PLC transmits all control signals directly to the soft starter. The device data are available for processing in the master controller without any additional requirements. The connection with SmartWire-Darwin is fast, easy, inexpensive and convenient.

Note:

For further details see section "Soft starters"

Ordering

	Rated operational current of the soft starter			Assigned motor rating	Part no. Article no.	Price See price list	Std. pack	Information relevant for export to North America
	I_e A	400 V P kW	480 V P HP					
Soft starters Soft starters for three-phase loads, mains supply voltage 230–480 V AC (50/60 Hz) Rated control circuit voltage U_c : 24 V DC SmartWire-Darwin								
	4	1.5	2	2	DS7-34DSX004N0-D 134943	1 off	Product Standards IEC/EN 60947-4-2; GB 14048.6; UL 508; CSA-C22.2 No 0-M91; CSA-C22.2 No 14-05 CE marking NA Certification Request filed for UL and CSA Suitable for Branch circuits Max. Voltage Rating 480 V Degree of Protection IP20; UL/CSA Part no. 1	
	7	3	3	3	DS7-34DSX007N0-D 134945			
	9	4	5	5	DS7-34DSX009N0-D 134946			
	12	5.5	7.5	7.5	DS7-34DSX012N0-D 134947			
	16	7.5	10	10	DS7-34DSX016N0-D 134948			
	24	11	15	15	DS7-34DSX024N0-D 134949			
	32	15	20	20	DS7-34DSX032N0-D 134950			
	41	22	30	30	DS7-34DSX041N0-D 134952			
	55	30	40	40	DS7-34DSX055N0-D 134953			
	70	37	50	50	DS7-34DSX070N0-D 134954			
	81	45	60	60	DS7-34DSX081N0-D 134955			
	100	55	75	75	DS7-34DSX100N0-D 134956			
	135	75	100	100	DS7-34DSX135N0-D 134957			
	160	90	125	125	DS7-34DSX160N0-D 134958			
	200	110	150	150	DS7-34DSX200N0-D 134959			



System overview

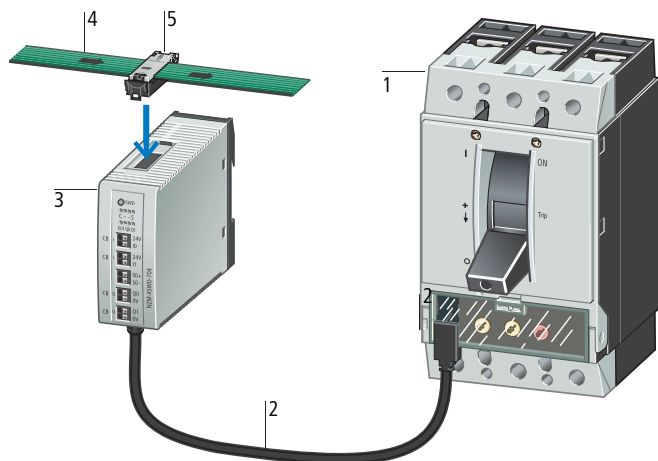

- 1 SmartWire-Darwin
NZM circuit-breakers
- 2 Connection cable from NZM
to NZMX-SWD-704
- 3 NZM interface for
Smart-Wire-Darwin
- 4 SWD ribbon cable
- 5 SWD device plug

Short description

The NZM interface module implements the data connection between circuit-breakers NZM2/3/4 with electronic release and SmartWire-Darwin. It transmits the following digital status data:

- On-Off-Tripped
- Load warnings
- Reason for last trip
- Actual currents, the switch type and the current settings of the rotary coding switches.

The switch can also be operated with a remote operator.

Note:



For further details see section "NZM circuit-breakers".

Ordering



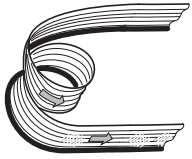
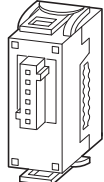

Description	Part no. Article no.	Price See price list	Std. pack	Notes
NZM interface to SmartWire-Darwin  <p>The module implements the data connection between the NZM2/3/4 with electronic release and the SmartWire-Darwin. The following data is transmitted:</p> <ul style="list-style-type: none"> • Digital status data (ON/OFF/TRIPPED) • Load warnings • Reason for last trip • The actual currents • The switch type • The current settings of the rotary coding switches <p>The switch can also be operated with a remote operator.</p> <ul style="list-style-type: none"> • Two digital inputs for the switch status • Two transistor outputs for remote operation • Retentive memory for energy data (kWh) <p>Energy data is transmitted through digital input (S₀) from an external energy measuring module NZN...-XMC-S0.</p>	NZM-XSWD-704 135530		1 off	A connection cable to the circuit-breaker is included as standard.

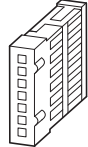
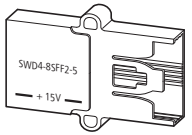
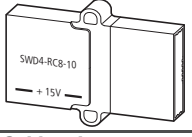
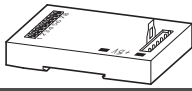
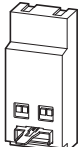

HPL01017EN

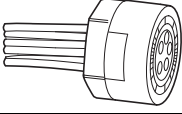
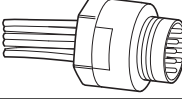
Description	Part no. Article no.	Price See price list	Std. pack	Information relevant for export to North America
Ribbon cable, 8 pole				
For laying the SmartWire-Darwin network inside the control panel.				
	Length: 100 m	SWD4-100LF8-24 116026	1 off 	NA Certification Request filed for UL and CSA UL/CSA approval applied for
	Length: 3 m Prefabricated with 2 blade terminals SWD4-8MF2.	SWD4-3LF8-24-2S 116027	1 off 	
	Length: 5 m Prefabricated with 2 blade terminals SWD4-8MF2.	SWD4-5LF8-24-2S 116028	1 off 	
	Length: 10 m Prefabricated with 2 blade terminals SWD4-8MF2.	SWD4-10LF8-24-2S 116029	1 off 	
Device plug				
Device plug for connecting SmartWire-Darwin slaves				
	SWD4-8SF2-5 116022		10 off 	NA Certification Request filed for UL and CSA UL/CSA approval applied for
Link				
Bridging open mounting locations for device plugs				
	Link for device plug SWD4-8SF2-5	SWD4-SEL8-10 116021	5 off 	NA Certification Request filed for UL and CSA UL/CSA approval applied for
Blade terminal				
	8 pole blade terminal for connection to gateway, power feeder module, coupling, network termination	SWD4-8MF2 116023	10 off 	NA Certification Request filed for UL and CSA UL/CSA approval applied for
Coupler				
	Coupling for 8 pole blade terminal	SWD4-8SFF2-5 116024	1 off 	NA Certification Request filed for UL and CSA UL/CSA approval applied for
Network terminator				
	Network terminator for 8 pole ribbon cable	SWD4-RC8-10 116020	1 off 	NA Certification Request filed for UL and CSA UL/CSA approval applied for
Cable adapter				
	Cable adapter for flat cable (plug) to round cable (terminal)	SWD4-8FRF-10 121377	1 off 	NA Certification Request filed for UL and CSA UL/CSA approval applied for
Switch cabinet bushing				
Transition from SWD ribbon cable to round cable, can be plugged-in on both sides. Additional control voltage feeder for the motor starters and contactors. Suitable for wall thickness up to 4 mm. Protection type IP67, drill hole 18.5 mm. Connection of ribbon cable with blade terminal SWD4-8MF2 8 pole				
	Connection round cable via socket.	SWD4-SFL8-20 121380	1 off 	NA Certification Request filed for UL and CSA UL/CSA approval applied for
	Connection round cable via plug.	SWD4-SML8-20 121381	1 off 	

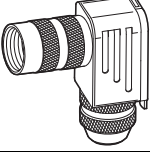
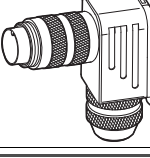

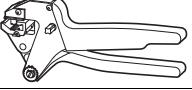
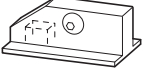
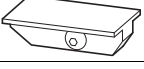
Description	Part no. Article no.	Price See price list	Std. pack	Information relevant for export to North America
Round cable, 8 pole				
For laying the SmartWire-Darwin network outside of the control panel.				
 Length: 50 m, HK-SO-Li2YY, 8 mm diameter	SWD4-50LR8-24 116030		1 off 	NA Certification Request filed for UL and CSA UL/CSA approval applied for
Housing bushing socket				
Enclosure bushing for installation in surface mounting enclosure M22-I... 8 pole socket/plug, IP67, for connection to SWD4-S(M,F)-67... 8 prefabricated cables for connection to PCB M22-SWD-I...				
 8 pole socket, M20	SWD4-SF8-20 116031		1 off 	NA Certification Request filed for UL and CSA UL/CSA approval applied for
 8 pole plug, M20	SWD4-SM8-20 116032		1 off 	
Connectors for SWD round cables				
 8 pole socket, straight	SWD4-SF8-67 116033		1 off 	NA Certification Request filed for UL and CSA UL/CSA approval applied for
 8 pole plug, straight	SWD4-SM8-67 116034		1 off 	
 8 pole socket, 90° angled	SWD4-SF8-67W 116035		1 off 	
 8 pole plug, 90° angled	SWD4-SM8-67W 116036		1 off 	
Tools for plugs				
 Pliers for device plugs	SWD4-CRP-1 116025		1 off 	UL/CSA certification not required
 Pliers for blade terminal	SWD4-CRP-2 116699		1 off 	
 Insert for toggle lever press of device plugs	SWD4-CRPAD-1 116700		1 off 	
 Insert for toggle lever press of blade terminal	SWD4-CRPAD-2 116701		1 off 	



HPL01019EN

Engineering

Part no.	Article no.	Current consumption mA	Notes
M22-SWD-K11	115964	7	-
M22-SWD-K22	115965	7	-
M22-SWD-LED-W	115966	19	-
M22-SWD-LED-B	115967	19	-
M22-SWD-LED-G	115968	19	-
M22-SWD-LED-R	115969	19	-
M22-SWD-K11LED-W	115972	19	-
M22-SWD-K11LED-B	115973	19	-
M22-SWD-K11LED-G	115974	19	-
M22-SWD-K11LED-R	115975	19	-
M22-SWD-K22LED-W	115978	19	-
M22-SWD-K22LED-B	115979	19	-
M22-SWD-K22LED-G	115980	19	-
M22-SWD-K22LED-R	115981	19	-
M22-SWD-KC11	115995	7	-
M22-SWD-KC22	115996	7	-
M22-SWD-LEDC-W	115997	19	-
M22-SWD-LEDC-B	115998	19	-
M22-SWD-LEDC-G	115999	19	-
M22-SWD-LEDC-R	116000	19	-
M22-SWD-K11LEDC-W	116003	19	-
M22-SWD-K11LEDC-B	116004	19	-
M22-SWD-K11LEDC-G	116005	19	-
M22-SWD-K11LEDC-R	116006	19	-
M22-SWD-K22LEDC-W	116009	19	-
M22-SWD-K22LEDC-B	116010	19	-
M22-SWD-K22LEDC-G	116011	19	-
M22-SWD-K22LEDC-R	116012	19	-
DIL-SWD-32-001	118560	40	-
DIL-SWD-32-002	118561	40	-
PKE-SWD-32	126895	58	-
EU5E-SWD-8DX	116381	12	-
EU5E-SWD-4D4D	116382	45	-
EU5E-SWD-4D2R	116383	45	-
NZM-XSWD-704	135530	35	-
M22-SWD-I1-LP01	115990	17	With terminating resistor switched on
M22-SWD-I2-LP01	115991	17	
M22-SWD-I3-LP01	115992	17	
M22-SWD-I4-LP01	115993	17	
M22-SWD-I6-LP01	115994	17	
SWD4-RC8-10	116020	17	

Power consumption/current consumption 24 V SWD control voltage U _{AUX}		DIL-SWD-32-...	PKE-SWD-32
Pick-up power			
for DILM(C) 7-9, DILA	W	3	3
for DILM(C) 12-15, DILMP20	W	4.5	4.5
for DILM(C) 17-38, DILMP32-45	W	12	12
Pick-up current			
for DILM(C) 7-9, DILA	mA	125	125
for DILM(C) 12-15, DILMP20	mA	188	188
for DILM(C) 17-38, DILMP32-45	mA	500	500
Sealing power			
for DILM(C) 7-9, DILA	W	3	3
for DILM(C) 12-15, DILMP20	W	4.5	4.5
for DILM(C) 17-38, DILMP32-45	W	0.5	0.5
Sealing current			
for DILM(C) 7-9, DILA	mA	125	125
for DILM(C) 12-15, DILMP20	mA	188	188
for DILM(C) 17-38, DILMP32-45	mA	21	21



Technical data

			EU5C-SWD-DP	EU5C-SWD-CAN	EU5C-SWD-PF1-1	EU5C-SWD-PF2-1
General						
Standards			IEC/EN 61131-2 EN 50178			
Dimensions (W x H x D)		mm	35 x 90 x 127		35 x 90 x 124	
Weight		kg	0.16	0.16	0.11	0.17
Weight		g	–	–	–	–
Mounting			Top-hat rail IEC/EN 60715, 35 mm			
Mounting position			Vertical			
Ambient mechanical conditions						
Protection type (IEC/EN 60529, EN50178, VBG 4)			IP20	IP20	IP20	IP20
Vibrations (IEC/EN 61131-2:2008)						
Constant amplitude 3.5 mm		Hz	5 ... 8.4	5 ... 8.4	5 ... 8.4	5 ... 8.4
Constant acceleration, 1 g		Hz	8.4 ... 150	8.4 ... 150	8.4 ... 150	8.4 ... 150
Mechanical shock resistance (IEC/EN 60068-2-27) semi-sinusoidal 15 g/11 ms			Shocks	9	9	9
Drop to IEC/EN 60068-2-31	Drop height	mm	50	50	50	50
Free fall, packaged (IEC/EN 60068-2-32)		m	0.3	0.3	0.3	0.3
Electromagnetic compatibility (EMC)						
Overvoltage category			II	II	II	II
Pollution degree			2	2	2	2
Electrostatic discharge (IEC/EN 61131-2:2008)						
Air discharge (Level 3)		kV	8	8	8	8
Contact discharge (Level 2)		kV	4	4	4	4
Electromagnetic fields (IEC/EN 61131-2:2008)						
80-1000 MHz		V/m	10	10	10	10
1.4 - 2 GHz		V/m	3	3	3	3
2 - 2.7 GHz		V/m	1	1	1	1
Radio interference suppression (SmartWire-Darwin)			EN 55011 Class A			
Burst (IEC/EN 61131-2:2008, Level 3)						
Supply cables		kV	2	2	2	2
CAN/DP bus cable		kV	1	1	–	–
SmartWire-Darwin cables		kV	1	1	1	1
Surge (IEC/EN 61131-2:2008, Level 1)						
Supply cables/CAN/DP bus cable			Supply cables 0.5 kV, CAN/DP bus cable 1 kV 10			
Radiated RFI (IEC/EN 61131-2:2008, Level 3)		V	10	10	10	10
Ambient climatic conditions						
Operating ambient temperature (IEC 60068-2)		°C	-25 ... +55	-25 ... +55	-25 ... +55	-25 ... +55
Condensation			Prevent with suitable measures			
Storage		°C	-40 - 70	-40 - 70	-40 - 70	-40 - 70
Relative humidity, non-condensing (IEC/EN 60068-2-30)		%	5 ... 95	5 ... 95	5 ... 95	5 ... 95
Supply voltage U_{Aux}						
Rated operating voltage		V	24 DC -15% +20%			
Input voltage residual ripple		%	≤ 5	≤ 5	≤ 5	≤ 5
Protection against polarity reversal			Yes	Yes	Yes	Yes
Max. current	I _{max}	A	3	3	3	3
Short-circuit rating			If contactors with a total power consumption > 3 A are connected, a power feeder module EU5C-SWD-PF1/2 has to be used.			
Heat dissipation			no, external fuse FAZ Z3			
Heat dissipation		W	Normally 1	Normally 1	Normally 1	Normally 1
Potential isolation			No	No	No	No
Rated operating voltage of 24 V DC stations		V	Normally U _{Aux} - 0.2	Normally U _{Aux} - 0.2	Normally U _{Aux} - 0.2	Normally U _{Aux} - 0.2



			EU5C-SWD-DP	EU5C-SWD-CAN	EU5C-SWD-PF1-1	EU5C-SWD-PF2-1
Supply voltage U_{Pow}						
Supply voltage		V	24 DC -15 % + 20 %	24 DC -15 % + 20 %	–	24 DC -15 % + 20 %
Input voltage residual ripple		%	≤ 5	≤ 5	–	≤ 5
Protection against polarity reversal			Yes	Yes	–	Yes
Rated operational current	I	A	0.7	0.7	–	0.7
Overload proof			Yes	Yes	–	Yes
Inrush current and length		A	12.5 A/6 ms	12.5 A/6 ms	–	12.5 A/6 ms
Heat dissipation at 24 V DC		W	3.8	3.8	–	3.8
Potential isolation between U _{Pow} and 15 V SmartWire-Darwin supply voltage			No	No	–	Yes
Bridging voltage dips		ms	10	10	–	10
Repeat rate		s	1	1	–	1
Status indicator		LED	Yes	Yes	–	Yes
Provision of SmartWire-Darwin supply voltage						
Rated operational voltage	U _e	V	14.5 ± 3 %	14.5 ± 3 %	–	14.5 ± 3 %
Max. current	I _{max}	A	0.7	0.7	–	0.7
			If SWD modules with a total power consumption > 0.7 A are connected, a power feeder module EU5C-SWD-PF2 has to be used.			
Short-circuit rating			Yes	Yes	–	Yes
Connection supply voltages						
Terminal type			Push-in terminals			
Solid		mm ²	0.2 - 1.5 (AWG 24 - 16)			
Flexible with ferrule		mm ²	0.25 - 1.5	0.25 - 1.5	0.25 - 1.5	0.25 - 1.5
SmartWire-Darwin network						
Station type			SmartWire-Darwin master		–	–
Number of SmartWire-Darwin slaves			58	99	–	–
Baud rate		kBd	125	125	–	–
Address setting			Automatic	Automatic	–	–
Status indicator		LED	SmartWire-Darwin master LED: green Configuration LED: red		–	–
Connections			Plug, 8 pole		2 x plug, 8 pole	
Plug connectors			Blade terminal SWD4-8MF2		2 blade terminals SWD4-8MF2	
Fieldbus interface						
Function			PROFIBUS-DP slave	CANopen slave	–	–
Bus protocol			PROFIBUS-DP	CANopen	–	–
Baud rate			Up to 12 MB	Up to 1 MB	–	–
Baud rate detection			Automatic	Automatic	–	–
Station address			2 ... 125	2 ... 32	–	–
Address setting			DIP switches	DIP switches	–	–
Status indication of fieldbus interface		LED	Two-colored red/ green	Two-colored red/ green	–	–
Terminal resistor			Switchable via plug	DIP switches	–	–
Terminal type fieldbus			1 x SUB-D, 9 pole, socket	1 x SUB-D plug, 9 pole	–	–
Potential isolation			Yes	Yes	–	–



			EU5E-SWD-8DX	EU5E-SWD-4D4D	EU5E-SWD-4D2R
General					
Standards			IEC/EN 61131-2 EN 50178		
Dimensions (W x H x D)		mm	35 x 90 x 101		
Weight		kg	0.1	0.1	0.11
Mounting			Top-hat rail IEC/EN 60715, 35 mm		
Mounting position			Vertical		
Ambient mechanical conditions					
Protection type (IEC/EN 60529, EN50178, VBG 4)			IP20	IP20	IP20
Vibrations (IEC/EN 61131-2:2008)					
Constant amplitude 3.5 mm		Hz	5 ... 8.4	5 ... 8.4	5 ... 8.4
Constant acceleration, 1 g		Hz	8.4 ... 150	8.4 ... 150	8.4 ... 150
Mechanical shock resistance (IEC/EN 60068-2-27) semi-sinusoidal 15 g/11 ms					
Drop to IEC/EN 60068-2-31	Drop height	mm	50	50	50
Free fall, packaged (IEC/EN 60068-2-32)		m	0.3	0.3	0.3
Electromagnetic compatibility (EMC)					
Overvoltage category			II	II	II
Pollution degree			2	2	2
Electrostatic discharge (IEC/EN 61131-2:2008)					
Air discharge (Level 3)		kV	8	8	8
Contact discharge (Level 2)		kV	4	4	4
Electromagnetic fields (IEC/EN 61131-2:2008)					
80-1000 MHz		V/m	10	10	10
1.4 - 2 GHz		V/m	3	3	3
2 - 2.7 GHz		V/m	1	1	1
Radio interference suppression (SmartWire-Darwin)					
Burst (IEC/EN 61131-2:2008, Level 3)			EN 55011 Class A		
Supply cables		kV	2	2	2
Signal cables		kV	1	1	1
SmartWire-Darwin cables		kV	1	1	1
Surge (IEC/EN 61131-2:2008, Level 1)			–	Supply cables 0.5 kV	–
Radiated RFI (IEC/EN 61131-2:2008, Level 3)		V	10	10	10
Ambient climatic conditions					
Operating ambient temperature (IEC 60068-2)		°C	-25 ... +55	-25 ... +55	-25 ... +55
Condensation			Prevent with suitable measures		
Storage		°C	-40 - 70	-40 - 70	-40 - 70
Relative humidity, non-condensing (IEC/EN 60068-2-30)		%	5 ... 95	5 ... 95	5 ... 95
SmartWire-Darwin network					
Station type			SmartWire-Darwin station (slave)		
Baud rate detection			Automatic		
SmartWire-Darwin status		LED	Green		
Connection			Plug, 8 pole Connection plug: Device plug SWD4-8SF2-5		
Current consumption (15 V SWD supply)			→ Page 19		
Connection supply and I/O					
Terminal type			Push-in terminals		
Solid		mm ²	0.2 - 1.5 (AWG 24 - 16)		
Flexible with ferrule		mm ²	0.25 - 1.5	0.25 - 1.5	0.25 - 1.5
Minimum length 8 mm					
24 V DC supply for output supply					
Rated operational voltage	U _e	V	–	24 DC -15 % / +20 %	–
Input voltage residual ripple		%	–	≤ 5	–
Protection against polarity reversal			–	Yes	–



	EU5E-SWD-8DX	EU5E-SWD-4D4D	EU5E-SWD-4D2R
Digital inputs			
Number	8	4	4
Input current	mA Normally 4 at 24 V DC		
Voltage level to IEC/EN 61131-2			
Limit value type 1	Low < 5 V DC; High > 15 V DC		
Input delay	High → Low typ. < 0.2 ms Low → High typ. < 0.2 ms		
SmartWire-Darwin status	LED Yellow		
Digital semiconductor outputs			
Number	–	4	–
Output current	–	Normally 0.5 at 24 V DC	–
Short-circuit tripping current	–	Max. 1.2 over 3 ms	–
Lamp load	R _{LL} W	≤ 3	–
Overload proof	–	Yes, with diagnostics	–
Switching capacity	–	EN 60947-5-1 utilization category DC-13	–
Relay outputs			
Number	–	–	2
Contact type	–	–	Normally open contact
Operations			
Utilization category AC-1, 250 V, 6 A	–	–	> 6 x 10 ⁴
Utilization category AC-15, 250 V, 3 A	–	–	> 5 x 10 ⁴
Utilization category DC-13, 24 V, 1 A	–	–	> 2 x 10 ⁵
Safe isolation according to EN 50178	V AC	–	230
Minimum load current	mA	–	100 mA, 12 V DC
Response/reset time	ms	–	5/2.5
Bounce duration	ms	–	Normally 1.5
Short-circuit protection	–	–	External 4 A gL/gG
Status display outputs	LED	Yellow	Yellow
Potential isolation			
Inputs from SmartWire-Darwin	Yes	Yes	Yes
Semi-conductor outputs from SmartWire-Darwin	–	Yes	–
Semi-conductor outputs from inputs	–	No	–
Relays from SmartWire-Darwin	–	–	Yes
Relays from inputs	–	–	Yes
Relays from relays	–	–	Yes



			M22-SWD-K11	M22-SWD-KC11	M22-SWD-LED-...
General					
Standards			IEC/EN 61131-2 EN 50178	IEC/EN 61131-2 EN 50178	IEC/EN 61131-2 EN 50178
Dimensions (W x H x D)		mm	12 x 42 x 39	12 x 45 x 37	10 x 42 x 45
Weight		g	10	10	10
Mounting position			Any	Any	Any
Ambient mechanical conditions					
Protection type (IEC/EN 60529, EN50178, VBG 4)			IP20	IP20	IP20
Vibrations (IEC/EN 61131-2:2008)					
Constant amplitude 3.5 mm		Hz	5 ... 8.4	5 ... 8.4	5 ... 8.4
Constant acceleration, 1 g		Hz	8.4 ... 150	8.4 ... 150	8.4 ... 150
Mechanical shock resistance (IEC/EN 60068-2-27) semi-sinusoidal 15 g/11 ms					
Drop to IEC/EN 60068-2-31	Drop height	mm	50	50	50
Free fall, packaged (IEC/EN 60068-2-32)		m	0.3	0.3	0.3
Electromagnetic compatibility (EMC)					
Overvoltage category			Not applicable	Not applicable	Not applicable
Pollution degree			2	2	2
Electrostatic discharge (IEC/EN 61131-2:2008)					
Air discharge (Level 3)		kV	8	8	8
Contact discharge (Level 2)		kV	4	4	4
Electromagnetic fields (IEC/EN 61131-2:2008)					
80-1000 MHz		V/m	10	10	10
1.4 - 2 GHz		V/m	3	3	3
2 - 2.7 GHz		V/m	1	1	1
Radio interference suppression (SmartWire-Darwin)					
Burst (IEC/EN 61131-2:2008, Level 3)			EN 55011 Class A	EN 55011 Class A	EN 55011 Class A
Supply cables		kV	2	2	2
SmartWire-Darwin cables		kV	1	1	1
Radiated RFI (IEC/EN 61131-2:2008, Level 3)		V	10	10	10
Ambient climatic conditions					
Operating ambient temperature (IEC 60068-2)		°C	-30 ... +55	-30 ... +55	-30 ... +55
Condensation			Prevent with suitable measures		
Storage		°C	-40 - 80	-40 - 80	-40 - 80
Relative humidity, non-condensing (IEC/EN 60068-2-30)		%	9 ... 95	9 ... 95	9 ... 95
SmartWire-Darwin network					
Station type			SmartWire-Darwin station (slave)		
Number			-	-	-
Baud rate setting			Automatic	Automatic	Automatic
SmartWire-Darwin status	LED		Green	Green	Green
Connections			Plug, 8 pole	Plug, 8 pole	Plug, 8 pole
Plug connectors			SWD4-8SF2-5	M22-SWD-I...LP	SWD4-8SF2-5
Number of insertion cycles			≥ 50	≥ 50	≥ 50
Current consumption (15 V SWD supply)			→ Page 19		
Function element					
Contacts			1 changeover contact	1 changeover contact	-
Lifespan mechanical/electrical	Switch operations		1 x 10 ⁶	1 x 10 ⁶	-
LED display		LED	No	No	Yes
Diagnostics			Yes	Yes	No
Fixing			Front fixing	Base fixing	Front fixing



M22-SWD-LEDC-...	M22-SWD-K11-LED...	M22-SWD-K11LEDC-...	M22-SWD-K22	M22-SWD-KC22	M22-SWD-K22-LED...	M22-SWD-K22LEDC-...
IEC/EN 61131-2 EN 50178	IEC/EN 61131-2 EN 50178	IEC/EN 61131-2 EN 50178	IEC/EN 61131-2 EN 50178	IEC/EN 61131-2 EN 50178	IEC/EN 61131-2 EN 50178	IEC/EN 61131-2 EN 50178
10 x 45 x 42	12 x 42 x 45	12 x 45 x 42	17 x 42 x 39	17 x 45 x 37	17 x 42 x 45	17 x 45 x 42
10	10	10	14	14	14	14
Any	Any	Any	Any	Any	Any	Any
IP20	IP20	IP20	IP20	IP20	IP20	IP20
5 ... 8.4	5 ... 8.4	5 ... 8.4	5 ... 8.4	5 ... 8.4	5 ... 8.4	5 ... 8.4
8.4 ... 150	8.4 ... 150	8.4 ... 150	8.4 ... 150	8.4 ... 150	8.4 ... 150	8.4 ... 150
9	9	9	9	9	9	9
50	50	50	50	50	50	50
0.3	0.3	0.3	0.3	0.3	0.3	0.3
Not applicable	Not applicable	Not applicable	Not applicable	Not applicable	Not applicable	Not applicable
2	2	2	2	2	2	2
8	8	8	8	8	8	8
4	4	4	4	4	4	4
10	10	10	10	10	10	10
3	3	3	3	3	3	3
1	1	1	1	1	1	1
EN 55011 Class A	EN 55011 Class A	EN 55011 Class A	EN 55011 Class A	EN 55011 Class A	EN 55011 Class A	EN 55011 Class A
2	2	2	2	2	2	2
1	1	1	1	1	1	1
10	10	10	10	10	10	10
-30 ... +55	-30 ... +55	-30 ... +55	-30 ... +55	-30 ... +55	-30 ... +55	-30 ... +55
Prevent with suitable measures						
-40 - 80	-40 - 80	-40 - 80	-40 - 80	-40 - 80	-40 - 80	-40 - 80
9 ... 95	9 ... 95	9 ... 95	5 ... 95	5 ... 95	5 ... 95	5 ... 95
SmartWire-Darwin station (slave)						
-	-	-	-	-	-	-
Automatic	Automatic	Automatic	Automatic	Automatic	Automatic	Automatic
Green	Green	Green	Green	Green	Green	Green
Plug, 8 pole	Plug, 8 pole	Plug, 8 pole	Plug, 8 pole	Plug, 8 pole	Plug, 8 pole	Plug, 8 pole
M22-SWD-I...LP	SWD4-8SF2-5	M22-SWD-I...LP	SWD4-8SF2-5	M22-SWD-I...LP	SWD4-8SF2-5	M22-SWD-I...LP
≥ 50	≥ 50	≥ 50	≥ 50	≥ 50	≥ 50	≥ 50
→ Page 19						
-	1 changeover contact	1 changeover contact	2 changeover contacts	2 changeover contacts	2 changeover contacts	2 changeover contacts
-	1 x 10 ⁶	1 x 10 ⁶	1 x 10 ⁶	1 x 10 ⁶	1 x 10 ⁶	1 x 10 ⁶
Yes	Yes	Yes	No	No	Yes	Yes
No	Yes	Yes	Yes	Yes	Yes	Yes
Base fixing	Front fixing	Base fixing	Front fixing	Base fixing	Front fixing	Base fixing



			DIL-SWD-32-001	DIL-SWD-32-002	PKE-SWD-32	NZM-XSWD-704
General						
Standards			IEC/EN 61131-2 EN 50178 IEC/EN 60947			
Dimensions (W x H x D)		mm	45 x 38 x 76	45 x 38 x 76	45 x 38 x 76	35 x 90 x 101
Weight		kg	0.04	0.04	0.04	0.1
Mounting			on DILM7 ... DILM38	on DILM7 ... DILM38	on DILM7 ... DILM32	Top-hat rail I EC/EN 60715, 35 mm
Mounting position			as DILM7 ... DILM38	as DILM7 ... DILM38	as DILM ... DILM32	Vertical
Ambient mechanical conditions						
Protection type (IEC/EN 60529, EN50178, VBG 4)			IP20	IP20	IP20	IP20
Vibrations (IEC/EN 61131-2:2008)						
Constant amplitude 3.5 mm		Hz	5 ... 8.4	5 ... 8.4	5 ... 8.4	5 ... 8.4
Constant acceleration, 1 g		Hz	8.4 ... 150	8.4 ... 150	8.4 ... 150	8.4 ... 150
Mechanical shock resistance (IEC/EN 60068-2-27) semi-sinusoidal 15 g/11 ms		Shocks	9	9	9	9
Drop to IEC/EN 60068-2-31	Drop height	mm	50	50	50	50
Free fall, packaged (IEC/EN 60068-2-32)		m	0.3	0.3	0.3	0.3
Electromagnetic compatibility (EMC)						
Overvoltage category			II	II	II	II
Pollution degree			2	2	2	2
Electrostatic discharge (IEC/EN 61131-2:2008)						
Air discharge (Level 3)		kV	8	8	8	8
Contact discharge (Level 2)		kV	4	4	4	4
Electromagnetic fields (IEC/EN 61131-2:2008)						
80 - 1000 MHz		V/m	10	10	10	10
1.4 - 2 GHz		V/m	3	3	3	3
2 - 2.7 GHz		V/m	1	1	1	1
Radio interference suppression (SmartWire-Darwin)			EN 55011 Class A	EN 55011 Class A	EN 55011 Class A	EN 55011 Class A
Burst (IEC/EN 61131-2:2008, Level 3)						
Supply cables		kV	–	–	–	2
CAN/DP bus cable		kV	1	1	1	1
SmartWire-Darwin cables		kV	1	1	1	1
Radiated RFI (IEC/EN 61131-2:2008, Level 3)		V	10	10	10	10
Ambient climatic conditions						
Operating ambient temperature (IEC 60068-2)		°C	-25 ... +60	-25 ... +60	-25 ... +60	-25 ... +55
Condensation			Prevent with suitable measures	Prevent with suitable measures	Prevent with suitable measures	Prevent with suitable measures
Storage		°C	-30 - 70	-30 - 70	-30 - 70	-40 - 70
Relative humidity, non-condensing (IEC/EN 60068-2-30)		%	5 ... 95	5 ... 95	5 ... 95	5 ... 95
SmartWire-Darwin network						
Station type			SmartWire-Darwin station (slave)	SmartWire-Darwin station (slave)	SmartWire-Darwin station (slave)	SmartWire-Darwin station (slave)
Address setting			Automatic	Automatic	Automatic	Automatic
Status SmartWire-Darwin		LED	Green/orange	Green/orange	Green/orange	Green
Connections			Plug, 8 pole	Plug, 8 pole	Plug, 8 pole	Plug, 8 pole
Plug connectors			Device plug SWD4-8SF2-5	Device plug SWD4-8SF2-5	Device plug SWD4-8SF2-5	Device plug SWD4-8SF2-5
Current consumption (15 V SWD supply)			→ Page 19			



			DIL-SWD-32-001	DIL-SWD-32-002	PKE-SWD-32	NZM-XSWD-704
Operation mode						
Manual/automatic mode			No	Yes	Yes	–
Setting			–	Rotary switch	Rotary switch	–
Connection auxiliary contact						
Number			2	2	–	–
Rated voltage	U_e	V DC	15	15	–	–
			Self-supplied	Self-supplied	–	–
Input current at 1 signal, typical		mA	3	3	–	–
Potential isolation			No	No	–	–
Cable length		m	≤ 2.8	≤ 2.8	–	–
Terminal type			Push-in terminals	Push-in terminals	–	Push-in terminals
Terminal capacity						
Solid		mm ²	0.2 - 1.5 (AWG 24 - 16)	0.2 - 1.5 (AWG 24 - 16)	0.2 - 1.5 (AWG 24 - 16)	0.2 - 1.5 (AWG 24 - 16)
Flexible with ferrule		mm ²	0.25 - 1.5	0.25 - 1.5	0.25 - 1.5	0.25 - 1.5
			Minimum length 8 mm	Minimum length 8 mm	Minimum length 8 mm	Minimum length 8 mm



Part no.			SWD4-RC8-10	SWD4-8SF2-5	SWD4-8SFF2-5
General					
Standards			IEC/EN 61131-2 EN 50178	IEC/EN 61131-2 EN 50178	IEC/EN 61131-2 EN 50178
Dimensions (W x H x D)		mm	48.5 x 34.5 x 10	15 x 36.5 x 17.5	48.5 x 34.5 x 10
Weight		kg	–	–	–
Weight		g	10	5.5	4.5
Mounting position			Any	Any	Any
Ambient mechanical conditions					
Protection type (IEC/EN 60529, EN50178, VBG 4)			IP20	IP20	IP20
Vibrations (IEC/EN 61131-2:2008)					
Constant amplitude 3.5 mm		Hz	5 ... 8.4	5 ... 8.4	5 ... 8.4
Constant acceleration, 1 g		Hz	8.4 ... 150	8.4 ... 150	8.4 ... 150
Mechanical shock resistance (IEC/EN 60068-2-27) semi-sinusoidal 15 g/11 ms					
Drop to IEC/EN 60068-2-31	Drop height	mm	50	–	–
Free fall, packaged (IEC/EN 60068-2-32)		m	0.3	–	–
Electromagnetic compatibility (EMC)					
Overvoltage category			II	–	–
Pollution degree			2	–	–
Electrostatic discharge (IEC/EN 61131-2:2008)					
Air discharge (Level 3)		kV	8	–	8
Contact discharge (Level 2)		kV	4	–	4
Electromagnetic fields (IEC/EN 61131-2:2008)					
80-1000 MHz		V/m	10	–	–
1.4 - 2 GHz		V/m	3	–	–
2 - 2.7 GHz		V/m	1	–	–
Radio interference suppression (SmartWire-Darwin)					
Burst (IEC/EN 61131-2:2008, Level 3)			EN 55011 Class A	–	–
SmartWire-Darwin cables		kV	1	–	–
Radiated RFI (IEC/EN 61131-2:2008, Level 3)		V	10	–	–
Ambient climatic conditions					
Operating ambient temperature (IEC 60068-2)		°C	-25 ... +55	-25 ... +55	-25 ... +55
Condensation			Prevent with suitable measures	Prevent with suitable measures	Prevent with suitable measures
Storage		°C	-40 - 70	-40 - 70	-40 - 70
Relative humidity, non-condensing (IEC/EN 60068-2-30)		%	5 ... 95	5 ... 95	5 ... 95
Connection options					
SWD-In			Plug, 8 pole	Plug connector	Plug, 8 pole
Number of insertion cycles			≥ 200	≥ 1	≥ 200
SWD-Out			–	Socket, 8 pole	Plug, 8 pole
Number of insertion cycles			–	≥ 200	≥ 200
Current consumption (15 V SWD supply)			→ Page 19		



SWD4-SF8-20	SWD4-SM8-20	SWD4-8FRF-10	SWD4-SFL8-20	SWD4-SML8-20
IEC/EN 61131-2 EN 50178	IEC/EN 61131-2 EN 50178	IEC/EN 61131-2 EN 50178	IEC/EN 61131-2 EN 50178	IEC/EN 61131-2 EN 50178
24 x 26 x 162	24 x 26 x 170	35 x 90 x 35	35 x 83 x 40	35 x 83 x 46
–	–	–	–	–
20	22.5	42	50	50
Any	Any	Any	Any	Any
IP67	IP67	IP20	IP67	IP67
–	–	5 ... 8.4	5 ... 8.4	5 ... 8.4
–	–	8.4 ... 150	8.4 ... 150	8.4 ... 150
–	–	9	9	9
–	–	–	–	–
–	–	–	–	–
–	–	–	–	–
–	–	8	8	8
–	–	4	4	4
–	–	–	10	10
–	–	–	3	3
–	–	–	1	1
–	–	–	–	–
–	–	–	–	–
–	–	–	10	10
–25 ... +55	–25 ... +55	–25 ... +55	–25 ... +55	–25 ... +55
Prevent with suitable measures	Prevent with suitable measures	Prevent with suitable measures	Prevent with suitable measures	Prevent with suitable measures
–40 - 70	–40 - 70	–40 - 70	–40 - 70	–40 - 70
5 ... 95	5 ... 95	5 ... 95	5 ... 95	5 ... 95
–	Plug, 8 pole	Plug, 8 pole	Plug, 8 pole	Plug, 8 pole
–	≥ 500	≥ 200	≥ 200	≥ 500
Socket, 8 pole	–	Push-in terminals	Socket, 8 pole	Plug, 8 pole
≥ 500	–	–	≥ 500	≥ 200



Dimensions

SWD gateways, input/output module, power feed modules

EU5C-SWD-DP

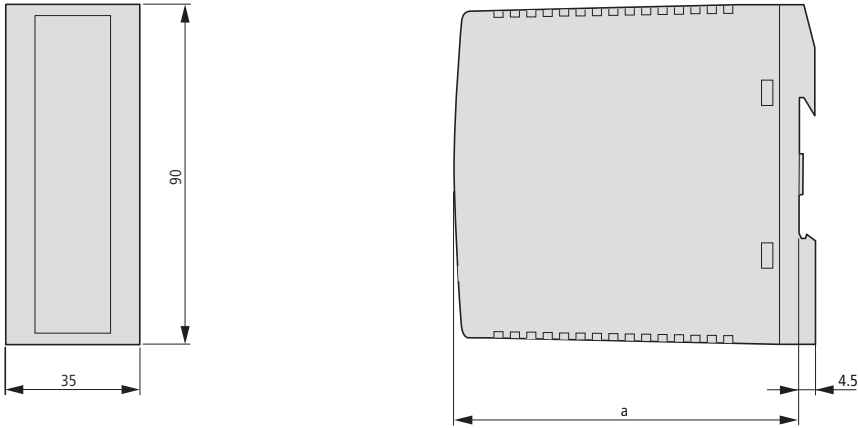

	a
EU5C-SWD-DP	122
EU5C-SWD-CAN	122
EU5E-SWD-...	97
EU5C-SWD-PF...	120

SWD contactor modules

DIL-SWD-32-001

DIL-SWD-32-002

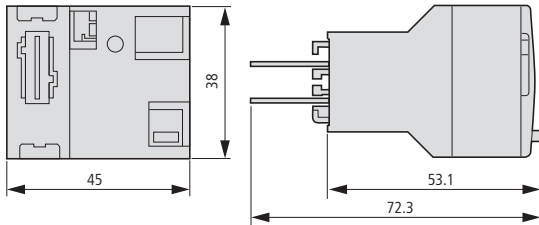

SWD PKE module

PKE-SWD-32

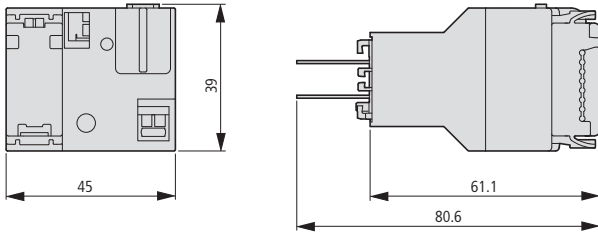

Fixing adapter (front fixing) for 3-contact/LED elements

M22-A-...

M22-SWD-A4

Function elements

M22-SWD-K...

M22-SWD-LED...

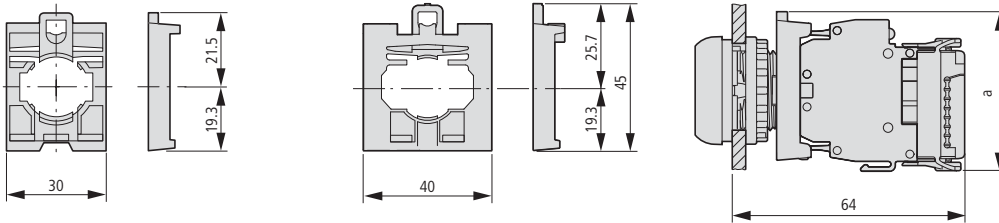

	a
M22-A	44
M22-SWD-A4	48

SWD soft starter DS7

DS7-34DSX

Dimension → Chapter "Soft starter"

SWD interface for NZM circuit-breakers

Dimensions → Chapter "NZM Circuit-breakers"



Device plug

SWD4-8SF2-5

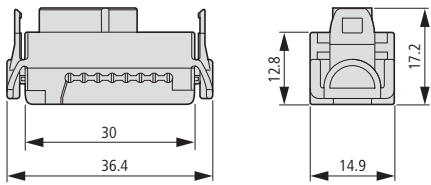

Network terminator

SWD4-RC8-10

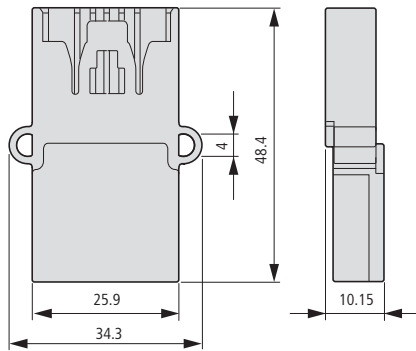

Coupler

SWD4-8SFF2-5

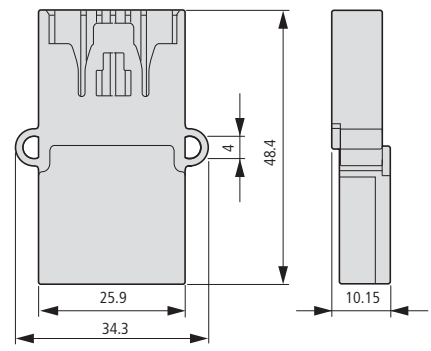

Housing bushing plug

SWD4-SM8-20

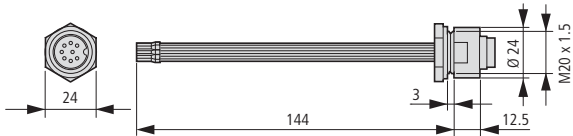

Housing bushing socket

SWD4-SF8-20

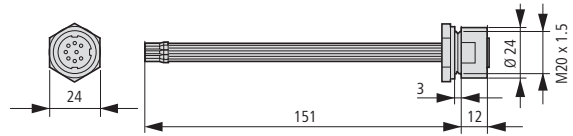

Switch cabinet bushing plug

SWD4-SM8-20

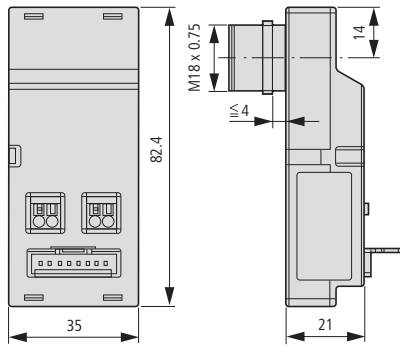

Switch cabinet bushing socket

SWD4-SFL8-20

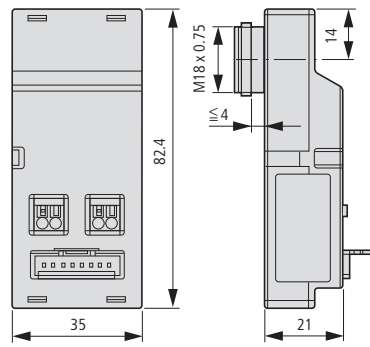

Adapter for blade terminal to round cable

SWD4-8FRF-10

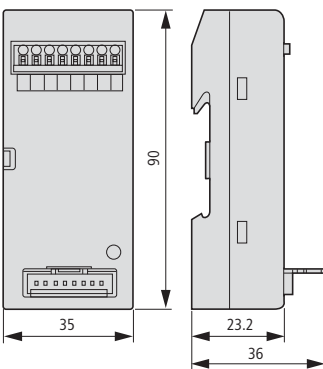

Plug connector for SWD round cables, straight

SWD4-SF8-67

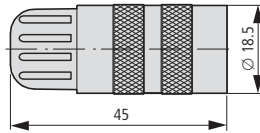

SWD4-SM8-67

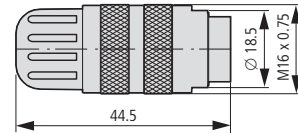

Plug connector for SWD round cables, angled

SWD4-SF8-67W

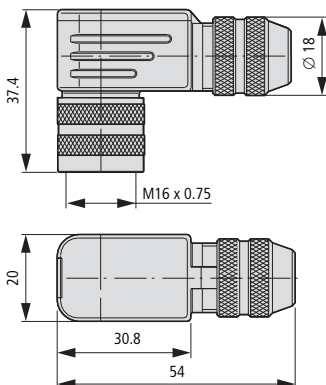

SWD4-SM8-67W

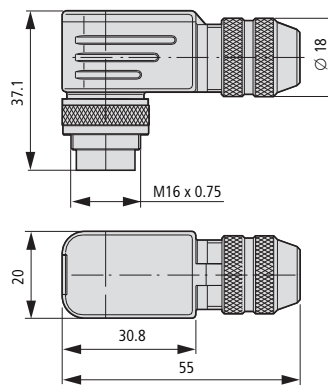



RMQ pilot devices

FAK palm switches

SL signal towers



The Eaton range of pilot devices combine state-of-the-art design with optimum functionality. Indicator lights and signal towers with LED technology ensure reliable indication of machine states.



The RMQ Titan product range offers contact elements which can be connected to the SmartWire-Darwin communication system.



Pilot devices with 22.5 mm hole diameter - RMQ-Titan

Modern, ergonomically molded design +++ 100,000 hours LED-illumination +++ Customized laser inscription +++ ATEX-versions possible

Pilot devices with 16 mm hole diameter - RMQ16

Extremely compact +++ Installation in smallest space +++ Customized laser inscription

Emergency stop pushbuttons/ Emergency switching off pushbuttons

Mushroom form +++ Palm form 45 mm, 60 mm +++ With illuminated ring +++ Mechanical switch position indicator +++ Security standards up to SIL3 (EN 62061) or Performance Level e (ISO 13849-1)



FAK foot and palm switches

High protection type IP69 +++ Suitable for use in rough environments +++ Extremely robust

SL signal towers

Optical and acoustic machine state display +++ Flexibly combinable +++ Simple mounting