

INDUSTRIAL AND POWER PROTECTION

CATALOGUE



THE GLOBAL SPECIALIST
IN ELECTRICAL AND DIGITAL BUILDING INFRASTRUCTURES

Enclosures and equipment



P. 12
Atlantic-E
wall mounting
steel enclosures
IP 66 - IK 10

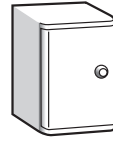

P. 16
Atlantic
wall mounting
304 L and 316 L
stainless enclosures
IP 66 - IK 10

Transcab® open slot panel trunking

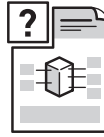

P. 48
Introduction
to Transcab

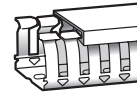

P. 50
Transcab
PVC panel trunking

Power protection

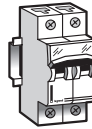

P. 56
DX³
MCBs

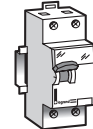

P. 61
DX³
RCDs

Isolation, control and signalling

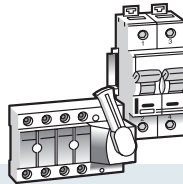

P. 84
Isolating and
changeover
switches

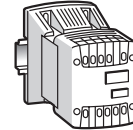

P. 90
Control and
compact
transformers

Viking 3 terminal blocks

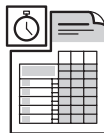

P. 118
Selection chart

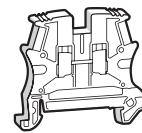

P. 120
Terminal blocks –
screw
connection

Cable marking systems and cable accessories

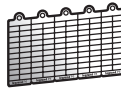

P. 140
Marking label
sheets



P. 140
CAB 3
marking system

Industrial plugs, sockets and combination units



P. 156
Hypra Prisinter
sockets
IP 44/55

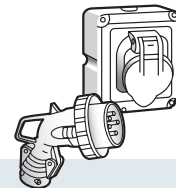

P. 162
Hypra
plugs and sockets
IP 44 and
IP 66/67-55

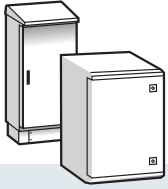

P. 18
Marina
wall mounting
and free standing
GRP enclosures
IP 66 - IK 10



P. 32
Plexo³
weatherproof
enclosures
and terminal
shield boxes

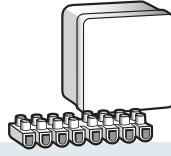

P. 36
Plexo
weatherproof
boxes and
Nybloc
terminal strips

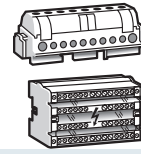

P. 42
Distribution
terminal blocks

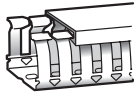

P. 50
Transcab
PC/ABS halogen free
panel trunking



P. 50
Transcab cutting
tool

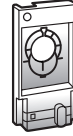

P. 50
Cable retainer,
marking and fixing
accessories and
braided sleeving



P. 51
Technical
information

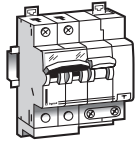

P. 63
DX³
RCB0s

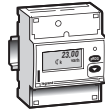

P. 68
EMDX³
metering

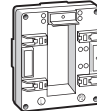

P. 70
Current
transformers

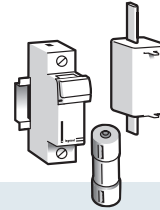

P. 74
Fuse carriers
and fuses

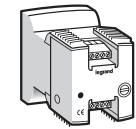

P. 96
Filtered power
supplies

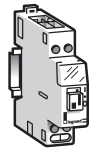

P. 98
CX³
power
contactors

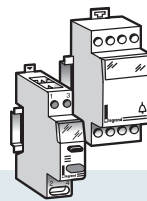

P. 101
Push buttons/
control switches,
indicators and
transformers

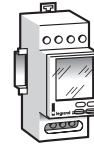

P. 104
Time switches,
light sensitive
and time-lag
switches

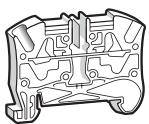

P. 124
Terminal blocks -
spring
connection

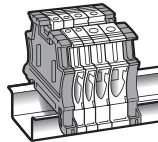

P. 126
Accessories for
terminal blocks

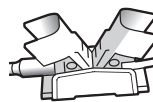

P. 133
Heavy duty
terminal blocks
for copper and
aluminium cables

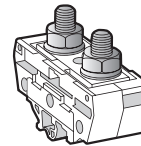

P. 134
Heavy duty
terminal blocks
for copper bars
and cable lugs



P. 142
CAB 3
marking system
accessories



P. 145
Colring
cable ties



P. 145
Colson
cable ties

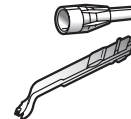

P. 148
Starfix
ferrules and
crimping tools

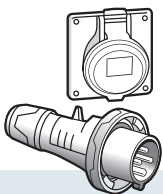

P. 178
P 17 Tempra Pro/
P 17 Tempra
plugs and sockets
IP 44 and
IP 66/67



P. 190
Hydra
combination units
IP 44 and
IP 66/67-55



P. 194
P 17 Tempra
combination units
IP 44, IP 55 and
IP 66

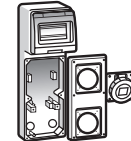

P. 195
P 17 Tempra
self assembly
combination units
IP 44, IP 66/67



Building strength

through innovation,
design and customer
focused values

Legrand is the global specialist in electrical and digital building infrastructures. Innovation is the driving force behind its development. With an increasing investment in research and development (circa 5% of sales) and more than 4,000 active patents, the Legrand Group is focused on maintaining a high rate of new product launches that present innovative solutions to the market.

CUSTOMER TRAINING AND SUPPORT

Legrand is committed to providing ongoing customer support and, with this in mind, has developed a wide variety of free CPD accredited seminars which are suited to anyone who is involved in the specification of electrical products and systems.

Visit [legrand.co.uk/training](https://www.legrand.co.uk/training) to find out more.



A RESPONSIBLE APPROACH TO THE ENVIRONMENT



The Legrand Group takes its environmental responsibility seriously. Designing and developing high environmental performance products means managing everything from the substances used through to 'eco-design' of products to ensure they have a minimum environmental impact throughout their lifecycle.

Product Environmental Profiles (PEP)



Legrand is committed to providing transparent, accurate information on the environmental impact of its products. Product Environmental Profiles (PEP), complying with standard ISO 14025, describe the environmental characteristics of products throughout their lifecycle.

PEPs are independently verified and certified by the PEP EcoPassport organisation.

www.pep-ecopassport.org



NEW

DX³ PROTECTION DEVICES AND ISOLATING SWITCHES

A new range of MCBs, RCDs, RCBOs and isolating switches with a uniform appearance and optimised dimensions.

see p. 54 to 65 and 82 to 84



NEW

CX³ POWER CONTACTORS

An updated design for Legrand's popular 2P, 3P and 4P power contactor range. N/O (normally open) and N/C (normally closed) versions available.

see p. 98 to 100



NEW

EMDX³ METERING DEVICES

A wide range of electricity meters and multi-function measuring units for door or DIN rail mounting, each supported by supervision software and a remote web-based monitoring system.

see p. 62 to 73



NEW

P17 TEMPRA PRO

LV 16 and 32 A industrial plugs and sockets with improved strength, safety and a wealth of design features with real user benefits.

see p. 176 to 187

alphabetical list

A

AlphaRex ³ time switches	106 to 108
Applicators for crimping tools (Starfix)	149
Atlantic-E steel enclosures	
crosspieces	26
equipment and fixing accessories	26
features information	12 to 13
insulated modular chassis	25
internal doors	25
locking accessories	14
plinths	14
roofs	14
sectioned uprights	26
selection chart	10 to 11
steel enclosures	14
technical information	15
universal plates	23
wall mounting brackets	14
Atlantic stainless steel enclosures	
crosspieces	26
equipment and fixing accessories	26
features information	8
insulated modular chassis	25
internal doors	25
locking accessories	28
sectioned uprights	26
selection chart	10 to 11
stainless steel enclosures – 304 L	16
stainless steel enclosures – 316 L	16
technical information	16 to 17
universal plates	23
wall mounting brackets	16

B

Bell transformers	102
Blade type cartridge fuses (HRC)	78 to 79
Boxes	
Plexo weatherproof boxes	36 to 41
Terminal shield boxes	35

C

CAB 3 cable marking system	
accessories	142
markers for cables	140 to 141
technical information	143
Cable marking systems (CAB 3)	140 to 143
Cable ties	
Colring	145
Colson	145
Cable trunking (Transcab)	48 to 51
Cartridge fuses and accessories	74 to 79
Changeover switches	87
Colring	
cable ties and tool	145
technical information	146
Colson	
cable ties and tool	145
technical information	147
Combination units	
Hypra	190 to 193
P17 Tempra	194 to 197
Compact transformers	
accessories	92
single phase	92
technical information	93 to 95
Contactors (CX ³)	
signalling auxiliaries for CX ³ 16-63 A	98 to 99
technical information	100
with 24 V / 230 V coil	98 to 99
Control switches	101
Control transformers	
single phase	90
technical information	91, 94 to 95
Crimping tools for ferrules (Starfix)	148
Current transformers CT (metering)	70
Cylindrical cartridge fuses (HRC)	76 to 77

D

Distribution blocks	
distribution terminal blocks	42
extra-flat distribution blocks 125/250 A	44
modular style distribution blocks 40-160 A	43
self assembly distribution blocks	45
stepped distribution blocks 125-400 A	44

Distribution terminal blocks	
fully shrouded	42
supports for terminal blocks	42
technical information	42
unshrouded	42
DX ³ -IS isolating switches	84
DX ³ MCBs	
accessories	58
auxiliaries	58
dimensions	65
DX ³ MCBs – 10 kA	57
DX ³ MCBs – 16 kA	56 to 57
technical information	59 to 60
DX ³ RCBOs	63 to 64
DX ³ RCDs	61 to 62

E

EconoRex analogue time switches	112
Electronic time-lag switch	113
EMDX ³ measuring meters	
electrical energy meters – modular	68
electrical energy meters – single phase	68
electrical energy meters – three phase	68
multi-function measuring meters	68 to 69
technical information	71 to 73
Enclosures	
Atlantic-E steel	14
Atlantic stainless steel	16
crosspieces	26
equipment and fixing accessories	26
features information	8 to 9
heating	31
insulated modular chassis	25
internal doors	25
locking accessories	14, 28
Marina GRP	18 to 22
Plexo weatherproof boxes	36 to 41
Plexo ³ weatherproof IP 65	33 to 34
sectioned uprights	21, 26
selection chart	10 to 11
universal plates	23
ventilation	29

F

Ferrules (Starfix)	148
Filtered power supplies	
electrical characteristics	97
single phase	96
technical information	96 to 97
Free standing enclosures (Marina)	21
Fuses	
cylindrical cartridge fuses HRC	76 to 77
HRC blade type cartridge fuses type aM/ gG	78
modular carriers accessories	75
modular carriers for HRC aM and gG fuses	74
SP fuse carriers	74
technical information	79

G

GRP (Marina) enclosures	
equipment and fixing accessories	18, 26
features information	9
free standing	21
insulated modular chassis	25
internal doors	25
locking accessories	28
selection chart	10 to 11
universal plates	23
wall mounting	18

H

HRC blade type cartridge fuses	78
HRC cylindrical cartridge fuses	76 to 77
Hypra combination units	
IP 44 - LV 16/32/63 A units	190
IP 66/67-55 - LV 16/32/63/125 A units	191
technical information	192 to 193
Hypra IP 44 plugs and sockets	
back boxes	163, 164
ELV 16 A and LV 16 A	163
LV 32 A	164
LV 63 A	164
mobile sockets	163, 164

panel appliance inlets	163, 164
panel mounting sockets	163, 164
selection chart	162
straight plugs	163, 164
surface mounting sockets	164
technical information	165 to 167
Hypra IP 44/55 Prisinter sockets	
interlocked switched sockets LV 16 A	156
interlocked switched sockets LV 32 A	157
interlocked switched sockets LV 63 A	157
selection chart	156
technical information	158 to 159
Hypra IP 66/67-55 plugs and sockets	
angled plugs	169, 170
back boxes	169, 170
LV 16 A	169
LV 32 A / 63 A / 125 A	170
mobile sockets	169, 170
panel mounting sockets	169, 170
selection chart	168
straight plugs	169, 170
surface mounting sockets	170
technical information	171 to 173

I

Indicators 250 V	101
Industrial plugs and sockets	
Hypra appliance inlets	162
Hypra IP 44 plugs and sockets	162 to 167
Hypra IP 44/55 Prisinter sockets	156 to 159
Hypra IP 66/67-55 plugs and sockets	168 to 173
P17 Tempra appliance inlets	179, 183, 184
P17 Tempra Pro IP 44	
plugs and sockets	178 to 181
P17 Tempra Pro IP 66/67	
plugs and sockets	182 to 187
Industrial plugs and sockets conformity	
to international standards	198
Insulated modular chassis for enclosures	25
Internal doors for wall mounting enclosures	25
IP table	209
Isolating switches	
DX ³ -IS 16 to 125 A	84
Vistop 63 to 160 A	85 to 86
Isolation and protection changeover switches	87
Isolation, control and signalling auxiliaries	
power contactors (CX ³)	98, 99
Vistop	85

L

Light control switches	113
Locking accessories for enclosures	14, 28

M

Marina GRP enclosures	
equipment and fixing accessories	18, 26
features information	9
free standing	21
free standing technical information	22
insulated modular chassis	25
internal doors	25
locking accessories	28
plinths	18, 21
roofs	18, 21
sectioned uprights	21
selection chart	10 to 11
universal plates	23
wall mounting	18
wall mounting technical information	19 to 20
Marking label sheets	140
Marking systems	
accessories	142
CAB 3	140 to 143
for cables	140 to 141
for Viking terminal blocks	140 to 141
technical information	143
MaxiRex time switches	
analogue surface and panel mounting	112
digital surface and panel mounting	110
MCBs DX ³	
accessories	58
auxiliaries	58
dimensions	65
DX ³ – 10 kA 1-63 A	57
DX ³ – 16 kA 1-125 A	56 to 57
protection of DC circuits	60

selectivity table	59
technical information	59
tripping curves	59
Metering	
current transformers CT	70
EMDX ³ electrical energy meters	68
EMDX ³ multi-function measuring meters	68 to 69
technical information	70 to 73
MicroRex time switches	
MicroRex analogue for rail	111
MicroRex D digital for rail	109
MicroRex D Plus digital for rail	109
Mobile P17 Tempra combination units	194 to 197
Modular device accessories	75
Modular DIN rail equipment	
bell transformers	102
changeover switches	87
dimensions	65, 103
DX ³ -ID RCDs	61 to 62
DX ³ MCBs	56 to 58
DX RCBOs	63
DX ³ RCBOs	63 to 64
EMDX ³ multi-function measuring unit	68
indicators	101
isolating switches DX ³ -IS	84
power contactors CX ³ (with handle)	99
power contactors CX ³ (without handle)	98
push buttons/control switches 20 A	101
safety transformers	102
signalling auxiliaries for CX ³ 16-63 A	
contactors(with handle)	98
signalling auxiliaries for CX ³ 16-63 A	
contactors(without handle)	98
Modular fuse carriers	
accessories	75
for HRC type aM and gG fuses	74
SP fuse carriers	74
technical information	74

N

Nylbloc terminal strips	41
-------------------------	----

O

Open slot panel trunking (Transcab)	48 to 51
-------------------------------------	----------

P

P17 Tempra combination units	
self assembly	195
surface mounting	194
technical information	196 to 197
P17 Tempra IP 66/67 plugs and sockets	
appliance inlets	183
LV 16 A	183
LV 32 A / 63 A / 125 A	183
mobile sockets	183
panel mounting sockets	183
selection chart	182
straight plugs	183
surface mounting sockets	183
technical information	184 to 187
P17 Tempra Pro IP 44 plugs and sockets	
appliance inlets	179
LV 16 A	179
LV 32 A	179
mobile sockets	179
panel mounting sockets	179
selection chart	178
straight plugs	179
surface mounting sockets	179
technical information	180 to 181
Panel mounting sockets	
Hypra	160 to 173
Hypra Prisinter	154 to 159
P17 Tempra	174 to 187
Panel trunking (Transcab)	48 to 51
Plexo weatherproof boxes	
features information	9
IP 55 – IK 07	37
IP 55 – IK 07 class II	37 to 38
IP 55 – IK 07/08 PVC increased depth	40
IP 66 – IK 08 class II	38
selection chart	36
technical information	37, 39 to 41
Plexo³ weatherproof enclosures IP 65	
accessories	33
enclosures 2 to 8 modules per row	33
enclosures 12 modules per row	33
enclosures 18 modules per row	33
features information	9
technical information	32
Plugs and sockets	
Hypra IP 44	160 to 167
Hypra IP 44/55 Prisinter	154 to 159
Hypra IP 66/67-55	168 to 173

P17 Tempra IP 44	174 to 181
P17 Tempra IP 66/67	182 to 187
Power and protection	
DX ³ and auxiliaries	56 to 60
DX ³ RCBOs	63 to 64
DX ³ RCDs	61 to 62
Power and protection auxiliaries	
for MCBs DX ³	58
RCBOs DX ³	64
RCDs DX ³ -ID	62
Power contactors	
signalling auxiliaries for CX ³ 16-63 A	98 to 99
technical information	100
with 24 V coil	98
with 230 V coil	98 to 99
Power supplies (filtered)	
electrical characteristics	97
single phase	96
technical information	96 to 97
Prisinter (Hypra)	154 to 159
Programmable light sensitive switch	113
Programmable time switches	
AlphaRex ³ time switches	106 to 108
Push buttons 20 A	101

R

RCBOs	
DX	63
DX ³ 10 kA and auxiliaries	63 to 64
dimensions	65
RCDs	
DX ³ ID and auxiliaries	61 to 62
dimensions	65
Rex control switches	
AlphaRex ³ Astro light control digital	106
AlphaRex ³ digital	106
AlphaRex ³ digital technical information	107 to 108
EconoRex MT analogue	112
Electronic time-lag switch	113
MaxiRex analogue surface and panel mounting	112
MaxiRex D Plus digital surface and panel mounting	110
MicroRex analogue for rail	111
MicroRex D digital for rail	109
MicroRex D Plus digital for rail	109
programmable light sensitive switch	113

S

Safety transformers	102
Stainless steel enclosures (Atlantic)	
crosspieces	26
equipment and fixing accessories	26
features information	8
insulated modular chassis	25
internal doors	25
locking accessories	28
sectioned uprights	26
selection chart	10 to 11
stainless steel enclosures – 304 L	16
stainless steel enclosures – 316 L	16
technical information	16 to 17
universal plates	23
wall mounting brackets	16
Starfix	
applicators	149
crimping tools	148
ferrules	148
technical information	149
Steel enclosures (Atlantic-E)	
crosspieces	26
equipment and fixing accessories	26
features information	12 to 13
insulated modular chassis	25
internal doors	25
locking accessories	14
plinths	14
roofs	14
sectioned uprights	26
selection chart	10 to 11
steel enclosures	14
technical information	15
universal plates	23
wall mounting brackets	14

T

Tempra (P17) plugs and sockets	
IP 44	174 to 181
IP 66/67	182 to 187
Terminal blocks (Viking 3)	
accessories for terminal blocks	126 to 127
features information	116 to 117
heavy duty terminal blocks	133 to 134

marking label sheets	140
marking systems CAB 3	140 to 143
selection chart – heavy duty	132
selection chart – screw connection	118 to 119
selection chart – spring connection	122 to 123
technical information	128 to 131, 135
terminal blocks with screw connection	120 to 121
terminal blocks with spring connection	124 to 125
Terminal shield boxes	35
Terminal strips	
Nylbloc	41
Time switches	
AlphaRex ³ Astro light control digital	106
AlphaRex ³ digital	106
AlphaRex ³ digital technical information	107 to 108
EconoRex analogue	112
electronic time-lag switch	113
MaxiRex analogue surface and panel mounting	112
MaxiRex D Plus digital surface and panel mounting	110
MicroRex analogue for rail	111
MicroRex D digital for rail	109
MicroRex D Plus digital for rail	109
programmable light sensitive switch	113
Transcab open slot panel trunking	48 to 51
Transformers	
bell transformers	102
compact transformers	92 to 93
control transformers	90 to 91
how to calculate rated power	94
power supplies	96 to 97
protection of circuits	95
safety transformers	102

U

Universal plates for wall mounting enclosures	23
---	----

V

Viking 3	
accessories for terminal blocks	126 to 127
features information	116 to 117
heavy duty terminal blocks	133 to 134
marking label sheets	140
marking systems CAB 3	140 to 143
selection chart – heavy duty	132
selection chart – screw connection	118 to 119
selection chart – spring connection	122 to 123
terminal blocks with screw connection	120 to 121
terminal blocks with spring connection	124 to 125
technical information	128 to 131, 135
Vistop isolating switches	
63 to 160 A	85
auxiliary switch - 250 V	85
auxiliary isolating switch - 400 V	85
technical information	86

W

Wall mounting enclosures	
Atlantic-E steel	12
Atlantic stainless steel	16
equipment and fixing accessories	18, 26
features information	8 to 9
insulated modular chassis	25
internal doors	25
locking accessories	14 and 28
Marina GRP	18
Plexo weatherproof boxes	36 to 41
Plexo ³ weatherproof IP 65	32 to 34
selection chart	10 to 11
universal plates	23
Weatherproof boxes Plexo IP 55 / 66	36 to 41
Weatherproof enclosures Plexo³ IP 65	32 to 34

Conditions of sale

please consult our current price list

In accordance with its policy of continuous improvement, the Company reserves the right to change specifications and designs without notice. All illustrations, descriptions, dimensions and weights in this catalogue are for guidance and cannot be held binding on the Company. All contents and design presentation included in this publication are © Legrand Electric Limited. All rights reserved. 2014



ENCLOSURES AND EQUIPMENT

**Atlantic-E
steel**



P. 10
Selection chart

**Atlantic
stainless steel**



P. 10
Selection chart

Marina GRP



P. 10
Selection chart

**Equipment
and locking
accessories**

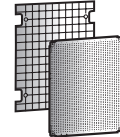

P. 23
Universal plates

**Ventilation
and heating
for enclosures**

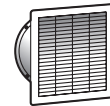

P. 29
Ventilation
for enclosures

**Plexo³ weatherproof
enclosures and
terminal shield
boxes**



P. 32
Introduction to
Plexo³ weatherproof
enclosures

**Plexo
weatherproof
boxes**



P. 36
Selection chart

**Nylbloc
terminal strips**



P. 41
Nylbloc
terminal strips

**Distribution
blocks**

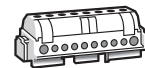

P. 42
Distribution
terminal blocks



P. 12
Introduction to Atlantic-E steel enclosures

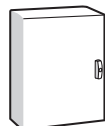

P. 14
Atlantic-E wall mounting steel enclosures IP 66 - IK 10



P. 15
Technical information



P. 16
Atlantic wall mounting 304L stainless enclosures IP 66 - IK 10



P. 16
Atlantic wall mounting 316L stainless enclosures IP 66 - IK 10



P. 16
Technical information

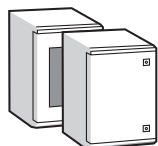

P. 18
Marina wall mounting GRP enclosures IP 66 - IK 10



P. 19
Technical information



P. 21
Marina free standing GRP enclosures IP 66 - IK 10



P. 22
Technical information

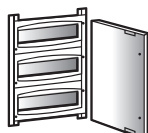

P. 25
Insulated modular chassis and internal doors

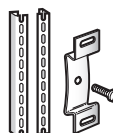

P. 26
Equipment and fixing accessories



P. 27
Technical information

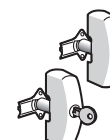

P. 28
Locking accessories



P. 30
Operating principle for ventilation

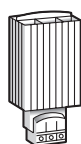

P. 31
Heating for enclosures



P. 31
Operating principle for heating



P. 33
Plexo³ weatherproof enclosures IP 65 - IK 09



P. 34
Technical information

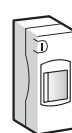

P. 35
Terminal shield boxes IP 30



P. 35
Technical information

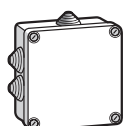

P. 37
IP 55 - IK 07

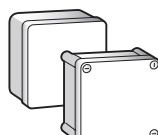

P. 38
IP 55 - IK 07/class II
IP 66 - IK 08

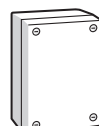

P. 40
PVC range with increased depth IP 55 - IK 07/08



P. 37, 39, 40, 41
Technical information



P. 43
Modular distribution blocks 40 to 160 A

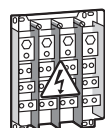

P. 44
Four pole distribution blocks 125 to 400 A

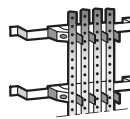

P. 45
Equipment for self assembly distribution blocks



P. 42, 43, 44, 45
Technical information

The right enclosure for your environment

Legrand's range of industrial enclosures has been designed to the highest specification, providing the user with much more than just a box!



STEEL ENCLOSURES

Atlantic-E

Suitable for non-corrosive commercial and industrial environments.

FEATURES

- Full range of 27 sizes
- Complete with removable mounting plate
- Optional heavy duty mounting brackets
- Dual locks on larger sizes

TECH DATA

IP66 in accordance with IEC EN 60529
IK10 in accordance with IEC EN 62262



STAINLESS STEEL ENCLOSURES

Atlantic

Suitable for corrosive environments and those requiring rigorous hygiene (e.g. food industry).

FEATURES

- Available in 8 sizes
- 304L and 316L grade steel options
- Reversible enclosure with rounded door and protective flange
- Double bar locks

TECH DATA

IP66 in accordance with IEC EN 60529
IK10 in accordance with IEC EN 62262
Nema 4x

All the kit you need for your enclosure

Tailor your enclosure to the exact requirements of an installation with Legrand's wide selection of equipment, including plain and perforated plates, insulated modular chassis and internal doors, heating, ventilation and locking devices.

See p. 23 - 31



FREE CPD: SPECIFICATION GUIDE TO ENCLOSURES
VISIT: LEGRAND.CO.UK/TRAINING



GRP ENCLOSURES

Marina

Suitable for saline atmospheres or other corrosive environments.

FEATURES

- Available in 11 sizes
- Wall mounting and free standing options
- Reversible plain or glass window door - 180° opening
- Dual locks on larger sizes

TECH DATA

IP66 in accordance with IEC EN 60529
IK10 in accordance with IEC EN 62262

WEATHERPROOF ENCLOSURES

Plexo³

Suitable for a multitude of indoor and outdoor applications.

FEATURES

- Available in 11 sizes
- Fully reversible door and enclosure
- Lockable door handle
- Sealable cover and face plate
- Optimised cable runs and organisation

TECH DATA

IP65 in accordance with IEC EN 60529
IK09 in accordance with IEC EN 62262
Conform to EN 60439-3

WEATHERPROOF BOXES

Plexo 55 / Plexo 66

Suitable for a multitude of indoor and outdoor applications.

FEATURES

- Quarter turn fixings
- Halogen free option
- Plain and transparent cover options
- Rail or plain plate equipment mounting

TECH DATA

IP55 / 66 in accordance with IEC EN 60529
IK07 / 08 in accordance with IEC EN 62262
Polycarbonate, polypropylene, PVC and polystyrene boxes

Seamless integration with Legrand's extended family

With high quality products throughout its product portfolio, Legrand is in an unbeatable position... offering integrated solutions designed to meet your needs whatever the budget or installation requirements.



Transcab open slot panel trunking
see p. 48 to 51

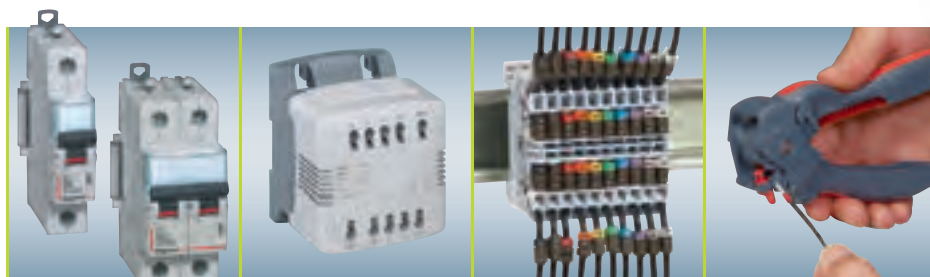

DIN rail equipment
see p. 54 to 113

Transformers
see p. 88 to 97

Viking 3 terminals
see p. 116 to 135

Starfix ferrules & tools
see p. 148 to 149

Atlantic-E, Atlantic and Marina enclosures and equipment

selection chart

EXTERNAL DIMENSIONS (nominal)				ATLANTIC-E ENCLOSURES	ATLANTIC ENCLOSURES		MARINA ENCLOSURES		
				STEEL IP 66 - IK 10 WALL MOUNTING GREY RAL 7035	STAINLESS STEEL IP 66 - IK 10 WALL MOUNTING Stainless 304 L Stainless 316 L		POLYESTER (GRP) IP 66 - IK 10 WALL MOUNTING GREY RAL 7035 GREY RAL 7035 with window FREE STANDING GREY RAL 7035		
Shapes	H (mm)	W (mm)	D (mm)	All supplied with plain plate					
	300	200	150	0399 30	-	-	-	-	-
	400	300	150	0399 34	-	-	-	-	-
	500	400	150	0399 38	-	-	-	-	-
	300	200	160	-	0352 00 Supplied with plain plate	0352 40 Supplied with plain plate	0362 50	-	-
	400	300	200	0399 35	0352 01	0352 41	0362 51	0362 71	-
	500	400	200	0399 39	0352 02	0352 42	0362 52	0362 72	-
	600	400	200	0399 42	0352 03	-	-	-	-
	600	500	200	0399 44	-	-	-	-	-
	700	500	200	0399 51	-	-	-	-	-
	800	600	200	0399 54	-	-	-	-	-
	500	400	250	0399 40	-	-	-	-	-
	600	400	250	0399 43	0352 05	0352 45	0362 55	0362 75	-
	600	500	250	0399 45	-	-	-	-	-
	700	500	250	0399 52	0352 06	0352 46	0362 56	0362 76	-
	800	600	250	0399 55	-	-	-	-	-
	1000	800	250	0399 64	-	-	-	-	-
	800	600	300	0399 56	0352 11	0352 47	0362 61	0362 81	-
	1000	600	300	0399 63	-	-	-	-	-
	1000	800	300	0399 65	0352 13	0352 53	0362 63	-	-
	1200	800	300	0399 69	-	-	0362 64	-	-
1460	800	463	-	-	-	-	-	0362 85	
1660	800	463	-	-	-	-	-	0362 86	
1860	800	463	-	-	-	-	-	0362 87	
	300	300	150	0399 31	-	-	-	-	-
	300	300	200	0399 32	-	-	-	-	-
	400	400	200	0399 36	-	-	-	-	-
	500	500	250	0399 41	-	-	-	-	-
	600	600	250	0399 46	-	-	-	-	-
	800	800	300	0399 59	-	-	-	-	-
	300	400	200	0399 33	-	-	-	-	-
	400	600	250	0399 37	-	-	-	-	-

1 : Atlantic-E enclosures are supplied complete with removable mounting plate 2 : Requires Cat. No. 0363 69 when mounting in Atlantic stainless steel (see p. 25)
 3 : Galvanised steel 4 : Pre-galvanised steel
 A : For Atlantic stainless steel only M : For Marina only E : For Atlantic-E only

EQUIPMENT										ASSOCIATED PRODUCTS
Plain plates ^{1,4}	Lina 12-5 perforated plates ⁴	Lina 25 perforated plates ⁴	Modular chassis	Internal doors (not compatible with Atlantic-E enclosures)	Lina 25 sectioned uprights	Lina 25 crosspieces	Roofs (not compatible with Atlantic stainless steel enclosures)	Plinths		
–	0360 00	0360 07	–	–	0361 50	–	–	–		Document pocket p. 26
–	0360 04	0360 12	–	–	0361 51	0367 80	–	–		
–	0360 09	0360 15	–	–	0361 52	0367 81	–	–		Perforated plates p. 23
0360 49 ^M	0360 00 ^A 0360 01 ^M	0360 07 ^A 0360 99 ^M	–	–	0361 50 ^A	–	–	–		
0360 52	0360 04	0360 12	0361 01	0363 59 ²	0361 51	0367 80	0365 51 ^E	–		Locking accessories p. 28
0360 55	0360 09	0360 15	0361 02	0363 60 ²	0361 52	0367 81	0365 52 ^E	–		
0360 56	0360 22	0360 16	–	0363 61 ²	0361 53	0367 81	0365 52 ^E	–		Ventilation kits p. 29
–	–	–	–	–	0361 53	0367 82	–	–		
–	0360 31	0360 18	–	–	0361 54	0367 82	–	–		Heaters and thermostat p. 31
–	0360 33	0360 19	–	–	0361 55	0367 83	–	–		
–	0360 09	0360 15	–	–	0361 52	0367 81	0365 53	–		Chassis kits p. 25
0360 56	0360 22	0360 16	0361 03	0363 61 ²	0361 53	0367 81	0365 53 ^E	–		
–	–	–	–	–	0361 53	0367 82	0365 64	–		
0360 58	0360 31	0360 18	0361 05	0363 62 ²	0361 54	0367 82	0362 93 ^M 0365 64 ^E	–		
–	0360 33	0360 19	–	–	0361 55	0367 83	–	–		
–	0360 42	0360 21	–	–	0361 56	0367 84	–	–		
0360 59	0360 33	0360 19	0361 06	0363 63 ²	0361 55	0367 83	0365 56 ^E 0362 94 ^M	0363 00 ^E 0362 91 ^M		
–	0360 40	0360 23	–	–	0361 56	0367 83	0365 56	0363 00		
0360 61	0360 42	0360 21	0361 09	0363 64 ²	0361 56	0367 84	0365 57 ^E 0362 95 ^M	0363 01 ^E 0362 92 ^M		
0360 64	0360 46	0360 87	0361 10	0363 65 ²	0361 58	0367 84	0365 57 ^E 0362 95 ^M	0363 01 ^E 0362 92 ^M		
0349 59 ³	–	–	–	–	0363 90	–	0362 97	0362 96		
0349 50 ³	–	–	–	–	0363 91	–	0362 97	0362 96		
0344 18 ³	–	–	–	–	0363 92	–	0362 97	0362 96		
–	0360 02	0360 91	–	–	0361 50	0367 80	–	–		
–	0360 02	0360 91	–	–	0361 50	0367 80	0365 51	–		
–	0360 05	0360 92	–	–	0361 51	0367 81	0365 52	–		
–	0360 14	0360 93	–	–	0361 52	0367 82	0365 64	–		
–	0360 24	0360 17	–	–	0361 53	0367 83	0365 54	–		
–	0360 34	0360 20	–	–	0361 55	0367 84	0365 57	0363 01		
–	0360 04	0360 11	–	–	0361 50	0367 81	0365 52	–		
–	0360 22	0360 13	–	–	0361 51	0367 83	0365 54	–		

Atlantic-E...

strength and innovation in equal measure

This robust range of steel wall mounting enclosures is the latest addition to Legrand's extensive industrial product portfolio. Atlantic-E has been designed to the highest specification and incorporates a number of innovations that make installation faster and easier than ever before.



Designed with the installer in mind

Save time on installation... each Atlantic-E enclosure is supplied ready to use with a removable plain mounting plate, cable entry plate, earth connection braid and wall mounting brackets.

Flexible and reliable... doors are easy to remove, are fully reversible if required, and offer a 130° opening for easy access inside the enclosure. Innovative design features provide greater strength and weatherproofing to ensure a long-lasting installation.

- Full range of 27 sizes (up to 1200 x 800 x 300 mm)
- Supplied complete with removable mounting plate
- IP 66 weatherproof seal
- IK 10 - maximum protection against mechanical impact
- Dual locks on larger sized enclosures provide additional security
- Optional mounting brackets for heavy loads

Optional features and fully compatible products extend your choices

With a wide selection of accessories and equipment available, Atlantic-E enclosures can easily be tailored to the specific requirements of each application.



Heavy duty mounting brackets
see p. 14

Mounting plate options
see p. 23

Transcab open slot panel trunking
see p. 48 to 51

Viking 3 terminal blocks
see p. 116 to 135





Sectioned uprights - provide greater door strength and mounting holes for cable trunking



Weatherproof seal - polyurethane seal for greater reliability and total weatherproofing to IP 66



Removable plain mounting plate - provides maximum usable space and an easy method of fixing equipment directly. Optional perforated plates or ready to use chassis available

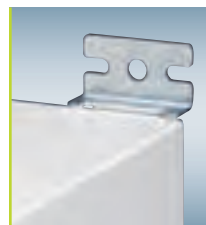

Mounting brackets - wall mounting brackets supplied with enclosure. Optional mounting brackets for heavy loads available



130°

Double bar locks - ensure a totally weatherproof seal. Supplied with double bar key. Alternative locks available



Reversible door - easy to remove. With metal hinges for guaranteed strength. Opens to 130° for easier access inside the enclosure

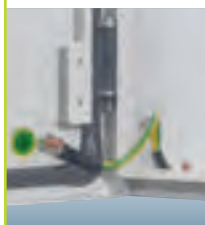

Removable cable entry plate - fully weatherproof polyurethane seals aligned with the base of the enclosure for a high quality finish. Can be equipped with cable glands



Atlantic-E steel wall mounting enclosures

IP 66 - IK 10



Technical information and dimensions **p. 15**
Equipment **p. 23-31**

Pack	Cat. Nos.	Steel enclosures			
		Grey RAL 7035 IP 66 according to IEC 60529 IK 10 according to IEC 62262 (EN 50102) Supplied with : galvanised plain mounting plate (removable), earth connection braid and wall mounting brackets Reversible door Supplied with one double bar lock up to 500 x 500 x 250 mm and 2 double bar locks from 600 x 400 x 150 mm Removable cable entries plate Can be equipped with Lina 12.5 and Lina 25 perforated plates, sectioned uprights, DIN rail or chassis with insulating faceplates (p. 23-26) 80 µ thick textured polyester coating			
		Dimensions (mm)			
		Height	Width	Depth	Weight (kg)
1	0399 30	300	200	150	4.5
1	0399 31	300	300	150	4.7
1	0399 32	300	300	200	4.8
1	0399 33	300	400	200	6.7
1	0399 34	400	300	150	6.25
1	0399 35	400	300	200	6.7
1	0399 36	400	400	200	10.5
1	0399 37	400	600	250	13.5
1	0399 38	500	400	150	11
1	0399 39	500	400	200	11.5
1	0399 40	500	400	250	12
1	0399 41	500	500	250	12.5
1	0399 42	600	400	200	13
1	0399 43	600	400	250	13.5
1	0399 44	600	500	200	16
1	0399 45	600	500	250	16.5
1	0399 46	600	600	250	17
1	0399 51	700	500	200	20
1	0399 52	700	500	250	21
1	0399 54	800	600	200	27
1	0399 55	800	600	250	30
1	0399 56	800	600	300	31.7
1	0399 59	800	800	300	33.5
1	0399 63	1000	600	300	48
1	0399 64	1000	800	250	49.5
1	0399 65	1000	800	300	52
1	0399 69	1200	800	300	62

Pack	Cat. Nos.	Plinths		Weight (kg)
		Anthracite grey RAL 7021 Height 200 mm Front and rear trap door		
		For 300 mm deep enclosures		
		Enclosure width (mm)		
1	0363 00	600		6
1	0363 01	800		6.7

Pack	Cat. Nos.	Wall mounting brackets
		Grey RAL 7035 For heavy loads up to 300 kg Horizontal or vertical installation With a roof, horizontal installation only Zamak Supplied with cover
1	0364 01	Set of 4

Pack	Cat. Nos.	Locking accessories
		Metal rebate lock barrels 6 mm female square 8 mm male triangle
10	0399 80	
10	0399 81	
		Keys for rebate locks 6 mm female square 8 mm male triangle
10	0365 35	
10	0365 40	
		Key barrels Supplied with set of 2 keys For key No :
10	0399 86	405
10	0399 87	455
10	0399 88	2433 A
10	0365 45	Set of two 2433 A keys

Pack	Cat. Nos.	Roofs		Weight (kg)
		Grey RAL 7035 Steel Possible adjustment ± 20 mm (front or back) For enclosures		
		Width (mm)	Depth (mm)	
1	0365 51	300	200	1.2
1	0365 52	400	200	1.4
1	0365 53	400	250	1.8
1	0365 64	500	250	2
1	0365 54	600	250	2.5
1	0365 56	600	300	3
1	0365 57	800	300	3.6

Lina 12.5 and Lina 25 perforated plates **p. 23**
Modular chassis **p. 25**
Sectioned uprights **p. 26**
Crosspieces **p. 26**

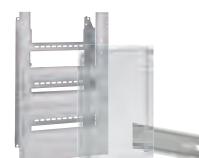

Atlantic-E steel wall mounting enclosures

IP 66 - IK 10 (continued)

■ Fixing dimensions

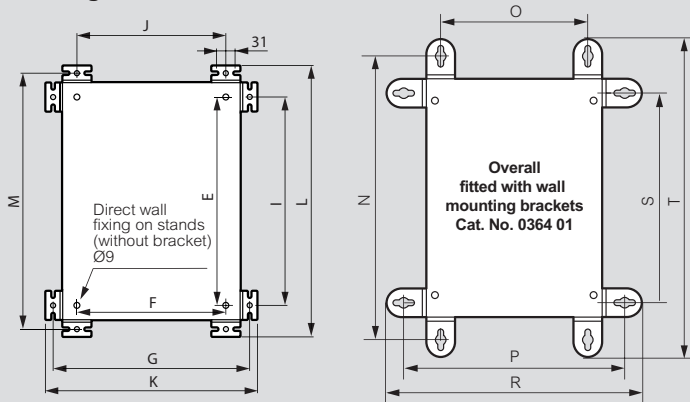

Enclosures		Vertical brackets		Mounting centres		Horizontal brackets		Mounting centres		Overall		Overall with 0364 01		Vertical brackets		Horizontal brackets	
H (mm)	W (mm)	M (mm)	J (mm)	E (mm)	I (mm)	G (mm)	F (mm)	L (mm)	K (mm)	T (mm)	R (mm)	N (mm)	O (mm)	P (mm)	S (mm)		
300	200	330	150	250	250	230	150	356	256	430	330	375	150	275	250		
300	300	330	250	250	250	330	250	356	356	430	430	375	250	375	250		
300	400	330	350	250	250	430	350	356	456	430	530	375	350	475	250		
400	300	430	250	350	350	330	250	456	356	530	430	475	250	375	350		
400	400	430	350	350	350	430	350	456	456	530	530	475	350	475	350		
400	600	430	550	350	350	530	550	456	656	530	730	475	550	575	350		
500	400	530	350	450	450	430	350	556	456	630	530	575	350	475	450		
500	500	530	450	450	450	530	450	556	556	630	630	575	450	575	450		
600	400	630	350	550	550	430	350	656	456	730	530	675	350	475	550		
600	500	630	450	550	550	530	450	656	556	730	630	675	450	575	550		
600	600	630	550	550	550	630	550	656	656	730	730	675	550	675	550		
700	500	730	450	650	650	530	450	756	556	830	630	775	450	575	650		
800	600	830	550	750	750	630	650	856	656	930	730	875	550	675	750		
800	800	830	750	750	750	830	750	856	856	930	930	875	750	875	750		
1000	600	1030	550	950	950	630	550	1056	656	1130	730	1075	550	675	950		
1000	800	1030	750	950	950	830	750	1056	856	1130	930	1075	750	875	950		
1200	800	1230	750	1150	1150	830	750	1256	856	1330	930	1275	750	875	1150		

■ Usable depth

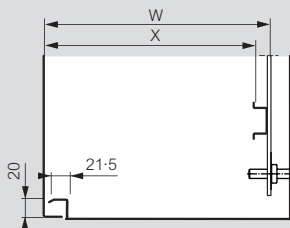

Enclosures depth (mm)	Back of enclosures	
	W (mm)	X (mm)
150	130	115
200	180	165
250	230	215
300	280	265

■ Doors : usable area dimensions

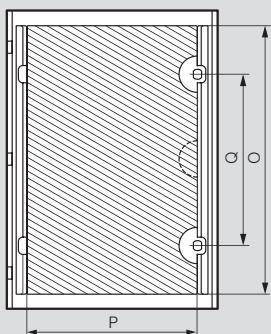

Enclosures H x W (mm)	Door usable space			Locking position Q (mm)
	Height O (mm)	Width P (mm)	Area (dm ²)	
300 x 200	251	80	2.0	1
300 x 300	251	180	4.5	1
300 x 400	251	280	7.0	1
400 x 300	351	180	6.3	1
400 x 400	351	280	9.8	1
400 x 600	351	480	16.8	1
500 x 400	425	280	11.9	1
500 x 500	425	380	16.1	1
600 x 400	525	280	14.7	350 ²
600 x 500	525	380	19.9	350 ²
600 x 600	525	480	25.2	350 ²
700 x 500	625	380	23.7	450 ²
800 x 600	725	480	36.0	550 ²
800 x 800	725	680	49.3	550 ²
1000 x 600	925	480	44.4	750 ²
1000 x 800	925	680	62.9	750 ²
1200 x 800	1125	680	76.5	950 ²

1 : Central lock
2 : Top and bottom lock

■ Roof fixing position

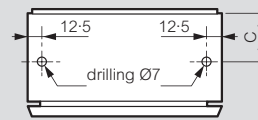

Cat. Nos.	C (mm)
0365 51/52	100
0365 53/54/64	125
0365 56/57	150

■ Plinths

Trap doors

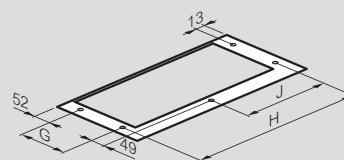
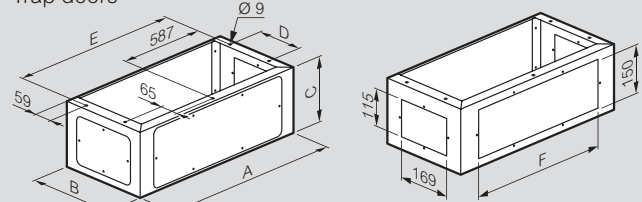

Cat. Nos.	Enclosures W x D (mm)	A	B	C	D	E	F	G	H	J
0363 00	600 x 300	600	280	200	150	574	469	150	542	271
0363 01	800 x 300	800	280	200	150	774	469	150	742	371

■ Cable entry plate

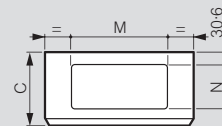

Enclosures (mm)	Dimensions of cable entries (mm)	
	W	D
200	150	155
300	150	155
300	200	205
400	150	155
400	200	205
400	250	255
500	200	205
500	250	255
600	200	205
600	250	255
600	300	305
800	250	255
800	300	305

Atlantic stainless steel wall mounting enclosures

IP 66 - IK 10 - Nema 4x



Technical information and dimensions **opposite**
Equipment **p. 23-31**

IP 66 according to IEC 60529
IK 10 according to IEC 62262 (EN 50102)
UL listed (Nema 4x)
CSA, Bureau Veritas, LRS. LCIE N° 170 790 10A
Stainless steel 304 L, 316 L
Upper and lower protective hoods
Door with rounded vertical sides

For use in :

• areas requiring a high level of hygiene :

- food processing plants and dairies
- industrial/commercial kitchens

• corrosive conditions :

- chemical plants
- pharmaceutical, petroleum and paper industries

• very harsh environments :

- industrial; acid or acid fumes
- offshore; naval; chlorides present

Automatic positioning of equipment on to active corners with M8 fixings
Provision to fix optional runners and brackets for depth adjustment in enclosures from 600 x 400 x 250 mm (contact us on +44 (0) 845 605 4333)

Pack Cat. Nos. **Stainless steel enclosures¹ – 304 L (1 door)**

Pack	Cat. Nos.	External dimensions (mm)			Weight (kg)
		Height	Width	Depth	
1	0352 00 ^{1,2}	300	200	160	4
1	0352 01 ¹	400	300	200	5-8
1	0352 02	500	400	200	8-3
1	0352 03	600	400	200	10-8
1	0352 05	600	400	250	12
1	0352 06	700	500	250	15
1	0352 11	800	600	300	22
1	0352 13	1 000	800	300	38

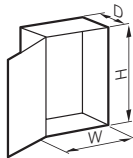

Double bar lock. Epoxy finish. Zamak coated
Locking points : 1 lock for heights ≤ 400 mm
2 locks for heights ≥ 500 mm

Stainless steel enclosures – 316 L (1 door)

Supplied with non-interchangeable double bar lock
Epoxy finish. Steel coated
Locking points : 1 lock for heights ≤ 400 mm
2 locks for heights ≥ 500 mm

Pack	Cat. Nos.	External dimensions (mm)			Weight (kg)
		Height	Width	Depth	
1	0352 40 ²	300	200	160	4
1	0352 41	400	300	200	5-8
1	0352 42	500	400	200	8-3
1	0352 45	600	400	250	12
1	0352 46	700	500	250	15
1	0352 47	800	600	300	22
1	0352 53	1 000	800	300	38

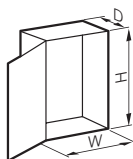

Wall mounting brackets

Supplied with stainless steel screws
Horizontal or vertical installation
Set of 4
Upto max. load 300 kg

1	0364 06	304 L
1	0364 16	316 L

1 : Cat. Nos. 0352 00/01 are fitted with 1 lock, all others are fitted with 2 locks
2 : Supplied with plain plate

■ Technical information

Stainless steel enclosures provide a solution in harsh, aggressive environments such as chemical plants or offshore

Corrosion resistance

	304 L	316 L
To salt spray (SS)	1 000 hrs	2 000 hrs
To sulphur dioxide (SO ₂)	500 hrs	1 000 hrs

Brushed stainless steel finish

Polygrain 180
- Ra 0.25 to 0.35 µm
- Rt 2.5 to 4 µm

Stainless steel properties

304 L : Provides good resistance to :

- nitric acid at concentrations of 52 % or less at all temperatures (or 98 % when cold)
- cold dilute organic acids
- alkaline solutions (unless hot or above 50 %)
- saline solutions except chlorides, sulphides and sulphates
- fresh water and natural atmosphere low in chlorides
- food products (except mustard and white wine)

316 L : Provides good resistance to :

- phosphoric acids - all concentrations ≤ 40 °C
- sulphuric acids < 10 % and > 80 % at 20 °C
- sulphuric compounds ≤ 70 °C
- sulphuric vapours and solutions, even boiling
- salt solutions except chloride
- alkaline solutions - all concentrations < 100 °C
- fresh water and natural atmosphere (particularly marine conditions)
- organic, food and pharmaceutical compounds

Physical properties

Specific weight - density : 8
Coefficient of expansion : 16 µ / m °C
Specific heat : 500 J / kg °C
Electrical resistivity : 0.75 µΩ mm²
Thermal conductivity : 15 W / m °C

The only way of guaranteeing excellent resistance to intercrystalline corrosion is the low carbon content (0.03 %) of 304 L and 316 L stainless steel

Different country names

		304 L	316 L
France	AFNOR NFEN	Z3 CN 18-10 X 2 CNI 19-11	Z3 CND 17-11-02 X 2 CNI Mo 17-12-2
Germany	DIN	X 2 CNI 19-11 (W.Nr 1-4 306)	X 2 CNI Mo 17-13-2 (W.Nr 1-4 404)
USA	AISI	304 L	316 L

Plates, internal doors, chassis and equipment **p. 23-31**



Atlantic stainless steel wall mounting enclosures

IP 66 - IK 10 - Nema 4x (continued)

■ Dimensions

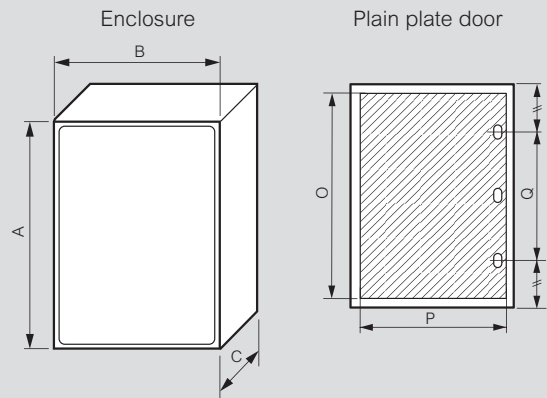

Cat. Nos.	Height	Width	Depth	Usable door surface area		Lock positions
	A (mm)	B (mm)	C (mm)	O (mm)	P (mm)	
0352 00/40	301-6	199-6	161-5	250	150	Centred
0352 01/41	401-6	299-6	201-5	350	250	Centred
0352 02/42	501-6	399-6	201-5	450	350	250
0352 03	601-6	399-6	201-5	550	350	380
0352 05/45	601-6	399-6	251-5	550	350	380
0352 06/46	702-4	500	251-5	650	450	400
0352 11/47	802-4	600	301-5	750	550	400
0352 13/53	1003-6	800-6	301-5	950	750	600

Note : Dimension C does not include lock
Lock thickness = 4 mm

■ Fixing positions for wall mounting brackets

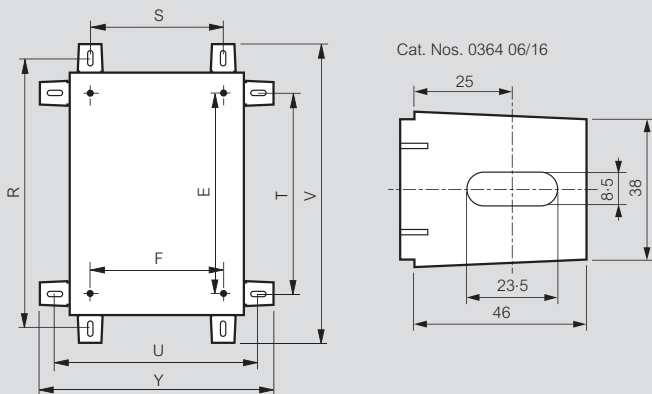

Cat. Nos.	Vertical wall brackets		Horizontal wall brackets		Dimensions			
	R (mm)	S (mm)	T (mm)	U (mm)	V (mm)	Y (mm)	E (mm)	F (mm)
0352 00/40	353	150	250	250	395	292	225	169
0352 01/41	453	250	350	350	495	392	325	269
0352 02/42	553	350	450	450	595	492	425	369
0352 03	653	350	550	450	695	492	525	369
0352 05/45	653	350	550	450	695	492	525	369
0352 06/46	753	450	650	550	795	592	625	469
0352 11/47	853	550	750	650	895	692	725	569
0352 13/53	1053	750	950	850	1095	892	925	769

Position of equipment

Without runners
For runners, contact us on +44 (0) 845 605 4333

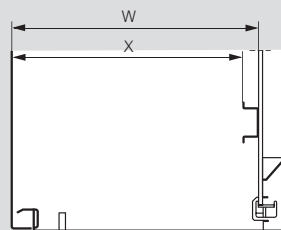

Enclosure Depth (mm)	Without runners	
	W (mm)	X (mm)
160	140	125
200	180	165
250	230	215
300	280	265

Active corner

Provides quick and easy fixing
Transfers equipment weight to wall fixings

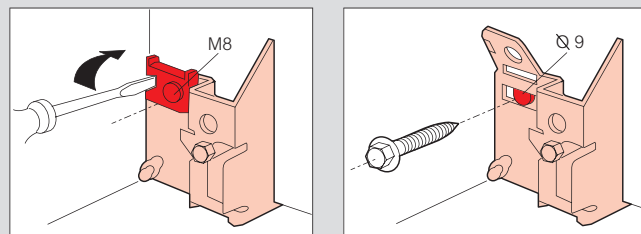

Fixing method for runners and depth adjustment brackets

Contact us on +44 (0) 845 605 4333

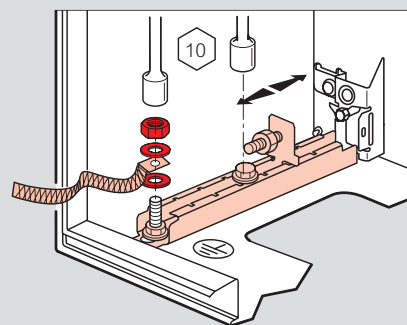

Mounting plates p. 23



Marina wall mounting enclosures

Polyester (GRP) IP 66 - IK 10



0362 56



0362 76



0362 63 + plinth Cat. No. 0362 92
+ roof Cat. No. 0362 95



0362 55 + wall brackets Cat. No. 0364 09

Technical information and dimensions **p. 19-20**
Equipment **p. 23-31**

Grey RAL 7035
IP 66 according to IEC EN 60529
IK 10 according to IEC EN 62262 (EN 50102)
Class II insulation for final assembly according to IEC EN 60439-1
Glass fibre reinforced polyester (GRP) enclosures
Self extinguishing at 960 °C according to IEC EN 60695-2-11
Designed for corrosive environments
Reversible door, 180° opening¹
2 x double bar locks¹
Captive stainless steel hinge pins¹
Mounting plate/equipment can be fixed directly to the rear of the enclosure
Accepts partial plate from 500 x 400 x 200 mm and/or rails¹
Optional depth adjustment kit (Cat. No. 0362 42) available for enclosures 400 mm high and above
For wall mounting, wall mounting brackets must be ordered separately

Pack	Cat. Nos.	GRP enclosures					
Plain door							
External dimensions (mm)							
		Height	Width	Depth	Weight (kg)		
1	0362 50	300	220	160	1.75		
1	0362 51	400	300	206	3.7		
1	0362 52	500	400	206	5.1		
1	0362 55	610	400	257	6.4		
1	0362 56	720	510	250	11.2		
1	0362 61	820	610	300	15.2		
1	0362 63	1020	810	300	21.8		
1	0362 64	1220	810	300	25.0		
Glazed door with tinted glass window							
External dimensions (mm)							
		Height	Width	Depth	Window (mm)	Weight (kg)	
					Height	Width	
1	0362 71	400	300	206	235	145	4.0
1	0362 72	500	400	206	335	245	5.6
1	0362 75	610	400	257	463	245	7.0
1	0362 76	720	510	250	570	272	12.3
1	0362 81	820	610	300	672	372	16.7

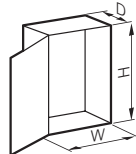

Pack	Cat. Nos.	Fixing accessories	
IP 66 maintained			
Wall mounting brackets			
Set of 4, supplied with screws			
For enclosures			
		Height (mm)	Max. load (kg)
1	0364 08	300	100
1	0364 09	400 to 1 200	150
Rear with threaded rod			
M8 for enclosures height ≥ 400 mm			
Mounting at back of enclosures			
Accessories			
1	0362 42	Depth adjustment kit for enclosures ≥ 200 mm	
4 fixings complete with screws			



Roofs			
IK 10			
For enclosures (mm)			
		Width	Depth
1	0362 93	500	250
1	0362 94	600	300
1	0362 95	800	300

Plinths			
Height 170 mm			
Front and rear trap door			
Possibility to overlap 2 plinths			
For enclosures (mm)			
		Width	Depth
1	0362 91	600	300
1	0362 92	800	300

1 : Except Cat. No. 0362 50

Plain and perforated plates **p. 23**
Modular chassis **p. 25**
Internal doors **p. 25**
Sectioned uprights **p. 26**
Crosspieces **p. 26**
Locking accessories **p. 28**

Marina wall mounting enclosures

Polyester (GRP) IP 66 - IK 10 (continued)

■ Dimensions, usable areas

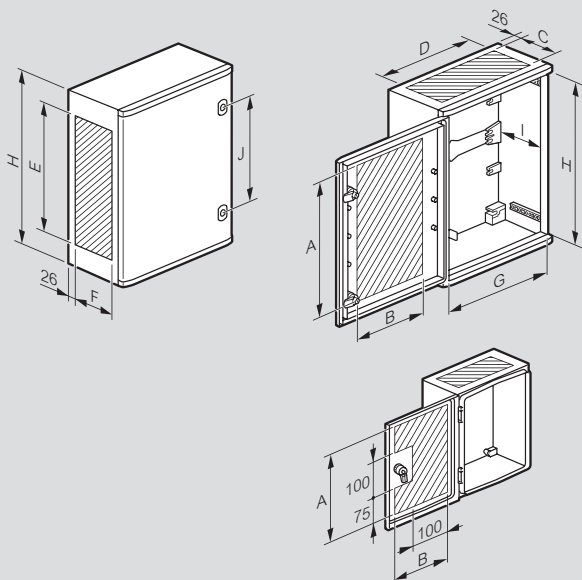

Cat. Nos.	Usable dimensions (mm)									
	A ¹	B ¹	C	D	E	F	G	H	I max.	J
0362 50	250	150	105	195	250	115	194	280	130	-
0362 51/71	300	180	130	250	260	150	260	350	178	200
0362 52/72	400	280	130	350	360	150	360	450	178	300
0362 55/75	500	280	180	350	460	180	360	560	225	400
0362 56/76	600	340	170	400	560	170	460	662	211	400
0362 61/81	700	440	220	500	660	230	560	762	261	500
0362 63	900	600	220	700	860	230	760	962	261	580
0362 64	1100	600	220	700	1060	230	760	1162	261	700

1 : Except for enclosures with glass windows

■ Dimensions for the window (glass door)

Window centred in height and width

Cat. Nos.	A (mm)	B (mm)
0362 71	235	145
0362 72	335	245
0362 75	463	245
0362 76	570	272
0362 81	672	372

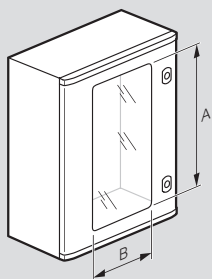

■ Roofs and plinths

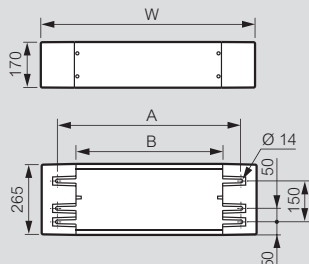
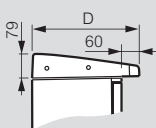

Roof Cat. Nos.	Width (mm)	D (mm)	Weight (kg)
0362 93	510	310	1
0362 94	612	360	1.3
0362 95	812	360	1.7

Plinth Cat. Nos.	W (mm)	A (mm)	B (mm)	Weight (kg)
0362 91	590	480	344	4.8
0362 92	790	680	544	5.4

■ Equipment fixing

Cat. Nos.	A (mm)	B (mm)	C (mm)	D (mm)	E (mm)	F (mm)
0362 50	263	163	-	-	-	-
0362 51/71	325	225	125	225	102.5	228.5
0362 52/72	425	325	225	325	87.5	228.5
0362 55/75	525	325	325	325	95	328.5
0362 56/76	625	425	425	425	100	428.5
0362 61/81	725	525	525	525	100	528.5
0362 63	925	725	725	725	100	728.5
0362 64	1125	725	925	725	100	728.5

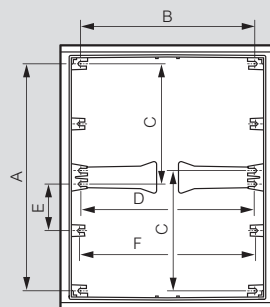

■ Adjustment of equipment (kit required)

Cat. Nos.	Full mounting plate (mm)		Chassis with rail (mm)	
	A max	A min (with Cat. No. 0362 42)	B max	B min (with Cat. No. 0362 42)
0362 50	135	-	-	-
0362 51/71	170	70	155	55
0362 52/72	170	70	155	55
0362 55/75	220	70	205	55
0362 56/76	220	70	205	55
0362 61/81	270	70	255	55
0362 63	270	70	255	55
0362 64	270	70	255	55

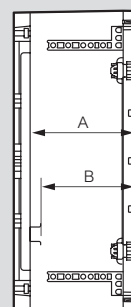

Depth adjustment using kit Cat. No. 0362 42 (except Cat. No. 0362 50)

Cat. Nos.	Thickness or wall (mm) (indicative dimensions)		
	Door	Sides	Rear
0362 50	2.5	2.5	2.5
0362 51/71	2.7	2.5	3
0362 52/72	2.7	2.5	3
0362 55/75	2.7	2.5	3
0362 56/76	4	3.5	3.5
0362 61/81	4	3.5	3.5
0362 63	4	3.5	3.5
0362 64	4	3.5	3.5

■ Fixing positions for mounting enclosure (maintains IP 66 and Class II)

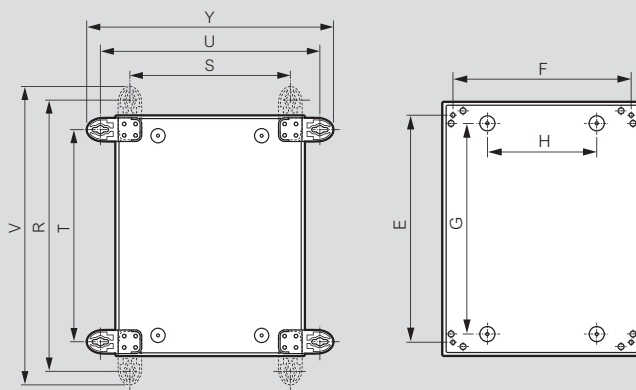

Cat. Nos.	Direct fixing outside mounting equipment area (mm)		Direct fixing through rear of enclosure (mm)		With vertical brackets (mm)			With horizontal brackets (mm)		
	E	F	G	H	R	S	V	T	U	Y
0362 50 ¹	-	-	220	150	330	190	359	270	250	279
0362 51/71	358	259	325	120	470	241	525	341	370	425
0362 52/72	458	359	425	220	570	341	625	441	470	525
0362 55/75	558	358	525	220	680	341	735	551	470	525
0362 56/76	664	468	600	200	789	441	844	641	579	634
0362 61/81	764	568	700	300	887	548	942	758	677	732
0362 63	964	768	900	500	1087	748	1142	958	877	932
0362 64	1164	768	1100	500	1287	748	1342	1158	877	932

1 : Use Cat. No. 0364 08 wall brackets. Others use Cat. No. 0364 09 wall brackets

Marina wall mounting enclosures

Polyester (GRP) IP 66 - IK 10 (continued)

Wall mounting brackets

Cat. No. 0364 08
for enclosures height 300 mm

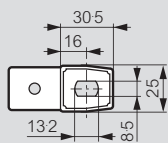

Cat. No. 0364 09
for enclosures height ≥ 400 mm

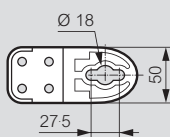

Wall fixing by threaded rods

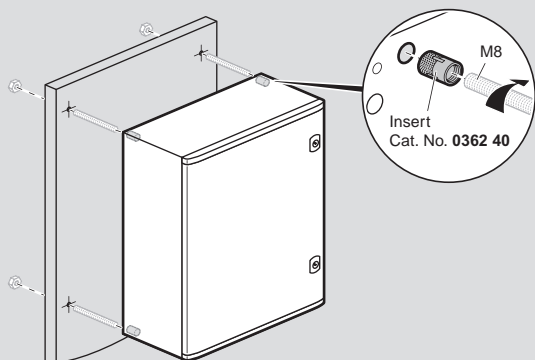

Floor fixing on plinth

H 170 mm (polyester RAL 7035)

Roof RAL 7035
Cat. Nos. 0362 93/94/95

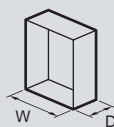

W (mm)	D (mm)
500	250
600	300
800	300

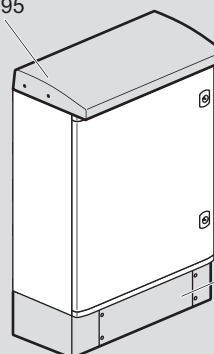

Plinth
Cat. Nos. 0362 91/92

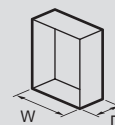

W (mm)	D (mm)
600	300
800	300

Marina free standing enclosures and equipment

Polyester (GRP) IP 66 - IK 10



Technical information and dimensions **p. 22**
 Locking accessories **p. 28**
 Ventilation and heating **p. 29-31**

Grey RAL 7035
 IP 66 according to IEC EN 60529
 IK 10 according to IEC EN 62262 (EN 50102)
 Class II insulation for final assembly according to IEC EN 60439-1
 Glass fibre reinforced polyester (GRP) enclosures
 Self extinguishing at 960 °C according to IEC EN 60695-2-11
 Designed for corrosive environments
 Stainless steel hinges and hinge pins
 Reversible door equipped with equipment mounting bosses
 Supplied with two part gland plate and fixing kit for plain plate or sectioned uprights
 Three point locking handle with European lock and 2433 A key¹
 Depth adjustment of equipment

Pack	Cat. Nos.	GRP enclosures			
		External dimensions (mm)			Weight (kg)
		Height	Width	Depth	
1	0362 85	1460	800	463 ²	49
1	0362 86	1660	800	463 ²	53
1	0362 87	1860	800	463 ²	57

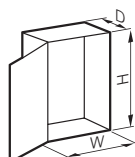

Pack	Cat. Nos.	Roof	
		For enclosures (mm)	
		Width	Depth
1	0362 97	800	463

Pack	Cat. Nos.	Plinth	
		For enclosures (mm)	
		Width	Depth
1	0362 96	800	463

Height 170 mm
 Front and rear access plates
 Stackable for extra height (2 max)

		Equipment		
		Plain plates		
		Galvanised steel. Premarked at 100 mm intervals Permissible load : 200 kg/m ²		
		For enclosures (mm)		Net weight (kg)
		Height	Width	
1	0349 59	1460	800	27
1	0349 50	1660	800	30.5
1	0344 18	1860	800	34

Pack	Cat. Nos.	Sectioned uprights	
		For enclosures	
		Height (mm)	Length (mm)
1	0363 90	1460	1284
1	0363 91	1660	1484
1	0363 92	1860	1684

For Lina 25 rail, Lina rail and Lina 12.5 or Lina 25 plates
 Set of 2 uprights galvanised steel

1 : Other barrels **p. 28**
 2 : 487 mm when handle in use

Marina free standing enclosures and equipment

Polyester (GRP) IP 66 - IK 10 (continued)

■ Dimensions and usable areas

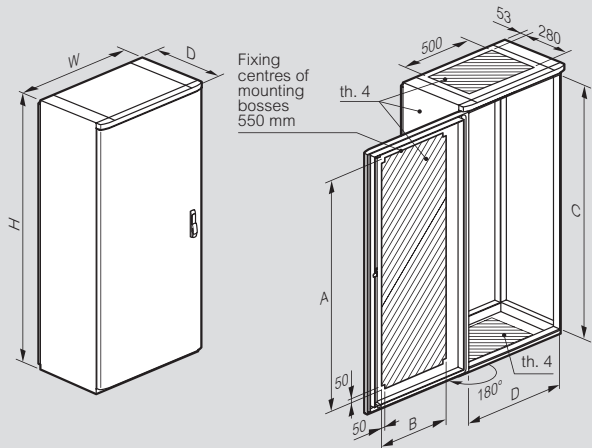

Cat. Nos.	Dimensions H x W x D (mm)	Usable area (mm)			
		A	B	C	D
0362 85	1460 x 800 x 463 ¹	1230	530	1300	700
0362 86	1660 x 800 x 463 ¹	1430	530	1500	700
0362 87	1860 x 800 x 463 ¹	1630	530	1700	700

1 : 487 mm when handle in use

■ Equipment fixing

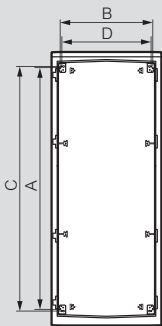

Cat. Nos.	Plain plate		Sectioned ¹ uprights	
	A	B	C	D
0362 85	1225	675	1250	630
0362 86	1425	675	1450	630
0362 87	1625	675	1650	630

1 : For mounting partial plates

Sectioned uprights are required to fix partial plates in the 1660 and 1860 mm enclosures – order separately

■ Equipment adjustment

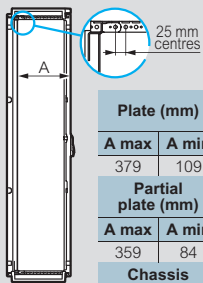
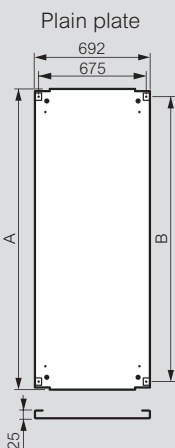

Plate (mm)	
A max	A min
379	109
Partial plate (mm)	
A max	A min
359	84
Chassis rail (mm)	
A max	A min
372	97

■ Mounting plates



Cat. Nos.	Enclosure height	Plain	
		A	B
0349 59	1460	1292	1225
0349 50	1660	1492	1425
0344 18	1860	1692	1625

■ Roof

Cat. No. 0362 97

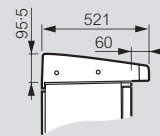

Weight : 2.5 kg
Width : 794 mm

■ Plinth

Cat. No. 0362 96

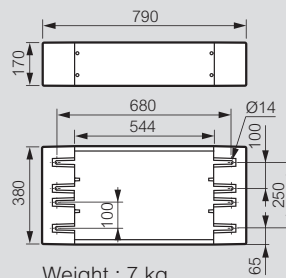

Weight : 7 kg

■ Sectioned uprights

Cat. Nos. 0363 90/91/92

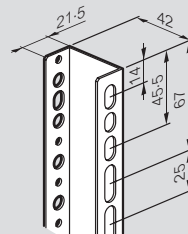

■ Suggested lifting method

4 x 500 kg slings and 4 brackets

A } 120° → 250 kg
90° → 300 kg
60° → 300 kg

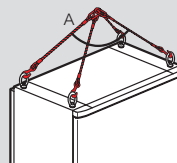

universal plates for wall mounting enclosures

Atlantic-E, Atlantic stainless steel and Marina



0360 55

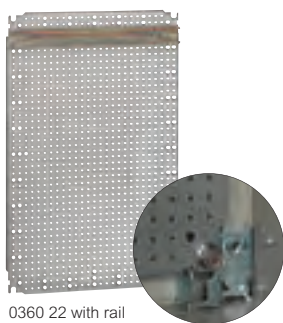

0360 22 with rail



0360 18

Technical information and dimensions **p. 24**

Fixing accessories are supplied in each enclosure

Pack	Cat. Nos.	Plain plates ¹		
		Pre-galvanised steel		
		2 mm thick up to 400 x 400 mm		
		3 mm thick from 400 x 600 mm		
		Vertical mounting for enclosures Height x Width (mm)	Weight (kg)	Horizontal mounting for enclosures Height x Width (mm)
1	0360 49 ²	300 x 220	0.9	
1	0360 52	400 x 300	1.3	300 x 400
1	0360 55	500 x 400	2.7	
1	0360 56	600 x 400	3.3	400 x 600
1	0360 58	700 x 500	6	
1	0360 59	800 x 600	8.4	600 x 800
1	0360 61	1000 x 800	14.4	800 x 1000
1	0360 64	1200 x 800	18.5	

Pack	Cat. Nos.	Lina 12.5 perforated plates		
		Pre-galvanised steel		
		2 mm thick		
		Ø 6.5 mm for rivets Cat. No. 0366 44		
		Ø 3.3 mm for equipment screws Cat. No. 0347 45		
		(see opposite)		
		Vertical mounting for enclosures Height x Width (mm)	Weight (kg)	Horizontal mounting for enclosures Height x Width (mm)
1	0360 00 ³	300 x 200	0.4	
1	0360 01 ²	300 x 220	0.47	
1	0360 02	300 x 300	0.6	
1	0360 04	400 x 300	0.8	300 x 400
1	0360 05	400 x 400	1.1	
1	0360 09	500 x 400	1.5	
1	0360 14	500 x 500	1.85	
1	0360 22	600 x 400	2.2	400 x 600
1	0360 24	600 x 600	3.7	
1	0360 31	700 x 500	3.7	
1	0360 33	800 x 600	5.2	600 x 800
1	0360 34	800 x 800	7	
1	0360 40	1000 x 600	6.8	600 x 1000
1	0360 42	1000 x 800	9.2	800 x 1000
1	0360 46	1200 x 800	11.1	

Pack	Cat. Nos.	Lina 25 perforated plates		
		Pre-galvanised steel		
		1.5 mm thick up to 600 x 400 mm		
		2 mm thick from 600 x 600 mm		
		Accepts clip nut fixings (see below)		
		Vertical mounting for enclosures Height x Width (mm)	Weight (kg)	
1	0360 07 ³	300 x 200	0.4	
1	0360 99	300 x 220	0.5	
1	0360 91	300 x 300	0.5	
1	0360 11	300 x 400	0.6	
1	0360 12	400 x 300	0.6	
1	0360 92	400 x 400	0.8	
1	0360 13	400 x 600	1.1	
1	0360 15	500 x 400	0.9	
1	0360 93	500 x 500	1.1	
1	0360 16	600 x 400	1.3	
1	0360 17	600 x 600	2.1	
1	0360 18	700 x 500	2	
1	0360 19	800 x 600	3.1	
1	0360 20	800 x 800	4	
1	0360 23	1000 x 600	3.7	
1	0360 21	1000 x 800	4.9	
1	0360 87	1200 x 800	7.1	

Pack	Cat. Nos.	Fixing accessories	
		For Lina 12.5 perforated plates	
500	0366 44	Insulated plastic rivets Ø 6 mm for 6 mm holes	
100	0347 45	Self piercing tapping hex head screws 4.8 x 16 mm for Ø 3.3 mm holes	
200	0347 50	Plastic insulating cap for above	
		For Lina 25 perforated plates	
		Supplied without screws	
100	0364 40	Clip nuts for M4 screw	
100	0364 42	Clip nuts for M6 screw	

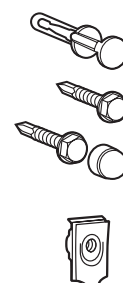

1 : Atlantic-E enclosures are supplied complete with removable plain plate
 2 : For Marina enclosure only
 3 : For Atlantic-E and Atlantic stainless steel enclosures

universal plates for wall mounting enclosures

Atlantic-E, Atlantic stainless steel and Marina (continued)

■ Mounting principle

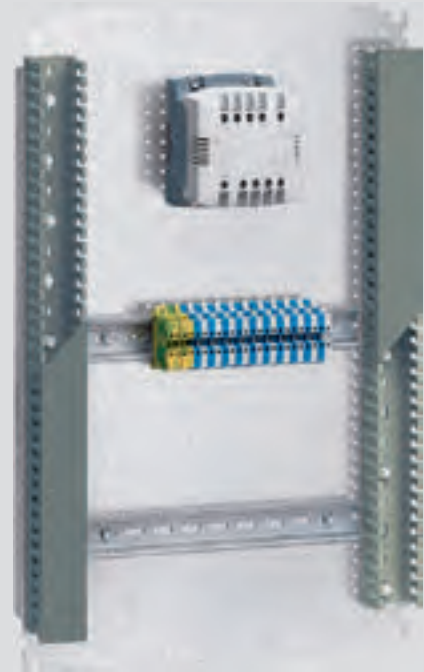
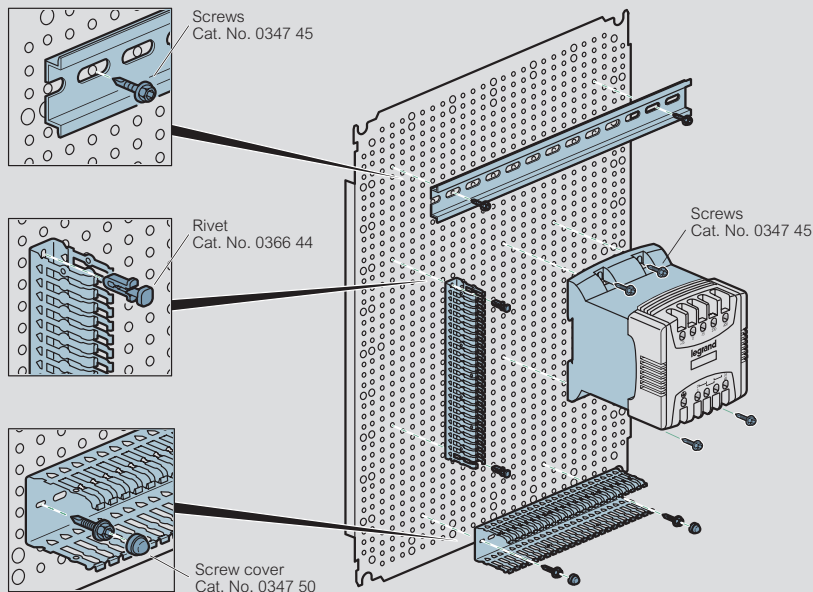

■ Dimensions

Plain plates, Lina 12-5 and Lina 25 perforated plates

Plain plate

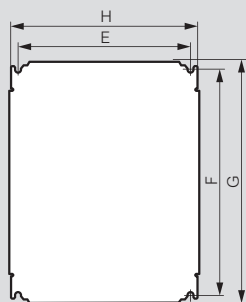

Lina 12-5 perforated plate

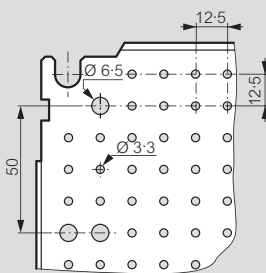

Lina 25 perforated plate

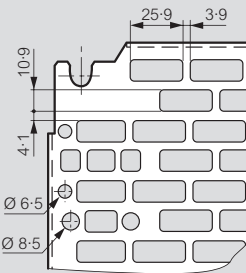

Fixing example on Lina 12-5 plate :

- of a transformer with screws Cat. No. 0347 45
- of a rail with Viking 3 terminals **p. 118**
- of Transcab panel trunking **p. 50**

Enclosure dimensions Height x Width (mm)	Dimensions of plates Plain / Lina 12-5 / 25 plates		Usable space for equipment (dm ²)	Mounting of plates	
	G (mm)	H (mm)		F (mm)	E (mm)
300 x 200	256	156	4.2	225	125
300 x 300	256	256	6.2	225	225
300 x 400 ¹	256	356	8.2	225	325
400 x 300 ¹	356	256	8.2	325	225
400 x 400	356	356	11.7	325	325
400 x 600 ¹	356	556	18.7	325	525
500 x 400	456	356	15.2	425	325
500 x 500	456	456	19.2	425	425
600 x 400 ¹	556	356	18.7	525	325
600 x 600	556	556	29.7	525	525
700 x 500	656	456	28.7	625	425
800 x 600 ¹	756	556	40.7	725	525
800 x 800	756	756	55.7	725	725
1000 x 600 ¹	956	556	51.7	925	525
1000 x 800 ¹	956	756	70.7	925	725
1200 x 800	1156	756	85.7	1125	725

Fixings **p. 23**



1 : For horizontal or vertical mounting

chassis and internal doors for wall mounting enclosures

Atlantic-E, Atlantic stainless steel and Marina



0361 03



0361 03 mounted in enclosure



Internal doors accept key barrel

Technical information and dimensions p. 27

Pack	Cat. Nos.	Insulated modular chassis
1	0361 01	<p>Grey RAL 7035 Separate ABS front plate per row Supplied in kit form with metal uprights and crosspieces Symmetrical rails ┘ depth 15 mm Fixings supplied with enclosure Self extinguishing 750 °C</p> <p>For enclosure dimensions Height x Width x Depth (mm)</p> <p>400 x 300 x 200</p> <p>30 modules (3 rows of 10) Supplied with 1 blanking plate</p>
1	0361 02	<p>500 x 400 x 200</p> <p>48 modules (3 rows of 16) Supplied with 1 blanking plate</p>
1	0361 03	<p>600 x 400 x 250</p> <p>48 modules (3 rows of 16) Supplied with 1 blanking plate</p>
1	0361 05	<p>700 x 500 x 250</p> <p>84 modules (4 rows of 21) Supplied with 1 blanking plate</p>
1	0361 06	<p>800 x 600 x 300</p> <p>108 modules (4 rows of 27) Supplied with 2 blanking plates</p>
1	0361 09	<p>1 000 x 800 x 300</p> <p>190 modules (5 rows of 38) Supplied with 2 blanking plates</p>
1	0361 10	<p>1 200 x 800 x 300</p> <p>228 modules (6 rows of 38) Supplied with 2 blanking plates</p>

Pack	Cat. Nos.	Blanking plate for windows
10	0361 00	<p>For enclosures up to 800 mm wide Blanking plate to suit up to 670 x 45 mm window To be cut to required length 38 modules, length 684 mm</p>

Pack	Cat. Nos.	Internal doors																								
1	0363 59	<p>Grey RAL 7035 - IP xxB Fit Marina enclosures Also suitable for Atlantic stainless steel enclosures when used with mounting kit Cat. No. 0363 69 Not compatible with Atlantic-E enclosures For mounting of control and signalling units Reversible, easy to fix, robust 4 mm thick GRP construction Left or right opening with built in grip Captive hinge pins Double bar lock : 1 lock for height 400 to 600 mm 2 locks for height ≥ 700 mm</p>																								
		<table border="1"> <thead> <tr> <th>For enclosures (mm) H x W</th> <th>Dim. (mm) H x W</th> <th>Usable area (mm) H x W</th> </tr> </thead> <tbody> <tr> <td>400 x 300</td> <td>341 x 236</td> <td>305 x 185</td> </tr> <tr> <td>500 x 400</td> <td>441 x 336</td> <td>405 x 250</td> </tr> <tr> <td>600 x 400</td> <td>541 x 336</td> <td>505 x 250</td> </tr> <tr> <td>700 x 500</td> <td>642 x 436</td> <td>500 x 340</td> </tr> <tr> <td>800 x 600</td> <td>742 x 536</td> <td>600 x 440</td> </tr> <tr> <td>1 000 x 800</td> <td>942 x 736</td> <td>800 x 640</td> </tr> <tr> <td>1 200 x 800</td> <td>942 x 736</td> <td>800 x 640</td> </tr> </tbody> </table>	For enclosures (mm) H x W	Dim. (mm) H x W	Usable area (mm) H x W	400 x 300	341 x 236	305 x 185	500 x 400	441 x 336	405 x 250	600 x 400	541 x 336	505 x 250	700 x 500	642 x 436	500 x 340	800 x 600	742 x 536	600 x 440	1 000 x 800	942 x 736	800 x 640	1 200 x 800	942 x 736	800 x 640
For enclosures (mm) H x W	Dim. (mm) H x W	Usable area (mm) H x W																								
400 x 300	341 x 236	305 x 185																								
500 x 400	441 x 336	405 x 250																								
600 x 400	541 x 336	505 x 250																								
700 x 500	642 x 436	500 x 340																								
800 x 600	742 x 536	600 x 440																								
1 000 x 800	942 x 736	800 x 640																								
1 200 x 800	942 x 736	800 x 640																								
1	0363 69	<p>Accessory Mounting kit for Atlantic stainless steel enclosures</p>																								

1 : Door identical to Cat. No. 0363 64 with 200 mm upper or lower reservation

equipment and fixing accessories for wall mounting enclosures

Atlantic-E, Atlantic stainless steel and Marina



Uprights + crosspieces (subject to size)
Pocket Cat. No. 0365 80



0365 81



0367 80



0364 40



0347 45



0366 44



0347 50

Technical information and dimensions p. 27

Pack	Cat. Nos.	Lina 25 sectioned uprights			Profile
		Set of 2 sectioned uprights For dimensions p. 27			
		For enclosures height (mm)	Length of uprights (mm)	Thickness (mm)	
5	0361 50	300	237	2.5	
5	0361 51	400	337	2.5	
5	0361 52	500	437	2.5	
5	0361 53	600	537	2.5	
5	0361 54	700	637	2.5	
5	0361 55	800	737	2.5	
5	0361 56	1000	937	2.5	
5	0361 58	1200	1137	2.5	

Pack	Cat. Nos.	Lina 25 crosspieces	
		Crosspieces ready to assemble (excluding fixings) For dimensions p. 27	
		For enclosures width (mm)	Crosspiece length (mm)
10	0367 80	300	243
10	0367 81	400	343
10	0367 82	500	443
10	0367 83	600	543
10	0367 84	800	743

Pack	Cat. Nos.	Rails	
		2 m length For dimensions p. 27	
10	0374 02		EN 60715
10	0374 07		Symmetrical, depth 15 mm

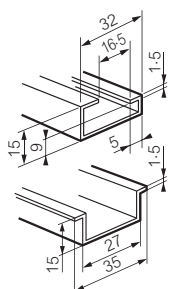

Pack	Cat. Nos.	45° mounting bracket	
10	0394 49	Set of 2 supports for tilting a rail at an angle of 45° Supplied with 4 x M6 screws, nuts and washers	

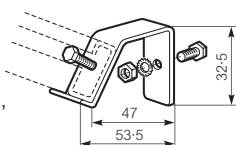

Pack	Cat. Nos.	Self-adhesive document pockets	
		RAL 7035	
		External dimensions (mm) Width x Height	Internal dimensions (mm) Width x Height x Depth
20	0365 80	340 x 235	310 x 200 x 18
20	0365 81	260 x 165	230 x 130 x 18

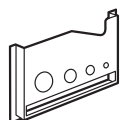

Pack	Cat. Nos.	Fixing accessories	
		For Lina 25 perforated plates Supplied without screws	
100	0364 40	Clip nuts for M4 screw	
100	0364 42	Clip nuts for M6 screw	
		For Lina 12.5 perforated plates	
500	0366 44	Insulated plastic rivets Ø 6 mm for 6 mm holes	
100	0347 45	Self piercing tapping hex head screws 4.8 x 16 mm for Ø 3.3 mm holes	
200	0347 50	Plastic insulating cap for above	
		For rails EN 60715	
100	0364 78	For M4 mm screw	
		For rail EN 60715	
10	0044 16	Claw width 10 mm Threaded hole for M4 screw	
10	0044 17	Claw width 17.5 mm Smooth hole Ø 3.8 mm Supplied with fixing screw Ø 3.5 mm Length 13 mm	
40	0364 69	Fixomega for M4 screw	

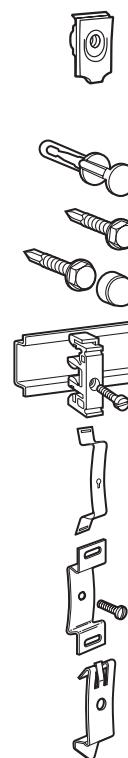

Lina perforated plates p. 23



equipment and fixing accessories for wall mounting enclosures

Atlantic-E, Atlantic stainless steel and Marina (continued)

Assembled chassis with crosspieces and Lina 25 uprights

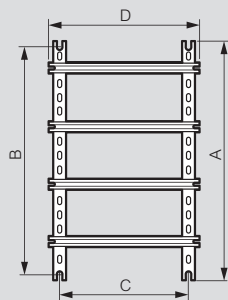

Enclosure dimensions Height x Width (mm)	Crosspiece length		Chassis fixing	
	A (mm)	D (mm)	B (mm)	C (mm)
300 x 300	237	243	225	225
300 x 400	237	343	225	325
400 x 300	337	243	325	225
400 x 400	337	343	325	325
400 x 600	337	543	325	525
500 x 400	437	343	425	325
500 x 500	437	443	425	425
600 x 400	537	343	525	325
600 x 600	537	543	525	525
700 x 500	637	443	625	425
800 x 600	737	543	725	525
800 x 800	737	743	725	725
1000 x 600	937	543	925	525
1000 x 800	937	743	925	725
1200 x 800	1137	743	1125	725

Lina 25 sectioned uprights

Cat. Nos. 0361 50/51/52/53/54/55/56

Cat. No. 0361 58

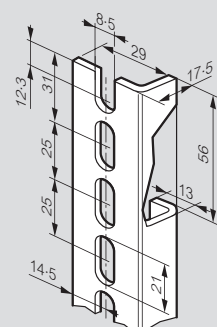
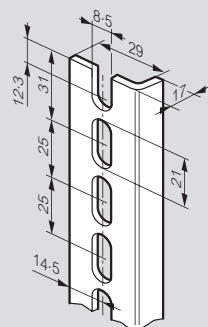

Crosspieces/rails

Cat. Nos. 0367 80/81/82/83/84

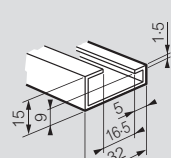
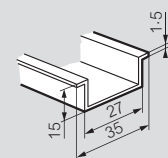

For crosspieces/rails **p. 26**

Clip nuts



For clip nuts **p. 26**

Insulated modular chassis

Fixes to corner fixings inside enclosure
Chassis can fit steel or polyster enclosures



Cat. No. 0361 03 fitted into enclosure

Space between door and chassis front

- Atlantic stainless steel } Depth 250 : 80 mm
- Marina } Depth 300 : 90 mm

The front sections can only be removed using a tool (flat blade screwdriver)

Glow wire tested : 5s at 750 °C

locking accessories

for Atlantic stainless steel and Marina enclosures

Lock housings for rebate or cylinder locks

Pack	Cat. Nos.	Description	Image
10	0368 04	Interchangeable for Atlantic stainless steel and Marina enclosures Plastic housing (excludes barrel and cam)	
10	0368 05	Handle With blank (excludes cam)	
10	0368 06	Handle Fitted with locking barrel 2433 A (excludes cam)	

Locking cams

10	0365 30	For Marina enclosures	
10	0368 43	For Atlantic stainless steel 1 door enclosures	
10	0368 44	For Atlantic stainless steel 2 door enclosures	

Note : Cam nuts are supplied with the handle or housing

Metal rebate lock barrels

10	0368 17	6.5 mm male triangle	
10	0368 18	8 mm male triangle	
10	0368 19	11 mm male triangle	
10	0368 20	Double bar	

Key barrels

		Supplied with set of 2 keys For key No :	
10	0368 22	405	
10	0368 23	421	
10	0368 24	455	
10	0368 25	1242 E	
10	0368 26	2433 A	
10	0368 27	3113 A	
10	0365 45	Set of two 2433 A keys	

Keys for rebate locks

10	0365 39	For 6.5 mm male triangle lock	
10	0365 40	For 8 mm male triangle lock	
10	0365 41	For 11 mm male triangle lock	
10	0365 42	For double bar	

Padlocking

		Padlock adaptor	
1	0365 11	Metal painted black-grey RAL 7021 Fits over door handles to provide security Accepts up to 3 padlocks (not included)	

Universal locking system¹

The locks can be assembled and fitted to all Atlantic stainless steel and Marina enclosures

Lock barrels

6.5 mm triangle male
Cat. No. 0368 17

8 mm male triangle
Cat. No. 0368 18

11 mm male triangle
Cat. No. 0368 19

Double bar
Cat. No. 0368 20

Detail of cut-out

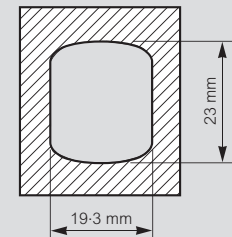

Key barrels

No. 405
Cat. No. 0368 22

No. 421
Cat. No. 0368 23

No. 455
Cat. No. 0368 24

1242 E
Cat. No. 0368 25

2433 A
Cat. No. 0368 26

3113 A
Cat. No. 0368 27



Dimensions of special triangle locks

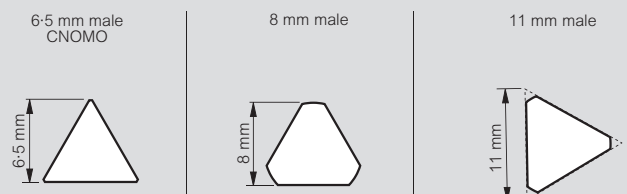

1 : The metal locks (special barrels and key barrels) and lock barrels are all compatible with each other

ventilation for enclosures

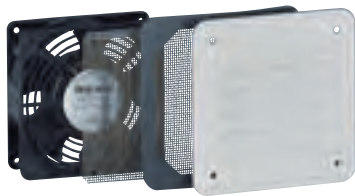

0348 17



0365 79



0348 04



0348 52



0348 89



0348 05



0348 35

Technical information and dimensions p. 30

Pack	Cat. Nos.	Ventilation fan kit with metal grill
1	0348 17	<p>IP 32 - IK 10 230 V - 50/60 Hz RAL 7035 Ventilator is mounted on the outside of the enclosure 30 m³/h with filter - 160 m³/h without filter installed (free flowing) Pack comprising a pair of metal RAL 7035 louvres and a pair of anti-insect grills, plus internal finger protection</p>

Pack	Cat. Nos.	Ventilation fan kits with plastic grill
1	0348 50	<p>IP 54 - IK 08 230 V - 50/60 Hz RAL 7035 plastic housing Supplied with finger protection guards External projection 7-10 mm Accepts mounting spacer Cat. No. 0348 88/89 Used to reduce internal projection and improve wiring space Fitted externally on to the enclosure with rapid fix screws 1 mm to 4 mm panel thickness An extra louvre can be fitted to improve air flow and extraction</p> <p>40/160 m³/h 40 m³ with filter 45 m³ with extra grill/filter Cat. No. 0348 34 160 m³ without filter installed (free flowing) Pack comprising a pair of RAL 7035 plastic grills 150 x 150 mm and washable electrostatic filter EU3, G3</p>
1	0348 51	<p>120/160 m³/h 120 m³ with filter 130 m³ with extra grill/filter Cat. No. 0348 35 160 m³ without filter installed (free flowing) Pack comprising a pair of RAL 7035 plastic grills 250 x 250 mm and washable filter EU3, G3</p>
1	0348 52	<p>240/450 m³/h 240 m³ with filter 260 m³ with extra grill/filter Cat. No. 0348 35 450 m³ without filter installed (free flowing) Pack comprising a pair of RAL 7035 plastic grills 250 x 250 mm and washable filter EU3, G3</p>

Pack	Cat. Nos.	Spacers for ventilation fan kits
1	0348 88	IP 54 maintained RAL 7035 Used to reduce the internal projection and increase the internal usable volume 150 x 150 mm
1	0348 89	250 x 250 mm

Pack	Cat. Nos.	Natural ventilation
2	0365 78	Ventilation glands IP 44 - IK 08 for outdoor use Grey polyamide Ø 15 mm aperture needed
2	0365 79	Ø 30.5 mm aperture needed
1	0348 04	Ventilation louvres - metal IP 32 - IK 10 RAL 7035 Pack comprising a pair of metal louvres and a pair of anti-insect grills 138 x 138 mm
1	0348 05	248 x 248 mm
1	0348 34	Ventilation louvres - plastic RAL 7035 Supplied singly Supplied with 10 mm thick filter EU 3, G3 IP 44 - 150 x 150 mm
1	0348 35	Supplied with 20 mm thick filter EU 3, G3 IP 54 - 250 x 250 mm
1	0348 36	IP 54 - 325 x 325 mm

Heating p. 31



Operating principle

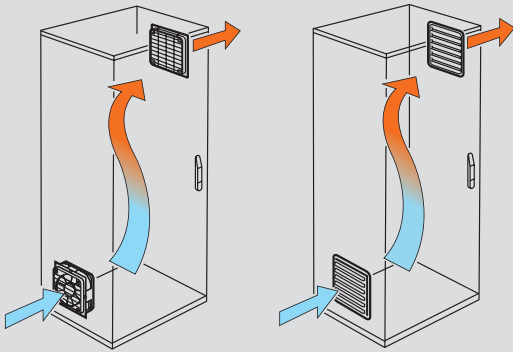

Ventilators, louvres and spacers

Natural ventilation

Ventilation fan kits, louvres and spacers

Dimensions and cut-outs

Cat. No. 0348 17

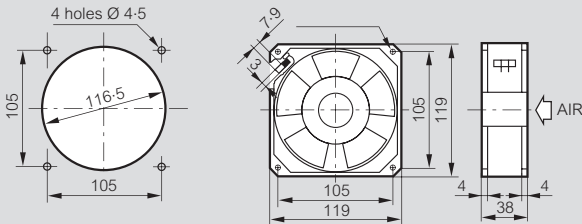

Cat. Nos. 0348 50/51/52/34/35/36

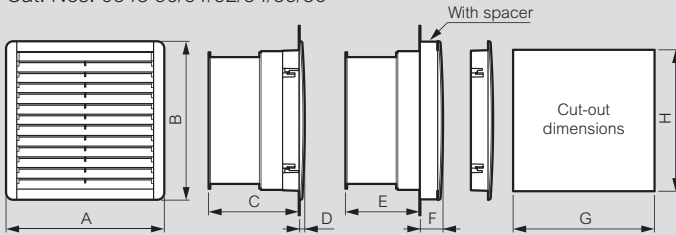

Cat. Nos.	A (mm)	B (mm)	C (mm)	D (mm)	E (mm)	F (mm)	G (mm)	H (mm)
0348 50	150	150	70	7	43	34	125	125
0348 51	250	250	105	8	78	35	223	223
0348 52	250	250	123	8	96	35	223	223
0348 34	150	150	-	7	-	34	125	125
0348 35	250	250	-	8	-	35	223	223
0348 36	325	325	-	10	-	37	291	291

Technical characteristics

Cat. Nos.	0348 17	0348 50	0348 51	0348 52
Voltage (V)/phase	220-240/1	230/1	230/1	220-240/1
Frequency (Hz)	50/60	50/60	50/60	50/60
No load flow ventilation only (m ³ /h)	160	160	160	240
On load flow - with an output louvre (supplied)	30	40	100	170
Static pressure (mm of water)	100	66	51	111
Power down (W)	22	20	20	29
Current down (A)	0.14	0.125	0.125	0.426
Operating temperature	-10°C/+50°C			
IP/IK	32/10	54/08	54/08	54/08
Sound level (dB)	49	43	43	50
Weight (kg)	0.72	0.8	1.4	1.7

Natural ventilation

Dimensions and cut-outs

Cat. No. 0348 04

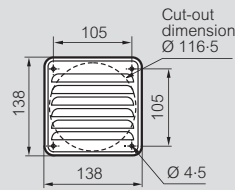

Cat. No. 0348 05

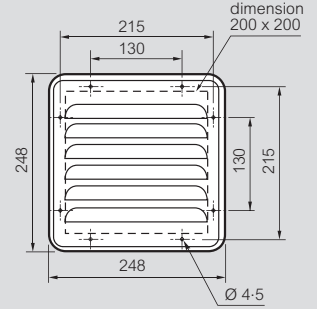

Cat. No. 0365 78

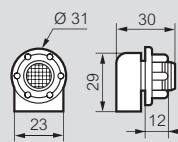

Cat. No. 0365 79

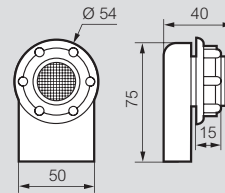

heating for enclosures



0353 08



0348 47

Technical information and dimensions **opposite**

Pack	Cat. Nos.	Heating
		Resistance heaters 120 V / 240 V ~
		IP 20 Prevent condensation forming inside the enclosure " PTC " auto-regulated and surface temperature limited : t = 70 °C Heat dissipator in black aluminium oxide Fix on rail
		Power Current rating
1	0353 06	20 W 2.5 A
1	0353 07	50 W 2.5 A
1	0353 08	100 W 4.5 A
1	0353 09	150 W 8.0 A
		Thermostat
		Precision 0.5 °C (neutral connected) Switching and control range : 2 °C 230 V - 50/60 Hz 12 to 250 V~ (requires neutral) Contact rating : 10 A max. (5 A closing) NO contact : 10 A, 250 V~ NC contact : 5 A, 250 V~ Adjustable from 5 to 60 °C with NO/NC contact
1	0348 47	Fix on rail

Operating principle

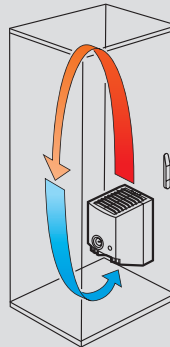

Heating

Dimensions

Resistance heaters

Cat. Nos. 0353 06/07/08/09

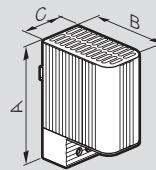

Cat. Nos.	Power	A	B	C
0353 06	20 W	98	75	38
0353 07	50 W	110	90	60
0353 08	100 W	110	90	60
0353 09	150 W	150	90	60

Vertical installation at the bottom of the enclosure
Air circulation :
- ensure clearance >50 mm all round the device
- do not cover

Thermostat

Cat. No. 0348 47

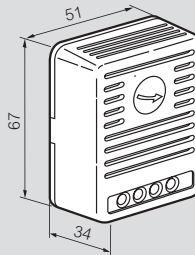

Vertical installation at the bottom of the enclosure
Recommended clearance around heat regulation products for optimal air circulation :
- ensure clearance >50 mm all round the device
- do not cover

Wiring diagram

Cat. Nos. 0353 07/08/09

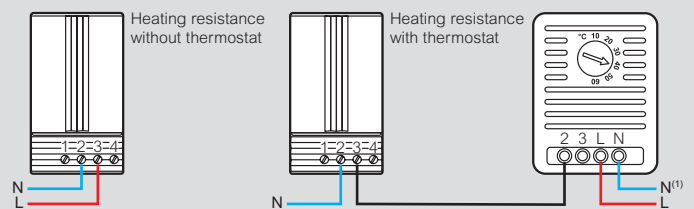

Cat. No. 0353 06

Thermostat Cat. No. 0348 47

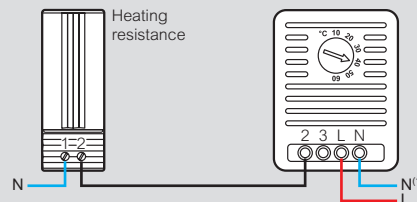

1 : Connection accelerating resistance

Ventilation p. 29-30



Tough Plexo³ weatherproof enclosures

Your DIN rail equipment is in safe hands with Plexo³. House up to 72 modules over 4 rows in this fully reversible, fully reliable range of enclosures.

FULLY REVERSIBLE
ENCLOSURE
AND DOOR

STRONG AND WEATHERPROOF



IP 65: weatherproofing and UV treatment guaranteed for applications in damp places



IK 09: enhanced impact resistance (shock-resistant polystyrene)



Double closing point to ensure a good seal

FAST, SIMPLE INSTALLATION



Removable faceplate: easier maintenance on individual rows



Rails can be removed one by one



Removable chassis for wiring outside the enclosure

CLEVER, TIME SAVING ACCESSORIES



Knockout cable entries at the top and bottom of the enclosure



Cable glands can be fitted according to your requirements



Hinged doors open fully for easy access to cables

Plexo³ weatherproof enclosures and accessories

IP 65 - IK 09

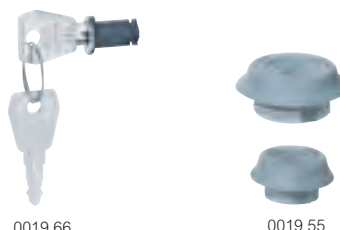
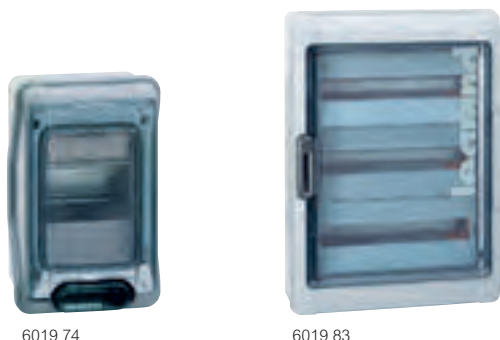

Technical information and dimensions **p. 34**

IP 65 - IK 09 - Class II
 Self-extinguishing : resistance to incandescent wire 650 °C
 Conform to EN 60439-3
 Door and enclosure fully reversible
 Removable chassis and faceplates from 2 row versions up
 2 position rail for modular products and moulded cases
 Spacing between rails 150 mm
 Can be fitted with perforated plates and solid faceplates for mounting non-modular products
 Lockable door handle, sealable cover and faceplate
 Shock-resistant polystyrene material
 Box colour light grey L750A, cover colour dark grey R746A
 Supplied with earth and neutral terminal blocks (except Cat. No. 6019 32)

Pack	Cat. Nos.	Enclosures 2 to 8 modules per row	
		Number of rows	Number of modules
1	6019 32	1	2 (+1)
1	6019 74	1	4
1	6019 76	1	6
1	6019 78	1	8

Pack	Cat. Nos.	Enclosures 12 modules per row	
		Number of rows	Number of modules
1	6019 81	1	12
1	6019 82	2	24
1	6019 83	3	36

Pack	Cat. Nos.	Enclosures 18 modules per row	
		Number of rows	Number of modules
1	6019 85	1	18
1	6019 86	2	36
1	6019 87	3	54
1	6019 88	4	72

Pack	Cat. Nos.	Accessories	
		Installation supports for terminal blocks	
		Set of 2 supports for mounting additional terminal blocks or empty supports for screw terminal blocks into Plexo ³ enclosures	
1	0019 72	For 1 and 2 row enclosures, 12 and 18 modules per row	
1	0019 73	For 3 and 4 row enclosures, 12 and 18 modules per row	
		Key lock	
1	0019 66	N° 850	
		Sealing kit	
1	0019 68	Set of 2 sealable terminal shields for cover and 8 sealable supports for faceplate	
		Wall mounting brackets	
1	0019 69	Set of 4	
		Blanking plates	
20	0019 61	5, separable into modules or 1/2 module Grey R746A	
		Direct piercing end caps	
1	0019 55	Pack consisting of 2 32Ø mm ISO end caps, 5 Ø25 mm ISO end caps and 10 Ø20 mm ISO end caps	
		Plain faceplates	
2	0019 64	For 12 modules enclosure	
2	0019 65	For 18 modules enclosure	
		Perforated plates	
		Allow the DIN rail to be replaced with a Lina 25 plate when integrating non-modular products	
2	0019 62	For 12 modules enclosure Height 150 mm	
2	4018 53	For 18 modules enclosure Height 150 mm	
		ISO M20 cable gland	
25	0980 03	Cable gland IP68	



IP 2X terminal blocks **p. 42**



Plexo³ weatherproof enclosures and accessories

IP 65 - IK 09 (continued)

■ Dimensions

Enclosures 2, 4, 6 and 8 modules per row

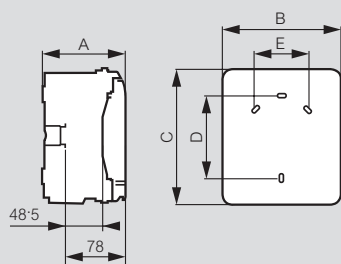

Cat. Nos.	Dimensions (mm)				
	A	B	C	D	E
6019 32	109	93	174	94	–
6019 74	115.6	128	200	120	–
6019 76	115.6	164	200	120	70
6019 78	115.6	200	200	120	106

Enclosures 12 and 18 modules per row

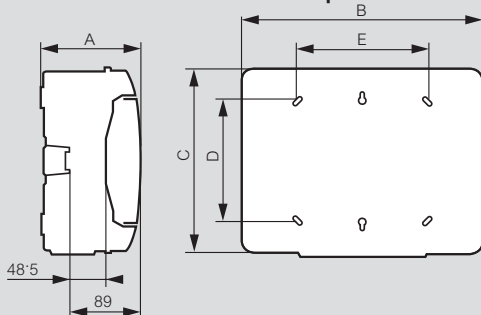

Cat. Nos.	Dimensions (mm)				
	A	B	C	D	E
6019 81	141	340	282	180	180
6019 82	161	340	432	330	180
6019 83	161	340	622	480	180
6019 85	141	448	282	180	288
6019 86	161	448	432	330	290
6019 87	161	448	622	480	290
6019 88	161	448	822	680	290

■ Fixing centres

Fixing the enclosure on the wall

Each enclosure is equipped with knockout entries for 2 wall fixing methods :

Hanging fixing

1 point in the middle, 2 points at the bottom

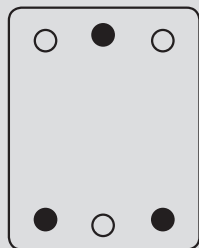

Adjustable peripheral fixing

4 fixing points

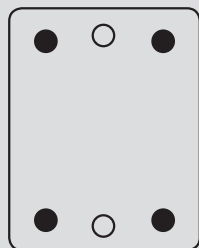

■ Number of knockouts on each side

Cat. Nos.	Top/bottom			Left/right		
	Ø20 mm	Ø25 mm	Ø32 mm	Ø20 mm	Ø25 mm	Ø32 mm
6019 32	2	–	–	–	–	–
6019 74	2	1	–	2	–	–
6019 76	4	1	–	2	–	–
6019 78	6	1	–	2	–	–
6019 81	7	2	2	–	–	2
6019 82	13	2	2	–	–	3
6019 83	13	2	2	–	–	4
6019 85	12	2	3	–	–	2
6019 86	13	4	3	–	–	3
6019 87	13	4	3	–	–	4
6019 88	13	4	3	–	–	5

■ Direct piercing end caps

Cat. No.	Type	Number of end caps per pack	Ø	
			Min. (mm)	Max. (mm)
0019 55	ISO 20	10	4	13
	ISO 25	5	9	18
	ISO 32	2	12	25

terminal shield boxes

with rail



0013 01 0013 04 0013 06 0013 08

Pack	Cat. Nos.	Terminal shield boxes
		Distribution boxes - 1 to 9 modules
		IP 30 - IK 05
		Conform to IEC 60439-3
		White RAL 9010
		Self-extinguishing
		Supplied with terminal block (box for 6 modules or more)
		Covers can be sealed and clipped on directly (except for box for 9 modules)
		Capacity in 17.5 mm modules
		Dimensions (mm) Height x Width x Depth
10	0013 01	1 140 x 30 x 72
10	0013 02	2 140 x 50 x 72
10	0013 04	4 160 x 90 x 74
5	0013 06	6 160 x 128 x 74
1	0013 08	(8 + 1) 180 x 190 x 83
10	0013 98	Membrane gland for boxes Cat. Nos. 0013 01 to 08

Dimensions

Cat. Nos. 0013 01/02/04/06/08

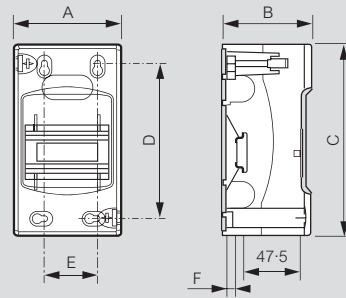

Cat. Nos.	A (mm)	B (mm)	C (mm)	D (mm)	E (mm)	F (mm)
0013 01	30	72	140	120	10	7
0013 02	50	72	140	115	25	7
0013 04	90	74	160	130	45	7
0013 06	128	74	160	125	80	7
0013 08	190	83	180	130	120	14.5

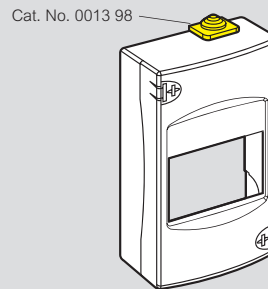

Entry via tube or cable

Plexo weatherproof boxes

selection chart

DIMENSIONS	CABLE ENTRY	INDUSTRIAL BOXES				ACCESSORIES		
		With IP 55 plain clip-on covers	With IP 55 covers		With IP 55 plain hinged covers - 2 x 1/4 turn fixings	With IP 66 plain covers	Mounting plates	Hinge kit accessories
 Internal dimensions (mm) Height x Width x Depth	Cable entry type 							
			Plain	Transparent				
Ø 60 x 40	membrane	0921 00	-	-	-	-	-	-
Ø 70 x 45	membrane	0921 01	-	-	-	-	-	-
65 x 65 x 40	membrane	0921 04	-	-	-	-	-	-
80 x 80 x 45	none	0921 28	-	-	-	-	-	-
80 x 80 x 45	membrane	0921 26	-	-	-	-	-	-
80 x 80 x 45	knockout	0921 27	-	-	-	-	-	-
105 x 105 x 55	membrane	-	0921 36	-	-	-	-	-
105 x 105 x 55	none	-	0921 38	-	-	-	-	-
105 x 105 x 55	knockout	-	0921 37	-	-	-	-	-
130 x 75 x 74	none	-	0359 00	-	-	0350 07	-	-
130 x 130 x 74	membrane	-	0920 32	-	-	-	0358 10	-
130 x 130 x 74	none	-	0359 30	-	-	0350 13	0358 10	0358 00
155 x 110 x 74	membrane	-	0920 42	-	-	-	0358 11	-
155 x 110 x 74	none	-	0359 40	-	-	0350 17	0358 11	0358 00
180 x 140 x 86	none	-	0359 50	0359 51	-	0350 22	0358 12	0358 00
220 x 170 x 86	none	-	0359 60	0359 61	-	0350 28	0358 13	0358 00
220 x 170 x 140	none	-	-	-	0921 22	-	0350 90	-
265 x 174 x 154	none	-	-	-	0350 43	-	0350 92	-
270 x 170 x 86	none	-	0359 70	0359 71	-	0350 33	0358 14	0358 00
310 x 240 x 124	none	-	0359 80	-	-	0350 44	0358 15	0358 01
310 x 240 x 160	none	-	-	-	0922 84	-	0350 93	-
359 x 265 x 154	none	-	-	-	0350 58	-	0350 94	-
360 x 270 x 124	none	-	0359 90	-	-	0350 47	0358 16	0358 01

Plexo weatherproof boxes

IP 55 - IK 07

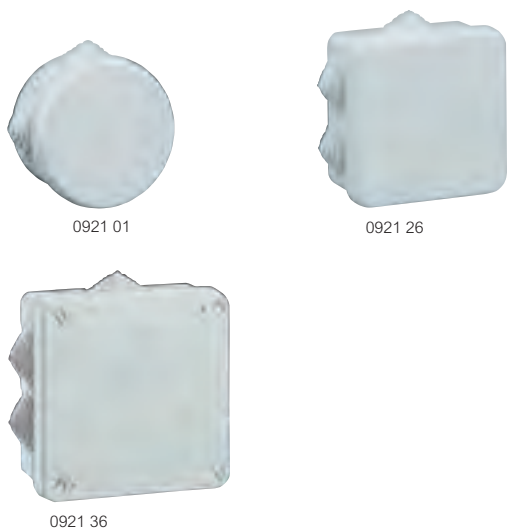

Dimensions **opposite**

IP 55 - IK 07
 Grey RAL 7035
 Conform to EN 60695-2-1
 Polystyrene box and polypropylene cover - halogen free
 Temperature rating : -25 °C to +40 °C
 Self-extinguishing 650 °C
 Membrane glands
 Plain cover

Pack	Cat. Nos.	Weatherproof boxes – round
5	0921 00	With fixing slots for easy alignment Use 5 mm Ø screws Clip-on cover Nominal internal dimensions : Ø x Depth Ø 60 mm x 40 mm 4 glands
5	0921 01	Ø 70 mm x 45 mm 4 glands

Pack	Cat. Nos.	Weatherproof boxes – square
5	0921 04	With fixing slots for easy alignment Use 5 mm Ø screws Clip-on cover Nominal internal dimensions : Height x Width x Depth 65 x 65 x 40 mm 7 glands
5	0921 26	80 x 80 x 45 mm 7 glands
5	0921 27	80 x 80 x 45 mm With pre-cut knockouts

Pack	Cat. Nos.	Weatherproof boxes – square class II
5	0921 36	Mounting by : • either internal fixing points - use 5 mm Ø screws • or at three corners outside the wiring area Use 4 mm Ø screws Provision for anti-tamper seal Cover with 4 x 1/4 turn fixings, indicated I-O, can be retained open during installation Nominal internal dimensions : Height x Width x Depth 105 x 105 x 55 mm 7 glands
5	0921 37	105 x 105 x 55 mm With pre-cut knockouts

■ Dimensions (mm)

Cat. Nos. 0921 00/01

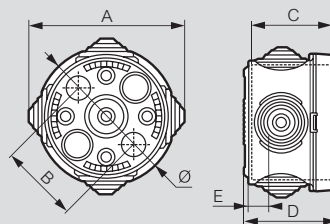

Cat. Nos.	Ø (mm)	A (mm)	B (mm)	C (mm)	D (mm)	E (mm)
0921 00	60	79	40	44.5	40	11
0921 01	70	86	50	49.5	45	11

Cat. No. 0921 04

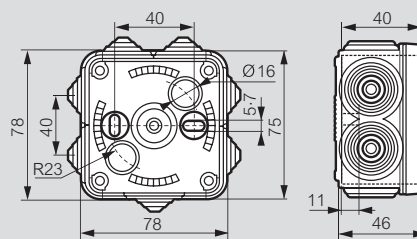

Cat. Nos. 0921 26/27

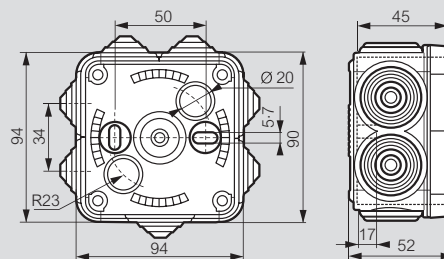

Cat. Nos. 0921 36/37

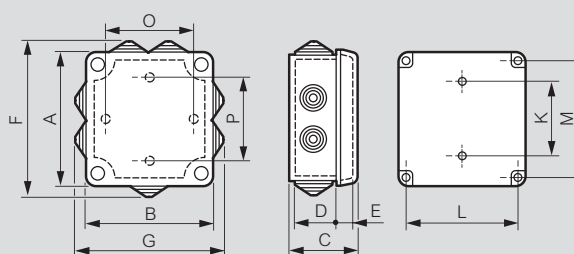

Cat. Nos.	A	B	F	G	C	D	E	Fixing of box			S dm ²	Fixing of accessories (screw Ø4 mm)	
								K	L	M		O	P
0921 36	116	116	132	132	60	41.8	13.4	50	95	95	1.34	80	80
0921 37	116	116	121	121	60	41.8	13.4	50	95	95	1.34	80	80

Plexo weatherproof boxes

IP 55 - IK 07

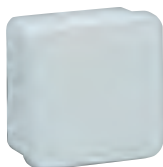

0921 28



0359 40

Technical information and dimensions p. 39

IP 55 - IK 07
 Grey RAL 7035
 Conform to EN 60695-2-1
 Temperature rating : - 25 °C to + 40 °C
 Undrilled with smooth sides

Pack	Cat. Nos.	Weatherproof boxes – class II
		Self-extinguishing 650 °C Polystyrene box and polypropylene cover - halogen free With fixing slots for easy alignment - use 5 mm Ø screws Clip-on plain cover Mounting by : • either internal fixing points - use 5 mm Ø screws • or at three corners outside the wiring area - use 4 mm Ø screws Provision for anti-tamper seal Cover with 4 x 1/4 turn fixings, indicated I-O, can be retained open during installation Nominal internal dimensions : Height x Width x Depth (mm)
5	0921 28	80 x 80 x 45
5	0921 38	105 x 105 x 55

Pack	Cover		Weatherproof boxes – class II
	Plain	Transparent	
1	0359 00		Self-extinguishing 750 °C Polypropylene box Plain cover : polypropylene ³ Transparent cover : polycarbonate Halogen free Class II protection ensured by the mounting screw protection plugs Detachable clip-on cover retainer (except 310 x 240 and 360 x 270 boxes) Side mounts for IP 2X terminals provided (except for 130 x 75 x 74 mm boxes) 1/4 turn fixings to seal cover With fixing slots for easy alignment Option mounting equipment on rail or plain plate Nominal internal dimensions : Height x Width x Depth (mm)
1	0359 30 ¹		130 x 75 x 74
1	0920 32		130 x 130 x 74
1	0920 32		130 x 130 x 74 (10 membrane gland fitted for 4-25 mm cable or conduit)
1	0359 40 ¹		155 x 110 x 74
1	0920 42		155 x 110 x 74 (10 membrane gland fitted for 4-25 mm cable or conduit)
1	0359 50 ¹	0359 51 ¹	180 x 140 x 86
1	0359 60 ¹	0359 61 ¹	220 x 170 x 86
1	0359 70 ²	0359 71 ²	270 x 170 x 86
1	0359 80 ²		310 x 240 x 124
1	0359 90 ²		360 x 270 x 124

Plexo weatherproof boxes

IP 66 - IK 08



0350 13



0350 28



0358 00

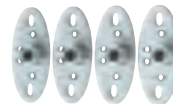

0358 02

Technical information and dimensions p. 39

Pack	Cat. Nos.	Weatherproof boxes – class II 500 V
		IP 66 - IK 08 Grey TO 29 Conform to EN 60695-2-1 Temperature rating : - 25 °C to + 80 °C Undrilled with smooth sides Self-extinguishing 750 °C Polycarbonate - halogen free Detachable clip-on cover retainer (except for 310 x 240 and 360 x 270 mm boxes) Side mounts for IP 2X terminals provided (except for 130 x 75 x 74 mm boxes) Sealable plain cover with captive 1/4 turn fixings Nominal internal dimensions : Height x Width x Depth (mm)
1	0350 07	130 x 75 x 74
1	0350 13 ¹	130 x 130 x 74
1	0350 17 ¹	155 x 110 x 74
1	0350 22 ¹	180 x 140 x 86
1	0350 28 ¹	220 x 170 x 86
1	0350 33 ²	270 x 170 x 86
1	0350 44 ²	310 x 240 x 124
1	0350 47 ²	360 x 270 x 124

Pack	Cat. Nos.	Accessories	
		Metal mounting plates	Set of 2 hinges ¹
		Galvanised steel - 1.5 mm thick For box size :	
5	0358 10	130 x 130 mm	
5	0358 11	155 x 110 mm	
5	0358 12	180 x 140 mm	
5	0358 13	220 x 170 mm	
5	0358 14	270 x 170 mm	
5	0358 15	310 x 240 mm	
5	0358 16	360 x 270 mm	
		Set of 4 wall mounting brackets	
1	0358 00	UV protected polyamide in dark grey (RAL 7016) For box 130 x 130 mm to 270 x 170 mm	
1	0358 01	For box 310 x 240 mm to 360 x 270 mm	
1	0358 02	For boxes from width 110 mm For wall fixing, supplied with screws	

1 : Not suitable for PVC range

Nylbloc terminal strips p. 41
 Distribution blocks p. 42-45

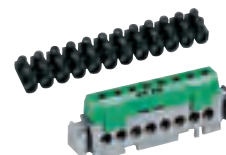

1 : Accepts Cat. No. 0358 00 hinges
 2 : Accepts Cat. No. 0358 01 hinges
 3 : Except Cat. No. 0359 80 : polycarbonate

Plexo weatherproof boxes

IP 55 - IK 07 and IP 66 - IK 08

■ Dimensions (mm)

Cat. No. 0921 28

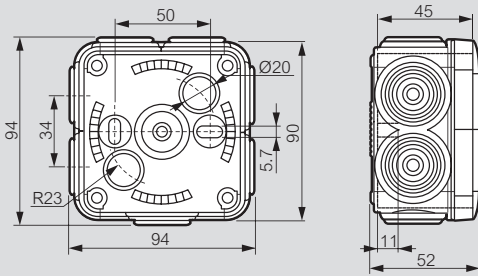

Cat. No. 0921 38

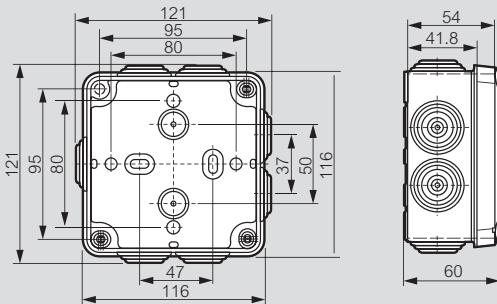

Boxes IP 55 – IK 07 and IP 66 – IK 08

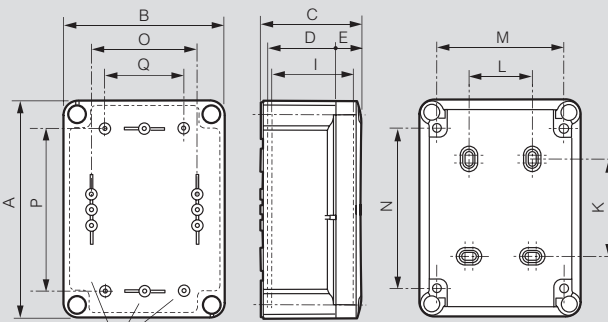

Fixings for accessories (screw Ø 4 mm)

Boxes	Dimensions (mm)						Fixing points (mm)					Fixing accessories (screw Ø 4 mm)	
Cat. Nos.	A	B	C	D	E	I	K	L	M	N	O	P	Q
0359 00 0350 07 ¹	140	85	81	56	18	67	70	-	65	120	51	106	-
0359 30 0350 13	150	150	81	56	18	67	54	70	120	103	106	106	84
0359 40 0350 17	175	130	81	56	18	67	79	50	100	128	86	131	64
0359 50/51 0350 22	200	160	94	69	18	80	104	50	130	153	116	156	94
0359 60/61 0350 28	240	190	94	69	18	80	144	80	160	193	146	196	124
0359 70/71 0350 33	290	190	94	69	18	80	194	80	160	243	146	246	122
0359 80 0350 44	332	262	132	97	27	116	220	160	222	276	200	260	150
0359 90 0350 47	382	292	132	97	27	116	270	190	252	326	230	310	150

1 : Not suitable for direct mounting of IP 2X terminals, use with DIN rail or 12 x 2 mm metal rail (Cat. No. 0048 19 p. 42)

Cat. Nos. 0920 32 and 0920 42

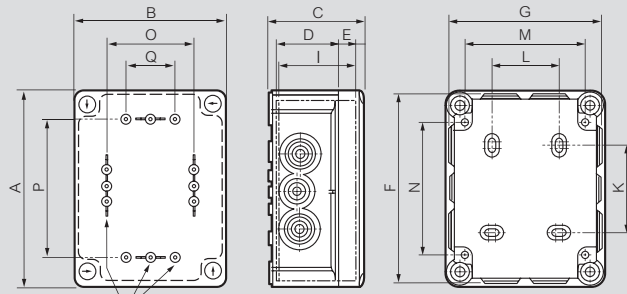

Fixings for accessories (screw Ø 4 mm)

Boxes	Dimensions (mm)							Fixing points (mm)					Fixing accessories (screw Ø 4 mm)		
Cat. Nos.	A	B	C	D	E	I	F	G	K	L	M	N	O	P	Q
0920 32	150	150	81	56	18	67	149	149	54	70	120	103	106	106	84
0920 42	175	130	81	56	18	67	173	128	79	50	100	128	86	131	64

■ Metal mounting plates

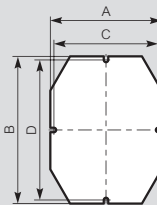

Cat. Nos.	A (mm)	B (mm)	C (mm)	D (mm)
0358 10	114	114	106	106
0358 11	94	139	86	131
0358 12	124	164	116	156
0358 13	154	204	146	196
0358 14	154	254	146	246
0358 15	211	271	200	260
0358 16	241	321	230	310

■ IP 2X terminal acceptance² chart see p. 43

Not suitable for direct mounting on to PVC range nor 130 x 75 x 74 mm boxes

Boxes	4 way	8 way	13 way	17 way	22 way	28 way
130 x 130 x 74	x	x	-	-	-	-
155 x 110 x 74	x	x	x	-	-	-
180 x 140 x 86	x	x	x	-	-	-
220 x 170 x 86	x	x	x	x	x	-
310 x 240 x 124	x	x	x	x	x	x
360 x 270 x 124	x	x	x	x	x	x

2 : Also accepts partly shrouded terminals

■ Thickness of walls

Up to 270 x 170 box = 2 mm
Above this size = 3 mm

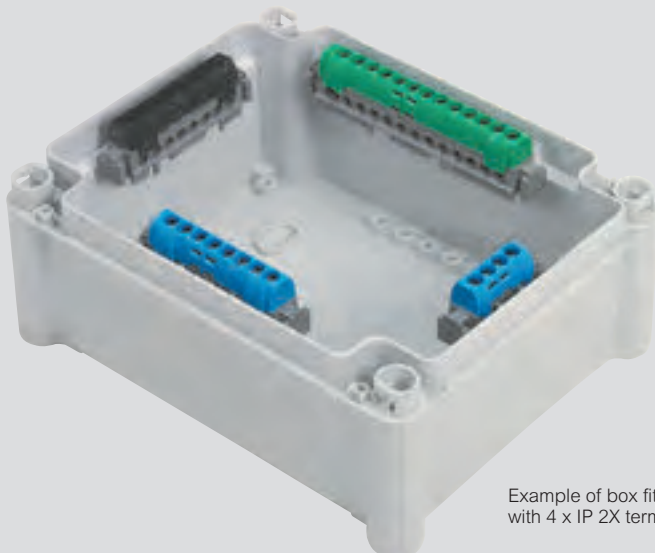

Example of box fitted with 4 x IP 2X terminals

Plexo weatherproof boxes

increased depth PVC range



0921 22

0350 43

Dimensions opposite and p. 41

Grey RAL 7035

Operating temperature : - 20 °C to +50 °C

PVC box and cover

Self-extinguishing : 750 °C for Cat. Nos. 0350 43 and 0922 84

960 °C for Cat. Nos. 0350 58 and 0921 22

Deep weatherproof plastic industrial equipment boxes with smooth sides

Fixing options :

- inside : 4 oblong holes at back of box
 - outside : cabling volume at 4 corners with Ø4 screws
 - with wall mounting brackets (Cat. No. 0364 08) for 310 x 240 boxes
- Option of mounting equipment on rail or on plain plate at back of box
1/4 turn opening/closing

Pack	Cat. Nos.	Weatherproof boxes – IP 55
		Nominal internal dimensions : Height x Width x Depth (mm)
		Depth 140 mm
2	0921 22	IK 07 - IP 55 220 x 170 x 140 mm - (1/4 turn cover fixings)
		Depth 154 mm
2	0350 43	IK 08 - IP 55 265 x 174 x 154 mm - (1/4 turn cover fixings with hinges)
1	0350 58	359 x 265 x 154 mm - (1/4 turn cover fixings with hinges)
		Depth 160 mm
1	0922 84	IK 08 - IP 55 310 x 240 x 160 mm - (1/4 turn cover fixings with hinges)

Accessories

Metal mounting plates

Galvanised steel - 1.5 mm thick
For PVC box size :

5	0350 90	220 x 170 mm
5	0350 92	265 x 174 mm
5	0350 93	310 x 240 mm
1	0350 94	359 x 265 mm

Set of 4 wall mounting brackets

1	0364 08	For PVC box size 310 x 240 mm only
---	---------	------------------------------------

PVC boxes are not provided with side mounts for IP 2X terminals

■ Dimensions (mm)

Cat. No. 0921 22

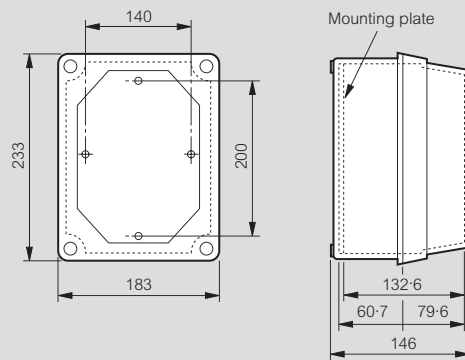

Fixing dimensions

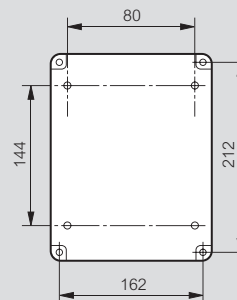

Cat. Nos. 0350 43/58

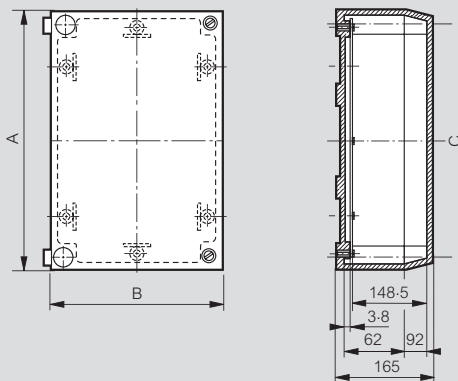

Fixing dimensions

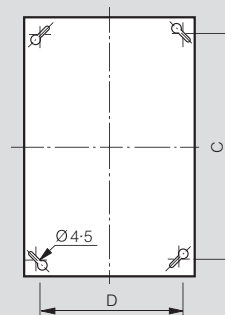

Cat. Nos.	Dimensions		Fixing points		Weight (kg)
	A (mm)	B (mm)	C (mm)	D (mm)	
0350 43	273	182	246	155	1.08
0350 58	367	273	340	246	1.80

Plexo weatherproof boxes

increased depth PVC range (continued)

■ Dimensions (mm)

Cat. No. 0922 84

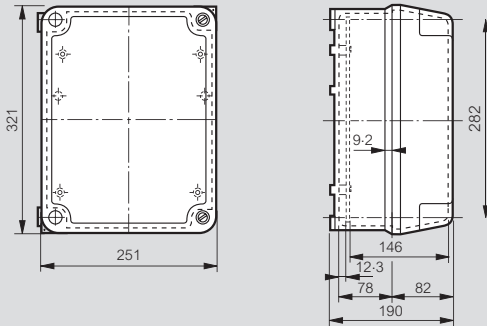

Fixing dimensions

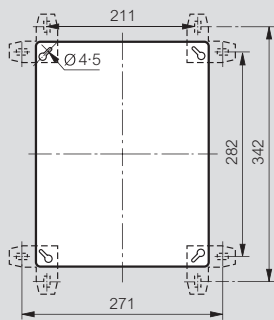

■ Mounting plates for PVC boxes

Cat. No. 0350 90

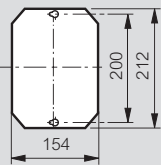

Cat. No. 0350 92

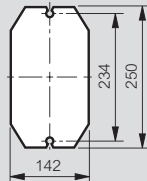

Cat. No. 0350 93

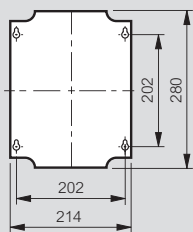

Cat. No. 0350 94

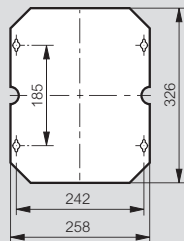

Nylbloc™ terminal strips

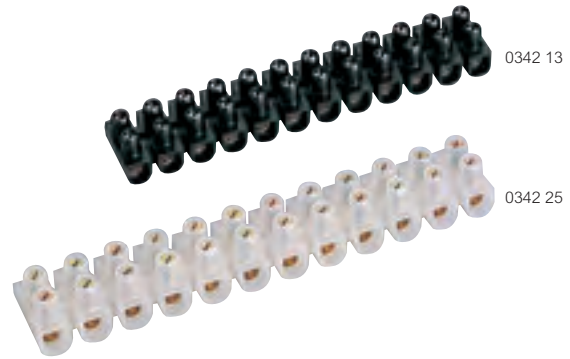

Pack	Cat. Nos.	Nylbloc terminal strips			
		According to EN 60998-2-1, the rated insulation voltage of Nylbloc terminal strips is 250 V			
		They may be used under 400 V nominal voltage supply when integrated in equipment designed according to EN 60664-1 with pollution degree 2 and overvoltage category III			
		12 way strips with captive screws			
		Supplied with screws undone			
		Flame retardent polypropylene (-25 °C to +100 °C)			
		Ambient temperature from -25 °C to +55 °C			
		Rated capacity (mm ²)	Diameter Ø	Current max. (A)	Dimensions (mm)
	Black				
10	0342 11	2.5	2.5	24	15.6 x 94 x 12.3
10	0342 13	6	3.5	41	18 x 107 x 14.7
10	0342 15	10	4.5	57	20.8 x 136 x 17.4
10	0342 17	16	5.5	76	24.2 x 157 x 22.6
10	0342 19	25	7	101	33.2 x 214 x 27.8
	White				
10	0342 21	2.5	2.5	24	15.6 x 94 x 12.3
10	0342 23	6	3.5	41	18 x 107 x 14.7
10	0342 25	10	4.5	57	20.8 x 136 x 17.4
10	0342 27	16	5.5	76	24.2 x 157 x 22.6



Plexo weatherproof boxes p. 36-40



distribution terminal blocks



Conform to standard IEC 60998-2-1
 Supplied ready for use (screws captive and backed-off)
 100 A max. - 400 V~ with 25 mm² incoming
 80 A max. - 400 V~ with 16 mm² incoming
 Ipk (kA) 60 : Icw (kA) 3-5

Pack	Cat. Nos.	Unshrouded terminal blocks		
		Fix using M4 dia. screw		
		Incoming capacity	Outgoing capacity	Terminal length (mm)
10	0048 01	1 x 6 to 25 mm ²	4 x 1.5 to 16 mm ²	45
10	0048 03	1 x 6 to 25 mm ²	8 x 1.5 to 16 mm ²	73
10	0048 05	1 x 6 to 25 mm ²	14 x 1.5 to 16 mm ²	122
10	0048 06	1 x 6 to 25 mm ²	19 x 1.5 to 16 mm ²	157
10	0048 07	1 x 6 to 25 mm ²	24 x 1.5 to 16 mm ²	192

		Fully shrouded terminal blocks		
		Terminal blocks on support		
		Mounting on or rail with universal terminal rail support Cat. No. 0048 11 or on 12 x 2 mm rail		
		Supplied with Duplix markers ¹		
		Incoming capacity	Outgoing capacity	Terminal length (mm)
10	0048 20 ¹	-	4 x 1.5 to 16 mm ²	47
10	0048 22 ¹	-	8 x 1.5 to 16 mm ²	75
10	0048 24 ¹	1 x 6 to 25 mm ²	12 x 1.5 to 16 mm ²	113
10	0048 25 ¹	1 x 6 to 25 mm ²	16 x 1.5 to 16 mm ²	141

		IP 2X terminal blocks on support		
		For fixing to 12 x 2 mm rail		
		Incoming capacity	Outgoing capacity	Terminal length (mm)
10	Phase (black) 0048 50	-	4 x 1.5 to 16 mm ²	47
10	0048 52	-	8 x 1.5 to 16 mm ²	75
10	0048 54	1 x 6 to 25 mm ²	12 x 1.5 to 16 mm ²	113
10	0048 55	1 x 6 to 25 mm ²	16 x 1.5 to 16 mm ²	141
10	0048 56	1 x 6 to 25 mm ²	21 x 1.5 to 16 mm ²	176
10	0048 58	2 x 6 to 25 mm ²	33 x 1.5 to 16 mm ²	276
		Neutral (blue)		
10	0048 30	-	4 x 1.5 to 16 mm ²	47
10	0048 32	-	8 x 1.5 to 16 mm ²	75
10	0048 34	1 x 6 to 25 mm ²	12 x 1.5 to 16 mm ²	113
10	0048 35	1 x 6 to 25 mm ²	16 x 1.5 to 16 mm ²	141
10	0048 36	1 x 6 to 25 mm ²	21 x 1.5 to 16 mm ²	176
10	0048 38	2 x 6 to 25 mm ²	33 x 1.5 to 16 mm ²	276
		Earth (green)		

		Supports for terminal blocks	
		Terminal side support	
1	0048 10	Consists of two side supports for positioning of up to 4 x IP 2X terminal blocks with the same dimensions to create a 2, 3 or 4 pole distribution block	
		Terminal rail support	
5	0048 11	Adaptor support for or rail. Provides a firm fixing allowing IP 2X terminal blocks to be side or top mounted on to adaptor	
		35 hole empty support	
5	0048 17	For screw terminal blocks Length : 276 mm	
		Rail	
10	0048 19	1 metre length of 12 x 2 mm terminal mounting rail - accepts partly and fully shrouded terminals	

■ Connection protection

Fixes into side supports to construct a distribution block

■ Use of terminal supports Cat. No. 0048 10

Terminal supports Cat. No. 0048 10 fitted with fully shrouded terminals providing custom made distribution

Adaptor support Cat. No. 0048 11 showing method of fixing terminals

+++ Plexo weatherproof boxes p. 36-40

¹ : Each terminal supplied with :
 - 2 green Duplix markers (+) - 2 blue Duplix markers (N) - 2 red Duplix markers (L)

distribution blocks 40 to 160 A

modular style - rail or screw fixing



0048 88 + 0048 45 (p. 42)



0048 79

Conform to standard EN 60947-1
 Insulation voltage according to EN 60947-1/IEC 60664-1 : 500 V
 Impulse (surge) voltage (Uimp) : 8 kV
 Degree of pollution : 3 (conductive dust)
 Self-extinguishing 960 °C for active part supports
 Connection with or without Starfix ferrules

Pack	Cat. Nos.	Modular style blocks		Capacity		Ipk peak withstand current (kA)	Icw (kA)	Number of modules
				rigid (mm ²)	flexible (mm ²)			
		Fixing on rail or on plate using 2 screws Supplied complete with rear insulated plate and transparent cover Bar identification possible using CAB 3 markers When installing under a front plate a blank can also be clipped on to the front plate Additional IP 2X terminals can be fitted (see table opposite)						
		Double pole						
		Equipped with 2 bars						
		Ways per bar						
5	0048 81	40 A	11	1.5 to 4	0.75 to 4	20	3	6
			2	6 to 16	4 to 10			
10	0048 80	100 A	5	2.5 to 10	1.5 to 10	20	4.5	4
			2	10 to 25	6 to 16			
5	0048 82	125 A	11	2.5 to 10	1.5 to 10	18	4.5	8
			2	10 to 25	6 to 16			
			2	10 to 35	10 to 25			
		Four pole						
		Equipped with 4 bars						
		Ways per bar						
5	0048 85	40 A	11	1.5 to 4	0.75 to 4	20	3	6
			2	6 to 16	4 to 10			
10	0048 84	100 A	5	2.5 to 10	1.5 to 10	20	4.5	4
			2	10 to 25	6 to 16			
5	0048 86	125 A	7	2.5 to 10	1.5 to 10	20	4.5	6
			2	10 to 25	6 to 16			
			2	10 to 35	10 to 25			
5	0048 88 ¹	125 A	11	2.5 to 10	1.5 to 10	14.5	4.2	8
			4	10 to 35	6 to 25 ¹			
1	0048 79 ¹	160 A	1	35 to 70	35 to 70	27	8.4	10
			8	2.5 to 10	1.5 to 10			
			4	10 to 25	6 to 16			
			2	10 to 35	10 to 25 ¹			

1 : Supplied with short ferrule

CAB 3 markers p. 140-143
 Starfix ferrules p. 148-149



■ Dimensions

Double pole 40 - 100 - 125 A

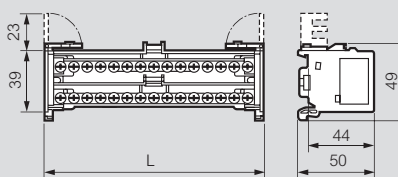

Cat. Nos.	Length (L)
0048 80	70
0048 81	105
0048 82	140

Four pole 40 - 100 - 125 A

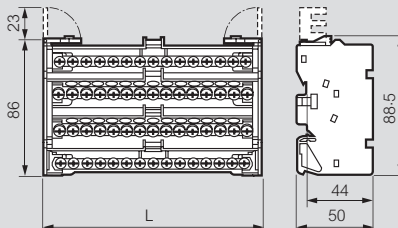

Cat. Nos.	Length (L)
0048 84	70
0048 85	105
0048 86	105
0048 88	140

Four pole 160 A

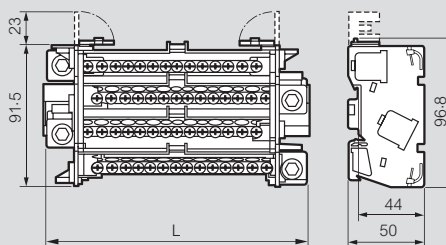

Cat. Nos.	Length (L)
0048 79	179

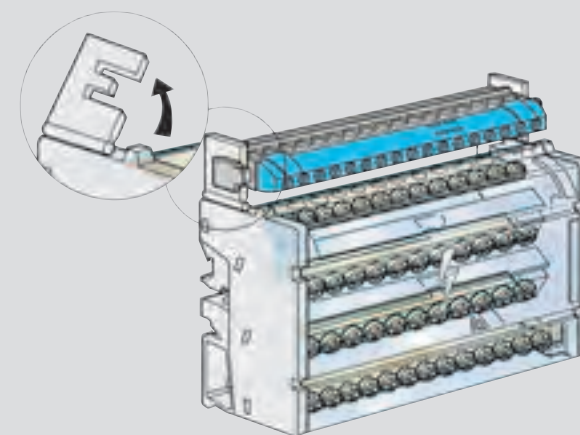

0048 88 + 0048 45

Extend your wiring capability using IP 2X fully shrouded terminals (see p. 42) on the following :

Distribution block Cat. Nos.	IP 2X Terminal	Characteristics Voltage	Rating
0048 80	0048 32 ¹	400 V	80 A
0048 81	0048 34 ¹	400 V	40 A
0048 82	0048 35 ¹	400 V	100 A
0048 84	0048 42 ²	400 V	80 A
0048 85	0048 44 ²	400 V	40 A
0048 86	0048 44 ²	400 V	100 A
0048 88	0048 45 ²	400 V	100 A
0048 79	0048 45 ²	400 V	100 A

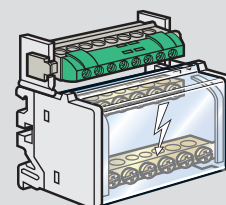

0048 80 + 0048 32

1 : (green cover)
 2 : Neutral (blue cover)

distribution blocks 125 to 400 A

four pole



0374 00



0373 08

Extra-flat distribution blocks for lugs

Pack	Cat. Nos.	Extra-flat distribution blocks for lugs									
1	0374 47	<p>125 A screw type (60 mm depth) Ipk peak withstand current 25 kA Insulation voltage according to EN 60947-1/ IEC 60664-1 : 500 V Self-extinguishing : 960 °C</p> <p>Fix to \perp (15 mm high) or by M6 screws Four bars each equipped with :</p> <table border="1"> <tr> <td>Incoming</td> <td>Phase outgoing</td> <td>Neutral outgoing</td> <td rowspan="2">No. of 17.5 mm modules</td> </tr> <tr> <td>1 x 35 mm²</td> <td>10 x 16 mm² M5 screw</td> <td>17 x 16 mm² M5 screw</td> </tr> </table> <p>Clamp connection possible using connector Cat. No. 0373 65 (p. 45)</p>	Incoming	Phase outgoing	Neutral outgoing	No. of 17.5 mm modules	1 x 35 mm ²	10 x 16 mm ² M5 screw	17 x 16 mm ² M5 screw		
Incoming	Phase outgoing	Neutral outgoing	No. of 17.5 mm modules								
1 x 35 mm ²	10 x 16 mm ² M5 screw	17 x 16 mm ² M5 screw									
1	0374 00	<p>250 A (75.5 mm depth) Ipk peak withstand current 60 kA Insulation voltage according to EN 60947-1/ IEC 60664-1 : 1 000 V Self-extinguishing : 960 °C</p> <p>Fix to mounting plate by M6 screws Four bars each equipped with :</p> <table border="1"> <tr> <td>Incoming</td> <td>either</td> <td>Outgoing</td> </tr> <tr> <td>150 mm²</td> <td></td> <td>1 x 70 mm² or 1 x 50 mm² plus 1 x 35 mm² or 2 x 35 mm²</td> </tr> <tr> <td></td> <td>or</td> <td>1 connector Cat. No. 0374 03</td> </tr> </table>	Incoming	either	Outgoing	150 mm ²		1 x 70 mm ² or 1 x 50 mm ² plus 1 x 35 mm ² or 2 x 35 mm ²		or	1 connector Cat. No. 0374 03
Incoming	either	Outgoing									
150 mm ²		1 x 70 mm ² or 1 x 50 mm ² plus 1 x 35 mm ² or 2 x 35 mm ²									
	or	1 connector Cat. No. 0374 03									
10	0374 03	<p>Connector for Cat. No. 0374 00 converts outgoing terminal to :</p> <ul style="list-style-type: none"> • 1 x 1.5 to 6 mm² Ø 5.3 mm • 2 x 6 to 16 mm² Ø 7.5 mm <p>Dimensions : 29 x 29 x 16.8 mm</p>									

Stepped distribution blocks for lugs

1	0373 95	<p>With front insulation sheet</p> <p>125 A (77 mm depth) Fix to \perp (15 mm high) or by M4 screws Four 12 x 4 mm bars each equipped with : • Five 2 x 10 mm² claw connectors per bar (not mounted)</p>				
1	0374 30	<p>125 A (125 mm depth) Fix to mounting plate by M6 screws Four 15 x 4 mm bars each equipped with :</p> <table border="1"> <tr> <td>Incoming</td> <td>Outgoing</td> </tr> <tr> <td>1 x 35 mm² - M8 screw</td> <td>5 x 25 mm² - M6 screw</td> </tr> </table>	Incoming	Outgoing	1 x 35 mm ² - M8 screw	5 x 25 mm ² - M6 screw
Incoming	Outgoing					
1 x 35 mm ² - M8 screw	5 x 25 mm ² - M6 screw					
1	0374 31	<p>160 A (125 mm depth) Fix to mounting plate by M6 screws Four 18 x 4 mm bars each equipped with :</p> <table border="1"> <tr> <td>Incoming</td> <td>Outgoing</td> </tr> <tr> <td>1 x 70 mm² - M8 screw</td> <td>5 x 35 mm² - M6 screw</td> </tr> </table>	Incoming	Outgoing	1 x 70 mm ² - M8 screw	5 x 35 mm ² - M6 screw
Incoming	Outgoing					
1 x 70 mm ² - M8 screw	5 x 35 mm ² - M6 screw					
1	0374 35	<p>250 A (155 mm depth) Fix to mounting plate by M6 screws Four 25 x 4 mm bars each equipped with :</p> <table border="1"> <tr> <td>Incoming</td> <td>Outgoing</td> </tr> <tr> <td>1 x 120 mm² - M10 screw</td> <td>5 x 50 mm² - M8 screw</td> </tr> </table>	Incoming	Outgoing	1 x 120 mm ² - M10 screw	5 x 50 mm ² - M8 screw
Incoming	Outgoing					
1 x 120 mm ² - M10 screw	5 x 50 mm ² - M8 screw					
1	0373 08	<p>400 A (107 mm depth) Four 32 x 5 mm bars equipped with :</p> <table border="1"> <tr> <td>Incoming</td> <td>Outgoing</td> </tr> <tr> <td>2 x Ø8.5 mm holes for bar/flexible bar</td> <td>21 x M6 holes for 70 mm² max cable lugs</td> </tr> </table>	Incoming	Outgoing	2 x Ø8.5 mm holes for bar/flexible bar	21 x M6 holes for 70 mm ² max cable lugs
Incoming	Outgoing					
2 x Ø8.5 mm holes for bar/flexible bar	21 x M6 holes for 70 mm ² max cable lugs					

Extra-flat distribution blocks for lugs

125 A Cat. No. 0374 47

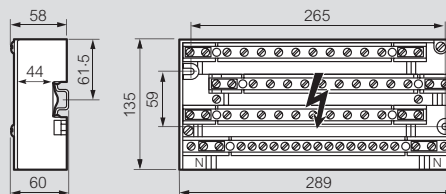

250 A Cat. No. 0374 00

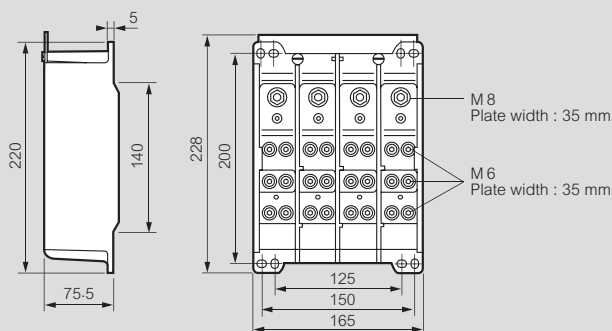

Stepped distribution blocks for lugs

125 A Cat. No. 0373 95 - Ipk peak withstand current 20 kA
Insulation voltage according to EN 60947-1/IEC 60664-1 : 600 V
Self-extinguishing : 850 °C

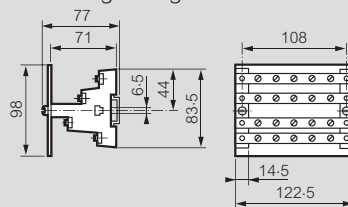

125/160/250 A Cat. Nos. 0374 30/31/35 - Ipk peak withstand current 35 kA
Insulation voltage according to EN 60947-1/IEC 60664-1 : 1 000 V
Impulse (surge) voltage (Uimp) : 12 kV
Degree of pollution : 3 (conductive dust)
Self-extinguishing : 850 °C

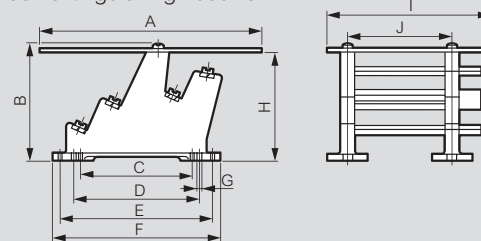

Dimensions (mm)

Rating	A	B	C	D	E	F	G	H	I	J
125 A	225	125	110	125	165	189	6.5	117.5	165	108
160 A	240	125	110	125	165	189	6.5	117.5	180	120
250 A	260	155	110	125	185	209	6.5	147.5	195	120

400 A¹ Cat. No. 0373 08 - Ipk peak withstand current 42 kA
Insulation voltage according to EN 60947-1/IEC 60664-1 : 1 000 V
Impulse (surge) voltage (Uimp) : 12 kV
Degree of pollution : 3 (conductive dust)
Self-extinguishing : 960 °C

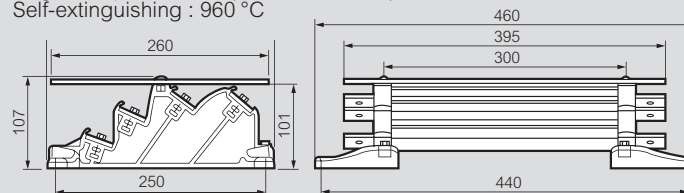

1 : It is recommended that the unit is fitted horizontally with a minimum face plate height of 300 mm

distribution blocks

self assembly

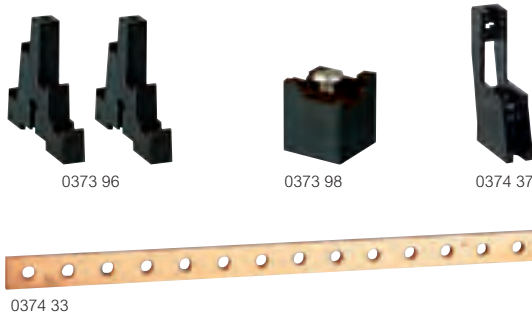

Insulated supports (maximum 280 A)

Pack	Cat. Nos.	Description	Mounting type
5	0373 96	For assembling distribution blocks of varying lengths using bars and connectors below. Supplied with insulated screws for mounting optional protective cover (except Cat. No. 0373 98). Set of 2 insulated 4 pole supports For bars 12 x 2 or 12 x 4 mm	DIN rail 0044 16 supplied or M4 screws not supplied
10	0373 98	Single pole supports For bars 12 x 2 or 12 x 4 mm	by M4 screws supplied
10	0374 37	For bars 15 x 4, 18 x 4 or 25 x 4 mm	

Copper connector bars

With threaded holes

		Size (mm)	Threaded holes Ø mm	Pitch	Max. thermal rating (A)	Length (mm)
10	0373 88	12 x 2	M5	18	110	990
10	0373 89	12 x 4	M5	18	160	990
10	0374 33	15 x 4	M6	18	200	990
10	0374 34	18 x 4	M6	18	245	990
10	0374 38	25 x 4	M6	18	280	990
4	0374 19	32 x 5	M6	25	450	1750

Connectors

Clamp type – For bars with threaded holes 12 x 4 (mm)

100	0373 65	For one or two conductors 1.5 to 10 mm ² (supplied with Ø 5 mm screw)
-----	---------	---

Cage type – For bare 12 x 4 mm bars

		Capacity
100	0373 60	1.5 to 4 mm ²
10	0373 61	6 to 16 mm ²
10	0373 62	10 to 35 mm ² (supplied with hexagonal 5 mm M6 screw)

Clips

10	0044 16	For mounting on rail EN 60715 and 15 mm depth 10 mm width With threaded Ø 4 mm hole
----	---------	---

Copper connector bars with threaded holes

Cat. Nos. 0373 88/89

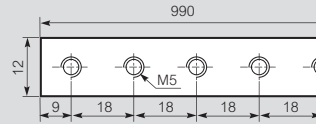

Cat. Nos. 0374 33/34

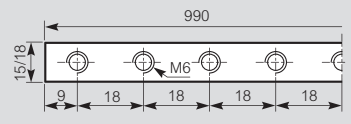

Cat. No. 0374 38

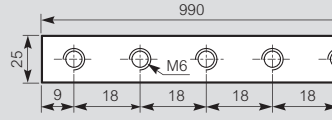

Cat. No. 0374 19

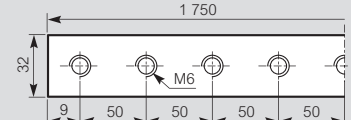

Cat. Nos.	Size	lthe (A)	lc (A)
0373 88	12 x 2	110	80
0373 89	12 x 4	160	125
0374 33	15 x 4	200	160
0374 34	18 x 4	245	200
0374 38	25 x 4	280	250
0374 19	32 x 5	450	400

Current ratings according to EN 60947-1 :

- lth : bars in free air
- lthe : bars enclosed with ventilation
- lc : bars totally enclosed in a weatherproof enclosure

Insulated supports four pole

Insulation voltage according to EN 60947-1/IEC 60664-1 :
Cat. No. 0373 96 : 690 V - Impulse voltage (surge) (Uimp) : 8 kV
Degree of pollution (conductive dust) : 3
Distance between supports (mm)

Cat. Nos.	0373 96
Bar size	12 x 4 (12 x 2)
In (A)	125 (80)
Peak withstand current (kA)	
10	400 (200)
15	300 (150)
20	200 (125)
25	150 (100)
30	-
35	-
40	-

Cat. No. 0373 96

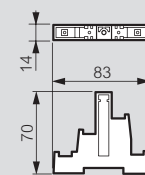

Insulated supports single pole

Insulation voltage according to EN 60947-1/IEC 60664-1 : 500 V
Impulse voltage (surge) (Uimp) : 8 kV
Degree of pollution (conductive dust) : 3

Cat. No. 0373 98

Front view for 12 x 2 mm bar

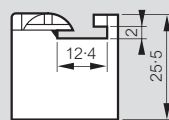

View from above

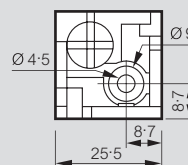

Front view for 12 x 4 mm bar

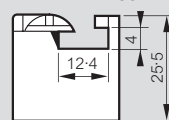

Cat. No. 0374 37

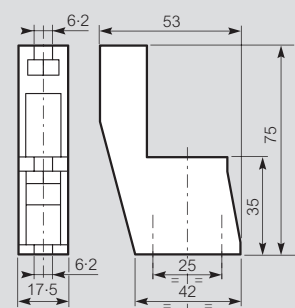

Max. space between 2 supports :
bar size 12 x 2 : 20 cm, 12 x 4 : 25 cm

The distance between supports can be determined using the chart
Select the peak withstand current (kA rating) and the distance between bars - dimension E (mm) after choosing your bar and support
Distance between supports (mm)

Cat. Nos.	0373 98				0374 37			
	12 x 2/12 x 4				15 x 4/18 x 4/25 x 4			
In (A)	80/125				160/200/245			
E (mm)	50	75	100	125	50	75	100	125
Peak withstand current (kA)								
10	400	600	800	-	350	600	750	-
15	300	450	600	800	250	400	500	700
20	250	350	450	600	150	225	300	375
25	200	250	300	400	125	150	200	250
30	-	-	-	-	100	125	150	175
35	-	-	-	-	-	100	125	150



Transcab®

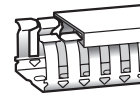

P. 50
Transcab
PVC panel trunking

TRANSCAB® OPEN SLOT PANEL TRUNKING

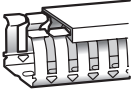

P. 50
Transcab
PC/ABS
halogen free
panel trunking



P. 50
Transcab
cutting tool

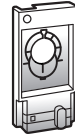

P. 50
Cable retainer,
marking and fixing
accessories and
braided sleeving



P. 51
Technical
information

TRANSCAB® ...

uniquely innovative
open slot trunking

Innovative design and high quality materials combine to create a globally approved system that is quick and easy to install

TRANSCAB 'HOW TO' VIDEO... VISIT [YOUTUBE.COM/LEGRANDTVUK](https://www.youtube.com/legrandtvuk)

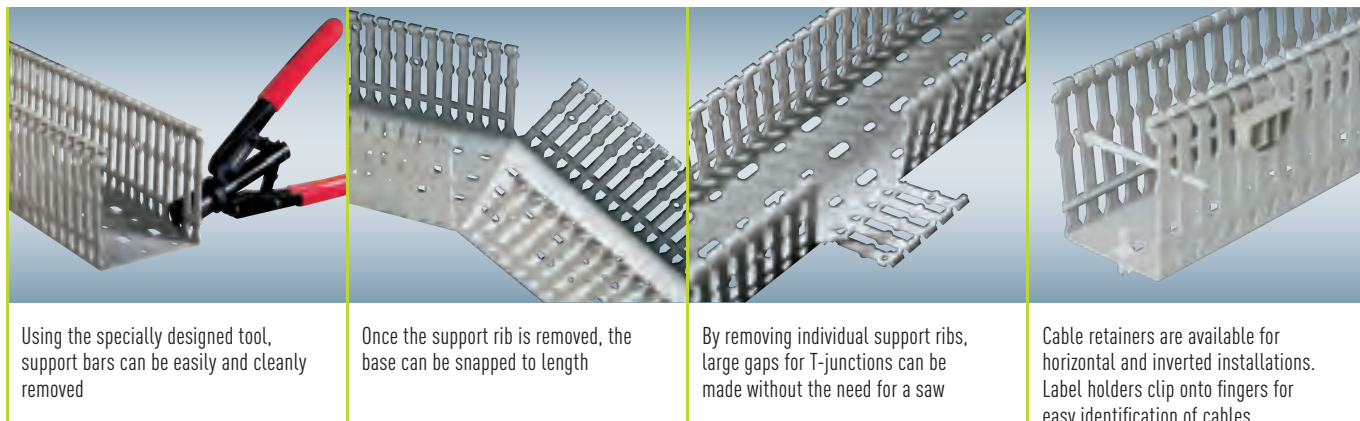

Using the specially designed tool, support bars can be easily and cleanly removed

Once the support rib is removed, the base can be snapped to length

By removing individual support ribs, large gaps for T-junctions can be made without the need for a saw

Cable retainers are available for horizontal and inverted installations. Label holders clip onto fingers for easy identification of cables

With its innovative snap to length design, Transcab open slot panel trunking is quick and easy to install without compromising on quality. And with its global standards approvals, Transcab is ideal for almost any industrial application.

Strength and flexibility

Transcab's durable PVC body consists of 6mm gaps and 6.5mm fingers with unique support ribs that provide strength and rigidity. Trunking fingers are easily removed by snapping at support rib or base level without the need for a saw.

FEATURES

- Snap to length design - for quick and simple installation without the need for a saw
- Rounded fingers - easily removed at support rib or base level to create T-junctions
- Clip-on covers with raised lines - for quick installation and easy label alignment
- Available in PVC and PC/ABS halogen-free versions - to suit a variety of applications
- Sizes : width x height - from 15 x 25mm to 150 x 100mm
: supplied in 2m lengths

ACCESSORIES

- Unique cutting tool for removing support ribs - Cat No. 0367 10
- Cable retainer - for vertical and inverted installations
- Label holder clips to fingers - for easy identification of cables

See p. 50

TECHNICAL DATA

APPROVALS: EN 50085 Parts 2 and 3, UL and CSA

SLOTING: Open with 6mm gaps

FLAMMABILITY: UL94 V0 rated

OPERATING TEMPERATURE: -5 to + 60°C

COLOUR: Grey RAL 7030 (PVC), light grey RAL 7035 (PC/ABS halogen-free)



Transcab® open slot panel trunking

PVC and PC/ABS halogen free

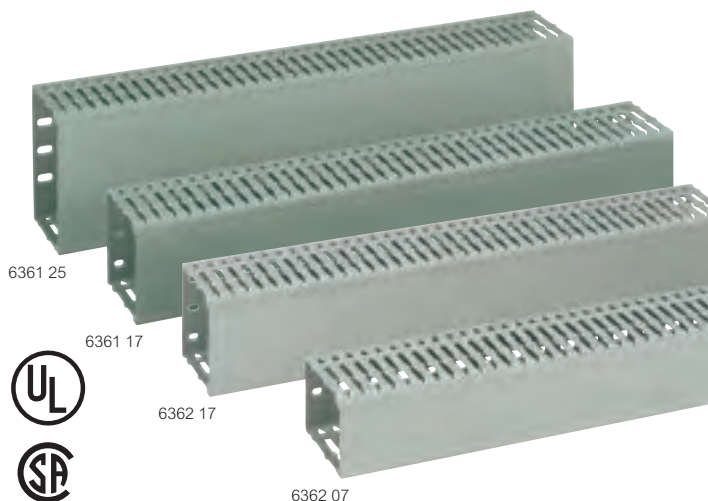

Dimensions and technical information p. 51
Accessories **opposite**

Conforms to EN 50085 Parts 2 and 3. UL and CSA approval
Material : PVC self-extinguishing or PC/ABS halogen free
Colour : grey RAL 7030 (PVC) or light grey RAL 7035 (PC/ABS)
PC/ABS range passes IEC 695-2-1 850 °C glow wire test
Operating temp. : -5 to +60 °C
UL classification : UL94 VO
Oxygen index : 43% (PVC) or 37% (PC/ABS) EN ISO 4589 (low fume)
Metric size body in 2 m lengths (6 mm gap/6.5 mm finger width)
DIN fixing centres of 12.5/25 mm
Maximum space for cables with good heat dissipation
Exit cables at terminal or base level

Plastic panel trunking (base + cover)

Pack	Cat. Nos.		2 metre lengths	
Metres per pack	PVC Grey RAL 7030	PC/ABS Grey RAL 7035 halogen free	Width x Height (mm)	Capacity (mm ²)
32	6360 95		15 x 25	264
60	6361 00		25 x 25	391
56	6361 05		40 x 25	692
40	6360 96		15 x 40	455
56	6361 01		25 x 40	720
48	6361 06		40 x 40	1 245
32	6361 11		60 x 40	1 932
24	6361 15		80 x 40	2 647
24	6361 19		100 x 40	3 363
56	6361 02	6362 02	25 x 60	1 159
48	6361 07	6362 07	40 x 60	2 007
32	6361 12	6362 12	60 x 60	3 115
24	6361 16		80 x 60	4 200
24	6361 20		100 x 60	5 307
40	6361 03		25 x 80	1 600
40	6361 08		40 x 80	2 717
32	6361 13	6362 13	60 x 80	4 216
24	6361 17	6362 17	80 x 80	5 715
16	6361 21		100 x 80	7 215
16	6361 25	6362 25	120 x 80	8 729
24	6361 09		40 x 100	3 354
24	6361 14		60 x 100	5 216
20	6361 18		80 x 100	7 078
16	6361 22		100 x 100	8 960
12	6361 23		150 x 100	13 683

Spare covers

Pack	PVC	2 metre lengths
		Width (mm)
36	0370 10	15 - also used for marking ¹
36	0370 11	25
36	0370 12	40
36	0370 13	60
36	0370 14	80

¹ : Clips to label holder Cat. No. 0367 02

Transcab® accessories

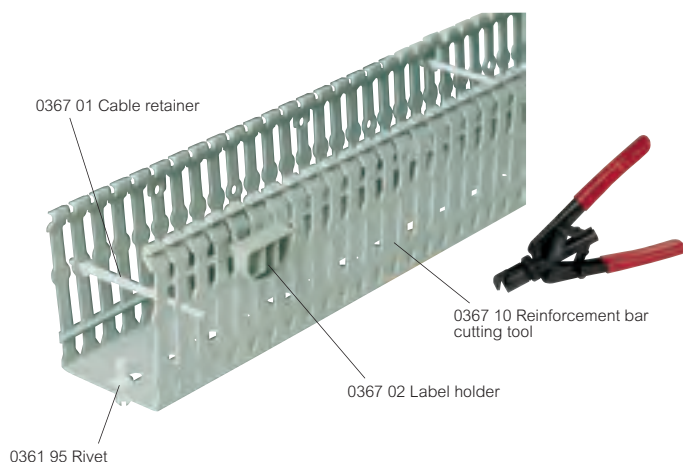

Pack	Cat. Nos.	Transcab cutting tool
1	0367 10	Tool for cutting 6 mm reinforcement bars

Pack	Cat. Nos.	Cable retainer
50	0367 01	Cable retainer - clips through trunking fingers

Pack	Cat. Nos.	Marking accessories
50	0367 02	Label holder Label holder - (clips to finger) for marking
10	0395 98	Black felt tip pen Indelible for marking



Pack	Cat. Nos.	Fixing accessories
100	6361 90	To DIN rail Insulated Nylon fixing screws Ø 6 mm for fixing the panel trunking to DIN rail
500	6361 95	To plain plate Insulated plastic rivets Ø 6 mm for fixing the panel trunking to a plain plate without the need of a screw
20	0366 42	To enclosure door Material : polyamide 6/6 For fixing the panel trunking to an enclosure door Fits under warning lights or other auxiliary controls attached to door Enables direct mounting of trunking by a manual 1/4 turn



Pack	Cat. Nos.	Braided sleeving
1	0366 38	Material : black polyester 50 m roll in dispenser box Used to protect runs of cables to door equipment Ø of roll Ø variations Ø 20 mm 10 - 30 mm
1	0366 39	Ø 30 mm 18 - 54 mm



Intrinsically safe
Lina 25 available to order
on special request
Contact us on
+44 (0) 845 605 4333

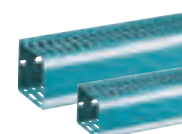

Transcab® open slot panel trunking

■ Dimensions

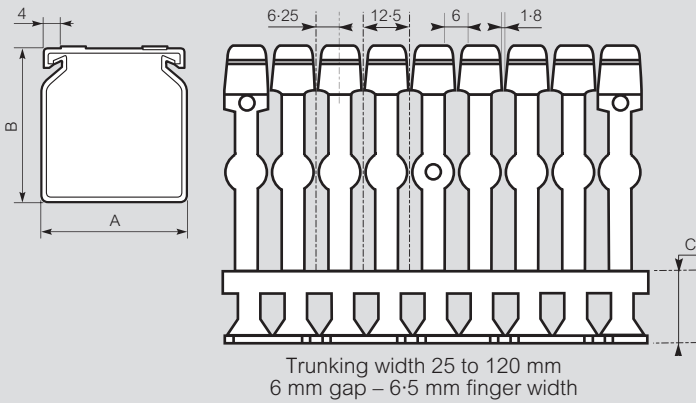

■ Detail of base perforations

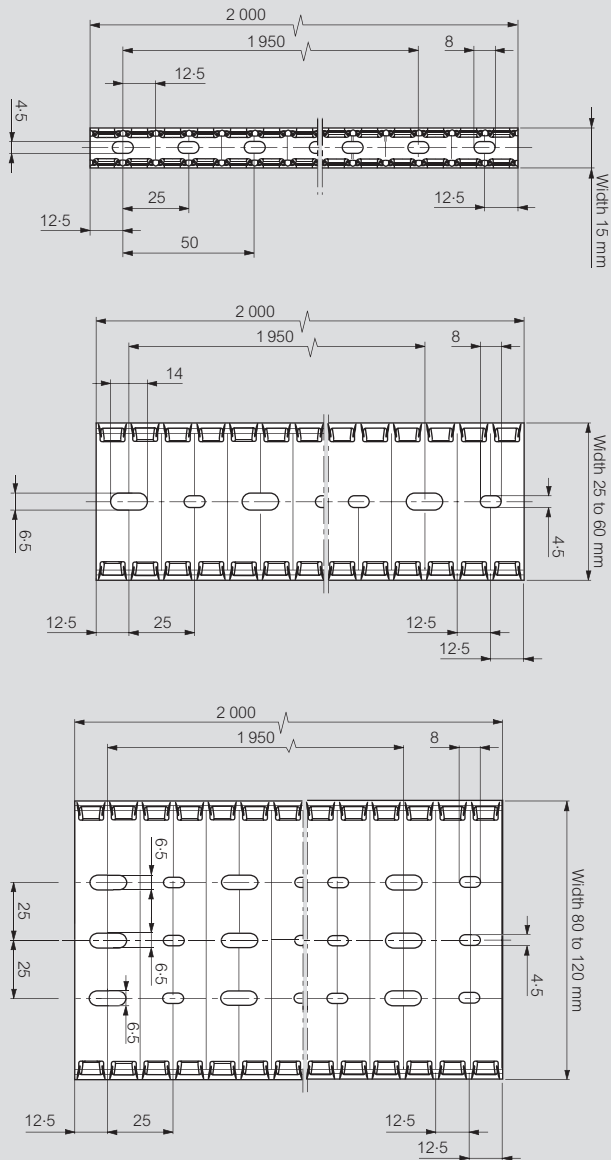

Transcab Cat. Nos.	A (mm)	B (mm)	C (mm)
6361 00	25	25	10-1
6361 01	25	40	12-6
6361 06	40	40	12-6
6361 11	60	60	16-1
6361 02	25	60	16-1
6361 07	40	60	16-1
6361 12	60	60	16-1
6361 16	80	60	16-1
6361 20	100	60	16-1
6361 03	25	80	18-6
6361 08	40	80	18-6
6361 13	60	80	18-6
6361 17	80	80	18-6
6361 21	100	80	18-6
6361 25	120	80	18-6
6361 14	60	100	20-6
6361 22	100	100	20-6
6361 23	150	100	20-6

Calculating the panel trunking usable cross section

Graph for H 05 V-K and H 07 V-K cables with 0.75 packing coefficient

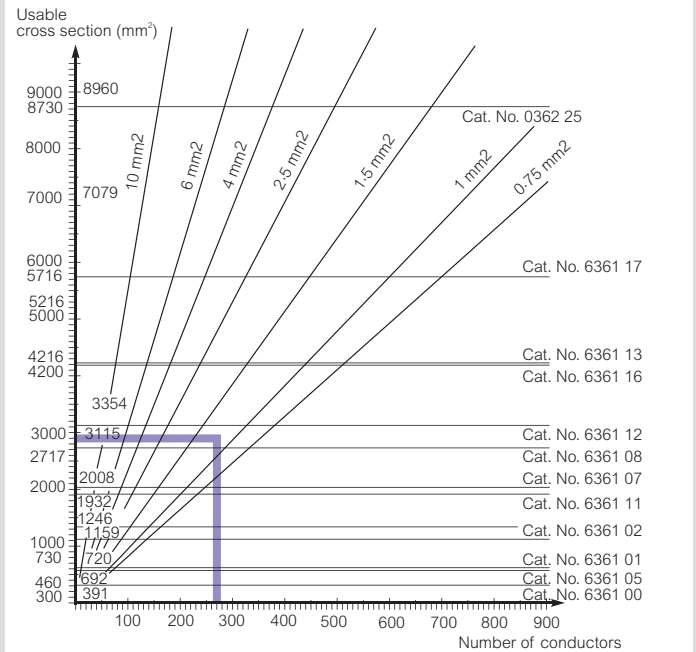

Example :

150 conductors 0.75 mm² → 1230 mm² cross section and
120 conductors 1.5 mm² → 1700 mm² cross section
Makes a total of 2930 mm²

The correct panel trunking is Cat. No. 6361 12, 60 x 60 mm, with a capacity of 3115 mm²

Faster base build without a saw



Remove reinforcement bars at required length and break

'T' junctions made easy

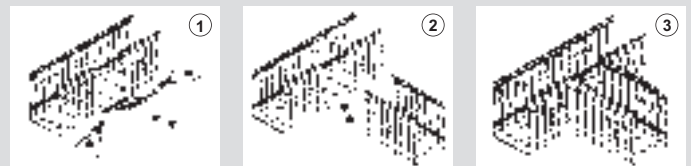

- 1 Clip out the required section width reinforcement bars and snap out section
- 2 Form T junction and fix into place
- 3 Ready for wiring – cut cover to suit

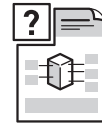

P. 54
Introduction to
power protection

MCB/RCD/RCBO protection devices



P. 60
Protection of
DC circuits



P. 65
DIN rail
equipment
dimensions

Metering



P. 66
Introduction to
metering

Fuse carriers and fuses

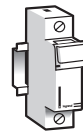

P. 74
Modular
fuse carriers



P. 78
Blade type
cartridge
fuses

NEW 2014



**DX³
MCBs**
(p. 56)



**DX³
RCDs**
(p. 61)



**DX³
RCBOs**
(p. 63)

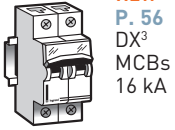

NEW
P. 56
DX³
MCBs
16 kA

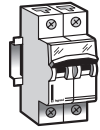

NEW
P. 57
DX³
MCBs
10 kA

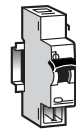

NEW
P. 58
DX³
MCB
auxiliaries



P. 59
DX³
technical
information

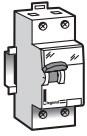

NEW
P. 61
DX³
RCDs



NEW
P. 62
DX³
RCD
auxiliaries

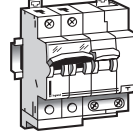

NEW
P. 63
DX³
RCBOs



NEW
P. 64
DX³
RCBO
auxiliaries

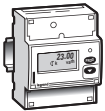

NEW
P. 68
EMDX³
electrical
energy meters



NEW
P. 68
EMDX³
multi-function
measuring units

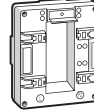

P. 70
Current
transformers



P. 71
Metering
technical
information

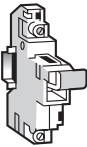

P. 74
SP
fuse carriers



P. 74
Modular
fuse carriers
technical
information

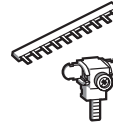

P. 75
Modular
fuse carriers
and device
accessories



P. 76
Cylindrical
cartridge
fuses



P. 79
Cartridge
fuses
dimensions



EMDX³
electrical energy
meters
(p. 68)



EMDX³
multi-function
measuring units
(p. 69)

POWER PROTECTION

In developing its new range of DX³ protection devices, Legrand has paid particular attention to the performance of each individual product, with every item being individually tested before it leaves the factory.

You're in safe hands with Legrand's power protection range.



DX³ MCBs

TECH DATA
 Breaking capacity: 10kA, 16kA
 Pole range: single to four pole
 Current rating: 1A to 125A
 Tripping characteristics: Type B, C, D

DX³ RCDs

TECH DATA
 Pole range: double and four pole
 Current rating: 16A to 100A
 Types: A, AC
 Sensitivity: 10mA, 30mA, 100mA, 300mA and 500mA



THE FIGHT AGAINST COUNTERFEIT... MANY DX³ PRODUCTS ARE MARKED WITH A UNIQUE REGISTRATION NUMBER. VISIT: WWW.LEGRAND-COPYTRACER.COM

NEW DX³ range...

Legrand's new DX³ range of MCBs, RCDs, RCBOs and isolating switches (p. 82) offer a variety of enhanced features...



WIRE GUIDE FLAP ensures the wire is in the correct position

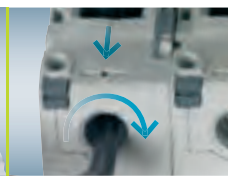

RISING CLAMP TERMINALS ensure a high quality, durable connection



INCREASED SAFETY guaranteed IP2X protection with no risk of contact with live parts, even with faceplate open



INNOVATIVE LABEL HOLDER offers improved opening mechanism and grip on label, plus enhanced dust protection

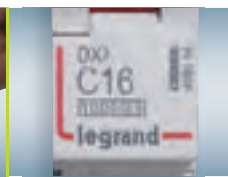

CLEAR, CONCISE MARKING Curve, rating and breaking capacity are easily identified

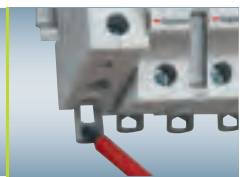

THE DOUBLE CLIP enables a device to be replaced without disconnecting the entire row. Now available on all devices

NEW



DX³ RCBOs

TECH DATA

Breaking capacity:	10kA
Pole range:	single pole, single pole + neutral to four pole
Current rating:	3A to 63A
Tripping characteristics:	Type B, C
Sensitivity:	10mA, 30mA, and 300mA

NEW



EMDX³ metering devices

A wide range of metering devices available:

- Electricity meters and multi-function measuring units
 - Door and DIN rail mounting options
 - MID certified meters
 - Supported by supervision software and remote web-based monitoring system
- see p. 68 to 73



Fuses and fuse carriers

In addition to DIN rail mounted protection devices, Legrand offers a comprehensive range of cylindrical fuses, blade fuses and modular fuse carriers.

see p. 74 to 79

... with added benefits for MCBs

80 to 125A DX³ MCBs benefit from all of the innovations offered by the new DX³ range and in addition offer a whole host more...



Temperature rise
-20%

RELIABLE CONNECTIONS

Compensation for the effect of loosening to ensure excellent hold over time and consistent contact

LOCK IN OPEN POSITION
simply by using a single Colring cable tie
(see p. 138)

EASY TAP-OFF CONNECTION
IP2X automatic terminals safely connect an auxiliary circuit or measuring device



ALLEN SCREW
and Allen key make it easier to tighten to required torque

RETRACTABLE INSULATING SHIELDS
no additional accessories required to isolate connections on high rating devices no matter what the breaking capacity



MCBs DX³ 10000 - 16 kA

thermal magnetic circuit breakers from 1 A to 125 A

NEW



4088 69



4089 43



4091 11



4092 03

Dimensions **p. 65**
 Technical information **p. 59-60**

Conform to IEC 60898-1

Breaking capacity

10000 - IEC 60898-1 - 400 V~

16 kA - IEC 60947-2 - 400 V~

Can be equipped with DX³ auxiliaries and accessories **p. 58**

MCBs DX³ 10000 - 16 kA - B curve

Pack	Cat. Nos.	Nominal rating I _n (A)	Number of modules
Single pole 230/400 V~			
B curve			
1	4088 65	1	1
1	4088 66	2	1
1	4088 67	3	1
1	4088 69	6	1
1	4088 70	10	1
1	4088 72	16	1
1	4088 73	20	1
1	4088 74	25	1
1	4088 75	32	1
1	4088 76	40	1
1	4088 78	63	1
Double pole 230/400 V~			
1	4089 35	1	2
1	4089 36	2	2
1	4089 37	3	2
1	4089 39	6	2
1	4089 40	10	2
1	4089 42	16	2
1	4089 43	20	2
1	4089 44	25	2
1	4089 45	32	2
1	4089 46	40	2
1	4089 48	63	2
Triple pole 400 V~			
1	4089 84	1	3
1	4089 85	2	3
1	4089 86	3	3
1	4089 88	6	3
1	4089 89	10	3
1	4089 91	16	3
1	4089 92	20	3
1	4089 93	25	3
1	4089 94	32	3
1	4089 95	40	3
1	4089 96	50	3
1	4089 97	63	3
Four pole 400 V~			
1	4090 58	1	4
1	4090 62	6	4
1	4090 63	10	4
1	4090 65	16	4
1	4090 66	20	4
1	4090 67	25	4
1	4090 68	32	4
1	4090 69	40	4
1	4090 70	50	4
1	4090 71	63	4

MCBs DX³ 10000 - 16 kA - C curve

Pack	Cat. Nos.	Nominal rating I _n (A)	Number of modules
Single pole 230/400 V~			
C curve			
1	4091 07	1	1
1	4091 08	2	1
1	4091 09	3	1
1	4091 11	6	1
1	4091 12	10	1
1	4091 14	16	1
1	4091 15	20	1
1	4091 16	25	1
1	4091 17	32	1
1	4091 18	40	1
1	4091 19	50	1
1	4091 20	63	1
1	4091 40	80	1
Double pole 230/400 V~			
1	4091 95	1	2
1	4091 96	2	2
1	4091 97	3	2
1	4091 99	6	2
1	4092 00	10	2
1	4092 02	16	2
1	4092 03	20	2
1	4092 04	25	2
1	4092 05	32	2
1	4092 06	40	2
1	4092 07	50	2
1	4092 08	63	2
1	4092 28	80	3
1	4092 29	100	3
1	4092 30	125	3
Triple pole 400 V~			
1	4092 47	1	3
1	4092 48	2	3
1	4092 49	3	3
1	4092 51	6	3
1	4092 52	10	3
1	4092 54	16	3
1	4092 55	20	3
1	4092 56	25	3
1	4092 57	32	3
1	4092 58	40	3
1	4092 59	50	3
1	4092 60	63	3
1	4092 80	80	4-5
1	4092 81	100	4-5
1	4092 82	125	4-5
Four pole 400 V~			
1	4093 29	1	4
1	4093 30	2	4
1	4093 31	3	4
1	4093 33	6	4
1	4093 34	10	4
1	4093 36	16	4
1	4093 37	20	4
1	4093 38	25	4
1	4093 39	32	4
1	4093 40	40	4
1	4093 41	50	4
1	4093 42	63	4
1	4093 62	80	6
1	4093 63	100	6
1	4093 64	125	6

MCBs DX³ 10000 - 16 kA **NEW**

thermal magnetic circuit breakers from 1 A to 125 A (continued)



4095 08

Dimensions **p. 65**
 Technical information **p. 59-60**

Conform to IEC 60898-1

Breaking capacity

10000 - IEC 60898-1 - 400 V~

16 kA - IEC 60947-2 - 400 V~

Can be equipped with DX³ auxiliaries and accessories **p. 58**

Pack	Cat. Nos.	MCBs DX ³ 10000 - 16 kA - D curve	
Single pole 230/400 V~			
	D curve	Nominal rating I _n (A)	Number of modules
1	4094 25	2	1
1	4094 28	6	1
1	4094 30	10	1
1	4094 32	16	1
1	4094 33	20	1
1	4094 34	25	1
1	4094 35	32	1
1	4094 36	40	1
1	4094 37	50	1
1	4094 38	63	1
Double pole 230/400 V~			
1	4094 44	2	2
1	4094 47	6	2
1	4094 49	10	2
1	4094 51	16	2
1	4094 52	20	2
1	4094 53	25	2
1	4094 54	32	2
1	4094 55	40	2
1	4094 56	50	2
1	4094 57	63	2
1	4094 58	80	3
1	4094 59	100	3
1	4094 60	125	3
Triple pole 400 V~			
1	4094 92	2	3
1	4094 95	6	3
1	4094 97	10	3
1	4094 99	16	3
1	4095 00	20	3
1	4095 01	25	3
1	4095 02	32	3
1	4095 03	40	3
1	4095 04	50	3
1	4095 05	63	3
1	4095 06	80	4.5
1	4095 07	100	4.5
1	4095 08	125	4.5
Four pole 400 V~			
1	4095 26	2	4
1	4095 29	6	4
1	4095 31	10	4
1	4095 33	16	4
1	4095 34	20	4
1	4095 35	25	4
1	4095 36	32	4
1	4095 37	40	4
1	4095 38	50	4
1	4095 39	63	4
1	4095 40	80	6
1	4095 41	100	6
1	4095 42	125	6

MCBs DX³ 6000 - 10 kA **NEW**

thermal magnetic circuit breakers from 1 A to 63 A



4079 65



4080 25

Dimensions **p. 65**
 Technical information **p. 59**

Conform to IEC 60898-1

Breaking capacity

6000 - IEC 60898-1 - 400 V~

10 kA - IEC 60947-2 - 400 V~

Can be equipped with DX³ auxiliaries and accessories **p. 58**

Pack	Cat. Nos.	MCBs DX ³ 6000 - 10 kA - D curve	
Single pole 230/400 V~			
	D curve	Nominal rating I _n (A)	Number of modules
1	4079 63	1	1
1	4079 65	3	1
1	4079 66	4	1
Double pole 230/400 V~			
1	4080 23	1	2
1	4080 25	3	2
1	4080 26	4	2
Triple pole 400 V~			
1	4080 81	1	3
1	4080 83	3	3
1	4080 84	4	3

Auxiliaries and accessories **p. 58**





4062 58







4062 66

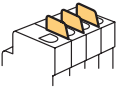

Dimensions **p. 65**
 Technical information **p. 59-60**

Pack	Cat. Nos.	Auxiliaries for MCBs	Number of modules
		Clip on the left hand side of the MCB (maximum 3) Allow insertion of the supply busbar at the top Auxiliaries common to DX ³ MCBs, RCDs and RCBOs	
		Signalling auxiliaries	
1	4062 58	Auxiliary changeover switch, 6 A - 250 V~ Indicates the position of the contacts	0.5
1	4062 60	Fault signalling changeover switch, 6 A - 250 V~ Indicates tripping of the MCB at a fault	0.5
1	4062 62	Auxiliary changeover switch, 6 A - 250 V which can be modified to a fault signalling switch	0.5
1	4062 66	Auxiliary changeover switch, 6 A - 250 V + fault signalling switch, can be modified to 2 auxiliary changeover switches	1

Pack	Cat. Nos.	Accessories	
		Padlocking	
2	4063 03	Support for one Ø5 mm padlock for DX ³ MCBs and RCDs or isolating switches	
3	4063 13	Ø5 mm shackle type padlock	
		Sealable screw cover - 4 separable poles	
2	4063 04	For DX ³ MCBs, 1 module per pole	
		Insulating shields	
1	4063 05	For DX ³ MCBs, 1 module per pole Pole insulating shield (set of 6)	
		Spacing element	
10	4063 07	For heat reduction – 0.5 module	

technical information

■ Breaking capacity in IT neutral earthing system

MCB single pole breaking capacity at 400 V according to IEC 60947-2

	DX ³ 10000 16 kA
1P/2P/3P/4P	4 kA

■ Breaking capacity in the event of short-circuit to earth and insulation voltage

	1P/2P/3P/4P 230/400 V~ MCBs DX ³ 10000 16 kA
Icn1	16000 A
Ui	500 V

Icn1 : Breaking capacity on 1 pole for multipole MCBs in the event of short-circuit to earth

Ui : Rated insulation voltage

■ Terminal connection cross-sections (mm²)

Copper cable	Rigid	Flexible
DX ³ 6000 10 kA	35	25
DX ³ 10000 16 kA		
Auxiliaries	2.5	2.5

■ Technical characteristics of auxiliaries

Max. connection cross-section : 2.5 mm²
Operating temperature : -25°C to +70°C

■ Signalling auxiliaries

Umin. : 24 V~ / = and Imin. : 5 mA

■ MCB selectivity table

MCBs/MCBs (in A)

Downstream MCB	Upstream MCB	DX ³ 10000 - 16 kA B curve				DX ³ 10000 - 16 kA C curve						
		In (A)	32	40	50	63	32	40	50	63	80	100
DX ³ 10000 - 16 kA B & C curve	≤ 6	128	160	200	252	240	300	375	472	4000	T	T
	10	128	160	200	252	240	300	375	472	3000	5000	T
	16	128	160	200	252	240	300	375	472	2000	3600	5500
	20		160	200	252	240	300	375	472	1600	3000	4000
	25			200	252	240	300	375	472	1300	2400	3300
	32				252	240	300	375	472	1000	1800	2700
	40							375	472	800	1600	2400
	50								472	800	900	1700
	63									650	900	1200
	80										600	750
	100											750
	125											

T : total selectivity, up to downstream circuit breaker breaking capacity according to IEC 60947-2

The magnetic threshold and the nominal rating of the downstream MCB must always be inferior to the ones of the upstream MCB

■ Back up between MCBs (in kA)

In 3 phase networks + N 400/415 V according to IEC 60947-2

MCBs upstream	DX ³ 10000 16 kA B, C and D curves	
MCBs downstream	10 to 125 A	
DX ³ 6000 - 10 kA B, C and D curves	≤ 20 A	16 kA
	25 A	16 kA
	32 A	16 kA
	40 A	16 kA
	50 A	16 kA
	63 A	-

In 3 phase networks + N 230/240 V according to IEC 60947-2

MCBs upstream	DX ³ 10000 16 kA B, C and D curves	
MCBs downstream	≤ 32 A 40 to 125 A	
DX ³ 6000 - 10 kA B, C and D curves	≤ 20 A	32 kA 25 kA
	25 to 40 A	- 25 kA
	50 A	- 25 kA
	63 A	- 25 kA

■ MCB tripping curves

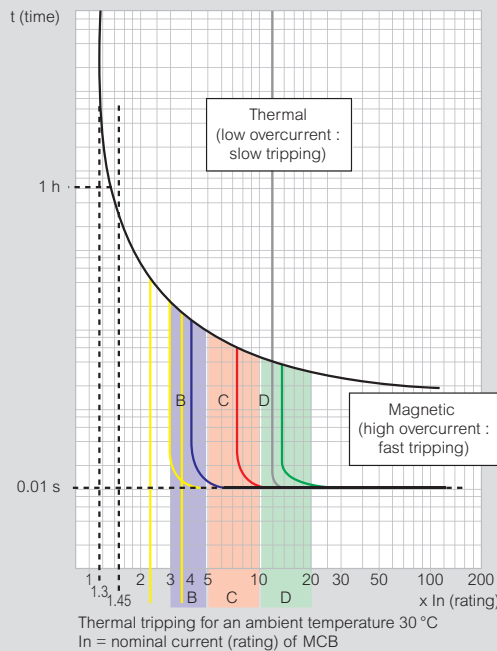

Curves	Magnetic threshold settings
B	3 to 5 In
C	5 to 10 In
D	10 to 14 In (10 to 20 acc. to the stds)

protection of DC circuits

Protection of DC circuits

DX³ 6000 and DX³ 10000 MCBs (1P/2P/3P/4P - $I_n \leq 63$ A) designed for use in 230/400 V~ supplies, can also be used in DC circuits. In this case, the following deratings and precautions must be taken into account

1 - Protection against short-circuits

Max. magnetic tripping threshold : multiplied by 1-4
 Example : For a C curve MCB for which the AC tripping threshold is between 5 and 10 I_n , the DC tripping threshold will be between 7 and 14 I_n

2 - Protection against overloads

The time/current thermal tripping curve is the same as for AC

3 - Operating voltage

Max. operating voltage : 80 V per pole (60 V for single pole + N MCBs)
 For voltages higher than this value, several poles must be wired in series

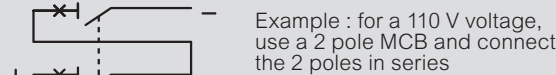

4 - Breaking capacity

4000 A for a single pole MCB at max. voltage (80 V= per pole)

For other voltages, the breaking capacities are as follows:

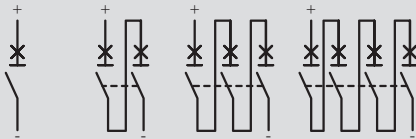

DX ³ 6000	voltage	single pole	2P	3P
Acc. to IEC 60947-2	≤ 48 V	6 kA	6 kA	
	110 V		6 kA	6 kA
	230 V			
Ics ¹	≤ 48 V	100 %	100 %	
	110 V		100 %	100 %
	230 V			

DX ³ 10000	voltage	single pole	2P	3P	4P
Acc. to IEC 60947-2	≤ 48 V	10 kA	10 kA		
	110 V		10 kA	10 kA	
	230 V				15 kA
Ics ¹	≤ 48 V	100 %	100 %		
	110 V		100 %	100 %	
	230 V				100 %

1 : As a % of Icu

5 - Distribution of breaking poles

To choose the MCB and determine the pole distribution necessary for breaking on each of the polarities, it is necessary to know how the installation is earthed

• Supply with one polarity earthed:

Place all the poles necessary for breaking on the other polarity. If isolation is required, an additional pole must be added on the earthed polarity

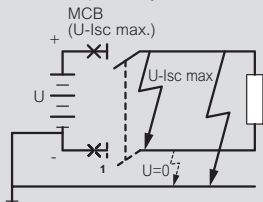

1 : Only if isolation required

Example : circuit earthed via the negative polarity / $U = 110$ V= / $I_{sc} = 10$ kA / $I_n = 32$ A

Protect the positive polarity using an MCB capable of breaking 10 kA at 110 V (DX³ 10000 2P 32 A with 2 poles on the positive polarity)
 For isolation, use a DX³ 10000 3P 32 A with 2 poles on the positive polarity and one pole on the negative polarity

DX ³ 10000	voltage	single pole	2P	3P	4P
Acc. to IEC 60947-2	≤ 48 V	10 kA	10 kA		
	110 V		10 kA	10 kA	
	230 V				15 kA

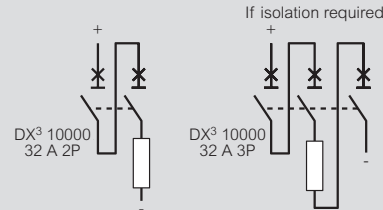

• Network earthed via a middle point:

Place on each polarity the number of poles necessary for max. I_{sc} breaking at half voltage

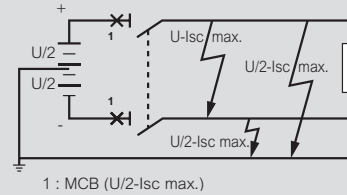

Example : circuit earthed via a middle point / $U = 230$ V= / $I_{sc} = 6$ kA / $I_n = 10$ A

Protect each polarity using an MCB capable of breaking 6 kA at half voltage, i.e. 115 V (DX³ 6000 4P 10 A with 2 poles on each polarity)

DX ³ 6000	voltage	single pole	2P	3P
Acc. to IEC 60947-2	≤ 48 V	6 kA	6 kA	
	110 V		6 kA	6 kA
	230 V			

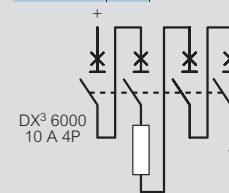

• Isolated earth supply:

Distribute the poles necessary for breaking over the 2 polarities to provide protection in the event of a double earth fault (particularly if there are a number of circuits in parallel)

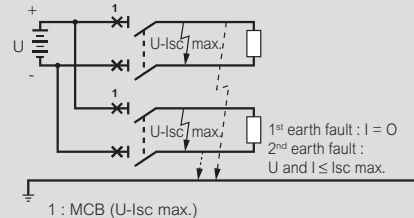

Example : isolated earth circuit / $U = 48$ V= / $I_{sc} = 4.5$ kA / $I_n = 40$ A
 Protect the installation with an MCB capable of breaking 4.5 kA at 48 V and protect each polarity (DX³ 6000 MCB 2P 40 A with one pole on each polarity)

DX ³ 6000	voltage	single pole	2P	3P
Acc. to IEC 60947-2	≤ 48 V	6 kA	6 kA	
	110 V		6 kA	6 kA
	230 V			

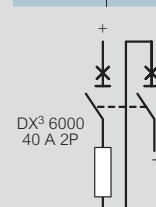

NEW

RCDs - DX³-ID

residual current devices 16 A to 100 A - AC and A types



4115 25



4117 05



4117 60



4117 90

Dimensions **p. 65**
 Technical information **p. 62**

Conform to IEC 61008-1

- AC type : detect AC component faults
 - A type : detect AC and DC component faults
- Enhanced immunity to unwanted tripping in disturbed environments
 Can be equipped with DX³ auxiliaries and accessories **p. 62**

Pack	Cat. Nos.	Double pole - 230 V \sim	
1	4115 00	AC Type 10 mA Nominal rating I _n (A) 16	Number of modules 2
1	4115 04	AC Type 30 mA 25	2
1	4115 05	40	2
1	4115 06	63	2
1	4115 07	80	2
1	4115 08	100	2
1	4115 14	AC Type 100 mA 25	2
1	4115 15	40	2
1	4115 16	63	2
1	4115 17	80	2
1	4115 24	AC Type 300 mA 25	2
1	4115 25	40	2
1	4115 26	63	2
1	4115 27	80	2
1	4115 37	AC Type 100 mA discriminating 100	2
1	4115 43	AC Type 300 mA discriminating 63	2
1	4115 50	A Type 10 mA 16	2
1	4115 54	A Type 30 mA 25	2
1	4115 55	40	2
1	4115 56	63	2
1	4115 57	80	2
1	4115 69	A Type 300 mA 25	2
1	4115 70	40	2
1	4115 71	63	2
1	4115 72	80	2
1	4115 84	A Type 300 mA discriminating 63	2

Pack	Cat. Nos.	Four pole - 400 V \sim - neutral on right-hand side	
1	4117 02	AC Type 30 mA Nominal rating I _n (A) 25	Number of modules 4
1	4117 03	40	4
1	4117 04	63	4
1	4117 05	80	4
1	4117 12	AC Type 100 mA 25	4
1	4117 13	40	4
1	4117 14	63	4
1	4117 15	80	4
1	4117 22	AC Type 300 mA 25	4
1	4117 23	40	4
1	4117 24	63	4
1	4117 25	80	4
1	4117 32	AC Type 500 mA 25	4
1	4117 33	40	4
1	4117 34	63	4
1	4117 35	80	4
1	4117 45	AC Type 300 mA discriminating 40	4
1	4117 46	63	4
1	4117 59	A Type 30 mA 25	4
1	4117 60	40	4
1	4117 61	63	4
1	4117 62	80	4
1	4117 69	A Type 100 mA 25	4
1	4117 70	40	4
1	4117 71	63	4
1	4117 72	80	4
1	4117 73	100	4
1	4117 79	A Type 300 mA 25	4
1	4117 80	40	4
1	4117 81	63	4
1	4117 82	80	4
1	4117 83	100	4
1	4117 90	A Type 500 mA 40	4
1	4117 91	63	4
1	4117 92	80	4
1	4118 00	A Type 300 mA discriminating 40	4
1	4118 01	63	4

Auxiliaries and accessories **p. 62**





Dimensions **p. 65**
 Technical information **opposite**

Pack	Cat. Nos.	Auxiliaries for RCDs	Number of modules
		Clip on the left hand side of the RCD (maximum 3) Allow insertion of the supply busbar at the top Auxiliaries common to DX ³ MCBs, RCDs and RCBOs	
		Signalling auxiliaries	
1	4062 58	Auxiliary changeover switch, 6 A - 250 V~ Indicates the position of the contacts	0.5
1	4062 60	Fault signalling changeover switch, 6 A - 250 V~ Indicates tripping of the RCD at a fault	0.5
1	4062 62	Auxiliary changeover switch, 6 A - 250 V which can be modified to a fault signalling switch	0.5
1	4062 66	Auxiliary changeover switch, 6 A - 250 V + fault signalling switch, can be modified to 2 auxiliary changeover switches	1

Accessories		
	Padlocking	
2	4063 03	Support for one Ø5 mm padlock for DX ³ MCBs and RCDs or isolating switches
3	4063 13	Ø5 mm shackle type padlock
	Spacing element	
10	4063 07	For heat reduction – 0.5 module

DX³-ID - RCDs (residual current devices)
Connection cross-section

RCDs	Cable (mm ²)	
	rigid	flexible
Connection at top and bottom	50	35

AC type - Standard applications

AC type RCDs detect AC residual currents
 In the majority of cases (standard applications), they are used for AC current detection at 50/60 Hz

A type - Specific applications: dedicated lines

In addition to the characteristics of AC type RCDs, A type RCDs also detect DC residual currents
 They are used whenever fault currents are not sinusoidal
 They are particularly suitable for the following specific applications (hobs, washing machines...) or materials that may produce DC fault currents, speed drives with frequency inverters, etc.

RCBOs DX™ 10000

residual current circuit breakers from 10 A to 45 A - AC type



6064 15

Dimensions **p. 65**
 Technical information **p. 59-60**

Breaking capacity:
 10000 - IEC 61009-1 for single pole
 • AC type : detect AC component faults

Pack	Cat. Nos.	Single pole - 230 V~ - C curve		
		Blue neutral leads		
		AC Type 30 mA		
		Nominal rating In (A)		Number of modules
1	6064 10	10		1
1	6064 11	16		1
1	6064 12	20		1
1	6064 13	25		1
1	6064 14	32		1
1	6064 15	45		1

RCBOs DX³ 6000 - 10 kA

NEW

residual current circuit breakers from 3 A to 63 A - AC type



4110 02

Dimensions **p. 65**
 Technical information **p. 59-60**

Conform to IEC 61009-1
 Breaking capacity:
 6000 - IEC 61009-1 - 10 kA / IEC 60947-2 for single pole + neutral,
 double and four pole
 • AC type : detect AC component faults
 Enhanced immunity to unwanted tripping in disturbed environments
 Can be equipped with DX³ auxiliaries and accessories **p. 64**

Pack	Cat. Nos.	Single pole + neutral - 230 V~ - B curve		
		Neutral on right-hand side		
		AC Type 30 mA		
		Nominal rating In (A)		Number of modules
1	4109 18	6		2
1	4110 19	10		2
1	4110 21	16		2
1	4110 22	20		2
1	4110 24	32		2
1	4110 25	40		2

Pack	Cat. Nos.	Single pole + neutral - 230 V~ - C curve		
		Neutral on right-hand side		
		AC Type 10 mA		
		Nominal rating In (A)		Number of modules
1	4109 93	16		2
		AC Type 30 mA		
1	4109 97	3		2
1	4109 99	6		2
1	4110 00	10		2
1	4110 02	16		2
1	4110 03	20		2
1	4110 04	25		2
1	4110 05	32		2
1	4110 06	40		2
		AC Type 300 mA		
1	4110 21	6		2
1	4110 22	10		2
1	4110 24	16		2
1	4110 25	20		2
1	4110 26	25		2
1	4110 27	32		2
1	4110 28	40		2

RCBOs DX³ 6000 - 10 kA

residual current circuit breakers from 3 A to 63 A - AC type (continued)



4111 49



4111 92



4062 58



4062 66

Dimensions p. 65
 Technical information p. 59-60

Breaking capacity:
 [6000] - IEC 61009-1 - 10 kA / IEC 60947-2 for single pole + neutral, double and four pole

• AC type : detect AC component faults
 Enhanced immunity to unwanted tripping in disturbed environments
 Can be equipped with DX³ auxiliaries and accessories opposite

Pack	Cat. Nos.	Double pole - 230 V~	Number of modules
		AC Type 10 mA	
		C curve	
1	4111 49	Nominal rating In (A)	4
1	4111 50	10	4
1	4111 51	16	4
		20	4
		AC Type 30 mA	
1	4111 57	10	4
1	4111 58	16	4
1	4111 59	20	4
1	4111 60	25	4
1	4111 61	32	4
1	4111 62	40	4
1	4111 63	50	4
1	4111 64	63	4

Pack	Cat. Nos.	Four pole - 400 V~	Number of modules
		AC Type 30 mA	
		C curve	
1	4111 85	Nominal rating In (A)	4
1	4111 86	10	4
1	4111 87	16	4
1	4111 88	20	4
1	4111 89	25	4
1	4111 89	32	4
1	4111 90	40	7
1	4111 91	50	7
1	4111 92	63	7
		AC Type 300 mA	
1	4112 04	10	4
1	4112 05	16	4
1	4112 06	20	4
1	4112 07	25	4
1	4112 08	32	4
1	4112 09	40	7
1	4112 10	50	7
1	4112 11	63	7

Pack	Cat. Nos.	Auxiliaries for RCBOs	Number of modules
		Clip on the left hand side of the RCBO (maximum 3) Allow insertion of the supply busbar at the top Auxiliaries common to DX ³ MCBs, RCDs and RCBOs	
		Signalling auxiliaries	
1	4062 58	Auxiliary changeover switch, 6 A - 250 V~ Indicates the position of the contacts	0-5
1	4062 60	Fault signalling changeover switch, 6 A - 250 V~ Indicates tripping of the RCBO at a fault	0-5
1	4062 62	Auxiliary changeover switch, 6 A - 250 V which can be modified to a fault signalling switch	0-5
1	4062 66	Auxiliary changeover switch, 6 A - 250 V + fault signalling switch, can be modified to 2 auxiliary changeover switches	1

Pack	Cat. Nos.	Accessories	Number of modules
		Padlocking	
2	4063 03	Support for one ø5 mm padlock for DX ³ MCBs and RCDs or isolating switches	
3	4063 13	ø5 mm shackle type padlock	
10	4063 07	Spacing element For heat reduction – 0-5 module	

DIN rail equipment

dimensions

■ Dimensions

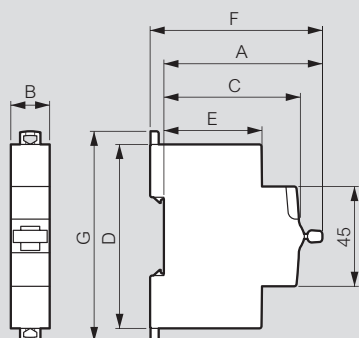

Description	Dimension (mm)										
	A	B					C	D	E	F	G
		1P	1P+N	2P	3P	4P					
DX ³ MCBs up to 63 A	71.7	17.7	35.4	35.4	53.1	70.8	61	83	44	77.8	94.8
DX ³ MCBs from 80 A to 125 A	73.1	26.7	–	53.4	80.1	106.8	61	100	47	79	104.3
DX ³ RCDs	71.7	–	–	35.6	–	71.2	61	83	44	77.8	94.8
DX ³ RCBOs 1P (up to 45 A)	68	17.7	–	–	–	–	60	115	48	74	126.8
DX ³ RCBOs 1P+PN (up to 40 A) & 4P (up to 32 A)	71.7	–	35.6	–	–	71.2	61	83	44	77.8	94.8
DX ³ RCBOs 2P & 4P (40 A to 63 A)	72	–	–	71.2	–	124.6	61	96	44	78.2	107.8
DX ³ auxiliaries	71.5	8.8 / 17.7					61	83	44	77.7	84.5
Fuse carriers	67	17.7	17.7	35.6	53.4	71.2	60	83	44	73	94

PUTTING MEASUREMENT AT THE HEART OF ENERGY EFFICIENCY

From MID¹ certified electricity meters and door mounted multi-functional displays, to remote web-based supervision software, Legrand's new EMDX³ metering range puts measurement at the heart of energy efficiency.



EMDX³ UNIT - FOR DIN RAIL



EMDX³ UNIT - FOR DOOR MOUNTING

DIN rail mounted EMDX³ measurement control units

Meter, measure, monitor and communicate all of the essential parameters of the installation on this DIN rail mounted module:

- Dual tariff metering
- Active and reactive energy
- Operating time
- Power factor
- Harmonic distortion
- Programmable alarms

Door mounted EMDX³ measurement control units

Meter, measure, monitor and communicate all of the essential parameters of the installation via a large display:

- Dual tariff metering
- Active and reactive energy
- Operating time
- Power factor
- Harmonic distortion
- Programmable alarms

For increased functionality, e.g. temperature/memory, additional modules are available. See p. 69



Any project that aims to **optimise** quality and **energy efficiency** must include measurement



DISPLAY OF 32 MEASUREMENT POINTS ON PC, TABLET AND SMARTPHONE

Remote supervision and viewing

With Legrand's communication interfaces (RS 485, IP), supervision software and Web servers, measurements can be centralised and displayed remotely on any device which is equipped with a web browser:

- Desktop / laptop
- Tablet
- Smartphone



DIN RAIL MOUNTED ELECTRICITY METER

DIN rail mounted EMDX³ electricity meter

EMDX³ meters installed in modular enclosures can be used to monitor consumption:

- By building
- By floor
- By application (e.g. lighting, heating, hot water production, power sockets)

MID certification (selected meters)

EMDX³ electrical energy meters

┌ rail mounting



0046 70

0046 74

Technical information p. 71-73

Measure the electricity consumed by a single phase or three phase circuit downstream of the electricity distribution metering. Display electricity consumption in kWh, as well as other values such as current, active energy, reactive energy and power (depending on the catalogue number).

Conform to standards IEC 62053-21/23, IEC 62052-11 and IEC 61010-1. MID compliance ensures accuracy of the metering with a view to recharging for the electricity used.

Single-phase meters

Pack	Cat. Nos.		
1	Non-MID 0046 70	MID certified	Direct connection 32 A - 1 module Pulse output
1	0046 81		36 A - 2 modules Pulse output
1	0046 72	0046 78	63 A - 2 modules Pulse output
1	0046 77	0046 79	63 A - 2 modules RS 485 output

Three-phase meters

Pack	Cat. Nos.		
1	Non-MID 0046 73	MID certified 0046 82	Direct connection 63 A - 4 modules Pulse output
1	0046 80	0046 83	63 A - 4 modules RS 485 output
1	0046 74	0046 85	Connection with CT 5 A - 4 modules pulse output
1	0046 84	0046 86	5 A - 4 modules RS 485 and pulse output

Concentrator

Pack	Cat. Nos.	
1	0046 87	For collecting and transmitting measurements taken by 7 universal pulse electricity meters. Also collects data from other meters (gas meters, water meters, etc.) RS485 output 4 modules

NEW

EMDX³ multi-function measuring units

┌ rail mounting

NEW



0046 76

Technical information p. 71-73

Conform to standards :
- IEC 61557-12
- IEC 62053-22 class 0.5 S
- IEC 62053-23 class 2

Pack	Cat. Nos.	EMDX ³ modular
		For mounting on ┌ rail Width : 4 modules • LCD display • Measurement of currents, voltages, active, reactive and apparent power and internal temperature • Dual tariff metering : - Active energy consumed - Reactive energy consumed - Operating time - Power factor • THD voltages and currents up to order 51 • Programmable alarms on all functions • Outputs for controlling wiring devices, alarm feedback and pulse feedback
1	0046 75	EMDX³ pulse unit Data transmission via pulses
1	0046 76	EMDX³ RS 485 unit Data transmission via RS 485 communication interface and pulses

EMDX³ multi-function measuring units

NEW

for mounting on door or solid faceplate



0146 68



0146 69



0146 73



0261 78



0261 89

Technical information p. 71-73

Conform to standards :

- IEC 61557-12
- IEC 62053-22 class 0-5 S
- IEC 62053-23 class 2

Pack	Cat. Nos.	EMDX³ - Access
1	0146 68	Multi-function measuring unit For mounting on door or solid faceplate Dimensions : 96 x 96 x 60 mm • LCD display • Measurement of currents, voltages, active, reactive and apparent power, internal temperature and power factor • Metering : - Active energy consumed or produced - Reactive energy consumed or produced - Operating time - Pulses • THD voltages and currents up to order 51 • Programmable alarms on all functions Can take 2 optional modules
1	0146 71	Modules for EMDX³ - Access multi-function measuring unit RS485 communication module MODBUS link
1	0146 72	1-output module Can be assigned to pulse feedback, alarm feedback or control of wiring devices

Pack	Cat. Nos.	EMDX³ - Premium
1	0146 69	Multi-function measuring units For mounting on door or solid faceplate Dimensions : 96 x 96 x 60 mm • LCD display • Measurement of currents, voltages, active, reactive and apparent power, internal temperature and power factor • Metering : - Active energy consumed or produced - Reactive energy consumed or produced - Operating time - Pulses • Individual harmonics up to order 63 • Programmable alarms on all functions Can take 4 optional modules

Pack	Cat. Nos.	EMDX³ - Premium (continued)
1	0146 73	Modules for EMDX³ - Premium multi-function measuring units RS 485 communication module MODBUS link
1	0146 74	Storage module Storage of active and reactive power over 62 days, the last 10 alarms and the average voltage and frequency values over 60 days max.
1	0146 75	Module with 2 inputs/2 outputs Up to 3 modules, i.e. 6 inputs/6 outputs, can be installed Outputs can be assigned to monitoring mode, remote control or timed remote control
1	0146 77	Temperature module Indication of the internal temperature and possibility of connecting 3 sensors for measuring the external temperature

Pack	Cat. Nos.	Communication and supervision
		Web servers Enable remote viewing, via a web browser on PCs, smartphones, web viewers, tablet computers such as iPads, Archos, etc., of values collected on electricity meters and multi-function measuring units
1	0261 78	For 32 metering points (meters or multi-function measuring units)
1	0261 79	For an unlimited number of metering points (meters or multi-function measuring units)
		Legrand software dedicated to measurement For displaying the values collected from electricity meters or multi-function measuring units on a PC connected to the network
1	0261 88	For 32 metering points (supplied on CD)
1	0261 89	For an unlimited number of metering points (supplied on CD)
		IP converter For RS485/Ethernet conversion for connecting electricity meters and multi-function measuring units to an IP network Supply voltage : 90-260 V~ 50/60Hz Dimensions : 3 modules
1	0046 89	

current transformers CT



0047 79

Pack	Cat. Nos.	Single phase current transformers (CT)								
		Used with ammeters, electricity meters or multi-function measuring units Provide a 0 to 5 A current at the secondary, proportional to the primary current For fixing on plates, EN 60715 rail Cat. Nos. 0046 31/34/36, or bars Secondary connected by terminals or lugs Precision class 1%								
		For 16 x 12.5 mm bar and Ø21 mm cable								
		<table border="1"> <thead> <tr> <th>Transformation ratio</th> <th>Output (VA)</th> </tr> </thead> <tbody> <tr> <td>50/5</td> <td>1.25</td> </tr> <tr> <td>100/5</td> <td>2.5</td> </tr> <tr> <td>200/5</td> <td>5.5</td> </tr> </tbody> </table>	Transformation ratio	Output (VA)	50/5	1.25	100/5	2.5	200/5	5.5
Transformation ratio	Output (VA)									
50/5	1.25									
100/5	2.5									
200/5	5.5									
1	0046 31									
1	0046 34									
1	0046 36									
		For 20.5 x 12.5 and 30 x 10.5 mm bar and Ø23 mm cable								
1	0047 75	300/5 11								
		For 40.5 x 10.5 mm bar and Ø35 mm cable								
1	0046 38	400/5 12								
		For 65 x 32 mm bar								
1	0047 76	600/5 12								
1	0047 77	800/5 15								
1	0047 78	1000/5 20								
		For 84 x 34 mm bar								
1	0047 79	1250/5 15								
		For 127 x 38 mm bar								
1	0046 45	1500/5 15								
1	0046 46	2000/5 20								
		For 127 x 54 mm bar								
1	0047 80	2500/5 50								
1	0046 48	4000/5 50								

Pack	Cat. Nos.	Three phase current transformers (CT)				
		Used with ammeters, electricity meters or multi-function measuring units Provide a 0 to 5 A current at the secondary, proportional to the primary current For fixing directly on bars Secondary connected by terminals or lugs Precision class 1%				
		For three 20.5 x 5.5 mm bars				
		<table border="1"> <thead> <tr> <th>Transformation ratio</th> <th>Output (VA)</th> </tr> </thead> <tbody> <tr> <td>250/5</td> <td>3</td> </tr> </tbody> </table>	Transformation ratio	Output (VA)	250/5	3
Transformation ratio	Output (VA)					
250/5	3					
1	0046 98					
		For three 30.5 x 5.5 mm bars				
1	0046 99	400/5 4				

Current transformers (CT)

Technical information

Degree of protection : IP 20
Operating frequency : 50/60 Hz

Dimensions

• Single phase CTs
Cat. Nos. 0046 31/34/36 for 16 x 12.5 mm bar and Ø21 mm cable
Fixing on EN 60715 rail

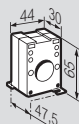

Cat. No. 0047 75 for 20.5 x 12.5 and 30 x 10.5 mm bar and Ø23 mm cable
Cat. No. 0046 38 for 40.5 x 10.5 mm bar and Ø35 mm cable
Fixing on EN 60715 rail or on plate

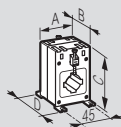

Cat. Nos.	A	B	C	D	Ø	Fixing centres on plate
0047 75	56	42	94	50	23	50 x 45
0046 38	77	46	107	54	35	54 x 45

Cat. Nos. 0047 76/77/78 for 65 x 32 mm bar
Cat. No. 0047 79 for 84 x 34 mm bar
Fixing on bar

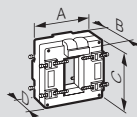

Cat. Nos.	A	B	C	D
0047 76/77/78	90	90	94	40
0047 79	96	87	116	58

Cat. Nos. 0046 45/46 for 127 x 38 mm bar
Cat. Nos. 0047 80 and 0046 48 for 127 x 54 mm bar
Fixing on bar

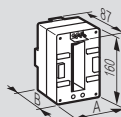

Cat. Nos.	A	B
0046 45/46	99	58
0046 48/0 047 80	125	40

• Three phase CT
Cat. No. 0046 98 for three 20.5 x 5.5 mm bars
Cat. No. 0046 99 for three 30.5 x 5.5 mm bars
Fixing on bar

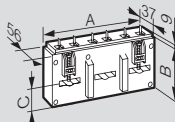

Cat. Nos.	A	B	C
0046 98	107	58.5	25
0046 99	135	66.5	30

Determination of the max. distance between CT and meter

Cat. Nos.	Max. power of CT	Meter consump. (W)	Max. loss in capac. (VA)	Max. distance bet. CT & meter (m)		
				Wiring 2.5 mm ²	Wiring 4 mm ²	Wiring 6 mm ²
0046 31	1.25	0.5	0.75	1.8	2.7	3.9
0046 34	2.5	0.5	2	4.9	7.1	10.4
0046 98	3	0.5	2.5	6.1	8.9	13
0046 99	4	0.5	3.5	8.5	12.4	18.1
0046 36	5.5	0.5	5	12.2	17.8	25.9
0047 75	11	0.5	10.5	25.5	37.3	54.4
0046 38 0047 76	12	0.5	11.5	28	40.8	59.6
0047 77/79 0046 45	15	0.5	14.5	35.3	51.5	75.2
0046 46 0047 78	20	0.5	19.5	47.4	69.3	101.1
0047 80 0046 48	50	0.5	49.5	120.4	175.8	256.7

EMDX³ electrical energy meters

└ rail mounting

■ Technical information

Single phase meters Cat. Nos. 0046 70/72/77/78/79/81

LCD display : 7 digits
 Resolution : 0.1 kWh
 Maximum indication : 99999.9 kWh
 Metrological LED : 1 Wh/pulse (Cat. No. 0046 70 : 0.5 Wh/pulse)
 Accuracy (EN 62053-21) : class 1
 Reference voltage Un : 230 V-240 V
 Reference frequency : 50-60 Hz

Three phase meters Cat. Nos. 0046 73/74/80/82/83/84/85/86

LCD display : 8 digits
 Resolution : 0.01 kWh¹
 Maximum indication : 99999.99 kWh¹
 Metrological LED : 0.1 Wh/pulse or 1 Wh/pulse
 Active energy accuracy (EN 62053-21) : class 1
 Reactive energy accuracy (EN 62053-23) : class 2
 Reference voltage Un :
 - Single phase : 230-240 V
 - Three phase : 230(400)-240(415) V
 Operating limit range (EN 62053-21, EN 62053-23) :
 - Single phase : 110 to 254 V
 - Three phase : 110(190) to 254(440) V

Cat. Nos.	0046 70	0046 81	0046 72	0046 77	0046 78	0046 79	0046 73	0046 80	0046 82	0046 83	0046 74	0046 84	0046 85	0046 86	
Number of modules	1	2	2	2	2	2	4	4	4	4	4	4	4	4	
Connection	Direct	●	●	●	●	●	●	●	●	●					
	Via a current transformer										●	●	●	●	
	Single phase	●	●	●	●	●	●				●	●			
	Three phase							●	●	●	●	●	●	●	
Max. current	32 A	36 A	63 A	63 A	63 A	63 A	63 A	63 A	63 A	63 A	5 A (CT)	5 A (CT)	5 A (CT)	5 A (CT)	
Metering and measurement	Total active energy	●	●	●	●	●	●	●	●	●	●	●	●	●	
	Total reactive energy										●	●	●	●	
	Partial active energy (reset)		●	●	●	●	●	●	●	●	●	●			
	Partial reactive energy (reset)										●	●			
	Active power			●	●	●	●	●	●	●	●	●	●	●	
	Reactive power							●	●	●	●	●	●	●	
	Apparent power							●	●	●	●	●	●	●	
	Current			●	●	●	●	●	●	●	●	●	●	●	
	Voltage			●	●	●	●	●	●	●	●	●	●	●	
	Frequency			●	●	●	●	●	●	●	●	●	●	●	
	Power factor			●	●	●	●	●	●	●	●	●	●	●	
	Time-of-use			●	●										
	Average active power							●	●	●	●	●	●	●	
	Max. average active power value							●	●	●	●	●	●	●	
Dual tariff							●								
Communication	Pulse output	●	●	●		●	●	●	●	●	●	●	●	●	
	RS 485 interface				●	●		●	●	●		●	●	●	
MID compliant					●	●			●	●			●	●	
Operating conditions	Reference temperature	23 °C ± 2 °C													
	Operating temperature	-20 to +55 °C	-10 to +45 °C					-5 to +55 °C							
	Storage temperature	-40 to +70 °C	-25 to +70 °C					-25 to +70 °C							
	Consumption	≤ 8 VA					≤ 4 VA per phase					≤ 1 VA per phase			
	Heat dissipation	≤ 6.5 W					≤ 6 W					≤ 4 W			

■ Interfacing with IP communication network

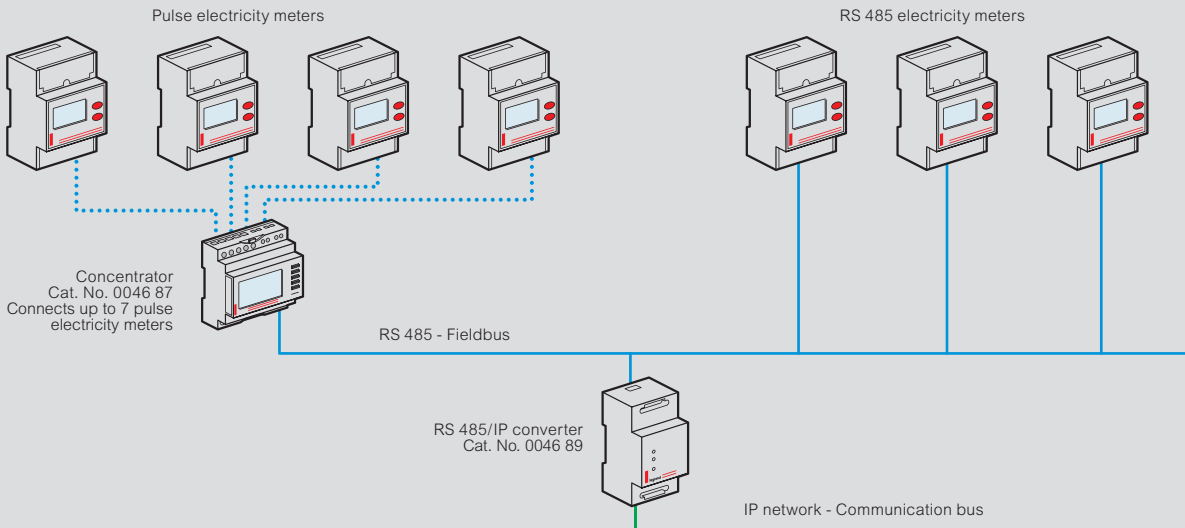

1 : For direct connection meters
 If connected via transformers, the resolution and maximum indication depend on the transformation ratios of these transformers

EMDX³ multi-function measuring units

■ Technical information

Cat. Nos.		0046 75/76	0146 68	0146 69	
Connection	Current measurement terminals	4 mm ²	6 mm ²	6 mm ²	
	Other terminals	2.5 mm ²	2.5 mm ²	2.5 mm ²	
Protection index	Front cover	IP 51	IP 52	IP 52	
	Casing	IP 20	IP 30	IP 30	
Weight		205/215 g	400 g	400 g	
Display		Backlit LCD	Backlit LCD	Backlit LCD	
Measurements		3P+N, 3P, 2P, 1P+N	3P+N, 3P, 2P, 1P+N	3P+N, 3P, 2P, 1P+N	
Voltage measurement	Direct	Phase/phase	50 to 520 V \sim	50 to 500 V \sim	18 to 700 V \sim
		Phase/neutral	28 to 300 V \sim	28 to 289 V \sim	11 to 404 V \sim
	From a PT	Primary	–	–	≤ 500 kV
		Secondary	–	–	60, 100, 110, 115, 120, 173, 190 V \sim
	Permanent overload between phases		760 V \sim	800 V \sim	760 V \sim
	Update period		1 s	1 s	1 s
Current measurement	From a CT	Primary	5 to 9999 A	≤ 9999 A	≤ 9995 A
		Secondary	5 A	5 A	1 or 5 A
	Minimum measurement	5 mA	5 mA	10 mA	
	Input consumption	< 0.6 VA	< 0.6 VA	< 0.3 VA	
	Display	0 to 9999 A	1 to 11 kA	0 to 11 kA	
	Permanent overload	6 A	6 A	10 A	
	Intermittent overload	60 A/1 s - 120 A/0.5 s	10 In/1 s	10 In/1 s	
	Update period	1 s	1 s	1 s	
	Max. CT x PT ratio	–	–	10000000	
	Power measurement	Total	0 to 9999 kW/kvar/kVA	0 to 11 MW/Mvar/MVA	0 to 8000 MW/Mvar/MVA
Update period		1 s	1 s	1 s	
Frequency measurement	Measurement range	45.0 to 65.0 Hz	45.0 to 65.0 Hz	45.0 to 65.0 Hz	
	Update period	1 s	1 s	1 s	
Auxiliary power supply	50/60 Hz	200 to 277 V \sim ±15%	110 to 400 V \sim ±10%	110 to 400 V \sim ±10%	
	DC	–	120 to 350 V= ±20%	120 to 350 V= ±20%	
	Consumption	< 5 VA	< 10 VA	< 10 VA	
Operating temperature		-10 °C to +55 °C	-10 °C to +55 °C	-10 °C to +55 °C	
Storage temperature		-20 °C to +70 °C	-20 °C to +85 °C	-20 °C to +85 °C	

■ Flush-mounting dimensions Cat. Nos. 0146 68/69

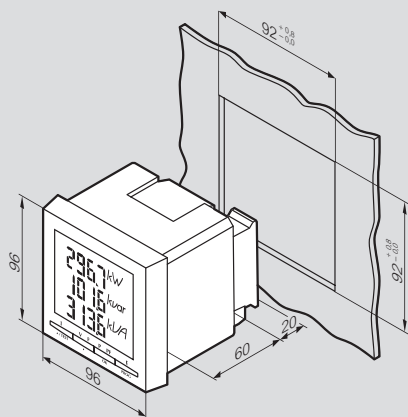

■ Fixing on door Cat. Nos. 0146 68/69

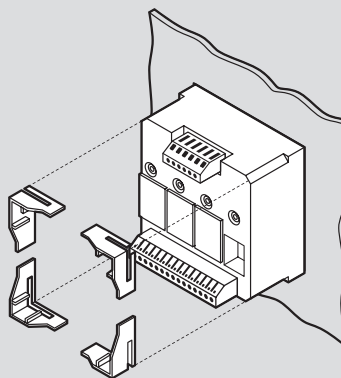

■ Fitting modules Cat. Nos. 0146 68/69

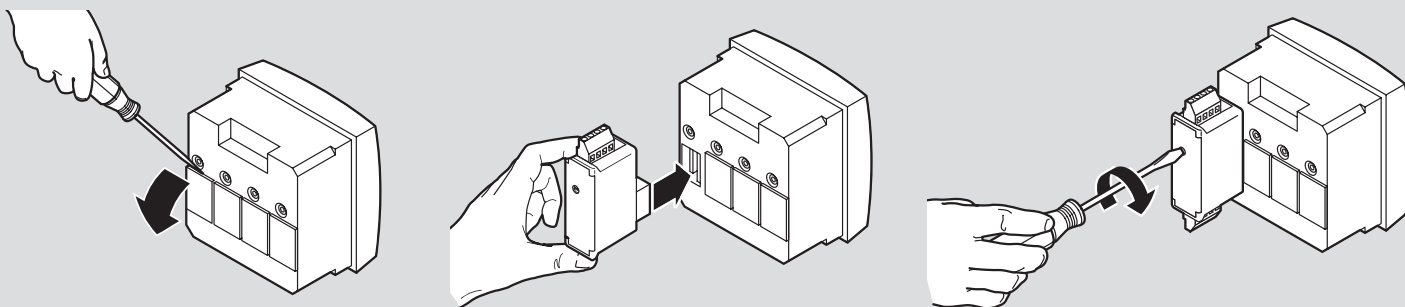

■ Connection solutions

Unbalanced three phase network (3 or 4 wire)

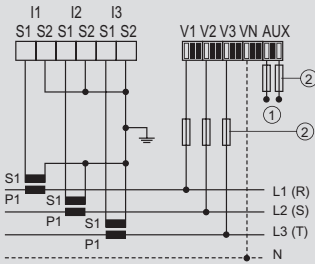

(3 wire)

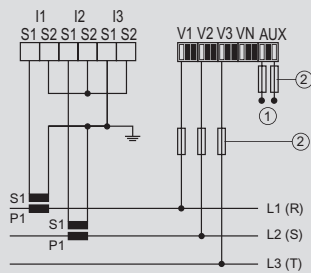
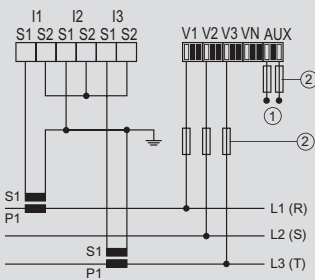

Balanced three phase network (3 or 4 wire)

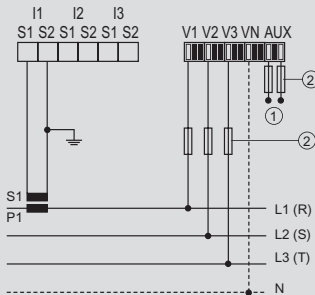

Single phase network (2 wire)

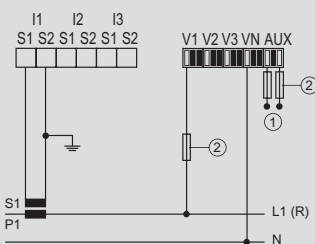

Two phase network (2 wire)

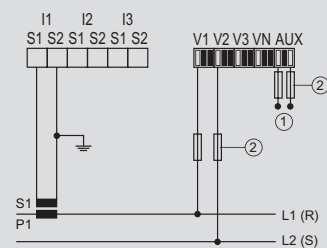

- ① Auxiliary power supply : 110 ... 400 VAC/120 ... 350 VDC
 ② Fuse : 0.5 A gG/BS 88 2A gG/0.5 A class CC

■ Wiring example of communication network

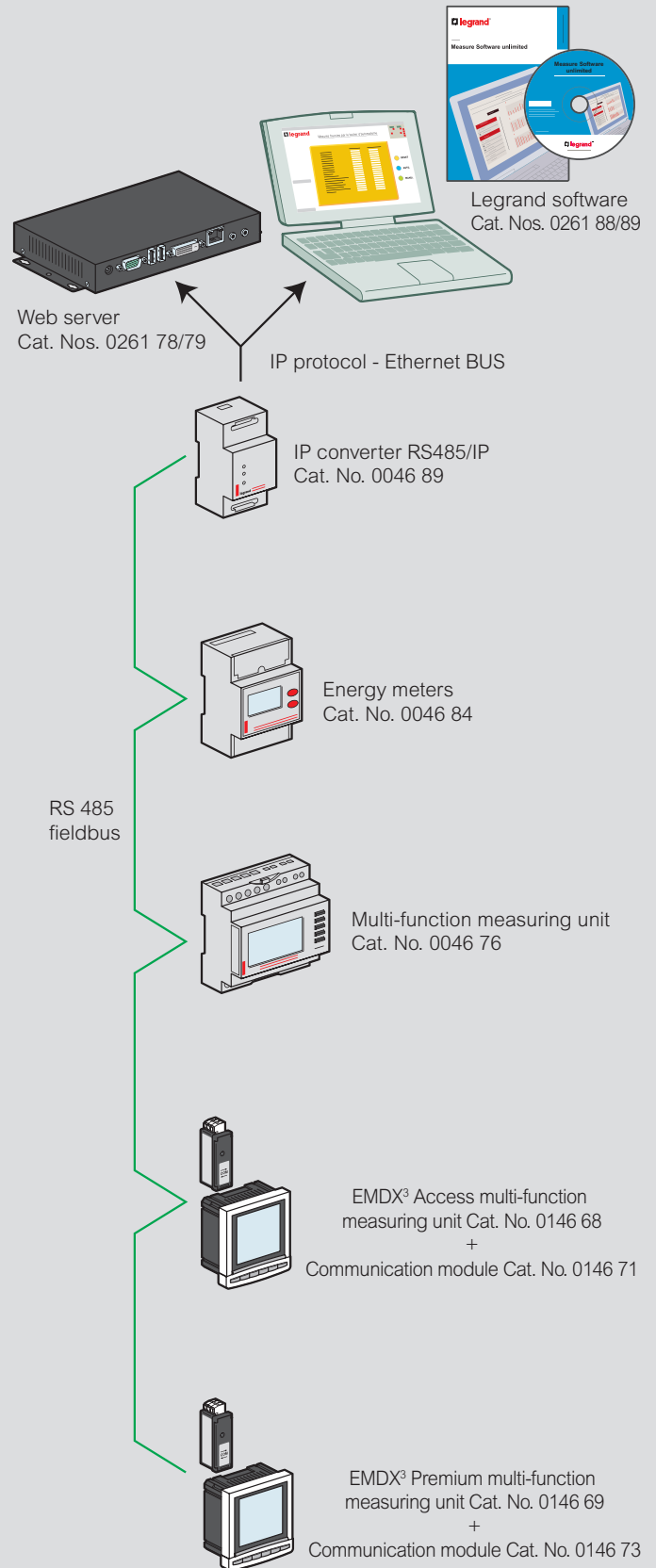

modular fuse carriers

for industrial cylindrical cartridge fuses

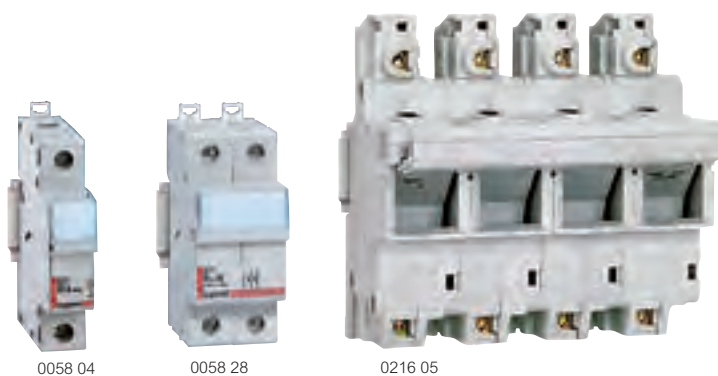

Dimensions **opposite**
Accessories **p. 75**

For HRC cylindrical fuses (see p. 76)

Pack	Cat. Nos.	Modular carriers for HRC type aM and gG fuses	
		Conform to IEC 60269-2/2-1, isolation to IEC 60947-3 Fix to DIN rail EN 60715 Equipped with label holder Padlockable using locking accessory Cat. No. 0057 99, p. 75 Shielded terminals max. capacity 2 x 10 mm ² Double insulated Class II	
		Fuse size (mm)	Voltage ~ (Volts)
			No. of 17.5 mm modules
		Single pole	
10	0058 04	Disconnectable neutral	500
10	0058 06	8.5 x 31.5	400
10	0058 08	10 x 38	500
		Single pole + Neutral	
10	0058 16	8.5 x 31.5	400
10	0058 18	10 x 38	500
		Double pole	
5	0058 28	10 x 38	500
		Triple pole	
3	0058 38	10 x 38	500
		Triple pole + Neutral	
2	0058 48	10 x 38	500

		SP isolating fuse carriers with protected terminals	
		For isolation and protection of electrical circuits Conform to IEC 60269-2 and BS EN 60269-2 Bureau Veritas approved Height under front plate : 44 mm Fix to DIN rail EN 60715 or with screws	
		SP 51 for HRC type aM and gG fuses 14 x 51	
		Connection	No. of 17.5 mm modules
5	0215 01	Single pole	1.5
1	0215 03	Double pole	3
1	0215 04	Triple pole	4.5
1	0215 05	Triple pole + disconnectable neutral	6
		SP 58 for HRC type aM and gG fuses 22 x 58	
		Connection	No. of 17.5 mm modules
3	0216 00	Disconnectable neutral	2
3	0216 01	Single pole	2
1	0216 04	Triple pole	6
1	0216 05	Triple pole + disconnectable neutral	8

Modular fuse carriers

Conform to IEC 60269-2/2-1, isolation to IEC 60947-3
Icc : 20 kA with 8.5 x 31.5 fuse
100 kA with 10 x 38 fuse
Operating temperature : -5 °C to +40 °C
Mechanical resistance : IPXX 3

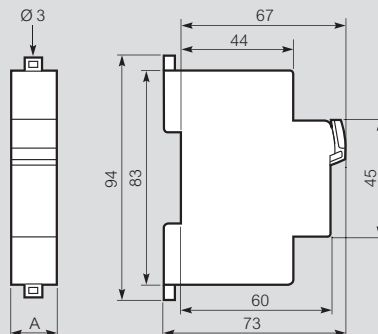

In mm	A
Single pole	17.7
Single pole + N	17.7
Double pole	35.5
Triple pole	53.4
Triple pole + N	71.2

SP 51 and SP 58 fuse carriers

Conform to IEC 60269-2 and BS EN 60269-2
Bureau Veritas approved

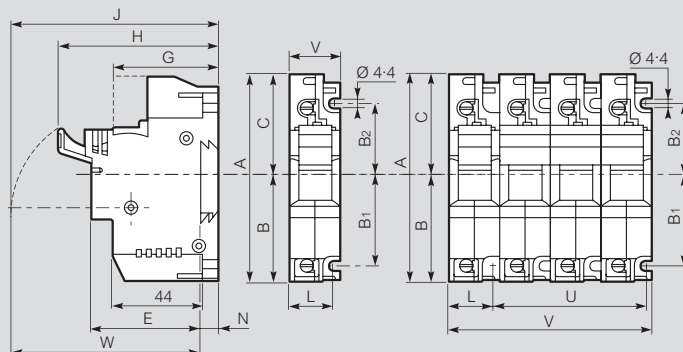

In mm	A	B	B ₁	B ₂	C	E	G	H 1 P	H multi.	J 1 P
SP 51	106	54.5	45	35	51.5	55	53	81	84	96
SP 58	140	74	65	45	66	59	53	87	90	111

In mm	J multi.	L	N	U 2 P	U 3 P	U 4 P	V 1 P	V 2 P	V 3 P	V 4 P	W 1 P	W multi.
SP 51	99	20.7	9	26.5	53	79.5	26.5	53	79.5	106	87	90
SP 58	114	27	9	36	72	108	36	72	108	144	101	109

Choice of equipment

Type	Rated current	Maximum cartridge rating			
		400 V ~		500 V ~	
		gG	aM	gG	aM
SP 51	50 A	50	50	50	40
SP 58	100 A (125 A in 400 V)	125	125	100	100

Protection index : IP 2X - IP 2X C - under front plate

Equipment derating

Justified under more severe conditions of use :

- Ambient temperature over 35 °C : derate fuse by one rating per 10 °C (UTE C 20-051)
- Side-by-side equipment in simultaneous function

2 or 3 devices	0.9 x I _n
4 or 5 devices	0.8 x I _n
6, 7, 8 or 9 devices	0.7 x I _n
≥ 10 devices	0.6 x I _n

This coefficient is to be applied on the nominal rating of the base (IEC 60439-1)
Continuous operation : it may be necessary to upgrade the bases by one size

Modular protective terminal shield mounting (see p. 75)

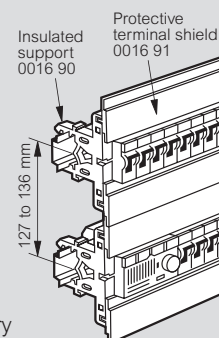

modular fuse carriers and device accessories



4049 05

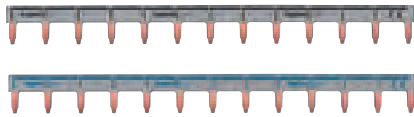

4049 26



0016 91



0016 90

Pack	Cat. Nos.	Modular fuse carrier accessory
3	0057 99	Padlock support suitable for Ø 5 mm padlocks

Pack	Cat. Nos.	Modular device accessories	
10	4063 07	Spacing elements For heat reduction - 0-5 module	
2	4063 03	Locking device Attachment for Ø 5 mm padlocks for DX ³	
3	4063 13	Padlock Ø 5 mm	
20	4049 05	Entry terminals Accepts conductors 4-25 mm ² max for single pole busbars only IP 2X	
20	4049 06	Entry terminals Accepts conductors 6-35 mm ² max	
20	4049 26	Supply busbars For 13 single pole units ¹ Reversible blue/black	
10	4049 37	Supply busbars For 57 single pole units ¹ Reversible blue/black	
5	4049 38	Supply busbars For 6 double pole units ^{2,3}	
10	4049 39	Supply busbars For 28 double pole units ^{2,3}	
5	4049 42	Supply busbars For 4 triple pole units ^{2,3}	
10	4049 43	Supply busbars For 19 triple pole units ^{2,3}	
3	4049 44	Supply busbars For 3 four pole units ^{2,3}	
20	4049 88	Insulation shroud For non-utilised busbar prongs	
10	0049 96	Self-adhesive label holder Width : 16 mm Width available for marking : 12 mm Length 430 mm (24 modules)	
10	0016 65	Grey blanking plate RAL 7035 18 module, blanking strip	

1 : 16 mm² section rated at 80 A with central feed
2 : 10 mm² section rated at 63 A with central feed
3 : With insulated ends

Pack	Cat. Nos.	Modular device accessories (continued)
5	0016 91	Protective terminal shield Light grey Ensures the protection of wiring and terminals in modular mechanisms fitted in enclosures (Atlantic or Marina) Width 45 mm, Length 1 m Clips on to support 0016 90 (below)
10	0016 90	Insulated support For protective terminal shield Clips on to rail EN 60715

DX³ MCBs p. 56-57



Enclosures p. 14-23



cylindrical cartridge fuses

HRC



Dimensions p. 79

Numbers refer to physical size of fuse i.e. 10 x 38 means Ø 10 mm x 38 mm length

Pack	Cat. Nos.	Miniature type 5 x 20		
		Type F (fast acting) fuse Ceramic body Conform to IEC 60127-2 For use with transformers (see p. 90), Viking 3 terminals (see p. 118) etc.		
		Rating (Amps)	Voltage ~ (Volts)	Breaking capacity (Amps)
10	0102 02	0.2		
10	0102 05	0.5		
10	0102 06	0.63		
10	0102 10	1		
10	0102 12	1.25		
10	0102 16	1.6		
10	0102 20	2	250	1 500
10	0102 25	2.5		
10	0102 30	3.15		
10	0102 50	5		
10	0102 63	6.3		
10	0102 96 ¹	10	250	500

Pack	Cat. Nos.	Type gG		
		Conform to BS EN 60269-1, IEC 60269-1 Bureau Veritas approved		
		Rating (Amps)	Voltage ~ (Volts)	Breaking capacity (Amps)
		Without indicator		
		8 x 32		
10	0123 01	1		
10	0123 02	2		
10	0123 04	4		
10	0123 06	6		
10	0123 08	8	400	20 000
10	0123 10	10		
10	0123 12	12		
10	0123 16	16		

1 : Overrating not described by standards

Pack	Cat. Nos.	Type gG industrial		
		HRC (high rupturing capacity) Conform to BS EN 60269-1 and 2 (BS 88) IEC 60269-1, 2 and 2-1 Bureau Veritas approved		
		Rating (Amps)	Voltage ~ (Volts)	Breaking capacity (Amps)
		Without indicator		
		10 x 38		
10	0133 94	0.5		
10	0133 01	1		
10	0133 02	2		
10	0133 04	4		
10	0133 06	6	500	100 000
10	0133 08	8		
10	0133 10	10		
10	0133 12	12		
10	0133 16	16		
10	0133 20	20		
10	0133 25	25		
		Without striker		
		14 x 51		
10	0143 02	2		
10	0143 04	4		
10	0143 06	6		
10	0143 10	10		
10	0143 16	16	500	100 000
10	0143 20	20		
10	0143 25	25		
10	0143 32	32		
10	0143 40	40		
10	0143 50	50		
		Without striker		
		22 x 58		
10	0153 10	10		
10	0153 16	16		
10	0153 20	20		
10	0153 25	25	500	100 000
10	0153 32	32		
10	0153 40	40		
10	0153 50	50		
10	0153 63	63		
10	0153 80	80		
10	0153 96	100		
10	0153 97	125	400	

Pack	Cat. Nos.	Neutral links	
10	0123 00	8 x 32	
10	0133 00	10 x 38	
10	0143 00	14 x 51	
10	0153 00	22 x 58	

High breaking capacity suits industrial applications



cylindrical cartridge fuses

HRC (continued)

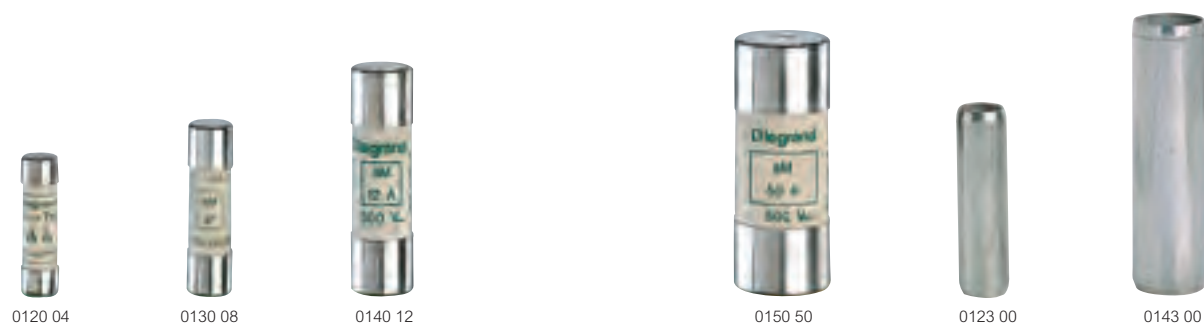

Dimensions p. 79

Numbers refer to physical size of fuse i.e. 10 x 38 means Ø 10 mm x 38 mm length

Pack	Cat. Nos.	Cylindrical type aM (motor rated)		
		Conform to BS EN 60269-1 (BS 88) IEC 60269-1 Bureau Veritas approved		
		Rating (Amps)	Voltage ~ (Volts)	Breaking capacity (Amps)
	Without indicator	8 x 32		
10	0120 02	2	400	20 000
10	0120 04	4		
10	0120 06	6		
10	0120 10	10		
		HRC (high rupturing capacity) Conform to BS EN 60269-1 and IEC 60269-1, 2 and 2-1 Bureau Veritas approved		
	Without indicator	10 x 38 HRC		
10	0130 95	0.5	500	100 000
10	0130 01	1		
10	0130 02	2		
10	0130 04	4		
10	0130 06	6		
10	0130 08	8		
10	0130 10	10		
10	0130 12	12		
10	0130 16	16		
10	0130 20 ¹	20		
10	0130 25 ¹	25	400	
	Without striker	14 x 51 HRC		
10	0140 04	4	500	100 000
10	0140 06	6		
10	0140 10	10		
10	0140 12	12		
10	0140 16	16		
10	0140 20	20		
10	0140 25	25		
10	0140 32	32		
10	0140 40	40		
10	0140 45 ²	45		
10	0140 50 ²	50	400	

Pack	Cat. Nos.	Cylindrical type aM (motor rated) (continued)			
		HRC (high rupturing capacity) Conform to BS EN 60269-1 (BS 88) IEC 60269-1, 2 and 2-1 Bureau Veritas approved			
		Rating (Amps)	Voltage ~ (Volts)	Breaking capacity (Amps)	
	Without striker	22 x 58 HRC			
10	0150 32	32	500	100 000	
10	0150 40	40			
10	0150 50	50			
10	0150 63	63			
10	0150 80	80			
10	0150 96	100			
10	0150 97 ²	125			400
		Neutral links			
10	0123 00	8 x 32			
10	0133 00	10 x 38			
10	0143 00	14 x 51			
10	0153 00	22 x 58			

1 : Overrating not described by standards
2 : Overrating described by standards

HRC blade type cartridge fuses

gG/aM type



Dimensions p. 79

Pack	Cat. Nos.	Type gG (IEC)/gL (VDE)		
		HRC (high rupturing capacity) Conform to BS EN 60269-1 and 2, IEC 60269-1,2 and 2-1, VDE 0636-21 Bureau Veritas approved Fully insulated end plate and handle lugs		
	With indicator	Rating (Amps)	Voltage ~ (Volts)	Breaking capacity (Amps)
	Size 00			
10	0163 18	25	500	120 000
10	0163 20	32		
10	0163 25	40		
10	0163 30	50		
10	0163 35	63		
10	0163 40	80		
10	0163 45	100		
10	0163 50	125		
10	0163 55	160		
	Size 0			
3	0168 45	100	500	120 000
3	0168 50	125		
3	0168 55	160		
3	0168 60 ¹	200		
	Size 1			
3	0173 50	125	500	120 000
3	0173 55	160		
3	0173 60	200		
3	0173 65	250		
	Size 2			
3	0178 60	200	500	120 000
3	0178 65	250		
3	0178 70	315		
3	0178 75	400		

Pack	Cat. Nos.	Type aM (motor rated)		
		HRC (high rupturing capacity) Conform to BS EN 60269-1 and 2, IEC 60269-1,2 and 2-1, VDE 0636-21 Bureau Veritas approved Fully insulated end plate and handle lugs		
	With indicator	Rating (Amps)	Voltage ~ (Volts)	Breaking capacity (Amps)
	Size 00			
3	0160 25	40	500	120 000
3	0160 30	50		
3	0160 35	63		
3	0160 40	80		
3	0160 45	100		
3	0160 50	125		
	Size 0			
3	0165 35	63	500	120 000
3	0165 40	80		
3	0165 45	100		
3	0165 50	125		
3	0165 55	160		
	Size 1			
3	0170 50	125	500	120 000
3	0170 55	160		
3	0170 60	200		
3	0170 65	250		
	Size 2			
3	0175 60	200	500	120 000
3	0175 65	250		
3	0175 70	315		

Neutral blades		
1	0168 04	Size 0
1	0173 04	Size 1
1	0178 04	Size 2
1	0181 04	Size 3

Handle	
5	0199 02 Removable handle for all sizes

1 : Overrating not described by standards

cartridge fuses

dimensions

■ Cylindrical fuses (p. 76-77)

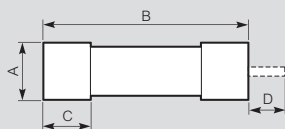

Size	A	B	C	D
8 x 32 (mm)	8.5	31.5	6.3	–
10 x 38 (mm)	10.3	38	10	–
14 x 51 (mm)	14.3	51	13	7.5
22 x 58 (mm)	22.2	58	16	7.5

■ Blade type fuses (p. 78)

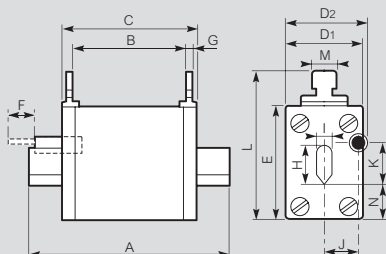

Size	00	0	1	2
A (mm)	78	125	135	150
B (mm)	44	62	64	64
C (mm)	52	67	74	74
D₁ (mm)	30	36	47	50
D₂ (mm)	–	39	47	50
E (mm)	46	46	52	60
F (mm)	–	14	14	14
G (mm)	2.5	2.5	3	3
H (mm)	15	15	21	28
I (mm)	6	6	6	6
J (mm)	–	14.5	16	19
K (mm)	–	14.5	14.5	14.5
L (mm)	59	59	64	72
M (mm)	10	10	10	10
N (mm)	14.5	14.5	14.5	14.5

■ Neutral blades (p. 78)

Sizes 0 to 3

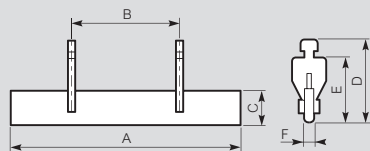

Size	0	1	2	3
A (mm)	125	135	150	150
B (mm)	65	65	65	65
C (mm)	15	20	26	38
D (mm)	45	50	58	66.5
E (mm)	35	40	48	56.5
F (mm)	6	6	6	6

■ Removable handle (p. 78)

For sizes 00 - 0 - 1 - 2

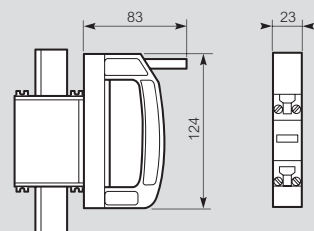

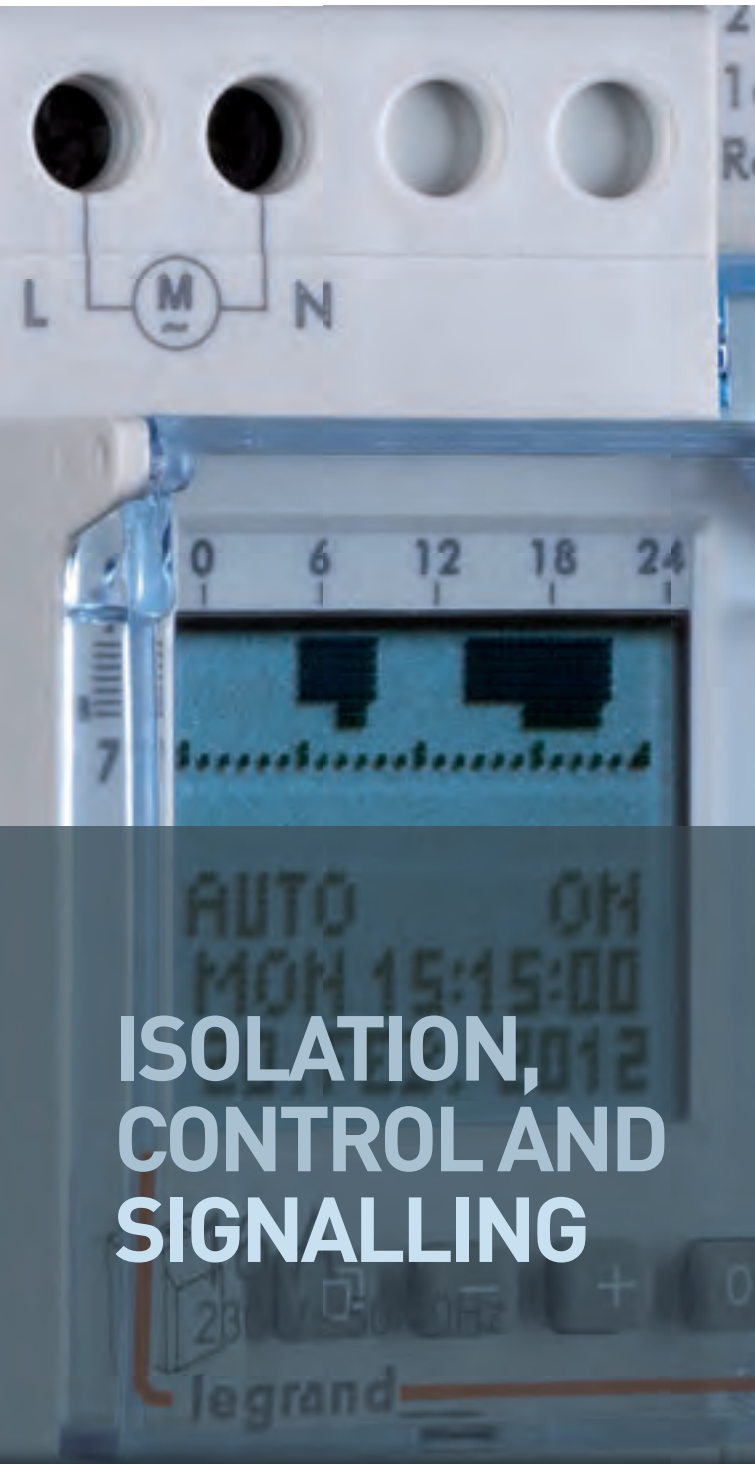

ISOLATION, CONTROL AND SIGNALLING

Isolating and changeover switches

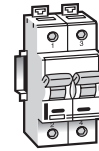

NEW
P. 84
DX³
isolating switches
16 to 125 A

Transformers

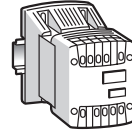

P. 90
Control, signalling
and safety isolation
transformers

Power supplies

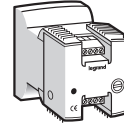

P. 96
Filtered
power supplies

Signalling



NEW
P. 98
CX³
power contactors

Time switches and light control switches



P. 106
AlphaRex³
programmable
digital for rail

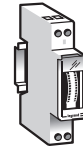

P. 111
MicroRex
analogue for rail

NEW 2014



DX³
isolating switches
(p. 84)



CX³
power contactors
(p. 98)

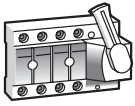

P. 85
Vistop
isolating switches
63 to 160 A



P. 86
Vistop
technical
information



P. 87
Changeover
switches



P. 87
Changeover
switches technical
information



P. 91
Control transformers
dimensions
and electrical
characteristics

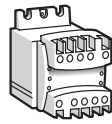

P. 92
Compact
transformers



P. 93
Compact transformers
dimensions
and electrical
characteristics



P. 94
How to calculate
rated power
and transformer
protection



P. 97
Filtered
power supplies
technical
information



P. 97
Filtered
power supplies
electrical
characteristics



P. 100
CX³
power contactors
technical
information

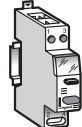

P. 101
Push buttons/
control switches
and indicators

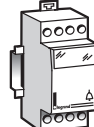

P. 102
Transformers



P. 103
Modular DIN
rail equipment
dimensions



P. 106
AlphaRex³ Astro
programmable
digital for rail



P. 109
MicroRex D Plus
digital for rail



P. 109
MicroRex D
digital for rail

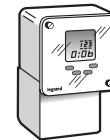

P. 110
MaxiRex
digital surface or
panel mounting

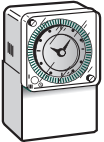

P. 112
MaxiRex
analogue
surface and panel
mounting

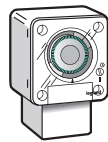

P. 112
EconoRex
analogue
surface and panel
mounting

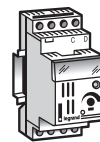

P. 113
Programmable
light sensitive
switch
digital for rail

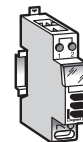

P. 113
Electronic
time-lag switch
digital for rail

ISOLATION, CONTROL AND SIGNALLING

Developments within Legrand's isolation, control and signalling range include new DX³ isolating switches which boast the same design improvements as DX³ MCBs, RCDs, RCBOs (see p. 54), and in addition new CX³ contactors which are available with or without handle.



NEW

DX³ ISOLATING SWITCHES

FEATURES

- Double break contacts
- Locking possible in open and closed position

TECH DATA

Category of use:	AC 22A / 23A
Current rating:	16A to 125A
Rated voltage:	250V / 400V

Vistop isolating switches also available. see p. 85



CHANGEOVER SWITCHES

FEATURES

- Locking accessories available
- Two way, double two way and two way with centre point options

TECH DATA

Category of use:	AC 22A
Nominal rating:	20A
Rated voltage:	250V / 400V

NEW

DX³... next generation DIN rail devices

Isolating switches, MCBs, RCDs, RCBOs, control and signalling auxiliaries... the guarantee of finding the function you need with a uniform appearance and optimised dimensions.

See page 54 to find out more about the new DX³ range

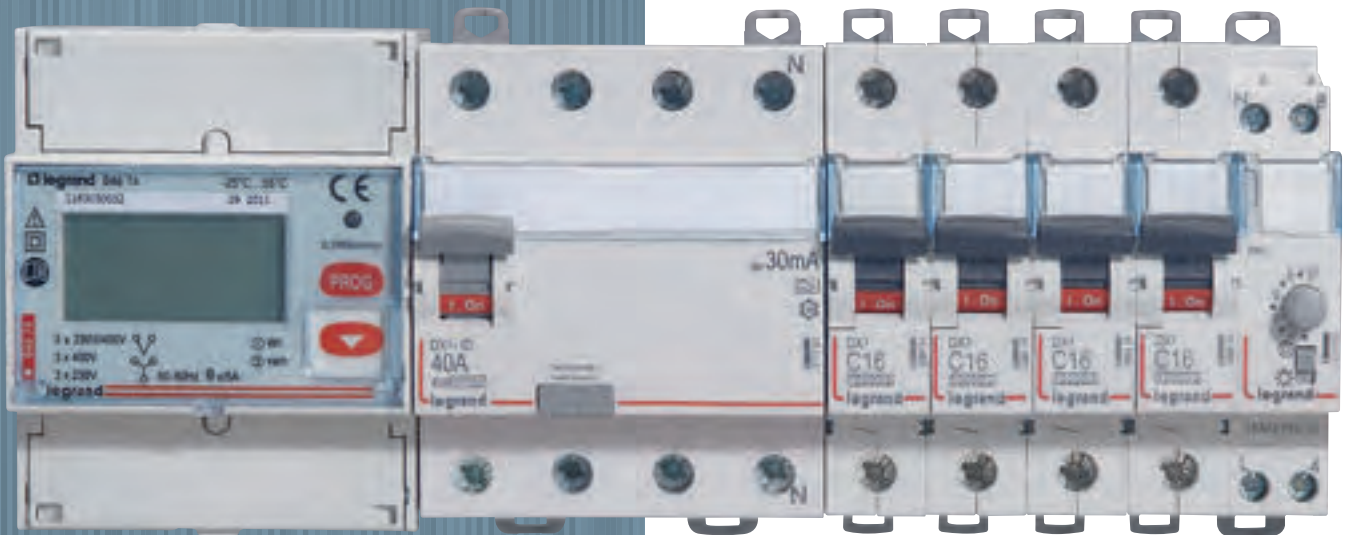

THE FIGHT AGAINST COUNTERFEIT... MANY DX³ PRODUCTS ARE MARKED WITH A UNIQUE REGISTRATION NUMBER. VISIT LEGRAND-COPYTRACER.COM

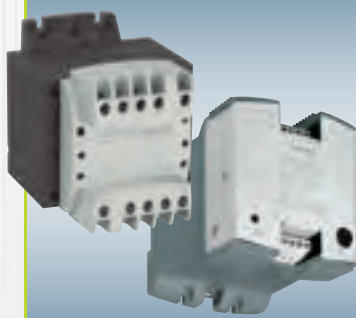

TRANSFORMERS AND POWER SUPPLIES

FEATURES

- Control, signalling and safety isolation transformers
- Compact transformers
- Filtered power supplies

For further information see p. 90 to 97



NEW

CX³ POWER CONTACTORS

FEATURES

- Contact choice: N/O - normally open
N/C - normally closed
- Easy fixing of control and auxiliaries ensures optimum strength
- Available with or without handle
- Independent screw connection / wiring of control and power terminals at any one time



TIME SWITCHES

FEATURES

- Digital and analogue versions available
- DIN rail and surface mounting options
- AlphaRex³ programmable range

For further information see p. 104 to 113

It's a push button, it's a control switch... you decide

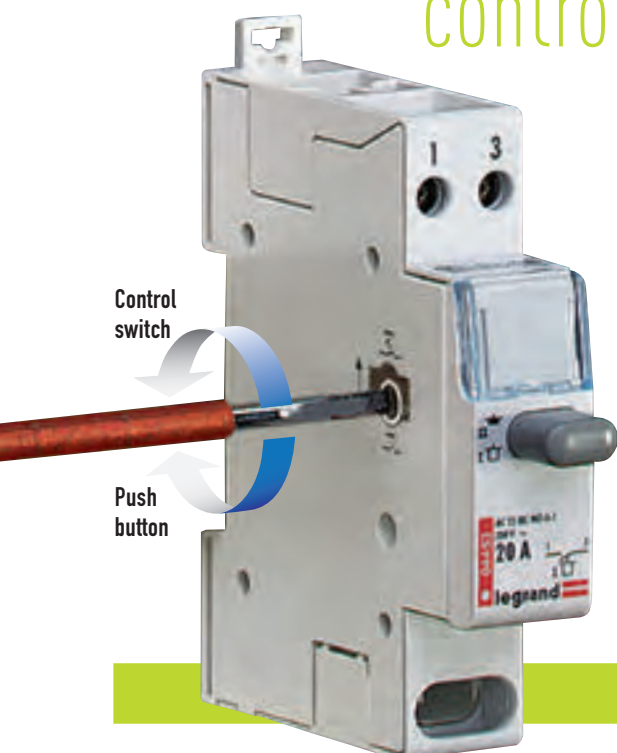

Turn a momentary contact into a maintained contact at the turn of a button with Legrand's versatile push button / control switches.

Available with normally open (N/O), normally closed (N/C) or both N/O and N/C contacts, and in single function or dual function with indicators.

GO TO PAGE 101 TO FIND OUT MORE

isolating switches DX³-IS

16 to 125 A



4064 59



4064 81

Dimensions **p. 103**
 Technical information **opposite**

AC 23 A according to BS EN 60947-3 and IEC 60947-3, AC 22 A for 125 A
 Double break contacts
 Visible contact indicator

Pack Cat. Nos. **Isolating switches**

		Grey handle Can be equipped with 1 DX ³ signalling auxiliary (p. 58) Lock in open and closed position with locking device Cat. No. 4063 03 and Ø 5 mm padlock Cat. No. 4063 13 Label holder for circuit identification	
1P - 250 V~			
		Nominal rating I _n (A)	Number of modules
10	4064 00	16	1
10	4064 01	20	1
10	4064 03	32	1
10	4064 11	40	1
10	4064 12	63	1
10	4064 23	100	1
2P - 400 V~			
10	4064 31	16	1
10	4064 32	20	1
10	4064 34	32	1
5	4064 40	40	2
5	4064 41	63	2
5	4064 53	63 with red handle	2
5	4064 55	100 with red handle	2
5	4064 50	125	2
2P with indicator - 400 V~			
		Supplied with lamp Do not accept auxiliaries	
10	4064 36	20	1
10	4064 38	32	1
3P - 400 V~			
5	4064 57	20	2
5	4064 59	32	2
1	4064 60	40	3
1	4064 61	63	3
1	4064 75	100 with red handle	3
1	4064 70	125	3
4P - 400 V~			
5	4064 77	20	2
5	4064 79	32	2
1	4064 80	40	4
1	4064 81	63	4
1	4064 95	100 with red handle	4
1	4064 90	125	4

Accessories

2	4063 03	Support for one Ø5 mm padlock for DX ³ MCBs and RCDs or isolating switches	
3	4063 13	Ø5 mm shackle type padlock	
2	4063 04	Sealable screw cover - 4 separable poles For DX ³ isolating switches, 1 module per pole	
1	4063 05	Insulating shields For DX ³ isolating switches, 1 module per pole Pole insulating shield (set of 6)	

DX³-IS isolating switches

Electrical characteristics

Thermal rating (I _{th})	16 - 40 A	40 - 63 A	100 - 125 A
Terminals	Cage	Cage	Cage
Connection	flexible	1.5 to 10 mm ²	4 to 35 mm ²
	rigid	1.5 to 16 mm ²	1.5 to 35 mm ²
Insulation voltage (H _i)	500 V~	500 V~	500 V~
Impulse withstand voltage (U _{imp})	6 kV	6 kV	6 kV
Category of use ¹	AC 22 A	AC 22 A	AC 22 A
Short time withstand current (I _{cw})	750 A	2000 A	2500 A
Short-circuit making capacity (I _{cm})	1500 A	3000 A	3700 A
No. of electrical operations	30000	20000	5000
Protection index	IP 2X wired	IP 2X wired	IP 2X wired

¹ : test conditions according to IEC 60947-3
 AC 22 A : combined motor/resistor breaking with frequent operations

Vistop™ isolating switches

63 to 160 A



0225 15

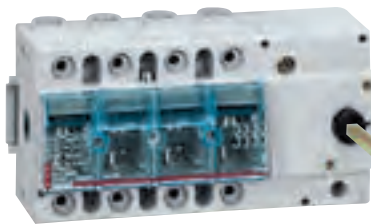

0225 53



0227 32



0227 98

Dimensions and technical information p. 86

Conform to BS EN 60947-3

Bureau Veritas approved

Safety switches for on-load circuit breaking by visible isolation of the contacts

Double break type load switching with self cleaning contacts by rapid make and break movements

Fixing on rail EN 60715 or screw fixing (only on rail for Vistop 63 A)

2 versions for mounting on faceplate : direct front handle or external handle with Cat. No. 0227 32

Pack	Cat. Nos.	Vistop isolating switches with black handle - 63 to 160 A		
		Possibility to add auxiliary contact Cat. No. 0227 07		
	Front handle			
1	0225 12	63 A	Connection	Number of 17.5 mm modules
1	0225 15	3P	Cage terminals	7
		4P		7
		100 A		
1	0225 20	3P	Key	7.5
1	0225 22	4P	6 sides	9
		125 A		
1	0225 34	3P	Key	7.5
1	0225 39	4P	6 sides	9
		160 A		
1	0225 51	3P	Key	7.5
1	0225 53	4P	6 sides	9

Pack	Cat. Nos.	Auxiliary isolating switch 2 pole - 16 A - 400 V		
		For creating 3 or 4 pole assemblies for simultaneous breaking of 2 pole auxiliary power supply (PLC, remote control), 16 A maximum Mounts on the left side of Vistop 100 to 160 A		
1	0227 22	2 P	Connection Cage terminals	Number of 17.5 mm modules 1.5
1	0227 98	Sealable terminal shields Set of 2 separate, sealable terminal shields Clip on upstream and/or downstream of Vistop 160 A		

Pack	Cat. Nos.	Front external handle kit	
1	0227 32	Comprising : connection rod, bracket, self-adhesive drilling template, fixing accessories (including a seal to maintain the IP protection of enclosure up to IP 55) and locking mechanism to prevent opening of the door when the circuit is closed Door distance 35 to 470 mm	

Pack	Cat. Nos.	Auxiliary switches for on-off signalling IP 2X - 5 A - 250 V	
		N/O + N/C contact For incorporation in one-piece enclosure	
1	0227 04	Main contact	
		2 N/C + 2 N/O mounting	
1	0227 07	Additional N/C + N/O auxiliary contact	Connection (mm ²) lug 2-58
		2 N/C + 2 N/O mounting	

Changeover switches p. 87
Fuse carriers p. 74



Vistop™ isolating switches

63 to 160 A (continued)

Conform to standards BS EN 60947-3, EN / IEC 60947-3, VDE 0660, NBN EN 60947-3, CNOMO E03 - 15-611 R, Bureau Veritas approved Glass fibre reinforced insulating casing, self-extinguishing at 960 °C (IEC EN 60695-2-1)
Handle can be padlocked in open position using 1 to 3 padlocks Ø6 mm

Electrical characteristics

Thermal rating (Ith)	63 A	100 A	125 A	160 A
Terminals	cage	cage	cage	cage
Connection	Cu (flexible)	4 to 50 mm ²		
	Cu (rigid)	4 to 70 mm ²		
Insulating voltage (Ui)	690 V~	800 V~	800 V~	800 V~
Impulse resistant voltage (Uimp)	8 kV	8 kV	8 kV	8 kV
AC 22 A ¹	400 V	63 A (35 kW)	100 A (55 kW)	125 A (70 kW)
	500 V	63 A (44 kW)	100 A (69 kW)	125 A (87 kW)
		160 A (88 kW)		
AC 23 A ¹	690 V	63 A (44 kW)	100 A (69 kW)	125 A (87 kW)
		160 A (110 kW)		
	690 V	40 A (38 kW)	100 A (96 kW)	125 A (120 kW)
DC 22 A/250 V ^{1,2}	63	100	125	125
DC 23 A/250 V ^{1,2}	63	100	125	125
Breaking capacity (Icu) (kA peak)	15	15	15	15
1 s resistant current (Icw) (kA rms)	2.5	3.5	3.5	3.5
Icc with fuses (kA rating)	100	100	100	80
Fuse rupture capacity	63 A	100 A (gG) 63 A (aM) ³	125 A (gG) 125 A (aM) ³	160 A (gG) 125 A (aM)
Short circuit capacity (Icm) (kA prospective peak)	7	12	12	12
Mechanical endurance (No. of operations)	> 30000	> 30000	> 30000	> 30000
Index of protection	IP 2X B (IP 3X C under front plates) from 6 mm ²	IP 2X B (IP 3X C under front plate) from 10 mm ²		

1 : Test according to IEC 60947-3
AC 22 A / DC 22 A : resistive motor breaking
AC 23 A / DC 23 A : inductive motor breaking
2 : No of breaking contacts : 2
3 : 100 A (aM) with blade type cartridge fuses

Example of mounting with Vistop 100 to 160 A

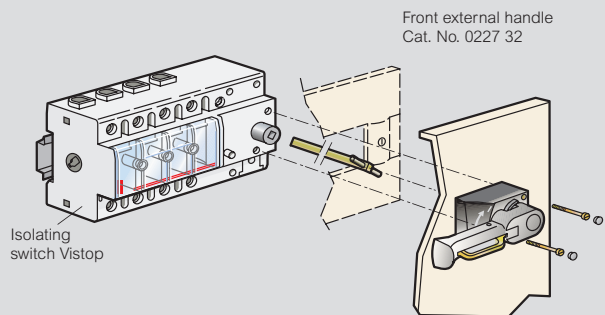

Dimensions

Front handle 63 to 160 A

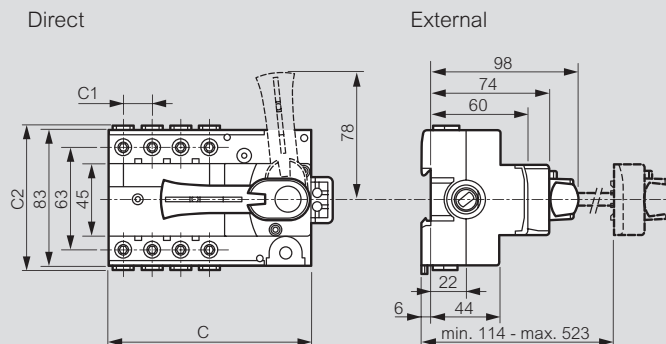

	Front handle		
	63 A	100 A, 125 A, 160 A	
	3P and 4P	3P	4P
C	125	133	160
C ₁	17.7	26.7	
C ₂	90	91	

changeover switches



0043 82



0043 83

Dimensions and technical information **opposite**

Pack	Cat. Nos.	Changeover switches	No. of 17.5 mm modules
10	0043 82	Conform to IEC 60669-1 Breaking capacity AC 22 A according to BS EN 60947-3 Nominal rating (A) Two way - 250 V~ 20	1
5	0043 83	Double two way - 400 V~ 20	2
10	0043 85	Two way with centre point - 250 V~ 20	1



Pack	Cat. Nos.	Accessories
2	4063 03	Padlocking Support for one Ø5 mm padlock
3	4063 13	Ø5 mm shackle type padlock

Protection index

Class II
 IP 2X protection against direct contact

Mechanical characteristics

• **Environmental conditions**
 Operating temperature : -5 °C to +40 °C

Dimensions

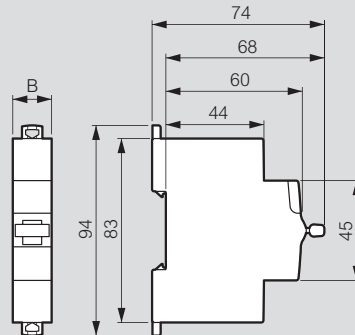

Cat. Nos.	B
0043 82/85	17-7
0043 83	35-6

Installation

- **Mounting**
 - on symmetrical rail EN 50-022
 - with Ø3 mm screw on plate using ends of released claws
 - supply via the top or the bottom
 - operating position : vertical

Wiring

Conductors permitted

Flexible with end caps	1.5 to 4 mm ²
Rigid	1.5 to 4 mm ²

Tools required :

Flat blade screwdriver	Ø4 mm
Posidrive screwdriver	Pz 1

Tightening torque

Min.	0.8 Nm
Max.	1.8 Nm
Recommended	1.2 Nm

TRANSFORMERS AND POWER SUPPLIES

the reliable choice

Specifically designed to meet the needs of control and signalling, isolation and safety isolation, Legrand's open type single phase transformers are suited to a multitude of applications.

The offer is complemented by a range of filtered power supplies, specifically for 12 or 24 V DC applications.



MEETING THE STANDARDS



CONTROL &
SIGNALLING
IEC / EN 61558-2-2



ISOLATING
IEC / EN 61558-2-4



SAFETY ISOLATING
IEC / EN 61558-2-6



CONTROL, SIGNALLING AND ISOLATION TRANSFORMERS

Ideal for heavy automation systems, industrial process systems and complex machinery.

FEATURES

- Primary tapping +/- 15 V
- 40 VA to 4000 VA
- Permanent laser engraved markings
- DIN rail mounting or mounting plate fixing
- Integral electrostatic shield
- Interference/disturbance filter
- Visible terminals ensure safe and reliable connections
- Supplied complete with voltage links

TECHNICAL DATA

APPROVALS: IEC/EN 61558-2-2, IEC/EN 61558-2-4, IEC/EN 61558-2-6, UL, CSA

PROTECTION: IP2X up to 400 A, IK04

OPERATING TEMPERATURE: up to 50° C without derating

RECOMMENDED PROTECTION: via a gG type fuse or by C type circuit breaker



COMPACT TRANSFORMERS

Ideal for standard systems where compact dimensions are a key installation requirement.

FEATURES

- Fixed secondary voltage: 24 V range
- 40 VA to 630 VA
- Noise filtering up to 220 VA
- Permanent laser engraved markings
- Multiple fixing options: standard plate mounting
DIN rail mounting optional
- Visible terminals ensure safe and reliable connections
- Supplied complete with voltage links

TECHNICAL DATA

APPROVALS: IEC/EN 61558-2-4, IEC/EN 61558-2-6

OPERATING TEMPERATURE: up to 35° C without derating

RECOMMENDED PROTECTION: Type T fuses for 40 VA and 63 VA
Type C MCBs for 100 VA and greater

FILTERED POWER SUPPLIES

A range of filtered power supplies for PLCs and other equipment requiring a voltage of 12 V DC or 24 V DC.

FEATURES

- Ripple factor < 3%
- Twin output terminals for ease of connection
- DIN rail or mounting plate fixing
- Noise filtering
- Integrated secondary fuse protection
- Supplied with busbar for quick connection between neutral and earth (up to 15 V)

TECHNICAL DATA

APPROVALS: IEC/EN 61558-2-6, UL, CSA

OPERATING TEMPERATURE: Up to 60° C without derating

control, signalling and safety isolation transformers

open type single phase



0442 35



0442 68



0442 71

Dimensions and technical information **p. 91**

IP 2X or IP XXB up to 400 VA
 IP XXA above 400 VA - IK 04
 Conform to IEC/EN 61558-2-2 and 2-4 or 2-6
 UL506 and CSA C22-2-N°66
 Products suitable for building into equipment conforming to EN 61131-2, EN 60204-1 and EN 61439 standards
 Insulated covers up to 1 000 VA provided
 Interference/disturbance filter included
 Screw fix to mounting plate or clip on to DIN rail up to 250 VA
 Supplied with 0V/Earth connection link up to 1 000 VA

Single phase

Pack	Cat. Nos.	Power in VA		
		according to IEC and CSA	according to UL	Admissible instantaneous power at $\cos \varphi = 0.5$
1	0442 31	40	40	52
1	0442 32	63	63	87
1	0442 33	100	100	150
1	0442 34	160	140	250
1	0442 35	250	210	420
1	0442 36	400	300	900
1	0442 37	630	500	1 700
1	0442 38	1 000	700	2 000
1	0442 39	1 600	700	8 500
1	0442 40	2 500	1 400	3 300

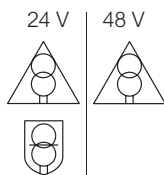

Single phase

Pack	Cat. Nos.	Power in VA		
		according to IEC and CSA	according to UL	Admissible instantaneous power at $\cos \varphi = 0.5$
1	0442 61	40	40	50
1	0442 62	63	63	86
1	0442 63	100	100	150
1	0442 64	160	140	250
1	0442 65	250	210	430
1	0442 66	400	300	1 200
1	0442 67	630	500	1 600
1	0442 68	1 000	700	2 000
1	0442 69	1 600	700	6 100
1	0442 70	2 500	1 300	7 100
1	0442 71	4 000	2 400	11 400

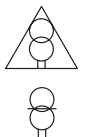

Secondary protection

Transformers can be protected by a gG type fuse **p. 76** or by a C type circuit breaker **p. 56**

Multiple fixing possibilities

- DIN rail **p. 26**
- Lina 12-5 plates **p. 23**
- Lina 25 plates **p. 23**

Modular transformers **p. 102**



control, signalling and safety isolation transformers

open type single phase (continued)

■ Dimensions

Fig. 1 : 40 to 400 VA

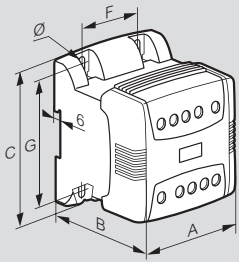

Fig. 2 : 630 to 1 000 VA

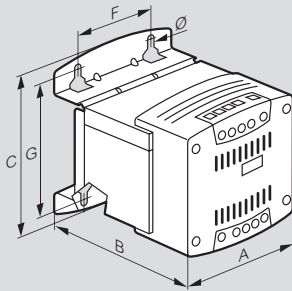

Fig. 3 : 1 600 to 2 500 VA

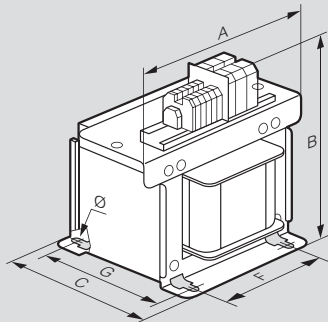
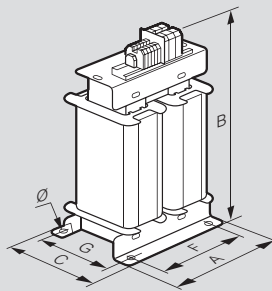

Fig. 4 : 4 000 to 8 000 VA



■ Electrical characteristics

Single phase 50-60 Hz - Class 1
 Insulation voltage between windings : 4 510 V
 Maximum ambient operating temperatures : 50 °C without derating

Voltage adjustment

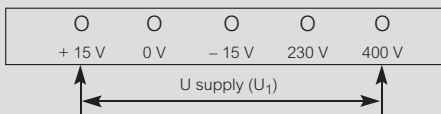

- 1) if $U_1 > 230$ or 400 V
- 2) if $I_2 < I_{2n}$ (if the load is less than the nominal load reduce the secondary voltage)

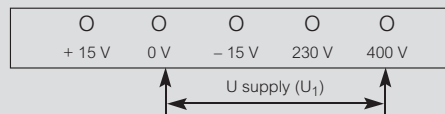

if $U_1 = 230$ or 400 V with load $I_2 = I_{2n}$

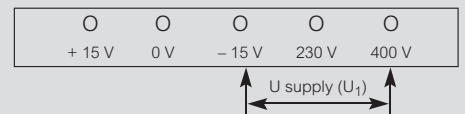

if $U_1 < 230$ or 400 V with load $I_2 = I_{2n}$

Cat. Nos.	Power (VA)	Admissible instantaneous power (VA) at cos φ of :									No-load loss (W)	On-load loss ¹ (W)	Voltage drop as (%) with cos φ :			Efficiency (%) with cos φ :			Ucc (%)	Connection capacity			
		0.2	0.3	0.4	0.5	0.6	0.7	0.8	0.9	1			0.3	0.6	1	0.3	0.6	1		Primary cable (mm ²)		Secondary cable (mm ²)	
Primary 230-400 V ± 15 V - Secondary 24-48 V																							
0442 31	40	63	58	55	52	50	48	48	49	60	3.9	7.3	8.7	10.5	8.5	62	77	84	10.0	1 to 4	1 to 4	1 to 4	1 to 4
0442 32	63	110	102	94	87	83	79	77	78	91	6.0	14.2	7.5	9.4	8.5	57	73	82	9.0	1 to 4	1 to 4	1 to 4	1 to 4
0442 33	100	200	180	160	150	140	130	130	130	150	8.2	15.1	7.3	9.3	8.9	66	80	87	8.9	1 to 4	1 to 4	1 to 4	1 to 4
0442 34	160	340	300	270	250	230	220	210	210	230	11.2	24.6	5.8	7.6	7.7	66	80	87	7.2	1 to 4	1 to 4	1 to 4	1 to 4
0442 35	250	550	490	450	420	400	380	370	370	430	14.9	31.4	5.2	6.6	6.2	70	83	89	6.1	1 to 4	1 to 4	1 to 4	1 to 4
0442 36	400	1800	1300	1100	900	800	700	600	600	500	18.3	46.3	2.1	3.7	5.6	72	84	90	4.2	1 to 4	1 to 4	1 to 4	1 to 4
0442 37	630	2700	2200	1900	1700	1500	1300	1200	1200	1200	24.1	49.4	2.0	3.0	3.9	79	88	93	3.3	1 to 16	1 to 16	1 to 16	1 to 16
0442 38	1000	3400	2800	2300	2000	1800	1600	1500	1400	1300	44.2	74.4	1.3	1.9	2.9	80	89	93	2.4	1 to 16	1 to 16	1 to 16	1 to 16
0442 39	1600	12800	10900	9500	8500	7700	7100	6700	6400	6600	65.5	94.7	1.1	1.6	1.9	84	91	94	1.7	2.5 to 10	1.5 to 16	4 to 16	1.5 to 25
0442 40	2500	4300	3900	3600	3300	3100	3000	2900	2900	3400	86.5	143.4	1.8	2.2	2.0	84	91	95	1.9	4 to 16	1.5 to 25	4 to 35	2.5 to 50
Primary 230-400 V ± 15 V - Secondary 115-230 V																							
0442 61	40	62	57	53	50	48	47	46	47	57	3.9	7.4	8.7	10.5	8.8	62	76	84	10.1	1 to 4	1 to 4	1 to 4	1 to 4
0442 62	63	110	100	93	86	82	78	76	76	90	6.0	11.8	7.6	9.6	8.9	62	76	84	9.2	1 to 4	1 to 4	1 to 4	1 to 4
0442 63	100	200	180	160	150	140	140	130	130	150	8.2	17.3	7.2	9.2	8.6	63	78	85	8.7	1 to 4	1 to 4	1 to 4	1 to 4
0442 64	160	330	300	270	250	240	230	220	220	250	11.2	23.4	5.8	7.4	7.1	67	80	87	6.9	1 to 4	1 to 4	1 to 4	1 to 4
0442 65	250	560	510	460	430	410	390	380	370	430	14.9	31.7	5.2	6.6	6.2	70	83	89	6.1	1 to 4	1 to 4	1 to 4	1 to 4
0442 66	400	2200	1700	1400	1200	1000	910	830	760	730	18.3	43.9	2.1	3.6	5.2	73	85	90	4.1	1 to 4	1 to 4	1 to 4	1 to 4
0442 67	630	2700	2200	1800	1600	1400	1200	1100	1000	1000	24.1	53.2	2.1	3.3	4.5	78	88	92	3.6	1 to 16	1 to 16	1 to 16	1 to 16
0442 68	1000	3400	2800	2300	2000	1800	1600	1500	1400	1300	44.2	73.6	1.3	2.0	2.7	80	89	93	2.2	1 to 16	1 to 16	1 to 16	1 to 16
0442 69	1600	8700	7500	6600	6100	5400	5000	4700	4500	4700	65.5	95.3	1.1	1.5	1.8	83	91	94	1.5	2.5 to 10	1.5 to 16	2.5 to 10	1.5 to 16
0442 70	2500	9200	8300	7600	7100	6700	6300	6200	6100	7100	86.5	150.1	1.8	2.3	2.2	83	91	94	2.0	4 to 16	1.5 to 25	4 to 16	1.5 to 25
0442 71	4000	16500	14300	12700	11400	10500	9800	9200	8900	9500	87.4	234.8	2.1	2.9	3.3	84	91	94	2.7	4 to 16	1.5 to 25	4 to 16	1.5 to 25

1 : Total losses at nominal load

■ Fixing

On perforated plates Lina 25 and on Lina 12.5 plates **p. 23**
 On symmetrical rail up to 250 VA
 fixing centres pitch 25 mm up to 1000 VA

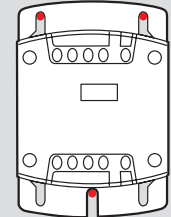
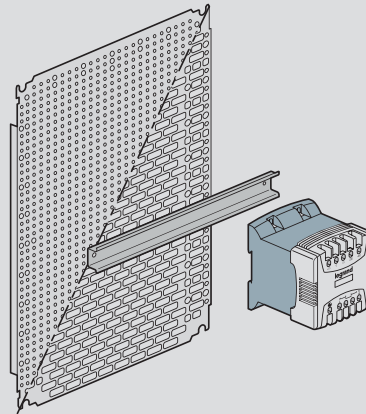

Oblong fixings : Attachment at 3 points possible

Cat. Nos.	Power (VA)	Fig.	Dimensions (mm)			Fixing ¹ (mm)			Weight (Kg)
			A	B	C	F	G	Ø	
0442 31/61	40	1	94	78	113	50	100	5.2	1.23
0442 32/62	63	1	94	85	113	50	100	5.2	1.56
0442 33/63	100	1	94	94	113	50	100	5.2	1.95
0442 34/64	160	1	94	112	113	50	100	5.2	2.6
0442 35/65	250	1	106	123	115	50	100	5.2	3.82
0442 36/66	400	1	120	140	140	62.5	125	5.2	5.62
0442 37/67	630	2	150	158	206	100	175	7	9.9
0442 38/68	1000	2	150	199	206	100	175	7	14.9
0442 39/69	1600	3	220	245	191	150	153	9	25.6
0442 40/70	2500	3	300	292	171	200	114	9	33.1
0442 71	4000	4	230	340	205	180	130	11	31

Note : 40-250 VA transformers have juxtaposed windings with an insulated barrier to provide insulation and interference filtering. Higher ratings have an electrostatic screen between windings

1 : Up to 250 VA may be fixed to symmetrical DIN rail

compact transformers

open type single phase

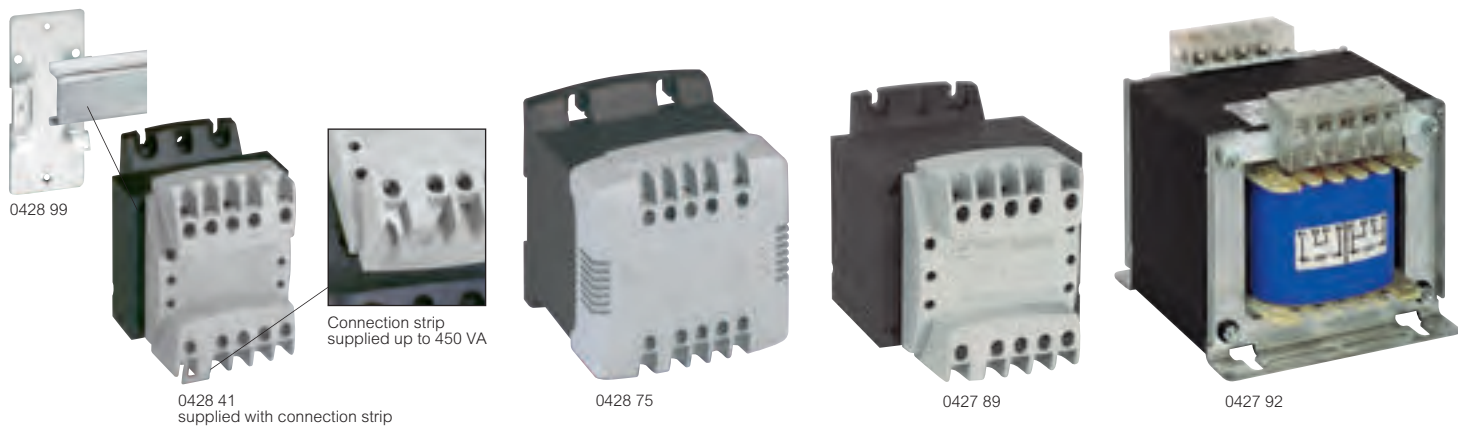

Technical information and dimensions p. 93
Transformer protection p. 95

Isolating and safety isolating <math>< 50\text{ V}</math> transformers
Designed to meet the needs of users with specific VA ratings such as original equipment manufacturers
The terminals are designed to provide easy and quick connections
Transformers up to 160 VA can be clipped to rail using accessory or directly fixed using screws through the easily accessible fixing points
Multiple fixing possibilities :
- clip to DIN rail using Cat. No. 0044 16 or 0428 99 ($\leq 160\text{ VA}$)
- screw directly on to Lina 12.5 or Lina 25 mounting plate ($\geq 220\text{ VA}$)
Recommended protection :
• for 40 and 63 VA : Type T fuses (5x20) time delay fuse to IEC 60127
• for $>100\text{ VA}$ use MCB Type C

Pack	Cat. Nos.	Single phase	
Safety isolating transformers			
Primary : 230-400 V			
Secondary : 12-24 V			
		Power in VA according to IEC/EN	Admissible instantaneous power at $\cos \varphi 0.5$
1	0428 40	40 VA	55
1	0428 41	63 VA	91
1	0428 42	100 VA	140
1	0428 43	160 VA	205
1	0428 44	220 VA	290
1	0428 45	310 VA	345
1	0428 47	630 VA	1 520
Primary : 230-400 V			
Secondary : 24 V			
		Power in VA according to IEC/EN	Admissible instantaneous power at $\cos \varphi 0.5$
1	0428 55	40 VA	55
1	0428 56	63 VA	91
1	0428 57	100 VA	140
1	0428 58	160 VA	205
1	0428 59	220 VA	290
1	0428 60	310 VA	345
1	0428 61	450 VA	1 100
1	0428 62	630 VA	1 520
Safety isolating transformers			
Primary : 230-400 V			
Secondary : 24-48 V			
		Power in VA according to IEC/EN	Admissible instantaneous power at $\cos \varphi 0.5$
1	0428 70	40 VA	55
1	0428 71	63 VA	80
1	0428 72	100 VA	150
1	0428 73	160 VA	160
1	0428 74	220 VA	290
1	0428 75	310 VA	345
1	0428 77	630 VA	1 520

Pack	Cat. Nos.	Single phase	
Isolating transformers			
Primary : 230-400 V			
Secondary : 115 V			
With centre tap			
		Power in VA according to IEC/EN	Admissible instantaneous power at $\cos \varphi 0.5$
1	6423 62	63 VA	91
1	6423 63	100 VA	140
1	6423 64	160 VA	205
1	6423 65	220 VA	290
1	6423 66	310 VA	345
1	6423 68	630 VA	1 520
Isolating transformers			
Primary : 230-400 V			
Secondary : 115-230 V			
		Power in VA according to IEC/EN	Admissible instantaneous power at $\cos \varphi 0.5$
1	0427 85	40 VA	55
1	0427 86	63 VA	91
1	0427 87	100 VA	140
1	0427 88	160 VA	205
1	0427 89	220 VA	290
1	0427 90	310 VA	345
1	0427 92	630 VA	1 520

Pack	Cat. Nos.	Accessories
10	0044 16	Clips for fixing up to 160 VA on to rail EN 60715
		Claw width 10 mm Threaded hole for M4 screws (Use two clips per transformer)
5	0428 99	Mounting bracket DIN rail mounting bracket

Modular transformers p. 102



Protection devices p. 56-64



compact transformers

open type single phase (continued)

Technical information

Conform to IEC / EN 61558-2-4 for 48 V, 115 V and 230 V and IEC / EN 61558-2-6 for 12 V and 24 V secondary

Products suitable for building into equipment conforming to EN 61131-2, EN 60204-1 and EN 61439 standards

IP 2X or IP XXB up to 250 VA - IK 04

Single phase 50-60 Hz - Class I

Insulation voltage : Primary/Secondary 4 470 V

Primary/Earth 2 240 V

Secondary/Earth (12 - 24 V) = 250 V ; 48, 115 and 230 V = 1 780 V

Max. ambient operating temperature : 35 °C without derating

Protected against accidental contact with live parts up to 220 VA

Dimensions

Fig. 1 - 40 to 220 VA

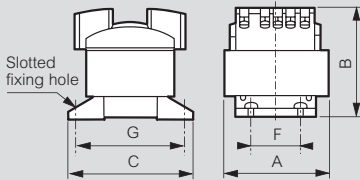

Fig. 2 - 310 VA¹

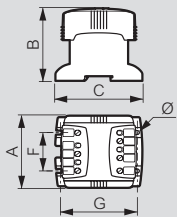
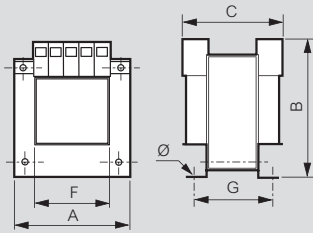

Fig. 3 - 450 to 630 VA



1 : Subject to secondary voltage (see tables)

Primary : 230 - 400 V
Secondary : 12 - 0 - 12 V
0 - 12 - 24 V

Cat. Nos.
0428 40 to 0428 47

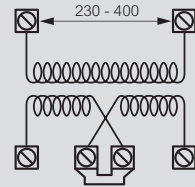

12 0 12 24
P max

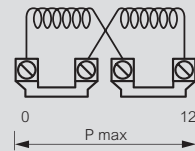

0 P max 12

Primary : 230 - 400 V
Secondary : 24 - 0 - 24 V
0 - 24 - 48 V

Cat. Nos.
0428 70 to 0428 77

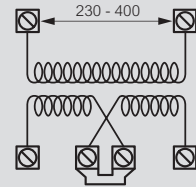

24 0 24 48
P max

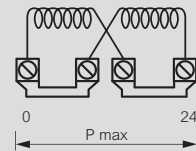

0 P max 24

Primary : 230 - 400 V
Secondary : 115 - 0 - 115 V
0 - 115 - 230 V

Cat. Nos.
0427 85 to 0427 92

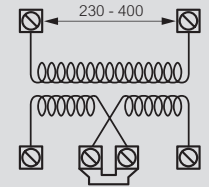

115 0 115 230
P max

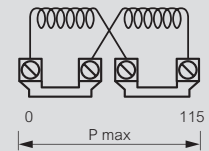

0 P max 115

Electrical characteristics

Cat. Nos.	Power (VA)	Dimensions (mm)			Fixing (mm)			Weight (kg)	No-load loss (W)	Total losses @ 100% load (W)	Voltage drop as % with		Efficiency with		Ucc %	Primary connection cable mm ²			Secondary connection cable mm ²			Fig.
		A	B	C	F	G	Ø				cos φ 1	cos φ 0.45	cos φ 1	cos φ 0.45		flexible	rigid	Ø mm	flexible	rigid	Ø mm	
Primary 230-400 V - 24 V or 2 x 12 V secondary																						
0428 40	40	84	70	98	40	86	4.5	0.9	3.7	13.1	18.3	12.7	0.75	0.6	15.6	1 to 4	1 to 4	4.5	1 to 4	1 to 4	4.5	1
0428 41	63	84	77	98	40	86	4.5	1.3	4.9	16.3	13.5	10.2	0.8	0.6	11.8	1 to 4	1 to 4	4.5	1 to 4	1 to 4	4.5	1
0428 42	100	84	86	98	40	86	4.5	1.6	6.2	21.0	10.5	8.7	0.8	0.7	9.5	1 to 4	1 to 4	4.5	1 to 4	1 to 4	4.5	1
0428 43	160	84	104	98	40	86	4.5	2.4	9.1	31.8	8.8	7.4	0.8	0.7	7.9	1 to 4	1 to 4	4.5	1 to 4	1 to 4	4.5	1
0428 44	220	96	115	110	40	98	4.5	3.4	12.6	40.0	6.9	6.3	0.85	0.7	6.5	1 to 4	1 to 4	4.5	1 to 4	1 to 4	4.5	1
0428 45	310	106	123	115	50	100	5.2	3.8	14.2	54.9	7.3	6.2	0.85	0.7	8.2	1 to 4	1 to 4	4.5	1 to 4	1 to 4	4.5	2
0428 47	630	126	126	141	90	105	6.5	8.0	25.5	62.4	4.3	2.6	0.91	0.82	3.5	1 to 4	1 to 4	4.5	1 to 16	1 to 25	6.5	3
Primary 230-400 V - 24 V secondary																						
0428 55	40	84	70	98	40	86	4.5	0.9	3.7	13.1	18.3	12.7	0.75	0.58	15.6	1 to 4	1 to 4	4.5	1 to 4	1 to 4	4.5	1
0428 56	63	84	77	98	40	86	4.5	1.3	4.9	16.3	13.5	10.2	0.79	0.64	11.8	1 to 4	1 to 4	4.5	1 to 4	1 to 4	4.5	1
0428 57	100	84	86	98	40	86	4.5	1.6	6.2	21.0	10.5	8.7	0.83	0.68	9.5	1 to 4	1 to 4	4.5	1 to 4	1 to 4	4.5	1
0428 58	160	84	104	98	40	86	4.5	2.4	9.1	31.8	8.8	7.4	0.83	0.69	7.9	1 to 4	1 to 4	4.5	1 to 4	1 to 4	4.5	1
0428 59	220	96	115	110	40	98	4.5	3.4	12.6	40.0	6.9	6.3	0.85	0.71	6.5	1 to 4	1 to 4	4.5	1 to 4	1 to 4	4.5	1
0428 60	310	106	123	115	50	100	5.2	3.82	14.2	54.9	7.3	6.2	0.85	0.72	8.2	1 to 4	1 to 4	4.5	1 to 4	1 to 4	4.5	2
0428 61	450	126	126	126	90	94	6.5	6.0	21.8	63.9	6.0	3.2	0.88	0.76	4.9	1 to 4	1 to 4	4.5	1 to 16	1 to 25	6.5	3
0428 62	630	126	126	141	90	105	6.5	8.0	25.5	62.4	4.3	2.6	0.91	0.82	3.5	1 to 4	1 to 4	4.5	1 to 16	1 to 25	6.5	3
Primary 230-400 V - 48 V or 2 x 24 V secondary																						
0428 70	40	84	77	98	40	86	4.5	1.3	3.7	12.9	18.0	12.5	0.8	0.6	15.4	1 to 4	1 to 4	4.5	1 to 4	1 to 4	4.5	1
0428 71	63	84	86	98	40	86	4.5	1.6	4.9	16.5	13.7	10.3	0.8	0.6	11.9	1 to 4	1 to 4	4.5	1 to 4	1 to 4	4.5	1
0428 72	100	84	104	98	40	86	4.5	2.4	6.2	21.0	10.4	8.7	0.8	0.7	9.4	1 to 4	1 to 4	4.5	1 to 4	1 to 4	4.5	1
0428 73	160	84	104	98	40	86	4.5	2.4	9.1	31.6	8.7	7.3	0.8	0.7	7.8	1 to 4	1 to 4	4.5	1 to 4	1 to 4	4.5	1
0428 74	220	96	115	110	40	98	4.5	3.4	12.6	39.5	6.7	6.2	0.85	0.7	6.3	1 to 4	1 to 4	4.5	1 to 4	1 to 4	4.5	1
0428 75	310	106	123	115	50	100	5.2	3.8	14.2	54.9	7.3	6.2	0.85	0.7	8.2	1 to 4	1 to 4	4.5	1 to 4	1 to 4	4.5	2
0428 77	630	126	126	141	90	105	6.5	8.0	25.5	63.3	4.2	2.6	0.9	0.8	3.5	1 to 4	1 to 4	4.5	1 to 16	1 to 25	6.5	3
Primary 230-400 V - 115-230 V secondary																						
0427 85	40	84	70	98	40	86	4.5	1.0	3.7	10.9	18.5	12.7	0.75	0.58	15.7	1 to 4	1 to 4	4.5	1 to 4	1 to 4	4.5	1
0427 86	63	84	77	98	40	86	4.5	1.3	4.9	15.6	12.5	9.7	0.80	0.65	11.0	1 to 4	1 to 4	4.5	1 to 4	1 to 4	4.5	1
0427 87	100	84	86	98	40	86	4.5	1.6	6.2	21.1	10.7	8.9	0.83	0.68	9.7	1 to 4	1 to 4	4.5	1 to 4	1 to 4	4.5	1
0427 88	160	84	104	98	40	88	4.5	2.4	9.1	32.3	8.8	7.3	0.83	0.69	7.9	1 to 4	1 to 4	4.5	1 to 4	1 to 4	4.5	1
0427 89	220	96	115	110	40	98	4.5	3.4	12.6	40.1	6.8	6.2	0.85	0.71	6.4	1 to 4	1 to 4	4.5	1 to 4	1 to 4	4.5	1
0427 90	310	106	123	115	50	100	5.2	3.8	14.2	54.0	7.3	6.2	0.85	0.7	8.2	1 to 4	1 to 4	4.5	1 to 4	1 to 4	4.5	2
0427 92	630	126	126	123	90	105	6.5	7.8	25.5	64.6	4.3	2.6	0.91	0.81	3.5	1 to 4	1 to 4	4.5	1 to 4	1 to 4	4.5	3

how to calculate

the rated power of a transformer

In equipment containing control devices, the transformer power depends on the maximum power required at a given moment (inrush power), the permanent power, the voltage drop and power factor

When determining the permissible instantaneous power (inrush power) required, the following factors should always be taken into account :

- two inrush currents cannot occur at the same time
- power factor $\cos \varphi$ equals 0.5
- at maximum, 80% of devices are supplied at the same time (this percentage can be calculated precisely for each device)

Determination of the inrush power

Where a simplified calculation of the power is required, the following formula can be used :

$$P_{\text{inrush}} = 0.8 (\Sigma P_m + \Sigma P_v + P_a)$$

ΣP_m : sum of all contactor steady state power levels (holding power)

ΣP_v : sum of all power levels of indicators and LEDs¹

P_a : inrush power of the largest contactor

Example :

A machine tool control cabinet comprising :

- 10 contactors for 4 kW motors, with a steady state power of 8 VA
- 2 contactors for 18.5 kW motor, with a steady state power of 20 VA
- 1 contactor for 45 kW motor, with a steady state power of 20 VA, and an inrush power of 250 VA $\cos \varphi$ 0.5
- 20 remote control relays, with a steady state power of 4 VA
- 30 signalling LEDs, with a consumption of 1 VA each

$$-\Sigma P_m = 220 \text{ VA } \{ (10 \times 8 \text{ VA}) + (2 \times 20 \text{ VA}) + (1 \times 20 \text{ VA}) + (20 \times 4 \text{ VA}) \}$$

$$-\Sigma P_v = 30 \text{ VA } (30 \times 1 \text{ VA})$$

$$-P_a = 250 \text{ VA}$$

$$P_{\text{inrush}} = 0.8 (220 + 30 + 250) = 400 \text{ VA at } \cos \varphi \text{ 0.5}$$

Determination of the rated power of a transformer

For control transformers, in particular, simply start with an inrush power at $\cos \varphi$ 0.5 and read the size from the table below

Rated power in VA IEC and CSA	Admissible instantaneous power in VA IEC/EN 61558-2-2 with $\cos \varphi$ of :								
	0.2	0.3	0.4	0.5	0.6	0.7	0.8	0.9	1
40	90	80	72	66	61	57	53	51	53
63	160	140	130	120	110	100	90	90	90
100	240	190	170	160	150	140	130	130	140
160	480	400	350	300	270	240	220	200	190
250	830	690	590	510	450	400	360	330	310
400	1 600	1 400	1 200	1 000	900	800	800	700	700
630	2 000	1 800	1 500	1 400	1 200	1 100	1 100	1 000	1 000
1 000	5 400	4 600	4 000	3 600	3 200	3 000	2 700	2 600	2 500
1 600	9 000	8 000	7 200	6 600	6 100	5 700	5 400	5 300	5 600
2 500	17 300	16 600	16 000	15 700	15 200	14 900	14 700	14 600	15 100
4 000	34 500	28 800	24 400	17 000	16 600	16 400	14 800	13 400	12 400

From the example above, an inrush of 460 VA at $\cos \varphi$ 0.5 gives a transformer size of 250 VA

Checking the selection

As a precaution, make the following checks on each of your devices :

- first calculate the sum of the steady state power for the coils and the LEDs powered at the same time
- then apply a coefficient : use either our hypothetical figure of 80% of devices at steady state power, or the actual calculation for your equipment
- the power of the chosen transformer shall be greater than or equal to the result of the calculation

1 : LED = Light Emitting Diode

General information

Transformers take around 25 times the load at switch on

$VA \div V =$ current in the winding
either PRIMARY or SECONDARY

$$\text{i.e. } \frac{300 \text{ VA}}{12 \text{ V}} = 25 \text{ A} \times 25 = 625 \text{ A}$$

The power triangle :

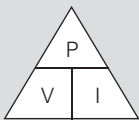

Secondary power/voltage information

Example : compact transformer 100 VA - 12/24 V Cat. No. 0428 42

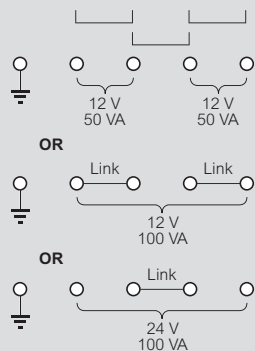

Identification of markings

Changing voltage



Isolation transformer (functional insulation between primary and secondary)



Auto transformer (no insulation between primary and secondary)

Control circuit power supply



Control transformer (functional insulation between primary and secondary)

Electric shock protection

- Protection against direct and indirect contact by :



Safety transformers (reinforced insulation between primary and secondary, no-load voltage < 50 V)

- Protection against indirect contact by :



Circuit separation transformers (reinforced insulation between primary and secondary)

The transformer function(s) can either be defined by the equipment designer or can be imposed by installation guidelines or the equipment standard

Definitions of electrical shock :

- Electric shocks : physiopathological effect resulting from an electrical current passing through the human body
- Direct contact : persons coming into contact with live parts (connected to the mains)
- Indirect contact : persons coming into contact with grounding which is accidentally live following an insulation fault

protection of transformers, primary and secondary circuits

Protection of transformers

In accordance with the IEC EN 61558 standard, transformers must be protected against overload and short-circuit conditions which may occur during normal operation.

The standard does not specify the type or location of the protective device : it is the manufacturer's responsibility to choose the most suitable position, either on the primary or secondary side. The rating, type and location of the protective device are to be indicated on the device identification plate.

Protection of the primary and secondary circuits

General

Circuits must be protected against overload and short-circuit conditions. Protection against overload is compulsory if the circuit is likely to be affected by an overload current. This protection can be installed at the supply source or end of the circuit.

Protection against a short-circuit is compulsory in all installations ; this protection has to be installed at the supply source of the circuit.

Supply circuits (transformer primary)

The transformer is a device which cannot itself generate overload. Its supply circuit therefore only requires protection against a short-circuit. When a transformer is energised, a very high inrush current (around 25 In)¹ is produced for approximately 10 ms.

When protecting the circuit, both factors must be considered.

Legrand offers three possibilities :

- type aM cartridge fuses,
- type D MCBs (with magnetic tripping set at 12 In average)
- type C MCBs (with magnetic tripping set at 7 In average)

Example : control transformer 630 VA - 230/24 V Cat. No. 0442 37

In primary 2·74 A (VA ÷ V)
I inrush at power-up 68·5 A (25 x 2·74 A)

Protection against a short-circuit can be provided by :

- type aM 6 A cartridge fuse
- type D 6 A MCBs
- type C 13 A MCBs - (16 A nearest UK)

Primary protection

Minimum protection rating for primary supply of the transformer :

Power (VA)	230 V single-phase			400 V single-phase			400 V three-phase		
	aM fuse	C MCB	D MCB	aM fuse	C MCB	D MCB	aM fuse	C MCB	D MCB
40	0·5	1		0·25	1				
50	1	1	1	0·5	1				
63	1	2	1	0·5	1				
100	1	3	1	1	2	1			
150	2	6	2	1	3	1			
160	2	6	2	1	3	1	1		
200	2	6	3	1	3	2			
250	2	6	3	1	6	2	1		
300	4	10	6	2	6	2			
400	4	10	6	2	6	2	2		
500	6	16	6	4	10	3			
630	6	16	6	4	10	3	2	6	2
750	8	16	10	6	10	6	2	6	3
1 000	10	20	10	6	16	6	4	10	3
1 250	10	25	16	6	20	10	4	10	6
1 500	10	32	16	10	20	10	4	16	6
1 600	10	32	16	10	20	10	6	16	6
2 000	12	40	16	10	25	10			
2 500	16	50	20	10	32	16	6	20	10
3 000	16	50	32	12	40	20			
3 500	20	50	32	16	40	20			
4 000	20	80	32	16	50	20	10	32	16
5 000	25	100	40	16	63	25	12	32	16

These values are given for information only for transformers with inrush currents of around 25 In.

1 : In = nominal rating of circuit

Protection of the secondary circuit

The secondary circuit must be protected against overload and short-circuit conditions. For overload, check that the protection rating chosen is lower than or equal to the transformer secondary current. For short-circuit, ensure that a short-circuit occurring at the furthest point of the circuit will trigger the protective device within 5 seconds.

Legrand offers two possibilities :

- type gG cartridge fuses
- type C MCBs (with magnetic tripping set at 7 In average)

If the transformer only supplies a single circuit, and provided the calculations show perfect compatibility, transformer protection (if on secondary) and circuit protection can be one and the same. A single protective device performs both functions (see table of transformer protective devices).

If the transformer supplies several circuits, overload and short-circuit calculations must be performed for each individual circuit. To check that the device chosen is suitable, an approximate minimum short-circuit value can be obtained using the following formula.

Formula for determining the secondary protection rating

Calculate the minimum short-circuit at the furthest point on the circuit :

$$I_{c/c \text{ min.}} = \frac{U_s}{\left(\frac{U_s^2}{P} \times \frac{U_{c/c \%}}{100}\right) + \frac{2\rho l}{S}}$$

Us = transformer secondary voltage

P = transformer power

U c/c % = transformer short-circuit voltage

l = line length in m

S = line cross section in mm²

ρ copper = 0·027 Ω mm²/m

Choose the protection rating so as to obtain a cut-off time of 5 seconds max. for a current I c/c defined above :

$$\text{type gG fuse : } I_n \leq \frac{I_{c/c \text{ min.}}}{4}$$

$$\text{type C MCB : } I_n \leq \frac{I_{c/c \text{ min.}}}{8}$$

Example : control transformer 630 VA - 230/24 V Cat. No. 0442 37

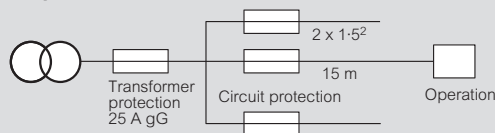

$$I_{c/c \text{ min.}} = \frac{24}{\left(\frac{24^2}{630} \times \frac{3\cdot3}{100}\right) + \frac{2 \times 0\cdot027 \times 15}{1\cdot5}} = 44\cdot42 \text{ A} = \text{Use either :}$$

$$\frac{44\cdot42}{4} = 11\cdot10 \rightarrow \text{gG fuse 10 A max.} \quad \frac{44\cdot42}{8} = 5\cdot55 \rightarrow \text{C type MCB 5 A max.}$$

Secondary protection

Ratings and types of protective devices to be used for single phase transformer protection according to VA rating and secondary voltage

Rated power (VA) IEC/CSA	24 V			48 V			110 V			230 V		
	Fuse A	Type	Curve C MCB	Fuse A	Type	Curve C MCB	Fuse A	Type	Curve C MCB	Fuse A	Type	Curve C MCB
40	2	T		1	T		400 m	T		200 m	T	
50	2	T	2	1	T	1	500 m	T	0·5	200 m	T	0·2
63	3·15	T		1·6	T		630 m	T		315 m	T	
100	4	gG	4	2	gG	2	1	gG	1	0·5	gG	0·5
150	6	gG	6	4	gG	4	2	gG	2	1	gG	1
160	8	gG	8	4	gG	4	2	gG	2	1	gG	1
200	8	gG	8	4	gG	4	2	gG	2	1	gG	1
250	10	gG	10	6	gG	6	2	gG	2	1	gG	1
300	12	gG	12	6	gG	6	4	gG	4	2	gG	2
400	16	gG	16	8	gG	8	4	gG	4	2	gG	2
500	20	gG	20	10	gG	10	6	gG	6	2	gG	2
630	25	gG	25	12	gG	12	6	gG	6	3	gG	3
750		gG		16	gG	16	8	gG	8	4	gG	4
1 000	40	gG	40	20	gG	20	8	gG	8	4	gG	4
1 250		gG			gG		12	gG	12		gG	
1 500		gG			gG		16	gG	13	8	gG	8
1 600	63	gG	63	32	gG	32	16	gG	13	8	gG	8
2 000		gG			gG		20	gG	20	8	gG	8
2 500	100	gG	100	50	gG	50	20	gG	20	10	gG	10
3 000		gG			gG		32	gG	32		gG	
3 500		gG			gG		32	gG	32		gG	
4 000		gG			gG		32	gG	32	16	gG	16
5 000		gG			gG		50	gG	50		gG	

filtered power supplies

open type single phase



Dimensions and technical information **opposite and p. 97**

Filtered power supplies for PLCs and other equipment requiring a voltage of 12 V DC or 24 V DC

Include :

- twin output terminals for ease of connection
- safety transformer with interference filtration
- fuse protection on output
- green LED output voltage indicator
- capacitor in filtered range

Supplied with a connection link for quick connection between - and \perp up to 15 A

Fixing options :

- clip directly to DIN rail up to 24 W
- clip on or screw fixing up to 120 W
- screw fixing only above 120 W

Pack	Cat. Nos.	Single phase filtered		Terminal capacity (mm ²) Flexible cable	
		12 V_{DC} output			
		230-400 V \pm 15 V _{AC} (input) / 12 V _{DC} (output)			
		Power (W)	Current rating (A)	Input	Output
1	0470 01	12	1	6	6
1	0470 02	30	2.5	6	6
1	0470 03	60	5	6	6
1	0470 04	120	10	6	6
		24 V_{DC} output			
		230-400 V \pm 15 V _{AC} (input) / 24 V _{DC} (output)			
		Power (W)	Current rating (A)	Input	Output
1	0470 20	12	0.5	6	6
1	0470 21	24	1	6	6
1	0470 22	60	2.5	6	6
1	0470 23	120	5	6	6
1	0470 24	240	10	6	6
1	0470 25	360	15	6	6

■ Dimensions

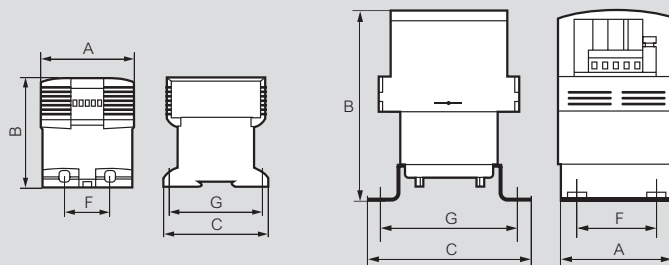

Cat. Nos. 0470 01/02/03 and 0470 20/21/22/23

Cat. Nos. 0470 04/24/25

Cat. Nos.	A (mm) Width	B (mm) Depth	C (mm) Height	F x G (mm) Fixing ctrs	Ø (mm)	Weight (Kg)
0470 01	68	98	88	DIN	-	1.00
0470 02	93	121	105	DIN	4-6	2.45
0470 03	105	135	115	DIN	4-6	3.60
0470 04	126	186	175	75 x 150	5-5	6.35
0470 20	68	98	88	DIN	-	1.00
0470 21	68	98	88	DIN	-	1.00
0470 22	93	121	105	DIN	4-6	2.45
0470 23	105	135	115	DIN	4-6	3.60
0470 24	126	186	175	75 x 150	5-5	6.40
0470 25	126	206	175	75 x 150	5-5	7.60

■ Technical information

Conform to IEC / EN 61558-2-6, UL 60950
CAN/CSA C22.2 N° 60 950.00



Products are compatible with EN 61131-2, EN 60204 and EN 61439 apparatus

Input voltage : 230/400 V_{AC} \pm 15 V single phase 50/60 Hz - Class I

Output voltage : 12 V_{DC} or 24 V_{DC}

Insulation voltage : Input/Output 4 510 V

Input/Earth 2 260 V

Output/Earth 500 V

Max. ambient temperature without derating : 60 °C

Ripple factor : <3 %

Cooling by natural convection

Integral fuse protection on output

Can be fixed to symmetrical rail 7.5 mm or 15 mm depth EN 60715

Screw fix only Cat. Nos. 0470 04/24 and 25

Screw fix or clip on to DIN rail Cat. Nos. 0470 02/03/22 and 23

Supplied with a connection link for quick connection between terminals and earth

Note : To conform to UL, product must be mounted in the vertical position (mounting against support) for Class A ambient temperature rating 25 °C

■ Operating diagram

Operating current up to 15 A

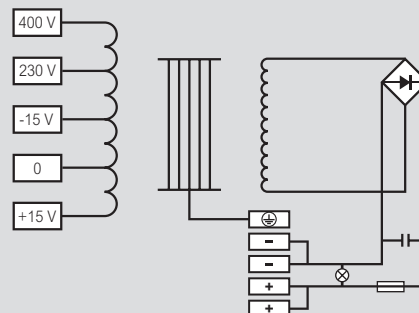

DX³ MCBs p. 56-57
Fuses p. 76-77



filtered power supplies

open type single phase (continued)

■ Circuit protection (double pole MCB)

Single phase		Input 230/400 V ±15 V			
U I	Protection	12 V		24 V	
		Internal	External	Internal	External
0.5 A	Power supply			0470 20	
	MCB/Fuse			T 0.5 A L ¹	4091 95 (1 A)
1 A	Power supply	0470 01		0470 21	
	MCB/Fuse	T 1 A L ¹	4091 95 (1 A)	T 1 A L ¹	4091 95 (1 A)
2.5 A	Power supply	0470 02		0470 22	
	MCB/Fuse	T 2.5 A L ¹	4091 97 (3 A)	T 2.5 A L ¹	4091 97 (3 A)
5 A	Power supply	0470 03		0470 23	
	MCB/Fuse	T 5 A L ¹	4091 99 (6 A)	T 5 A L ¹	4091 99 (16 A)
10 A	Power supply	0470 04		0470 24	
	MCB/Fuse	T 10 A L ¹	4092 00 (10 A)	T 10 A L ¹	4092 00 (10 A)
15 A	Power supply			0470 25	
	MCB/Fuse				4092 02 (16 A)

1 : T type fuse is a time delay fuse (5 x 20 mm)

■ Primary fuse protection required for UL conformity

Supply 230 V : Use 250 V time delay HRC fuse
UL Category Code JDYX2

Supply 400 V : Use 500 V time delay HRC fuse
UL Category Code JDYX

Secondary voltage	12 V		24 V	
Primary voltage	230 V ~	400 V ~	230 V ~	400 V ~
Power supply			0470 20	
Fuse rating			0.315 A T	2/10 A
Power supply	0470 01		0470 21	
Fuse rating	0.315 A	2/10 A	0.4 A	2/10 A
Power supply	0470 02		0470 22	
Fuse rating	0.8 A	4/10 A	1 A	6/10 A
Power supply	0470 03		0470 23	
Fuse rating	1.6 A	8/10 A	2 A	1 A
Power supply	0470 04		0470 24	
Fuse rating	3.15 A	1 ¹ / ₂ A	4 A	2 ¹ / ₄ A
Power supply			0470 25	
Fuse rating			6.3 A	3 A

■ Electrical characteristics

Cat. Nos.	Voltage (V)	Current rating (A)	Weight (Kg)	Input under load 230 V (A)	Input under load 400 V (A)	Operating voltage				No-load loss (W)	Total loss at nominal load 100 % (W)	Voltage drop (%)
						No-load (V)	Underload (V)	With 100 mA load and input voltage +10%	With nominal load input voltage -15%			
Output 12 V												
0470 01	12	1	1	0.12	0.06	14.4	11.7	15.5	10.3	4.4	7.3	23.5
0470 02	12	2.5	2.45	0.33	0.19	13.9	11.6	15.2	10.2	8.3	11.9	19.4
0470 03	12	5	3.6	0.60	0.34	14.1	12.1	15.5	10.5	11.4	17.1	17.2
0470 04	12	10	6.35	1.24	0.72	14.7	11.8	16.1	10.4	20.2	33.7	24.7
Output 24 V												
0470 20	24	0.5	1	0.12	0.06	27.6	22.9	29.4	20.1	4.4	7.3	20.66
0470 21	24	1	1	0.18	0.10	29.0	22.8	31.2	20.2	4.4	10.3	27.03
0470 22	24	2.5	2.45	0.47	0.27	27.8	23.3	30.4	20.4	8.3	16.3	19.46
0470 23	24	5	3.6	0.88	0.51	27.5	23.2	30.2	20.3	11.4	25.4	18.68
0470 24	24	10	6.35	1.88	1.09	27.7	23.5	30.5	20.5	20	45.3	18.20
0470 25	24	15	7.6	2.53	1.46	27.5	23.2	30.2	20.2	23	54.7	18.70

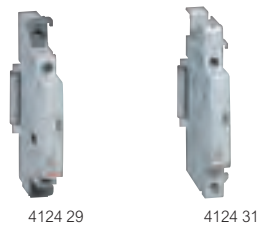
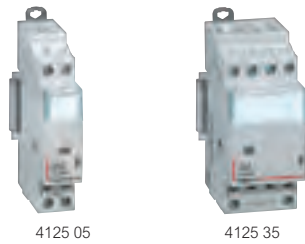

Technical information p. 100
Dimensions p. 103

Conform to IEC/EN 61095
Space for power supply busbar on top (up to 25 A)

Pack	Cat. Nos.	Power contactors with 24 V~ coil		
1	4125 03	Double pole - 250 V~ I max 16 A		Type of contact N/C + N/O Number of modules 1
1	4125 05	25 A		2 N/O 1

Pack	Cat. Nos.	Power contactors with 230 V~ coil		
4	4125 21	Double pole - 250 V~ I max 16 A		Type of contact N/C + N/O Number of modules 1
1	4125 24	25 A		2 N/C 1
5	4125 35	Four pole - 400 V~ 25 A		4 N/O 2
1	4125 36	25 A		4 N/C 2
1	4125 33	25 A		2 N/C + 2 N/O 2

Pack	Cat. Nos.	Signalling auxiliaries for CX ³ contactors			
		Auxiliary changeover switch Used to signal the position status of the contacts on the product to which it is connected For 1 module contactors 16 A to 25 A Maximum 2 auxiliary devices per contactor Fitted on left-hand side of contactor			
1	4124 29	I max 5 A	Voltage 250 V~	Contact N/C + N/O	Number of modules 0.5
		For 2 module contactors 25 A Maximum 2 auxiliary devices per contactor Fitted on left-hand side of contactor			
1	4124 30	5 A	250 V~	N/C + N/O	0.5
		For 63 A contactors Maximum 1 auxiliary device per contactor Fitted on left-hand side of contactor			
1	4124 31	5 A	250 V~	N/C + N/O	0.5
10	4063 07	Accessory Spacing unit 0.5 module To be placed between every 2 contactors to aid cooling			



NEW

power contactors CX³ with handle

16 A to 63 A

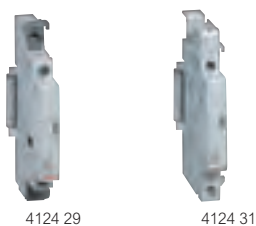
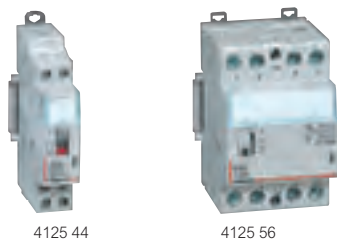

Technical information p. 100
Dimensions p. 103

Conform to IEC/EN 61095
Space for power supply busbar on top (up to 25 A)

Pack	Cat. Nos.	Power contactors with 230 V~ coil and handle			
		Manual override for test and repair function, carried out via the handle Permanent "ON" or "OFF" without automatic reset			
		Double pole - 250 V~			
4	4125 44	I max	Connection	Type of contact	Number of modules
1	4125 45 ¹	25 A		2 N/O	1
1	4125 47 ¹	40 A		2 N/O	2
1	4125 47 ¹	63 A		2 N/O	2
		Triple pole 400 V~			
1	4125 49 ¹	40 A		3 N/O	3
1	4125 50 ¹	63 A		3 N/O	3
		Four pole 400 V~			
1	4125 53 ¹	40 A		4 N/O	3
1	4125 56 ¹	63 A		4 N/O	3

Pack	Cat. Nos.	Signalling auxiliaries for CX³ contactors			
		Auxiliary changeover switch Used to signal the position status of the contacts on the product to which it is connected			
		For 1 module contactors 16 A to 25 A Maximum 2 auxiliary devices per contactor Fitted on left-hand side of contactor			
1	4124 29	I max	Voltage	Contact	Number of modules
		5 A	250 V~	N/C + N/O	0.5
		For 2 module contactors 25 A Maximum 2 auxiliary devices per contactor Fitted on left-hand side of contactor			
1	4124 30	5 A	250 V~	N/C + N/O	0.5
		For 40 and 63 A contactors Maximum 1 auxiliary device per contactor Fitted on left-hand side of contactor			
1	4124 31	5 A	250 V~	N/C + N/O	0.5
		Accessory			
10	4063 07	Spacing unit 0.5 module To be placed between every 2 contactors to aid cooling			



1 : Handle can be accessed after removing blanking plate

Technical information

- Rated impulse withstand voltage (Uimp) : 4 kV
- Mechanical endurance (no. of operating cycles) : 10⁶ cycles
- Operating temperatures : - 25 °C to + 40 °C
- Storage temperatures : - 40 °C to + 70 °C

Contactor protection against short circuits according to standard EN 61095, conditional short circuit current:

- I_q = 6 kA for 16 to 25 A contactors

- I_q = 3 kA for 40 to 63 A contactors

Circuit breaker or gG fuse rated:

- ≤ 16 A for 16 A rating • ≤ 40 A for 40 A rating
- ≤ 25 A for 25 A rating • ≤ 63 A for 63 A rating

Consumption of a contactor control coil

16 A and 25 A power contactors					
Coil voltage	24 V~		230 V~ low noise	230 V~	
Current	16 A and 25 A	25 A	25 A	16 A and 25 A	16 A and 25 A
Type of contact	NC + NO 2 NO	4 NO	2 NO	NC + NO 2 NO 2 NC	2 NC + 2 NO 4 NO 4 NC
Dimensions	1 mod.	2 mod.	1 mod.	1 mod.	2 mod.
Holding current	200 mA	300 mA	12 mA	20 mA	20 mA
Inrush current	970 mA	2500 mA	60 mA	90 mA	200 mA

40 A and 63 A power contactors				
Coil voltage	24 V~		230 V~	
Current	40 A and 63 A	40 A and 63 A	40 A and 63 A	40 A and 63 A
Type of contact	2 NO	4 NO	2 NO 2 NC	3 NO 4 NO 4 NC
Dimensions	2 mod.	3 mod.	2 mod.	3 mod.
Holding current	250 mA	270 mA	15 mA	30 mA
Inrush current	1750 mA	1500 mA	150 mA	200 mA

Recommendations

Insert a spacing module (Cat. No. 4063 07 p. 98-99):

- every two contactors when the ambient temperature is below 40 °C

- every contactor when the ambient temperature is between 40 and 60 °C

Contactor rating	40 °C	50 °C	60 °C
I _e = 16 A	16 A	14 A	12 A
I _e = 25 A	25 A	22 A	20 A
I _e = 40 A	40 A	36 A	32 A
I _e = 63 A	63 A	57 A	50 A

Max. connection cross section in mm²

Conductor type	Ratings ≤ 25 A	Ratings 40 & 63 A
Rigid	6 ² or 2 x 2.5 ²	25 ² or 2 x 10 ²
Flexible	6 ² or 2 x 2.5 ²	25 ² or 2 x 10 ²
Flexible with single end cap	6 ²	16 ²
Flexible with double end cap	2 x 4 ²	2 x 16 ²

Contactor selection charts

Incandescent lamps

Tungsten and halogen filaments 230 V~								
Nominal wattage	40 W	60 W	75 W	100 W	150 W	200 W	500 W	1000 W
16 A	45	30	24	19	13	10	4	2
25 A	60	48	38	30	20	15	6	3
40 A	96	77	61	48	32	24	10	5
63 A	154	123	97	77	51	38	15	8

ELV halogen bulbs with ferromagnetic ballast						ELV halogen bulbs with electronic ballast						
Nominal wattage	20 W	35 W	50 W	75 W	100 W	150 W	20 W	35 W	50 W	75 W	100 W	150 W
16 A	32	20	15	12	9	6	60	40	28	18	14	9
25 A	52	30	24	16	12	8	80	50	40	26	20	13
40 A	68	39	31	21	16	10	112	70	56	36	28	18
63 A	88	51	41	27	20	14	157	98	78	51	39	25

Contactor selection charts (continued)

Fluorescent tubes with ferromagnetic ballast

Nominal wattage	Single parallel compensated fluorescent					Double series compensated fluorescent				
	18 W	20 W	36 W	58 W	115 W	2 x 20 W	2 x 36 W	2 x 40 W	2 x 58 W	2 x 140 W
16 A	24	24	16	11	5	30	24	22	15	6
25 A	33	30	25	17	9	45	38	35	24	10
40 A	43	39	33	22	12	68	57	53	36	15
63 A	56	51	42	29	15	101	86	79	54	23

Nominal wattage	Quadruple series compensated fluorescent				Compact fluorescent with built-in starter			
	4 x 18 W				7 W	10 W	18 W	26 W
16 A	16				50	40	28	19
25 A	24				60	50	42	28
40 A	36				78	65	55	36
63 A	54				101	85	71	47

Fluorescent tubes with electronic ballast

Nominal wattage	Single fluorescent				Double fluorescent		
	18 W	30 W	36 W	58 W	2 x 18 W	2 x 36 W	2 x 58 W
16 A	72	42	36	22	36	20	12
25 A	110	68	58	36	56	30	19
40 A	165	102	87	54	84	45	29
63 A	248	153	131	81	126	68	43

Nominal wattage	Triple fluorescent (series compensated)		Quadruple fluorescent (series compensated)	
	3 x 14 W	3 x 18 W	4 x 14 W	4 x 18 W
16 A	34	26	26	20
25 A	46	38	37	28
40 A	62	51	52	39
63 A	84	69	73	55

Compact fluorescent with built-in electronic power supply					
Nominal wattage	7 W	11 W	15 W	20 W	23 W
16 A	120	80	64	50	43
25 A	200	125	90	70	60
40 A	280	175	126	98	84
63 A	392	245	176	137	118

Discharge lamps with compensation

Nominal wattage	Metal halogenide						Low pressure sodium vapour					
	35 W	70 W	100 W	150 W	250 W	400 W	18 W	35 W	55 W	90 W	135 W	180 W
16 A	10	6	5	3	2	1	12	6	5	3	2	2
25 A	15	9	7	5	3	2	20	10	7	5	3	3
40 A	23	14	11	8	5	3	30	15	11	8	5	5
63 A	34	20	16	11	7	5	45	23	16	11	7	7

Nominal wattage	High pressure sodium vapour					High pressure mercury vapour				
	70 W	150 W	250 W	400 W	1000 W	50 W	80 W	125 W	250 W	400 W
16 A	8	7	5	3	1	11	8	6	3	2
25 A	10	9	6	4	2	15	10	8	4	3
40 A	15	14	9	6	3	21	14	11	6	4
63 A	23	20	14	9	5	29	20	16	8	6

Nominal wattage	High pressure mixed			
	100 W	160 W	250 W	400 W
16 A	9	6	4	2
25 A	11	7	5	3
40 A	14	9	7	4
63 A	19	12	8	5

push buttons/control switches

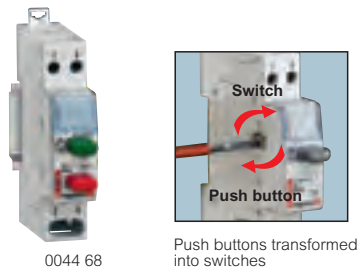

0044 68
Push buttons transformed into switches

Dimensions p. 103

Conform to IEC 60669-1
Breaking capacity AC 12 A according to IEC 60947-5-1
Supplied in push button position
Can be converted to control switches
Accepts insertion of supply busbars

Pack	Cat. Nos.	Push buttons/control switches 20 A - 250 V~		Number of 17.5 mm modules
		Single function		
10	0044 53	1 N/O		1
10	0044 54	1 N/C		1
10	0044 55	2 N/O		1
10	0044 58	1 N/O + 1 N/C		1
		Dual function + indicator		
10	0044 63	1 N/O + green indicator Supplied with 230 V~ E10 lamp		1
10	0044 64	1 N/C + red indicator Supplied with 230 V~ E10 lamp		1
10	0044 68	1 N/O (green) + 1 N/C (red)		1

indicators



Dimensions p. 103

Pack	Cat. Nos.	Indicators - 250 V~	Number of 17.5 mm modules
		Supplied with replaceable diffuser and lamp E10 - 230 V~ Allow supply busbar to be inserted	
		Single	
10	0044 83	Green	1
10	0044 84	Red	1
10	0044 85	Orange	1
10	0044 86	Blue	1
10	0044 87	Colourless	1
10	0044 88	Double Green + red	1
		Three phase voltage indicator Supplied with 230/400 V~ non-replacement lamps	
2	0031 43	3 colourless neon lamps	0.5
		Accessories	
		Replacement lamps E10 - 1.2 W	
10	0044 32	8/12 V incandescent	
10	0044 33	24 V incandescent	
10	0044 36	230 V neon	
10	0044 37	230 V fluo for blue and green diffusers	



4130 91



4130 98

Technical information and dimensions **opposite and p. 103**

In the event of an overload, switch off the power supply and allow the transformer to cool down before switching on again
Wall or rail mounted

Pack	Cat. Nos.	Bell transformers								
		Conform to IEC/EN 61558-2-8 Supplied with label holder Protected against overloads and short circuits Power to 8 V-12 V or 24 V access control devices such as bells and chimes Possibility for supply busbars to run through (Cat. Nos. 4130 90/91)								
		230 V / 8 V								
		<table border="1"> <thead> <tr> <th>Secondary (V)</th> <th>Rating (A)</th> <th>Power (VA)</th> <th>Number of 17.5 mm modules</th> </tr> </thead> <tbody> <tr> <td>8 V~</td> <td>0.5 A</td> <td>4 VA</td> <td>2</td> </tr> </tbody> </table>	Secondary (V)	Rating (A)	Power (VA)	Number of 17.5 mm modules	8 V~	0.5 A	4 VA	2
Secondary (V)	Rating (A)	Power (VA)	Number of 17.5 mm modules							
8 V~	0.5 A	4 VA	2							
1	4130 90									
		230 V / 12 V - 8 V								
		<table border="1"> <thead> <tr> <th>Secondary (V)</th> <th>Rating (A)</th> <th>Power (VA)</th> <th>Number of 17.5 mm modules</th> </tr> </thead> <tbody> <tr> <td>12/8 V~</td> <td>0.66/1 A</td> <td>8 VA</td> <td>2</td> </tr> </tbody> </table>	Secondary (V)	Rating (A)	Power (VA)	Number of 17.5 mm modules	12/8 V~	0.66/1 A	8 VA	2
Secondary (V)	Rating (A)	Power (VA)	Number of 17.5 mm modules							
12/8 V~	0.66/1 A	8 VA	2							
1	4130 91									
		230 V / 24 V - 12 V								
		<table border="1"> <thead> <tr> <th>Secondary (V)</th> <th>Rating (A)</th> <th>Power (VA)</th> <th>Number of 17.5 mm modules</th> </tr> </thead> <tbody> <tr> <td>24/12 V~</td> <td>1/1.5 A</td> <td>24/18 VA</td> <td>4</td> </tr> </tbody> </table>	Secondary (V)	Rating (A)	Power (VA)	Number of 17.5 mm modules	24/12 V~	1/1.5 A	24/18 VA	4
Secondary (V)	Rating (A)	Power (VA)	Number of 17.5 mm modules							
24/12 V~	1/1.5 A	24/18 VA	4							
1	4130 93									

Pack	Cat. Nos.	Safety transformers																																			
		Conform to IEC/EN 61558-2-6 Supplied with label holder Protected against overloads and short circuits Power to 12 V or 24 V devices such as modular power contactors, latching relays and signalling units																																			
		230 V / 12 or 24 V																																			
		<table border="1"> <thead> <tr> <th>P (VA)</th> <th>No-load loss (W)</th> <th>Voltage % drop Cos φ = 1</th> <th>Efficiency % Cos φ = 1</th> <th>Ucc (%)</th> <th>I (A) primary loaded</th> <th>Number of 17.5 mm modules</th> </tr> </thead> <tbody> <tr> <td>16</td> <td>2.5</td> <td>34.6</td> <td>60</td> <td>27.5</td> <td>0.10</td> <td>4</td> </tr> <tr> <td>25</td> <td>2.5</td> <td>29</td> <td>66</td> <td>23.3</td> <td>0.14</td> <td>4</td> </tr> <tr> <td>40</td> <td>4</td> <td>17.9</td> <td>68</td> <td>14.4</td> <td>0.22</td> <td>5</td> </tr> <tr> <td>63</td> <td>4</td> <td>15.7</td> <td>75</td> <td>13.6</td> <td>0.33</td> <td>5</td> </tr> </tbody> </table>	P (VA)	No-load loss (W)	Voltage % drop Cos φ = 1	Efficiency % Cos φ = 1	Ucc (%)	I (A) primary loaded	Number of 17.5 mm modules	16	2.5	34.6	60	27.5	0.10	4	25	2.5	29	66	23.3	0.14	4	40	4	17.9	68	14.4	0.22	5	63	4	15.7	75	13.6	0.33	5
P (VA)	No-load loss (W)	Voltage % drop Cos φ = 1	Efficiency % Cos φ = 1	Ucc (%)	I (A) primary loaded	Number of 17.5 mm modules																															
16	2.5	34.6	60	27.5	0.10	4																															
25	2.5	29	66	23.3	0.14	4																															
40	4	17.9	68	14.4	0.22	5																															
63	4	15.7	75	13.6	0.33	5																															
1	4130 95																																				
1	4130 96																																				
1	4130 97																																				
1	4130 98																																				

Operating principle

Bell transformers

Safety isolating transformer with secondary voltage not permanently exceeding 24 V and for a non permanent usage

Power to 8 V-12 V or 24 V access control devices such as:

- bell
- chime
- door release
- optical electrical barrier

Also:

- flood detector
- temperature rise detector

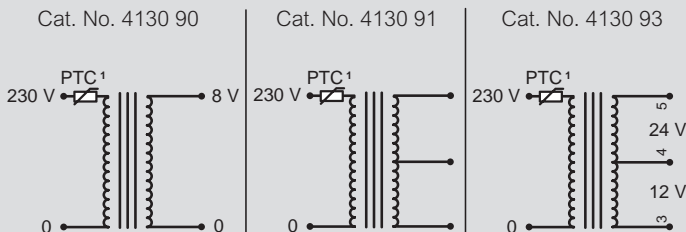

Safety transformers

Designed to protect people from electric shocks by using extra low voltage (ELV $U_{sec} \leq 50 V$)

Power to 12 or 24 V devices such as:

- relay
- modular power contactor
- signalling unit
- latching relay

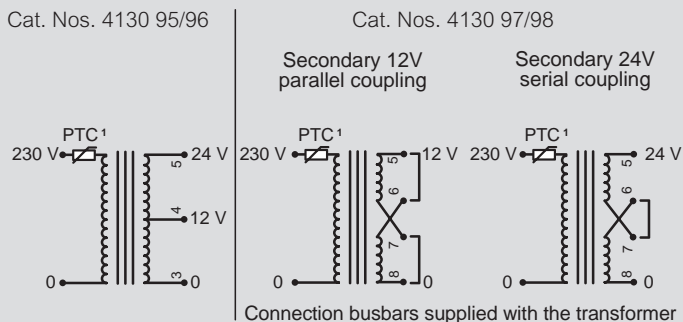

Connection busbars supplied with the transformer

1 : PTC refer to general characteristics

Fixings

Wall or DIN rail 7.5 or 15 mm² depth for 4 module units
 Rail DIN 7.5 or 15 mm² depth for 2 and 5 module units

2 : Remove with tool

Connection

	Primary flexible or rigid	Secondary flexible or rigid
	1 to 4 mm ²	1 to 4 mm ²
	1 to 4 mm ²	1 to 4 mm ²

modular DIN rail equipment

dimensions

■ Dimensions

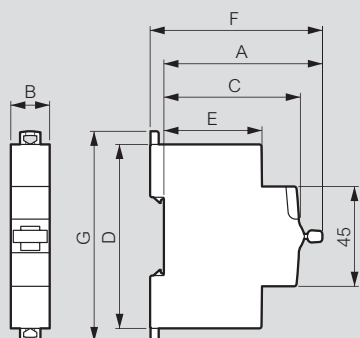

Description	Dimension (mm)										
	A	B					C	D	E	F	G
		1P	1P+N	2P	3P	4P					
Isolating switches DX ³	71-7	17-8	–	17-8/ 35-4	35-6 53-1	35-6/ 70-8	61	83	44	77-8	94-8
Changeover switches	68	17-7	–	35-6	–	–	60	83	44	74	94
Push buttons/ control switches	68	17-7					60	83	44	74	94
CX ³ contactors up to 25 A	66-3/ 61	17-8	–	17-8	35-6	35-6	61	84-5	44	72-6/ 67.3	94-8
CX ³ contactors 40 A & 63 A	62	–	–	35-6	53-4	53-4	60	83	44	68	94
Auxiliaries for CX ³ contactors	61	9 / 17-8					61	84-5	44	67	84-5
DX ³ auxiliaries	71-5	8-8 / 17-7					61	83	44	77-7	84-5

■ Dimensions

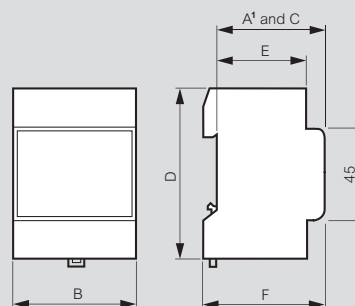

Description		Dimension (mm)					
		A'	B	C	D	E	F
Transformers	Cat. Nos. 4130 90/91	60	36	60	84	44	66
	Cat. No. 4130 93	60	72	60	84	44	66
	Cat. Nos. 4130 95/96	60	72	60	84	44	66
	Cat. Nos. 4130 97/98	60	89	60	95	44	66

1 : Maximum projection



TIME SWITCHES... MOVE WITH THE TIMES

Legrand's one and two channel time switches are available in digital and analogue versions, ranging from AlphaRex³ programmable switches with 0.1 second clock precision, to a more simplistic analogue technology with basic switching functions.

ALPHAREX³... THE NEXT GENERATION OF INNOVATION

AlphaRex³ is the latest addition to the digital time switches range. Available in astronomical light control and standard versions, each with PC programmable functionality.

- 0.1 second clock precision – unbeatable accuracy
- Zero crossing switching – reduces stress on the relay / increases longevity of time switch and lamp
- Expanded offset programming – ideal for outdoor signage and street lighting applications
- Expanded cycle functions – for non-lighting applications such as water features and water irrigation
- Preset time and date – no adjustment needed
- High torque terminal blocks – for enhanced safety
- Pin code for weekly devices – prevents unauthorised programming
- Programme back-up via data key – one key fits all devices

PROGRAMMING MADE EASY

AlphaRex³ can be programmed for standard applications using the push buttons on the device. More expert programming can be achieved either on site or remotely using a PC, data key and Legrand's patented programming software.





ALPHAREX³ AT A GLANCE



Weekly time switch
1 + 2 channel
DIN rail mountable



Weekly time switch
with astronomical
functions
1 + 2 channel
DIN rail mountable



Yearly time switch
1 + 2 channel
DIN rail mountable

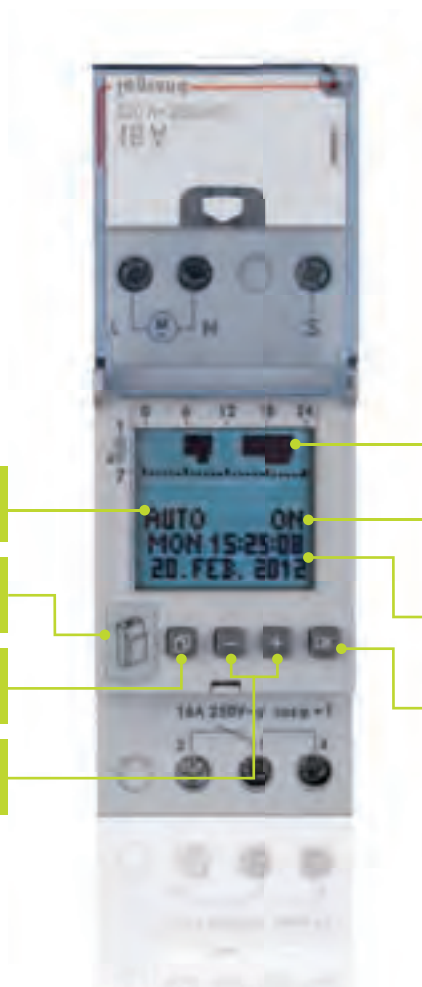

Operating mode

Data key

'MENU' - Launches
the programming mode

'+ / -' - Selects
program menus

Switching time overview

Switching state

Current time
and date

'OK' - Confirms the
selected program point

ALSO AVAILABLE

DIGITAL



MicroRex D
digital time switches
DIN rail mountable
see p. 109



MaxiRex
digital time switches
Surface mounting
see p. 110

ANALOGUE



MicroRex
analogue time switches
DIN rail mountable
see p. 111



MaxiRex and EconoRex
analogue time switches
Surface / panel mounting
see p. 112

LIGHTING CONTROL



Programmable light
sensitive switch
For lighting control
see p. 113



Electronic time lag
switch
For lighting control
see p. 113



4126 31



4128 72



4128 73



4126 57



4128 72



4128 73

Technical information p. 107

Conform to EN 60730-1 and EN 60730-2-7
 Supply voltage : 230 V~ 50/60 Hz
 Mount on DIN rail EN 60715
 Text based programming. Programmable in 15 languages
 Programme directly on time switch keypad or remotely via a PC with Legrand AlphaSoft software, USB adaptor and data key
 Data key enables programmes to be transferred from one unit to another and for programmes to be stored
 EEPROM memory keeps programmes stored indefinitely
 Pin code facility to protect programmes from unauthorised changes
 Time switch accuracy : ±0.1 second per day
 Zero-crossing switching
 Automatic summer/winter time correction
 5 years running reserve
 Back lit graphic display
 Operating temperature : -20 °C to +55 °C
 Protection : IP 20
 Switching increment : 1 second
 Shortest switching time : 1 second

Pack	Cat. Nos.	AlphaRex ³	No. of 17.5 mm modules
1	4126 31	Weekly time switches 24h / 7 day programme time Particularly suited to irregular cycles (e.g. security installations and industrial installations) Random function to simulate presence - programmed switching cycles are shifted at random with a range of ±15 minutes Additional functions : Operating hours counter (for max. 65,535 hours) 1 hour test Cycle function Holiday programme AlphaRex D21 230 V 24 hr / 7 day single channel 1 x 16 A output 56 programmes	2
1	4126 41	AlphaRex D22 230 V 24 hr / 7 day two channel 2 x 16 A outputs 2 x 28 programmes	2

Pack	Cat. Nos.	Accessories
1	4128 72	Programming transfer key Enables programmes to be stored and / or transferred from one time switch to another when used with the programming software kit Cat. No. 4128 73 Data key can be stored directly within the time switch
1	4128 73	Programming software kit Create and read programmes remotely via a PC Transfer programmes via transfer key Cat. No. 4128 72 to time switches Kit comprises : AlphaSoft 4-0 software, data loader and transfer key Windows®1 Vista compatible

1 : Windows is a registered trademark of the Microsoft Corporation

Technical information p. 108

Conform to EN 60730-1 and EN 60730-2-7
 Supply voltage : 230 V~ 50/60 Hz
 Mount on DIN rail EN 60715
 Text based programming. Programmable in 15 languages
 Programme directly on time switch keypad or remotely via a PC with Legrand AlphaSoft software, USB adaptor and data key
 Data key enables programmes to be transferred from one unit to another and for programmes to be stored
 EEPROM memory keeps programmes stored indefinitely
 Pin code facility to protect programmes from unauthorised changes
 Time switch accuracy : ±0.1 second per day
 Zero-crossing switching
 Automatic summer/winter time correction
 5 years running reserve
 Back lit graphic display
 Operating temperature : -20 °C to +55 °C
 Protection : IP 20
 Switching increment : 1 second
 Shortest switching time : 1 second

Pack	Cat. Nos.	AlphaRex ³ Astro light control	No. of 17.5 mm modules
1	4126 54	Weekly time switches 24h / 7 day programme time Particularly suited to outdoor lighting and street signage applications Enables the daily astronomical calculation of sunrise and sunset by inputting local position or coordinates (no need to install a light sensor) Lights are switched ON and OFF according to sunrise and sunset times, and can be offset by up to ±120 minutes in relation to sunrise and sunset times To save energy, it is also possible to programme an ON and OFF time at night Time saving programming due to pre-set groups of days : Mon-Sun, Mon-Fri, or Sat-Sun and individual selection of days Programmes are shown as a weekly matrix on the graphic display Additional functions : Operating hours counter (for max. 65,535 hours) 1 hour test. Holiday programme Expert mode for additional functions : Cycle function Control input (Cat. No. 4126 54 only) Mains synchronisation Channel switching AlphaRex Astro D21 230 V 24 hr / 7 day single channel 1 x 16 A output. 56 programmes	2
1	4126 57	AlphaRex Astro D22 230 V 24 hr / 7 day two channel 2 x 16 A outputs. 2 x 28 programmes	2

Pack	Cat. Nos.	Accessories
1	4128 72	Programming transfer key Enables programmes to be stored and / or transferred from one time switch to another when used with the programming software kit Cat. No. 4128 73 Data key can be stored directly within the time switch
1	4128 73	Programming software kit Create and read programmes remotely via a PC Transfer programmes via transfer key Cat. No. 4128 72 to time switches Kit comprises : AlphaSoft 4-0 software, data loader and transfer key Windows®1 Vista compatible

1 : Windows is a registered trademark of the Microsoft Corporation

AlphaRex³ programmable time switches

digital for rail



■ Dimensions (mm)

Cat. Nos. 4126 31/41

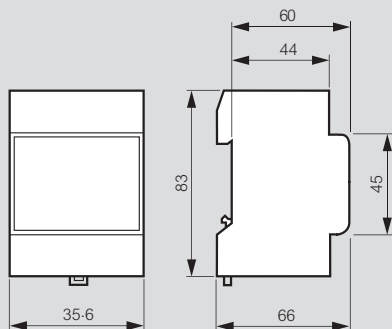

■ Wiring diagrams

Cat. No. 4126 31

Cat. No. 4126 41

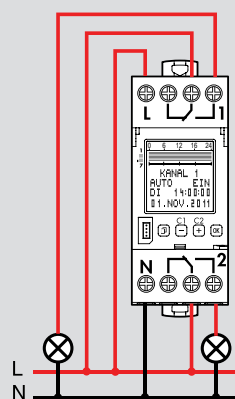
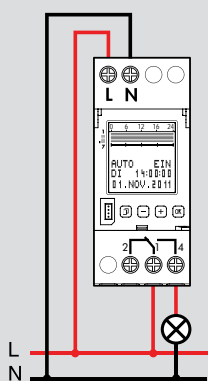

Technical information

Type Cat. No.	AlphaRex ³ D21 4126 31	AlphaRex ³ D22 4126 41
Supply voltage	230 V~	
Frequency	50/60 Hz	
Programme	24 hour or 7 day	
No. of channels	1	2
Effective power consumption	Approx 1 W	ca 1.5 W
Switching capacity : cos φ = 1	16 A 250 V~	
Contact	1 changeover switch	2 changeover switches
Parallel compensation	600 W max, 70µF	
Switching step	1 second	
Min. switching time	1 second	
Accuracy	±0.1 seconds per day	
Terminal capacity	Single strand 1.5 to 4mm ²	
Programmes	56	28 per channel
Working reserve ¹	5 years	
Programme memory	EEPROM	
Summer/Winter time	Auto	
IP rating	IP 20	
No. of 17.5 mm modules	2	
Operating temp.	-20 °C to +55 °C	
Storage temp.	-20 °C to +60 °C	

1 : For time and date only

■ General information

AlphaRex³ D21 Cat. No. 4126 31

• **Start-up** : after applying the supply voltage, the time switch starts automatically with the last selected function. The relay position is set by the current programme

• **Battery backup**

- **Backlighting** not active
- **Data key** READ/WRITE only via the menu

Select menu, back to main menu, Hold down > 1s = operating display

Confirm selection or load parameters

Select menu options or set parameters

AlphaRex³ D22 Cat. No. 4126 41

• **Start-up** : after applying the supply voltage, the time switch starts automatically with the last selected function. The relay position is set by the current programme

• **Battery backup**

- **Backlighting** not active
- **Data key** READ/WRITE only via the menu

• **For safety** : when the time switch is connected to the mains supply the contact should not be used on an isolated low voltage supply and when the time switch is connected to the isolated voltage supply the contact should not be used on the mains supply

Select menu, back to main menu, Hold down > 1s = operating display

Confirm selection or load parameters

C1 C2
 • Select menu options or set parameters
 • Channel selection



■ Dimensions (mm)

Cat. Nos. 4126 54/57

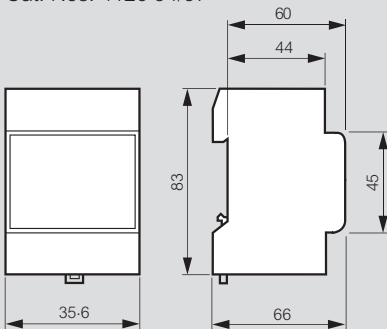

■ Wiring diagrams

Cat. No. 4126 54

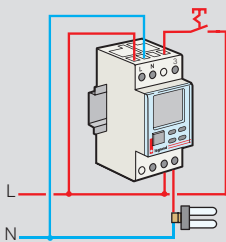

Cat. No. 4126 57

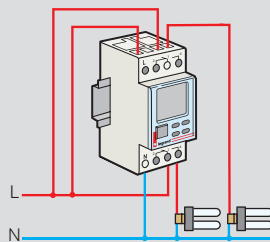

Output closing and breaking times are calculated based on the date, the actual time when the device was switched and on geographical coordinates of the actual location

Cat. No. 4126 54

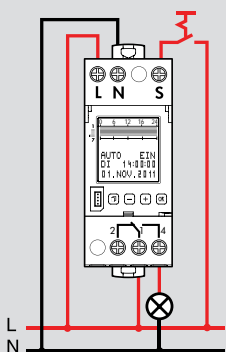

Cat. No. 4126 57

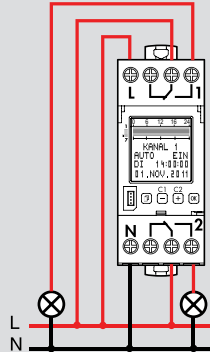

■ General information

AlphaRex³ Astro D21 Cat. No. 4126 54

• **Start-up** : after applying the supply voltage, the time switch starts automatically with the last selected function. The relay position is set by the current programme

• **Battery backup**

- **Backlighting** not active
- **Data key** READ/WRITE only via the menu

Select menu, back to main menu, Hold down > 1s = operating display

Confirm selection or load parameters

Select menu options or set parameters

■ Technical information

Type Cat. No.	AlphaRex ³ Astro D21 4126 54	AlphaRex ³ Astro D22 4126 57
Supply voltage	230 V~	
Frequency	50/60 Hz	
Programme	24 hour or 7 day	
No. of channels	1	2
Effective power consumption	1 W	1.5 W
Switching capacity : cos φ = 1	16 A 250 V~	
Contact	1 changeover switch	2 changeover switches
Min. prog. setting	1 second	
Accuracy	±0.1 seconds per day	
Terminal capacity	Single strand 1.5 to 4mm ²	
Programmes	56	28 per channel
Control-cable length	Max. 50 m	
Control signal	230 V AC/2 mA	
Control-pulse duration	100 to 200 ms	
Delay time	0 to 23 h 59 min 59 s	
Local coordinates	Resolution 1°/1' in EXPERT-Mode	
Working reserve ¹	5 years	
Programme memory	EEPROM	
Summer/Winter time	Auto	
IP rating	IP 20	
No. of 17.5 mm modules	2	
Operating temp.	-20 °C to +55 °C	
Storage temp.	-20 °C to +60 °C	

1 : For time and date only

AlphaRex³ Astro D22 Cat. No. 4126 57

• **Start-up** : after applying the supply voltage, the time switch starts automatically with the last selected function. The relay position is set by the current programme

• **Battery backup**

- **Backlighting** not active
- **Data key** READ/WRITE only via the menu

• **For safety** : when the time switch is connected to the mains supply the contact should not be used on an isolated low voltage supply and when the time switch is connected to the isolated voltage supply the contact should not be used on the mains supply

Select menu, back to main menu, Hold down > 1s = operating display

Confirm selection or load parameters

C1 C2
 Select menu options or set parameters
 Channel selection

MicroRex D digital time switches

for rail



6037 70

0037 00

Conform to EN 60730-1 and EN 60730-2-7
LCD digital display
Mount on DIN rail EN 60715

Pack	Cat. Nos.	MicroRex D Plus	No. of 17.5 mm modules
1	6037 70	MicroRex D21 Plus UK specific English display Supply voltage : 220 V~ 50 Hz CE approved 16 A 56 programmes per channel 3 years working reserve Accuracy : 1 second clock precision Switching precision : 1 minute	2
1	6037 71	MicroRex D22 Plus 2 channels	2

Pack	Cat. Nos.	MicroRex D	No. of 17.5 mm modules
1	0037 00	MicroRex D11 – 1 module 8 programmes 1 channel 1 x 16 A – 250 V~ voltage free c/o contacts with 8 "ON-OFF" per day or per week Supply voltage : 230 V~ 50/60 Hz Working reserve : 100 hours Accuracy : ±2.5 seconds per day 7 day programme Programmable for 1 minute min. at 1 minute steps Additional features : Manual advance/override (ON-OFF) Automatic override (ON-OFF) for holidays, weekends or bank holidays up to 99 days successively Automatic summer/winter setting	1

Technical information

Type Cat. No.	MicroRex D21 Plus 6037 70	MicroRex D22 Plus 6037 71	MicroRex D11 0037 00
Programme	24 hour or 7 day		
No. of channels	1	2	1
No. of ON-OFF actions per day/week	28	2 x 14	8
Switching cap : cos φ = 1 incandescent lamp cos φ = 0.6	16 A 5 A 8 A		16 A 4 A 10 A
Contact	1 c/o	2 c/o	1 c/o
Terminal capacity	1 - 4 mm ² single/0.5 - 2.5 mm ² stranded		
IP rating	IP 20		
Min. prog. time	1 minute		
Switching step	1 minute		
Accuracy	±1 second per day	±2.5 sec/d	
Working reserve¹	3 years	>100 hrs	
Prog. memory	EEPROM		–
Manual switching	Override and permanent		
No. of 17.5 mm modules	2	1	
Operating temp.	–20 °C to +55 °C		–10 °C to +55 °C
Storage temp.	–20 °C to +60 °C		–
Weight	137 g		100 g

1 : For time and date only

Dimensions (mm) and wiring diagrams

MicroRex D21/D22 Plus

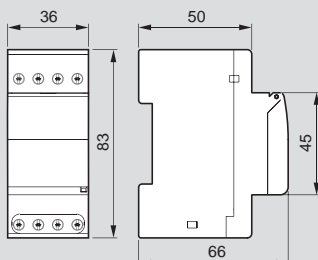

Wiring diagram

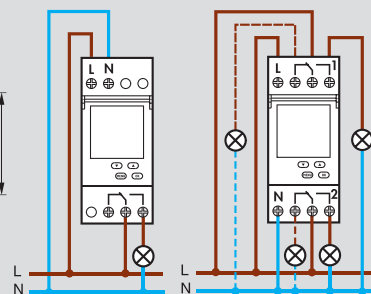

MicroRex D11

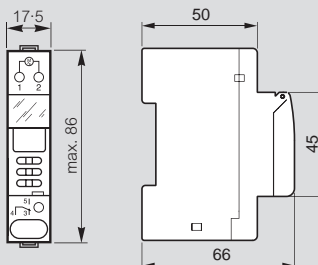

Wiring diagram

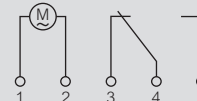

MaxiRex digital time switches

surface or 72 x 72 mm panel mounting



0496 82

Conform to EN 60730-1 and EN 60730-2-7
 Supply voltage : 230 V~ 50/60 Hz
 Accuracy : ±1 second per day
 LCD digital display
 Programmable for 1 minute minimum at 1 minute intervals
 Panel and DIN rail mounting :
 - can be panel mounted using Cat. No. 0498 32
 - can be clipped to DIN rail using Cat. No. 0044 09

Pack	Cat. Nos.	MaxiRex D Plus
		Working reserve : 6 years Programmable for 1 minute min. at 1 minute steps either as 24 hour/7 day using pre-set groups of days One programme consists of 1 "ON" and 1 "OFF" time and the allocation of any day of the week or a combination of days. Plus the selected channel Example : Prog. 1 On 07.00hrs Off 08.15hrs Mon-Fri Ch1 Prog. 2 On 16.00hrs Off 20.15hrs Mon-Fri Ch2 Prog. 3 On 10.00hrs Off 16.15hrs Sat-Sun Ch1 Additional features : EEPROM memory stores programme indefinitely Optional automatic summer/winter time change Manual override (ON or OFF) Automatic advance (changes contact position until next automatic ON time)
1	0496 80	MaxiRex D72/1 Plus 24 hour or 7 day 28 programme 1 channel 1 x 16 A voltage free c/o contact
1	0496 82	MaxiRex D72/2 Plus 24 hour or 7 day 2 x 14 programme 2 channel 2 x 8 A voltage free c/o contacts

Fixing accessories		
5	0498 32	Clip-on support frame for panel mounting
5	0044 09	DIN rail adaptor

Technical information

Type Cat. No.	MaxiRex D72/1 Plus 0496 80	MaxiRex D72/2 Plus 0496 82
Programme	24 hour or 7 day	
No. of channels	1	2
No. of ON-OFF actions per day	28	2 x 14
Switching capacity : cos φ = 1 incandescent lamp cos φ = 0.6	16 A 5 A 8 A	8 A 3.5 A 4 A
Contact	1 changeover switch	2 changeover switches
Min. prog. time	1 minute	
Switching step	1 minute	
Accuracy	±1 second per day	
Working reserve ¹	6 years	
Programme memory	EEPROM	
Manual switching	Override and permanent	
Operating temp.	-20 °C to +55 °C	
Storage temp.	-20 °C to +60 °C	
Weight	178 g	204 g

1 : For time and date only

Dimensions (mm)

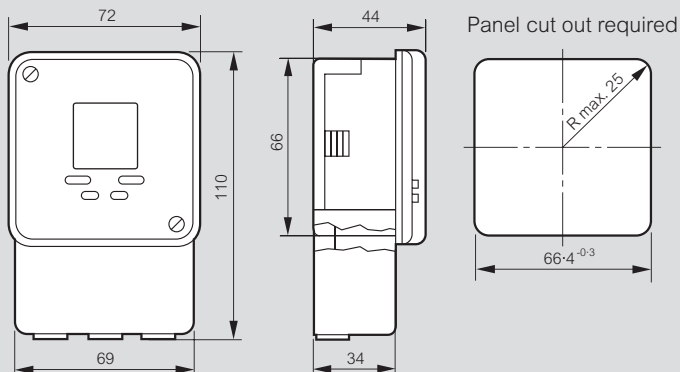

Wiring diagrams

MaxiRex D72/1 Plus

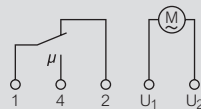

MaxiRex D72/2 Plus

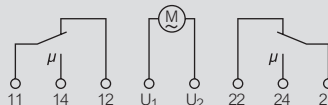

MaxiRex D72/2 Plus

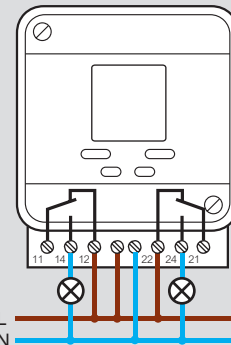

Mounting options

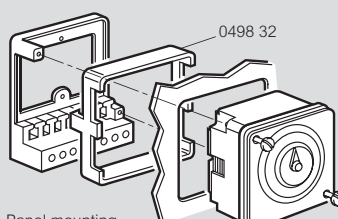

Panel mounting with support Cat. No. 0498 32 to be ordered separately

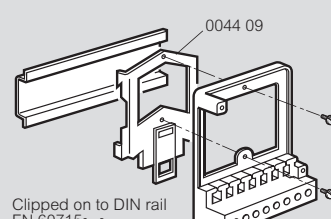

Clipped on to DIN rail EN 60715 Adaptor to be ordered separately (Cat. No. 0044 09)

MicroRex analogue time switches

for rail



4127 90



4127 95

Conform to EN 60730-1 and EN 60730-2-7
 Programmed via captive segment
 Supply voltage : 230 V~ 50/60 Hz
 1 x 16 A output
 Manual changeover to summer/winter time
 Mount on DIN rail EN 60715

Pack	Cat. Nos.	Daily programme
1	4127 80	24 hour programme One segment : 15 minutes Switching accuracy : ± 5 minutes T11 Daily 1 channel Without working reserve N/O contact Minimum switching time : 15 minutes Vertical dial
1	4127 90	QT11 Daily 1 channel With 100 hr working reserve N/O contact Minimum switching time : 15 minutes Vertical dial
1	4128 12	T31 Daily 1 channel Without working reserve Changeover switch Minimum switching time : 30 minutes Horizontal dial
1	4128 13	QT31 Daily 1 channel With 100 hr working reserve Changeover switch Minimum switching time : 30 minutes Horizontal dial
Weekly programme		
1	4127 94	7 day programme One segment : 2 hours Switching accuracy : ± 30 minutes QW11 Weekly With 100 hr working reserve N/O contact Minimum switching time : 2 hours Vertical dial
1	4127 95	QW31 Weekly With 100 hr working reserve Changeover switch Minimum switching time : 4 hours Horizontal dial

No. of 17.5 mm modules
1

1

3

3

No. of 17.5 mm modules
1

3

Technical information

Cat. Nos.	Programme	Segment	Min. switching time	Working reserve	16 A output via contact		No. of modules
					N/O	Chang. S.	
4128 12	24 h	15 min	30 min	without	-	1	3
4128 13	24 h	15 min	30 min	100 h	-	1	3
4127 80	24 h	15 min	15 min	without	1	-	1
4127 90	24 h	15 min	15 min	100 h	1	-	1
4127 94	7 d	2 h	2 h	100 h	1	-	1
4127 95	7 d	2 h	4 h	100 h	-	1	3

Wiring diagrams

Cat. Nos. 4127 80/90/94

Cat. Nos. 4128 12/13/4127 95

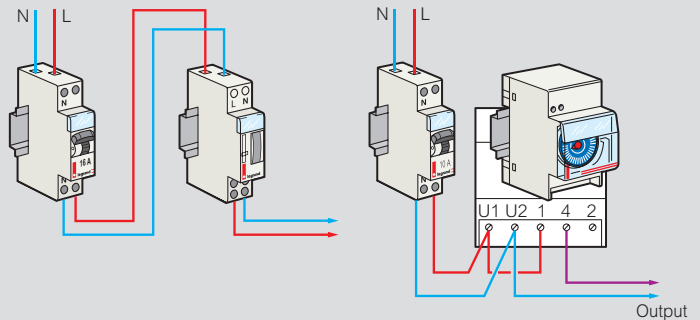

Output closing and breaking times are calculated based on the date, the actual time when the device was switched and on geographical coordinates of the actual location

Dimensions (mm)

Cat. Nos. 4127 80/90/94

Cat. Nos. 4128 12/13/4127 95

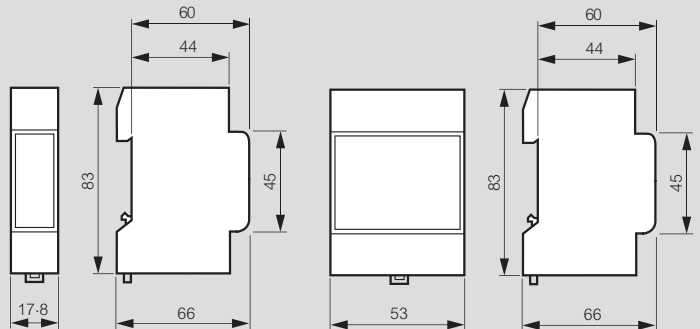

MaxiRex and EconoRex analogue time switches

surface and panel mounting



Pack	Cat. Nos.	MaxiRex
		<p>Conform to EN 60730-1 and EN 60730-2-7 Supply voltage : 230 V~ ±10% 3 position changeover switch With manual override Voltage free contacts Mounting options : - can be surface mounted - can be panel mounted using Cat. No. 0498 32 - can be clipped to DIN rail using Cat. No. 0044 09</p> <p>With 72 x 72 mm display to DIN EN 60715 Part C</p> <p>24 hour programme Programmable for 30 minutes minimum at 10 minute intervals Accuracy : ±5 minutes per day</p>
1	0497 50	MaxiRex T Without working reserve – 50 Hz
1	0497 54	MaxiRex QT With 100 hr working reserve – 50/60 Hz
		<p>7 day programme Programmable for 3 hours minimum at 1 hour intervals Accuracy : ±30 minutes per day</p>

Fixing accessories		
5	0498 32	Clip-on support frame for panel mounting
5	0044 09	DIN rail adaptor

EconoRex MT		
1	0499 83	<p>Conforms to EN 60730-1 and EN 60730-2-7 Supply voltage : 230 V~ 50 Hz Mounting options : - can be surface mounted using Cat. No. 0495 94 - can be panel mounted</p> <p>EconoRex MT BTAP without working reserve 20 A output Shortest switching step : 20 minutes Switching accuracy : ± 5 minutes</p>

Fixing accessory		
1	0495 94	Support frame for surface mounting

Technical information

Type Cat. No.	MaxiRex T 0497 50	MaxiRex QT 0497 54	EconoRex MT 0499 83
Supply voltage	230 V~+10% -15%		
Frequency	50 Hz	50/60Hz	50 Hz
Switching capacity : cos φ = 1 cos φ = 0.6 incand. lamp	16 A 10 A 1 000 W		16 A 8 A 1 000 W
Contact	1 c/o SPDT	1 c/o SPDT	1 c/o
Working reserve	None	100 hrs	None
Min. switching time	30 mins		15 mins
Interval	10 mins		15 mins
IP rating	IP 30		
Storage temp.	-10 °C to +60 °C		
Operating temp.	0 °C to +55 °C		

Dimensions (mm)

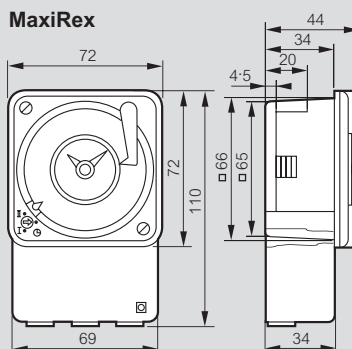

MaxiRex mounting

Wall mounting

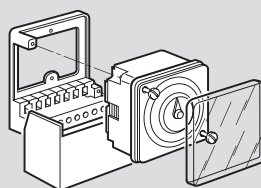

Panel mounting

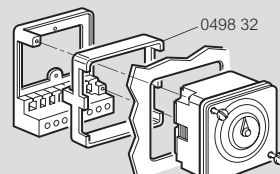

Panel mounting with support
 Cat. No. 0498 32
 to be ordered separately

DIN rail mounting

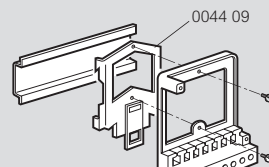

Clipped on to
 DIN rail EN 60715
 Adaptor to be ordered
 separately (Cat. No. 0044 09)

Wiring diagrams

MaxiRex and EconoRex

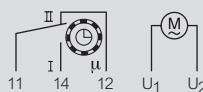

EconoRex mounting

Wall mounting

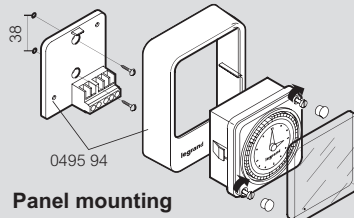

Panel mounting

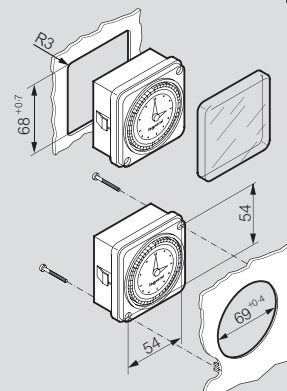

Time switches are ideal for use
 with Bticino door entry systems
 Contact us on +44 (0) 845 605 4333



light sensitive control and electronic time lag switches

digital for rail



4126 26



4126 02

Pack	Cat. Nos.	Programmable light sensitive switch
1	4126 26	<p>Can be used to switch a lighting circuit "ON" and "OFF" based on light conditions (nightfall, daybreak) Supplied with IP 65 weatherproof photoelectric cell Power supply : 230 V\sim - 50/60 Hz</p> <p>Standard</p> <p>56 programmes possible : daily, weekly or yearly programmes Output 16 A - 250 V\sim - μ cos φ = 1 2000 W incandescent 2000 VA series compensated fluorescent 1000 W energy-saving bulb Integrated hour counter High precision clock : \pm 0.1 sec per day at 25°C Working reserve : 5 years Adjustable from 3 to 100 000 lux Automatic changeover between summer/winter time Number of modules : 2 Programmed using programme transfer key Cat. No. 4128 72 (below) Supplied with IP 65 photoelectric cell Cat. No. 4128 58²</p>

Pack	Cat. Nos.	Accessories
1	4128 72	<p>Programming transfer key</p> <p>Enables programmes to be stored and / or transferred from one time switch to another when used with the programming software kit Cat. No. 4128 73 Data key can be stored directly within the time switch</p>
1	4128 73	<p>Programming software kit</p> <p>Create and read programmes remotely via a PC Transfer programmes via transfer key Cat. No. 4128 72 to time switches Kit comprises : AlphaSoft 4.0 software, data loader and transfer key Windows^{®1} Vista compatible</p>

Pack	Cat. Nos.	Electronic time-lag switch
10	4126 02	<p>For staircase lighting. Switches a lighting circuit on and off from remote switch for a specific time DIN rail mountable Self-protection in the event of a blocked push button</p> <p>Power supply : 230 V\sim - 50/60 Hz 2 000 W incandescent 2 000 W halogen - 230 V\sim 1 000 VA fluo-series compensated 120 VA fluo-parallel compensated 14 μF 100 VA compact fluorescent 1 000 W energy saving lamp Adjustable from 0.5 seconds to 10 minutes</p> <p>Output : 16 A - 250 V\sim - cos φ = 1 3 wire or 4 wire connection Manual override contact Number of modules : 1</p>

Technical information

Type Cat. No.	Light sensitive switch 4126 26	Electronic time-lag 4126 02
Supply voltage	230 V \sim	
Frequency	50/60 Hz	
Consumption	~1 W	0.8 W
Contact rating	Changeover contact 16 A 250 V \sim μ cos φ = 1	μ 16 A cos φ = 1/250 V \sim
Accuracy	\pm 0.1 second per day	\pm 2.5 seconds per day
Terminal capacity	Single strand 1.5 to 4 mm ²	Multi strand 1.5 to 2.5 mm ²
Program pictures	56	
Battery reserve	5 years	100 minutes
Operating temp.	-20 °C to +55 °C	-20 °C to +55 °C
Storage temp.	-20 °C to +60 °C	-20 °C to +70 °C
Setting range	1 lx ... 100 klx	
IP rating	IP 20	IP 30

Time-lag switch

Allows :

- unlimited numbers of unlit push-buttons
- 50 lit push-buttons max. (neon R = 1 mA max.)
Constant lighting possible

3-wire connection

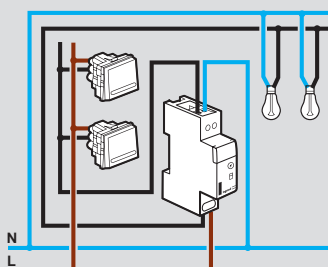

4-wire connection

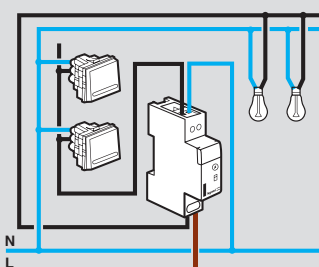

1 : Windows is a registered trademark of the Microsoft Corporation
2 : Contact us on +44 (0) 845 605 4333



VIKING 3 TERMINAL BLOCKS

Viking 3



P. 118
Terminal blocks –
screw connection
selection chart



P. 122
Terminal blocks –
spring connection
selection chart



P. 132
Terminal blocks –
heavy duty
selection chart

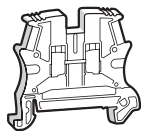

P. 120
Terminal blocks –
screw
connection

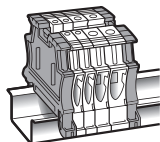

P. 126
Accessories for
terminal blocks



P. 128
Technical
information

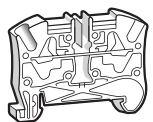

P. 124
Terminal blocks –
spring
connection

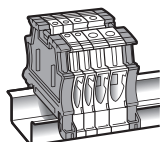

P. 126
Accessories for
terminal blocks



P. 130
Technical
information



P. 133
Heavy duty
terminal blocks
for copper and
aluminium cables

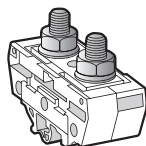

P. 134
Heavy duty
terminal blocks for
copper bars and
cable lugs



P. 135
Technical
information

VIKING 3[®]



fast, secure connections every time

Available with a choice of screw, spring and heavy duty connection options, Viking 3 terminal blocks provide trusted, safe and reliable installations whatever your application.

Terminal blocks in the screw and spring connection ranges are complemented by a range of common accessories, including end stops, dividers and bridging combs.

Used in conjunction with Legrand's CAB 3 marking system and Starfix ferrules and crimping tools, Viking 3 provides a total solution for easy to use connection systems.

TECHNICAL DATA

APPROVALS:

Conform to EN 60947-7-1,
EN 60947-7-2, EN 60947-7-3,
UL / CSA / NF / VDE / IMQ
ATEX certification

SIZE RANGE:

To fit cable cross sections from
0.25mm² to 300mm²

FLAMMABILITY:

UL94, self extinguishing at 960°C



SCREW CONNECTION



Universal screw technology, ideal for distribution and process cabinets.

FEATURES

- Cable capacities from 0.25mm² to 95mm²
- High quality steel clamp ensures mechanical strength
- Angled cable entries for easy cabling and visible cable marking
- 2 central shunting zones
- Supplied pre-assembled in blocks of 5 or 10, using fixing pin
- 2 marking zones

SPRING CONNECTION



Ideal for vibration sensitive environments such as cranes, machines and onboard cabinets.

FEATURES

- Cable capacities from 0.5mm² to 16mm²
- Angled cable entries for easy cabling and visible cable marking
- Direct insertion of rigid cable, or flexible cable with ferrules, in terminal blocks up to 6mm²
- 2 central shunting zones
- Reduced cabling time
- Automatic connection with or without ferrules
- 2 marking zones
- No regular retightening required
- 5mm pitch block facilitates 4mm cable

HEAVY DUTY CONNECTION



Enables copper and aluminium cables with cross sections from 35mm² to 300mm² to be connected directly or via lugs.

FEATURES

- Multiple mounting options: DIN rail, G rail or plate fixing
- Compatible with CAB 3 marking system
- Sealable to create weatherproof connections
- Separation barriers and protective covers available
- Provide facility for the termination of larger cables associated with long cable runs



INTEGRATED ACCESSORIES



Common accessories across the screw and spring connection ranges include:

- End stops with screwless fixing
- Bridging comb with automatic insertion up to 8mm (screw) or 12mm (spring) widths
- Identification of blown fuses (12 / 48 V or 110 / 250 V)
- Additional functions can be added: standard, neutral or protected isolation, MCBs, automotive-type fuses, etc.

Perfect connections...

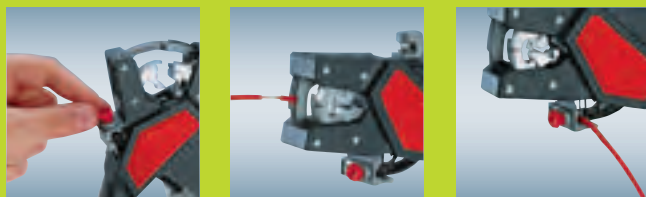

Create reliable connections in seconds with Starfix crimping tools and ferrules... everything you need for cable widths from 0.25mm² to 50mm².

See p. 148 to 149

clearly marked

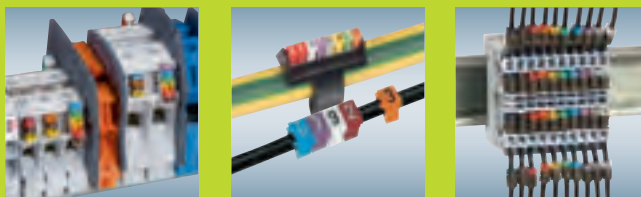

CAB 3 offers a high quality solution to multiple cable and terminal block marking needs. Universal fittings enable clear, rapid marking and simple modification.

See p. 138 to 143

Viking 3 terminal blocks – screw connection

for copper cable

		Product detail p. 120-121		TERMINAL TYPE		
0371 61 0371 63 0371 64 0371 66 0371 69 0371 68 0371 00 0371 08 0371 20 0371 30	Connection p. 120	1 connection - 1 entry/1 exit				
		1 connection - 2 entries/2 exits				
		2 connections on 2 levels				
		3 connections on 3 levels				
0371 71 0371 76 0371 78 0371 79	Protection p. 120	1 connection - 1 entry/1 exit - metal base				
		1 connection - 1 entry/1 exit - plastic base ¹				
		1 connection - 2 entries/2 exits - metal base				
0371 80 0371 81 0371 84 0371 86 0371 87	Disconnection p. 121	1 connection	Open (to be equipped)			
			For fuse cartridge 5 x 20 with handle lever			
			For fuse cartridge 5 x 20 with handle lever + blown fuse indicator			
			For neutral circuit with handle lever			
			For standard circuit	With handle lever		
				With mini lever		
			For circuit not broken	With handle lever		
With mini lever						
For fuse cartridge 5 x 20 with screwed plug						
0371 51 0371 52	For sensors and actuator p. 121 PNE p. 121	3 connections on 3 levels	Sensor			
			Actuator			
			Phase/Neutral/Earth			

1 : Can be used for protection conductor inside class II equivalent assemblies
 2 : Blown fuse indicator 12/24/48 V ~ Cat. No. 0375 24 or 110/250 V ~ Cat. No. 0375 25 (p. 127)
 3 : Or end stop Cat. No. 0375 10 (p. 126)

4 : Upper level only
 5 : Lower and intermediate levels

accessories

for Viking 3 terminal blocks - screw connection

TERMINAL BLOCK				INSULATION		BRIDGING COMBS					PROTECTION		MEASURE- MENT	ASSOCIATED PRODUCTS
Nominal cross section (mm ²)	Width (mm)	Colour	Cat. Nos.	End cap	Separation / insulation divider	Comb for 2 blocks, auto. front	Comb for 3 blocks, auto. front	Comb for 10 blocks, auto. front	Comb for 12 blocks, side	Bar for 12 blocks, front	Single pole screen	Cut to length screen	Test meter adaptor	
2-5	5		0371 60	0375 50 ³	0375 60	0375 02	-	0375 01	-	-	0375 65	0375 68	0375 27	<p>End stops p. 126</p>
			0371 00											
			0371 20											
4	6		0371 61	0375 50 ³	0375 60	0375 05	-	0375 04	-	-	0375 65	0375 68	0375 27	<p>Label holder for end stop p. 126</p>
			0371 01											
			0371 21											
			0371 31											
6	8		0371 62	0375 50 ³	0375 60	-	0375 07	-	-	-	0375 66	0375 68	0375 27	<p>End caps p. 126</p>
			0371 78											
10	10		0371 63	0375 50 ³	0375 60	-	-	-	-	0375 40	0375 66	0375 68	-	
16	12		0371 64	0375 51	0375 61	-	-	-	-	0375 42	0375 67	0375 69	-	<p>End caps p. 126</p>
			0371 04											
35	15		0371 65	0375 51	0375 61	-	-	-	-	0375 44	0375 67	0375 69	-	
			0371 05											
70	22		0371 66	built-in	-	-	-	-	-	-	-	-	-	
4	6		0371 69	0375 52	0375 62	0375 05	-	0375 04	-	-	-	-	0375 27	
			0371 09											
2-5	5		0371 67	0375 53	0375 63	0375 02	-	0375 01	-	-	-	-	0375 27 ⁴	
			0371 07											
4	6		0371 68	0375 53	0375 63	0375 05	-	0375 04	-	-	-	-	0375 27 ⁴	<p>Dividers p. 126</p>
			0371 08											
2-5	5		0371 51	0375 54	0375 54	0375 02 ⁴	-	0375 01 ⁴	0375 46 ⁵ 0375 47 ⁵	-	-	-	0375 27 ⁴	
			0371 70											
4	6		0371 71	0375 50 ³	-	-	-	-	-	-	-	-	-	
6	8		0371 72											
10	10		0371 73											
16	12		0371 74	0375 51	-	-	-	-	-	-	-	-	-	<p>Blown fuse indicators p. 127</p>
35	15		0371 75											
35	15		0371 76	-	-	-	-	-	-	-	-	-	-	
4	6		0371 77	0375 50	0375 60	0375 05	-	0375 04	-	-	0375 65	0375 68	-	<p>Shielding p. 127</p>
			0371 78											
6	8		0371 78	0375 50	0375 60	-	0375 07	-	-	-	0375 66	0375 68	-	
4	6		0371 79	0375 52	-	-	-	-	-	-	-	-	-	
2-5	6		0371 80	0375 55	0375 62	0375 05	-	0375 04	-	-	-	-	0375 27	<p>CAB 3 marking system p. 140</p>
			0371 81											
			0371 81 + 0375 24 / 25 ²											
			0371 82											
			0371 83											
			0371 84											
			0371 85											
			0371 86											
10	12		0371 87	0375 56	-	-	-	-	-	-	-	-		
2-5	5		0371 51	0375 54	0375 54	0375 02 ⁴	-	0375 01 ⁴	0375 46 ⁵ 0375 47 ⁵	-	-	-	0375 27 ⁴	<p>Starfix ferrules p. 148</p>
			0371 52											

Viking 3 terminal blocks – screw connection

for copper cable

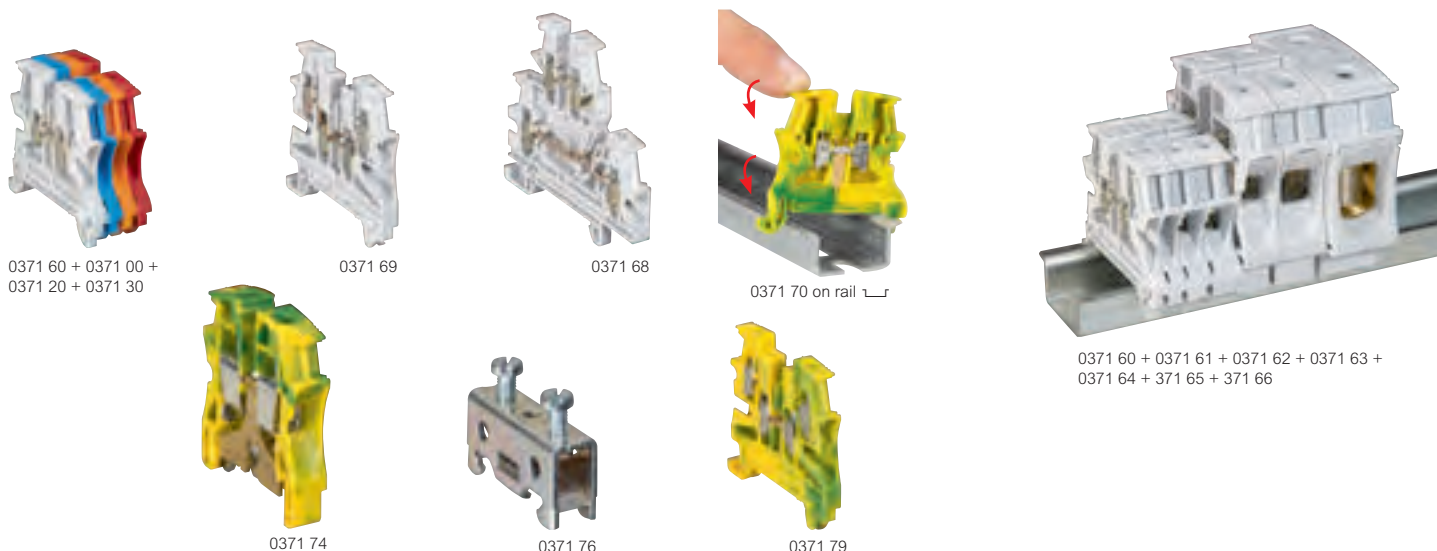

Accessories **p. 126-127**
 Technical characteristics **p. 128-129**

All V2 polyamide UL94 960 °C to IEC EN 60695-2-11
 Compatible with either rigid (0.25 mm² to 95 mm²) or flexible (0.25 mm² to 70 mm²) copper cables
 Facility for 2 bridging combs
 Compatible with rails depth 15 mm and rails EN 60715 depth 7.5 mm and 15 mm
 Range comprises only 2 block heights (2.5 mm² to 10 mm² and 16 mm² to 70 mm²) ensuring a neat installation

Pack	Cat. Nos.	Connection	Capacity			Width (mm)
			Nominal cross section (mm ²)	Rigid cable (mm ²)	Flexible cable (mm ²)	
Grey for standard circuit Blue for neutral conductor Orange for circuit not broken by the master isolating device Red for special circuits (safety, protected, etc)						
1 connection - 1 entry/1 exit						
60	0371 60	Grey ●	2.5	0.25 to 4	0.25 to 2.5	5
60	0371 00	Blue ●				
60	0371 20	Orange ●				
60	0371 30	Red ●				
50	0371 61	Grey ●	4	0.25 to 6	0.25 to 4	6
50	0371 01	Blue ●				
50	0371 21	Orange ●				
50	0371 31	Red ●				
40	0371 62	Grey ●	6	0.5 to 10	0.25 to 6	8
40	0371 02	Blue ●				
30	0371 63	Grey ●	10	1.5 to 16	2.5 to 10	10
30	0371 03	Blue ●				
20	0371 64	Grey ●	16	1.5 to 25	4 to 16	12
20	0371 04	Blue ●				
20	0371 65	Grey ●	35	2.5 to 50	4 to 35	15
20	0371 05	Blue ●				
10	0371 66 ¹	Grey ●	70	25 to 95	16 to 70	22
1 connection - 2 entries/2 exits						
25	0371 69	Grey ●	4	0.25 to 6	0.25 to 4	6
25	0371 09	Blue ●				
2 connections on 2 levels						
60	0371 67	Grey ●	2.5	0.25 to 4	0.25 to 2.5	5
60	0371 07	Blue ●				
60	0371 68	Grey ●	4	0.25 to 6	0.25 to 4	6
60	0371 08	Blue ●				
3 connections on 3 levels						
50	0371 51 ²	Grey ●	2.5	0.25 to 4	0.25 to 2.5	5



Pack	Cat. Nos.	Protection	Capacity			Width (mm)
			Nominal cross section (mm ²)	Rigid cable (mm ²)	Flexible cable (mm ²)	
1 connection - 1 entry/1 exit - metal base						
Screwless fixing on rail up to 10 mm width PEN from 10 mm ²						
60	0371 70	Green/yellow ●	2.5	0.25 to 4	0.25 to 2.5	5
50	0371 71	Green/yellow ●				
40	0371 72	Green/yellow ●	6	0.5 to 10	0.25 to 6	8
30	0371 73	Green/yellow ●				
10	0371 74	Green/yellow ●	16	1.5 to 25	4 to 16	12
10	0371 75	Green/yellow ●				
10	0371 76	-	35	2.5 to 50	4 to 35	15
1 connection - 2 entries/2 exits - metal base						
Screwless fixing on rail						
50	0371 79	Green/yellow ●	4	0.25 to 6	0.25 to 4	6
1 connection - 1 entry/1 exit - plastic base						
Can be used for protection conductor inside class II equivalent assemblies						
50	0371 77	Green ●	4	0.25 to 6	0.25 to 4	6
40	0371 78	Green ●				
PNE - Phase/Neutral/Earth						
3 connections on 3 levels - metal base						
Green/yellow marking for the lower level Screwless fixing on rail						
50	0371 52 ²	Grey ●	2.5	0.25 to 4	0.25 to 2.5	5



CAB 3 marking system **p. 140-142**
 Starfix ferrules and crimping tools **p. 148-149**

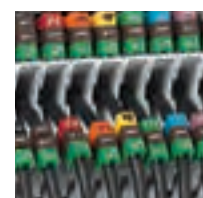

1 : Built-in end cap
 2 : Cable capacity - 2.5 mm² max. only when used with bridging comb

Viking 3 terminal blocks – screw connection

for copper cable (continued)

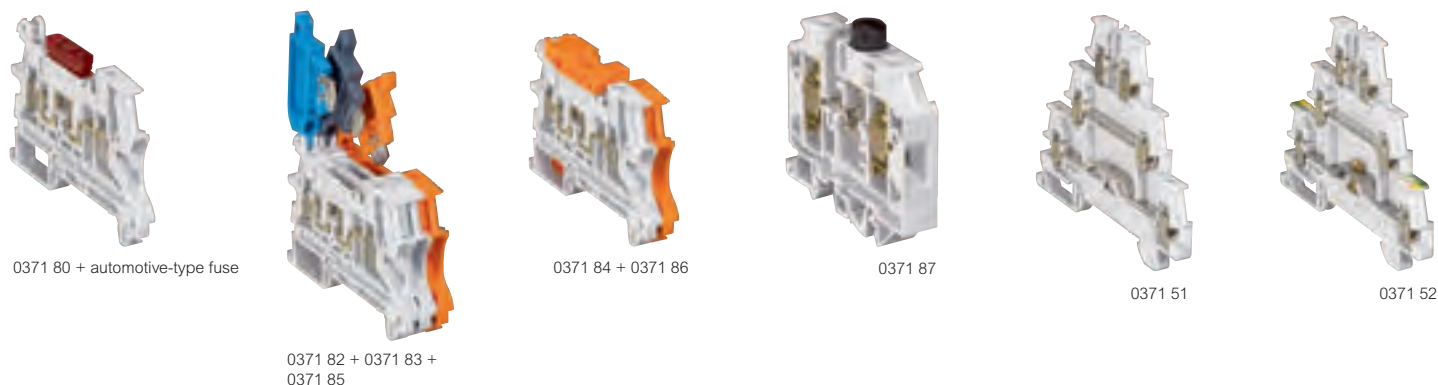

Accessories p. 126-127
 Technical characteristics p. 128-129

All V2 polyamide UL94 960 °C to IEC EN 60695-2-11
 Compatible with either rigid (0.25 mm² to 95 mm²) or flexible (0.25 mm² to 70 mm²) copper cables
 Facility for 2 bridging combs
 Compatible with rails depth 15 mm and rails EN 60715 depth 7.5 mm and 15 mm
 Range comprises only 2 block heights (2.5 mm² to 10 mm² and 16 mm² to 70 mm²) ensuring a neat installation

Pack	Cat. Nos.	Disconnection				
		1 connection				
		Disconnection by means of blade type lever, handle lever or mini lever (with tool)				
		Open (to be equipped)				
		Can take a blade-type automotive fuse or a miniature circuit breaker				
		Colour	Nominal cross section (mm ²)	Capacity		Width (mm)
				Rigid cable (mm ²)	Flexible cable (mm ²)	
20	0371 80	Grey ●	2.5	0.25 to 2.5	0.25 to 2.5	6
		For fuse cartridge 5 x 20 with handle lever				
20	0371 81	Grey ●	2.5	0.25 to 2.5	0.25 to 2.5	6
		For neutral circuit with blue handle lever				
20	0371 82	Grey/blue ●	2.5	0.25 to 2.5	0.25 to 2.5	6
		For standard circuit with handle lever				
20	0371 83	Grey ●	2.5	0.25 to 2.5	0.25 to 2.5	6
		For standard circuit with mini lever				
20	0371 84	Grey ●	2.5	0.25 to 2.5	0.25 to 2.5	6
		For circuit not broken with handle lever				
		Circuit not broken by the master isolating device				
20	0371 85	Orange ●	2.5	0.25 to 2.5	0.25 to 2.5	6
		For circuit not broken with mini lever				
		Circuit not broken by the master isolating device				
20	0371 86	Orange ●	2.5	0.25 to 2.5	0.25 to 2.5	6
		For cartridge 5 x 20 with screwed plug				
20	0371 87	Grey ●	10	0.25 to 16	0.25 to 10	12

Blown fuse indicators p. 127

Pack	Cat. Nos.	Blocks for sensors and actuators				
		For connecting sensors (Cat. No. 0371 51) or actuators (Cat. No. 0371 52), and their shared power supply unit when using equipotential bridging comb				
		Cat. Nos. 0375 46/47 (wiring diagram p. 127)				
		3 connections on 3 levels - for sensor				
		Colour	Nominal cross section (mm ²)	Capacity		Width (mm)
				Rigid cable (mm ²)	Flexible cable (mm ²)	
50	0371 51 ¹	Grey ●	2.5	0.25 to 4	0.25 to 2.5	5
		3 connections on 3 levels - for actuator				
		Green/yellow marking for the lower level				
		Metal base. Screwless fixing on rail				
50	0371 52 ¹	Grey ●	2.5	0.25 to 4	0.25 to 2.5	5

Accessories p. 126-127

End stops p. 126

CAB 3 marking system p. 140-142
 Starfix ferrules and crimping tools p. 148-149

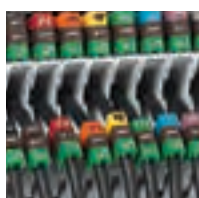

1 : Rigid cable capacity - 2.5 mm² max. only when used with bridging comb

Viking 3 terminal blocks – spring connection

for copper cable

		Product detail p. 124-125	TERMINAL TYPE		
0372 60 0372 61 0372 64 0372 40 0372 69 0372 68 0372 02 0372 47 0372 21 0372 42	Connection p. 124	1 connection - 1 entry/1 exit			
		1 connection - 1 entry/2 exits			
		1 connection - 2 entries/2 exits			
		2 connections - 2 levels			
		0372 70 0372 71 0372 72 0372 12	Protection p. 124	1 connection - 1 entry/1 exit - metal base	
1 connection - 1 entry/2 exits - metal base					
1 connection - 2 entries/2 exits - metal base					
0372 80 0372 82 0372 83 0372 84	Disconnection p. 125	1 connection	Open (to be equipped)		
			For fuse cartridge 5 x 20 with handle lever		
			For fuse cartridge 5 x 20 with handle lever + blown fuse indicator		
			For neutral circuit with handle lever		
			For standard circuit	With handle lever With mini lever	
			For circuit not broken	With handle lever With mini lever	
0372 54	Function blocks p. 125	1 connection - 2 entries/2 exits	Diode carrier 1N4007		
		2 connections - 2 entries	Diode carrier 1N4007		
			With voltage presence LED		

1 : Blown fuse indicator 12/24/48V~ /~ Cat. No. 0375 24 or 110/250V~ Cat. No. 0375 25 (p. 127)
 2 : Lower level only
 3 : Upper level only

accessories

for Viking 3 terminal blocks - spring connection

TERMINAL BLOCK				INSULATION		BRIDGING COMBS			MEASUREMENT	ASSOCIATED PRODUCTS						
Nominal cross section (mm ²)	Width (mm)	Colour	Cat. Nos.	End cap	Separation and insulation divider	Comb for 2 blocks	Comb for 3 blocks	Comb for 10 blocks	Test meter adaptor							
4	5		0372 60	0375 86	0375 95	0375 02	-	0375 01	0375 27	<p>End stops p. 126</p>						
			0372 00													
			0372 20													
	6		0372 61								built-in	0375 95	0375 05	-	0375 04	0375 27
			0372 01													
			0372 21													
6	8		0372 62	built-in	-	-	0375 07	-	0375 27	<p>Label holder for end stop p. 126</p>						
			0372 02													
10	10		0372 63	built-in	-	0375 82	-	-	-							
			0372 03													
16	12		0372 64	built-in	-	0375 85	-	-	-							
			0372 04													
4	5		0372 40	0375 87	0375 95	0375 02	-	0375 01	0375 27	<p>End caps p. 126</p>						
			0372 41													
			0372 42													
4	6		0372 43	built-in	0375 95	0375 05	-	0375 04	0375 27							
			0372 44													
4	5		0372 46	0375 88	0375 95	0375 02	-	0375 01	0375 27							
			0372 47													
4	6		0372 69	built-in	-	0375 05	-	0375 04	0375 27							
			0372 09													
4	5		0372 67	0375 89	0375 96	0375 02	-	0375 01	0375 27 ³	<p>Dividers p. 126</p>						
			0372 07													
4	6		0372 68	built-in	0375 96	0375 05	-	0375 04	0375 27 ³							
			0372 08													
4	5		0372 70	0375 86	-	-	-	-	-	<p>Blown fuse indicators p. 127</p>						
			0372 71													
			0372 72													
			0372 73													
			0372 74													
4	5		0372 10	0375 87	-	-	-	-	-							
			0372 11													
			0372 12													
			0372 79													
2-5	6		0372 80	0375 90	-	0375 05	-	0375 04	0375 27	<p>Shielding p. 127</p>						
			0372 81													
			0372 81 + 0375 24/25 ¹													
			0372 82													
			0372 83													
			0372 84													
			0372 85													
			0372 86													
			0375 90								-	0375 05	-	0375 04	0375 27	
			0375 90								-	0375 05	-	0375 04	-	
	0375 90	-	0375 05	-	0375 04	0375 27										
4	5		0372 54	0375 88	0375 95	0375 02	-	0375 01	-	<p>Starfix ferrules p. 148</p>						
			0372 55													
			0372 56													
			0375 89	0375 96	0375 02	-	0375 01	-								
			0375 89	0375 96	0375 02 ²	-	0375 01 ²	-								

Viking 3 terminal blocks – spring connection

for copper cable



0372 60 + 0372 00 + 0372 20



0372 01



0372 21



0372 63



0372 40



Automatic insertion of stripped cable with ferrule cap or rigid cable up to width of 6 mm

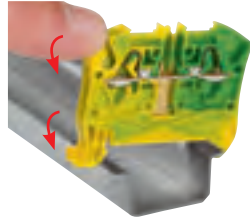

0372 70 Automatic fixing on rail

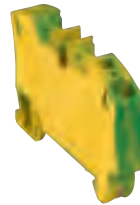

0372 72

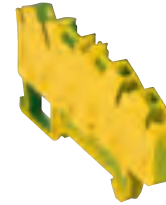

0372 79

Accessories **p. 126-127**
 Technical characteristics **p. 130-131**

Screwless connection system, stainless steel spring type
 Compatible with either 2 rigid copper cables or flexible cables (0.5 mm² - 16 mm²) with or without ferrules (p. 148)
 Direct tool-free insertion of a rigid cable. Direct tool-free insertion of a flexible cable with ferrule, up to 6 mm width
 Facility for 2 bridging combs
 Compatible with rails EN 60715 depth 7.5 mm and 15 mm

Pack	Cat. Nos.	Connection					
		Grey for standard circuit Blue for neutral conductor Orange for circuit not broken by the master isolating device					
		1 connection - 2 cables - 1 entry/1 exit					
		Colour	Nominal cross section (mm ²)	Rigid cable (mm ²)	Capacity Flexible cable (mm ²)	Flexible cable with ferrule (mm ²)	Width (mm)
60	0372 60	Grey ●	4	0.5 to 6	0.5 to 4	0.5 to 2.5	5
60	0372 00	Blue ●					
60	0372 20	Orange ●					
50	0372 61'	Grey ●	4	0.5 to 6	0.5 to 4	0.5 to 4	6
50	0372 01'	Blue ●					
50	0372 21'	Orange ●					
50	0372 62'	Grey ●	6	0.5 to 6	0.5 to 6	0.5 to 6	8
50	0372 02'	Blue ●					
40	0372 63'	Grey ●	10	0.75 to 10	0.75 to 10	0.75 to 10	10
40	0372 03'	Blue ●					
10	0372 64'	Grey ●	16	4 to 16	4 to 16	4 to 16	12
10	0372 04'	Blue ●					
		1 connection - 3 cables - 1 entry/2 exits					
60	0372 40	Grey ●	4	0.5 to 6	0.5 to 4	0.5 to 2.5	5
60	0372 41	Blue ●					
60	0372 42	Orange ●					
50	0372 43'	Grey ●	4	0.5 to 6	0.5 to 4	0.5 to 4	6
50	0372 44'	Blue ●					
		1 connection - 4 cables - 2 entries/2 exits					
60	0372 46	Grey ●	4	0.5 to 6	0.5 to 4	0.5 to 2.5	5
60	0372 47	Blue ●					
50	0372 69'	Grey ●	4	0.5 to 6	0.5 to 4	0.5 to 4	6
50	0372 09'	Blue ●					
		2 connections - 4 cables - 2 levels					
60	0372 67	Grey ●	4	0.5 to 6	0.5 to 4	0.5 to 2.5	5
60	0372 07	Blue ●					
50	0372 68'	Grey ●	4	0.5 to 6	0.5 to 4	0.5 to 4	6
50	0372 08'	Blue ●					

Pack	Cat. Nos.	Protection					
		Metal base Screwless fixing on rail PEN from 10 mm ²					
		1 connection - 2 cables - 1 entry/1 exit					
		Colour	Nominal cross section (mm ²)	Rigid cable (mm ²)	Capacity Flexible cable (mm ²)	Flexible cable with ferrule (mm ²)	Width (mm)
60	0372 70	Green/yellow ●	4	0.5 to 6	0.5 to 4	0.5 to 2.5	5
50	0372 71'	Green/yellow ●					
25	0372 72'	Green/yellow ●	6	0.5 to 6	0.5 to 6	0.5 to 6	8
20	0372 73'	Green/yellow ●					
15	0372 74'	Green/yellow ●	16	4 to 16	4 to 16	4 to 16	12
		Green/yellow ●					
		1 connection - 3 cables - 1 entry/2 exits					
40	0372 10	Green/yellow ●	4	0.5 to 6	0.5 to 4	0.5 to 2.5	5
30	0372 11'	Green/yellow ●					
		1 connection - 4 cables - 2 entries/2 exits					
40	0372 12	Green/yellow ●	4	0.5 to 6	0.5 to 4	0.5 to 2.5	5
30	0372 79'	Green/yellow ●					

CAB 3 marking system **p. 140-142**
 Starfix ferrules and crimping tools **p. 148-149**



1 : Built-in end cap

Viking 3 terminal blocks – spring connection

for copper cable (continued)

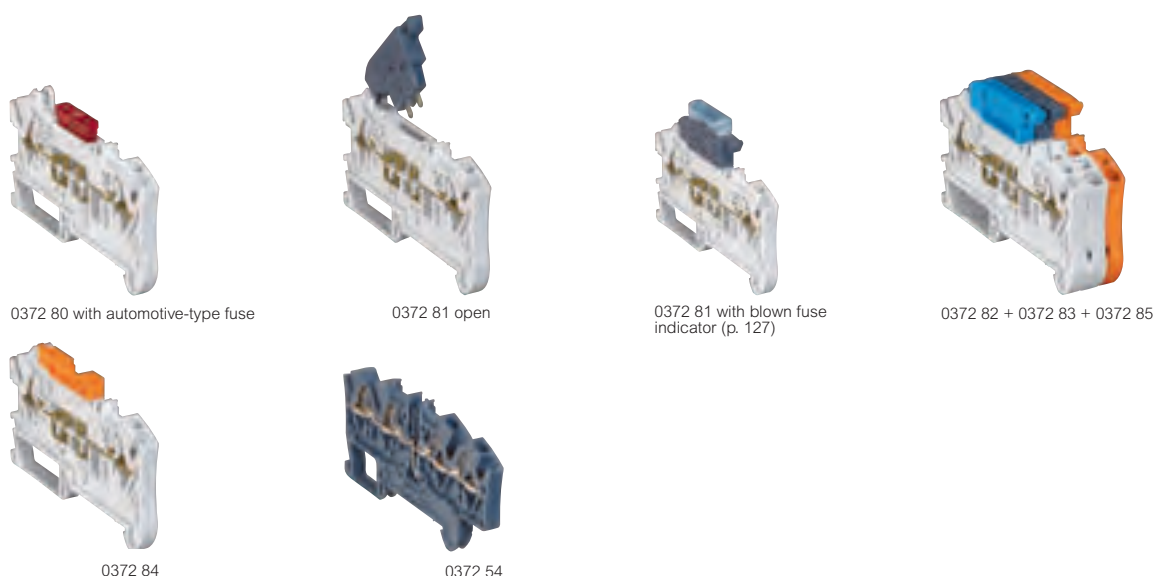

Accessories **p. 126-127**
 Technical characteristics **p. 130-131**

Screwless connection system, stainless steel spring type
 Compatible with either 2 rigid copper cables or flexible cables (0.5 mm² - 16 mm²) with or without ferrules (p. 148)
 Direct tool-free insertion of a rigid cable. Direct tool-free insertion of a flexible cable with ferrule, up to 6 mm width
 Facility for 2 bridging combs
 Compatible with rails EN 60715 depth 7.5 mm and 15 mm

Pack	Cat. Nos.	Disconnection					
		1 connection - 2 cables					
		Disconnection by means of blade type lever, handle lever or mini lever (with tool)					
		Open (to be equipped)					
		Can take a blade-type automotive fuse or a miniature circuit breaker					
		Colour	Nominal cross section (mm ²)	Rigid cable (mm ²)	Capacity Flexible cable (mm ²)	Flexible cable with ferrule (mm ²)	Width (mm)
20	0372 80	Grey ●	2.5	0.5 to 2.5	0.5 to 2.5	0.5 to 2.5	6
20	0372 81	Grey ●	2.5	0.5 to 2.5	0.5 to 2.5	0.5 to 2.5	6
20	0372 82	Grey/blue ●	2.5	0.5 to 2.5	0.5 to 2.5	0.5 to 2.5	6
20	0372 83	Grey ●	2.5	0.5 to 2.5	0.5 to 2.5	0.5 to 2.5	6
20	0372 84	Grey ●	2.5	0.5 to 2.5	0.5 to 2.5	0.5 to 2.5	6
20	0372 85	Orange ●	2.5	0.5 to 2.5	0.5 to 2.5	0.5 to 2.5	6
20	0372 86	Orange ●	2.5	0.5 to 2.5	0.5 to 2.5	0.5 to 2.5	6

Blown fuse indicators p. 127

Pack	Cat. Nos.	Function blocks					
		1 connection - 4 cables - 2 entries/2 outlets - diode-carrier					
		Colour	Nominal cross section (mm ²)	Rigid cable (mm ²)	Capacity Flexible cable (mm ²)	Flexible cable with ferrule (mm ²)	Width (mm)
60	0372 54	Grey ●	4	0.5 to 6	0.5 to 4	0.5 to 2.5	5
60	0372 55	Grey ●	4	0.5 to 6	0.5 to 4	0.5 to 2.5	5
60	0372 56	Grey ●	4	0.5 to 6	0.5 to 4	0.5 to 2.5	5

Accessories p. 126-127

End stops p. 126

CAB 3 marking system **p. 140-142**
 Starfix ferrules and crimping tools **p. 148-149**



Viking 3 accessories for terminal blocks

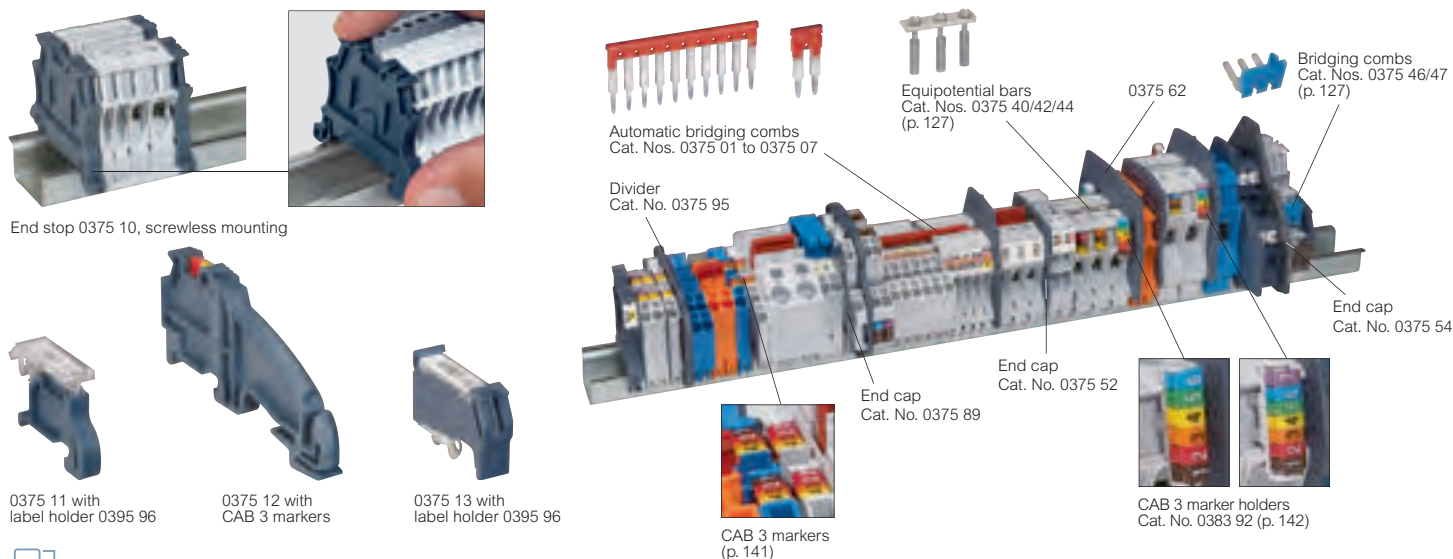

Technical characteristics p. 131

Pack	Cat. Nos.	Rails
10	0374 04	Length 2 m
10	0374 07	EN 60715 depth 7.5 mm
		depth 15 mm
10	0394 49	45° mounting bracket Set of 2 supports for tilting a rail at an angle of 45° Supplied with 4 x M6 screws, nuts and washers
50	0375 10	End stops Grey Compatible with CAB 3 marking system 6 mm width Screwless mounting For rails EN 60715 depth 15 mm and EN 60715 depth 7.5 mm and 15 mm Accepts label holder Cat. No. 0395 96 Acts as end cap for screw terminal blocks 1 entry/1 exit 5, 6, 8 and 10 mm width
20	0375 11	8 mm width For rails EN 60715 depth 15 mm and EN 60715 depth 7.5 mm and 15 mm Accepts label holder Cat. No. 0395 96
10	0375 12	10 mm width For rails EN 60715 depth 15 mm and EN 60715 depth 7.5 mm (except for rail fixed on plate) and 15 mm - IP 2X terminal block with flat steel bar 12 x 2 mm Cat. No. 0048 19 (p. 42) - Copper bar 12 x 4 mm Cat. No. 0373 89 (p. 45) - Shielding bar 10 x 3 mm Cat. No. 0375 34 (p. 127)
20	0375 13	12 mm width For rails EN 60715, EN 60715 depth 15 mm and EN 60715 depth 7.5 mm and 15 mm
20	0395 96	Identification accessories Transparent label holder With variable angle Fixing on end stops Cat. Nos. 0375 10/11 Supplied with label 32 x 9.5 mm Compatible with label Cat. No. 0395 97
20	0395 97	Label For engraving 28 x 9.5 mm For label holder Cat. No. 0395 96. Flexible ABS White background, black engraving
10	0395 98	Black felt tip pen For permanent marking

CAB 3® marking system p. 140-142

Pack	Cat. Nos.	End caps
		Grey
100	0375 50	For screw terminal blocks 1 entry/1 exit 5, 6, 8 and 10 mm width
20	0375 51	1 entry/1 exit 12 and 15 mm width
20	0375 52	2 entries/2 exits
20	0375 53	2 levels
20	0375 54	3 levels
20	0375 55	Disconnection terminal 6 mm width and function blocks 5 mm width
20	0375 56	Disconnection terminal fuse cartridge 5 x 20 with screwed plug
10	0375 57	Disconnection for measurement
50	0375 86	For spring terminal blocks with 5 mm width 5 mm pitch block becomes 6 mm pitch with end cap fitted Permits termination of a 4 mm ² cable complete with ferrule 1 entry/1 exit
50	0375 87	1 entry/2 exits
20	0375 88	2 entries/2 exits
20	0375 89	2 levels
20	0375 90	For spring terminal blocks with 6 mm width Disconnection type
		Separation and insulation dividers Grey
20	0375 60	For screw terminal blocks 1 entry/1 exit 5, 6, 8 and 10 mm width
10	0375 61	1 entry/1 exit 12 and 15 mm width
10	0375 62	2 entry/2 exits and disconnection 6 mm width blocks
10	0375 63	2 levels
10	0375 95	For spring terminal blocks 1 entry/1 exit, 1 entry/2 exits and 2 entry/2 exits 5 and 6 mm width
10	0375 96	2 levels
		Bridging accessories Bridging combs for screw and spring terminal blocks Front mounting (automatic insertion), screwless Isolated and separable. Consecutive or alternating connection. Red
20	0375 01 ¹	For 10 blocks with 5 mm width
50	0375 02 ¹	For 2 blocks with 5 mm width
20	0375 04 ¹	For 10 blocks with 6 mm width
50	0375 05 ¹	For 2 blocks with 6 mm width
20	0375 07 ¹	For 3 blocks with 8 mm width

1 : Blocks Cat. Nos. 0371 51/52 : upper level only
Block Cat. No. 0372 56 : lower level only

Viking 3 accessories for terminal blocks (continued)



0372 81 (p. 125) + 0375 24

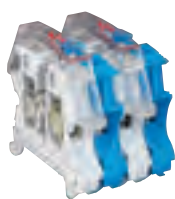

0371 63/0371 03 (p. 120) + 0375 66



0371 61 (p. 120) + 0375 27

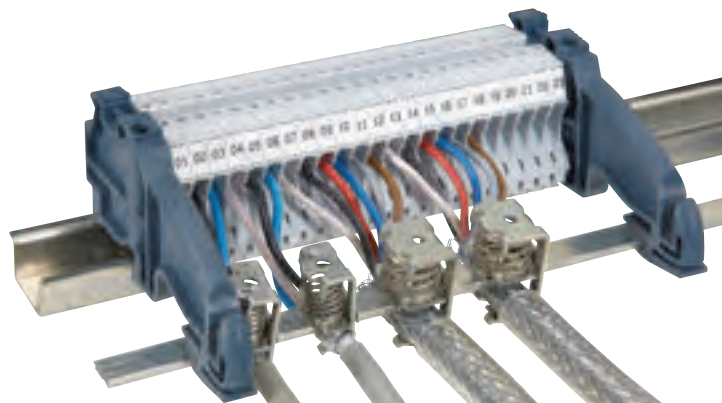

Shielding terminal block with end stops Cat. No. 0375 12 (p. 126), shielding bar Cat. No. 0375 34 and clamps Cat. Nos. 0375 30/31

Technical characteristics p. 131

Pack	Cat. Nos.	Bridging accessories (continued)
		Bars for screw terminal blocks Front mounting with screws. Pre-assembled Consecutive or alternating connection
10	0375 40	For 12 blocks with 10 mm width
10	0375 42 ¹	For 12 blocks with 12 mm width
10	0375 44	For 12 blocks with 15 mm width
		Bridging combs for 3-level screw terminal blocks For lower and intermediate levels of blocks Cat. Nos. 0371 51/52 (p. 121). Side mounting Isolated and separable
10	0375 46	Brown. For 12 blocks with 5 mm width
10	0375 47	Blue. For 12 blocks with 5 mm width
		Bridging combs for spring terminal blocks Front mounting (automatic insertion), screwless Isolated. Red
20	0375 82	For 2 blocks with 10 mm width
20	0375 85	For 2 blocks with 12 mm width
		Accessories for disconnection blocks For screw and spring terminal blocks
		Blown fuse indicators Clip directly on to blocks Cat. Nos. 0371 81 (p. 120) or 0372 81 (p. 121)
50	0375 24	12/24/48 V _~ / \sim for block with fuse cartridge 5 x 20 with handle lever
50	0375 25	110/250 V _~ for block with fuse cartridge 5 x 20 with handle lever

Pack	Cat. Nos.	Shielding accessories
		Ensure safe, simple connection of cable shielding
		Shielding clamps For screw and spring terminal blocks - mounted by pivoting on collector bar 10 x 3 mm Cat. No. 0375 34 - mounted on plate with M4 screws (supplied) - mounted on rail with Cat. No. 0364 69 (p. 26)
10	0375 30	For cable diameter 3 to 8 mm
10	0375 31	For cable diameter 4 to 13.5 mm
4	0375 32	For cable diameter 10 to 20 mm
		Shielding bar For screw and spring terminal blocks. Steel. Length 1 m For use with end stop Cat. No. 0375 12 (p. 126) 10 x 3 mm
10	0375 34	
50	0375 35	Screening continuity bracket For screw terminal blocks 1 entry/1 exit 5, 6, 8 and 10 mm width Connected with 2.8 x 0.8 mm clips or welded on. Capacity : 1 mm ²
		Protective screens
		1 pole For screw terminal blocks 1 entry/1 exit
10	0375 65	5 and 6 mm width
10	0375 66	8 and 10 mm width
10	0375 67	12 and 15 mm width
		Cut to length Length 1 m Mounted on separation and insulation divider For screw terminal blocks 1 entry/1 exit
10	0375 68	5, 6, 8 and 10 mm width (divider Cat. No. 0375 60, p. 126)
10	0375 69	12 and 15 mm width (divider Cat. No. 0375 61, p. 126)
		Test meter adaptor
10	0375 27 ²	For screw and spring terminal blocks Measurement socket for Ø4 mm plug for blocks with 5 and 6 mm width

1 : Except for Cat. No. 0371 87 (p. 121)

2 : Except for disconnection blocks with handle lever, screw terminal block with LED and spring function blocks. 2 and 3-level terminal blocks : upper level only

Viking 3 terminal blocks – screw connection

Characteristics and dimensions (mm)

V2 polyamide according to UL 94, 960 °C according to IEC EN 60695-2-11

Connection blocks

Cat. Nos.	Voltage (V)			Current (A)				Nominal cross section		
	IEC	CSA	UL	le	IEC	CSA	UL	IEC (mm ²)	CSA (AWG)	UL (AWG)
0371 00/20/30/60	800	600	600	27	24	20	20	2.5	12	12
0371 01/21/31/61				36	32	30	30	4	10	10
0371 02/62				48	41	50	50	6	8	8
0371 03/63				63	57	60	60	10	6	6
0371 04/64				85	76	85	85	16	4	4
0371 05/65				138	125	115	115	35	2	2
0371 07/67				27	24	20	20	2.5	12	12
0371 08/68				36	32	30	30	4	10	10
0371 09/69				36	32	30	30	4	10	10
0371 66				1000	600	600	213	192	200	200
0371 77	800	600	600	36	32	30	30	4	10	10
0371 78				48	41	50	50	6	8	8

Cat. No. 0371 51 : see blocks for sensors
IEC 60947-7-1, CSA no. 22-2 no. 158, UL 1059
le: Rated current NF C 15100 table 52H, column 4

Cat. Nos. 0371 00/01/
02/03/20/21/30/31/60/
61/62/63/77/78

Cat. Nos.
0371 04/05/64/65

Cat. No. 0371 66

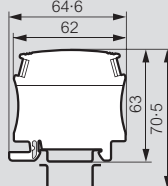
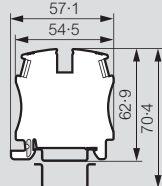
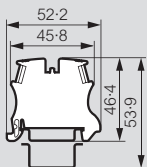

Cat. Nos. 0371 09/69

Cat. Nos. 0371 07/08/67/68

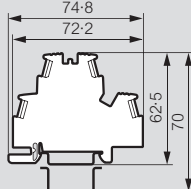
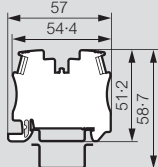

Approved by ATEX :
LCIE 07 ATEX 0010 U-0081 II 1 or 2 G or D Ex e/i/tD/iD II

The terminal blocks with screw connection covered by this certificate are 1-, 2- and 3-level connection terminal blocks, and protection blocks with metal¹ and plastic base (detailed list on p. 118)

The main characteristics are :
Operating temperature : -30 °C to +55 °C
Maximum temperature of materials : +85 °C

Working voltage acc. to EN 60079-7 : 1-level terminal blocks : 500 V
Blocks with 2 entries - 2 exits : 250 V
2 and 3-level terminal blocks : 250 V

Rated current:

Conductor cross section (mm ²)	2.5	4	6	10	16	35	70
Rated current (A)	18	23	30	42	57	93	144

Certificate of conformity of components is available on request

1 : Except for Cat. No. 0371 76

Protection blocks

Cat. Nos.	Voltage (V)			Nominal cross section					
	IEC	CSA	UL	IEC (mm ²)	CSA (AWG)	UL (AWG)			
0371 70	800	600	600	2.5	12	12			
0371 71				4	10	10			
0371 72				6	8	8			
0371 73 ¹				10	6	6			
0371 74 ¹				16	4	4			
0371 75 ¹				35	2	2			
0371 76				-	-	-	35	-	-
0371 77				800	600	600	4	10	10
0371 78				6	8	8	4	10	10
0371 79				500	300	300	4	10	10

IEC 60947-7-1/7-2, CSA no. 22-2 no. 158, UL 1059

1 : PEN terminal blocks

Cat. Nos.

0371 70/71/72/73

Cat. Nos. 0371 74/75

Cat. No. 0371 76

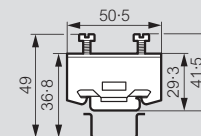
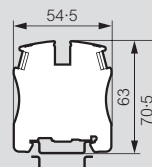
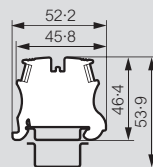

Cat. Nos. 0371 77/78

Cat. No. 0371 79

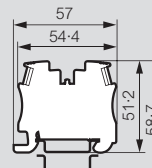
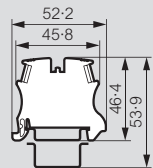

Disconnection blocks

Cat. Nos.	Voltage (V)			Current (A)			Nominal cross section		
	IEC	CSA	UL	IEC	CSA	UL	IEC (mm ²)	CSA (AWG)	UL (AWG)
0371 80	500	300	300	15	15	15	2.5	12	12
0371 81 or 0371 80 + 0375 15	250	250	250	6.3	6.3	6.3			
0371 82	500	300	300	15	15	15			
0371 83									
0371 84									
0371 85									
0371 86									
0371 87	250	250	250	10	10	10	10	10	

IEC 60947-7-1/7-3, CSA no. 22-2 no. 158, UL 1059

Power according to EN 60947-7-3

Cat. Nos.	Short-circuit		Short-circuit + overload	
	Separate blocks	Assembled blocks	Separate blocks	Assembled blocks
0371 81 or 0371 80	4 W / 6.3 A Pvk = 4.75 W	1.6 W/6.3 A Pvk = 2 W	1.6 W/6.3 A Pv = 1.65 W	-
0371 87	4 W Pvk = 5 W	2.5 W Pvk = 2.7 W	1.6 W Pv = 1.8 W	-

Cat. No. 0371 80

Cat. Nos. 0371 81/82/83/85

Cat. Nos. 0371 84/86

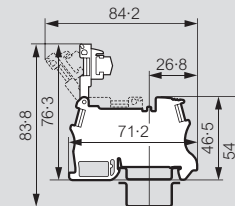
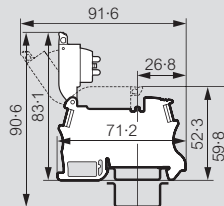
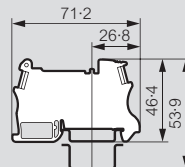

Cat. No. 0371 87

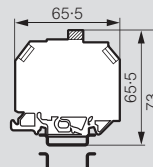

Blocks for sensors and actuators/PNE

Cat. Nos.	Voltage (V)			Current (A)			Nominal cross section			
	IEC	CSA	UL	Ie	IEC	CSA	UL	IEC (mm ²)	CSA (AWG)	UL (AWG)
0371 51 0371 52	400	300	300	27	24	20	20	2.5	12	12

IEC 60947-7-1/7-2, CSA no. 22-2 no. 158, UL 1059
Ie: Rated current NF C 15100 table 52H, column 4

Cat. Nos. 0371 51/52

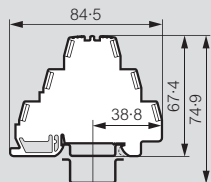

Wiring diagram

Block for sensor Cat. No. 0371 51

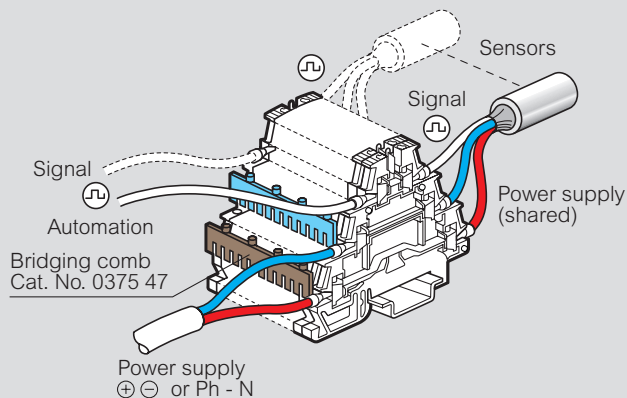

Block for actuator Cat. No. 0371 52

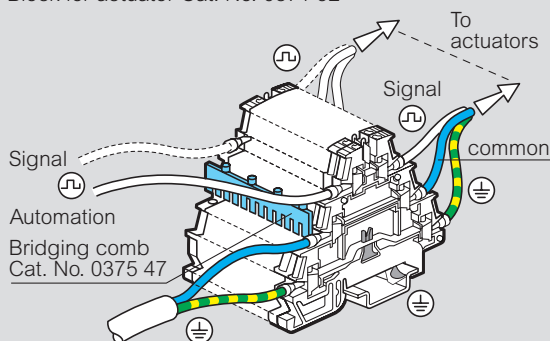

PNE block Cat. No. 0371 52

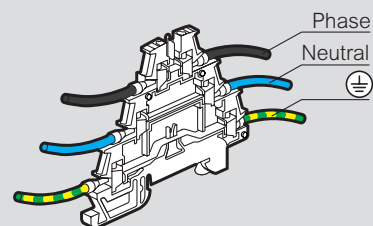

Stripped lengths (mm)

Screw terminal width (mm)	Rigid or flexible cable
5	
6	6 to 8
8	
10	10 to 12
12	13 to 17
15	14 to 18
22	15 to 22

Protection against fire and panic risks in public buildings/UTE C 12-201 guide

Art. EL 3, definitions : "Security installations are those that have to be put into or maintained in service to ensure the evacuation of the public" or facilitate the intervention of the first-aid

Art. EL 16, power supply circuits in security installations section 1a: "...the corresponding junction or deviation devices and their enclosures except for the waterproofing systems must satisfy the incandescent cable test defined in the standard in force, the temperature of the incandescent cable being 960 °C"
Viking 3 terminal blocks satisfy the incandescent cable test 960 °C according to standard IEC 60695-2-11

Viking 3 terminal blocks – spring connection

Characteristics and dimensions (mm)

V2 polyamide according to UL 94, 960 °C according to IEC EN 60695-2-11

Connection blocks

Cat. Nos.	Voltage (V)			Current (A)				Nominal cross section						
	IEC	CSA	UL	le	IEC	CSA	UL	IEC (mm ²)	CSA (AWG)	UL (AWG)				
0372 00	800	600	600	36	32	20	20	4	12	12				
0372 01				48	41	30	30	6	10	10				
0372 02				63	57	50	50	10	8	8				
0372 03				85	76	65	65	16	6	6				
0372 04				85	76	65	65	16	6	6				
0372 07	500	300	300	36	32	20	20	4	12	12				
0372 08											30	30	10	10
0372 09											30	30	10	10
0372 20											30	30	10	10
0372 21											30	30	10	10
0372 40	800	600	600	36	32	20	20	4	12	12				
0372 41											30	30	10	10
0372 42											30	30	10	10
0372 43											30	30	10	10
0372 44											30	30	10	10
0372 46											30	30	10	10
0372 47											30	30	10	10
0372 60											30	30	10	10
0372 61											30	30	10	10
0372 62											30	30	10	10
0372 63	30	30	10	10										
0372 64	500	300	300	36	32	30	30	4	10	10				
0372 67											30	30	10	10
0372 68											30	30	10	10
0372 69											30	30	10	10
0372 69											30	30	10	10

IEC 60947-7-1, CSA no. 22-2 no. 158, UL 1059
le: Rated current NF C 15100 table 52H, column 4

Protection blocks

Cat. Nos.	Voltage (V)			Nominal cross section		
	IEC	CSA	UL	IEC (mm ²)	CSA (AWG)	UL (AWG)
0372 10	800	600	600	4	10	10
0372 11						
0372 12						
0372 70						
0372 71						
0372 72						
0372 73 ¹						
0372 74 ¹						
0372 79						
0372 79						

IEC 60947-7-2, CSA no. 22-2 no. 158, UL 1059
1 : PEN terminal blocks

Function blocks

Cat. Nos.	Voltage (V)			Current (A)			Nominal cross section		
	IEC	CSA	UL	IEC	CSA	UL	IEC (mm ²)	CSA (AWG)	UL (AWG)
0372 54	500	300	300	1	1	1	4	14	14
0372 55				1	1	1			
0372 56				12 to 24	12 to 24	12 to 24			

IEC 60947-7-1, CSA no. 22-2 no. 158, UL 1059

Cat. Nos. 0372 00/01/
20/21/60/61/70/71

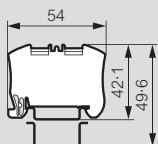

Cat. Nos. 0372 02/62/72

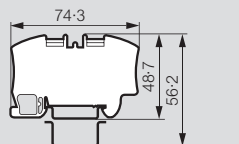
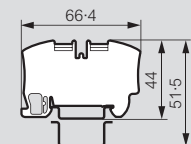

Cat. Nos. 0372 04/
64/74

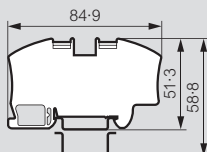

Cat. Nos. 0372 10/11/
40/41/42/43/44

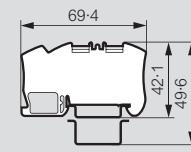

Cat. Nos. 0372 09/12/
46/47/54/69/79

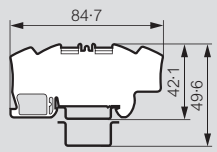

Cat. Nos. 0372 07/08/55/56/67/68

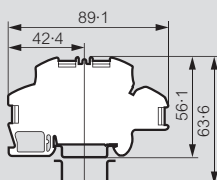

Function block schematic diagrams

Cat. No. 0372 54

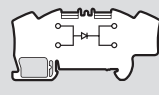

Cat. No. 0372 55

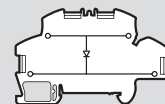

Cat. No. 0372 56

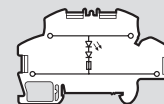

Diode for Cat. Nos. 0372 54/55
- 1N4007 type 1 A
- direct current = 1 A
- peak inverse voltage 1000 V
- inverse current 5 µA at 25 °C

Approved by ATEX :

LCIE 07 ATEX 0010 U-0081 II 1 or 2 G or D Ex e/i/tD/iD II

The terminal blocks with spring connection covered by this certificate are 1- and 2-level connection terminal blocks, and blocks for protection conductor with metal base (detailed list on p. 120)

The main characteristics are :

Operating temperature : -30 °C to +55 °C

Maximum temperature of materials : +85 °C

Working voltage acc. to EN 60079-7 : 1-level terminal blocks : 500 V
Blocks with 2 entries - 2 exits : 500 V
2-level terminal blocks : 250 V

Rated current:

Conductor cross section (mm ²)	4	6	10	16
Rated current (A)	23	30	42	57

Certificate of conformity of components is available on request

Disconnection blocks

Cat. Nos.	Voltage (V)			Current (A)			Nominal cross section		
	IEC	CSA	UL	IEC	CSA	UL	IEC (mm ²)	CSA (AWG)	UL (AWG)
0372 80	500	300	300	15	15	15	2.5	14	14
0372 81 or 0372 80	250	250	250	6.3	6.3	6.3			
0372 82	500	300	300	15	15	15			
0372 83									
0372 84									
0372 85									
0372 86	15	15	15	15	15	15			

IEC 60947-7-1/7-3, CSA no. 22-2 no. 158, UL 1059

Power according to EN 60947-7-3

Cat. Nos.	Short-circuit		Short-circuit + overload	
	Separate blocks	Assembled blocks	Separate blocks	Assembled blocks
0372 81 or 0372 80	4 W / 6.3 A	1.6 W / 6.3 A	1.6 W / 6.3 A	-
	P _{vk} = 4.75 W	P _{vk} = 2 W	P _v = 1.65 W	-

Cat. No. 0372 80

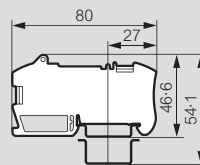

Cat. Nos. 0372 81/82/83/85

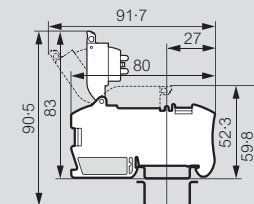

Cat. No. 0372 84/86

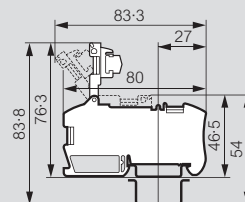

Viking 3 accessories for terminal blocks

Stripped lengths (mm)

Spring terminal width (mm)	Rigid or flexible cable
5	
6	8 to 12
8	
10	8 to 13
12	8 to 15

Protection against fire and panic risks in public buildings/UTE C 12-201 guide

Art. EL 3, definitions : "Security installations are those that have to be put into or maintained in service to ensure the evacuation of the public" or facilitate the intervention of the first-aid

Art. EL 16, power supply circuits in security installations section 1a: "...the corresponding junction or deviation devices and their enclosures except for the waterproofing systems must satisfy the incandescent cable test defined in the standard in force, the temperature of the incandescent cable being 960 °C"
Viking 3 terminal blocks satisfy the incandescent cable test 960 °C according to standard IEC 60695-2-11

■ Characteristics and dimensions (mm)

End stops

Cat. No. 0375 10

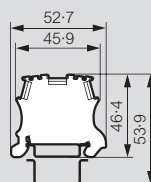

Cat. No. 0375 11

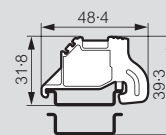

Cat. No. 0375 12

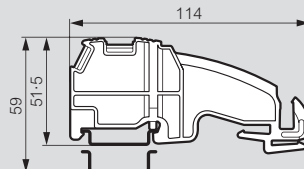

Cat. No. 0375 13

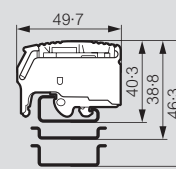

End caps

Cat. Nos.	Thickness (mm)
0375 50	2
0375 51	2.5
0375 52	2
0375 53	2
0375 54	2.5
0375 55	2
0375 56	1.4
0375 57	1.4
0375 86	1
0375 87	1.1
0375 88	1.1
0375 89	1.1
0375 90	2

Separation and insulation dividers

Cat. Nos.	Thickness (mm)
0375 54	2.5
0375 60	2.5
0375 61	2.6
0375 62	2.5
0375 63	2.5
0375 95	2.8
0375 96	2.7

Bridging combs/bars

Cat. Nos.	Cross-section (mm²)
0375 01	2.5
0375 02	2.5
0375 04	4
0375 05	4
0375 07	6
0375 40	10
0375 42	16
0375 44	35
0375 46	2.5
0375 47	2.5
0375 82	10
0375 85	16

Shielding accessories

Mounting on bar
10 x 3
Cat. No. 0375 34

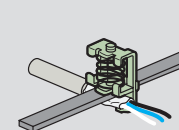

Mounting on rail
with accessory
Cat. No. 0364 69¹

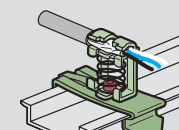

Mounting on plate

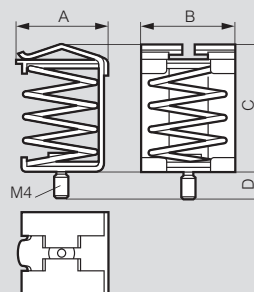
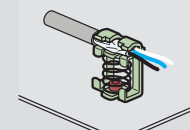

Cat. Nos.	A	B	C	D
0375 30	13.5	18	26	5.6
0375 31	20	20.3	31.4	5.3
0375 32	24.8	26	40	5.3

1 : See enclosures equipment and fixing accessories p. 26

Viking 3 heavy duty terminal blocks

selection chart

	TERMINAL TYPE		TERMINAL BLOCK				INSULATION Separation and insulation divider	BRIDGING COMB Shunt	PROTECTION		ASSOCIATED PRODUCTS CAB 3 marking system p. 140
			Max. connection (mm ²)	Width (mm)	Cat. Nos.				Cover 4 blocks	Cover 3 blocks	
					Rail	Rail					
 0390 11 0390 14 Heavy duty terminal blocks p. 133	Cable - cable	-	42	0390 10	-	-	0394 46	-	-		
			55	0390 11	-	-	0394 47	-	-		
	Cable lug - cable lug	-	36	0390 13	-	-	0394 46	-	-		
			42	0390 14	-	-	0394 46	-	-		
			55	0390 15	-	-	0394 47	-	-		
			42	0390 17	-	-	0394 46	-	-		
Cable lug - cable	-	42	0390 17	-	-	0394 46	-	-			
		55	0390 18	-	-	0394 47	-	-			
 0390 32 Heavy duty terminal blocks p. 134	For copper bars and cable lugs	-	35	26	0390 71	0390 31	0394 77	-	0394 88	-	
			70	34	0390 72	0390 32	0394 78	-	0394 86	-	
			120	34	0390 73	0390 33	0394 78	-	0394 86	-	
			240	46	0390 74	0390 34	0394 78	-	0394 89	0394 86	

CAB 3 marking system p. 140-142



Enclosures p. 14-23



Viking 3 heavy duty terminal blocks

for copper and aluminium cables

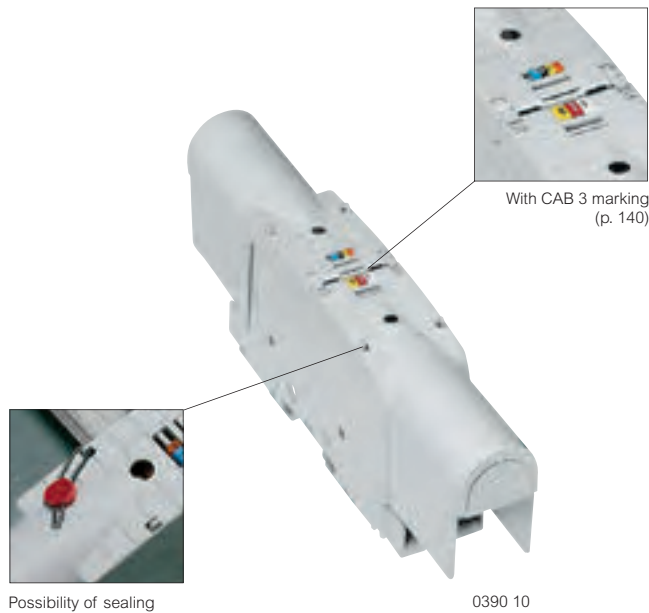

Possibility of sealing

0390 10

Technical characteristics p. 135

Pack	Cat. Nos.	Heavy duty terminal blocks		
		For copper and aluminium cables		
		IK 04 Conform to IEC 60947-7-1, EN 60947-7-1 UL 1059 and 486 E - CSA 22-2 Fire resistant IEC 60695-2-11 : 960°C (except cover) V2 according to UL 94 Bridging the gap between the enclosure and external cables Fixed using metal clip for rails 15 mm depth and EN 60715, 15 mm depth or on plate with screws Fitted with hinged covers with cut-outs Permits the use of CAB 3 markers Test via test plug Ø4 mm closed covers Blocks with identical width can be joined using a threaded rod Supports shunt with Cat. Nos. 0394 46/47		
5	0390 10	Cable - Cable Rigid or flexible connecting cable (mm ²) Al/Cu 35 to 120	Rigid or flexible connecting cable (mm ²) Cu 35 to 70	Width (mm) 42
5	0390 11	Al/Cu 70 to 300	Cu 70 to 150	55
		Cable lug - Cable lug		
5	0390 13	Connecting plate max. (mm ²) Al/Cu 95	Connecting plate max. (mm ²) Al/Cu 95	Width (mm) 36
5	0390 14	Al/Cu 150	Al/Cu 150	42
5	0390 15	Al/Cu 300	Al/Cu 300	55
		Cable lug - Cable		
5	0390 17	Connecting plate max. (mm ²) Al/Cu 150	Rigid or flexible connecting cable (mm ²) Cu 35 to 95	Width (mm) 42
5	0390 18	Al/Cu 300	Cu 70 to 150	55

Termination options

Cable - Cable



Cable lug - Cable lug



Cable lug - Cable



0390 11 (interior view)

Pack	Cat. Nos.	Accessories
		Shunt
5	0394 46	For blocks with width 36 and 42 mm
5	0394 47	For blocks with width 55 mm

DIN rails p. 126



Viking 3 heavy duty terminal blocks

for copper bars and cable lugs



0390 32



0394 78 + 86

Technical characteristics p. 135

Pack	Cat. Nos.	Heavy duty terminal blocks			
		For copper bars or cable lugs			
		Conform to IEC EN 60947-7-1			
		Fire resistance : 960 °C, IEC EN 60695-2-11 V2 according to UL94			
		Insulating material : polyamide -30 °C to +100 °C			
		Bridging the gap between the enclosure and external cables			
		Plastic foot			
		For use with terminal marker sheets (p. 140)			
		Separation barriers and protective covers to be ordered separately			
		For symmetrical rails			
		Fixed using metal clip on rails 15 mm depth and EN 60715, 15 mm depth (p. 126)			
		Connecting max. (mm ²)	Width of plate (mm)	Stud (∅)	Width (mm)
5	0390 71	35	15	M 8	26
5	0390 72	70	20	M 10	34
5	0390 73	120	25	M 10	34
5	0390 74	240	35	M 12	46
		For asymmetrical rails			
		Fixed using metal clip on rails EN 60715 (p. 26)			
5	0390 31	35	15	M 8	26
5	0390 32	70	20	M 10	34
5	0390 33	120	25	M 10	34
5	0390 34	240	35	M 12	46

Pack	Cat. Nos.	Accessories	
		Separation barriers	
		Take protective covers	
		Marking possible with CAB 3 marking system (p. 140)	
10	0394 77	For terminals with width 26 mm	
10	0394 78	For terminals with width 34 and 46 mm	
		Protective covers	
		For mounting on separation barriers	
5	0394 86	For 3 terminals with width 46 mm or for 4 terminals with width 34 mm	
5	0394 88	For 4 terminals with width 26 mm	
5	0394 89	For 4 terminals with width 46 mm	



End stops p. 126

CAB 3 marking system p. 140-142



Enclosures p. 14-23



Viking 3 heavy duty terminal blocks

■ Characteristics of heavy duty terminal blocks for copper and aluminium cables

IK 04
 Conform to IEC 60947-7-1, EN 60947-7-1
 UL 1059 and 486 E - CSA 22-2
 Fire resistant IEC 60695-2-11 : 960 °C (except cover)
 V2 according to UL 94
 Insulation voltage U_i : 1000 V
 Impulse voltage U_{imp} : 12 kV
 Insulating material :
 - polyamide body -30 °C to +100 °C
 - polypropylene cover -25 °C to +100 °C

Connection table

Cat. Nos.	Connection (mm ²)	Width of plate (mm)	Screw \varnothing	Connection (mm ²)	Width of plate (mm)	Screw \varnothing	Width (mm)
Cable - Cable							
0390 10	Rigid or flexible Cu/Al: 35 to 120	-	-	Rigid or flexible Cu: 35 to 70	-	-	42
0390 11	Rigid or flexible Cu/Al: 70 to 300	-	-	Rigid or flexible Cu: 70 to 150	-	-	55
Cable lug - Cable lug							
0390 13	Cu/Al: max. 95	28	M 8	Cu/Al: max. 95	28	M 8	36
0390 14	Cu/Al: max. 150	34	M 10	Cu/Al: max. 150	34	M 10	42
0390 15	Cu/Al: max. 300	46	M 12	Cu/Al: max. 300	46	M 12	55
Cable lug - Cable							
0390 17	Cu/Al: max. 150	34	M 10	Rigid or flexible Cu: 35 to 95	-	-	42
0390 18	Cu/Al: max. 300	46	M 12	Rigid or flexible Cu: 70 to 150	-	-	55

Cable - Cable



Cable lug - Cable lug



Cable lug - Cable

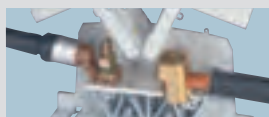

Currents table

Cat. Nos.	Current (A)				Short-circuit current (kA)		Tightening torque (Nm)		Width (mm)
	Shunted input		I/O currents		Shunted input	I/O	Site	Factory	
	IEC	IEC	CSA	UL					
Cable - Cable									
0390 10	340	250	200	170	14.4	8.4	15	15	42
0390 11	570	400	300	285	36	18	35	35	55
Terminal for cable lug - Terminal for cable lug									
0390 13	310	310	250	230	11.4	11.4	15	15	36
0390 14	415	415	340	285	18	18	15	15	42
0390 15	670	670	520	420	36	36	35	35	55
Terminal for cable lug - Cable									
0390 17	415	315	210	230	18	11.4	15	15	42
0390 18	670	420	325	285	36	18	35	35	55
Shunts									
0394 46	450 max.	-	-	-	-	-	6	-	-
0394 47	700 max.	-	-	-	-	-	10	-	-

Cable section equivalence table

mm ²	35	70	95	120	150	185	300
AWG	2	00	0000	250	300	350	600

Dimensions (mm)

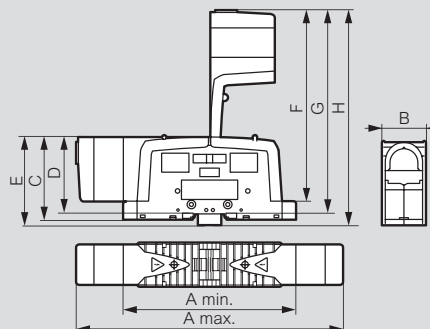

Cat. Nos.	A max.	A min.	B	C	D	E	F	G	H
0390 13	227	155	36	82	73	88	176	185	191
0390 10/14/17	296	200	42	83.5	74.5	89.5	212	221	227
0390 11/15/18	337	216	55	107.3	98.5	113.5	257	266	272

■ Characteristics of heavy duty plate terminal blocks for copper bars or cable lugs

IEC EN 60947-7-1
 Fire resistance :
 960 °C, IEC EN 60695-2-11
 V2 according to UL 94
 Insulating material :
 polyamide -30 °C to +100 °C

Cat. Nos.	Voltage (V) IEC	Intensity (A) IEC
0390 31/71	1000	125
0390 32/72	1000	192
0390 33/73	1000	269
0390 34/74	1000	415

Dimensions (mm)

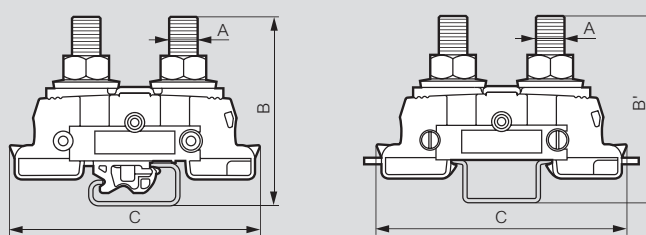

Cat. Nos. 0390 31/32/33/34

Cat. Nos. 0390 71/72/73/74

Cat. Nos.	A	B	B'	C
0390 31	M 8	56		84
0390 32	M 10	61		84
0390 33 ¹	M 10	61		84
0390 34 ²	M 12	64		86
0390 71	M 8		55.3	84
0390 72	M 10		60.4	84
0390 73	M 10		60.4	84
0390 74	M 12		63.5	86

■ Separation barriers

Dimensions (mm)

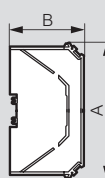

Cat. Nos. 0394 77/78

Cat. Nos.	A	B	Thickness
0394 77	106	82	8
0394 78	188	102	12

1 : Previously M 12 + block length 78.5 mm
 2 : Previously M 16 + block length 94 mm



CABLE MARKING SYSTEMS AND CABLE ACCESSORIES

Marking systems



P. 140
Marking label sheets

Cable ties



P. 144
Cable tie specification guide

Starfix®



P. 148
Starfix ferrules



P. 140
CAB 3
marking system



P. 142
CAB 3
marking system
accessories



P. 143
Technical
information



P. 145
Colring
cable ties



P. 145
Colson
cable ties



P. 146
Colring
cable ties
technical
information



P. 147
Colson
cable ties
technical
information

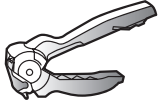

P. 148
Crimping tools for
Starfix ferrules



P. 149
Applicators
for Starfix
crimping tools



P. 149
Starfix
technical
information

Completing the

Create reliable connections which are clearly marked and secured with Legrand's range of cabling accessories. From Starfix tools and ferrules to CAB 3 marking systems and Colson and Colring cable ties, we've got everything you need to complete your installation to the highest standard.

Starfix crimping tools - available in 3 sizes for cables from 0.25 to 6mm²



Fit the applicator



Adjust cable size



Insert cable and crimp

Starfix multi-purpose crimping tool - for cables from 0.5mm to 2.5mm²



Adjust cross section

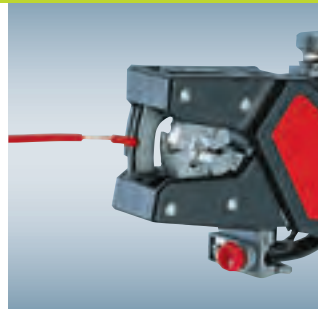

Cut, strip and twist



Crimp

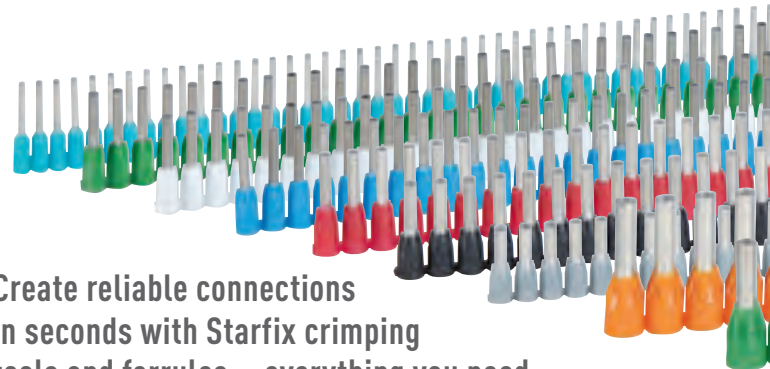

Create reliable connections in seconds with Starfix crimping tools and ferrules... everything you need for 0.25 to 50mm² cables.

perfect installation

Colring® cable ties

Colring polyamide 6/6 cable ties feature internal teeth and are available in black UV protected and colourless non UV protected options.

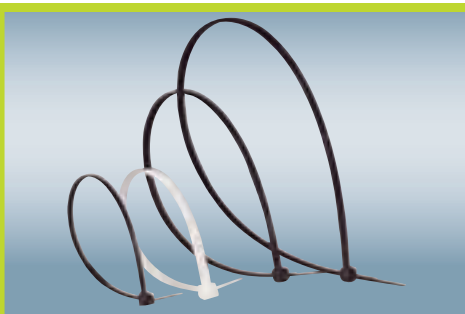

Tool available for tightening and trimming of Colring cable ties

Self-adhesive and screw mounting bases available

Colson® cable ties

Colson polyamide 12 (halogen-free, low fire hazard) cable ties feature external teeth and offer UV, high level acid and chemical protection.



Tool available for tightening and trimming of Colson cable ties

Screw mounting and wall plug bases available

Making your mark

CAB 3 offers a high quality solution to multiple cable and terminal marking requirements. Universal fittings enable clear, rapid marking and simple modification.

- Sizes range from 0.15 to 6mm²
- Numbers, letters, conventional symbols and international marker colours available
- Supplied in strips - easier to handle / less wastage
- For Viking 3, heavy duty terminal blocks - or fit directly to cables (retrofit possible)
- Mixed marker sets available



Markers can be fitted directly onto cables or via a marker holder

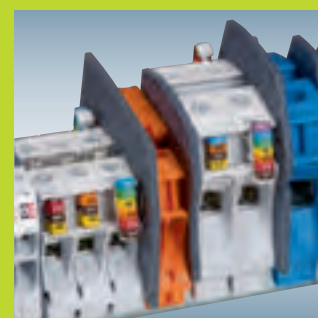

Terminal block installation with CAB 3 markers

marking label sheets

for Viking 3 terminal blocks

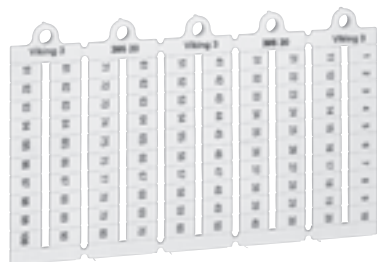

0395 20



0395 98

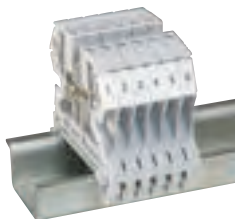

0395 05 on Viking 3 terminal blocks

CAB 3[®] marking system

for cables and Viking 3 terminal blocks

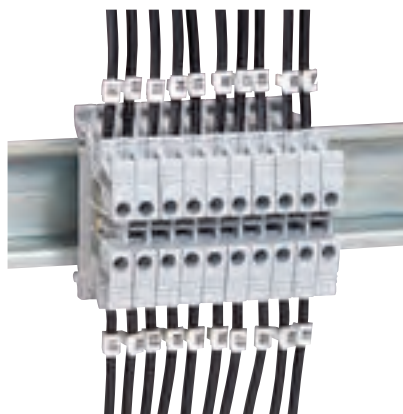

Same markers for cable and terminal blocks

Strips of 20 markers
For cables or Viking 3 terminal blocks

Technical information p. 143

Pack	Cat. Nos.	Blank markers
1000	0395 00	Displayed by sheet of 100 pre-cut markers
1000	0395 01	Manual marking with black felt tip pen Cat. No. 0395 98
1000	0395 02	For blocks 5 mm width
		For blocks 6 mm width
		For blocks 8 mm width

Pre-printed markers – numbers

Horizontal format		
Width of 5 mm		
1000	0395 05	From 1 to 10 (10 times)
1000	0395 06	From 11 to 20 (10 times)
1000	0395 09	From 1 to 50 (2 times)
1000	0395 10	From 1 to 100
Width of 6 mm		
1000	0395 15	From 1 to 10 (10 times)
1000	0395 16	From 11 to 20 (10 times)
1000	0395 19	From 1 to 50 (2 times)
1000	0395 20	From 1 to 100
1000	0395 21	From 101 to 200

Black felt tip pen

10	0395 98	Permanent marker
----	---------	------------------

Pack	Cat. Nos.	Markers for cables 1.5 to 2.5 mm ² cross section and terminal blocks
		Numbers : black on white background
240	0381 60	01 to 20
240	0381 61	21 to 40
240	0381 62	41 to 60
240	0381 63	61 to 80

Viking 3 terminal blocks
p. 118-135



CAB 3® marking system

for cables and Viking 3 terminal blocks (continued)



Perfect alignment of markers



0382 12

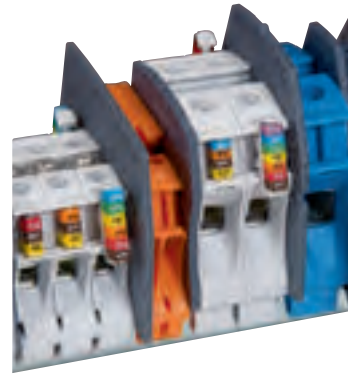

Terminal blocks with CAB 3 markers and label holders

Technical information p. 143

Pack*	Cat. Nos.		Markers for cables 0-15 to 0-5 mm ² and 0-5 to 1-5 mm ² cross section and terminal blocks	
			On Viking 3 terminal blocks - 4 markers 0-15 to 0-5 mm ² max. - 3 markers 0-15 to 1-5 mm ² max.	
			Digits : international colour code	
1 000	1 200	0381 00	0382 10	0
1 000	1 200	0381 01	0382 11	1
1 000	1 200	0381 02	0382 12	2
1 000	1 200	0381 03	0382 13	3
1 000	1 200	0381 04	0382 14	4
1 000	1 200	0381 05	0382 15	5
1 000	1 200	0381 06	0382 16	6
1 000	1 200	0381 07	0382 17	7
1 000	1 200	0381 08	0382 18	8
1 000	1 200	0381 09	0382 19	9
				Letters : black on yellow background
300	0381 10	0383 00		A
300	0381 11	0383 01		B
300	0381 12	0383 02		C
300	0381 13	0383 03		D
300	0381 14	0383 04		E
300	0381 15	0383 05		F
300	0381 16	0383 06		G
300	0381 17	0383 07		H
300	0381 18	0383 08		I
300	0381 19	0383 09		J
300	0381 20	0383 10		K
300	0381 21	0383 11		L
300	0381 22	0383 12		M
300	0381 23	0383 13		N
300	0381 24	0383 14		O
300	0381 25	0383 15		P
300	0381 26	0383 16		Q
300	0381 27	0383 17		R
300	0381 28	0383 18		S
300	0381 29	0383 19		T
300	0381 30	0383 20		U
300	0381 31	0383 21		V
300	0381 32	0383 22		W
300	0381 33	0383 23		X
300	0381 34	0383 24		Y
300	0381 35	0383 25		Z
				Conventional symbols : black on yellow background
300	0381 40	0382 70		/
300	0381 41	0382 71		•
300	0381 42	0382 72		+
300	0381 43	0382 73		-
300	0381 44	0382 74		~
300		0382 75		≡
300		0382 76		⊕

Pack*	Cat. Nos.		Markers for cables 1-5 to 2-5 mm ² and 4 to 6 mm ² cross section	
				Digits : international colour code
1 200	800	0382 20	0382 30	0
1 200	800	0382 21	0382 31	1
1 200	800	0382 22	0382 32	2
1 200	800	0382 23	0382 33	3
1 200	800	0382 24	0382 34	4
1 200	800	0382 25	0382 35	5
1 200	800	0382 26	0382 36	6
1 200	800	0382 27	0382 37	7
1 200	800	0382 28	0382 38	8
1 200	800	0382 29	0382 39	9
				Letters : black on yellow background
300	0383 30	0383 60		A
300	0383 31	0383 61		B
300	0383 32	0383 62		C
300	0383 33	0383 63		D
300	0383 34	0383 64		E
300	0383 35	0383 65		F
300	0383 36	0383 66		G
300	0383 37	0383 67		H
300	0383 38	0383 68		I
300	0383 39	0383 69		J
300	0383 40	0383 70		K
300	0383 41	0383 71		L
300	0383 42	0383 72		M
300	0383 43	0383 73		N
300	0383 44	0383 74		O
300	0383 45	0383 75		P
300	0383 46	0383 76		Q
300	0383 47	0383 77		R
300	0383 48	0383 78		S
300	0383 49	0383 79		T
300	0383 50	0383 80		U
300	0383 51	0383 81		V
300	0383 52	0383 82		W
300	0383 53	0383 83		X
300	0383 54	0383 84		Y
300	0383 55	0383 85		Z
				Conventional symbols : black on yellow background
300	0382 80	0382 90		/
300	0382 81	0382 91		•
300	0382 82	0382 92		+
300	0382 83	0382 93		-
300	0382 84	0382 94		~
300	0382 85	0382 95		≡
300	0382 86	0382 96		⊕

1 : Up to 0-5 mm²: strips of 25 markers
From 0-5 mm² to 2-5 mm²: strips of 30 markers
Upper 2-5 mm²: strips of 20 markers

CAB 3 accessories p. 142
Viking 3 terminal blocks p. 118-135



CAB 3[®] marking system

accessories



0384 90



0384 92



0383 92 +
CAB 3 markers



0383 97



0382 00

Technical information p. 143

Pack	Cat. Nos.	CAB 3 accessories										
		Marker holders – for cable For cables with cross section from 10 mm ² to 70 mm ² Capacity : 8 digit, letter or symbol markers from 0-5 to 1-5 mm ² or 1-5 to 2-5 mm ² cross section Black										
100	0384 90	10 to 16 mm ² cable cross section										
50	0384 91	25 to 35 mm ² cable cross section										
50	0384 92	50 to 70 mm ² cable cross section										
		Marker holders – for Viking 3 terminal blocks Can be clipped onto Viking 3 terminal blocks Capacity : 7 markers from 0-15 to 0-5 mm ² 6 markers from 0-5 to 1-5 mm ²										
100	0383 92											
		Transparent applicators For rapid selection and application of markers onto cable										
		<table border="1"> <thead> <tr> <th>For markers cross section (mm²)</th> <th>Applicator colour for identification of cross section</th> </tr> </thead> <tbody> <tr> <td>0-15 to 0-5</td> <td>Green</td> </tr> <tr> <td>0-5 to 1-5</td> <td>Red</td> </tr> <tr> <td>1-5 to 2-5</td> <td>Blue</td> </tr> <tr> <td>4 to 6</td> <td>Yellow</td> </tr> </tbody> </table>	For markers cross section (mm ²)	Applicator colour for identification of cross section	0-15 to 0-5	Green	0-5 to 1-5	Red	1-5 to 2-5	Blue	4 to 6	Yellow
For markers cross section (mm ²)	Applicator colour for identification of cross section											
0-15 to 0-5	Green											
0-5 to 1-5	Red											
1-5 to 2-5	Blue											
4 to 6	Yellow											
10	0383 94	0-15 to 0-5										
10	0383 95	0-5 to 1-5										
10	0383 96	1-5 to 2-5										
10	0383 97	4 to 6										
		Set of mixed markers										
1	0382 01	0-15 to 0-5 mm ² : 2 500 markers + 10 applicators (250 digits from 0 to 9)										
1	0382 02	0-5 to 1-5 mm ² : 3 000 markers + 10 applicators (300 digits from 0 to 9)										
1	0382 03	1-5 to 2-5 mm ² : 3 000 markers + 10 applicators (300 digits from 0 to 9)										
1	0382 04	4 to 6 mm ² : 2 000 markers + 10 applicators (200 digits from 0 to 9)										

Pack	Cat. Nos.	CAB 3 accessories
1	0382 00	On-site toolbox With removable tray for CAB 3 markers and applicators, Starfix ferrules etc. Height 85 mm, depth 280 mm, width 450 mm Metal, padlockable Supplied empty

CAB 3® marking system

for cables and Viking 3 terminal blocks

■ Dimensions

Markers

Polyamide 6/6

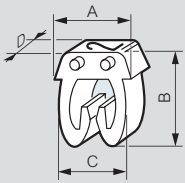

Dimensions	Cable cross section (mm²)			
	0-15 to 0-5	0-5 to 1-5	1-5 to 2-5	4 to 6
A (mm)	5	5	5-6	8
B (mm)	5-05	6-4	7-6	9-6
C (mm)	3-7	4-3	4-9	7-1
D (mm)	2-3	3	3	3
Ø min./max. (mm)	0-8/2-2	2-2/3	2-8/3-8	4-3/5-3

Marker holders – for cable

Cat. No. 0384 90

Cat. No. 0384 91

Cat. No. 0384 92

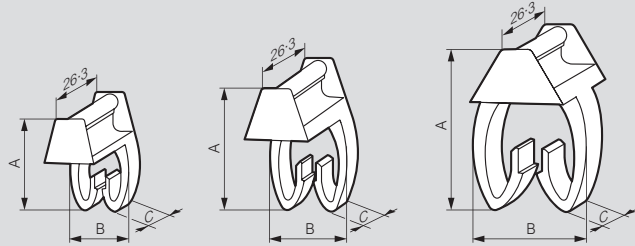

Dim.	Section of cable for marking (mm-)		
	10 to 16	25 to 35	50 to 70
A (mm)	18	24-3	27-2
B (mm)	8-9	12-2	17-2
C (mm)	7	7	10

Marker holders – for Viking 3 terminal blocks

Cat. No. 0383 92

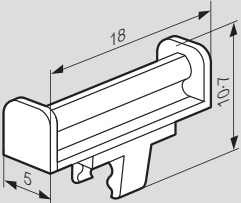

On-site toolbox

Cat. No. 0382 00

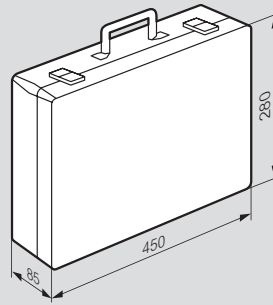

Bottom tray consists of :

- 8 medium slots (each slot takes 1 box of CAB 3)
- 1 large slot

Top tray consists of :

- 12 small slots (<=> approx. 6 boxes of CAB 3)
 - 1 medium slot for applicators
- Capacity : approx. 15000 CAB 3 markers

■ Examples

CAB 3 fitted on to Viking 3 terminal blocks using marker holder (Cat. No. 0383 92)



Fitted directly on to heavy duty terminal blocks

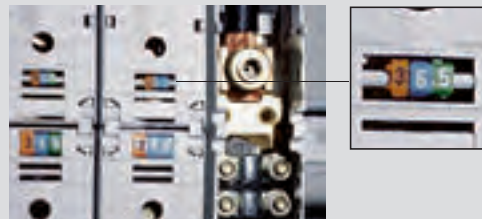

Fitted on to cable with marker holder (Cat. No. 0384 92)



Cable tie specification guide

OPERATING TEMPERATURE

Always check the operating temperature, especially if the cable tie is to be installed in an application where extreme temperature may occur. Not all ties are made with the same material characteristics and some can become brittle at low temperatures and soften at high temperatures

Legrand recommends

- Colring polyamide 6/6 black cable ties (operating temperature: -15°C to +120°C)
- Colson polyamide 12 black cable ties (operating temperature: -40°C to +100°C)

ENVIRONMENT

Establish if the cable tie is being used inside or outside. Exposure to sunlight and UV rays can damage and break down the material causing the tie to weaken and fracture. Always choose a UV protected cable tie for external applications

Legrand recommends

- Colring polyamide 6/6 black or Colson polyamide 12 black UV protected cable ties for external usage

TENSILE STRENGTH

Consider the load that the cable tie will need to deal with. Tensile strength is the maximum stress that a material can withstand while being stretched or pulled before failing or breaking

Legrand recommends

- Colson polyamide 12 black UV protected cable ties for heavy load applications

For more information please contact Legrand on:

Tel: 0845 605 4333

Fax: 0845 605 4334

Email: uk-wdsales@legrand.co.uk

HALOGENS

Are halogen free cable ties required?

Halogens are a group of highly reactive elements. Products containing halogens can produce highly dangerous gases when burned, and can therefore be life threatening in the event of a fire

Legrand recommends

- Colring and Colson cable ties, both of which are halogen free

INTERNAL OR EXTERNAL TEETH

Cable ties with external teeth are particularly useful in applications where internal teeth could cause damage. An example of this is for suspended lines, where damage to insulation needs to be avoided

Legrand recommends

- Colson polyamide 12 black UV protected cable ties with external teeth

EXTERNAL AGENTS

Ensure that the cable ties are resistant to any external agents they may be exposed to, such as oils, greases, petroleum products and chlorinated solvents. This is particularly important for extreme environments

Legrand recommends

- Colring cable ties for environments where oils, greases, petroleum products and chlorinated solvents may be present
- Colson cable ties for environments where oils, greases, petroleum products, saline mist and diluted acids may be present

FIRE PROPAGATION

Is there a fire risk? This will affect the type of cable tie required. We would always recommend fire resistant cable ties to guarantee the safety of persons and property in the event of a fire

Legrand recommends

- All Legrand cable ties are flame retardant with a fire resistance to UL 94

Colring® cable ties



Technical information p. 146

Pack	Cat. Nos.	Colring cable ties with internal teeth				
		With self-locking head Conform to EN 62275 type 1 (NF C 68-146)				
		Polyamide 6/6 colourless				
		Blister packed				
		Width (mm)	Flat length (mm)	Max. Ø grip capacity (mm)	Min. Ø grip capacity (mm)	Weight (g)
1000	0320 30	2-4	95	18	1-6	0-26
1000	0320 31	2-4	140	33	1-6	0-37
1000	0320 32	2-4	180	46	1-6	0-47
1000	0320 37	3-5	140	33	1-6	0-57
1000	0320 38	3-5	180	46	1-6	0-73
100	0320 39	3-5	280	77	1-6	1-13
100	0320 40	3-5	360	102	1-6	1-46
1000	0320 42	4-6	180	46	1-6	1-20
100	0320 43	4-6	280	77	1-6	1-88
		Polyamide 6/6 black				
		High temperature UV protected Blister packed				
100	0320 12	2-4	95	18	1-6	0-26
100	0320 15	3-5	140	33	1-6	0-57
1000	0320 22	4-6	180	46	1-6	1-20
100	0320 24	4-6	360	102	1-6	2-38

Pack	Cat. Nos.	Accessories	
		Self-adhesive base	
100	0320 65	For ties up to 4-6 mm max. width Colourless	
		Screw mounting bases	
1000	0320 70	For ties 4-6 mm max. width Central fixing (screw Ø 4 mm)	
100	0320 72	For ties all widths Central fixing (screw Ø 5 mm)	
		Tool for Colring cable ties	
		Max. width 4-6 mm Direct adjustment of clamping tension by using the milled screw at the base of the handle After clamping, a blade automatically cuts the surplus length close to the head without leaving a burr	
1	0320 88	P 46 tool for cable ties	

Colson® cable ties



Technical information p. 147

Pack	Cat. Nos.	Colson UV protected cable ties				
		Conform to EN 50146 and IEC 62275 UV protected External teeth Black polyamide 12				
		Width (mm)	Flat length (mm)	Max. Ø grip capacity (mm)	Min. Ø grip capacity (mm)	Weight (g)
100	0319 13	9	185	42	10	3-2
100	0319 16	9	262	62	26	4-7
100	0319 19	9	357	92	26	6-9
100	0319 20	9	498	140	74	12-7
100	0319 21	9	750	220	74	16-9
100	0319 22	6	119	25	4	1-6
100	0319 25	6	180	45	10	2-0
		Accessories				
		Screw-on base				
100	0319 50	Black For ties max. width 9 mm. Height : 12 mm for cartridge-fired stud and rag-bolt Ø 6-35 mm, metal stud Ø 7 mm and countersunk screws Ø 5 mm				
		Wall plug base				
100	0319 55	Black Ø 8 mm drilling				
		Tool for Colson cable ties				
1	0319 96	Black and red finish Allows tightening and trimming of Colson ties				

■ Performance

Conform to EN 62275 type 1 (NFC 68-146)
 "cable ties for electrical installations"
 Recognised UL 1565 approval

■ Technical data

Good resistance to bases, oils, greases and petroleum products
 Limited resistance to acids, sensitive to mineral acids and no resistance to phenol

Cable ties Polyamide 6/6		Max. ratchet force (daN)	Tensile strength	
Colourless Non UV protected	Black High temperature UV protected		According to EN 50146	
			Test dia. (mm)	Min. guaranteed strength (daN)
0320 30	0320 12	0-50	18	8-0
0320 31		0-50	20	8-0
0320 32		0-50	20	8-0
0320 37	0320 15	0-50	20	13-0
0320 38		0-50	20	13-0
0320 39		0-50	20	13-0
0320 40		0-50	20	13-0
0320 42	0320 22	0-50	20	22-0
0320 43		0-50	20	22-0
	0320 24	0-50	20	22-0

Type	Colring colourless	Colring black
UV protection	no	yes
Polyamide material	6/6	6/6
Teeth	internal	internal
Halogen free ¹	yes	yes
Humidity absorption ²	2.5 %	2.5 %
Operating temperature		
- 20,000 hrs	85 °C	105 °C
- 1,000 hrs	100 °C	120 °C
Resistance to low temperatures		
- fitted	-15 °C	-15 °C
- assembly	-10 °C	0 °C
Flame retardancy	UL 94 V2	UL 94 V2
Oxygen index (LOI) (EN ISO 4589-1/ASTM D 2863-00)	28.5 %	26 %
Self-extinguishing ³	850 °C	850 °C

1 : Conform to Class I ASTM D 4066 (Class 2 for Colring black)
 2 : Conform to ISO 62 (EH 0-23°C)
 3 : Conform to IEC 60695-2-12

External agents resistance

- Good resistance to bases, oils, greases, petroleum products, chlorinated solvents
- Humidity retention : 1.5 % ≤ humidity retention ≤ 3 %

Fire resistance

- Flame resistance UL 94 : V2
- Flame-retardant
- Self-extinguishing 850 °C according to IEC 60695-2-12
- Oxygen index : EN ISO 4589-1 / ASTM D 2863-00 : 28.5% (26% for Colring black)
- Halogen-free polyamide, class 1 according to ASTM D 4066 (Class 2 for Colring black)

■ Dimensions

Accessories for Colring

Cat. No. 0320 65

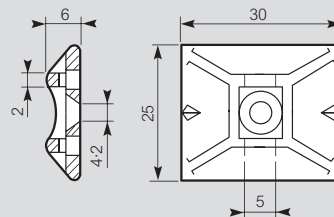

Cat. No. 0320 70

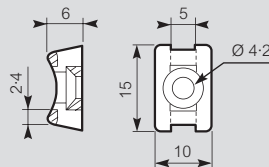

Cat. No. 0320 72

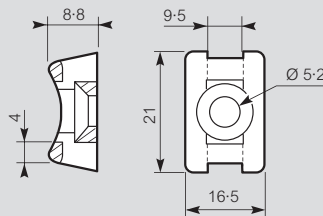

Colson® cable ties

■ Performance

Conform to EN 62275 type 1 (NFC 68-146)

"cable ties for electrical installations"

Test conditions :

- Temperature : 23 °C
- Relative humidity of air : 50 %
- Traction speed : 25-4 mm/min

■ Technical data

Constant high quality

Type tests

- Raw material test
- Product test on the production line and in the laboratory
- Packaging test

Tensile strength (according to EN 50146)

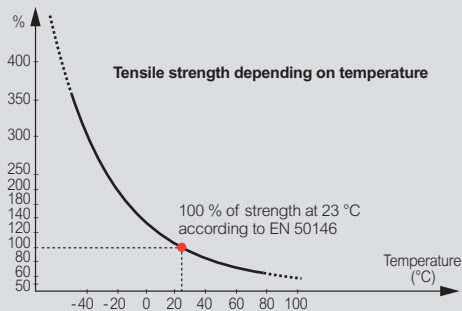

Quality of tensile strength

Cat. Nos.	Diagram (A) - Max. ratchet force (daN)	Diagram (B) - Tensile strength	
		Test dia. (mm) According to EN 50146	Min. strength (daN)
0319 13	4	20	36
0319 16	5	26	53
0319 19	5	26	53
0319 20	5.5	74	53
0319 21	5.5	74	53
0319 22	4	20	22
0319 25	4	20	22

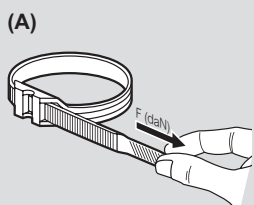

Fire resistance

- Flame retardant
- Conform to UL 94 requirements, HB classification
- Glow-wire flammability resistance according to IEC 60695-2-11 : 650 °C
- Oxygen index (LOI) according to EN ISO 4589-1/ASTM D 2863-00 : 20 %
- Low fire hazard polyamide

UV protected according to norm IEC 62275 type 1

UV protected black cable ties for outdoor use

These black cable ties have successfully undergone UV resistance and climatic ageing tests representing actual conditions of use

These cycles combine a 1000 hours radiance under arc or xenon lamp according to ISO 4892-2 method 1

Resistance to external agents



- Good resistance to oils, greases, petroleum products, saline mist and diluted acids

Resistance to rain



- Humidity absorption: ≤ 0.7%

Resistance to low temperatures



- Assembly -30 °C
- Fitted -40 °C

Resistance to sun



- Maximum temperatures :
- 85 °C continuous
 - 100 °C @ 1000 hrs
 - UV resistant

Colson approvals

Oxygen index : EN ISO 4589-1 and ASTM D 2863-00, 20 %

Corrosiveness of fumes : NFC 20-453, < 5 %

Flame retardancy : UL 94 HB

Type	Colson black
UV protection	yes
Polyamide material	12
Teeth	external
Halogen free ¹	yes
Humidity absorption ²	<0.7 %
Operating temperature	
- 20,000 hrs	85 °C
- 1,000 hrs	100 °C
Resistance to low temperatures	
- fitted	-40 °C
- assembly	-30 °C
Flame retardancy	UL 94 HB
Oxygen index (LOI) (EN ISO 4589-1/ASTM D 2863-00)	20 %
Self-extinguishing ³	650 °C

1 : Conform to Class I ASTM D 4066

2 : Conform to ISO 62 (EH 0-23 °C

3 : Conform to IEC 60695-2-11

■ Colson traceability

Each Colson cable tie can be identified, underlining Legrand's commitment to the consumer, so that you can always be sure you are using a genuine Colson

■ Dimensions

Accessories for Colson

Cat. No. 0319 50

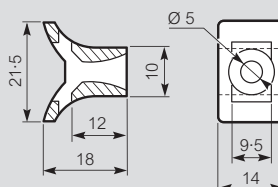

Cat. No. 0319 55

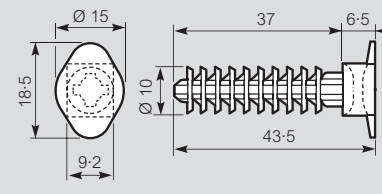

Starfix® ferrules and crimping tools

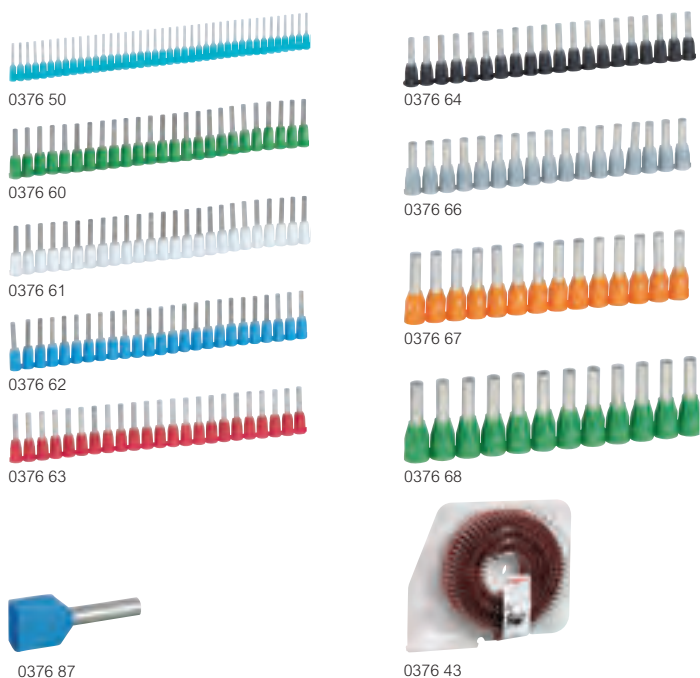

Technical information p. 149

Pack	Cat. Nos.	Ferrules with insulating flange			
		Provide an equipotential link for all the strands of a flexible conductor Active part in tinned electrolytic copper Conform to NF C 63-023			
		Single ferrules (in strips) Supplied in strips to prevent loss of ferrules			
		For cables cross section (mm ²)	Colour	Strips	Ferrules
500	0376 50	0-25	turquoise	10	50
500	0376 60	0-34	green	10	50
480	0376 61	0-5	white	12	40
480	0376 62	0-75	blue	12	40
1000	0376 63	1-0	red	25	40
1000	0376 64	1-5	black	25	40
1000	0376 66	2-5	grey	25	40
250	0376 67	4-0	orange	10	25
250	0376 68	6-0	green	10	25
		Individual ferrules - single			
100	0376 69	10	brown		
100	0376 70	16	white		
50	0376 71	25	black		
		Individual ferrules - double			
100	0376 87	2 x 0-75	blue		
100	0376 88	2 x 1-0	red		
100	0376 89	2 x 1-5	black		
100	0376 90	2 x 2-5	grey		
		Large capacity refills Large capacity for less frequent applicator reloading Translucent packaging For direct mounting on crimping tool Cat. No. 0376 09			
		Cross section (mm ²)	Colour	Number of ferrules per strip	
3000	0376 41	0-5	White	300	
3000	0376 42	0-75	Blue	300	
3000	0376 43	1-0	Red	300	
3000	0376 44	1-5	Black	300	
2500	0376 45	2-5	Grey	250	

Colours according to NF C 63-023 standard

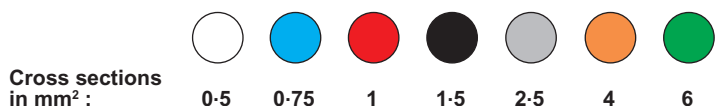

Cross sections in mm² :

Pack	Cat. Nos.	Crimping tools for ferrules in strips	
		Cut and carry out 4-point crimping of ferrules from 0-25 to 6 mm ² in one operation Recommended for spring connections Dedicated applicator for each crimping tool for dispensing strips For right and left-handed usage 4 point crimping for Cat. Nos. 0376 08/09 3 point crimping for Cat. No. 0376 10	
1	0376 08	For ferrules with 0-25 and 0-34 mm² cross sections Supplied with empty applicator fitted	
1	0376 09	For ferrules with 0-5 to 2-5 mm² cross sections Fitted with an adjustment wheel Supplied with empty applicator fitted	
1	0376 10	For ferrules with 4 and 6 mm² cross sections Fitted with an adjustment wheel Supplied complete with empty applicator	
1	0376 39	Transport case for on-site use Assorted kit, comprising : - 1 Starfix crimping tool, Cat. No. 0376 09 with empty applicator fitted - 120 x 0-5 mm ² ferrules - 120 x 0-75 mm ² ferrules - 240 x 1-0 mm ² ferrules - 320 x 1-5 mm ² ferrules - 200 x 2-5 mm ² ferrules	
1	0376 97	Multi-purpose crimping tool for 0-5 to 2-5 mm² cross sections Tool cuts, strips, twists, crimps Supplied complete with 5 empty applicators	
1	0376 06	Crimping tool for single and double ferrules Starfix crimping tool for 0-25 to 6 mm² cross sections For 4-point crimping of ferrules from 0-25 to 6 mm ² Recommended for spring connections Crimping tool with disengageable control system, crimping at end For right and left-handed usage	
1	0376 92	Transport case for on-site use Assorted kit. Supplied with : - 1 tool with crimping operation control system for individual ferrules 10 to 50 mm ² - 30 individual ferrules 10 mm ² - 20 individual ferrules 16 mm ² - 15 individual ferrules 25 mm ² - 10 individual ferrules 35 mm ² - 10 individual ferrules 50 mm ²	

applicators for Starfix® crimping tools



0376 47

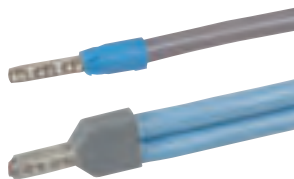

Example of single/double ferrules fitted on cables



Example of different cables and ferrules

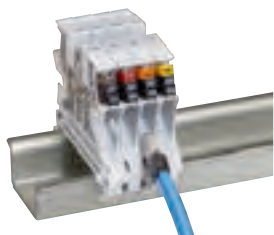

Example of use with Viking 3 terminals

Technical information **opposite**

Pack	Cat. Nos.	Starfix applicators
10	0376 46	For Starfix crimping tools For dispensing strips of ferrules in Starfix crimping tools Cat. Nos. 0376 08/09/10/97 For ferrules cross section (mm ²) Colour 0.25 and 0.34 yellow 0.5 to 2.5 red 4 and 6 orange
10	0376 47	
10	0376 48	

Starfix® ferrules, crimping tools and applicators

■ Correspondance table

Cross section (mm ²)			
	Single ferrule	Large capacity ferrule - refills	Starfix applicator
0.5	0376 61	0376 41	0376 47
0.75	0376 62	0376 42	0376 47
1.0	0376 63	0376 43	0376 47
1.5	0376 64	0376 44	0376 47
2.5	0376 66	0376 45	0376 47

■ Dimensions (mm)

Single ferrules

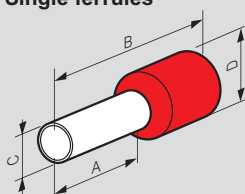

Cat. Nos.	Cross section (mm ²)	A	B	C	D
0376 50	0.25	8	14.5	1.1	3
0376 60	0.34	8	14.5	1.1	3
0376 61	0.5	8	14.5	1.5	3.4
0376 62	0.75	8	14.5	1.5	3.4
0376 63	1.0	8	14.5	1.7	3.6
0376 64	1.5	8	14.5	2	4.1
0376 66	2.5	8	14.5	2.6	4.8
0376 67	4	12	21	3.2	5.7
0376 68	6	12	23	3.9	7.2
0376 69	10	12	21	4.9	8.1
0376 70	16	18	29	6.3	9.8
0376 71	25	18	31	7.9	12

Double ferrules

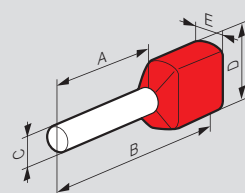

Cat. Nos.	Cross section (mm ²)	A	B	C	D	E
0376 87	2 x 0.75	8	15	2.1	6	3.3
0376 88	2 x 1.0	8	15	2.35	6	4
0376 89	2 x 1.5	8	16	2.6	7.2	4.2
0376 90	2 x 2.5	10	18.5	3.3	8.4	4.8

■ Starfix crimping tool usage example



1 Fit the applicator



2 Adjust



The handle gives an excellent grip



3 Insert the cable



4 Crimp



INDUSTRIAL PLUGS, SOCKETS AND COMBINATION UNITS

**Hypra® Prisinter
IP 44/55**



P. 156
Selection chart IP 44/55
panel and surface
mounting sockets
LV 16/32/63 A

**Hypra®
IP 44**



P. 162
Selection chart
IP 44 plugs and sockets
ELV 16 A and
LV 16/32/63 A

**Hypra®
IP 66/67-55**



P. 168
Selection chart
IP 66/67-55
plugs and sockets
LV 16/32/63/125 A

**P 17 Tempra Pro/
P 17 Tempra®
IP 44**



P. 178
Selection chart
IP 44 plugs and sockets
LV 16/32 A

**P 17 Tempra Pro/
P 17 Tempra®
IP 66/67**



P. 182
Selection chart
IP 66/67
plugs and sockets
LV 16/32/63 A

**Hypra®
combination units
IP 44, IP 66/67-55**



P. 190
IP 44
combination units
16/32/63/125 A

**P 17 Tempra®
combination units
IP 44/IP 55/IP 66**

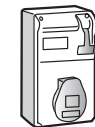

P. 194
IP 44
combination units
LV 16/32 A

**P 17 Tempra®
self assembly
combination units
IP 44, IP 66/67**

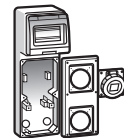

P. 195
Self assembly
LV 16/32 A

NEW 2014



**P17 Tempro Pro
IP 44 - LV 16/32 A**
Panel and surface
mounting sockets
(p. 178)



**P17 Tempro Pro
IP 44 - LV 16/32 A**
Mobile sockets and
straight plugs
(p. 178)



P. 156
IP 44/55
panel and surface
mounting sockets
LV 16 A



P. 157
IP 44/55
panel and surface
mounting sockets
LV 32 A



P. 157
IP 44/55
panel and surface
mounting sockets
LV 63 A



P. 158
Technical
information

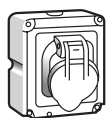

P. 163
IP 44
plugs and sockets
ELV 16 A and
LV 16 A

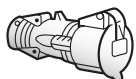

P. 164
IP 44
plugs and sockets
LV 32 A

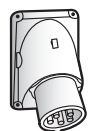

P. 164
IP 44
plugs and sockets
LV 63 A



P. 165
Technical
information

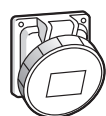

P. 169
IP 66/67-55
plugs and sockets
LV 16 A

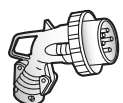

P. 170
IP 66/67-55
plugs and sockets
LV 32 A

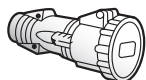

P. 170
IP 66/67-55
plugs and sockets
LV 63/125 A



P. 171
Technical
information

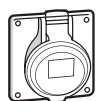

NEW
P. 179
IP 44
plugs and sockets
LV 16 A

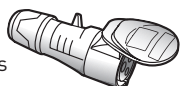

NEW
P. 179
IP 44
plugs and sockets
LV 32 A



P. 179
IP 44
appliance inlets
LV 16/32 A



P. 180
Technical
information



NEW
P. 183
IP 66/67
plugs and sockets
LV 16/32 A

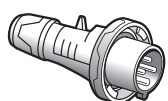

P. 183
IP 66/67
plugs and sockets
LV 63/125 A

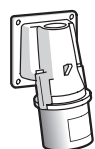

P. 183
IP 66/67
appliance inlets
LV 16/32/63/125 A



P. 184
Technical
information



P. 190
IP 44
combination units
with Prisinter
16/32 A



P. 191
IP 66/67-55
combination units
LV 16/32/63/125 A



P. 192
Technical
information

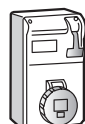

P. 194
IP 55
combination units
LV 16/32 A



P. 194
IP 66
combination units
LV 16/32/63 A



P. 196
Technical
information



P. 195
IP 44 and
IP 66/67
sockets for
self assembly units
LV 16/32 A



P. 196
Technical
information



P. 198
Plugs and sockets
pin configurations



P17 Tempro Pro
IP 66/67 - LV 16/32 A
Panel and surface
mounting sockets
(p. 183)



P17 Tempro Pro
IP 66/67 - LV 16/32 A
Mobile sockets and
straight plugs
(p. 183)

HYPRA - tough, durable reliability

Industrial plugs, sockets and combination units

A choice of plugs, sockets and combination units, each designed to meet the individual needs of specific areas of the market.

From the everyday simplicity of the P17 Tempra Pro and P17 Tempra ranges to the rugged sophistication and additional security presented by Hypra, which is further enhanced by its unique interlocked load break Prisinter sockets range.



HYPRA PRISINTER SOCKETS

- Unique interlocked load break
- Padlockable cover
- Compact combined socket and switch
- Surface and panel mounting options
- Available in plastic and metal versions

TECH INFO

- IP44/55
- IK09 (plastic)
- IK10 (metal)



HYPRA PLUGS AND SOCKETS

- Full range of panel and surface mounting sockets, mobile sockets, straight plugs and appliance inlets
- Available in plastic and metal

TECH INFO

- IP44 and IP66/67-55 ranges
- IK09 (plastic)
- IK10 (metal)

NEW P17 Tempra Pro...

Following the success of P17 Tempra, Legrand's new P17 Tempra Pro range of LV 16 and 32A plugs and sockets offers improved strength, safety and a wealth of design features with real user benefits.

Available in IP44 and IP66/67 polyamide 6 versions, P17 Tempra Pro is suited to most internal and external applications.

See p. 176 to 187



P17 Tempra Pro and P17 Tempra- innovative simplicity

Combination units - rugged versatility



NEW



**P17 TEMPRA PRO
PLUGS AND SOCKETS**

- NEW LV 16 / 32A range of panel and surface mounting sockets, mobile sockets and straight plugs

TECH INFO

- IP44 and IP66/67 ranges
- IK09

**P17 TEMPRA
PLUGS AND SOCKETS**

- LV 16 / 32A appliance inlets
- LV 63 / 125A range of panel and surface mounting sockets, mobile sockets, straight plugs and appliance inlets

TECH INFO

- IP44 and IP66/67 ranges
- IK09

**HYPRA
COMBINATION UNITS**

- Available with Hypra Prisinter or Hypra panel mounted sockets
- RCD, MCB or RCBO protection options

TECH INFO

- IP44 and IP66/67-55 ranges
- IK09

**P17 TEMPRA
COMBINATION UNITS**

- Available pre-assembled, or as self assembly version
- Available with or without protection

TECH INFO

- IP44, IP55 and IP66 ranges
- IK08

FREE CPD: SPECIFICATION GUIDE TO INDUSTRIAL PLUGS AND SOCKETS
VISIT: LEGRAND.CO.UK/TRAINING

Legrand's extended product family

With quality being paramount throughout its product portfolio, Legrand is in an unbeatable position... offering high quality, integrated solutions designed to meet your needs whatever the budget or installation requirements.



Enclosures
see p. 8 to 45

MCBs
see p. 56 to 60

RCDs
see p. 61 to 62

RCBOs
see p. 63 to 64

Hypra[®] Prisinter... take a load off your mind

With its unique interlocked load break, the Prisinter is a key asset to the Hypra range and is available in 16, 32 and 63 A ratings.

Features:

- Combined socket and switch - saving space, cost and installation time
- Unique interlocked load break system - prohibits on load connection or disconnection for maximum safety
- Padlockable cover - for additional security
- Brass contact sleeves - create high quality, reliable connections
- Stainless steel screws - maximum durability



Simple, safe and unique

The added safety provided by Hypra's load break system prior to disconnection is equivalent to that provided by safety shutters on domestic sockets.

1. Turn the plug to lock in position and connect power
2. Press the isolator button to disconnect power and remove the plug

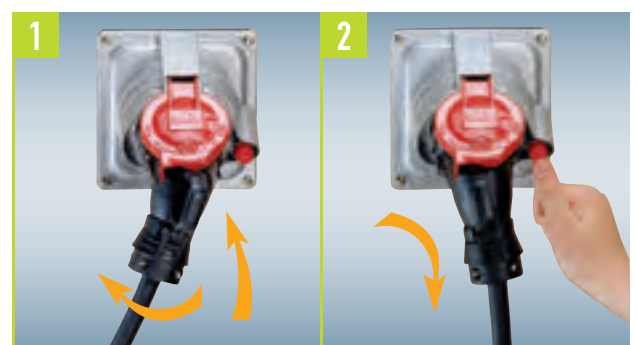

TECHNICAL DATA

APPROVALS:

BS EN 60309-1, BS EN 60309-2
Products are interchangeable with other manufacturers' products that meet BS EN 60309-2

SELF EXTINGUISHING:

950°C for insulated parts, 650°C for housing

OPERATING TEMPERATURE:

-20°C to +100°C

PROTECTION:

IP44 with Hypra IP44 straight plug connected
IP54 with Hypra IP66/67-55 straight plug connected
IP55 with cover closed or IP66/67-55 angled plug connected

IK09 for plastic products

IK10 for metal products



Safe and adaptable power supply for TATA steel Colorcoat® PV Facility

Prisinter sockets and Hypra plugs were specified retrospectively for TATA in a facility which requires machinery to be moved on a regular basis. Machines, originally wired directly to Zucchini tap-offs, are now wired into Hypra plugs, and simply connected and disconnected as required under the safety of Prisinter's interlocked load break switch.

Above:
Hypra Prisinter socket, Hypra angled plug and Zucchini tap-off

HYPRA PRISINTER - the choice is yours



Panel mounting (plastic and metal options)

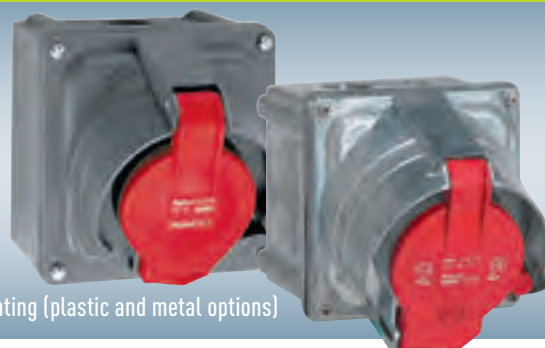

Surface mounting (plastic and metal options)

Related products and accessories



IP44 plugs
see p. 162 to 167



IP66/67-55 plugs
see p. 168 to 173

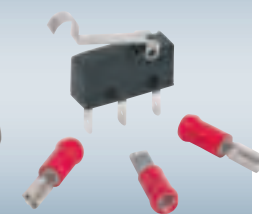

Auxiliary c/o contact work in conjunction with main contacts to provide remote indication and supplementary equipment control
see p. 156

An innovative answer to safe, secure power connections

Hypra® Prisinter IP 44/55 - LV 16/32/63 A

selection chart

HYPRAS® PRISINTER IP 44/55 - LV 16/32/63 A

Conform to :
 BS EN 60309-1,
 BS EN 60309-2,
 IP 44 when plug inserted
 IP 54 when used with IP 66/67-55 straight plugs
 IP 55 with cover closed or used with IP 66/67-55 angled plugs
 IK 09 (plastic)
 IK 10 (metal)
 Self-extinguishing : 960 °C
 650 °C for housing
 Temp. rating :
 -20 °C to +100 °C

(Back boxes sold separately)

Technical information and dimensions p. 158-159

			Prisinter				Auxiliary c/o contact microswitch
LV			Panel mounting sockets		Surface mounting sockets		
			METAL	PLASTIC	METAL	PLASTIC	
100 to 130 V 50/60 Hz	16 A	2 P + ⊥	-	0519 10	-	0519 10+ 0520 49	0521 96
		2 P + ⊥	-	0520 02	-	0520 02+ 0520 49	0521 96
		3 P + ⊥	-	0520 03	-	0520 03+ 0520 49	0521 96
200 to 250 V 50/60 Hz	16 A	3 P + N + ⊥	-	0520 04	-	0520 04+ 0522 49	0521 96
		2 P + ⊥	-	0527 02	-	0527 02+ 0529 49	0521 96
		3 P + ⊥	-	0527 03	-	0527 03+ 0529 49	0521 96
380 to 415 V 50/60 Hz	16 A	3 P + ⊥	0522 13	0522 03	0522 13+ 0520 59	0522 03+ 0520 49	0521 96
		3 P + N + ⊥	0522 14	0522 04	0522 14+ 0529 59	0522 04+ 0522 49	0521 96
	32 A	3 P + ⊥	0529 13	0529 03	0529 13+ 0522 59	0529 03+ 0529 49	0521 96
		3 P + N + ⊥	0529 14	0529 04	0529 14+ 0522 59	0529 04+ 0529 49	0521 96
	63 A	3 P + ⊥	0538 00	0536 03	0538 00+ 0538 09	0536 03+ 0537 49	0521 96
		3 P + N + ⊥	0538 01	0536 04	0538 01+ 0538 09	0536 04+ 0537 49	0521 96

For pack quantities, see opposite and p. 157

Hypra® Prisinter IP 44/55 - LV 16 A

interlocked switched sockets

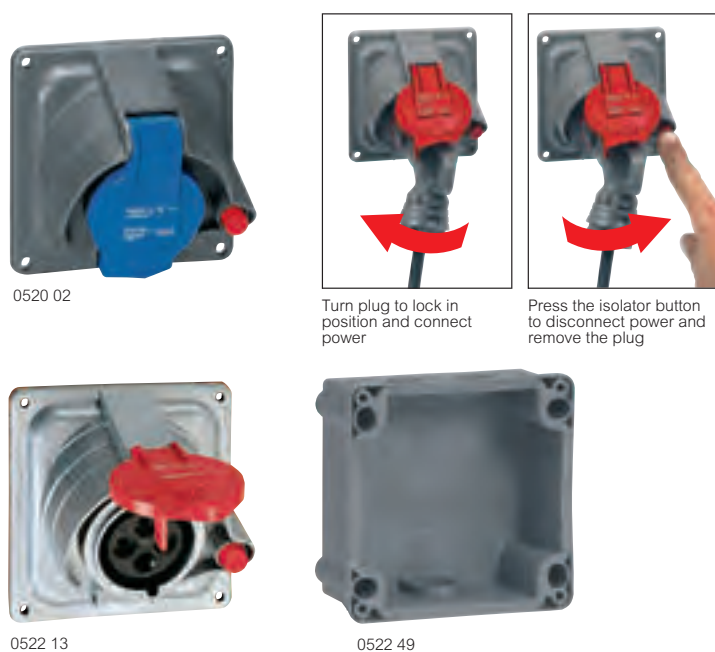

Technical information and dimensions p. 158-159
 Conformity to International Standards p. 198

Conform to BS EN 60309-1, BS EN 60309-2
 IP 44 when plug inserted
 IP 54 when used with IP 66/67-55 straight plugs
 IP 55 with cover closed or used with IP 66/67-55 angled plugs
 IK 09 (plastic)
 IK 10 (metal)
 Stainless steel screws
 Brass contacts

Pack	Cat. Nos.		Prisinter panel mounting sockets 16 A
			Load break disconnect at the push of the button Accepts Ø6 mm padlock with cover closed Terminals accept 1.5 mm ² to 4 mm ² rigid cable (BS EN 60309-1 and IEC 60309-1) Possibility to fit 2 auxiliary C/O contacts Cat. No. 0521 96
			100/130 V ~
1	Metal	0519 10	2 P + ⊥
			200/250 V ~
1		0520 02	2 P + ⊥
1		0520 03	3 P + ⊥
1		0520 04	3 P + N + ⊥
			380/415 V ~
1	0522 13	0522 03	3 P + ⊥
1	0522 14	0522 04	3 P + N + ⊥

	Surface mounting boxes		
			Enable Hypra Prisinter panel mounting sockets to be surface mounted Reversible entry box with 3 x M20 entries with 2 blanking plugs plus rear knockout entries
			For 2 P + ⊥ / 3 P + ⊥ sockets
1	Metal	0520 59	0520 49
1		0529 59	0522 49
			For 3 P + N + ⊥ sockets

IP 44 straight plugs p. 162-164



IP 66/67-55 angled and straight plugs p. 169-170



Hypra® Prisinter IP 44/55 - LV 32 A

interlocked switched sockets



0529 13



Turn plug to lock in position and connect power



Press the isolator button to disconnect power and remove the plug



0529 04 + 0529 49

Technical information and dimensions **p. 158-159**
Conformity to International Standards **p. 198**

Conform to BS EN 60309-1, BS EN 60309-2
IP 44 when plug inserted
IP 54 when used with IP 66/67-55 straight plugs
IP 55 with cover closed or used with IP 66/67-55 angled plugs
IK 09 (plastic)
IK 10 (metal)
Stainless steel screws
Brass contacts

Pack	Cat. Nos.		Prisinter panel mounting sockets 32 A
			Load break disconnect at the push of the button Accepts Ø6 mm padlock with cover closed Terminals accept 2.5 mm ² to 10 mm ² rigid cable (BS EN 60309-1 and IEC 60309-1) Possibility to fit 2 auxiliary C/O contacts Cat. No. 0521 96
	Metal	Plastic	200/250 V~
1		0527 02	2 P + ⊥
1		0527 03	3 P + ⊥
			380/415 V~
1	0529 13	0529 03	3 P + ⊥
1	0529 14	0529 04	3 P + N + ⊥

Pack	Cat. Nos.		Surface mounting boxes
			Enable Hypra Prisinter panel mounting sockets to be surface mounted Reversible entry box with 2 x M25 and 1 x M20 entries with 1 x M25 and 1 x M20 blanking plugs plus rear knockout entries
1	Metal	Plastic	For 2 P + ⊥ / 3 P + ⊥ / 3 P + N + ⊥ sockets
	0522 59	0529 49	

IP 44 straight plugs **p. 162-164**



Hypra® Prisinter IP 44/55 - LV 63 A

interlocked switched sockets



0538 00 + 0538 09



Turn plug to lock in position and connect power



Press the isolator button to disconnect power and remove the plug

Technical information and dimensions **p. 158-159**
Conformity to International Standards **p. 198**

Conform to BS EN 60309-1, BS EN 60309-2
IP 44 when plug inserted
IP 54 when used with IP 66/67-55 straight plugs
IP 55 with cover closed or used with IP 66/67-55 angled plugs
IK 09 (plastic)
IK 10 (metal)
Stainless steel screws
Brass contacts

Pack	Cat. Nos.		Prisinter panel mounting sockets 63 A
			Load break disconnect at the push of the button Accepts 3 x Ø8 mm padlocks with cover closed IP 2X protection against direct contact Terminals accept 6 mm ² to 25 mm ² rigid cable Possibility to fit 2 auxiliary C/O contacts Cat. No. 0521 96
	Metal	Plastic	380/415 V~
1	0538 00	0536 03	3 P + ⊥
1	0538 01	0536 04	3 P + N + ⊥

Pack	Cat. Nos.		Surface mounting boxes
			Enable Hypra Prisinter panel mounting sockets to be surface mounted Reversible entry box with 2 x M32 and 1 x M20 entries with 1 x M32 and 1 x M20 blanking plugs
1	Metal	Plastic	For 3 P + ⊥ / 3 P + N + ⊥ sockets
	0538 09	0537 49	

IP 66/67-55 angled and straight plugs **p. 169-170**



Hypra® Prisinter IP 44/55 - LV 16/32/63 A

panel mounting interlocked switched sockets

■ Technical information

Icc 10 kA according to BS EN 60309-1, BS EN 60309-2, IEC 60309-1 and IEC 60309-2

IP rating according to BS EN 60529 and IEC 60529 :

IP 44 when plug inserted

IP 54 when used with IP 66/67-55 straight plugs

IP 55 with cover closed or used with IP 66/67-55 angled plugs

IK according to BS EN 62262 and IEC 62262 :

IK 09 : Plastic

IK 10 : Metal

Stainless steel screws

Brass contacts

Resistance to glow wire and dielectric strength

Glow wire :

960° C for live part supports

650° C for other parts

Dielectric strength : 3 000 V 50 Hz

Temperatures

-20 °C to + 100 °C (+80 °C with auxiliary fitted)

Installation : -20 °C / +40 °C

Use : -20 °C / +100 °C

Hypra Prisinter breaking capacity at 3 x 400 V_~ according to BS EN 60947-1, BS EN 60947-3, IEC 60947-1 and IEC 60947-3 :

Category	16 A	32 A	63 A
AC 1	16 A	32 A	63 A
AC 23	8.4 kW	16.8 kW	33 kW
AC 3	8.4 kW	16.8 kW	33 kW

■ Dimensions

Prisinter panel mounting sockets IP 44/55 - LV 16/32/63 A

(p. 156-157)

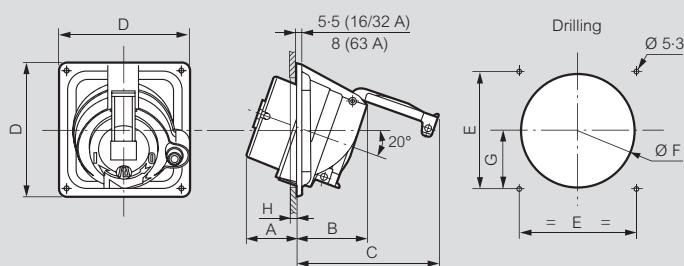

	Material	Weight (kg)	A (mm)	B (mm)	C (mm)	D (mm)	E (mm)	F (mm)		G (mm)	H (mm)
								min.	max.		max.
LV 16 A											
2 P + ⊥	Plastic	0.42	46	70	132	115	100	92	98	46	6 to 10
3 P + ⊥	Plastic	0.48	46	70	138	115	100	92	96	46	6 to 10
	Metal	1.33									
3 P + N + ⊥	Plastic	0.57	46	75	156	125	110	102	106	51.5	7
	Metal	1.47									
LV 32 A											
2 P + ⊥	Plastic	0.57	54	77	153	143	125	115	122	58.5	10 to 20
3 P + ⊥	Plastic	0.61	54	77	153	143	125	115	122	58.5	10 to 20
	Metal	1.5									
3 P + N + ⊥	Plastic	0.65	55	79	169	143	125	119	122	58.5	9 to 13
	Metal	1.8									
LV 63 A											
3 P + ⊥	Plastic	0.95	55	99	205	143	125	120	122	59.5	10 to 20
	Metal	1.85									
3 P + N + ⊥	Plastic	0.98	55	99	205	143	125	120	122	59.5	10 to 20
	Metal	2.2									

■ Accessories

Auxiliary contacts (-20 °C to +80 °C)

Prisinter sockets can accommodate two c/o auxiliary contacts (late make/early break) Cat. No. 0521 96 p. 156

These may be used to signal to a central control/monitoring station or control a contactor to remove load

Padlockable cover in closed position



HYPRA[®]

plugs and sockets

The Hypra range is aimed at installations where maximum durability is a must... including the nuclear, chemical and process industries.

The highest levels of protection and reliability

Available in IP44 and IP66/67-55 rated versions and manufactured in Polyamide 6, Hypra plugs and sockets are ideal for use in harsh and demanding environments.

The plastic units are IK09 rated, while the class leading metal units are IK10 rated – the highest rating for impact.

FEATURES:

- **Integrated cable gland on entire IP66/67-55 range** - providing the highest levels of ingress protection
- **Captive, slotted connection screws** - for fast secure connections
- **Nickel-plated brass pins and contact sleeves** - creating high quality, reliable connections
- **Captive, stainless steel external screws** - maximise durability
- **Double jaw cable clamps** - provide powerful cable fastening
- **Available in 2 ranges** - IP44 and IP66/67-55



HYPRA PLUGS AND SOCKETS - options for every application



PANEL AND SURFACE MOUNTING SOCKETS

CURRENT RATING - 16A, 32A, 63A, 125A

VOLTAGES - 20-25V, 20-50V, 110V, 240V, 400V

PIN CONFIG - 2P, 3P, 2P+E, 3P+E, 3P+N+E

IP RATING - IP44, IP66/67-55

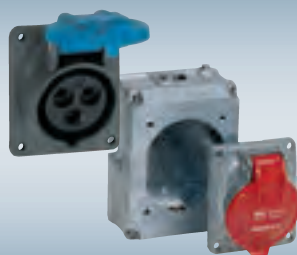

MOBILE SOCKETS, STRAIGHT AND ANGLED PLUGS

CURRENT RATING - 16A, 32A, 63A, 125A

VOLTAGES - 20-25V, 20-50V, 110V, 240V, 400V

PIN CONFIG - 2P, 3P, 2P+E, 3P+E, 3P+N+E

IP RATING - IP44, IP66/67-55



APPLIANCE INLETS

CURRENT RATING - 16A, 32A, 63A, 125A

VOLTAGES - 20-25V, 20-50V, 110V, 240V, 400V

PIN CONFIG - 2P, 3P, 2P+E, 3P+E, 3P+N+E

IP RATING - IP44, IP66/67-55



TECHNICAL DATA

APPROVALS:

BS EN 60309-1, BS EN 60309-2, BS EN 60529 (IP), BS EN 62262 (IK)

Products are interchangeable with other manufacturers' products that meet BS EN 60309-2

PROTECTION:

IP44 and IP66/67-55 ranges available

IK09 for plastic products

IK10 for metal products

SELF EXTINGUISHING:

850°C for insulated parts, 650°C for housing

OPERATING TEMPERATURE:

-50°C to +100°C

UNDERSTANDING THE IP66/IP67-55 RATING

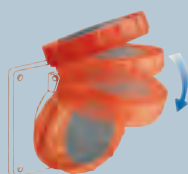

IP 55 assured automatically with cover closed without locking ring secured

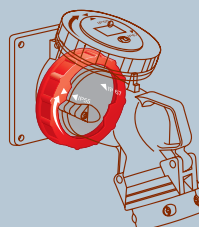

IP 55 guaranteed with IP 66/67-55 plug inserted and cover in place over spigot on plug

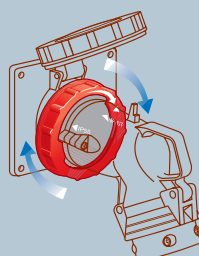

IP 66/67-55 obtained with locking ring secured

Hypra® plugs and sockets IP 44 - ELV 16 A and LV 16/32/63 A

selection chart

HYPRAS® PLUGS AND SOCKETS IP 44 - ELV 16 A AND LV 16/32/63 A												
<p>Conform to : BS EN 60309-1, BS EN 60309-2, IEC 60309-1 and IEC 60309-2 IP 44 according to BS EN 60529 and IEC 60529 IK 09 plastic IK 10 metal according to BS EN 62262 and IEC 62262 Self-extinguishing : 850 °C for insulated parts 650 °C for housing - conforms to BS EN 60695-2-10 and IEC 60695-2-10 Temp. rating : -50 °C to +100 °C</p> <p> Technical information and dimensions p. 165-167</p>			PANEL MOUNTING SOCKETS			SURFACE MOUNTING SOCKETS		THROUGH ENTRY SURFACE MOUNTING SOCKETS	MOBILE SOCKETS	STRAIGHT PLUGS	PANEL APPLIANCE INLETS	
			(Back boxes sold separately)								(Covers available, see bottom of page)	
ELV			METAL	PLASTIC	MODULAR ¹	METAL	PLASTIC	PLASTIC	PLASTIC	PLASTIC	PLASTIC	
20 to 25 V 50/60 Hz	16 A	2 P	-	0524 01	-	-	0524 01+ 0524 19	-	0524 61	0524 21	-	
		3 P	-	0524 02	-	-	0524 02+ 0524 19	-	0524 62	0524 22	-	
20 to 50 V D.C. ≍	16 A	2 P	-	0524 05	-	-	0524 05+ 0524 19	-	-	0524 25	-	
LV												
100 to 130 V 50/60 Hz	16 A	2 P + ⊥	0519 30	0519 20	0519 19	-	0519 20+ 0520 29	0519 20+ 0520 89	0519 80	0519 40	0519 70	
200 to 250 V 50/60 Hz	16 A	2 P + ⊥	0520 32	0520 22	0520 18	-	0520 22+ 0520 29	0520 22+ 0520 89	0520 82	0520 42	0521 72	
		3 P + ⊥	0520 33	0520 23	0520 19	-	0520 23+ 0522 29	0520 23+ 0522 89	0520 83	0520 43	0520 73	
		3 P + N + ⊥	0520 34	0520 24	-	-	0520 24+ 0522 29	0520 24+ 0522 89	0520 84	0520 44	-	
	32 A	2 P + ⊥	0527 32	-	0527 18	-	0527 18+ 0529 40	0527 18+ 0529 90	0527 82	0527 42	0528 72	
		3 P + ⊥	0527 33	-	0527 19	-	0527 19+ 0529 40	0527 19+ 0529 90	0527 83	0527 43	-	
380 to 415 V 50/60 Hz	16 A	3 P + ⊥	0522 33	0522 23	0522 19	0522 33+ 0522 39	0522 23+ 0522 29	0522 23+ 0522 89	0522 83	0522 43	0521 73	
		3 P + N + ⊥	0522 34	0522 24	0522 20	0522 34+ 0522 39	0522 24+ 0522 29	0522 24+ 0522 89	0522 84	0522 44	0521 74	
	32 A	3 P + ⊥	0529 33	-	0529 19	0529 33+ 0529 39	0529 19+ 0529 40	0529 19+ 0529 90	0529 83	0529 43	0528 73	
		3 P + N + ⊥	0529 34	-	0529 20	0529 34+ 0529 39	0529 20+ 0529 40	0529 20+ 0529 90	0529 84	0529 44	0528 74	
	63 A	3 P + ⊥	0538 33	0538 23	-	-	-	-	0538 83	0538 43	0537 73	
		3 P + N + ⊥	0538 34	0538 24	-	-	0537 24	-	0538 84	0538 44	0537 74	

1 : Modular sockets are manufactured from plastic with 70 x 70 mm fixing centres

For pack quantities, p. 163-164

Modular sockets have
70 x 70mm fixing centres
across 16 A and 32 A range
p. 163-164



APPLIANCE INLET COVERS

Conform to :
BS EN 60309-1,
BS EN 60309-2,
IEC 60309-1 and
IEC 60309-2
Material : Rubber
Self-extinguishing :
650 °C
Temp. rating :
-20 °C to +40 °C



Dimensions
p. 166

		Pack	Cat. Nos.
16 A	2 P + ⊥	10	0521 25
	3 P + ⊥	5	0521 26
	3 P + N + ⊥	5	0521 27
32 A	2 P + ⊥	5	0521 27
	3 P + ⊥	5	0521 27
	3 P + N + ⊥	5	0527 99
63 A	3 P + ⊥	5	0536 99
	3 P + N + ⊥	5	0536 99

Hypra® IP 44 - ELV 16 A and LV 16 A

metal and plastic plugs and sockets



0520 22



0522 19



0522 44

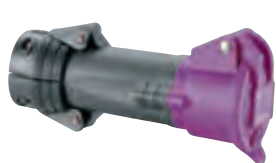

0524 61



0520 82



0521 73 + 0522 89



0522 33 + 0522 39

Technical information and dimensions **p. 165-167**
Conformity to International Standards **p. 198**

Conform to BS EN 60309-1, BS EN 60309-2, IEC 60309-1 and IEC 60309-2
IP 44 according to BS EN 60529 and IEC 60529
IK 09 plastic
IK 10 metal according to BS EN 62262 and IEC 62262
Self-extinguishing : 850 °C for insulated parts
650 °C for housing - conforms to BS EN 60695-2-10 and IEC 60695-2-10
Temp. rating : -50 °C to +100 °C
Nickel plated brass contacts

Pack	Cat. Nos.		Panel mounting sockets 16 A	
	ELV			
	Metal	Plastic		20 to 25 V~
5		0524 01	2 P	
1		0524 02	3 P	
				20 to 50 V~
1		0524 05	2 P	
	LV			
	Metal	Plastic		100 to 130 V~
1	0519 30	0519 20	2 P + ⊥	
				200 to 250 V~
1 5	0520 32	0520 22	2 P + ⊥	
1	0520 33	0520 23	3 P + ⊥	
1	0520 34	0520 24	3 P + N + ⊥	
				380 to 415 V~
1 5	0522 33	0522 23	3 P + ⊥	
1	0522 34	0522 24	3 P + N + ⊥	
	Plastic modular			100 to 130 V~
1		0519 19	2 P + ⊥	
				200 to 250 V~
5		0520 18	2 P + ⊥	
1		0520 19	3 P + ⊥	
				380 to 415 V~
5		0522 19	3 P + ⊥	
1		0522 20	3 P + N + ⊥	

Pack	Cat. Nos.		Mobile sockets 16 A	
	ELV			
	Plastic			20 to 25 V~
1		0524 61	2 P	
1		0524 62	3 P	
	LV			
	Plastic			100 to 130 V~
1		0519 80	2 P + ⊥	
				200 to 250 V~
1		0520 82	2 P + ⊥	
1		0520 83	3 P + ⊥	
1		0520 84	3 P + N + ⊥	
				380 to 415 V~
1		0522 83	3 P + ⊥	
1		0522 84	3 P + N + ⊥	

Pack	Cat. Nos.		Straight plugs 16 A	
	ELV			
	Plastic			20 to 25 V~
5		0524 21	2 P	
1		0524 22	3 P	
				20 to 50 V~
1		0524 25	2 P	
	LV			
	Plastic			100 to 130 V~
1		0519 40	2 P + ⊥	
				200 to 250 V~
5		0520 42	2 P + ⊥	
1		0520 43	3 P + ⊥	
1		0520 44	3 P + N + ⊥	
				380 to 415 V~
5		0522 43	3 P + ⊥	
1		0522 44	3 P + N + ⊥	

Pack	Cat. Nos.		Panel appliance inlets 16 A	
	LV			
	Plastic		Covers available, see opposite	
				100 to 130 V~
1		0519 70	2 P + ⊥	
				200 to 250 V~
1		0521 72	2 P + ⊥	
1		0520 73	3 P + ⊥	
				380 to 415 V~
1		0521 73	3 P + ⊥	
1		0521 74	3 P + N + ⊥	

Pack	Cat. Nos.		Back boxes	
	Metal			
	Plastic		Surface mounting boxes	
5		0524 19	For ELV 2 P / 3 P sockets	
5		0520 29	For LV 16 A 2 P + ⊥ sockets	
5	0522 39	0522 29	For LV 16 A 3 P + ⊥ / 3 P + N + ⊥ sockets	
	Plastic		Through entry surface mounting boxes	
1		0520 89	For LV 16 A 2 P + ⊥ sockets	
5		0522 89	For LV 16 A 3 P + ⊥ / 3 P + N + ⊥ sockets	

Pack	Cat. Nos.		Appliance inlet covers	
10		0521 25	For LV 16 A 2 P + ⊥ appliance inlets	
5		0521 26	For LV 16 A 3 P + ⊥ appliance inlets	
5		0521 27	For LV 16 A 3 P + N + ⊥ appliance inlets	

Hypra® IP 44 - LV 32 A

metal and plastic plugs and sockets



Technical information and dimensions **p. 165-167**
Conformity to International Standards **p. 198**

Conform to BS EN 60309-1, BS EN 60309-2, IEC 60309-1 and IEC 60309-2
IP 44 according to BS EN 60529 and IEC 60529
IK 09 plastic
IK 10 metal according to BS EN 62262 and IEC 62262
Self-extinguishing : 850 °C for insulated parts
650 °C for housing - conforms to BS EN 60695-2-10 and IEC 60695-2-10
Temp. rating : -50 °C to +100 °C
Nickel plated brass contacts

Pack	Cat. Nos.		Panel mounting sockets 32 A
	Metal	Modular	200 to 250 V~
1	0527 32	0527 18	2 P + ⊥
1	0527 33	0527 19	3 P + ⊥
			380 to 415 V~
1	0529 33	0529 19	3 P + ⊥
1	0529 34	0529 20	3 P + N + ⊥

Pack	Cat. Nos.	Mobile sockets 32 A
	Plastic	200 to 250 V~
1	0527 82	2 P + ⊥
1	0527 83	3 P + ⊥
		380 to 415 V~
1	0529 83	3 P + ⊥
1	0529 84	3 P + N + ⊥

Pack	Cat. Nos.	Straight plugs 32 A
	Plastic	200 to 250 V~
1	0527 42	2 P + ⊥
1	0527 43	3 P + ⊥
		380 to 415 V~
1	0529 43	3 P + ⊥
1	0529 44	3 P + N + ⊥

Pack	Cat. Nos.	Panel appliance inlets 32 A
	Plastic	Covers available, see below 200 to 250 V~
1	0528 72	2 P + ⊥
		380 to 415 V~
1	0528 73	3 P + ⊥
1	0528 74	3 P + N + ⊥

Pack	Cat. Nos.	Back boxes
	Metal	Surface mounting boxes
1	0529 39	For LV 32 A 2 P + ⊥ / 3 P + ⊥ / 3 P + N + ⊥ sockets
	Plastic	Through entry surface mounting boxes
1	0529 90	For LV 32 A 2 P + ⊥ / 3 P + ⊥ / 3 P + N + ⊥ sockets

Pack	Cat. Nos.	Appliance inlet covers
5	0521 27	For LV 32 A 2 P + ⊥ / 3 P + ⊥ appliance inlets
5	0527 99	For LV 32 A 3 P + N + ⊥ appliance inlets

Hypra® IP 44 - LV 63 A

metal and plastic plugs and sockets



Technical information and dimensions **p. 165-167**
Conformity to International Standards **p. 198**

Conform to BS EN 60309-1, BS EN 60309-2, IEC 60309-1 and IEC 60309-2
IP 44 according to BS EN 60529 and IEC 60529
IK 09 plastic
IK 10 metal according to BS EN 62262 and IEC 62262
Self-extinguishing : 850 °C for insulated parts
650 °C for housing - conforms to BS EN 60695-2-10 and IEC 60695-2-10
Temp. rating : -50 °C to +100 °C
Nickel plated brass contacts. 63 A units have a pilot pin

Pack	Cat. Nos.		Panel mounting sockets 63 A
	Metal	Plastic	380 to 415 V~
1	0538 33	0538 23	3 P + ⊥
1	0538 34	0538 24	3 P + N + ⊥

Pack	Cat. Nos.	Surface mounting socket 63 A
	Plastic	380 to 415 V~
1	0537 24	3 P + N + ⊥

Pack	Cat. Nos.	Mobile sockets 63 A
	Plastic	380 to 415 V~
1	0538 83	3 P + ⊥
1	0538 84	3 P + N + ⊥

Pack	Cat. Nos.	Straight plugs 63 A
	Plastic	380 to 415 V~
1	0538 43	3 P + ⊥
1	0538 44	3 P + N + ⊥

Pack	Cat. Nos.	Panel appliance inlets 63 A
	Plastic	380 to 415 V~
1	0537 73	3 P + ⊥
1	0537 74	3 P + N + ⊥

Pack	Cat. Nos.	Appliance inlet cover
5	0536 99	For LV 63 A 3 P + ⊥ / 3 P + N + ⊥ appliance inlets

Hypra® IP 44 - ELV 16 A and LV 16/32/63 A

metal and plastic plugs and sockets (continued)

Hypra® IP 44 - ELV 16 A and LV 16/32 A

surface mounting back boxes

■ Dimensions (continued)

Straight plugs IP 44

ELV 16 A, LV 16/32 A (p. 163-164)

LV 63 A (p. 164)

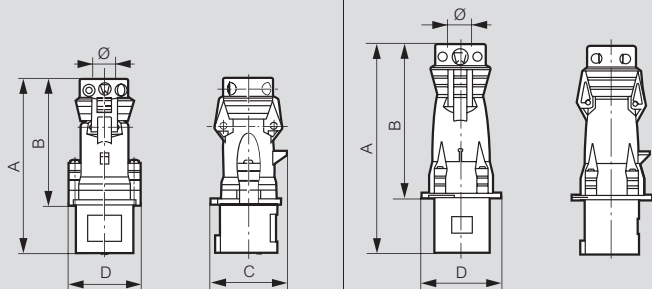

	Material	Weight (kg)	Dimensions (mm)				Ø Clamping and grip (mm)
			A	B	C	D	
ELV 16 A							
2 P + ⊥	Plastic	0-180	142	107	62	55	8-5 to 22
LV 16 A							
2 P + ⊥	Plastic	0-150	135	100	57	55	8 to 15
3 P + ⊥	Plastic	0-175	139	103	65	60	8 to 15
3 P + N + ⊥	Plastic	0-210	154	118	73	66	10 to 18
LV 32 A							
2 P + ⊥	Plastic	0-260	164	119	78	70-5	10 to 18
3 P + ⊥	Plastic	0-260	164	119	78	70-5	12 to 22
3 P + N + ⊥	Plastic	0-300	170	125	86	77	12 to 22
LV 63 A							
3 P + ⊥	Plastic	0-640	255	188-5	-	102	18-5 to 29
3 P + N + ⊥	Plastic	0-700	255	188-5	-	102	20-5 to 32

Panel appliance inlets IP 44¹ (p. 163-164)

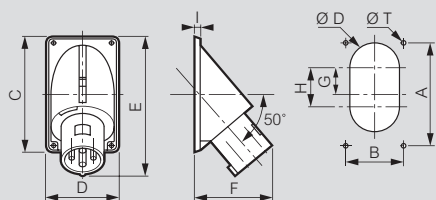

	Material	Weight (kg)	Drilling (mm)				Dimensions (mm)														
			A	B	ØT	ØD	G	H	C	D	E	F	I								
LV 16 A																					
2 P + ⊥	Plastic	0-140	94	62	4-5	40	-	-	104	72	121	78	6								
3 P + ⊥	Plastic	0-160	109	83	4-5	40	-	-	120	94	135	86	6								
3 P + N + ⊥	Plastic	0-190	109	83	4-5	40	-	-	120	94	139	86	6								
LV 32 A																					
2 P + ⊥	Plastic	0-280	149	90	5-5	40	-	-	160	101	176	111	6								
3 P + ⊥	Plastic	0-280	149	90	5-5	40	-	-	160	101	176	111	6								
3 P + N + ⊥	Plastic	0-320	149	90	5-5	40	-	-	160	101	174	108	6								
LV 63 A																					
3 P + ⊥	Plastic	0-630	163	93	6-5	80	42	62	183	113	221	120	8								
3 P + N + ⊥	Plastic	0-690	163	93	6-5	80	42	62	183	113	221	120	8								

Appliance inlet covers (p. 163-164)

16/32/63 A

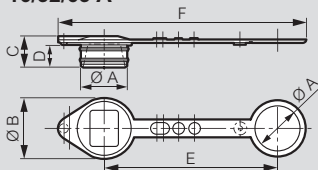

Cat. Nos.	Product	Ø A (mm)	Ø B (mm)	C (mm)	D (mm)	E (mm)	F (mm)
0521 25	16 A - 2 P + ⊥	38	50	26	18	140	200
0521 26	16 A - 3 P + ⊥	43	55	26	18	150	215
0521 27	16 A - 3 P + N + ⊥ 32 A - 2 P + ⊥, 3 P + ⊥	50	62	26	18	160	232
0527 99	32 A - 3 P + N + ⊥	56	68	26	18	167	248
0536 99	63 A - 3 P + ⊥, 3 P + N + ⊥	62	74	26	18	205	290

1 : Wiring diagram for 63 A shown on p. 167

■ Dimensions

Reversible boxes for surface mounting sockets

Boxes can be rotated to aid entry

ELV 16 A, LV 16 A (p. 163)

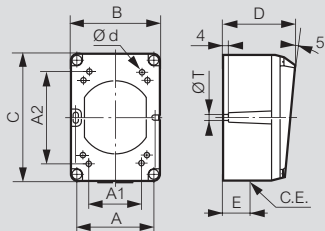

A1 and A2 : optional blind fixing points
Metal boxes are equipped with :
- 2 internal linked earth terminals
and 1 external earth terminal
- 1 tulip earth pin connection
between base and cover

LV 32 A (p. 164)

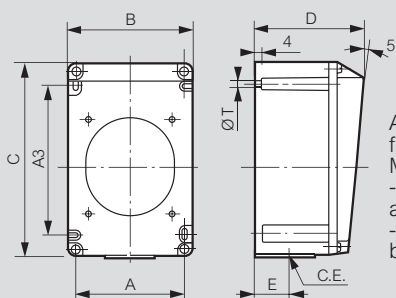

A1 and A2 : optional blind fixing points
Metal boxes are equipped with :
- 2 internal linked earth terminals
and 1 external earth terminal
- 1 tulip earth pin connection
between base and cover

Back boxes → Panel mounting sockets ↓	Material	Weight (kg)	Fixings (mm)				Dimensions (mm)					C.E.	
			A1	A2	Ød	A	A3	ØT	B	C	D	E	
ELV 16 A/32 A													
2 P	Plastic	0-115	51	68	4-2	64	-	5-3	74	106	58	20	M25
LV 16 A													
2 P + ⊥	Plastic	0-115	51	68	4-2	64	-	5-3	74	106	58	20	M20
3 P + ⊥	Plastic	0-160	68	68	4-2	85	-	5-3	96	122	60	22	M20
	Metal	0-520											
3 P + N + ⊥	Plastic	0-160	68	68	4-2	85	-	5-3	96	122	60	22	M20
	Metal	0-520											
LV 32 A													
2 P + ⊥	Plastic	0-340	-	-	-	90	125	5-3	102	162	90	26	M25
	Metal	0-910											
3 P + ⊥	Plastic	0-340	-	-	-	90	125	5-3	102	162	90	26	M25
	Metal	0-910											
3 P + N + ⊥	Plastic	0-340	-	-	-	90	125	5-3	102	162	90	26	M25
	Metal	0-910											

Hypra® IP 44 - LV 16/32 A

through entry surface mounting boxes

■ Technical information

IK 09 (plastic) according to BS EN 62262 and IEC 62262
 Contacts : nickel plated brass with stainless steel connection pins

■ Dimensions

Reversible boxes for surface mounting

LV 16 to 32 A (p. 163-164)

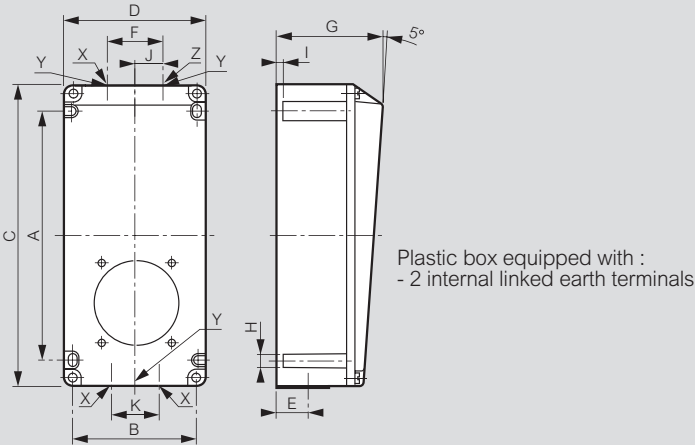

Back boxes → Panel mounting sockets ↓	Material	Weight (kg)	Fixings (mm)			Dimensions (mm)												
			A	B	H	C	D	E	F	G	I	J	K	X	Y	Z		
16 A																		
2 P + ⊕	Plastic	0.330	145	74	5.3	182	86	22	34	75	4	-	-	-	M20	-		
3 P + ⊕	Plastic	0.330	145	74	5.3	182	86	22	34	75	4	-	-	-	M20	-		
3 P + N + ⊕	Plastic	0.330	145	74	5.3	182	86	22	34	75	4	-	-	-	M20	-		
32 A																		
2 P + ⊕	Plastic	0.670	234	117	5.3	270	130	30	50	110	4	-	-	-	M25	-		
3 P + ⊕	Plastic	0.670	234	117	5.3	270	130	30	50	110	4	-	-	-	M25	-		
3 P + N + ⊕	Plastic	0.670	234	117	5.3	270	130	30	50	110	4	-	-	-	M25	-		

Note : Through entry boxes provide extra wiring space but not looping terminals

Hypra® IP 44 - LV 63 A

pilot pin connection

■ Example of 63 A 3 P + ⊕ and 3 P + N + ⊕ pilot pin connection

The pilot pin enables the load to be removed prior to the separation of the phase pins, when the circuit is routed via a contactor

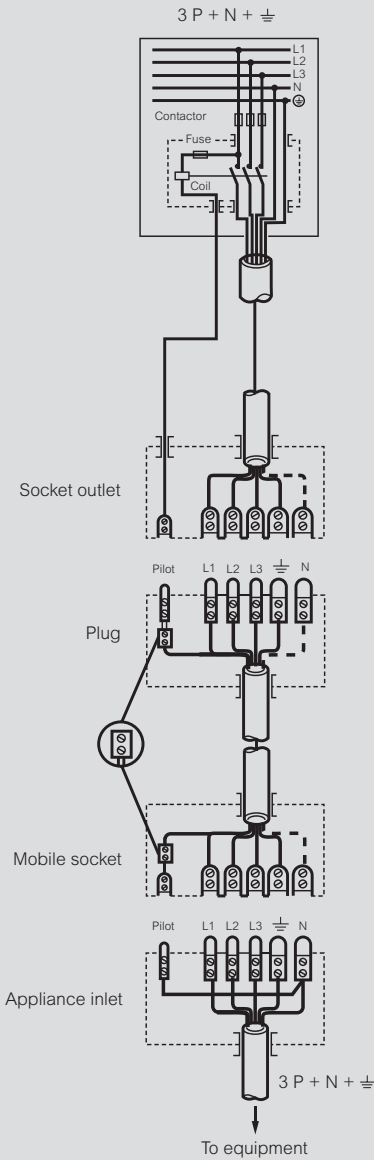

The pilot pin connection accepts 2.5-6 mm² flexible or up to 10 mm² rigid conductor. It is the small centre pin in the connection

■ Pilot cabling

	63 A	Conductors type
Plugs and mobile sockets	2.5 to 6	Flexible
Surface and panel mounting sockets	2.5 to 10	Rigid

HYPRAS® PLUGS AND SOCKETS IP 66/67-55 - LV 16/32/63/125 A									
<p>Conform to : BS EN 60309-1, BS EN 60309-2, IEC 60309-1 and IEC 60309-2 IP according to BS EN 60529 and IEC 60529 IK 09 Self-extinguishing : 850 °C for insulated parts 650 °C for housing Stainless steel external screws Temp. rating : -50 °C to +100 °C 63/125 A units have a pilot pin</p> <p> Technical information and dimensions p. 171-173</p>	PANEL MOUNTING SOCKETS		SURFACE MOUNTING SOCKETS		THROUGH ENTRY SURFACE MOUNTING SOCKETS	MOBILE SOCKETS	STRAIGHT PLUGS	ANGLED PLUGS	
	inclined outlets		modular ¹ with single fixing centres		(Back boxes sold separately)				
LV									
100 to 130 V 50/60 Hz	16 A	2P + ⊥	0511 25	–	0511 25 + 0520 29	0511 25 + 0520 89	0511 75	0511 55	–
200 to 250 V 50/60 Hz	16 A	2P + ⊥	0511 26	0511 46	0511 26 + 0520 29	0511 26 + 0520 89	0511 76	0511 56	0511 06
	32 A	2P + ⊥	–	0530 46	0530 46 + 0529 40	0530 46 + 0529 90	0530 76	0530 56	0530 06
380 to 415 V 50/60 Hz	16 A	3P + ⊥	0511 30	0511 50	0511 30 + 0522 29	0511 30 + 0522 89	0511 80	0511 60	0511 10
		3P + N + ⊥	0511 31	0511 51	0511 31 + 0522 29	0511 31 + 0522 89	0511 81	0511 61	0511 11
	32 A	3P + ⊥	–	0530 50	0530 50 + 0529 40	0530 50 + 0529 90	0530 80	0530 60	0530 10
		3P + N + ⊥	–	0530 51	0530 51 + 0529 40	0530 51 + 0529 90	0530 81	0530 61	0530 11
380 to 415 V 50/60 Hz	63 A	3P + ⊥	0594 27	–	0594 37	–	0594 87	0594 47	–
		3P + N + ⊥	0594 28	–	0594 38	–	0594 88	0594 48	–
	125 A	3P + ⊥	0595 12	–	0595 02	–	0595 32	0595 22	–
		3P + N + ⊥	0595 13	–	0595 03	–	0595 33	0595 23	–

1 : 70 x 70 mm fixing centres

Complete range from 16 A to 125 A : IP 55 (minimum) guaranteed

IP 55 assured automatically with cover flap down without locking ring secured

IP 55 guaranteed with IP 66/67-55 plug inserted and cover in place over spigot on plug

IP 66/67-55 obtained with locking ring secured

For pack quantities, p. 169-170

Modular sockets have
70 x 70mm fixing centres
across 16 A and 32 A range
p. 169-170



Hypra® IP 66/67-55 - LV 16 A

plastic plugs and sockets



Technical information and dimensions **p. 171-173**
 Conformity to International Standards **p. 198**

Conform to BS EN 60309-1, BS EN 60309-2, IEC 60309-1 and IEC 60309-2
 IP according to BS EN 60529 and IEC 60529
 IK 09

Self-extinguishing : 850 °C for insulated parts, 650 °C for housing
 Stainless steel external screws - Nickel plated brass contacts
 Temp. rating : -50 °C to +100 °C

Pack	Cat. Nos.		Panel mounting sockets 16 A
1	Plastic	Modular	Plastic version can be used with back boxes to create surface mounting sockets (modular version is not compatible with back boxes)
			100 to 130 V~ 2 P + ⊥
			200 to 250 V~ 2 P + ⊥
5 1	0511 25	0511 46	380 to 415 V~ 2 P + ⊥
1	0511 26	0511 50	3 P + ⊥
1	0511 30	0511 51	3 P + N + ⊥
1	0511 31	0511 51	3 P + N + ⊥

Pack	Cat. Nos.	Mobile sockets 16 A
1	0511 75	100 to 130 V~ 2 P + ⊥
1	0511 76	200 to 250 V~ 2 P + ⊥
1	0511 80	380 to 415 V~ 3 P + ⊥
1	0511 81	3 P + N + ⊥

Pack	Cat. Nos.	Straight plugs 16 A
1	0511 55	100 to 130 V~ 2 P + ⊥
1	0511 56	200 to 250 V~ 2 P + ⊥
5	0511 60	380 to 415 V~ 3 P + ⊥
5	0511 61	3 P + N + ⊥

Pack	Cat. Nos.	Angled plugs 16 A
1	0511 06	200 to 250 V~ 2 P + ⊥
1	0511 10	380 to 415 V~ 3 P + ⊥
1	0511 11	3 P + N + ⊥

Pack	Cat. Nos.	Back boxes
Surface mounting boxes		
5	0520 29	For LV 16 A 2 P + ⊥ sockets
5	0522 29	For LV 16 A 3 P + ⊥ / 3 P + N + ⊥ sockets
Through entry surface mounting boxes		
1	0520 89	For LV 16 A 2 P + ⊥ sockets
5	0522 89	For LV 16 A 3 P + ⊥ / 3 P + N + ⊥ sockets

Hypra® IP 66/67-55 - LV 32 A

plastic plugs and sockets



0530 50 + 0529 40

Technical information and dimensions **p. 171-173**
 Conformity to International Standards **p. 198**

Conform to BS EN 60309-1, BS 60309-2, IEC 60309-1 and IEC 60309-2
 IP according to BS EN 60529 and IEC 60529

IK 09
 Self-extinguishing : 850 °C for insulated parts, 650 °C for housing
 Stainless steel external screws - Nickel plated brass contacts
 Temp. rating : -50 °C to +100 °C

Pack Cat. Nos. Panel mounting sockets (modular) 32 A

Pack	Cat. Nos.	200 to 250 V~	380 to 415 V~
1	Modular 0530 46	2 P + ⊥	
1	0530 50	3 P + ⊥	
1	0530 51		3 P + N + ⊥

Mobile sockets 32 A

Pack	Cat. Nos.	200 to 250 V~	380 to 415 V~
1	0530 76	2 P + ⊥	
1	0530 80	3 P + ⊥	
1	0530 81		3 P + N + ⊥

Straight plugs 32 A

Pack	Cat. Nos.	200 to 250 V~	380 to 415 V~
1	0530 56	2 P + ⊥	
1	0530 60	3 P + ⊥	
1	0530 61		3 P + N + ⊥

Angled plugs 32 A

Pack	Cat. Nos.	200 to 250 V~	380 to 415 V~
1	0530 06	2 P + ⊥	
1	0530 10	3 P + ⊥	
1	0530 11		3 P + N + ⊥

Back boxes

Pack	Cat. Nos.	Surface mounting boxes
1	0529 40	For LV 32 A 2 P + ⊥ / 3 P + ⊥ / 3 P + N + ⊥ sockets
1	0529 90	Through entry surface mounting boxes
		For LV 32 A 2 P + ⊥ / 3 P + ⊥ / 3 P + N + ⊥ sockets

Hypra® IP 66/67-55 - LV 63 and 125 A

plastic plugs and sockets



0594 27



0595 32

Technical information and dimensions **p. 171-173**
 Conformity to International Standards **p. 198**

Conform to BS EN 60309-1, BS 60309-2, IEC 60309-1 and IEC 60309-2
 IP according to BS EN 60529 and IEC 60529

IK 09
 Self-extinguishing : 850 °C for insulated parts, 650 °C for housing
 Stainless steel external screws - Nickel plated brass contacts
 Temp. rating : -50 °C to +100 °C
 LV 63 A and 125 A have a pilot pin

Pack Cat. Nos. Panel mounting sockets 63 and 125 A

Pack	Cat. Nos.		380 to 415 V~
	63 A	125 A	
1	0594 27	0595 12	3 P + ⊥
1	0594 28	0595 13	3 P + N + ⊥

Surface mounting sockets 63 and 125 A

Pack	Cat. Nos.		380 to 415 V~
	63 A	125 A	
1	0594 37	0595 02	3 P + ⊥
1	0594 38	0595 03	3 P + N + ⊥

Mobile sockets 63 and 125 A

Pack	Cat. Nos.		380 to 415 V~
	63 A	125 A	
1	0594 87	0595 32	3 P + ⊥
1	0594 88	0595 33	3 P + N + ⊥

Straight plugs 63 and 125 A

Pack	Cat. Nos.		380 to 415 V~
	63 A	125 A	
1	0594 47	0595 22	3 P + ⊥
1	0594 48	0595 23	3 P + N + ⊥

Hypra® IP 66/67-55 - LV 16/32/63/125 A

plastic plugs and sockets

Technical information

IP 66/67-55 conforms to BS EN 60529 and IEC 60529
Icc 10 kA according to BS EN 60309-1 and IEC 60309-1
Stainless steel external screws - Nickel plated brass contacts
IK according to BS EN 62262 and IEC 62262 : plastic = IK 09

Wiring tested according to BS EN 60309-1

Type	Current	Conductors size (mm ²)	Conductors type
Plugs and mobile sockets	LV 16 A	1 to 2.5	Flexible
	LV 32 A	2.5 to 6	Flexible
	LV 63 A	6 to 16	Flexible
	LV 125 A	16 to 50	Flexible
Panel and surface mounting sockets	LV 16 A	1.5 to 4	Rigid
	LV 32 A	2.5 to 10	Rigid
	LV 63 A	6 to 25	Rigid
	LV 125 A	25 to 70	Rigid

Tightening torque of connection screws

LV 16 A : from 0.7 to 1 Nm
LV 32 A : from 0.7 to 1 Nm
LV 63 A : from 2 to 2.2 Nm for Phase and Earth
from 0.7 to 1 Nm for pilot
LV 125 A : from 3 to 4 Nm for Phase and Earth
from 0.7 to 1 Nm for pilot

Dimensions

Panel mounting sockets IP 66/67-55

LV 16 A (p. 169)

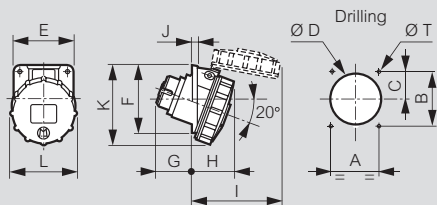

	Weight (kg)	Drilling (mm)					Dimensions (mm)									
		A	B	C	ØD	ØT	E	F	G	H	I	J	K	L		
LV 16 A																
2 P + ⊕	0.140	52	60	33	55	4.2	64	72	40	45	91	5.5	87	72.5		
3 P + ⊕	0.165	60	70	39	63.5	5.2	74	84	41	48	102	5.5	96	81		
3 P + N + ⊕	0.195	60	70	37	70.6	5.2	80	84	42	50	106	5.5	96	86.5		

LV 16/32 A with modular fixings (p. 169-170)

Single fixing centres

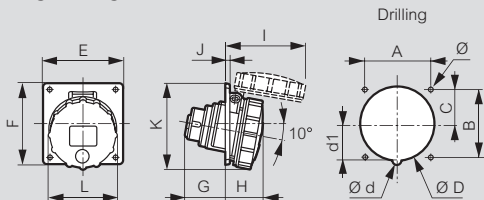

	Weight (kg)	Drilling (mm)							Dimensions (mm)									
		A	B	C	ØD	Ød	d1	E	F	G	H	I	J	K	L	Ø		
LV 16 A																		
2 P + ⊕	0.140	70	70	35	76.2	-	-	84	84	42	39	83	4.5	90	72.5	4.2		
3 P + ⊕	0.165	70	70	35	76.2	-	-	84	84	43	41	98	4.5	93	81	4.2		
3 P + N + ⊕	0.195	70	70	35	76.2	-	-	84	84	43	41	99	4.5	91	86.5	4.2		
LV 32 A																		
2 P + ⊕	0.240	70	70	35	76.2	-	-	84	94	54	50	113	4.5	101	94.5	4.2		
3 P + ⊕	0.240	70	70	35	76.2	-	-	84	94	54	50	113	4.5	101	94.5	4.2		
3 P + N + ⊕	0.270	70	70	35	76.2	8	36	84	94	54	51	120	4.5	103	101	4.2		

Panel mounting sockets IP 66/67-55

LV 63/125 A (p. 170)

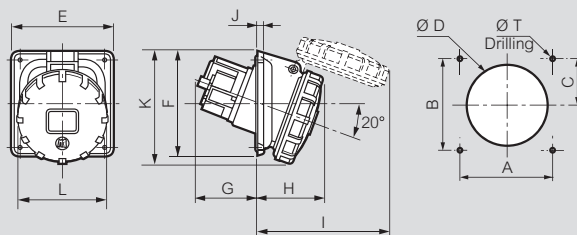

	Weight (kg)	Drilling (mm)					Dimensions (mm)									
		A	B	C	ØD	ØT	E	F	G	H	I	J	K	L		
LV 63 A																
3 P + ⊕	0.71	77	85	42.5	92	6.5	106	106	98	79	158	6	127	113.5		
3 P + N + ⊕	0.77	77	85	42.5	92	6.5	106	106	98	79	158	6	127	113.5		
LV 125 A																
3 P + ⊕	1.40	124	124	62	120	6.5	146	146	84	93	182	8	157	131		
3 P + N + ⊕	1.55	124	124	62	120	6.5	146	146	84	93	182	8	157	131		

Surface mounting sockets IP 66/67-55

LV 63 A (p. 170)

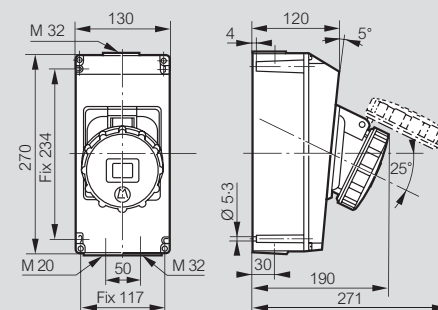

	Weight (kg)
LV 63 A	
3 P + ⊕	1.65
3 P + N + ⊕	1.70

LV 125 A (p. 170)

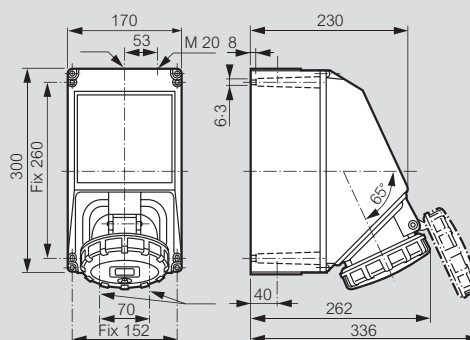

	Weight (kg)
LV 125 A	
3 P + ⊕	3.5
3 P + N + ⊕	3.7

Hypra® IP 66/67-55 - LV 16/32/63/125 A

plastic plugs and sockets (continued)

■ Dimensions (continued)

Mobile sockets IP 66/67-55

LV 16/32 A (p. 169-170)

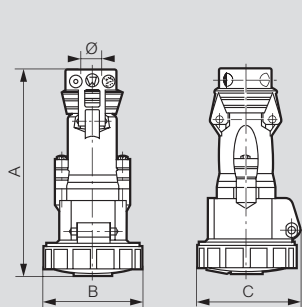

LV 63 A¹ (p. 170)

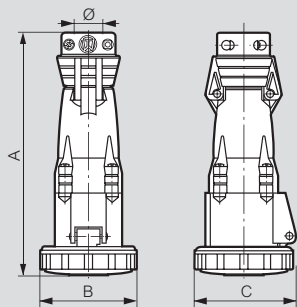

	Material	Weight (kg)	Dimensions (mm)			Ø Clamping and grip (mm)
			A	B	C	
LV 16 A						
2 P + ⊥	Plastic	0-180	150	72-5	75-5	8 to 15
3 P + ⊥	Plastic	0-215	154	81	86	8 to 15
3 P + N + ⊥	Plastic	0-275	189	86-5	89	10 to 18
LV 32 A						
2 P + ⊥	Plastic	0-320	179	94-5	99	10 to 18
3 P + ⊥	Plastic	0-320	179	94-5	99	12 to 22
3 P + N + ⊥	Plastic	0-375	185	101	106	12 to 22
LV 63 A						
3 P + ⊥	Plastic	0-850	278	113-5	119	18-5 to 29
3 P + N + ⊥	Plastic	0-910	278	113-5	119	20-5 to 32

LV 125 A¹ (p. 170)

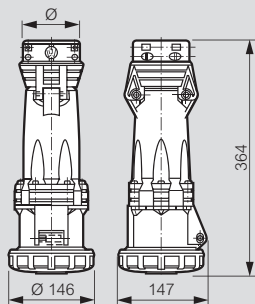

	Weight (kg)	Ø Clamping and grip (mm)
LV 125 A		
3 P + ⊥	1-8	24 to 48
3 P + N + ⊥	2-0	28 to 48

Straight plugs IP 66/67-55

LV 16/32 A (p. 169-170)

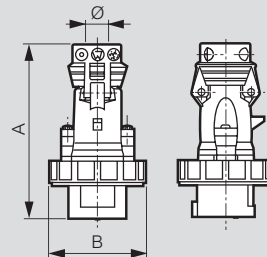

	Weight (kg)	A (mm)	B (mm)	Ø Clamping and grip (mm)
LV 16 A				
2 P + ⊥	0-165	135	72-5	8 to 15
3 P + ⊥	0-195	139	81	8 to 15
3 P + N + ⊥	0-220	154	86-5	10 to 18
LV 32 A				
2 P + ⊥	0-280	164	94-5	10 to 18
3 P + ⊥	0-280	164	94-5	12 to 22
3 P + N + ⊥	0-325	170	101	12 to 22

LV 63 A (p. 170)

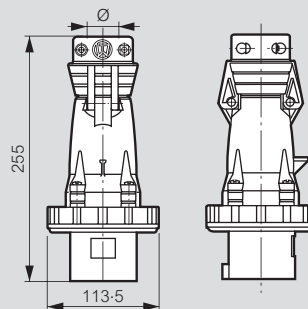

	Weight (kg)	Ø Clamping and grip (mm)
LV 63 A		
3 P + ⊥	0-680	18-5 to 29
3 P + N + ⊥	0-750	20-5 to 32

LV 125 A (p. 170)

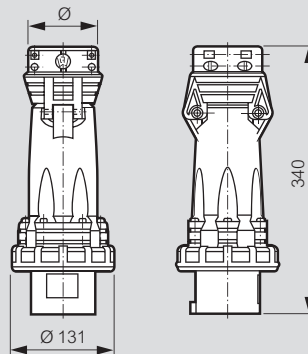

	Weight (kg)	Ø Clamping and grip (mm)
LV 125 A		
3 P + ⊥	1-54	24 to 48
3 P + N + ⊥	1-7	28 to 48

Angled plugs IP 66/67-55

LV 16/32 A (p. 169-170)

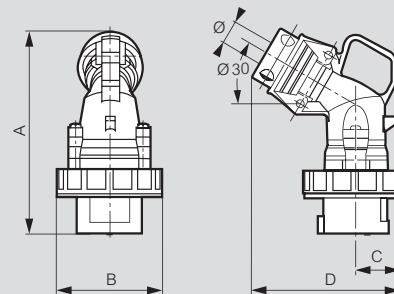

	Weight (kg)	Dimensions (mm)				Ø Clamping and grip (mm)
		A	B	C	D	
LV 16 A						
2 P + ⊥	0-165	136	72-5	29-5	100	8 to 15
3 P + ⊥	0-195	141	81	33-5	105	8 to 15
3 P + N + ⊥	0-220	150	86-5	37-5	114	10 to 18
LV 32 A						
2 P + ⊥	0-280	161	94-5	39-5	116	10 to 18
3 P + ⊥	0-280	161	94-5	39-5	116	12 to 22
3 P + N + ⊥	0-325	167	101	44-5	122	12 to 22

1 : Wiring diagram for 63 A and 125 A shown on p. 173

Hypra® IP 66/67-55 - LV 16/32/63 A

surface mounting and through entry back boxes

Hypra® IP 66/67-55 - LV 63 and 125 A

pilot pin connection

■ Dimensions

Surface mounting boxes

Reversible boxes for surface mounting sockets
Boxes can be rotated to aid entry

LV 16 A (p. 169)

LV 32 A (p. 170)

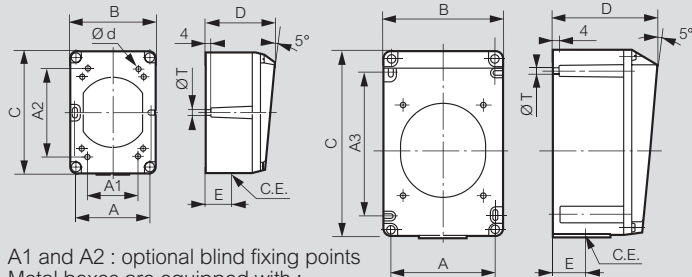

A1 and A2 : optional blind fixing points
Metal boxes are equipped with :
- 2 internal linked earth terminals and 1 external earth terminal
- 1 tulip earth pin connection between base and cover

Back boxes → Panel mounting sockets ↓	Material	Weight (kg)	Fixings (mm)					Dimensions (mm)					C.E.
			A1	A2	ød	A	A3	ØT	B	C	D	E	
LV 16 A													
2 P + ⊕	Plastic	0.115	51	68	4.2	64	-	5.3	74	106	58	20	M20
3 P + ⊕	Plastic	0.160	68	68	4.2	85	-	5.3	96	122	60	22	M20
3 P + N + ⊕	Plastic	0.160	68	68	4.2	85	-	5.3	96	122	60	22	M20
LV 32 A													
2 P + ⊕ / 3 P + ⊕	Plastic	0.340	-	-	-	90	125	5.3	102	162	90	26	M25
3 P + N + ⊕													

Through entry surface mounting boxes

Reversible boxes for surface mounting through entry sockets

LV 16 to 63 A (p. 169-170)

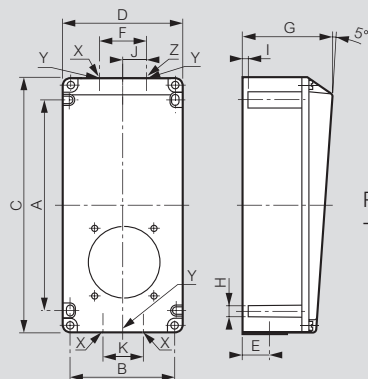

Plastic box equipped with :
- 2 internal linked earth terminals

Back boxes → Panel mounting sockets ↓	Material	Weight (kg)	Fixings (mm)					Dimensions (mm)											
			A	B	H	C	D	E	F	G	I	J	K	X	Y	Z			
16 A																			
2 P + ⊕	Plastic	0.330	145	74	5.3	182	86	22	34	75	4	-	-	-	M20	-			
3 P + ⊕	Plastic	0.440	175	88	5.3	212	100	22	40	77	4	-	-	-	M20	-			
3 P + N + ⊕	Plastic	0.440	175	88	5.3	212	100	22	40	77	4	-	-	-	M20	-			
32 A																			
2 P + ⊕	Plastic	0.670	234	117	5.3	270	130	30	50	120	4	-	-	-	M25	-			
3 P + ⊕	Plastic	0.670	234	117	5.3	270	130	30	50	120	4	-	-	-	M25	-			
3 P + N + ⊕	Plastic	0.670	234	117	5.3	270	130	30	50	120	4	-	-	-	M25	-			
63 A																			
3 P + ⊕	Plastic	2.000	260	152	6.3	300	170	40	-	150	8	50	70	M32	-	M20			
3 P + N + ⊕	Plastic	2.000	260	152	6.3	300	170	40	-	150	8	50	70	M32	-	M20			

Note : Through entry boxes provide extra wiring space but not looping terminals

■ Example of 63/125 A 3 P + ⊕ and 3 P + N + ⊕ pilot pin connection

The pilot pin enables the load to be removed prior to the separation of the phase pins, when the circuit is routed via a contactor

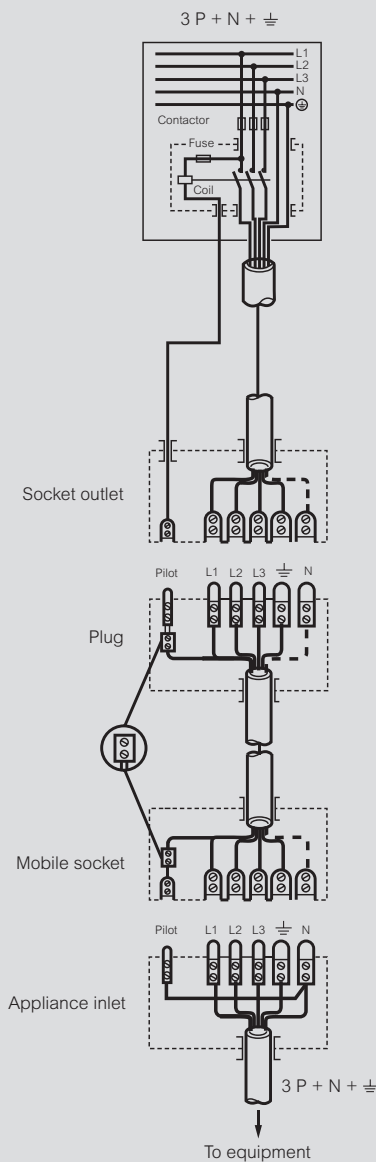

The pilot pin connection accepts 2.5-6 mm² flexible or up to 10 mm² rigid conductor. It is the small centre pin in the connection

■ Pilot cabling

	63 A	Conductors type
Plugs and mobile sockets	2.5 to 6	Flexible
Surface and panel mounting sockets	2.5 to 10	Rigid



P17 TEMPRA PRO

RELIABLY VERSATILE....



Following the success of P17 Tempra, Legrand's new P17 Tempra Pro range of LV 16 and 32A plugs and sockets offers improved strength, safety and a wealth of design features that add simplicity and speed to the installation process. Every aspect of the new P17 Tempra Pro range has been designed with the user in mind.

SAFE AND SOUND

Manufactured from polyamide 6 which boasts high chemical resistance and IK09 impact rating, P17 Tempra Pro is no amateur. And with its impressive temperature resistance qualities and choice of IP44 and IP66/67 protection options, the range is suited to most internal and external applications.



PANEL MOUNTING SOCKETS

CURRENT RATING - 16A, 32A, 63A, 125A
 VOLTAGES - 100 - 415V
 PIN CONFIG - 2P+E, 3P+E, 3P+N+E
 IP RATING - IP44, IP66/67



SURFACE MOUNTING SOCKETS

CURRENT RATING - 16A, 32A, 63A, 125A
 VOLTAGES - 100 - 415V
 PIN CONFIG - 2P+E, 3P+E, 3P+N+E
 IP RATING - IP44, IP66/67



MOBILE SOCKETS
 AND STRAIGHT PLUGS

CURRENT RATING - 16A, 32A, 63A, 125A
 VOLTAGES - 100 - 415V
 PIN CONFIG - 2P+E, 3P+E, 3P+N+E
 IP RATING - IP44, IP66/67



APPLIANCE INLETS

CURRENT RATING - 16A, 32A, 63A, 125A
 VOLTAGES - 100 - 415V
 PIN CONFIG - 2P+E, 3P+E, 3P+N+E
 IP RATING - IP44, IP66/67

TECHNICAL DATA

APPROVALS:

BS EN 60309-1, BS EN 60309-2,
 BS EN 60529 (IP), BS EN 62262 (IK)

PROTECTION:

IP44 and IP66/67-55 ranges available
 IK09

SELF EXTINGUISHING:

850°C for insulated parts, 650°C for housing

OPERATING TEMPERATURE:

-25°C to +40°C





P17 TEMPRA PRO

The new P17 Tempra Pro range has been subject to extensive research to ensure its new ergonomic design not only looks the part but makes life easier for the user. Reliable cable connections are easily created in an optimised wiring space which is protected by a robust exterior that performs well in a wide variety of environments.



Surface mounting sockets



EASY FIXING

Stainless steel captive screws with mixed head (for cross or flat screwdriver) form a strong seal and provide corrosion resistance

CABLE ENTRY

Back boxes have 4 threaded, sealed cable entries on the top and bottom edge and marking on the back for ISO cable glands or conduit



ONE SCREW

A single captive PZ 2 screw, per terminal for simple and easy connections

EASY REMOVAL

Remove active parts from the base for easier wiring and to change the angle of the socket

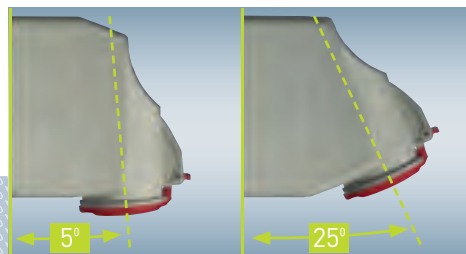

TWO MOUNTING POSITIONS

To solve the problem of limited space, surface mounting sockets offer 2 different mounting positions (5° or 25°) which allow users to adapt to the space available without changing the box



Mobile sockets and straight plugs

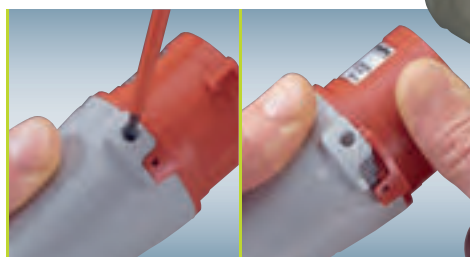
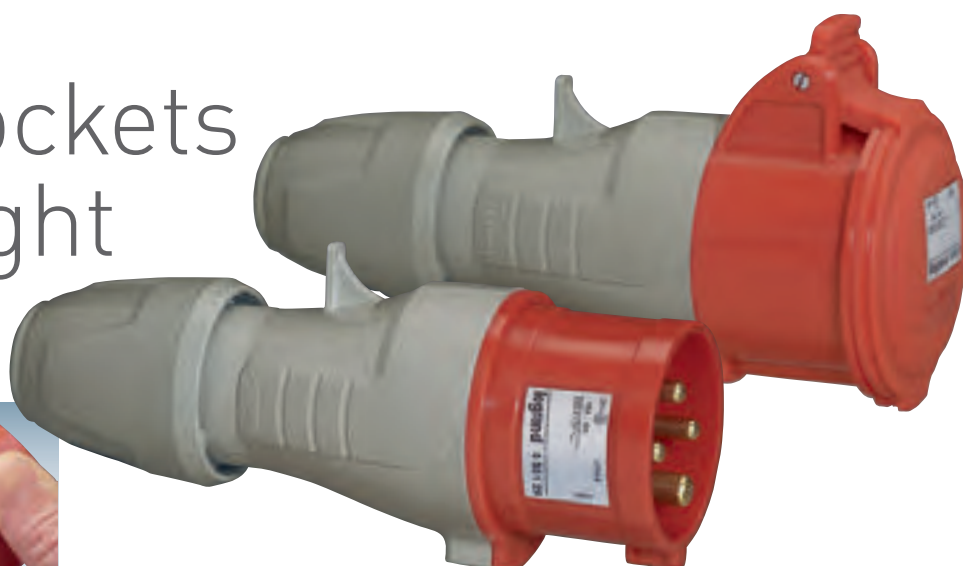

QUICK OPENING / CLOSING SYSTEM

Unlock by pressing with a screwdriver. Marking indicates the location for the locking clip. Open by turning the two parts in opposite directions

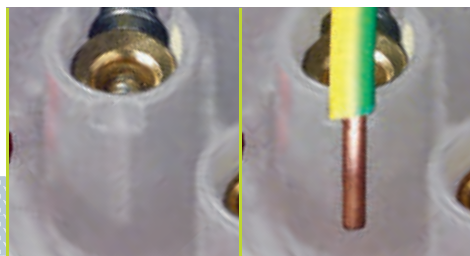

CABLE STRIPPING

Marking allows the user to see quickly the length of cable to be stripped. Option of using cables with ferrules

Innovative design and quality construction make P17 Tempra Pro ideal for a wide variety of applications

WATCH THE P17 TEMPRA PRO VIDEO AT:
[YOUTUBE.COM/LEGRANDTVUK](https://www.youtube.com/legrandtvuk)

P 17 Tempra Pro IP 44 - LV 16 and 32 A

selection chart

<p>Conform to : BS EN 60309-1, IEC 60309-1, BS EN 60309-2 and IEC 60309-2 IP 44 according to BS EN 60529 and IEC 60529 IK 09 according to BS EN 62262 and IEC 62262 Material : polyamide 6 or plastic (see p. 179 for details) Self-extinguishing : 850 °C (support of active parts) / 650 °C (plastic housing)</p> <p> Technical information and dimensions p. 180-181</p>			FUNCTIONS										
			PANEL MOUNTING SOCKETS INCLINED OUTLET	PANEL MOUNTING SOCKETS STRAIGHT OUTLET	SURFACE MOUNTING SOCKETS	MOBILE SOCKETS	STRAIGHT PLUGS	APPLIANCE INLETS					
<p>NEW</p>						<p>NEW</p>		<p>NEW</p>		<p>NEW</p>			
LV													
100 to 130 V 50/60 Hz	16 A	2 P + \downarrow	5551 81	0573 51 ²	5551 51	5551 01	5551 21	0575 81 ¹					
	32 A	2 P + \downarrow	5552 81	–	5552 51	5552 11	5552 31	0582 81 ¹					
200 to 250 V 50/60 Hz	16 A	2 P + \downarrow	5551 84	0573 54 ²	5551 54	5551 04	5551 24	0575 84 ¹					
	32 A	2 P + \downarrow	5552 84	0580 54 ²	5552 54	5552 14	5552 34	0582 84 ¹					
380 to 415 V 50/60 Hz	16 A	3 P + \downarrow	5551 88	0573 58 ²	5551 58	5551 08	5551 28	0575 88 ¹					
		3 P + N + \downarrow	5551 89	0573 59 ²	5551 59	5551 09	5551 29	0575 89 ¹					
	32 A	3 P + \downarrow	5552 88	0580 58 ²	5552 58	5552 18	5552 38	0582 88 ¹					
		3 P + N + \downarrow	5552 89	0580 59 ²	5552 59	5552 19	5552 39	0582 89 ¹					
<p>1 : Appliance inlet covers not supplied, see p. 179 2 : Panel mounting sockets (straight outlet) and appliance inlets are P17 Tempra items which are manufactured from plastic For pack quantities, see p. 179</p>													

ADAPTOR

Conform to BS EN 60309-1,
BS EN 60309-2, IEC 60309-1
and IEC 60309-2
Self-extinguishing : 850 °C
Temp. rating : -15 °C to +40 °C

Dimensions
p. 181

16 A – 230 V

	Pack	Cat. No.
IEC 2 P + \downarrow plug – 13 A 2 P + \downarrow B.S. socket	10	0521 01

P 17 Tempra Pro IP 44 - LV 16 and 32 A

sockets, mobile sockets, plugs and appliance inlets

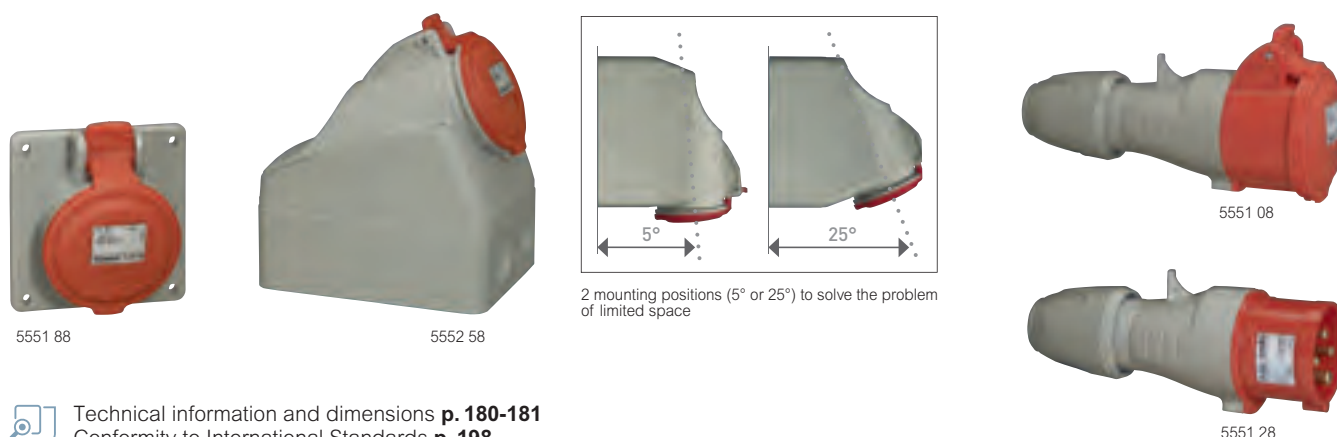

Technical information and dimensions **p. 180-181**
 Conformity to International Standards **p. 198**

Conform to BS EN 60309-1, IEC 60309-1, BS EN 60309-2 and IEC 60309-2
 IP 44 according to BS EN 60529 and IEC 60529
 IK 09 according to BS EN 62262 and IEC 62262
 Material : polyamide 6 or plastic (see below)
 Self-extinguishing : 850 °C (support of active parts) / 650 °C (plastic housing)

Pack	Cat. Nos.	Panel mounting sockets inclined outlet
		Material : polyamide 6 Can be fixed on plain faceplates or pre-drilled (p. 195)
		NEW IP 44
5	16 A 32 A 5551 81 5552 81	100/130 V ~ 2 P + ⊥
10	5551 84 5552 84	200/250 V ~ 2 P + ⊥
10	5551 88 5552 88	380/415 V ~ 3 P + ⊥
10	5551 89 5552 89	3 P + N + ⊥

Pack	Cat. Nos.	Panel mounting sockets straight outlet small flange¹
		Material : plastic Can be fixed only on plain faceplates Cat. No. 0577 15 (p. 195)
		IP 44
5	16 A 32 A 0573 51 0580 51	100/130 V ~ 2 P + ⊥
5	0573 54 0580 54	200/250 V ~ 2 P + ⊥
5	0573 58 0580 58	380/415 V ~ 3 P + ⊥
5	0573 59 0580 59	3 P + N + ⊥

Pack	Cat. Nos.	Surface mounting sockets
		Material : polyamide 6 Two possible angles (5° or 25°)
		NEW IP 44
5	16 A 32 A 5551 51 5552 51	100/130 V ~ 2 P + ⊥
10 5	5551 54 5552 54	200/250 V ~ 2 P + ⊥
10	5551 58 5552 58	380/415 V ~ 3 P + ⊥
10	5551 59 5552 59	3 P + N + ⊥

Pack	Cat. Nos.	Mobile sockets
		Material : polyamide 6 Cable clamping and closing without screws Supplied unlocked
		NEW IP 44
10 5	16 A 32 A 5551 01 5552 11	100/130 V ~ 2 P + ⊥
10	5551 04 5552 14	200/250 V ~ 2 P + ⊥
10	5551 08 5552 18	380/415 V ~ 3 P + ⊥
10	5551 09 5552 19	3 P + N + ⊥

Pack	Cat. Nos.	Straight plugs
		Material : polyamide 6 Cable clamping and closing without screws Supplied unlocked
		NEW IP 44
10 5	16 A 32 A 5551 21 5552 31	100/130 V ~ 2 P + ⊥
10	5551 24 5552 34	200/250 V ~ 2 P + ⊥
10	5551 28 5552 38	380/415 V ~ 3 P + ⊥
10	5551 29 5552 39	3 P + N + ⊥

Pack	Cat. Nos.	Appliance inlets¹
		Material : plastic Covers not supplied with product For appliance inlet covers, see below
		IP 44
10	16 A 32 A 0575 81 0582 81	100/130 V ~ 2 P + ⊥
5	0575 84 0582 84	200/250 V ~ 2 P + ⊥
5	0575 88 0582 88	380/415 V ~ 3 P + ⊥
5	0575 89 0582 89	3 P + N + ⊥

Pack	Cat. Nos.	Appliance inlet covers
		For plugs and appliance inlets:
10	Rubber 0521 25	2 P + ⊥ - 16 A
5	0521 26	3 P + ⊥ - 16 A
5	0521 27	3 P + N + ⊥ - 16 A / 2 P + ⊥ and 3 P + ⊥ - 32 A
5	0527 99	3 P + N + ⊥ - 32 A

¹ : Panel mounting sockets (straight outlet) and appliance inlets are P17 Tempra items which are manufactured from plastic

P 17 Tempra Pro IP 44 - LV 16 and 32 A

sockets and mobile sockets

Technical information

Terminal connection :

- Panel and surface mounting sockets

16 A : max. 1 x 4 mm² rigid

32 A : max. 1 x 10 mm² rigid

- Plugs and mobile sockets:

16 A : max. 1 x 2.5 mm² flexible

32 A : max. 1 x 6 mm² flexible

- Appliance inlets :

16 A : max. 1 x 2.5 mm² rigid

32 A : max. 1 x 6 mm² rigid

IP 44 according to BS EN 60529 and IEC 60529

IK 09 according to BS EN 62262 and IEC 62262

Material : polyamide 6

Self-extinguishing : 850 °C (support of active parts) / 650 °C (plastic housing)

Temp. rating : -25 °C to +40 °C according to IEC 60309-1

Conform to BS EN 60309-1, IEC 60309-1, BS EN 60309-2 and

IEC 60309-2

Dimensions

Panel mounting sockets inclined outlet (p. 179)

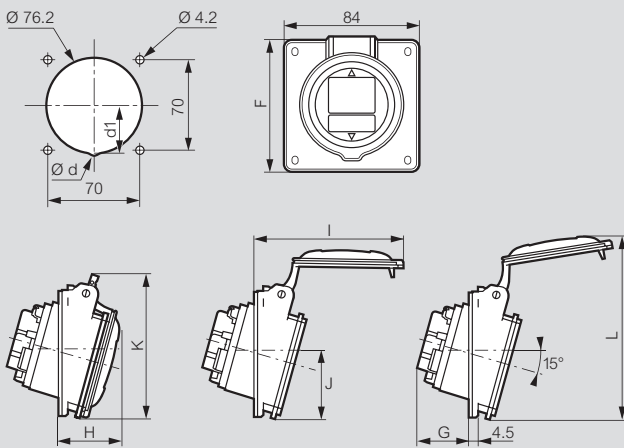

	Ød	d1	F	G	H	I	J	K	L
LV 16 A									
2P+±	-	-	84	33.5	37.5	85	42	88.5	112.5
3P+±	-	-	84	35.5	38.5	93	42	91.5	118.5
3P+N+±	-	-	84	36.5	39.5	100	43.3	97	123.5
LV 32 A									
2P+±	-	-	94	41.5	45.5	110	47	102	131
3P+±	-	-	94	41.5	45.5	110	47	102	131
3P+N+±	8	36	94	42.5	46.5	117	47	107.5	138

Panel mounting socket straight outlet small flange (p. 179)

Cat. No. 0573 54

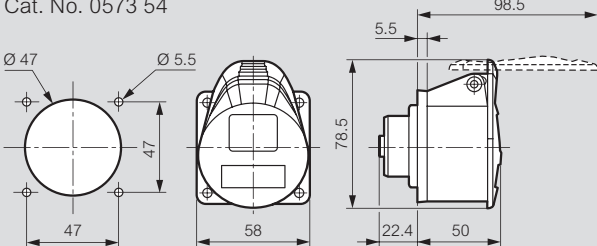

Weight (kg) = 0.105

Surface mounting sockets (p. 179)

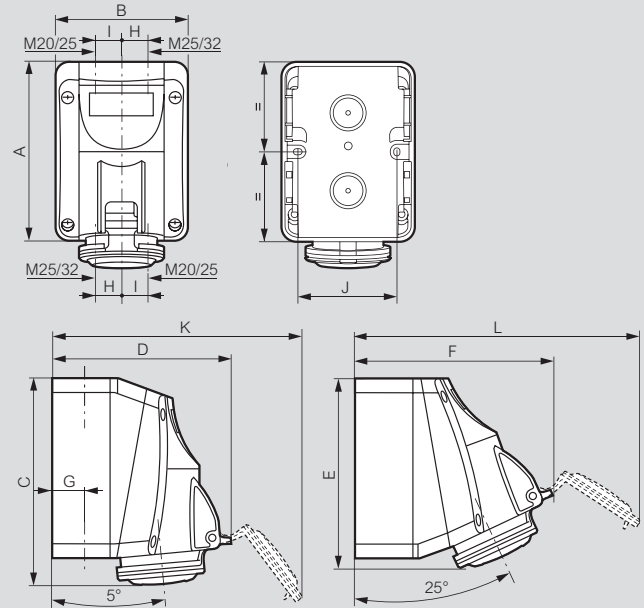

	A	B	C	D	E	F	G	H	I	J	K	L
LV 16 A												
2P+±	125	93	147	126	138	139	22	17	20	70	176	195
3P+±	125	93	147	134	138	147	22	17	20	70	190	210
3P+N+±	125	93	147	140	138	153	22	17	20	70	201	221
LV 32 A												
2P+±	150	113	174	156	163	172	28	22	26	90	220	245
3P+±	150	113	174	156	163	172	28	22	26	90	220	245
3P+N+±	150	113	174	162	163	177	28	22	26	90	230	256

Mobile sockets (p. 179)

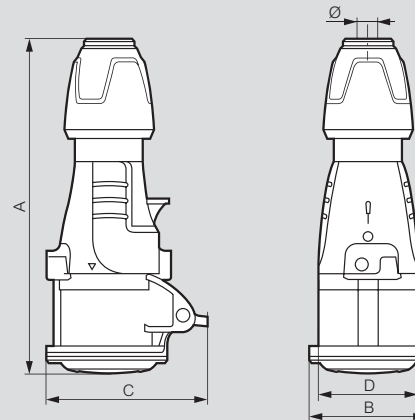

	A	B	C	D	Ø
LV 16 A					
2P+±	156 to 167	59	81	50	6.5 to 14
3P+±	157 to 168	65	88	55	7-10 to 15-5
3P+N+±	175 to 188	72	94	65	8 to 20
LV 32 A					
2P+±	184 to 197	73	99	65	8 to 20
3P+±	184 to 197	73.5	99	65	8 to 20
3P+N+±	190 to 203	79.5	105	71	11.9 to 22.2

P 17 Tempra Pro IP 44 - LV 16 and 32 A

plugs and appliance inlets

■ Dimensions

Straight plugs (p. 179)

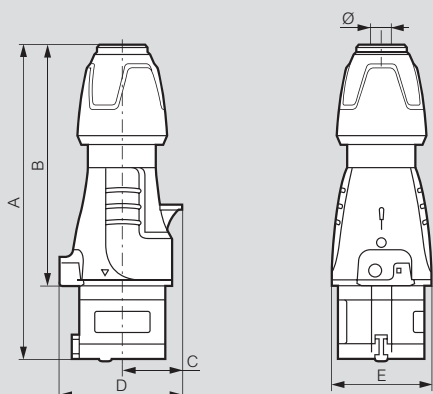

	A	B	C	D	E	Ø
LV 16 A						
2 P + ⊕	146 to 157	109.5 to 120.5	30	61	50	6.5 to 14
3 P + ⊕	146 to 157	109.5 to 120.5	34	67	55	7.10 to 15.5
3 P + N + ⊕	163 to 176	126.5 to 139.5	38	76	65	8 to 20
LV 32 A						
2 P + ⊕	172 to 185	127 to 140	40	78	65	8 to 20
3 P + ⊕	172 to 185	127 to 140	40	78	65	8 to 20
3 P + N + ⊕	179 to 189	133 to 143	45	86	71	11.9 to 22.2

Appliance inlets (p. 179)

Cat. Nos. 0575 84/88/89 and 0582 84/88/89

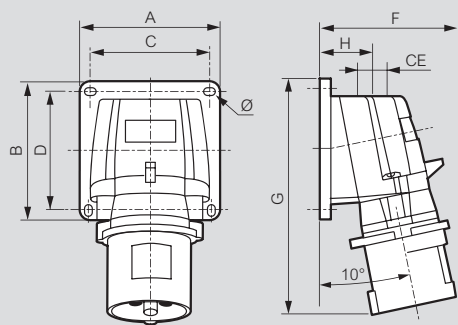

	Weight (kg)	A	B	C	D	F	G	H	CE	Ø
LV 16 A										
2 P + ⊕	0.168	84	84	72	72	77	126	34	M20	4.3
3 P + ⊕	0.232	84	84	72	72	84	134	34	M20	4.3
3 P + N + ⊕	0.256	84	84	72	72	91	141	34	M20	4.3
LV 32 A										
2 P + ⊕	0.325	110	110	98	98	96	168	39	M25	5.3
3 P + ⊕	0.364	110	110	98	98	102	168	39	M25	5.3

Adaptor from IEC to BS (p. 178)

Cat. No. 0521 01

16 A 2 P + ⊕ 230 V plug to 13 A 3 pin BS socket

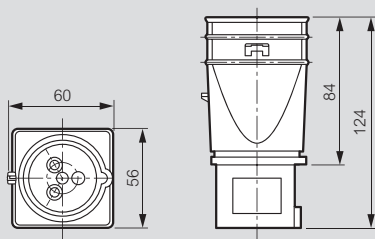

P 17 Tempra Pro IP 66/67 - LV 16/32/63/125 A

selection chart

<p>Conform to : BS EN 60309-1, IEC 60309-1, BS EN 60309-2 and IEC 60309-2 IP 44 according to BS EN 60529 and IEC 60529 IK 09 according to BS EN 62262 and IEC 62262 Material : polyamide 6 or plastic (see p. 183 for details) Self-extinguishing : 850 °C (support of active parts) / 650 °C (plastic housing)</p> <p> Technical information and dimensions p. 184-187</p>			FUNCTIONS					
			PANEL MOUNTING SOCKETS	SURFACE MOUNTING SOCKETS	MOBILE SOCKETS	STRAIGHT PLUGS	APPLIANCE INLETS	
LV								
100 to 130 V 50/60 Hz	16 A	2 P + ⊥	5553 81	5553 51	5553 01	5553 21	–	
	32 A	2 P + ⊥	5554 81	5554 51	–	5554 31	–	
200 to 250 V 50/60 Hz	16 A	2 P + ⊥	5553 84	5553 54	5553 04	5553 24	0568 03 ¹	
	32 A	2 P + ⊥	5554 84	5554 54	5554 14	5554 34	0568 23 ¹	
	63 A	2 P + ⊥	0587 20 ¹	0587 40 ¹	0587 10 ¹	0587 00 ¹	0587 30 ¹	
380 to 415 V 50/60 Hz	16 A	3 P + ⊥	5553 88	5553 58	5553 08	5553 28	0568 07 ¹	
		3 P + N + ⊥	5553 89	5553 59	5553 09	5553 29	0568 08 ¹	
	32 A	3 P + ⊥	5554 88	5554 58	5554 18	5554 38	0568 27 ¹	
		3 P + N + ⊥	5554 89	5554 59	5554 19	5554 39	0568 28 ¹	
	63 A	3 P + ⊥	0587 24 ¹	0587 44 ¹	0587 14 ¹	0587 04 ¹	0587 34 ¹	
		3 P + N + ⊥	0587 25 ¹	0587 45 ¹	0587 15 ¹	0587 05 ¹	0587 35 ¹	
	125 A	3 P + N + ⊥	0591 17 ¹	0591 07 ¹	0591 37 ¹	0591 27 ¹	0591 47 ¹	

¹ : Appliance inlets and all 63 A and 125 A products are P17 Tempra items which are manufactured from plastic
For pack quantities, see p. 183

ADAPTOR

Conform to BS EN 60309-1,
BS EN 60309-2, IEC 60309-1
and IEC 60309-2
Self-extinguishing : 850 °C
Temp. rating : -15 °C to +40 °C

Dimensions
p. 186

16 A – 230 V

	Pack	Cat. No.
IEC 2 P + ⊥ plug – 13 A 2 P + ⊥ B.S. socket	10	0521 01

P 17 Tempra Pro IP 66/67 LV 16 and 32 A



Technical information and dimensions **p. 184-187**
Conformity to International Standards **p. 198**

Conform to BS EN 60309-1, IEC 60309-1, BS EN 60309-2 and IEC 60309-2
IP 44 according to BS EN 60529 and IEC 60529
IK 09 according to BS EN 62262 and IEC 62262
Material : polyamide 6 or plastic (see below)
Self-extinguishing : 850 °C (support of active parts) / 650 °C (plastic housing)

Pack	Cat. Nos.	Panel mounting sockets
		NEW Material : polyamide 6 Can be fixed on the faceplates (p. 195)
5	16 A 32 A 5553 81 5554 81	100/130 V 2 P + ⊕
5	5553 84 5554 84	200/250 V 2 P + ⊕
5	5553 88 5554 88	380/415 V 3 P + ⊕
5	5553 89 5554 89	380/415 V 3 P + N + ⊕

Pack	Cat. Nos.	Surface mounting sockets
		NEW Material : polyamide 6 Two possible angles (5° or 25°)
5	16 A 32 A 5553 51 5554 51	100/130 V 2 P + ⊕
5	5553 54 5554 54	200/250 V 2 P + ⊕
5	5553 58 5554 58	380/415 V 3 P + ⊕
5	5553 59 5554 59	380/415 V 3 P + N + ⊕

Pack	Cat. Nos.	Mobile sockets
		NEW Material : polyamide 6 Supplied unlocked
5	16 A 32 A 5553 01	100/130 V 2 P + ⊕
5	5553 04 5554 14	200/250 V 2 P + ⊕
5	5553 08 5554 18	380/415 V 3 P + ⊕
5	5553 09 5554 19	380/415 V 3 P + N + ⊕

Pack	Cat. Nos.	Straight plugs
		NEW Material : polyamide 6 Supplied unlocked
5	16 A 32 A 5553 21 5554 31	100/130 V 2 P + ⊕
5	5553 24 5554 34	200/250 V 2 P + ⊕
5	5553 28 5554 38	380/415 V 3 P + ⊕
5	5553 29 5554 39	380/415 V 3 P + N + ⊕

Pack	Cat. Nos.	Appliance inlets ¹
		Material : plastic
5	16 A 32 A 0 568 03 0 568 23	200/250 V 2 P + ⊕
5	0 568 07 0 568 27	380/415 V 3 P + ⊕
5	0 568 08 0 568 28	380/415 V 3 P + N + ⊕

P 17 Tempra IP 66/67 LV 63 and 125 A

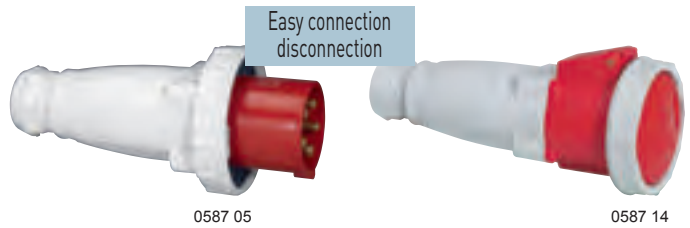

Technical information and dimensions **p. 185-187**
Conformity to International Standards **p. 198**

Conform to BS EN 60309-1, IEC 60309-1, BS EN 60309-2 and IEC 60309-2
IP 44 according to BS EN 60529 and IEC 60529
IK 09 according to BS EN 62262 and IEC 62262
Material : plastic
Self-extinguishing : 850 °C (support of active parts) / 650 °C (plastic housing)

Pack	Cat. Nos.	Panel mounting sockets ¹
		Can be fixed on the faceplates Cat. Nos 0577 17/19 (p. 195)
2	63 A 125 A 0587 20	200/250 V 2 P + ⊕
2 1	0587 24	380/415 V 3 P + ⊕
2 1	0587 25 0591 17	380/415 V 3 P + N + ⊕

Pack	Cat. Nos.	Surface mounting sockets ¹
2	63 A 125 A 0587 40	200/250 V 2 P + ⊕
2 1	0587 44	380/415 V 3 P + ⊕
2 1	0587 45 0591 07	380/415 V 3 P + N + ⊕

Pack	Cat. Nos.	Mobile sockets ¹
2	63 A 125 A 0587 10	200/250 V 2 P + ⊕
2 1	0587 14	380/415 V 3 P + ⊕
2 1	0587 15 0591 37	380/415 V 3 P + N + ⊕

Pack	Cat. Nos.	Straight plugs ¹
2	63 A 125 A 0587 00	200/250 V 2 P + ⊕
2 1	0587 04	380/415 V 3 P + ⊕
2 1	0587 05 0591 27	380/415 V 3 P + N + ⊕

Pack	Cat. Nos.	Appliance inlets ¹
2	63 A 125 A 0587 30	200/250 V 2 P + ⊕
2 1	0587 34	380/415 V 3 P + ⊕
2 1	0587 35 0591 47	380/415 V 3 P + N + ⊕

¹ : Appliance inlets and all 63 A and 125 A products are P17 Tempra items which are manufactured from plastic

P 17 Tempra Pro IP 66/67 - LV 16 and 32 A

sockets, mobile sockets, plugs and appliance inlets

Technical information

Terminal connection :

- Panel and surface mounting sockets
- 16 A : max. 1 x 4 mm² rigid – 32 A : max. 1 x 10 mm² rigid
- Plugs and mobile sockets:
- 16 A : max. 1 x 2.5 mm² flexible – 32 A : max. 1 x 6 mm² flexible

• Appliance inlets :

- 16 A : max. 1 x 2.5 mm² rigid – 32 A : max. 1 x 6 mm² rigid
- IP 66/67 according to BS EN 60529 and IEC 60529
- IK 09 according to BS EN 62262 and IEC 62262
- Material : polyamide 6 (appliance inlet material : plastic)
- Self-extinguishing : 850 °C (support of active parts) / 650 °C (plastic housing)
- Temp. rating : -25 °C to +40 °C
- Conform to BS EN 60309-1, IEC 60309-1, BS EN 60309-2 and IEC 60309-2

Dimensions

Panel mounting sockets (p. 183)

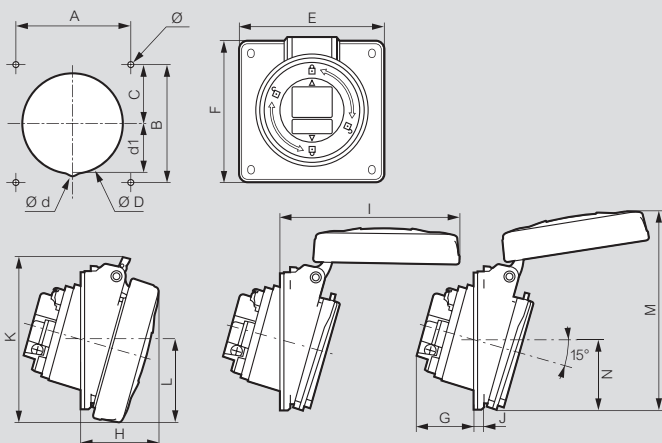

	Dimensions (mm)																
	A	B	C	ØD	Ød	d1	E	F	G	H	I	J	K	L	M	N	Ø
LV 16 A																	
2P+±	70	70	35	76.2	-	-	84	84	33.5	42	94	4.5	88	42.5	114	42	4.2
3P+±	70	70	35	76.2	-	-	84	84	35.5	43	101	4.5	94.5	46	118	42	4.2
3P+N+±	70	70	35	76.2	-	-	84	84	36.5	44	108.5	4.5	101	50	123	42.5	4.2
LV 32 A																	
2P+±/3P+±	70	70	35	76.2	-	-	84	94	41.5	50.5	118	4.5	105.5	54.5	129.5	47.5	4.2
3P+N+±	70	70	35	76.2	8	36	84	94	42.5	51.5	124.5	4.5	112	57.5	137	51	4.2

Surface mounting sockets (p. 183)

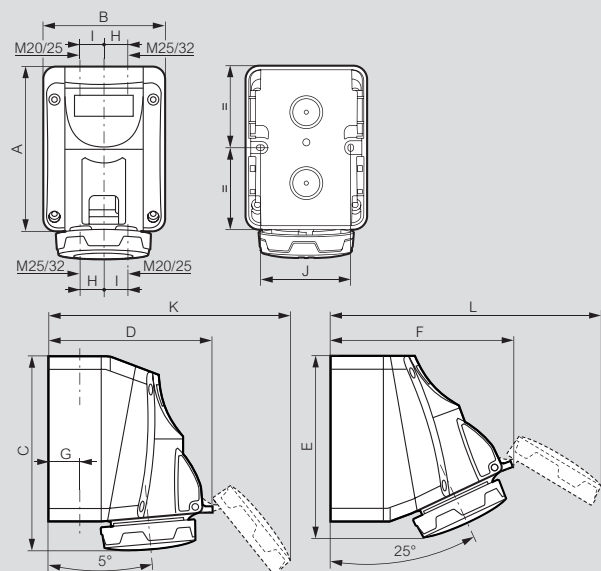

	A	B	C	D	E	F	G	H	I	J	K	L
LV 16 A												
2P+±	125	93	144	125	131	137	22	17	20	70	178	200
3P+±	125	93	144	133	131	145	22	17	20	70	194	215
3P+N+±	125	93	144	139	131	150	22	17	20	70	205	227
LV 32 A												
2P+±/3P+±	150	113	171	155	156	170	28	22	26	90	224	250
3P+N+±	150	113	171	161	156	175	28	22	26	90	231	260

Mobile sockets (p. 183)

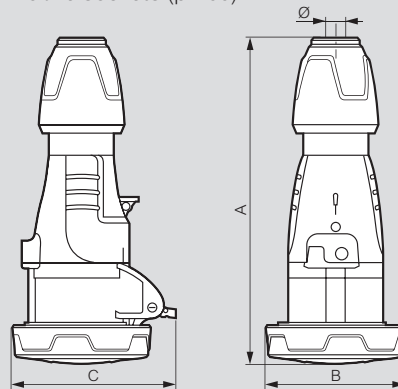

	A	B	C	Ø
LV 16 A				
2P+±	159 to 170	72.5	86	6.5 to 14
3P+±	159 to 170	80.5	93	7.1 to 15.5
3P+N+±	179 to 190	89	100	8 to 20
LV 32 A				
2P+±	187 to 200	93	104	8 to 20
3P+±	187 to 200	93	104	8 to 20
3P+N+±	192 to 205	100	110.5	11.9 to 22.2

Straight plugs (p. 183)

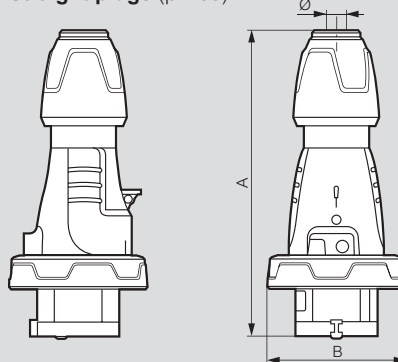

	A	B	Ø
LV 16 A			
2P+±	146 to 157	72.5	6.5 to 14
3P+±	146 to 157	80.5	7.1 to 15.5
3P+N+±	163 to 176	89	8 to 20
LV 32 A			
2P+±	172 to 185	93	8 to 20
3P+±	172 to 185	93	8 to 20
3P+N+±	179 to 189	100	11.9 to 22.2

Appliance inlets (p. 183)

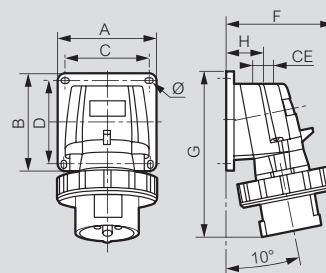

	Weight (kg)	A/B	C/D	F	G	H	CE	Ø
LV 16 A								
2P+±	0.188	84	72	87	126	34	M 20	4.3
3P+±	0.257	84	72	95	134	34	M 20	4.3
3P+N+±	0.297	84	72	100	141	34	M 20	4.3
LV 32 A								
2P+±	0.370	110	98	107	168	39	M 25	5.3
3P+±								
3P+N+±	0.413	110	98	113	168	39	M 25	5.3

P 17 Tempra IP 66/67 - LV 63 A

sockets, mobile sockets, plugs and appliance inlets

Technical information

Terminal connection :

- Panel and surface mounting sockets
- 63 A : max. 1 x 25 mm² rigid - 125 A: max. 1 x 70 mm² rigid
- Plugs and mobile sockets:
- 63 A : max. 1 x 16 mm² flexible - 125 A: max. 1 x 50 mm² flexible
- Appliance inlets :

63 A : max. 1 x 16 mm² rigid - 125 A: max. 1 x 50 mm² rigid

IP 66/67 according to BS EN 60529 and IEC 60529

IK 09 according to BS EN 62262 and IEC 62262

Material : plastic

Self-extinguishing : 850 °C (support of active parts) / 650 °C (plastic housing)

Temp. rating : -25 °C to +40 °C

Conform to BS EN 60309-1, IEC 60309-1, BS EN 60309-2 and IEC 60309-2

Dimensions

Panel mounting sockets (inclined outlet) (p. 183)

Cat. Nos. 0587 20/24/25

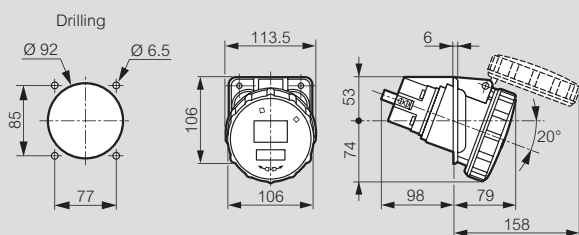

	Weight (kg)
3 P + \pm	0-710
3 P + N + \pm	0-770

Surface mounting sockets (p. 183)

Cat. Nos. 0587 40/44/45

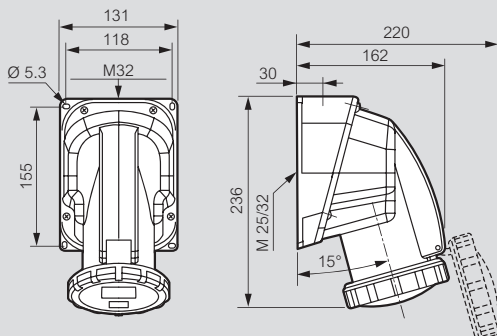

	Weight (kg)
3 P + \pm	0-900
3 P + N + \pm	0-950

Mobile sockets (p. 183)

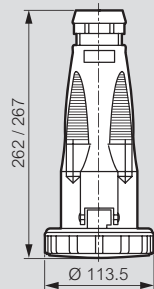

	Weight (kg)
	Mobile sockets
3 P + \pm	0-780
3 P + N + \pm	0-850

Straight plugs (p. 183)

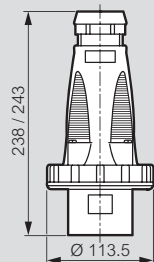

	Weight (kg)
	Straight plugs
3 P + \pm	0-570
3 P + N + \pm	0-640

Appliance inlets (p. 183)

Cat. Nos. 0587 30/34/35

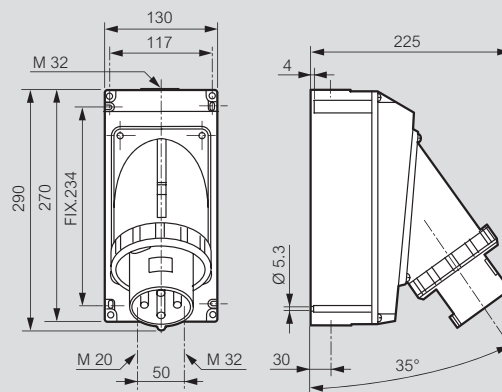

	Weight (kg)
3 P + \pm	1-540
3 P + N + \pm	1-610

P 17 Tempra IP 66/67 - LV 125 A

sockets, mobile sockets, plugs and appliance inlets

Technical information

Terminal connection :

- Panel and surface mounting sockets
125 A : max. 1 x 25 mm² rigid - 125 A: max. 1 x 70 mm² rigid
- Plugs and mobile sockets:
125 A : max. 1 x 16 mm² flexible - 125 A: max. 1 x 50 mm² flexible
- Appliance inlets :

125 A : max. 1 x 16 mm² rigid - 125 A: max. 1 x 50 mm² rigid
IP 66/67 according to BS EN 60529 and IEC 60529
IK 09 according to BS EN 62262 and IEC 62262

Material : plastic

Self-extinguishing : 850 °C (support of active parts) / 650 °C (plastic housing)

Temp. rating : -25 °C to +40 °C

Conform to BS EN 60309-1, IEC 60309-1, BS EN 60309-2 and IEC 60309-2

Dimensions

Panel mounting sockets (p. 183)

Cat. No. 0591 17

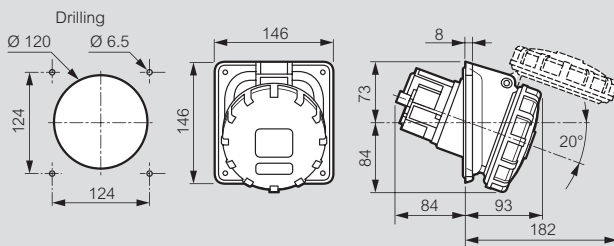

	Weight (kg)
3 P+N+⊥	1.200

Surface mounting sockets (p. 183)

Cat. No. 0591 07

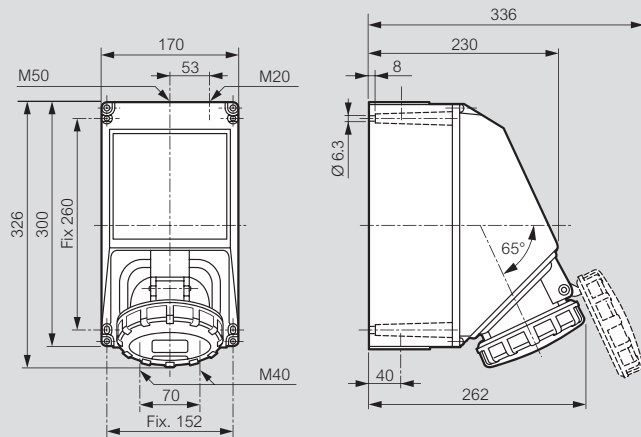

	Weight (kg)
3 P+N+⊥	2.730

Mobile sockets (p. 183)

Cat. No. 0591 37

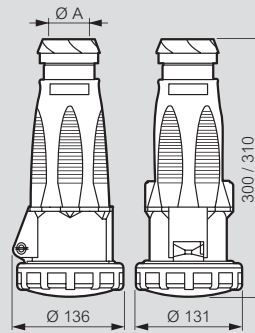

	A
3 P+N+⊥	28.5 to 50

Straight plugs (p. 183)

Cat. No. 0591 27

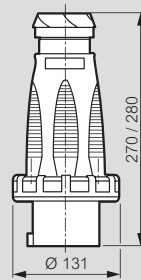

	Ø
3 P+N+⊥	28.5 to 50

Appliance inlets (p. 183)

Cat. No. 0591 47

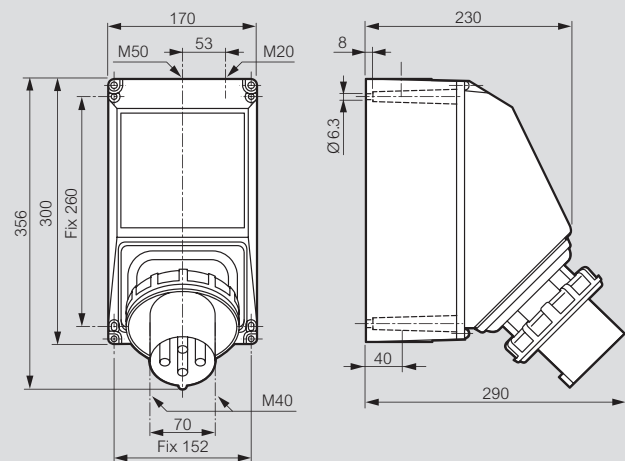

Adaptor from IEC to BS (p. 182)

Cat. No. 0521 01

16 A 2 P+⊥ 230 V plug to 13 A 3 pin BS socket

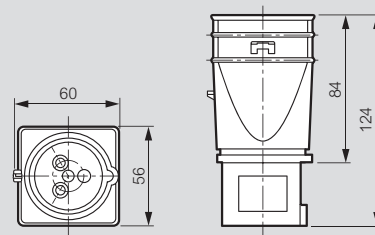

P 17 Tempra IP 66/67 - LV 63 A

pilot pin connection, specifications and type

■ Example of 63 A 3 P + \perp and 3 P + N + \perp pilot pin connection

The pilot pin enables the load to be removed prior to the separation of the phase pins, when the circuit is routed via a contactor

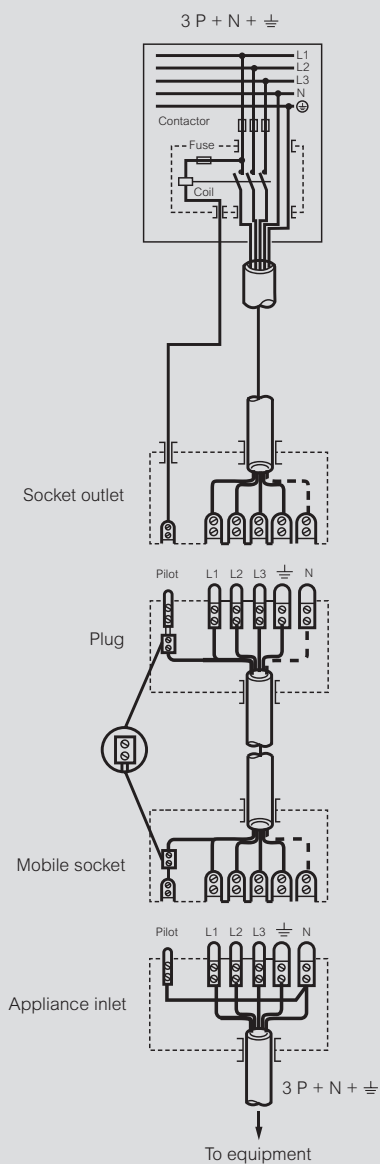

The pilot pin connection accepts 2.5-6 mm² flexible or up to 10 mm² rigid conductor. It is the small centre pin in the connection

■ Pilot cabling

	63 A	Conductors type
Plugs and mobile sockets	2.5 to 6	Flexible
Surface mounting sockets	2.5 to 10	Rigid

Hypra[®] and P17[®]

safe, secure connections



Hypra[®]

Tough and durable combination units available with Hypra Prisinter or panel mounting sockets.

- Lockable transparent window - for security and instant monitoring of protection device status
- Captive, stainless steel external screws - for added durability
- Off load connection and disconnection on Prisinter equipped versions - providing additional safety for users and circuits alike
- Choice of circuit protection - DIN rail mounted MCB, RCBO and RCD protection options



Lockable transparent window for security and instant monitoring of protection device status



Prisinter sockets offer a unique interlocked load break

TECHNICAL DATA

APPROVALS:

BS EN 60309-1, BS EN 60309-2,
BS EN 60529 (IP), BS EN 62262 (IK)

PROTECTION:

IP44, IP66/67-55 and IP66/67 ranges available
IK09

SELF EXTINGUISHING:

850°C for insulated parts
650°C for housing

OPERATING TEMPERATURE:

Mechanical lock only -20°C to +100°C
with RCD -15°C to +40°C
with MCB -5°C to +40°C



Single socket units with switch



Single socket units with switch and MCB / RCD protection



Prisinter single socket units with RCBO protection

combination units...

P17 Tempra®

These combination units feature a unique plug-in design that enables the base to be wired independently of the cover, making installation both quicker and easier:

1. Fix the base on to the wall
2. Wire the protection device and the base socket connection independently of the cover
3. Close the combination unit and plug in



Double mechanical interlocking switch cannot be turned on unless a plug is inserted. Once switched on, the plug cannot then be removed until the switch is turned off

Units can be fitted with a variety of Legrand modular devices, including MCBs, RCDs, timers, contactors and indicators. Lid window allows instant monitoring of protection device status

TECHNICAL DATA

APPROVALS:

BS EN 60309-1, BS EN 60309-2, BS EN 60529 (IP), BS EN 62262 (IK)

PROTECTION:

IP44, IP55 and IP66 ranges available
IK08

SELF EXTINGUISHING:

850°C for insulated parts
650°C for housing

OPERATING TEMPERATURE:

-20°C to +100°C without protection device
-15°C to +40°C with protection device



Interlocked switched sockets without protection

Interlocked switched sockets with DIN rail

Self assembly units

Hypra® IP 44 combination units - LV 16/32/63 A

plastic surface mounting



Technical information and dimensions **p. 192**
 Conformity to International Standards **p. 198**

Conform to BS EN 60309-1, BS EN 60309-2 and IEC 60309-1, IEC 60309-2
 IP 44 conforms to BS EN 60529 and IEC 60529
 IK 09 conforms to BS EN 62262 and IEC 62262
 Temp. rating : -15 °C to +40 °C*
 RAL 7022

Pack	Cat. Nos.		Single socket units with switch
	16 A	32 A	Double mechanical interlock
1	0592 00		100 to 130 V~ 2 P + ⊥
1	0592 03	0592 43	200 to 250 V~ 2 P + ⊥
1	0592 09	0592 49	380 to 415 V~ 3 P + ⊥
1	0592 16	0592 56	380 to 415 V~ 3 P + N + ⊥
	63 A		380 to 415 V~ 3 P + ⊥
1	0592 34		3 P + N + ⊥
1	0592 35		3 P + N + ⊥

Pack	Cat. Nos.		Single socket units protected by 30 mA RCBO
	16 A	32 A	Transparent plastic hinged viewing window Supplied complete with 16/32 A 30 mA RCBO With 5 module DIN rail
1	0592 07	0592 47	200 to 250 V~ with RCBO 2 P + ⊥
1	0592 14		380 to 415 V~ with RCBO 3 P + ⊥
1	0592 19	0592 59	380 to 415 V~ with RCBO 3 P + N + ⊥

Pack	Cat. Nos.		Single socket units with switch and protected by 30 mA RCBO
	16 A	32 A	Transparent plastic hinged viewing window Supplied complete with 16/32 A 30 mA RCBO With 6 module DIN rail
1	0596 01	0596 05	200 to 250 V~ with RCBO 2 P + ⊥
1	0596 02	0596 07	380 to 415 V~ with RCBO 3 P + ⊥
1	0596 03	0596 08	380 to 415 V~ with RCBO 3 P + N + ⊥

Pack	Cat. Nos.		Single socket units with switch and protected by RCD
	63 A		Transparent plastic hinged viewing window Supplied complete with RCD With 6 module DIN rail
1	0592 83		380 to 415 V~ 3 P + ⊥ with MCB + RCD add-on module
1	0592 84		380 to 415 V~ 3 P + N + ⊥ with RCD

Pack	Cat. Nos.		Prisinter single socket units protected by 30 mA RCBO
	16 A	32 A	Transparent plastic hinged viewing window Cable glands are not supplied (ISO) With 6 module DIN rail IP 44 plug inserted IP 55 lid closed or connected to an IP 66/67-55 angled plug
1	0592 24		200 to 250 V~ 2 P + ⊥
1	0592 25	0592 28	380 to 415 V~ 3 P + ⊥
1	0592 26	0592 29	380 to 415 V~ 3 P + N + ⊥

1 : Units with RCBO and some MCB protection devices have temperature ratings of -5 °C to +40 °C
 Switch only units and some MCBs have increased ratings - please contact us on +44 (0) 845 605 4333

Hypra IP 44 straight plugs
p. 162



Hypra IP 66/67-55 angled and straight plugs
p. 168



Hypra® IP 66/67-55 combination units - LV 16/32/63/125 A

plastic surface mounting



0592 65



0591 15



0596 61

Technical information and dimensions **p. 193**
 Conformity to International Standards **p. 198**

Conform to BS EN 60309-1, BS EN 60309-2 and IEC 60309-1, IEC 60309-2
 IP 66/67-55 for 16 and 32 A and to BS EN 60529 and IEC 60529 for 63 and 125 A
 IK 09 conforms to BS EN 62262 and IEC 62262
 Temp. rating : -15 °C to +40 °C¹

Pack	Cat. Nos.		Single socket units with switch
	16 A	32 A	Double mechanical interlock
1	0592 60	0592 63	200 to 250 V~ 2 P + ⊥
			380 to 415 V~
1	0592 61	0592 64	3 P + ⊥
1	0592 62	0592 65	3 P + N + ⊥
	63 A		380 to 415 V~
1	0592 66		3 P + ⊥
1	0592 67		3 P + N + ⊥
	125 A		380 to 415 V~
1	0591 14 ²		3 P + ⊥
1	0591 15 ²		3 P + N + ⊥

Pack	Cat. Nos.		Single socket units with rail only, or complete with MCB 16/32 A
	16 A	32 A	Transparent plastic hinged viewing window Cable glands are not supplied (ISO) With 6 module DIN rail
1	0596 60		100 to 130 V~ rail only 2 P + ⊥
1	0596 61		200 to 250 V~ with MCB 2 P + ⊥
			380 to 415 V~ with MCB
1		0596 67	3 P + ⊥
1		0596 68	3 P + N + ⊥

Pack	Cat. Nos.		Single socket units with switch and protected by 30 mA RCBO or RCD
	16 A	32 A	Transparent plastic hinged viewing window Cable glands are not supplied (ISO) With 6 module DIN rail
1	0596 51	0596 55	200 to 250 V~ with RCBO 2 P + ⊥
			380 to 415 V~ with RCBO
1	0596 52	0596 57	3 P + ⊥
1	0596 53	0596 58	3 P + N + ⊥
	63 A		380 to 415 V~ with RCD
1	0596 81		3 P + N + ⊥

1 : Units with RCBO and some MCB protection devices have temperature ratings of -5 °C to +40 °C
 Switch only units and some MCBs have increased ratings - contact us on +44 (0) 845 605 4333
 2 : Interlocked using a Vistop switch, see p. 85

Protection devices **p. 56-57**



Hypra® IP 44 combination units - LV 16/32/63 A

plastic surface mounting

Technical information

IP 44 conforms to BS EN 60529 and IEC 60529
 IK 09 conforms to BS EN 62262 and IEC 62262
 External screws in stainless steel - Nickel plated contacts
 Icc 10 kA conforms to BS EN 60309-1, BS EN 60309-2 and IEC 60309-1, IEC 60309-2
 Self-extinguishing : 850 °C for insulated parts (650 °C for housing) according to BS EN 60695-1, BS EN 60695-2, IEC 60695-1 and IEC 60695-2
 IK 09
 RAL 7022

Units with Prisinter :

- IP 44 plug connected conforms to BS EN 60529 and IEC 60529
- IP 55 with cover closed or used with IP 66/67-55 plug
- Breaking capacity conforms to BS EN 60947-1, BS EN 60947-3, IEC 60947-1 and IEC 60947-3 :

	16 A	32 A	63 A
AC1	16 A - 400 V~	32 A - 400 V~	63 A - 400 V~
AC3	8.4 kW	16.8 kW	33 kW
AC23	8.4 kW	16.8 kW	33 kW

Single socket units with switch (p. 190)

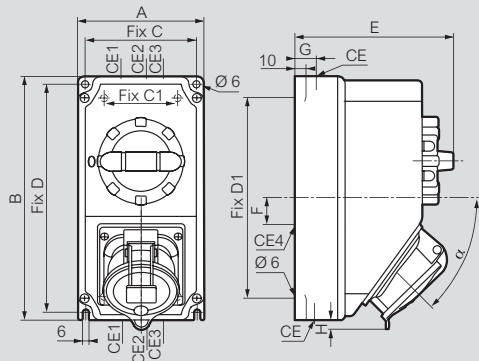

	Cat. Nos.	Dimensions (mm)										Knock-out entries for cable gland																																					
		110 to 130 V~	200 to 250 V~	380 to 415 V~	A	B	C	D	C1	D1	E	F	G	H	α	CE1	CE2	CE3	CE4																														
16 A	2P+⊥	0592 00	0592 03		120	230	106	216	70	190	151	25	20	1.5	46°	M 20/25	-	M 20/25	Ø 29																														
	3P+⊥		0592 09																																														
	3P+N+⊥		0592 16																																														
32 A	2P+⊥	0592 43																		170	320	156	306	100	270	204	65	28	21.5	56°	M 20/25	M 25/32	M 20	Ø 38															
	3P+⊥		0592 49																																														
	3P+N+⊥		0592 56																																														
63 A	3P+⊥		0592 34																																170	320	156	306	100	270	204	65	28	21.5	56°	M 20/25	M 25/32	M 20	Ø 38
	3P+N+⊥		0592 35																																														

Single socket units protected by 30 mA RCBO and Prisinter single socket units protected by 30 mA RCBO (p. 190)

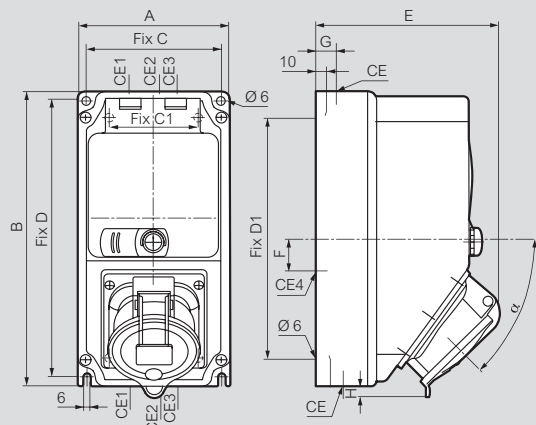

	Cat. Nos.	Dimensions (mm)										Knock-out entries for cable gland																																					
		200 to 250 V~	380 to 415 V~	A	B	C	D	C1	D1	E	F	G	H	α	CE1	CE2	CE3	CE4																															
16 A	2P+⊥	0592 07		120	230	106	216	70	190	138	25	20	1.5	46°	M 20/25	-	M 20/25	Ø 29																															
	3P+⊥		0592 14																																														
	3P+N+⊥		0592 19																																														
32 A	2P+⊥	0592 47																	170	320	156	306	100	270	145	28	0	9	56°	M 20/25	M 25/32	M 20	Ø 38																
	3P+⊥		0592 25																																														
	3P+N+⊥		0592 26																																														
Prisinter 16 A	2P+⊥	0592 24																																170	320	156	306	100	270	195	65	28	0	56°	M 20/25	M 25/32	M 20	Ø 38	
	3P+⊥		0592 25																																														
	3P+N+⊥		0592 26																																														
Prisinter 32 A	3P+⊥	0592 28		170	320	156	306	100	270	206	65	28	0	56°	M 20/25	M 25/32	M 20	Ø 38																															
	3P+N+⊥		0592 29																																														

Single socket units with switch and protected by 30 mA RCBO or RCD (p. 190)

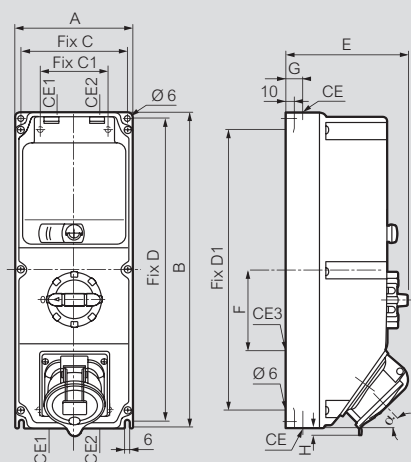

	Cat. Nos.	Dimensions (mm)										Knock-out entries for cable gland																																	
		200 to 250 V~	380 to 415 V~	A	B	C	D	C1	D1	E	F	G	H	α	CE1	CE2	CE3																												
Protected by 30 mA RCBO																																													
16 A	2P+⊥	0596 01		140	370	126	356	74	330	151	95	20	1.5	46°	M 20/25	M 20/25	Ø 29																												
	3P+⊥		0596 02																																										
	3P+N+⊥		0596 03																																										
32 A	2P+⊥	0596 05																140	370	126	356	74	330	151	95	20	9	46°	M 20/25	M 20/25	Ø 29														
	3P+⊥		0596 07																																										
	3P+N+⊥		0596 08																																										
Protected by RCD																																													
63 A	3P+⊥	0596 83																														160	470	146	456	90	420	204	125	28	20	56°	M 25/32	M 20/25	Ø 38
	3P+N+⊥		0596 84																																										

P 17 Tempra® IP 44, IP 55 and IP 66 combination units - LV 16/32/63 A

plastic surface mounting

16/32 A INTERLOCKED SWITCHED SOCKETS										
IK 08 according to BS EN 62262 and IEC 62262 Self-extinguishing : 650 °C according to BS EN 60695-2-1 and IEC 60695-2-1 Temp. rating : -20 °C to +100 °C Supplied without protection device (switch only)		WITHOUT PROTECTION 125 x 220 mm					WITH DIN RAIL 125 x 280 mm			
		IP 44 		IP 55 			IP 44  With 5 module DIN rail		IP 66  With 5 module DIN rail	
		Pack	Cat. Nos.	Pack	Cat. Nos.	Pack	Cat. Nos.	Pack	Cat. Nos.	
LV										
100 to 130 V 50/60 Hz	16 A	2 P + ⊥	1	0566 00	1	0566 20	1	0566 40	1	–
200 to 250 V 50/60 Hz	16 A	2 P + ⊥	1	0566 01	1	0566 21	1	0566 41	1	0566 61
	32 A	2 P + ⊥	1	0566 09	1	0566 29	1	0566 49	1	0566 69
380 to 415 V 50/60 Hz	16 A	3 P + ⊥	1	0566 05	1	0566 25	1	0566 45	1	0566 65
		3 P + N + ⊥	1	0566 06	1	0566 26	1	0566 46	1	0566 66
	32 A	3 P + ⊥	1	0566 13	1	0566 33	1	0566 53	1	0566 73
		3 P + N + ⊥	1	0566 14	1	0566 34	1	0566 54	1	0566 74

63 A INTERLOCKED SWITCHED SOCKETS										
IK 08 according to BS EN 62262 and IEC 62262 Self-extinguishing : 650 °C according to BS EN 60695-2-1 and IEC 60695-2-1 Temp. rating : -20 °C to +100 °C Supplied without protection device (switch only)		WITHOUT PROTECTION 125 x 421 mm					WITH DIN RAIL 125 x 501 mm			
		IP 66 					IP 66  With 5 module DIN rail			
		Pack	Cat. Nos.	Pack	Cat. Nos.					
380 to 415 V 50/60 Hz	63 A	3 P + N + ⊥	1	0589 10	1	0572 99				

Protection devices p. 56-57



Larger self assembly and factory configured units available on request
Contact us on +44 (0) 845 605 4333



P 17 Tempra® self assembly combination units - LV 16/32 A

IK 08 according to BS EN 62262 and IEC 62262

Self-extinguishing : 650 °C according to BS EN 60695-2-1 and IEC 60695-2-1
Temp. rating : -20 °C to +100 °C
Supplied without protection device (switch only)

Technical information and dimensions p. 197

Assembly example

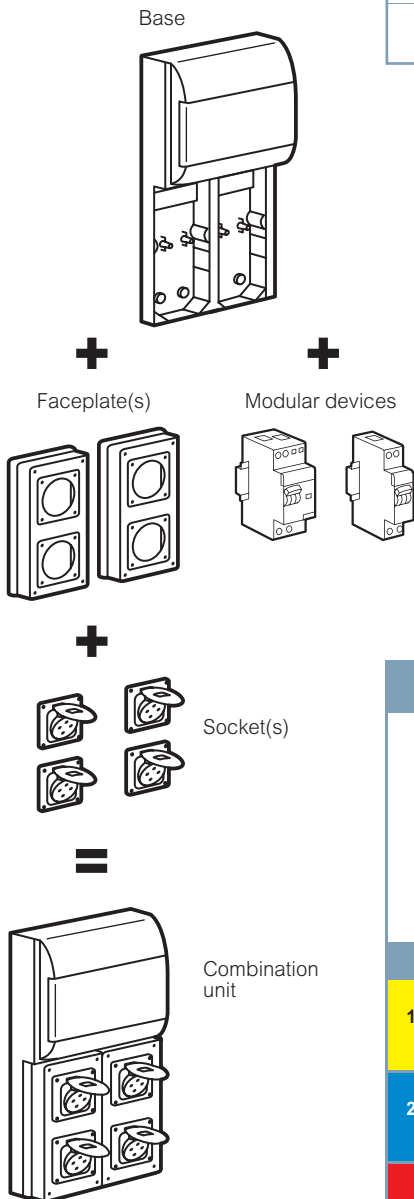

Note : Up to 9 socket units available on request

BASES FOR 125 x 220 MM FACEPLATES

16/32 A Surface mounting box		2 x 16 A		16/32 A		16/32 A	
Without protection option		With 5 module DIN rail		With 12 module DIN rail		With 18 module DIN rail	
Pack	Cat. Nos.	Pack	Cat. Nos.	Pack	Cat. Nos.	Pack	Cat. Nos.
2	0577 10	5	0589 38	1	0577 05	1	0577 06



125 x 220 MM FACEPLATES

1 x 16 A or 1 x 32 A		2 x 16 A		Blank plate	
Pack	Cat. Nos.	Pack	Cat. Nos.	Pack	Cat. Nos.
5	0577 12	5	0577 13 ¹	5	0577 15



SOCKETS FOR SELF ASSEMBLY COMBINATION UNITS

		Panel mounting sockets				
		IP 44		IP 66/67		
		Pack	Cat. Nos.	Pack	Cat. Nos.	
LV						
110 to 130 V 50/60 Hz	16 A	2 P + ⊥	5	5551 81	5	5553 81
	32 A	2 P + ⊥	5	5552 81	5	5554 81
200 to 250 V 50/60 Hz	16 A	2 P + ⊥	10	5551 84	5	5553 84
	32 A	2 P + ⊥	10	5552 84	5	5554 84
380 to 415 V 50/60 Hz	16 A	3 P + ⊥	10	5551 88	5	5553 88
		3 P + N + ⊥	10	5551 89	5	5553 89
	32 A	3 P + ⊥	10	5552 88	5	5554 88
		3 P + N + ⊥	10	5552 89	5	5554 89

1 : Supplied with one blank plate

P 17 Tempra® IP 44, IP 55 and IP 66 combination units - LV 16/32/63 A

plastic surface mounting

IP 44, IP 55, IP 66 according to BS EN 60529 and IEC 60529
IK 08 according to BS EN 62262 and IEC 62262
Switch ratings (p. 197)

■ Interlocked switched sockets without protection - IP 44/IP 55 LV 16/32 A (p. 194)

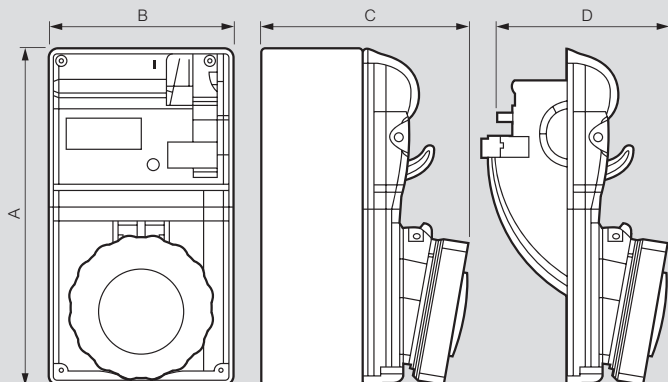

		IP 44	A	B	C	D	IP 55	A	B	C	D
		Cat. Nos.	(mm)	(mm)	(mm)	(mm)	Cat. Nos.	(mm)	(mm)	(mm)	(mm)
LV 16 A	2 P+ ⊥	0566 00/01	220	125	127	122	0566 20/21	220	125	133	128
	3 P+ ⊥	0566 05	220	125	129	124	0566 25	220	125	134	129
	3 P+N+⊥	0566 06	220	125	130	125	0566 26	220	125	135	130
LV 32 A	2 P+ ⊥	0566 09	220	125	138	133	0566 29	220	125	143	138
	3 P+ ⊥	0566 13	220	125	138	133	0566 33	220	125	143	138
	3 P+N+⊥	0566 14	220	125	139	134	0566 34	220	125	144	139

■ Interlocked switched sockets with DIN rail - IP 44/IP 66 LV 16/32 A (p. 194)

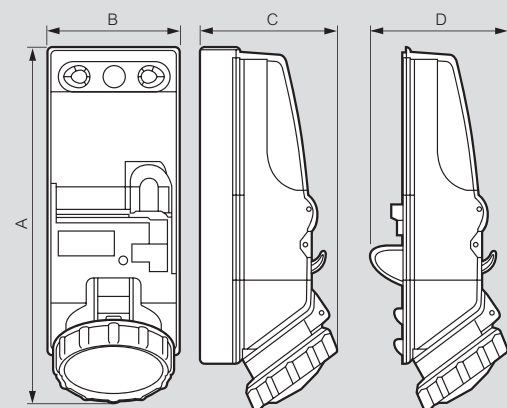

		IP 44	A	B	C	D	IP 66	A	B	C	D
		Cat. Nos.	(mm)	(mm)	(mm)	(mm)	Cat. Nos.	(mm)	(mm)	(mm)	(mm)
LV 16 A	2 P+ ⊥	0566 40/41	290	125	155	135	0566 61	300	125	155	135
	3 P+ ⊥	0566 45	290	125	155	135	0566 65	300	125	155	135
	3 P+N+⊥	0566 46	290	125	155	135	0566 66	300	125	155	135
LV 32 A	2 P+ ⊥	0566 49	295	125	155	145	0566 69	310	125	155	145
	3 P+ ⊥	0566 53	295	125	155	145	0566 73	310	125	155	145
	3 P+N+⊥	0566 54	295	125	155	145	0566 74	310	125	155	145

■ Interlocked switched sockets without protection/ with DIN rail - IP 66 LV 63 A (p. 194)

Cat. Nos. 0589 10/0572 99

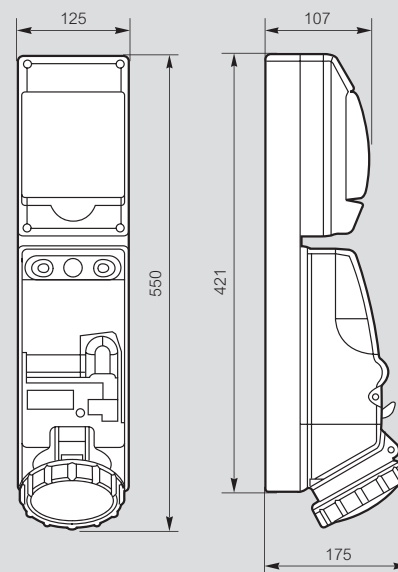

industrial plugs and sockets to International Standards

Conform to BS EN 60309-1, BS EN 60309-2, IEC 60309-1 and IEC 60309-2

■ Voltage identification

Colours specified by standards and the clock indexing of the contact tubes in socket outlets

■ With Legrand Hypra and P 17 Tempra industrial plugs and sockets, your installations will comply fully with international standards :

- Standard IEC 60309-1 : this defines the safety regulations (protection of workers) which should be observed in the manufacture of industrial power sockets and plugs
- Standard IEC 60309-2 : this defines the interchangeability regulations for the dimensions of equipment with pins and sockets

These safety regulations, together with the requirements of standard BS EN 60309-1, define the safety conditions necessary for normal operation. It is prudent to go one step further and insist on equipment which ensures the safety of the persons as a priority as well as ease of operation. Many manufacturers therefore use sockets which incorporate a switch, to avoid on-load disconnection (eg : Hypra Prisinter).

ELV by position of the minor keyway

24 V \sim 50 – 60 Hz Violet

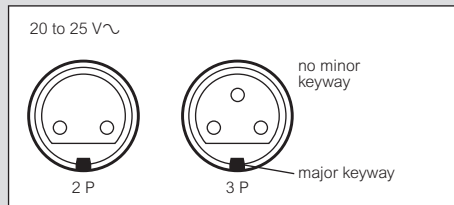

42 V \sim 50 – 60 Hz White

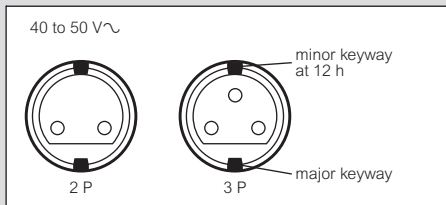

42 V \equiv White

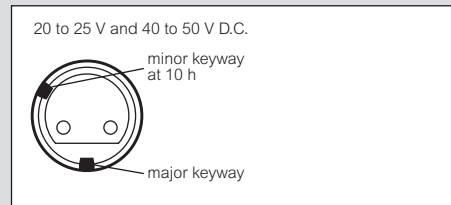

LV by the position of the earth contact tube in relation to the major keyway in the socket outlets

110 V \sim 50 – 60 Hz Yellow

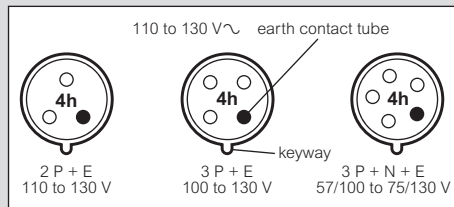

230 V \sim 50 – 60 Hz Blue

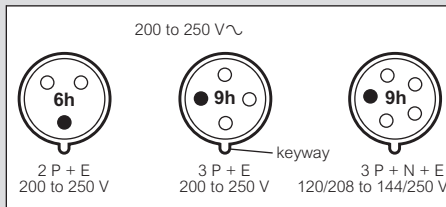

400 V \sim 50 – 60 Hz Red

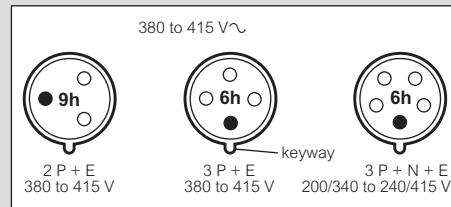

500 V \sim 50 – 60 Hz Black

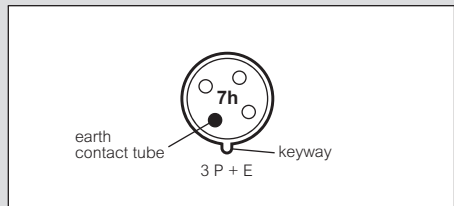

> 50 to 500 V \sim
100 to 300 Hz inclusive Green

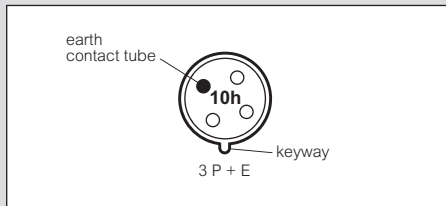

■ Terminal connection capacity, Prisinter rating and contact sizes

• Terminal connection capacity

	Hypra/P 17 Tempra
ELV 16/32 A	1 x 10 mm (A + B)
LV 16 A	1 x 4 mm (A) 1 x 2.5 mm (B)
LV 32 A	1 x 10 mm (A) 1 x 6 mm (B)
LV 63 A	1 x 25 mm (A) 1 x 16 mm (B)
LV 125 A	1 x 70 mm (A) 1 x 50 mm (B)

• Hypra Prisinter breaking capacity for 3 x 400 V \sim according to IEC 60947-1-3

Category	16 A	32 A	63 A
AC 1	16 A	32 A	63 A
AC 23	8.4 kW	16.8 kW	33 kW
AC 3	8.4 kW	16.8 kW	33 kW

• Diameters of pins or contact tubes (mm)

		16 A	32 A	63 A	125 A
24 V \sim 42 V \sim 42 V \equiv	Phase	6	6	–	–
	Phase + Neutral	5	6	8	10
110 V \sim 230 V \sim 400 V \sim 440 V \sim 500 V \sim	Earth	7	8	10	12
	Pilot	–	–	6	6

(A) Panel mounting sockets
(B) Mobile sockets and plugs

Cross-reference tables

ENCLOSURES				
Range	Description	Old Cat. No.	New Cat. No. / status	Page No.
Atlantic	Stainless St Enc 1200x800x300mm	0352 14	P	N/A
Atlantic	Stainless St Enc 1400x800x400mm	0352 15	P	N/A
Cabstop	Cabstop Plate	0364 95	P	N/A
Cabstop	Cabstop Plate	0364 97	P	N/A
Fixing Accessories	On Ground	0364 36	P	N/A
Fixing Accessories	On Ground	0364 37	P	N/A
Fixing Accessories	On Ground	0364 39	P	N/A
Lifting Accessories	Set of 4 Lifting Brackets For Enclosure	0362 46	P	N/A
Lifting Accessories	Enclosure Coupling Frame Kit	0362 48	P	N/A
Lina 12-5 Perforated Plates	Lina 12-5 Perforated Plates	0360 75	P	N/A
Lina 25 Perforated Plates	Perforated Plate Lina 25 1200x800mm	0360 90	P	N/A
Lina 25 Sectioned Uprights	Sectioned Uprights 1400mm	0361 59	P	N/A
Marina	Anti Tapping Cross Pieces	0369 39	P	N/A
Plain Plates	Plain Mounting Plate 300x200mm	0360 50	P	N/A
Plain Plates	Plain Mounting Plate 1400x800mm	0360 67	P	N/A
Roofs	Roof 500(W)x200(D)mm	0365 59	P	N/A
Terminal Block	Shrouded 3P+N Term Block 227mm	0048 14	P	N/A

POWER PROTECTION				
Range	Description	Old Cat. No.	New Cat. No. / status	Page No.
A Board	100A 6 Way Type A Board	6022 51	P	N/A
A Board	100A 10 Way Type A Board	6022 52	P	N/A
A Board	100A 14 Way Type A Board	6022 53	P	N/A
A Board	100A 18 Way Type A Board	6022 54	P	N/A
B Board	4 Way 125A Type B Dist Board SD	6071 00	P	N/A
B Board	6 Way 125A Type B Dist Board SD	6071 01	P	N/A
B Board	8 Way 125A Type B Dist Board SD	6071 02	P	N/A
B Board	12 Way 125A Type B Dist Board SD	6071 03	P	N/A
B Board	16 Way 125A Type B Dist Board SD	6071 04	P	N/A
B Board	24 Way 125A Type B Dist Board SD	6071 05	P	N/A
B Board	Flexible 125 B Board 24 Mod SD	6071 06	P	N/A
B Board	Flexible 125 B Board 36 Mod SD	6071 07	P	N/A
B Board	Flexible 125 B Board 48 Mod SD	6071 08	P	N/A
B Board	Flexible 125 B Board 72 Mod SD	6071 09	P	N/A
B Board	4 Way 250A Type B Dist Board SD	6071 10	P	N/A
B Board	6 Way 250A Type B Dist Board SD	6071 11	P	N/A
B Board	8 Way 250A Type B Dist Board SD	6071 12	P	N/A
B Board	12 Way 250A Type B Dist Board SD	6071 13	P	N/A
B Board	16 Way 250A Type B Dist Board SD	6071 14	P	N/A
B Board	24 Way 250A Type B Dist Board SD	6071 15	P	N/A
B Board	Flexible 250 B Board 24 Mod SD	6071 16	P	N/A
B Board	Flexible 250 B Board 36 Mod SD	6071 17	P	N/A
B Board	Flexible 250 B Board 48 Mod SD	6071 18	P	N/A
B Board	Flexible 250 B Board 72 Mod SD	6071 19	P	N/A
B Board	4 Way 125A Type B Dist Board GD	6071 50	P	N/A
B Board	6 Way 125A Type B Dist Board GD	6071 51	P	N/A
B Board	8 Way 125A Type B Dist Board GD	6071 52	P	N/A
B Board	12 Way 125A Type B Dist Board GD	6071 53	P	N/A
B Board	16 Way 125A Type B Dist Board GD	6071 54	P	N/A
B Board	24 Way 125A Type B Dist Board GD	6071 55	P	N/A
B Board	Flexible 125 B Board 24 Mod GD	6071 56	P	N/A
B Board	Flexible 125 B Board 36 Mod GD	6071 57	P	N/A
B Board	Flexible 125 B Board 48 Mod GD	6071 58	P	N/A
B Board	Flexible 125 B Board 72 Mod GD	6071 59	P	N/A
B Board	4 Way 250A Type B Dist Board GD	6071 60	P	N/A
B Board	6 Way 250A Type B Dist Board GD	6071 61	P	N/A
B Board	8 Way 250A Type B Dist Board GD	6071 62	P	N/A
B Board	12 Way 250A Type B Dist Board GD	6071 63	P	N/A
B Board	16 Way 250A Type B Dist Board GD	6071 64	P	N/A
B Board	24 Way 250A Type B Dist Board GD	6071 65	P	N/A
B Board	Flexible 250 B Board 24 Mod GD	6071 66	P	N/A
B Board	Flexible 250 B Board 36 Mod GD	6071 67	P	N/A
B Board	Flexible 250 B Board 48 Mod GD	6071 68	P	N/A
B Board	Flexible 250 B Board 72 Mod GD	6071 69	P	N/A
B Board	Incomer Kit MCB 125A 3P/4P	6072 00	P	N/A
B Board	Incomer Kit MCB 125A 3P	6072 01	P	N/A
B Board	Incomer Kit MCB 125A 4P	6072 02	P	N/A
B Board	Incomer Kit MCB 125A 4P+RCB	6072 03	P	N/A
B Board	Incomer Kit MCB 250A 3P	6072 04	P	N/A
B Board	Incomer Kit MCB 250A 4P	6072 05	P	N/A

POWER PROTECTION (cont)				
Range	Description	Old Cat. No.	New Cat. No. / status	Page No.
B Board	Incomer Kit MCB 250A 4P+RCB	6072 06	P	N/A
Cartridge Fuses	100A SP Size Fuse Base Sm	0160 00	P	N/A
Cartridge Fuses	100A SP Size Fuse Base Rm	0160 01	P	N/A
Cartridge Fuses	100A TP Size Fuse Base Sm	0160 04	P	N/A
Cartridge Fuses	100A TP Size Fuse Base Rm	0160 05	P	N/A
Cartridge Fuses	160A SP Size Fuse Base Sm	0162 00	P	N/A
Cartridge Fuses	160A TP Size Fuse Base Sm	0162 04	P	N/A
Cartridge Fuses	160A SP Size Fuse Base	0165 00	P	N/A
Cartridge Fuses	160A SP Size Fuse Base+M/SW	0165 02	P	N/A
Cartridge Fuses	160A SP Size Fuse Base	0165 03	P	N/A
Cartridge Fuses	250A SP Size 1 Fuse Base	0170 00	P	N/A
Cartridge Fuses	250A SP Size 1 Fuse Base+M/SW	0170 02	P	N/A
Cartridge Fuses	250A TP Size 1 Fuse Base	0170 03	P	N/A
Cartridge Fuses	400A SP Size 2 Fuse Base	0175 00	P	N/A
Cartridge Fuses	400A SP Size 2 Fuse Base+M/SW	0175 02	P	N/A
Cartridge Fuses	400A TP Size 2 Fuse Base	0175 03	P	N/A
Cartridge Fuses	Separation Dividers Size 00	0199 09	P	N/A
Cartridge Fuses	Separation Dividers Size 0	0199 15	P	N/A
Cartridge Fuses	Separation Dividers Size 1	0199 16	P	N/A
Cartridge Fuses	Separation Dividers Size 2	0199 17	P	N/A
Cartridge Fuses	Blade Fuse Terminal Shield Size 00	0199 20	P	N/A
Cartridge Fuses	Blade Fuse Terminal Shield Size 0	0199 21	P	N/A
Cartridge Fuses	Blade Fuse Terminal Shield Size 1	0199 22	P	N/A
Cartridge Fuses	Blade Fuse Terminal Shield Size 2	0199 23	P	N/A
MCB	80A SP Type C 16kA MCB	0063 83	4091 40	56
MCB	80A DP Type C 16kA MCB	0064 75	4092 28	56
MCB	100A DP Type C 16kA MCB	0064 76	4092 29	56
MCB	125A DP Type C 16kA MCB	0064 77	4092 30	56
MCB	80A 3P Type C 16kA MCB	0064 95	4092 80	56
MCB	100A 3P Type C 16kA MCB	0064 96	4092 81	56
MCB	125A 3P Type C 16kA MCB	0064 97	4092 82	56
MCB	80A 4P Type C 16kA MCB	0065 70	4093 62	56
MCB	100A 4P Type C 16kA MCB	0065 71	4093 63	56
MCB	125A 4P Type C 16kA MCB	0065 72	4093 64	56
MCB	1A SP Type D 10kA MCB	0065 75	4079 63	57
MCB	2A SP Type D 10kA MCB	0065 76	4094 25	57
MCB	3A SP Type D 10kA MCB	0065 77	4079 65	57
MCB	4A SP Type D 10kA MCB	0065 78	4079 66	57
MCB	6A SP Type D 10kA MCB	0065 79	4094 28	57
MCB	10A SP Type D 10kA MCB	0065 81	4094 30	57
MCB	16A SP Type D 10kA MCB	0065 83	4094 32	57
MCB	20A SP Type D 10kA MCB	0065 84	4094 33	57
MCB	25A SP Type D 10kA MCB	0065 85	4094 34	57
MCB	32A SP Type D 10kA MCB	0065 86	4094 35	57
MCB	40A SP Type D 10kA MCB	0065 87	4094 36	57
MCB	50A SP Type D 10kA MCB	0065 88	4094 37	57
MCB	63A SP Type D 10kA MCB	0065 89	4094 38	57
MCB	1A DP Type D 10kA MCB	0066 25	4080 23	57
MCB	2A DP Type D 10kA MCB	0066 26	4094 44	57
MCB	3A DP Type D 10kA MCB	0066 27	4080 25	57
MCB	4A DP Type D 10kA MCB	0066 28	4080 26	57
MCB	6A DP Type D 10kA MCB	0066 29	4094 47	57
MCB	10A DP Type D 10kA MCB	0066 31	4094 49	57
MCB	16A DP Type D 10kA MCB	0066 33	4094 51	57
MCB	20A DP Type D 10kA MCB	0066 34	4094 52	57
MCB	25A DP Type D 10kA MCB	0066 35	4094 53	57
MCB	32A DP Type D 10kA MCB	0066 36	4094 54	57
MCB	40A DP Type D 10kA MCB	0066 37	4094 55	57
MCB	50A DP Type D 10kA MCB	0066 38	4094 56	57
MCB	63A DP Type D 10kA MCB	0066 39	4094 57	57
MCB	80A DP Type D 16kA MCB	0066 40	4094 58	57
MCB	100A DP Type D 16kA MCB	0066 41	4094 59	57
MCB	125A DP Type D 16kA MCB	0066 42	4094 60	57
MCB	1A 3P Type D 10kA MCB	0066 45	4080 81	57
MCB	2A 3P Type D 10kA MCB	0066 46	4094 92	57
MCB	3A 3P Type D 10kA MCB	0066 47	4080 83	57
MCB	4A 3P Type D 10kA MCB	0066 48	4080 84	57
MCB	6A 3P Type D 10kA MCB	0066 49	4094 95	57
MCB	10A 3P Type D 10kA MCB	0066 51	4094 97	57
MCB	16A 3P Type D 10kA MCB	0066 53	4094 99	57
MCB	20A 3P Type D 10kA MCB	0066 54	4095 00	57
MCB	25A 3P Type D 10kA MCB	0066 55	4095 01	57
MCB	32A 3P Type D 10kA MCB	0066 56	4095 02	57
MCB	40A 3P Type D 10kA MCB	0066 57	4095 03	57

Status : P = Phase out
N/A = No direct replacement available. Please contact us on +44 (0) 845 605 4333.

Cross-reference tables

POWER PROTECTION (cont)				
Range	Description	Old Cat. No.	New Cat. No. / status	Page No.
MCB	50A 3P Type D 10kA MCB	0066 58	4095 04	57
MCB	63A 3P Type D 10kA MCB	0066 59	4095 05	57
MCB	80A 3P Type D 16kA MCB	0066 60	4095 06	57
MCB	100A 3P Type D 16kA MCB	0066 61	4095 07	57
MCB	125A 3P Type D 16kA MCB	0066 62	4095 08	57
MCB	1A 4P Type D 10kA MCB	0066 65	P	N/A
MCB	2A 4P Type D 10kA MCB	0066 66	4095 26	57
MCB	3A 4P Type D 10kA MCB	0066 67	P	N/A
MCB	4A 4P Type D 10kA MCB	0066 68	P	N/A
MCB	6A 4P Type D 10kA MCB	0066 69	4095 29	57
MCB	10A 4P Type D 10kA MCB	0066 71	4095 31	57
MCB	16A 4P Type D 10kA MCB	0066 73	4095 33	57
MCB	20A 4P Type D 10kA MCB	0066 74	4095 34	57
MCB	25A 4P Type D 10kA MCB	0066 75	4095 35	57
MCB	32A 4P Type D 10kA MCB	0066 76	4095 36	57
MCB	40A 4P Type D 10kA MCB	0066 77	4095 37	57
MCB	50A 4P Type D 10kA MCB	0066 78	4095 38	57
MCB	63A 4P Type D 10kA MCB	0066 79	4095 39	57
MCB	80A 4P Type D 16kA MCB	0066 80	4095 40	57
MCB	100A 4P Type D 16kA MCB	0066 81	4095 41	57
MCB	125A 4P Type D 16kA MCB	0066 82	4095 42	57
MCB	1A SP Type B 16kA MCB	0066 91	4088 65	56
MCB	2A SP Type B 16kA MCB	0066 92	4088 66	56
MCB	3A SP Type B 16kA MCB	0066 93	4088 67	56
MCB	6A SP Type B 16kA MCB	0066 95	4088 69	56
MCB	10A SP Type B 16kA MCB	0066 97	4088 70	56
MCB	16A SP Type B 16kA MCB	0067 00	4088 72	56
MCB	20A SP Type B 16kA MCB	0067 01	4088 73	56
MCB	25A SP Type B 16kA MCB	0067 02	4088 74	56
MCB	32A SP Type B 16kA MCB	0067 03	4088 75	56
MCB	40A SP Type B 16kA MCB	0067 04	4088 76	56
MCB	63A SP Type B 16kA MCB	0067 06	4088 78	56
MCB	1A DP Type B 16kA MCB	0067 52	4089 35	56
MCB	2A DP Type B 16kA MCB	0067 53	4089 36	56
MCB	3A DP Type B 16kA MCB	0067 54	4089 37	56
MCB	6A DP Type B 16kA MCB	0067 56	4089 39	56
MCB	10A DP Type B 16kA MCB	0067 58	4089 40	56
MCB	16A DP Type B 16kA MCB	0067 60	4089 42	56
MCB	20A DP Type B 16kA MCB	0067 61	4089 43	56
MCB	25A DP Type B 16kA MCB	0067 62	4089 44	56
MCB	32A DP Type B 16kA MCB	0067 63	4089 45	56
MCB	40A DP Type B 16kA MCB	0067 64	4089 46	56
MCB	63A DP Type B 16kA MCB	0067 66	4089 48	56
MCB	1A 3P Type B 16kA MCB	0067 72	4089 84	56
MCB	2A 3P Type B 16kA MCB	0067 73	4089 85	56
MCB	3A 3P Type B 16kA MCB	0067 74	4089 86	56
MCB	6A 3P Type B 16kA MCB	0067 76	4089 88	56
MCB	10A 3P Type B 16kA MCB	0067 78	4089 89	56
MCB	16A 3P Type B 16kA MCB	0067 80	4089 91	56
MCB	20A 3P Type B 16kA MCB	0067 81	4089 92	56
MCB	25A 3P Type B 16kA MCB	0067 82	4089 93	56
MCB	32A 3P Type B 16kA MCB	0067 83	4089 94	56
MCB	40A 3P Type B 16kA MCB	0067 84	4089 95	56
MCB	50A 3P Type B 16kA MCB	0067 85	4089 96	56
MCB	63A 3P Type B 16kA MCB	0067 86	4089 97	56
MCB	1A 4P Type B 16kA MCB	0068 32	4090 58	56
MCB	6A 4P Type B 16kA MCB	0068 36	4090 62	56
MCB	10A 4P Type B 16kA MCB	0068 38	4090 63	56
MCB	16A 4P Type B 16kA MCB	0068 40	4090 65	56
MCB	20A 4P Type B 16kA MCB	0068 41	4090 66	56
MCB	25A 4P Type B 16kA MCB	0068 42	4090 67	56
MCB	32A 4P Type B 16kA MCB	0068 43	4090 68	56
MCB	40A 4P Type B 16kA MCB	0068 44	4090 69	56
MCB	50A 4P Type B 16kA MCB	0068 45	4090 70	56
MCB	63A 4P Type B 16kA MCB	0068 46	4090 71	56
MCB	1A SP Type C 16kA MCB	0068 52	4091 07	56
MCB	2A SP Type C 16kA MCB	0068 53	4091 08	56
MCB	3A SP Type C 16kA MCB	0068 54	4091 09	56
MCB	6A SP Type C 16kA MCB	0068 56	4091 11	56
MCB	10A SP Type C 16kA MCB	0068 58	4091 12	56
MCB	16A SP Type C 16kA MCB	0068 60	4091 14	56
MCB	20A SP Type C 16kA MCB	0068 61	4091 15	56
MCB	25A SP Type C 16kA MCB	0068 62	4091 16	56
MCB	32A SP Type C 16kA MCB	0068 63	4091 17	56

POWER PROTECTION (cont)				
Range	Description	Old Cat. No.	New Cat. No. / status	Page No.
MCB	40A SP Type C 16kA MCB	0068 64	4091 18	56
MCB	50A SP Type C 16kA MCB	0068 65	4091 19	56
MCB	63A SP Type C 16kA MCB	0068 66	4091 20	56
MCB	1A DP Type C 16kA MCB	0069 12	4091 95	56
MCB	2A DP Type C 16kA MCB	0069 13	4091 96	56
MCB	3A DP Type C 16kA MCB	0069 14	4091 97	56
MCB	6A DP Type C 16kA MCB	0069 16	4091 99	56
MCB	10A DP Type C 16kA MCB	0069 18	4092 00	56
MCB	16A DP Type C 16kA MCB	0069 20	4092 02	56
MCB	20A DP Type C 16kA MCB	0069 21	4092 03	56
MCB	25A DP Type C 16kA MCB	0069 22	4092 04	56
MCB	32A DP Type C 16kA MCB	0069 23	4092 05	56
MCB	40A DP Type C 16kA MCB	0069 24	4092 06	56
MCB	50A DP Type C 16kA MCB	0069 25	4092 07	56
MCB	63A DP Type C 16kA MCB	0069 26	4092 08	56
MCB	1A 3P Type C 16kA MCB	0069 32	4092 47	56
MCB	2A 3P Type C 16kA MCB	0069 33	4092 48	56
MCB	3A 3P Type C 16kA MCB	0069 34	4092 49	56
MCB	6A 3P Type C 16kA MCB	0069 36	4092 51	56
MCB	10A 3P Type C 16kA MCB	0069 38	4092 52	56
MCB	16A 3P Type C 16kA MCB	0069 40	4092 54	56
MCB	20A 3P Type C 16kA MCB	0069 41	4092 55	56
MCB	25A 3P Type C 16kA MCB	0069 42	4092 56	56
MCB	32A 3P Type C 16kA MCB	0069 43	4092 57	56
MCB	40A 3P Type C 16kA MCB	0069 44	4092 58	56
MCB	50A 3P Type C 16kA MCB	0069 45	4092 59	56
MCB	63A 3P Type C 16kA MCB	0069 46	4092 60	56
MCB	1A 4P Type C 16kA MCB	0069 92	4093 29	56
MCB	2A 4P Type C 16kA MCB	0069 93	4093 30	56
MCB	3A 4P Type C 16kA MCB	0069 94	4093 31	56
MCB	6A 4P Type C 16kA MCB	0069 96	4093 33	56
MCB	10A 4P Type C 16kA MCB	0069 98	4093 34	56
MCB	16A 4P Type C 16kA MCB	0070 00	4093 36	56
MCB	20A 4P Type C 16kA MCB	0070 01	4093 37	56
MCB	25A 4P Type C 16kA MCB	0070 02	4093 38	56
MCB	32A 4P Type C 16kA MCB	0070 03	4093 39	56
MCB	40A 4P Type C 16kA MCB	0070 04	4093 40	56
MCB	50A 4P Type C 16kA MCB	0070 05	4093 41	56
MCB	63A 4P Type C 16kA MCB	0070 06	4093 42	56
MCB	Aux C/O Switch 0-5 Mod	0073 50	4062 58	58
MCB	Fault Signalling 0-5 Mod	0073 51	4062 60	58
MCB	Aux C/O or Fault Signal	0073 53	4062 62	58
MCB	C/O+FS or 2 C/O Switch 1M	0073 54	4062 66	58
MCCB	DPX-E125 16A 1P 16kA MCCB	0250 00	P	N/A
MCCB	DPX-E125 20A 1P 16kA MCCB	0250 01	P	N/A
MCCB	DPX-E125 25A 1P 16kA MCCB	0250 02	P	N/A
MCCB	DPX-E125 32A 1P 16kA MCCB	0250 03	P	N/A
MCCB	DPX-E125 40A 1P 16kA MCCB	0250 04	P	N/A
MCCB	DPX-E125 50A 1P 16kA MCCB	0250 05	P	N/A
MCCB	DPX-E125 63A 1P 16kA MCCB	0250 06	P	N/A
MCCB	DPX-E125 80A 1P 16kA MCCB	0250 07	P	N/A
MCCB	DPX-E125 100A 1P 16kA MCCB	0250 08	P	N/A
MCCB	DPX-E125 125A 1P 16kA MCCB	0250 09	P	N/A
MCCB	DPX-E125 16A 3P 16kA MCCB	0250 16	P	N/A
MCCB	DPX-E125 25A 3P 16kA MCCB	0250 17	P	N/A
MCCB	DPX-E125 40A 3P 16kA MCCB	0250 18	P	N/A
MCCB	DPX-E125 63A 3P 16kA MCCB	0250 19	P	N/A
MCCB	DPX-E125 100A 3P 16kA MCCB	0250 20	P	N/A
MCCB	DPX-E125 125A 3P 16kA MCCB	0250 21	P	N/A
MCCB	DPX-E125 16A 4P 16kA MCCB	0250 24	P	N/A
MCCB	DPX-E125 25A 4P 16kA MCCB	0250 25	P	N/A
MCCB	DPX-E125 40A 4P 16kA MCCB	0250 26	P	N/A
MCCB	DPX-E125 63A 4P 16kA MCCB	0250 27	P	N/A
MCCB	DPX-E125 100A 4P 16kA MCCB	0250 28	P	N/A
MCCB	DPX-E125 125A 4P 16kA MCCB	0250 29	P	N/A
MCCB	DPX125 16A 3P 25kA MCCB	0250 36	P	N/A
MCCB	DPX125 25A 3P 25kA MCCB	0250 37	P	N/A
MCCB	DPX125 40A 3P 25kA MCCB	0250 38	P	N/A
MCCB	DPX125 63A 3P 25kA MCCB	0250 39	P	N/A
MCCB	DPX125 100A 3P 25kA MCCB	0250 40	P	N/A
MCCB	DPX125 125A 3P 25kA MCCB	0250 41	P	N/A
MCCB	DPX125 16A 4P 25kA MCCB	0250 44	P	N/A
MCCB	DPX125 25A 4P 25kA MCCB	0250 45	P	N/A
MCCB	DPX125 40A 4P 25kA MCCB	0250 46	P	N/A

Status : P = Phase out
N/A = No direct replacement available. Please contact us on +44 (0) 845 605 4333.

Cross-reference tables

POWER PROTECTION (cont)				
Range	Description	Old Cat. No.	New Cat. No. / status	Page No.
MCCB	DPX125 63A 4P 25kA MCCB	0250 47	P	N/A
MCCB	DPX125 100A 4P 25kA MCCB	0250 48	P	N/A
MCCB	DPX125 125A 4P 25kA MCCB	0250 49	P	N/A
MCCB	DPX125 16A 3P 36kA MCCB	0250 50	P	N/A
MCCB	DPX125 25A 3P 36kA MCCB	0250 51	P	N/A
MCCB	DPX125 40A 3P 36kA MCCB	0250 52	P	N/A
MCCB	DPX125 63A 3P 36kA MCCB	0250 53	P	N/A
MCCB	DPX125 100A 3P 36kA MCCB	0250 54	P	N/A
MCCB	DPX125 125A 3P 36kA MCCB	0250 55	P	N/A
MCCB	DPX125 16A 4P 36kA MCCB	0250 58	P	N/A
MCCB	DPX125 25A 4P 36kA MCCB	0250 59	P	N/A
MCCB	DPX125 40A 4P 36kA MCCB	0250 60	P	N/A
MCCB	DPX125 63A 4P 36kA MCCB	0250 61	P	N/A
MCCB	DPX125 100A 4P 36kA MCCB	0250 62	P	N/A
MCCB	DPX125 125A 4P 36kA MCCB	0250 63	P	N/A
MCCB	DPX-I 125 125A 3P M/C Switch	0250 98	P	N/A
MCCB	DPX-I 125 125A 4P M/C Switch	0250 99	P	N/A
MCCB	DPX250ER 25A 3P 25kA MCCB	0252 01	P	N/A
MCCB	DPX250ER 40A 3P 25kA MCCB	0252 02	P	N/A
MCCB	DPX250ER 63A 3P 25kA MCCB	0252 03	P	N/A
MCCB	DPX250ER 100A 3P 25kA MCCB	0252 04	P	N/A
MCCB	DPX250ER 160A 3P 25kA MCCB	0252 05	P	N/A
MCCB	DPX250ER 250A 3P 25kA MCCB	0252 06	P	N/A
MCCB	DPX250ER 25A 4P 25kA MCCB	0252 11	P	N/A
MCCB	DPX250ER 40A 4P 25kA MCCB	0252 12	P	N/A
MCCB	DPX250ER 63A 4P 25kA MCCB	0252 13	P	N/A
MCCB	DPX250ER 100A 4P 25kA MCCB	0252 14	P	N/A
MCCB	DPX250ER 160A 4P 25kA MCCB	0252 15	P	N/A
MCCB	DPX250ER 250A 4P 25kA MCCB	0252 16	P	N/A
MCCB	DPX250ER 40A 3P 36kA MCCB	0252 22	P	N/A
MCCB	DPX250ER 63A 3P 36kA MCCB	0252 23	P	N/A
MCCB	DPX250ER 100A 3P 36kA MCCB	0252 24	P	N/A
MCCB	DPX250ER 160A 3P 36kA MCCB	0252 25	P	N/A
MCCB	DPX250ER 250A 3P 36kA MCCB	0252 26	P	N/A
MCCB	DPX250ER 200A 3P 36kA MCCB	0252 30	P	N/A
MCCB	DPX250ER 25A 4P 36kA MCCB	0252 31	P	N/A
MCCB	DPX250ER 40A 4P 36kA MCCB	0252 32	P	N/A
MCCB	DPX250ER 63A 4P 36kA MCCB	0252 33	P	N/A
MCCB	DPX250ER 100A 4P 36kA MCCB	0252 34	P	N/A
MCCB	DPX250ER 160A 4P 36kA MCCB	0252 35	P	N/A
MCCB	DPX250ER 250A 4P 36kA MCCB	0252 36	P	N/A
MCCB	DPX250ER 200A 4P 36kA MCCB	0252 37	P	N/A
MCCB	DPX-I 250ER 160A 3P M/C Switch	0252 96	P	N/A
MCCB	DPX-I 250ER 160A 4P M/C Switch	0252 97	P	N/A
MCCB	DPX-I 250ER 250A 3P M/C Switch	0252 98	P	N/A
MCCB	DPX-I 250ER 250A 4P M/C Switch	0252 99	P	N/A
MCCB	DPX250 100A 3P 36kA MCCB	0253 30	P	N/A
MCCB	DPX250 160A 3P 36kA MCCB	0253 31	P	N/A
MCCB	DPX250 250A 3P 36kA MCCB	0253 32	P	N/A
MCCB	DPX250 100A 4P 36kA MCCB	0253 47	P	N/A
MCCB	DPX250 160A 4P 36kA MCCB	0253 48	P	N/A
MCCB	DPX250 250A 4P 36kA MCCB	0253 49	P	N/A
MCCB	DPX-H 250 100A 3P 70kA MCCB	0253 54	P	N/A
MCCB	DPX-H 250 160A 3P 70kA MCCB	0253 55	P	N/A
MCCB	DPX-H 250 250A 3P 70kA MCCB	0253 56	P	N/A
MCCB	DPX-H 250 100A 4P 70kA MCCB	0253 71	P	N/A
MCCB	DPX-H 250 160A 4P 70kA MCCB	0253 72	P	N/A
MCCB	DPX-H 250 250A 4P 70kA MCCB	0253 73	P	N/A
MCCB	DPX-I 250 250A 3P M/C Switch	0253 98	P	N/A
MCCB	DPX-I 250 250A 4P M/C Switch	0253 99	P	N/A
MCCB	DPX630 250A 3P 36kA MCCB	0255 21	P	N/A
MCCB	DPX630 320A 3P 36kA MCCB	0255 22	P	N/A
MCCB	DPX630 400A 3P 36kA MCCB	0255 23	P	N/A
MCCB	DPX630 630A 3P 36kA MCCB	0255 24	P	N/A
MCCB	DPX630 250A 4P 36kA MCCB	0255 36	P	N/A
MCCB	DPX630 320A 4P 36kA MCCB	0255 37	P	N/A
MCCB	DPX630 400A 4P 36kA MCCB	0255 38	P	N/A
MCCB	DPX630 630A 4P 36kA MCCB	0255 40	P	N/A
MCCB	DPX630-H 250A 3P 70kA MCCB	0255 41	P	N/A
MCCB	DPX630-H 320A 3P 70kA MCCB	0255 42	P	N/A
MCCB	DPX630-H 400A 3P 70kA MCCB	0255 43	P	N/A
MCCB	DPX630 630A 3P 70kA MCCB	0255 44	P	N/A
MCCB	DPX630 250A 4P 70kA MCCB	0255 56	P	N/A
MCCB	DPX630 320A 4P 70kA MCCB	0255 57	P	N/A

POWER PROTECTION (cont)				
Range	Description	Old Cat. No.	New Cat. No. / status	Page No.
MCCB	DPX630 400A 4P 70kA MCCB	0255 58	P	N/A
MCCB	DPX630 630A 4P 70kA MCCB	0255 60	P	N/A
MCCB	DPX-I 630A 3P M/Case Switch	0255 88	P	N/A
MCCB	DPX-I 630A 4P M/Case Switch	0255 89	P	N/A
MCCB	DPX-I 630 400A 3P M/C Switch	0255 96	P	N/A
MCCB	DPX-I 630 400A 4P M/C Switch	0255 97	P	N/A
MCCB	DPX-I 1600 630A 3P M/C Switch	0257 92	P	N/A
MCCB	DPX-I 1600 630A 4P M/C Switch	0257 93	P	N/A
MCCB	DPX-I 1600 800A 3P M/C Switch	0257 94	P	N/A
MCCB	DPX-I 1600 800A 4P M/C Switch	0257 95	P	N/A
MCCB	DPX1250 500A 3P 50kA MCCB	0258 00	P	N/A
MCCB	DPX1250 630A 3P 50kA MCCB	0258 01	P	N/A
MCCB	DPX1250 800A 3P 50kA MCCB	0258 02	P	N/A
MCCB	DPX1250 500A 3P+N 50kA MCCB	0258 07	P	N/A
MCCB	DPX1250 630A 3P+N 50kA MCCB	0258 08	P	N/A
MCCB	DPX1250 800A 3P+N 50kA MCCB	0258 09	P	N/A
MCCB	DPX1250-H 500A 3P 70kA MCCB	0258 14	P	N/A
MCCB	DPX1250-H 630A 3P 70kA MCCB	0258 15	P	N/A
MCCB	DPX1250-H 800A 3P 70kA MCCB	0258 16	P	N/A
MCCB	DPX1250-H 630A 3P+N 70kA MCCB	0258 22	P	N/A
MCCB	DPX1250-H 800A 3P+N 70kA MCCB	0258 23	P	N/A
MCCB	DPX125 125A 4P E/L Mod Under	0260 14	P	N/A
MCCB	DPX250ER 250A 4P E/L Mod Under	0260 38	P	N/A
MCCB	DPX250 3P MCCB Elect E/L Mod	0260 54	P	N/A
MCCB	DPX250 4P E/L Module Under	0260 55	P	N/A
MCCB	DPX400 3P MCCB Elect E/L Mod	0260 60	P	N/A
MCCB	DPX400 4P E/L Module Under	0260 61	P	N/A
MCCB	DPX630 3P MCCB Elect E/L Mod	0260 64	P	N/A
MCCB	DPX630 4P E/L Module Under	0260 65	P	N/A
MCCB	DPX MCCB Aux/Signal Contact	0261 60	P	N/A
MCCB	DPX MCCB Shunt Trip 24V AC/DC	0261 64	P	N/A
MCCB	DPX MCCB Shunt Trip 48V AC/DC	0261 65	P	N/A
MCCB	DPX MCCB Shunt Trip 110V AC/DC	0261 66	P	N/A
MCCB	DPX MCCB Shunt Trip 230V AC/DC	0261 67	P	N/A
MCCB	DPX MCCB Shunt Trip 400V AC/DC	0261 68	P	N/A
MCCB	DPX125 MCCB UV Release 24V DC	0261 70	P	N/A
MCCB	DPX125 MCCB UV Release 24V AC	0261 71	P	N/A
MCCB	DPX125 MCCB UV Release 48V DC	0261 72	P	N/A
MCCB	DPX125 MCCB UV Release 230V AC	0261 73	P	N/A
MCCB	DPX125 MCCB UV Release 400V AC	0261 74	P	N/A
MCCB	DPX250/1250 MCCB UV Rel 24V DC	0261 80	P	N/A
MCCB	DPX250/1250 MCCB UV Rel 24V AC	0261 81	P	N/A
MCCB	DPX250/1250 MCCB UV Rel 48V DC	0261 82	P	N/A
MCCB	DPX250/1250 MCCB UV Rel 230V AC	0261 83	P	N/A
MCCB	DPX250/1250 MCCB UV Rel 400V AC	0261 84	P	N/A
MCCB	DPX125 MCCB Padlock Accessory	0262 00	P	N/A
MCCB	DPX125 Terminal Shield 3P	0262 05	P	N/A
MCCB	DPX125 Terminal Shield 4P	0262 06	P	N/A
MCCB	DPX125 Insulating Shields	0262 07	P	N/A
MCCB	DPX125 DIN Rail Mounting Plate	0262 08	P	N/A
MCCB	DPX250ER DIN Rail Mounting Plate	0262 09	P	N/A
MCCB	DPX250 MCCB Padlock Accessory	0262 21	P	N/A
MCCB	DPX250 Terminal Shield 3P	0262 26	P	N/A
MCCB	DPX250 Terminal Shield 4P	0262 27	P	N/A
MCCB	DPX250/630 Insulating Shields	0262 30	P	N/A
MCCB	DPX250 4no Connection Terms	0262 35	P	N/A
MCCB	DPX630 MCCB Padlock Accessory	0262 40	P	N/A
MCCB	DPX630 Terminal Shield 3P	0262 44	P	N/A
MCCB	DPX630 Terminal Shield 4P	0262 45	P	N/A
MCCB	DPX630 4no Connection Terms	0262 50	P	N/A
MCCB	DPX630 4no High Cap Conn Terms	0262 51	P	N/A
MCCB	DPX1600 MCCB Padlock Accessory	0262 60	P	N/A
MCCB	DPX1600 Terminal Shield 3P	0262 64	P	N/A
MCCB	DPX1600 Terminal Shield 4P	0262 65	P	N/A
MCCB	DPX1600 Insulating Shields	0262 66	P	N/A
MCCB	DPX1600 Ext Front Short Terms	0262 67	P	N/A
MCCB	DPX1600 Ext Front Long Terms	0262 68	P	N/A
MCCB	DPX1600 4no Connection Terms	0262 69	P	N/A
MCCB	DPX1600 4no High Cap Con Terms	0262 70	P	N/A
MCCB	DPX250ER Terminal Shield 3P	0262 85	P	N/A
MCCB	DPX250ER Terminal Shield 4P	0262 86	P	N/A
MCCB	DPX250ER 4no Connection Terms	0262 88	P	N/A
MCCB	DPX250ER 3P Spreader Links	0262 90	P	N/A
MCCB	DPX250ER 4P Spreader Links	0262 91	P	N/A

Status : P = Phase out
N/A = No direct replacement available. Please contact us on +44 (0) 845 605 4333.

Cross-reference tables

POWER PROTECTION (cont)				
Range	Description	Old Cat. No.	New Cat. No. / status	Page No.
Metering	Ammeter Unit Less Dial And Ct	0046 00	P	N/A
Metering	Ammeter 0-30A AC/DC	0046 02	P	N/A
Metering	Dial For Cat. No. 0046 00 0-50A	0046 10	P	N/A
Metering	Dial For Cat. No. 0046 00 0-100A	0046 13	P	N/A
Metering	Dial For Cat. No. 0046 00 0-200A	0046 15	P	N/A
Metering	Dial For Cat. No. 0046 00 0-300A	0046 17	P	N/A
Metering	Dial For Cat. No. 0046 00 0-400A	0046 18	P	N/A
Metering	Dial For Cat. No. 0046 00 0-600A	0046 20	P	N/A
Metering	Dial For Cat. No. 0046 00 0-800A	0046 21	P	N/A
Metering	Dial For Cat. No. 0046 00 0-1000A	0046 22	P	N/A
Metering	Lexic Ammeter Dial 0-1500A	0046 24	P	N/A
Metering	Lexic Ammeter Dial 0-2000A	0046 25	P	N/A
Metering	4 Pos Ammeter Selector SW	0046 50	P	N/A
Metering	4 Pos Voltmeter Selector SW	0046 52	P	N/A
Metering	7 Pos Voltmeter Selector SW	0046 53	P	N/A
Metering	Analogue Voltmeter	0046 60	P	N/A
Metering	Digital Ammeter Voltmeter	0046 63	P	N/A
Metering	Digital Frequency Meter	0046 64	P	N/A
Metering	Rex 2000 24V Hours Run Meter	0046 91	P	N/A
Metering	Rex 2000 230V Hours Run Meter	0046 94	P	N/A
Modular Device Accessories	Modular Spacer Unit (Full)	0044 41	P	N/A
Modular Device Accessories	Prong Busbar Comb 4/25mm Conn	0049 05	4049 05	75
Modular Device Accessories	Prong Busbar Comb 6/35mm Conn	0049 06	4049 06	75
Modular Device Accessories	Lexic 13x1P Prong Busbar Comb	0049 26	4049 26	75
Modular Device Accessories	Lexic 57x1P Prong Busbar Comb	0049 37	4049 37	75
Modular Device Accessories	Lexic 6x2P Prong Busbar Comb	0049 38	4049 38	75
Modular Device Accessories	Busbar Comb 28 Double Pole	0049 39	4049 39	75
Modular Device Accessories	Lexic 4x3P Prong Busbar Comb	0049 42	4049 42	75
Modular Device Accessories	Busbar Comb 19 Triple Pole	0049 43	4049 43	75
Modular Device Accessories	Lexic 3x4P Prong Busbar Comb	0049 44	4049 44	75
Modular Device Accessories	Lexic Busbar Comb Prong Cover	0049 88	4049 88	75
RCBO	RCBO C10 2P 10mA AC	0077 45	4111 49	64
RCBO	RCBO C16 2P 10mA AC	0077 46	4111 50	64
RCBO	RCBO C20 2P 10mA AC	0077 47	4111 51	64
RCBO	RCBO B6 SP+N 30mA AC	0077 77	4109 18	63
RCBO	RCBO B10 SP+N 30mA AC	0077 78	4109 19	63
RCBO	RCBO B16 SP+N 30mA AC	0077 80	4109 21	63
RCBO	RCBO B20 SP+N 30mA AC	0077 81	4109 22	63
RCBO	RCBO B32 SP+N 30mA AC	0077 83	4109 24	63
RCBO	RCBO B40 SP+N 30mA AC	0077 84	4109 25	63
RCBO	RCBO C16 SP+N 10mA AC	0078 79	4109 93	63
RCBO	RCBO C3 SP+N 30mA AC	0078 81	4109 97	63
RCBO	RCBO C6 SP+N 30mA AC	0078 83	4109 99	63
RCBO	RCBO C10 SP+N 30mA AC	0078 84	4110 00	63
RCBO	RCBO C16 SP+N 30mA AC	0078 86	4110 02	63
RCBO	RCBO C20 SP+N 30mA AC	0078 87	4110 03	63
RCBO	RCBO C25 SP+N 30mA AC	0078 88	4110 04	63
RCBO	RCBO C32 SP+N 30mA AC	0078 89	4110 05	63
RCBO	RCBO C40 SP+N 30mA AC	0078 90	4110 06	63
RCBO	RCBO C6 SP+N 300mA AC	0078 94	4110 21	63
RCBO	RCBO C10 SP+N 300mA AC	0078 95	4110 22	63
RCBO	RCBO C16 SP+N 300mA AC	0078 97	4110 24	63
RCBO	RCBO C20 SP+N 300mA AC	0078 98	4110 25	63
RCBO	RCBO C25 SP+N 300mA AC	0078 99	4110 26	63
RCBO	RCBO C32 SP+N 300mA AC	0079 00	4110 27	63
RCBO	RCBO C40 SP+N 300mA AC	0079 01	4110 28	63
RCBO	RCBO C10 2P 30mA AC	0079 11	4111 57	64
RCBO	RCBO C16 2P 30mA AC	0079 19	4111 58	64
RCBO	RCBO C20 2P 30mA AC	0079 20	4111 59	64
RCBO	RCBO C25 2P 30mA AC	0079 21	4111 60	64
RCBO	RCBO C32 2P 30mA AC	0079 22	4111 61	64
RCBO	RCBO C40 2P 30mA AC	0079 29	4111 62	64
RCBO	RCBO C50 2P 30mA AC	0079 30	4111 63	64
RCBO	RCBO C60 2P 30mA AC	0079 31	4111 64	64
RCBO	RCBO C10 4P 30mA AC	0079 62	4111 85	64
RCBO	RCBO C16 4P 30mA AC	0079 64	4111 86	64
RCBO	RCBO C20 4P 30mA AC	0079 65	4111 87	64
RCBO	RCBO C25 4P 30mA AC	0079 66	4111 88	64
RCBO	RCBO C32 4P 30mA AC	0079 67	4111 89	64
RCBO	RCBO C40 4P 30mA AC	0079 75	4112 04	64
RCBO	RCBO C50 4P 30mA AC	0079 77	4112 05	64
RCBO	RCBO C63 4P 30mA AC	0079 78	4112 06	64
RCBO	RCBO C10 4P 300mA AC	0079 79	4112 07	64
RCBO	RCBO C16 4P 300mA AC	0079 80	4112 08	64

POWER PROTECTION (cont)				
Range	Description	Old Cat. No.	New Cat. No. / status	Page No.
RCBO	RCBO C20 4P 300mA AC	0080 13	4111 90	64
RCBO	RCBO C25 4P 300mA AC	0080 14	4111 91	64
RCBO	RCBO C32 4P 300mA AC	0080 15	4111 92	64
RCBO	RCBO C40 4P 300mA AC	0080 31	4112 09	64
RCBO	RCBO C50 4P 300mA AC	0080 32	4112 10	64
RCBO	RCBO C63 4P 300mA AC	0080 33	4112 11	64
RCD	80A 4P 30mA AC Left	0086 96	P	N/A
RCD	80A 4P 300mA AC Left	0087 14	P	N/A
RCD	16A DP 10mA AC	0089 06	4115 00	61
RCD	25A DP 30mA AC	0089 09	4115 04	61
RCD	40A DP 30mA AC	0089 10	4115 05	61
RCD	63A DP 30mA AC	0089 11	4115 06	61
RCD	80A DP 30mA AC	0089 12	4115 07	61
RCD	25A DP 100mA AC	0089 15	4115 14	61
RCD	40A DP 100mA AC	0089 16	4115 15	61
RCD	63A DP 100mA AC	0089 17	4115 16	61
RCD	80A DP 100mA AC	0089 18	4115 17	61
RCD	25A DP 300mA AC	0089 27	4115 24	61
RCD	40A DP 300mA AC	0089 28	4115 25	61
RCD	63A DP 300mA AC	0089 29	4115 26	61
RCD	80A DP 300mA AC	0089 30	4115 27	61
RCD	63A Discriminating DP 300mA AC	0089 35	4115 43	61
RCD	25A 4P 30mA AC	0089 93	4117 02	61
RCD	40A 4P 30mA AC	0089 94	4117 03	61
RCD	63A 4P 30mA AC	0089 95	4117 04	61
RCD	80A 4P 30mA AC	0089 96	4117 05	61
RCD	25A 4P 100mA AC	0089 99	4117 12	61
RCD	40A 4P 100mA AC	0090 00	4117 13	61
RCD	63A 4P 100mA AC	0090 01	4117 14	61
RCD	80A 4P 100mA AC	0090 02	4117 15	61
RCD	25A 4P 300mA AC	0090 11	4117 22	61
RCD	40A 4P 300mA AC	0090 12	4117 23	61
RCD	63A 4P 300mA AC	0090 13	4117 24	61
RCD	80A 4P 300mA AC	0090 14	4117 25	61
RCD	40A Discriminating 4P 300mA AC	0090 18	4117 45	61
RCD	63A Discriminating 4P 300mA AC	0090 19	4117 46	61
RCD	25A 4P 500mA AC	0090 23	4117 32	61
RCD	40A 4P 500mA AC	0090 24	4117 33	61
RCD	63A 4P 500mA AC	0090 25	4117 34	61
RCD	80A 4P 500mA AC	0090 26	4117 35	61
RCD	16A DP 10mA A	0090 53	4115 50	61
RCD	25A DP 30mA A	0090 56	4115 54	61
RCD	40A DP 30mA A	0090 57	4115 55	61
RCD	63A DP 30mA A	0090 58	4115 56	61
RCD	80A DP 30mA A	0090 59	4115 57	61
RCD	25A DP 300mA A	0090 74	4115 69	61
RCD	40A DP 300mA A	0090 75	4115 70	61
RCD	63A DP 300mA A	0090 76	4115 71	61
RCD	80A DP 300mA A	0090 77	4115 72	61
RCD	63A Discriminating DP 300mA A	0090 82	4115 84	61
RCD	25A 4P 30mA A	0091 40	4117 59	61
RCD	40A 4P 30mA A	0091 41	4117 60	61
RCD	63A 4P 30mA A	0091 42	4117 61	61
RCD	80A 4P 30mA A	0091 43	4117 62	61
RCD	25A 4P 100mA A	0091 46	4117 69	61
RCD	40A 4P 100mA A	0091 47	4117 70	61
RCD	63A 4P 100mA A	0091 48	4117 71	61
RCD	80A 4P 100mA A	0091 49	4117 72	61
RCD	100A 4P 100mA A	0091 50	4117 73	61
RCD	25A 4P 300mA A	0091 58	4117 79	61
RCD	40A 4P 300mA A	0091 59	4117 80	61
RCD	63A 4P 300mA A	0091 60	4117 81	61
RCD	80A 4P 300mA A	0091 61	4117 82	61
RCD	100A 4P 300mA A	0091 62	4117 83	61
RCD	40A Discriminating 4P 300mA A	0091 65	4118 00	61
RCD	63A Discriminating 4P 300mA A	0091 66	4118 01	61
RCD	40A 4P 500mA A	0091 71	4117 90	61
RCD	63A 4P 500mA A	0091 72	4117 91	61
RCD	80A 4P 500mA A	0091 73	4117 92	61
RCD	100A DP 30mA AC	6027 10	4115 08	61
RCD	100A Discriminating DP 100mA AC	6027 11	4115 37	61

Status : P = Phase out
N/A = No direct replacement available. Please contact us on +44 (0) 845 605 4333.

Cross-reference tables

ISOLATION, CONTROL AND SIGNALLING				
Range	Description	Old Cat. No.	New Cat. No. / status	Page No.
Buzzers	Lexic Modular 24V AC Buzzer	0041 11	P	N/A
Buzzers	Lexic Modular 230V AC Buzzer	0041 13	P	N/A
Digital Times Switches	MicroRexPlus D21 230V 16A T/SW	6047 74	P	N/A
Digital Times Switches	MicroRexPlus D22 230V 16A T/SW	6047 77	P	N/A
Isolating Switches	Lexic 16A SP Isolator SW	0043 01	4064 00	84
Isolating Switches	Lexic 20A SP Isolator SW	0043 02	4064 01	84
Isolating Switches	Lexic 32A SP Isolator SW	0043 05	4064 03	84
Isolating Switches	Lexic 40A SP Isolator SW	0043 07	4064 11	84
Isolating Switches	Lexic 63A SP Isolator SW	0043 10	4064 12	84
Isolating Switches	Lexic 100A SP Isolator SW	0043 14	4064 23	84
Isolating Switches	Lexic 16A DP Isolator SW	0043 21	4064 31	84
Isolating Switches	Lexic 20A DP Isolator SW	0043 22	4064 32	84
Isolating Switches	Lexic 20A DP Isolator SW+Ind	0043 23	4064 36	84
Isolating Switches	Lexic 32A DP Isolator SW	0043 25	4064 34	84
Isolating Switches	Lexic 32A DP Isolator SW+Ind	0043 26	4064 38	84
Isolating Switches	Lexic 40A DP Isolator SW	0043 27	4064 40	84
Isolating Switches	Lexic 63A DP Isolator SW	0043 30	P	N/A
Isolating Switches	Lexic 63A DP Isolator Red SW	0043 31	4064 53	84
Isolating Switches	Lexic 100A DP Isolator SW	0043 34	P	N/A
Isolating Switches	Lexic 100A DP Isolator Red SW	0043 36	4064 55	84
Isolating Switches	Lexic 125A DP Isolator SW	0043 38	4064 50	84
Isolating Switches	Lexic 20A TP Isolator SW	0043 42	4064 57	84
Isolating Switches	Lexic 32A TP Isolator SW	0043 45	4064 59	84
Isolating Switches	Lexic 40A TP Isolator SW	0043 47	4064 60	84
Isolating Switches	Lexic 63A TP Isolator SW	0043 50	4064 61	84
Isolating Switches	Lexic 100A TP Isolator SW	0043 54	P	N/A
Isolating Switches	Lexic 100A TP Isolator Red SW	0043 55	4064 75	84
Isolating Switches	Lexic 125A TP Isolator SW	0043 58	4064 70	84
Isolating Switches	Lexic 20A FP Isolator SW	0043 62	4064 77	84
Isolating Switches	Lexic 32A FP Isolator SW	0043 65	4064 79	84
Isolating Switches	Lexic 40A FP Isolator SW	0043 67	4064 80	84
Isolating Switches	Lexic 63A FP Isolator SW	0043 70	4064 81	84
Isolating Switches	Lexic 100A 4P Isolator SW	0043 74	P	N/A
Isolating Switches	Lexic 100A FP Isolator Red SW	0043 75	4064 95	84
Isolating Switches	Lexic 125A FP Isolator SW	0043 78	4064 90	84
Isolating Switches	Spacing Unit 0-5 Mod	0044 40	4063 07	58
Isolating Switches	Lexic Locking Attachment	0044 42	4063 03	58
Isolating Switches	Lexic 4mm Dia Padlock	0044 43	4063 13	58
Isolating Switches	Lexic Sealable Screw Cover	0044 44	4063 04	58
Isolating Switches	Lexic Insulating Shield	0044 47	4063 05	58
Light Sensitive Switch	Microlux D 7 Day 1ch Timer	0037 21	4126 26	113
Power Contactors	CT 230V 2NO 40A Handle	0040 68	4125 45	99
Power Contactors	CT 230V 3NO 40A Handle	0040 69	4125 49	99
Power Contactors	CT 230V 4NO 40A Handle	0040 70	4125 53	99
Power Contactors	CT 230V 2NO 63A Handle	0040 75	4125 47	99
Power Contactors	CT 230V 3NO 63A Handle	0040 77	4125 50	99
Power Contactors	CT 230V 4NO 63A Handle	0040 78	4125 56	99
Power Contactors	COS FOR CT 40A 63A	0040 85	4124 31	98
Power Contactors	CT 24V NC+NO 16A	0041 14	4125 03	98
Power Contactors	CT 24V 2NO 25A	0041 16	4125 05	98
Power Contactors	CT 230V NC+NO 16A	0041 26	4125 21	98
Power Contactors	CT 230V 2NC 25A	0041 29	4125 24	98
Power Contactors	CT 230V 4NO 25A	0041 31	4125 35	98
Power Contactors	CT 230V 4NC 25A	0041 32	4125 36	98
Power Contactors	CT 230V 2NC+2NO 25A	0041 33	4125 33	98
Power Contactors	CT 230V 2NO 25A Handle	0041 47	4125 44	99
Power Contactors	COS For CT 2M 25A	0041 83	4124 30	98
Power Contactors	COS For LR And CT 1M 25A	0041 85	4124 29	98
Vistop	Vistop 63A 3P Side Handle	0225 16	P	N/A
Vistop	Vistop 63A 4P Side Handle	0225 18	P	N/A
Vistop	Vistop 100A 3P Side Handle	0225 25	P	N/A
Vistop	Vistop 100A 4P Side Handle	0225 27	P	N/A
Vistop	Vistop 125A 3P Side Handle	0225 44	P	N/A
Vistop	Vistop 125A 4P Side Handle	0225 46	P	N/A
Vistop	Vistop 160A 3P Side Handle	0225 54	P	N/A
Vistop	Vistop 160A 4P Side Handle	0225 56	P	N/A

PLUGS AND SOCKETS				
Range	Description	Old Cat. No.	New Cat. No. / status	Page No.
P17 Tempra	Surface Skt 230V 16A 2P+E IP67	0553 03	5553 54	183
P17 Tempra	Surface Skt 400V 16A 3P+E IP67	0553 07	5553 58	183
P17 Tempra	Surface Skt 400V 16A 3P+N+E IP67	0553 08	5553 59	183
P17 Tempra	Surface Skt 230V 32A 2P+E IP67	0553 23	5554 54	183
P17 Tempra	Surface Skt 400V 32A 3P+E IP67	0553 27	5554 58	183
P17 Tempra	Surface Skt 400V 32A 3P+N+E IP67	0553 28	5554 59	183
P17 Tempra	Surface Skt 110V 16A 2P+E IP44	0553 50	5551 51	179
P17 Tempra	Surface Skt 230V 16A 2P+E IP44	0553 53	5551 54	179
P17 Tempra	Surface Skt 400V 16A 3P+E IP44	0553 57	5551 58	179
P17 Tempra	Surface Skt 400V 16A 3P+N+E IP44	0553 58	5551 59	179
P17 Tempra	Surface Skt 230V 32A 2P+E IP44	0553 73	5552 54	179
P17 Tempra	Surface Skt 400V 32A 3P+N+E IP44	0553 78	5552 59	179
P17 Tempra	Surface Skt 110V 16A 2P+E IP44	0555 50	5551 51	179
P17 Tempra	Surface Skt 230V 16A 2P+E IP44	0555 53	5551 54	179
P17 Tempra	Surface Skt 400V 16A 3P+E IP44	0555 57	5551 58	179
P17 Tempra	Surface Skt 400V 16A 3P+N+E IP44	0555 58	5551 59	179
P17 Tempra	Surface Skt 230V 32A 2P+E IP44	0555 73	5552 54	179
P17 Tempra	Surface Skt 400V 32A 3P+N+E IP44	0555 78	5552 59	179
P17 Tempra	Mobile Skt 230V 16A 2P+E IP67	0562 03	5553 04	183
P17 Tempra	Mobile Skt 400V 16A 3P+E IP67	0562 07	5553 08	183
P17 Tempra	Mobile Skt 400V 16A 3P+N+E IP67	0562 08	5553 09	183
P17 Tempra	Mobile Skt 230V 32A 2P+E IP67	0562 23	5554 14	183
P17 Tempra	Mobile Skt 400V 32A 3P+E IP67	0562 27	5554 18	183
P17 Tempra	Mobile Skt 400V 32A 3P+N+E IP67	0562 28	5554 19	183
P17 Tempra	Straight Plug 230V 16A 2P+E IP67	0563 03	5553 24	183
P17 Tempra	Straight Plug 400V 16A 3P+E IP67	0563 07	5553 28	183
P17 Tempra	Straight Plug 400V 16A 3P+N+E IP67	0563 08	5553 29	183
P17 Tempra	Straight Plug 230V 32A 2P+E IP67	0563 23	5554 34	183
P17 Tempra	Straight Plug 400V 32A 3P+E IP67	0563 27	5554 38	183
P17 Tempra	Straight Plug 400V 32A 3P+N+E IP67	0563 28	5554 39	183
P17 Tempra	Straight Plug 110V 16A 2P+E IP44	0574 31	5551 21	179
P17 Tempra	Straight Plug 230V 16A 2P+E IP44	0574 34	5551 24	179
P17 Tempra	Straight Plug 400V 16A 3P+E IP44	0574 38	5551 28	179
P17 Tempra	Straight Plug 400V 16A 3P+N+E IP44	0574 39	5551 29	179
P17 Tempra	Mobile Skt 110V 16A 2P+E IP44	0575 11	5551 01	179
P17 Tempra	Mobile Skt 230V 16A 2P+E IP44	0575 14	5551 04	179
P17 Tempra	Mobile Skt 400V 16A 3P+E IP44	0575 18	5551 08	179
P17 Tempra	Mobile Skt 400V 16A 3P+N+E IP44	0575 19	5551 09	179
P17 Tempra	Panel Skt 110V 32A 2P+E IP44	0576 08	5552 81	179
P17 Tempra	Panel Skt 110V 16A 2P+E IP44	0576 10	5551 81	179
P17 Tempra	Panel Skt 230V 16A 2P+E IP44	0576 11	5551 84	179
P17 Tempra	Panel Skt 230V 32A 2P+E IP44	0576 12	5552 84	179
P17 Tempra	Panel Skt 400V 16A 3P+E IP44	0576 17	5551 88	179
P17 Tempra	Panel Skt 400V 32A 3P+E IP44	0576 18	5552 88	179
P17 Tempra	Panel Skt 400V 16A 3P+N+E IP44	0576 23	5551 89	179
P17 Tempra	Panel Skt 400V 32A 3P+N+E IP44	0576 24	5552 89	179
P17 Tempra	Straight Plug 110V 32A 2P+E IP44	0581 21	5552 31	179
P17 Tempra	Straight Plug 230V 32A 2P+E IP44	0581 34	5552 34	179
P17 Tempra	Straight Plug 400V 32A 3P+E IP44	0581 38	5552 38	179
P17 Tempra	Straight Plug 400V 32A 3P+N+E IP44	0581 39	5552 39	179
P17 Tempra	Mobile Skt 110V 32A 2P+E IP44	0582 01	5552 11	179
P17 Tempra	Mobile Skt 230V 32A 2P+E IP44	0582 14	5552 14	179
P17 Tempra	Mobile Skt 400V 32A 3P+E IP44	0582 18	5552 18	179
P17 Tempra	Mobile Skt 400V 32A 3P+N+E IP44	0582 19	5552 19	179

Cat. Nos.	Page No.	Cat. Nos.	Page No.	Cat. Nos.	Page No.	Cat. Nos.	Page No.	Cat. Nos.	Page No.	Cat. Nos.	Page No.	Cat. Nos.	Page No.
0010 00		0046 70	68	0048 54	42	0130 04	77	0150 50	77	0175 65	78	0320 31	145
		72 -		55 -		06 -		63 -		70 -		32 -	
0013 01	35	73 -		56 -		08 -		80 -		0178 04	78	37 -	
02 -		74 -		58 -		10 -		96 -		60 -		38 -	
04 -		75 -		79 43		12 -		97 -		65 -		39 -	
06 -		76 -		80 -		16 -		0153 00	76	70 -		40 -	
08 -		77 -		81 -		20 -		10 -		75 -		42 -	
98 -		78 -		82 -		25 -		16 -		0181 04	78	43 -	
0016 65	75	79 -		84 -		95 -		20 -		0199 02	78	65 -	
90 -		80 -		85 -		0133 00	76	25 -				70 -	
91 -		81 -		86 -		01 -		32 -		0200 00		72 -	
0019 55	33	82 -		88 -		02 -		40 -		0215 01	74	88 -	
61 -		83 -		0049 96	75	04 -		50 -		03 -		0342 11	41
62 -		84 -				06 -		63 -		04 -		13 -	
64 -		85 -		0050 00		08 -		80 -		05 -		15 -	
65 -		86 -		0057 99	75	10 -		96 -		0216 00	74	17 -	
66 -		87 -		0058 04	74	12 -		97 -		01 -		19 -	
68 -		89 69		06 -		16 -		0160 25	78	04 -		21 -	
69 -		98 70		08 -		20 -		30 -		05 -		0342 23	41
72 -		99 -		16 -		25 -		35 -		0225 12	85	25 -	
73 -		0047 75	70	18 -		94 -		40 -		15 -		27 -	
0031 43	101	76 -		28 -		0140 04	77	45 -		20 -		0344 18	21
0037 00	106	77 -		38 -		06 -		50 -		22 -		0347 45	23
0043 82	87	78 -		48 -		10 -		0163 18	78	34 -		50 -	
83 -		79 -				12 -		20 -		39 -		0348 04	29
85 -		80 -		0100 00		16 -		22 -		51 -		05 -	
0044 09	110	0048 01	42	0102 02	76	20 -		25 -		53 -		17 -	
16 26		03 -		05 -		25 -		30 -		0227 04	85	34 -	
17 -		05 -		06 -		32 -		35 -		07 -		35 -	
32 101		06 -		10 -		40 -		40 -		22 -		36 -	
33 -		07 -		12 -		45 -		45 -		32 -		47 31	
36 -		10 -		16 -		50 -		50 -		98 -		50 29	
37 -		11 -		20 -		0143 00	76	55 -		0261 78	69	51 -	
53 -		17 -		25 -		02 -		0165 35	78	79 -		52 -	
54 -		19 -		30 -		04 -		40 -		88 -		88 -	
55 -		20 -		50 -		06 -		45 -		89 -		89 -	
58 -		22 -		63 -		10 -		50 -				0349 50	50
63 -		24 -		96 -		16 -		55 -				59 -	
64 -		25 -		0120 02	77	20 -		0168 04	78	0319 13	145	0350 07	38
68 -		30 -		04 -		25 -		45 -		16 -		13 -	
83 -		32 -		06 -		32 -		50 -		19 -		17 -	
84 -		34 -		10 -		40 -		55 -		20 -		22 -	
85 -		35 -		0123 00	76	50 -		60 -		21 -		28 -	
86 -		36 -		01 -		0146 68	69	0170 50	78	22 -		33 -	
87 -		38 -		02 -		69 -		55 -		25 -		43 40	
88 -		40 -		04 -		71 -		60 -		50 -		44 38	
0046 31	70	42 -		06 -		72 -		65 -		55 -		47 -	
34 -		44 -		08 -		73 -		0173 04	78	96 -		58 40	
36 -		45 -		10 -		74 -		50 -		0320 12	145	90 -	
38 -		46 -		12 -		75 -		55 -		15 -		92 -	
45 -		48 -		16 -		77 -		60 -		22 -		93 -	
46 -		50 -		0130 01	77	0150 32	77	65 -		24 -		94 -	
48 -		52 -		02 -		40 -		0175 60	78	30 -		0352 00	16

Cat. Nos.	Page No.	Cat. Nos.	Page No.	Cat. Nos.	Page No.	Cat. Nos.	Page No.	Cat. Nos.	Page No.	Cat. Nos.	Page No.	Cat. Nos.	Page No.	Cat. Nos.	Page No.
0360 18	23	0362 72	18	0365 80	26	0371 64	120	0372 68	124	0375 32	127	0376 66	148	0381 60	140
19 -	-	75 -	-	81 -	-	65 -	-	69 -	-	34 -	-	67 -	-	61 -	-
20 -	-	76 -	-	0366 38	50	66 -	-	70 -	-	35 -	-	68 -	-	62 -	-
21 -	-	81 -	-	39 -	-	67 -	-	71 -	-	40 -	-	69 -	-	63 -	-
22 -	-	85 21	21	42 -	-	68 -	-	72 -	-	42 -	-	70 -	-	0382 00	142
23 -	-	86 -	-	44 23	23	69 -	-	73 -	-	44 -	-	71 -	-	01 -	-
24 -	-	87 -	-	0367 01	50	70 -	-	74 -	-	46 -	-	87 -	-	02 -	-
31 -	-	91 18	18	02 -	-	71 -	-	79 -	-	47 -	-	88 -	-	03 -	-
33 -	-	92 -	-	10 -	-	72 -	-	80 125	125	50 126	126	89 -	-	04 -	-
34 -	-	93 -	-	80 26	26	73 -	-	81 -	-	51 -	-	90 -	-	10 141	141
40 -	-	94 -	-	81 -	-	74 -	-	82 -	-	52 -	-	92 -	-	11 -	-
42 -	-	95 -	-	82 -	-	75 -	-	83 -	-	53 -	-	97 -	-	12 -	-
46 -	-	96 21	21	83 -	-	76 -	-	84 -	-	54 -	-	0381 00	141	13 -	-
49 -	-	97 -	-	84 -	-	77 -	-	85 -	-	55 -	-	01 -	-	14 -	-
52 -	-	0363 00	14	0368 04	28	78 -	-	86 -	-	56 -	-	02 -	-	15 -	-
55 -	-	01 -	-	05 -	-	79 -	-	0373 08	44	57 -	-	03 -	-	16 -	-
56 -	-	59 25	25	06 -	-	80 121	121	60 45	45	60 -	-	04 -	-	17 -	-
58 -	-	60 -	-	17 -	-	81 -	-	61 -	-	61 -	-	05 -	-	18 -	-
59 -	-	61 -	-	18 -	-	82 -	-	62 -	-	62 -	-	06 -	-	19 -	-
61 -	-	62 -	-	19 -	-	83 -	-	65 -	-	63 -	-	07 -	-	20 -	-
64 -	-	63 -	-	20 -	-	84 -	-	88 -	-	65 127	127	08 -	-	21 -	-
87 -	-	64 -	-	22 -	-	85 -	-	89 -	-	66 -	-	09 -	-	22 -	-
91 -	-	65 -	-	23 -	-	86 -	-	95 44	44	67 -	-	10 -	-	23 -	-
92 -	-	69 -	-	24 -	-	87 -	-	96 45	45	68 -	-	11 -	-	24 -	-
93 -	-	90 21	21	25 -	-	0372 00	124	98 -	-	69 -	-	12 -	-	25 -	-
99 -	-	91 -	-	26 -	-	01 -	-	0374 00	44	82 -	-	13 -	-	26 -	-
0361 00	25	92 -	-	27 -	-	02 -	-	02 26	26	85 -	-	14 -	-	27 -	-
01 -	-	0364 01	14	43 -	-	03 -	-	03 44	44	86 126	126	15 -	-	28 -	-
02 -	-	06 16	16	44 -	-	04 -	-	04 126	126	87 -	-	16 -	-	29 -	-
03 -	-	08 18	18	0370 10	50	07 -	-	07 26	26	88 -	-	17 -	-	30 -	-
05 -	-	09 -	-	11 -	-	08 -	-	19 45	45	89 126	126	18 -	-	31 -	-
06 -	-	16 16	16	12 -	-	09 -	-	30 44	44	90 -	-	19 -	-	32 -	-
09 -	-	40 23	23	13 -	-	10 -	-	31 -	-	95 -	-	20 -	-	33 -	-
10 -	-	42 -	-	14 -	-	11 -	-	33 45	45	96 -	-	21 -	-	34 -	-
50 26	26	69 26	26	0371 00	120	12 -	-	34 -	-	0376 06	148	22 -	-	35 -	-
51 -	-	78 -	-	01 -	-	20 -	-	35 44	44	08 -	-	23 -	-	36 -	-
52 -	-	0365 11	28	02 -	-	21 -	-	37 45	45	09 -	-	24 -	-	37 -	-
53 -	-	30 -	-	03 -	-	40 -	-	38 -	-	10 -	-	25 -	-	38 -	-
54 -	-	35 14	14	04 -	-	41 -	-	47 44	44	39 -	-	26 -	-	39 -	-
55 -	-	39 28	28	05 -	-	42 -	-	0375 01	126	41 -	-	27 -	-	70 -	-
56 -	-	40 14	14	07 -	-	43 -	-	02 -	-	42 -	-	28 -	-	71 -	-
58 -	-	41 28	28	08 -	-	44 -	-	04 -	-	43 -	-	29 -	-	72 -	-
0362 40	18	42 -	-	09 -	-	46 -	-	05 -	-	44 -	-	30 -	-	73 -	-
42 -	-	45 14	14	20 -	-	47 -	-	07 -	-	45 -	-	31 -	-	74 -	-
50 -	-	51 -	-	21 -	-	54 125	125	10 -	-	46 149	149	32 -	-	75 -	-
51 -	-	52 -	-	30 -	-	55 -	-	11 -	-	47 -	-	33 -	-	76 -	-
52 -	-	53 -	-	31 -	-	56 -	-	12 -	-	48 -	-	34 -	-	80 -	-
55 -	-	54 -	-	51 -	-	60 124	124	13 -	-	50 148	148	35 -	-	81 -	-
56 -	-	56 -	-	52 -	-	61 -	-	24 127	127	60 -	-	40 -	-	82 -	-
61 -	-	57 -	-	60 -	-	62 -	-	25 -	-	61 -	-	41 -	-	83 -	-
63 -	-	64 -	-	61 -	-	63 -	-	27 -	-	62 -	-	42 -	-	84 -	-
64 -	-	78 29	29	62 -	-	64 -	-	30 -	-	63 -	-	43 -	-	85 -	-
71 -	-	79 -	-	63 -	-	67 -	-	31 -	-	64 -	-	44 -	-	86 -	-

Cat. Nos.	Page No.	Cat. Nos.	Page No.	Cat. Nos.	Page No.	Cat. Nos.	Page No.	Cat. Nos.	Page No.	Cat. Nos.	Page No.	Cat. Nos.	Page No.	Cat. Nos.	Page No.
0382 90	141	0383 50	141	0390 73	134	0399 81	14	0442 68	90	0520 22	163	0527 02	157	0538 23	164
91	-	51	-	74	-	86	-	69	-	23	-	03	-	24	-
92	-	52	-	0394 46	133	87	-	70	-	24	-	18	164	33	-
93	-	53	-	47	-	88	-	71	-	29	-	19	-	34	-
94	-	54	-	49	26	0400 00		0470 01	96	32	-	32	-	43	-
95	-	55	-	77	134	0427 85	92	02	-	33	-	33	-	44	-
96	-	60	-	78	134	86	-	03	-	34	-	42	-	83	-
0383 00	141	61	-	86	-	86	-	04	-	42	-	43	-	84	-
01	-	62	-	88	-	87	-	20	-	43	-	82	-	0566 00	194
02	-	63	-	89	-	88	-	21	-	44	-	83	-	01	-
03	-	64	-	0395 00	140	89	-	22	-	49	156	99	-	05	-
04	-	65	-	01	-	90	-	23	-	59	-	0528 72	164	06	-
05	-	66	-	02	-	92	-	24	-	73	163	73	-	09	-
06	-	67	-	05	-	0428 40	92	25	-	82	-	74	-	13	-
07	-	68	-	06	-	41	-	0495 94	112	83	-	0529 03	157	14	-
08	-	69	-	09	-	42	-	0496 80	110	84	-	04	-	20	-
09	-	70	-	10	-	43	-	82	-	89	-	13	-	21	-
10	-	71	-	15	-	44	-	0497 50	112	0521 01	178	14	-	25	-
11	-	72	-	16	-	45	-	54	-	25	163	19	164	26	-
12	-	73	-	19	-	47	-	0498 32	110	26	-	20	-	29	-
13	-	74	-	20	-	55	-	0499 83	112	27	-	33	-	33	-
14	-	75	-	21	-	56	-	0500 00		72	-	34	-	34	-
15	-	76	-	96	126	57	-	0511 06	169	73	-	39	-	40	-
16	-	77	-	97	-	58	-	10	-	74	-	40	-	41	-
17	-	78	-	98	-	59	-	11	-	96	156	43	-	45	-
18	-	79	-	0399 30	14	60	-	25	-	0522 03	156	44	-	46	-
19	-	80	-	31	-	61	-	26	-	04	-	49	157	49	-
20	-	81	-	32	-	62	-	30	-	13	-	59	156	53	-
21	-	82	-	33	-	70	-	31	-	14	-	83	164	54	-
22	-	83	-	34	-	71	-	46	-	19	163	84	-	61	-
23	-	84	-	35	-	72	-	50	-	20	-	90	-	65	-
24	-	85	-	36	-	73	-	51	-	23	-	0530 06	170	66	-
25	-	92	142	37	-	74	-	55	-	24	-	10	-	69	-
30	-	94	-	38	-	75	-	56	-	29	-	11	-	73	-
31	-	95	-	39	-	77	-	60	-	33	-	46	-	74	-
32	-	96	-	40	-	99	-	61	-	34	-	50	-	0568 00	183
33	-	97	-	41	-	0442 31	90	61	-	39	-	51	-	03	-
34	-	0384 90	142	42	-	32	-	75	-	43	-	56	-	07	-
35	-	91	-	43	-	33	-	76	-	44	-	60	-	08	-
36	-	92	-	44	-	34	-	80	-	49	156	61	-	23	-
37	-	0390 10	133	45	-	35	-	81	-	59	157	76	-	27	-
38	-	11	-	46	-	36	-	0519 10	156	83	163	80	-	28	-
39	-	13	-	51	-	37	-	19	163	84	-	81	-	0572 99	194
40	-	14	-	52	-	38	-	20	-	89	-	0536 03	157	0573 51	179
41	-	15	-	54	-	39	-	30	163	0524 01	163	04	-	54	-
42	-	17	-	55	-	40	-	40	-	02	-	99	164	58	-
43	-	18	-	56	-	61	-	70	-	05	-	0537 24	164	59	-
44	-	31	134	59	-	62	-	80	-	19	-	49	157	0575 81	179
45	-	32	-	63	-	63	-	0520 02	156	21	-	73	164	84	-
46	-	33	-	64	-	64	-	03	-	22	-	74	-	88	-
47	-	34	-	65	-	65	-	04	-	25	-	0538 00	157	89	-
48	-	71	-	69	-	66	-	18	163	61	-	01	-	0577 05	195
49	-	72	-	80	-	67	-	19	-	62	-	09	-	06	-

Cat. Nos.	Page No.	Cat. Nos.	Page No.	Cat. Nos.	Page No.	Cat. Nos.	Page No.	Cat. Nos.	Page No.	Cat. Nos.	Page No.	Cat. Nos.	Page No.	Cat. Nos.	Page No.
0577 10	195	0592 59	190	0921 27	37	4064 81	84	4090 69	56	4093 38	56	4095 39	57	4115 00	61
12	-	60	191	28	38	90	-	70	-	39	-	40	-	04	-
13	-	61	-	36	37	95	-	71	-	40	-	41	-	05	-
15	-	62	-	37	-	4079 63	57	4091 07	56	41	-	42	-	06	-
0580 54	179	63	-	0921 38	38	65	-	08	-	42	-	4109 18	63	07	-
58	-	64	-	0922 84	40	66	-	09	-	62	-	19	-	08	-
59	-	65	-	0980 03	33	4080 23	57	11	-	63	-	21	-	14	-
0582 81	179	66	-			25	-	12	-	64	-	22	-	15	-
84	-	67	-	4000 00		26	-	14	-	4094 25	57	24	-	16	-
88	-	83	190	4018 53	33	81	-	15	-	28	-	25	-	17	-
89	-	84	-	4049 05	75	83	-	16	-	30	-	93	-	24	-
0587 00	183	0594 27	170	06	-	84	-	17	-	32	-	97	-	25	-
04	-	28	-	26	-	4088 65	56	18	-	33	-	99	-	26	-
05	-	37	-	37	-	66	-	19	-	34	-	4110 00	63	27	-
10	-	38	-	38	-	67	-	20	-	35	-	02	-	37	-
14	-	47	-	39	-	69	-	40	-	36	-	03	-	43	-
15	-	48	-	42	-	70	-	95	-	37	-	04	-	50	-
20	-	87	-	43	-	72	-	96	-	38	-	05	-	54	-
24	-	88	-	44	-	73	-	97	-	44	-	06	-	55	-
25	-	0595 02	170	88	-	74	-	99	-	47	-	21	-	56	-
30	-	03	-	4062 58	58	75	-	4092 00	56	49	-	22	-	57	-
34	-	12	-	60	-	76	-	02	-	51	-	24	-	69	-
35	-	13	-	62	-	78	-	03	-	52	-	25	-	70	-
40	-	22	-	66	-	4089 35	56	04	-	53	-	26	-	71	-
44	-	23	-	4063 03	58	36	-	05	-	54	-	27	-	72	-
45	-	32	-	04	-	37	-	06	-	55	-	28	-	84	-
0589 10	194	33	-	05	-	39	-	07	-	56	-	4111 49	64	4117 02	61
38	195	0596 01	190	07	-	40	-	08	-	57	-	50	-	03	-
0591 07	183	02	-	13	-	42	-	28	-	58	-	51	-	04	-
14	191	03	-	4064 00	84	43	-	29	-	59	-	57	-	05	-
15	-	05	-	01	-	44	-	30	-	60	-	58	-	12	-
17	183	07	-	03	-	45	-	47	-	92	-	59	-	13	-
27	-	08	-	11	-	46	-	48	-	95	-	60	-	14	-
37	-	51	191	12	-	48	-	49	-	97	-	61	-	15	-
47	-	52	-	23	-	84	-	51	-	99	-	62	-	22	-
0592 00	190	53	-	31	-	85	-	52	-	4095 00	57	63	-	23	-
03	-	55	-	32	-	86	-	54	-	01	-	64	-	24	-
07	-	57	-	34	-	88	-	55	-	02	-	85	-	25	-
09	-	58	-	36	-	89	-	56	-	03	-	86	-	32	-
14	-	60	-	38	-	91	-	57	-	04	-	87	-	33	-
16	-	61	-	40	-	92	-	58	-	05	-	88	-	34	-
19	-	67	-	50	-	93	-	59	-	06	-	89	-	35	-
24	-	68	-	53	-	94	-	60	-	07	-	90	-	45	-
25	-	81	-	55	-	95	-	80	-	08	-	91	-	46	-
26	-			57	-	96	-	81	-	26	-	92	-	59	-
28	-	0900 00		59	-	97	-	82	-	29	-	4112 04	64	60	-
29	-	0920 32	38	60	-	4090 58	56	4093 29	56	31	-	05	-	61	-
34	-	42	-	61	-	62	-	30	-	33	-	06	-	62	-
35	-	0921 00	37	70	-	63	-	31	-	34	-	07	-	69	-
43	-	01	-	75	-	65	-	33	-	35	-	08	-	70	-
47	-	04	-	77	-	66	-	34	-	36	-	09	-	71	-
49	-	22	40	79	-	67	-	36	-	37	-	10	-	72	-
56	-	26	37	80	-	68	-	37	-	38	-	11	-	73	-

Cat. Nos.	Page No.	Cat. Nos.	Page No.	Cat. Nos.	Page No.	Cat. Nos.	Page No.
4117 79	61	5551 09	179	5554 39	183	6361 23	50
80	-	21	-	51	-	25	-
81	-	24	-	54	-	90	-
82	-	28	-	58	-	95	-
83	-	29	-	59	-	6362 02	50
90	-	51	-	81	-	07	-
91	-	54	-	84	-	12	-
92	-	58	-	88	-	13	-
4118 00	61	59	-	89	-	17	-
01	-	81	-			25	-
4124 29	98	84	-	6000 00		6423 62	92
30	-	88	-	6019 32	33	63	-
31	-	89	-	74	-	64	-
4125 03	98	5552 11	179	76	-	65	-
05	-	14	-	78	-	66	-
21	-	18	-	81	-	68	-
24	-	19	-	82	-		
33	-	31	-	83	-		
35	-	34	-	85	-		
36	-	38	-	86	-		
44	99	39	-	87	-		
45	-	51	-	88	-		
47	-	54	-	6037 70	109		
49	-	54	-	71	-		
50	-	58	-	6064 10	63		
53	-	59	-	11	-		
56	-	59	-	12	-		
4126 02	113	81	-	13	-		
26	-	84	-	14	-		
31	106	88	-	15	-		
41	-	89	-	6360 95	50		
54	-	5553 01	183	96	-		
57	-	04	-	6361 00	50		
4127 80	111	08	-	01	-		
90	-	09	-	02	-		
94	-	21	-	03	-		
95	-	24	-	05	-		
4128 12	111	28	-	06	-		
13	-	29	-	07	-		
72	106	51	-	08	-		
73	-	54	-	09	-		
4130 90	102	58	-	11	-		
91	-	59	-	12	-		
93	-	81	-	13	-		
95	-	84	-	14	-		
96	-	88	-	15	-		
97	-	89	-	16	-		
98	-	5554 14	183	17	-		
		18	-	18	-		
5000 00		19	-	19	-		
5551 01	179	31	-	20	-		
04	-	34	-	21	-		
08	-	38	-	22	-		

Protection classifications

Protection against solid bodies and liquids : Index of protection - IP xx

Degree of protection of enclosures of electrical equipment in accordance with standards IEC 60529, BS EN 60529
Up to 1 000 V~ and 1 500 V=

1 st digit: protection against solid bodies			Additional letter IP XX (ABCD): protection against direct contact resulting from the access to hazardous current-carrying parts			2 nd digit: protection against liquids		
IP	tests		IP	tests	protection	IP	tests	
0		No protection				0		No protection
1		Protected against solid bodies larger than 50 mm	A		The back of the hand remains remote from dangerous parts	1		Protected against vertically-falling drops of water (condensation)
2		Protected against solid bodies larger than 12.5 mm	B		The dangerous parts can not be touched when introducing a finger	2		Protected against drops of water falling at up to 15° from the vertical
3		Protected against solid bodies larger than 2.5 mm	C		The dangerous parts can not be touched when introducing a tool (eg a screwdriver)	3		Protected against drops of rain water at up to 60° from the vertical
4		Protected against solid bodies larger than 1 mm				4		Protected against projections of water from all directions
5		Protected against dust (no harmful deposit)				5		Protected against jets of water from all directions
6		Completely protected against dust	D		The dangerous parts can not be touched when introducing a wire	6		Protected against jets of water of similar force to heavy seas
						7		Protected against the effects of immersion
						8		Protected against prolonged effects of immersion under pressure

Protection against mechanical impact : Index of protection - IK

According to standards IEC 62262 and BS EN 62262

IK	Tests	Impact energy (in Joules)
IK 00		0
IK 01		0.15
IK 02		0.2
IK 03		0.35
IK 04		0.5
IK 05		0.7
IK 06		1
IK 07		2
IK 08		5
IK 09		10
IK 10		20

(1) A product previously classed as IP xx-7 can be assumed to fulfill the conditions of an IP xx - IK 08

This table can be used to ascertain the resistance of a product to an impact given in Joules from the IK code (graduated from 00 to 10). It can also be used to ascertain the correspondence with the old IP code 3rd digit and the corresponding external "Ag" conditions.

The contents of the Protection Classifications charts are for guidance only. If you have any doubt as to the interpretation of the information contained therein, please refer either to the standard itself or contact Legrand.

Health and Safety at Work, etc. Act. 1974

Statement to Purchasers and Prospective Purchasers

1. Section 6 of this Act provides that manufacturers, designers, importers or suppliers of articles for use at work have a duty to ensure so far as is reasonably practical, that the article will be safe and without risk to health when properly used. An article is not regarded as being 'properly used' if it is used without regard to any relevant information or advice relating to its use made available by the manufacturer, designer, importer or supplier.

2. With regard to these provisions the following is given as a guide to the information which is readily available to you. This information relates to those products detailed in our catalogue(s) or associated literature or may be obtained by specific request to the Company.

3. All products should be installed and maintained in accordance with good engineering practice and relevant British or

other applicable standards, regulations for the installation of equipment by the Institute of Electrical Engineers or any other applicable Codes of Practice.

Health and Safety at Work Act

The Electricity at Work Regulations, 1989

1. All installations and maintenance should be carried out within the provision of the above Act and by persons so qualified as defined in the Act.

2. Information and advice on the suitability of our products can be obtained from Legrand Electric Limited on specific request.

For information concerning wiring device standards outside the UK contact :

BSI

Tel : +44 (0) 20 8996 9000

Fax : +44 (0) 20 8996 7001

Email : cservices@bsigroup.com

www.bsigroup.com

marking appears on electrical or electronic products from Legrand and enables the circulation of goods outside the UK.

Conditions of sale

Please consult our current price list

In accordance with its policy of continuous improvement the Company reserves the right to change specifications and designs without notice. All illustrations, descriptions, dimensions and weights in this catalogue are for guidance and cannot be held binding on the Company.



Contact details

United Kingdom

Great King Street North,
Birmingham, B19 2LF

Customer Services:

Tel: +44 (0) 845 605 4333 Fax: +44 (0) 845 605 4334
E-mail: legrand.sales@legrand.co.uk

Quotations and Technical Support:

Tel: +44 (0) 870 608 9020 Fax: +44 (0) 870 608 9021
E-mail: uk-wdsales@legrand.co.uk

Republic of Ireland:

Tel: 01 295 9673 Fax: 01 295 4671
E-mail: legrand.sales@legrand.co.uk



FOLLOW
US AT

@ www.legrand.co.uk
www.legrand.ie

 www.youtube.com/legrandtvuk

 www.twitter.com/legranduk

 www.voltimum.co.uk
www.voltimum.ie

Distributor:



Head office (UK and Ireland):

Legrand Electric Limited
Great King Street North, Birmingham, B19 2LF
Tel: +44 (0) 870 608 9000 Fax: +44 (0) 870 608 9004
Website: www.legrand.co.uk



This document is printed on sustainably sourced paper. Please recycle.

The Legrand logo is a registered trademark of the Legrand group of companies.