

Switch Disconnectors



7/2 Introduction

3LD main control and EMERGENCY-STOP switches up to 250 A

- 7/3 Introduction
- 7/6 Front mounting
- 7/11 Floor mounting
- 7/17 Distribution board mounting
- 7/19 Molded-plastic enclosures
- 7/21 DC applications
- 7/22 Accessories

5TE1 switch disconnectors up to 200 A

- 7/27 Introduction
- 7/28 General data

3KA, 3KE switch disconnectors up to 1000 A

- 7/32 Introduction
- 7/35 Floor mounting
- 7/40 Molded-plastic enclosures
- 7/41 Accessories

3VT switch disconnectors up to 1600 A

- 7/44 Introduction
- 7/46 3VT1 switch disconnectors up to 160 A
- 7/51 3VT2 switch disconnectors up to 250 A
- 7/57 3VT3 switch disconnectors up to 630 A
- 7/63 3VT4 switch disconnectors up to 1000 A
- 7/64 3VT5 switch disconnectors up to 1600 A

3KL switch disconnectors with fuses up to 800 A

- 7/68 Introduction
- 7/70 Floor mounting
- 7/72 Front mounting
- 7/73 Accessories
- 7/75 Fuses

3KM switch disconnectors with fuses and isolating plug connector up to 400 A

- 7/77 Introduction
- 7/79 For snapping onto busbars
- 7/80 Accessories
- 7/82 Fuses

8UC7 door-coupling rotary operating mechanisms

- 7/84 For 3K switch disconnectors
- 7/88 Individual parts
- 7/89 Operating mechanisms for fixed mounting

3NJ62 in-line switch disconnectors with fuses up to 630 A

- 7/90 Introduction
- 7/90 For LV HRC fuse links
- 7/97 For BS fuse links
- 7/99 For LV HRC and BS fuse links
- 7/108 Accessories

3NP1 fuse switch disconnectors up to 630 A

- 7/115 Introduction
- 7/118 Floor mounting
- 7/120 For 40 mm busbar system
- 7/122 For 60 mm busbar system
- 7/124 Accessories
- 7/132 Fuses

3NP5 fuse switch disconnectors up to 630 A

- 7/135 Introduction
- 7/137 Floor mounting
- 7/138 For 40 mm busbar system
- 7/139 For 60 mm busbar system
- 7/140 With fuse monitoring
- 7/143 Accessories
- 7/145 Fuses

3NJ4, 3NJ5 in-line fuse switch disconnectors up to 2000 A

- 7/148 Introduction
- 7/151 1-pole, switchable
- 7/152 3-pole, switchable
- 7/153 Accessories

For further technical product information:

[Configuration Manual](#)

Switch Disconnectors 2014
Article No.: 3ZW1012-3NP11-0AC1

[Service & Support Portal](#)

www.siemens.com/lowvoltage/product-support

→ Product List:
Technical specifications

→ Entry List:
Certificates / Characteristics /
Download / FAQ / Manuals /
Updates

Switch Disconnectors

Introduction

Overview

		Article No.	Page
Switch disconnectors			
	<p>Main control and EMERGENCY-STOP switches from 16 A to 250 A</p> <ul style="list-style-type: none"> • Devices for front mounting, floor mounting with door-coupling rotary operating mechanism, distribution board mounting or in molded-plastic enclosures • Front mounting with four-hole and center hole arrangement • 3, 4 and 6-pole versions • 3 and 4-pole load transfer switches • Solar plant isolators 800 V DC 	3LD	7/3
3LD			
	<p>Switch disconnectors from 100 A to 200 A</p> <ul style="list-style-type: none"> • For floor and distribution board mounting • 2, 3 and 4-pole versions 	5TE1	7/27
5TE1			
	<p>Switch disconnectors from 63 A to 1000 A</p> <ul style="list-style-type: none"> • Devices for floor mounting with handle, with door-coupling rotary operating mechanism, in molded-plastic enclosures and for mounting in control cabinet side panels • 3 and 4-pole versions • Accessories for use as load transfer switches and parallel switches 	3KA, 3KE	7/32
3KA/3KE			
	<p>Switch disconnectors from 160 A to 1600 A</p> <ul style="list-style-type: none"> • Compact design allowing it to be used where space is limited. • 3 and 4-pole versions • Coordinated, comprehensive range of accessories for greater functionality, e.g. <ul style="list-style-type: none"> - Motorized operating mechanisms - Shunt and undervoltage releases for remote control - Switching state interrogation by means of auxiliary and alarm switches 	3VT	7/44
3VT			
Switch disconnectors with fuses			
	<p>Switch disconnectors with fuses up to 800 A</p> <ul style="list-style-type: none"> • Devices for floor mounting with door-coupling rotary operating mechanism and for mounting in control cabinet side panels • 3KM versions with isolating plug connector for mounting on vertical busbars • 3 and 4-pole versions • Suitable for NH and BS 88 fuse systems 	3KL, 3KM	7/68
3KL			
	<p>In-line switch disconnectors with fuses, plug-in type, up to 630 A</p> <ul style="list-style-type: none"> • 2, 3 and 4-pole versions • Suitable for NH and BS 88 fuse systems • Manually operated or with motorized operating mechanism • Optionally with integrated current transformers, auxiliary switches and electronic fuse monitoring 	3NJ62	7/90
3NJ62			
Fuse switch disconnectors			
	<p>3NP fuse switch disconnectors</p> <ul style="list-style-type: none"> • Rated current up to 630 A • Connection components are available for flat connection, saddle terminal connection, prism terminal connection and box terminal connection • Electromechanical and electronic fuse monitoring with/without network monitoring function • Mounting versions for floor mounting and 40/60 mm busbar system 	3NP1 / 3NP5	7/115
3NP1			
	<p>In-line fuse switch disconnectors up to 2000 A</p> <ul style="list-style-type: none"> • 1- and 3-pole switchable versions • Versions for secondary-side protection of transformers • In-line infeed block versions up to 2000 A with isolating blades • Connection components are available for flat connection, stud bolt connection, saddle terminal connection, prism terminal connection and box terminal connection • Versions with/without integratable current transformer • Versions with/without electronic fuse monitoring 	3NJ4, 3NJ5	7/148
3NJ4/3NJ5			

Switch Disconnectors

3LD Main Control and EMERGENCY-STOP Switches up to 250 A

Introduction

Overview

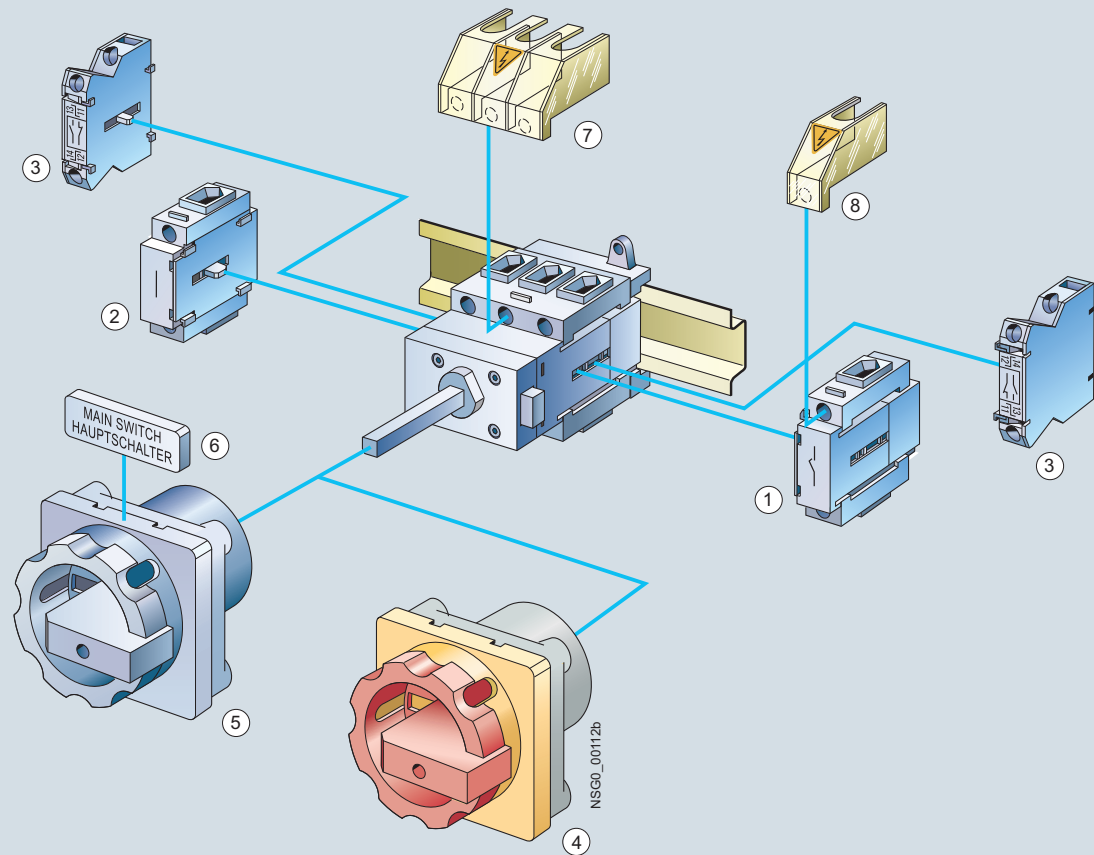

- ① 4th contact (N conductor)
- ② N or PE/ground terminal, continuous
- ③ Auxiliary switch 1 NO + 1 NC
- ④ Rotary operating mechanism, red/yellow
- ⑤ Rotary operating mechanism, black
- ⑥ Front plate, English/German
- ⑦ Terminal cover, three-pole
- ⑧ Terminal cover, single-pole

The 3LD main control and EMERGENCY-STOP switches are manually operated switch disconnectors according to IEC 60947-3/VDE 0660 Part 107 (EN 60947-3) and comply with the conditions for switch disconnectors.

In EN 60204-1 (VDE 0113 Part 1), main control switches are called "disconnector units", while EMERGENCY-STOP switches are termed "devices for emergency shutdown".

The 3LD switches for 16 to 250 A are approved according to UL 508 and can be used as "manual motor controllers" and "motor disconnects". In addition, the 3LD switch disconnectors have CCC certification.

Maintenance personnel can protect themselves against unauthorized startup with padlocks (up to three can be fitted).

The 3LD switches can be used in any mounting position.

Application

The 3LD switches are used for switching main and auxiliary circuits, but also for switching three-phase motors and other loads during maintenance and repair work.

They can be used as:

- ON-OFF switches
- EMERGENCY-STOP switches
- Main control switches according to EN 60204-1

Switch Disconnectors

3LD Main Control and EMERGENCY-STOP Switches up to 250 A

Introduction

Design

Design of the contacts

Each switch has three adjacent contact elements¹⁾. A fourth leading contact for switching the N conductor, a continuous PE terminal, an auxiliary switch (1 NO + 1 NC) can be fitted to each side of the switch. The auxiliary switches operate as leading contacts on opening. On opening, the NO contact opens before the main contacts, so that a contactor carries the switching capacity in the circuit and the maintenance or safety switch switches at zero current. On closing, the auxiliary switch switches later than or at the same time as the main contacts.

Construction of rotary operating mechanisms

The rotary operating mechanisms of the switches for front or floor mounting are mounted on control cabinet doors, front or side panels with four-hole or center-hole mounting with a standard diameter of 22.5 mm and operated from the outside. In their Off position, they can be locked with up to three padlocks with a hasp thickness of 8 mm. Controls with defeatable door-coupling rotary operating mechanism are available in addition.

- **Switch position indicator:**
The switch position is clearly marked with direction arrows and an "O" for OFF and a "I" for ON at the front.
- **Switches for front mounting:**
The switches for front mounting are connected directly to the rotary operating mechanism through the fixing screws or - in the case of center-hole mounting - a special-purpose coupling.
- **Switches for floor mounting:**
The switches for floor mounting are snapped onto 35 mm standard mounting rails according to EN 60715 or screw-mounted on mounting plates. The actuators are connected to the lower section of the switch through a door coupling, which can be released in its zero position, and a 300 mm long switch shaft. When the control cabinet door is open, the switch can be protected against inadvertent operation by removing the switch shaft from the lower section of the switch. The mounting depth can be adapted to individual requirements by adjusting the switch shaft length.
- **Switches for distribution board mounting:**
The switches for distribution board mounting are suited for operation in distribution boards and for switching inside control cabinets or distributors. They have cap and mounting dimensions according to DIN 43880 and can be fitted under the same cover together with miniature circuit breakers. The selector switches can be locked in their OFF position with up to 2 padlocks with a hasp thickness of 6 mm.
- **Switches in molded-plastic enclosure:**
For surface mounting of individual main control and EMERGENCY-STOP switches, molded plastic-enclosed switches to degree of protection IP65 are used. The actuators can be locked in their OFF position with three padlocks with a hasp thickness of 8 mm. The molded-plastic enclosures each contain an N and/or a PE terminal.

¹⁾ 16 A versions have four contact elements; 3-pole changeover switches and 6-pole main control switches have six contact elements.



3LD2704-0TK53
switch for front mounting
with rotary operating mechanism



3LD2222-0TK1
switch for front mounting
with knob



3LD2122-7UK01 3-pole changeover
switch for front mounting with knob

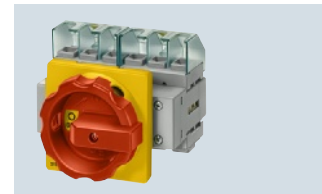

3LD2103-3VK53 6-pole switch
for front mounting with rotary
operating mechanism



3LD2144-0TK53 switch for floor
mounting with rotary operating
mechanism and door coupling



3LD2530-0TK11 switch for
distribution board mounting
with knob



3LD2264-0TB5 switch in
molded-plastic enclosure



3LD2217-1TL13 switch for floor
mounting with rotary operating mech-
anism and defeatable door coupling



3LD2265-8VQ51-0AF6
solar plant isolator



3LD2418-0TK13 switch for floor
mounting, 250 A, with rotary operat-
ing mechanism and door coupling

Switch Disconnectors

3LD Main Control and EMERGENCY-STOP Switches up to 250 A

Introduction

Technical specifications

Standards		DIN VDE 0660, IEC 60947								
Switches		Type	3LD20	3LD21	3LD22	3LD25	3LD27	3LD28	3LD23	3LD24
Rated insulation voltage U_i		V	690							
Rated operational voltage U_e		V AC	690							
Rated frequency		Hz	50 ... 60							
Rated impulse withstand voltage U_{imp}		kV	6	6	6	6	6	6	6	6
Rated short-time withstand current (1 s current, rms value)		A	340	640	640	1260	2000	2000	4000	4000
Short-circuit protection, max. back-up fuse (gL)		A	20	25	40	63	100	125	160	250
Rated conditional short-circuit current with upstream fuses at AC 50/60 Hz, 690 V		kArms	50	50	50	50	50	20	50	50
Maximum permissible let-through I^2t value		kA ² s	2.5	4	9	21	64	104	185	557
Permissible let-through current of the fuse		kA	3	3.5	4.5	6	10	10	15	15
Rated uninterrupted current I_U		A	16	25	32	63	100	125	160	250
AC-21A load-break switch	Rated operational current I_e	A	16	25	32	63	100	125	160	250
AC-3 motor load switches	Rating									
In-service switching	At 220 ... 240 V	kW	3.0	4.0	5.5	11.0	18.5	22.0	35.0	55.0
of individual motors	At 380 ... 440 V	kW	5.5	7.5	9.5	18.5	30.0	37.0	50.0	110.0
	At 660/690 V	kW	5.5	7.5	9.5	15.0	22.0	30.0	37.0	45.0
AC-23A main control switch	Rating									
Repair switch	At 220 ... 240 V	kW	4.0	5.0	6.0	11.0	18.5	22.0	45.0	75.0
frequent, but not in-service switching	At 380 ... 440 V	kW	7.5	9.5	11.5	22.0	37.0	45.0	75.0	132.0
of individual motors	At 660/690 V	kW	7.5	9.5	11.5	18.5	30.0	37.0	45.0	55.0
Power loss per conducting path at I_e		W	0.5	1.1	1.8	4.5	7.5	12.0	36.0	36.0
Endurance mechanical	Switching cycles		100 000							
Switching frequency		1/h	50							
Permissible ambient temperature		°C	-25 ... +55							
Isolating features		Up to max.	V 690							
Conductor cross-sections for main conductors ¹⁾										
Solid or stranded		mm ²	1 ... 6	1.5 ... 16	1.5 ... 16	2.5 ... 35	4 ... 50	4 ... 50	16 ... 185	16 ... 185
Finely stranded with end sleeve (max.)		mm ²	4	10	10	16	35	35	150	150
Conductor cross-sections	Copper cable	AWG	18 ... 10	14 ... 8	14 ... 8	14 ... 6	12 ... 1	12 ... 1		
Torque for terminal		Nm	1.5 ... 2	2 ... 2.5	2 ... 2.5	2.5 ... 3	2.5 ... 3	2.5 ... 3	9.5 ... 10	9.5 ... 10
Touch protection according to EN 50274			Yes							
Auxiliary switches										
Rated insulation voltage U_i		V	500							
Rated operational voltage U_e		V AC	500							
Rated uninterrupted current I_U		A	10							
Rated operational current I_e , AC-15										
	At 120 V	A	6							
	At 220 ... 240 V	A	3							
	At 380 ... 415 V	A	1.8							
	At 500 V	A	1.4							
Short-circuit protection, aux. switch, max. back-up fuse (gL/gG)		A	10							
Conductor cross-sections for auxiliary conductors										
Connection type			Terminals							
Solid or stranded		mm ²	2 × (0.75 ... 2.5), 1 × 4							
Finely stranded with end sleeve		mm ²	2 × (0.75 ... 1.5) 1 × 2.5							
Torque for terminal		Nm	0.8							

3LD main control and EMERGENCY-STOP switches for UL/CSA

Standards		UL/CSA								
Switches		Type	3LD20	3LD21	3LD22	3LD25	3LD27	3LD28	3LD23	3LD24
Rated operational voltage U_e		V AC	600							
Rated uninterrupted current I_U		A	10	20	30	60	100	125	160	250
	Current rating		A 600	A 600	A 600	--	--	--	--	--
	Pilot duty		P 600	P 600	P 600	--	--	--	--	--
Conventional thermal current I_{th}		A	16	25	32	63	100	125	160	250
Maximum rated power (AC-3)		3 ~ 120 V	HP 1	3	3	5	10	15	--	--
Alternating current motors 40 ... 60 Hz (HP = PS)		240 V	HP 3	7.5	10 (7.5) ²⁾	15	30	40	40	50
	480 V	HP 7.5	10	15	20 (15) ²⁾	40	60	75	75	100
	600 V	HP 10	15	20	30 (20) ²⁾	50	75	100	75	75
	1 ~ 120 V	HP 0.5	2	2	3	--	--	--	--	--
	240 V	HP 1.5	3	3	10	--	--	--	--	--
Conductor cross-sections		Cu cable	AWG 18 ... 10	14 ... 8	14 ... 8	14 ... 6	12 ... 1	12 ... 1	1 ... MCM400	
Torque			Nm 1.5 ... 2	2 ... 2.5	2 ... 2.5	2.5 ... 3	2.5 ... 3	2.5 ... 3	10	10

¹⁾ Depending on the cable infeed, only small cross-sections are possible with devices in molded-plastic enclosures



²⁾ Values in brackets apply to devices in molded-plastic enclosure

Switch Disconnectors

3LD Main Control and EMERGENCY-STOP Switches up to 250 A

Front mounting

Selection and ordering data

Number and version of the contacts		Rated data at 50 ... 60 Hz, 380 ... 440 V			DT	Article No.	Price per PU	PU (UNIT, SET, M)	PS*/P. unit	PG	Weight per PU approx.	
Main contact elements	Auxiliary contact elements	P/AC-3	P/AC-23A	I _n /AC-21A							kg	
		kW	kW	A								
Main control and EMERGENCY-STOP switches with rotary operating mechanism/knob-operated mechanism <ul style="list-style-type: none"> • Lockable in 0 position with up to 3 padlocks • Degree of protection at front side IP65 • All versions with rotary operating mechanism Exception: 3LD23 and 3LD24 with knob-operated mechanism • Including terminal cover for the infeed side • Front plate: <ul style="list-style-type: none"> - 3LD20, 3LD21, 3LD22: 67 mm × 67 mm - 3LD25 to 3LD28: 90 mm × 90 mm - 3LD23 to 3LD24: 96 mm × 96 mm 												
Four-hole mounting												
 3LD2203-0TK51	3	--	5.5	7.5	16	▶	3LD2003-0TK5□	1	1 unit	103	0.204	
			7.5	9.5	25	▶	3LD2103-0TK5□	1	1 unit	103	0.203	
			9.5	11.5	32	▶	3LD2203-0TK5□	1	1 unit	103	0.203	
			18.5	22.0	63	▶	3LD2504-0TK5□	1	1 unit	103	0.419	
			30	37.0	100	▶	3LD2704-0TK5□	1	1 unit	103	0.497	
			37	45.0	125		3LD2804-0TK5□	1	1 unit	103	0.490	
			50	75.0	160		3LD2305-0TK1□	1	1 unit	103	2.085	
			110	132.0	250		3LD2405-0TK1□	1	1 unit	103	2.090	
	 3LD2704-0TK53	3 + N	--	5.5	7.5	16	▶	3LD2003-1TL5□	1	1 unit	103	0.213
				7.5	9.5	25		3LD2103-1TL5□	1	1 unit	103	0.243
			9.5	11.5	32		3LD2203-1TL5□	1	1 unit	103	0.236	
			18.5	22.0	63		3LD2504-1TL5□	1	1 unit	103	0.490	
			30.0	37.0	100	▶	3LD2704-0TK5□ +1)	1	1 unit	103	0.497	
						▶	3LD9280-0B	1	1 unit	103	0.099	
			37.0	45.0	125		3LD2804-0TK5□ +1)	1	1 unit	103	0.490	
						▶	3LD9280-0B	1	1 unit	103	0.099	
			50	75.0	160		3LD2305-1TL1□	1	1 unit	103	2.580	
			110	132.0	250		3LD2405-1TL1□	1	1 unit	103	2.592	
	3	1 NO + 1 NC	5.5	7.5	16		3LD2003-1TP5□	1	1 unit	103	0.224	
			7.5	9.5	25		3LD2103-1TP5□	1	1 unit	103	0.221	
			9.5	11.5	32		3LD2203-1TP5□	1	1 unit	103	0.223	
			18.5	22.0	63		3LD2504-1TP5□	1	1 unit	103	0.424	
			30.0	37.0	100		3LD2704-1TP5□	1	1 unit	103	0.513	
			37	45.0	125		3LD2804-1TP5□	1	1 unit	103	0.513	
			50.0	75.0	160		3LD2305-0TK1□ +2)	1	1 unit	103	2.085	
						▶	3LD9200-5B	1	1 unit	103	0.024	
			110.0	132.0	250		3LD2405-0TK1□ +2)	1	1 unit	103	2.090	
						▶	3LD9200-5B	1	1 unit	103	0.024	
	3 + N	1 NO + 1 NC	5.5	7.5	16		3LD2003-2EP5□	1	1 unit	103	0.234	
			7.5	9.5	25		3LD2103-2EP5□	1	1 unit	103	0.255	
			9.5	11.5	32		3LD2203-1TL5□ +2)	1	1 unit	103	0.236	
						▶	3LD9200-5B	1	1 unit	103	0.024	
			18.5	22.0	63		3LD2504-1TP5□ +1)	1	1 unit	103	0.424	
						▶	3LD9250-0BA	1	1 unit	103	0.077	
			30.0	37.0	100	▶	3LD2704-0TK5□ +1)	1	1 unit	103	0.497	
						▶	3LD9280-0B +2)	1	1 unit	103	0.099	
						▶	3LD9200-5B	1	1 unit	103	0.024	
			37.0	45.0	125		3LD2804-0TK5□ +1)	1	1 unit	103	0.490	
					▶	3LD9280-0B +2)	1	1 unit	103	0.099		
					▶	3LD9200-5B	1	1 unit	103	0.024		
		50.0	75.0	160		3LD2305-1TL1□ +2)	1	1 unit	103	2.580		
					▶	3LD9200-5B	1	1 unit	103	0.024		
		110.0	132.0	250		3LD2405-1TL1□ +2)	1	1 unit	103	2.592		
					▶	3LD9200-5B	1	1 unit	103	0.024		

Actuator color

Black

Red/yellow (EMERGENCY-STOP)

1

3

¹⁾ 4th cont. element as N conductor to be ordered separately, see "Accessories".

²⁾ Auxiliary switches 1 NO + 1 NC to be ordered separately, see "Accessories".

3LD Main Control and EMERGENCY-STOP Switches up to 250 A

Front mounting

Number and version of the contacts		Rated data at 50 ... 60 Hz, 380 ... 440 V			DT	Article No.	Price per PU	PU (UNIT, SET, M)	PS*/P. unit	PG	Weight per PU approx.
Main contact elements	Auxiliary contact elements	P/AC-3 kW	P/AC-23A kW	I _n /AC-21A A							kg
Main control and EMERGENCY-STOP switches with rotary operating mechanism/knob-operated mechanism <ul style="list-style-type: none"> • Lockable in 0 position with up to 3 padlocks • Degree of protection at front side IP65 • All versions with rotary operating mechanism Exception: 3LD23 and 3LD24 with knob-operated mechanism • Including terminal cover for the infeed side • Front plate <ul style="list-style-type: none"> - 3LD20, 3LD21, 3LD22: 67 mm × 67 mm - 3LD25 to 3LD28: 90 mm × 90 mm - 3LD23 to 3LD24: 96 mm × 96 mm 											
Center-hole mounting Ø 22.5 mm											
 3LD2254-0TK53	3	--	5.5	7.5	16	3LD2054-0TK5□		1	1 unit	103	0.210
			7.5	9.5	25	3LD2154-0TK5□		1	1 unit	103	0.208
			9.5	11.5	32	3LD2254-0TK5□		1	1 unit	103	0.206
			18.5	22	63	3LD2555-0TK5□		1	1 unit	103	0.423
	3 + N	--	5.5	7.5	16	3LD2054-1TL5□		1	1 unit	103	0.216
			7.5	9.5	25	3LD2154-1TL5□		1	1 unit	103	0.245
			9.5	11.5	32	3LD2254-1TL5□		1	1 unit	103	0.242
			18.5	22	63	3LD2555-0TK5□ +1)		1	1 unit	103	0.423
	3	1 NO + 1 NC	5.5	7.5	16	▶ 3LD9250-0BA		1	1 unit	103	0.077
			7.5	9.5	25	3LD2054-1TP5□		1	1 unit	103	0.225
			9.5	11.5	32	3LD2154-1TP5□		1	1 unit	103	0.232
			9.5	11.5	32	3LD2254-0TK5□ +2)		1	1 unit	103	0.206
18.5			22	63	▶ 3LD9200-5B		1	1 unit	103	0.024	
18.5			22	63	3LD2555-0TK5□ +2)		1	1 unit	103	0.423	
18.5			22	63	▶ 3LD9200-5B		1	1 unit	103	0.024	
18.5			22	63	▶ 3LD2555-0TK5□ +1)		1	1 unit	103	0.423	
3 + N	1 NO + 1 NC	5.5	7.5	16	3LD2054-2EP5□		1	1 unit	103	0.232	
		7.5	9.5	25	3LD2154-2EP5□		1	1 unit	103	0.262	
		9.5	11.5	32	3LD2254-1TL5□ +2)		1	1 unit	103	0.242	
		18.5	22	63	▶ 3LD9200-5B		1	1 unit	103	0.024	
18.5	22	63	3LD2555-0TK5□ +1)		1	1 unit	103	0.423			
18.5	22	63	▶ 3LD9250-0BA +2)		1	1 unit	103	0.077			
18.5	22	63	▶ 3LD9200-5B		1	1 unit	103	0.024			

Actuator color

Black

Red/yellow (EMERGENCY-STOP)

1

3

1) 4th contact element as N conductor to be ordered separately, see "Accessories".

2) Auxiliary switches 1 NO + 1 NC to be ordered separately, see "Accessories".

Switch Disconnectors

3LD Main Control and EMERGENCY-STOP Switches up to 250 A

Front mounting

Number and version of the contacts		Rated data 50 ... 60 Hz, 380 ... 440 V		DT	Article No.	Price per PU	PU (UNIT, SET, M)	PS*/P. unit	PG	Weight per PU approx.
Main contact elements	Auxiliary contact elements	P/AC-23A	I_u							kg
		kW	A							
Main control and EMERGENCY-STOP switches with knob-operated mechanism <ul style="list-style-type: none"> Lockable in 0 position (can be modified to I position) with max. 2 padlocks Degree of protection at front side IP65 Including terminal cover for the infeed side Front plate <ul style="list-style-type: none"> - 48 mm x 48 mm 										
Four-hole mounting										
 3LD2222-0TK11	3	--	7.5	16	3LD2022-0TK1□		1	1 unit	103	0.181
			9.5	25	3LD2122-0TK1□		1	1 unit	103	0.181
			11.5	32	3LD2222-0TK1□		1	1 unit	103	0.181
	3 + N	--	7.5	16	3LD2022-1TL1□		1	1 unit	103	0.192
			9.5	25	3LD2122-1TL1□		1	1 unit	103	0.213
			11.5	32	3LD2222-0TK1□⁺¹⁾		1	1 unit	103	0.181
					▶ 3LD9220-0B		1	1 unit	103	0.037
	3	1 NO + 1 NC	7.5	16	3LD2022-0TK1□⁺²⁾		1	1 unit	103	0.181
					▶ 3LD9200-5B		1	1 unit	103	0.024
			9.5	25	3LD2122-0TK1□⁺²⁾		1	1 unit	103	0.181
					▶ 3LD9200-5B		1	1 unit	103	0.024
			11.5	32	3LD2222-0TK1□⁺²⁾		1	1 unit	103	0.181
					▶ 3LD9200-5B		1	1 unit	103	0.024
	3 + N	1 NO + 1 NC	7.5	16	3LD2022-1TL1□⁺²⁾		1	1 unit	103	0.192
					▶ 3LD9200-5B		1	1 unit	103	0.024
			9.5	25	3LD2122-1TL1□⁺²⁾		1	1 unit	103	0.213
					▶ 3LD9200-5B		1	1 unit	103	0.024
			11.5	32	3LD2222-0TK1□⁺¹⁾		1	1 unit	103	0.181
					▶ 3LD9220-0B		1	1 unit	103	0.037
					▶ 3LD9200-5B		1	1 unit	103	0.024

Actuator color

Black
Red/yellow (EMERGENCY-STOP)

1
3

- 1) 4th contact element as N conductor to be ordered separately, see "Accessories".
- 2) Auxiliary switches 1 NO + 1 NC to be ordered separately, see "Accessories".

Switch Disconnectors

3LD Main Control and EMERGENCY-STOP Switches up to 250 A

Front mounting

Number and version of the contacts		Rated data at 50 ... 60 Hz, 380 ... 440 V		DT	Article No.	Price per PU	PU (UNIT, SET, M)	PS*/P. unit	PG	Weight per PU approx.
Main contact elements	Auxiliary contact elements	P/AC-23A	I_u							kg
		kW	A							
Main control and EMERGENCY-STOP switches with knob-operated mechanism <ul style="list-style-type: none"> • Lockable in 0 position (can be modified to I position) with max. 2 padlocks • Degree of protection at front side IP65 • Including terminal cover for the infeed side • Front plate: 48 mm × 48 mm 										
Center-hole mounting Ø 22.5 mm										
 3LD2150-0TK13	3	--	7.5	16	3LD2050-0TK1□		1	1 unit	103	0.187
			9.5	25	3LD2150-0TK1□		1	1 unit	103	0.186
			11.5	32	3LD2250-0TK1□		1	1 unit	103	0.186
	3 + N	--	7.5	16	3LD2050-1TL1□		1	1 unit	103	0.196
			9.5	25	3LD2150-0TK1□ ⁺²⁾		1	1 unit	103	0.186
					▶ 3LD9200-5B		1	1 unit	103	0.024
			11.5	32	3LD2250-0TK1□ ⁺²⁾		1	1 unit	103	0.186
					▶ 3LD9200-5B		1	1 unit	103	0.024
	3	1 NO + 1 NC	7.5	16	3LD2050-0TK1□ ⁺²⁾		1	1 unit	103	0.187
					▶ 3LD9200-5B		1	1 unit	103	0.024
			9.5	25	3LD2150-0TK1□ ⁺²⁾		1	1 unit	103	0.186
					▶ 3LD9200-5B		1	1 unit	103	0.024
			11.5	32	3LD2250-0TK1□ ⁺²⁾		1	1 unit	103	0.186
					▶ 3LD9200-5B		1	1 unit	103	0.024
	3 + N	1 NO + 1 NC	7.5	16	3LD2050-1TL1□ ⁺²⁾		1	1 unit	103	0.196
					▶ 3LD9200-5B		1	1 unit	103	0.024
			9.5	25	3LD2150-0TK1□ ⁺¹⁾		1	1 unit	103	0.186
					▶ 3LD9220-0B		1	1 unit	103	0.037
				▶ 3LD9200-5B ⁺²⁾		1	1 unit	103	0.024	
		11.5	32	3LD2250-0TK1□ ⁺¹⁾		1	1 unit	103	0.186	
				▶ 3LD9220-0B		1	1 unit	103	0.037	
				▶ 3LD9200-5B ⁺²⁾		1	1 unit	103	0.024	

Actuator color

Black

Red/yellow (EMERGENCY-STOP)

 1
3

1) 4th contact element as N conductor to be ordered separately, see "Accessories".

2) Auxiliary switches 1 NO + 1 NC to be ordered separately, see "Accessories".

Switch Disconnectors

3LD Main Control and EMERGENCY-STOP Switches up to 250 A

Front mounting

Number and version of the contacts		Rated data at 50 ... 60 Hz, 380 ... 440 V			DT	Article No.	Price per PU	PU (UNIT, SET, M)	PS*/P. unit	PG	Weight per PU approx.
Main contact elements	Auxiliary contact elements	P/AC-3 kW	P/AC-23A kW	I_u A							kg

Main control and EMERGENCY-STOP switches with rotary operating mechanism/knob-operated mechanism (6-pole)

- Lockable in 0 position with up to 3 padlocks
- Degree of protection at front side IP65
- All versions with rotary operating mechanism
Exception: 3LD23 and 3LD24 with knob-operated mechanism
- Including terminal cover for the infeed side
- Front plate
 - 3LD20, 3LD21, 3LD22: 67 mm × 67 mm
 - 3LD25: 90 mm × 90 mm
 - 3LD23 to 3LD24: 96 mm × 96 mm

Four-hole mounting



3LD2103-3VK53

6	--	7.5	9.5	25	3LD2103-3VK5□		1	1 unit	103	0.386
		9.5	11.5	32			1	1 unit	103	0.381
		18.5	22.0	63			1	1 unit	103	0.751
		50	75	160			1	1 unit	103	3.940
		110	132	250			1	1 unit	103	3.949
6	1 NO + 1 NC	7.5	9.5	25	3LD2103-4VP5□		1	1 unit	103	0.408

Actuator color

Black
Red/yellow (EMERGENCY-STOP)

1
3

Number and version of the contacts		Rated data at 50 ... 60 Hz, 380 ... 440 V			DT	Article No.	Price per PU	PU (UNIT, SET, M)	PS*/P. unit	PG	Weight per PU approx.
Main contact elements	Auxiliary contact elements	P/AC-3 kW	P/AC-23A kW	I_u A							kg

Changeover switches with knob-operated mechanism

- Black actuator
- Knob-operated mechanism on 3LD23 and 3LD24 is lockable, on all other versions it is non-lockable
- Degree of protection at front side IP65

Four-hole mounting



3LD2123-7UK01

3	--	7.5	9.5	25	3LD2123-7UK01		1	1 unit	103	0.376
		9.5	11.5	32			1	1 unit	103	0.376
		18.5	22.0	63			1	1 unit	103	0.744
		30.0	37.0	100			1	1 unit	103	0.952
		50	75	160			1	1 unit	103	4.340
		110	132	250			1	1 unit	103	4.401



3LD2405-7UL01

3 + N		50	75	160	3LD2305-7UL01		1	1 unit	103	5.885
		110	132	250			1	1 unit	103	5.745

Switch Disconnectors

3LD Main Control and EMERGENCY-STOP Switches up to 250 A

Floor mounting

Selection and ordering data

Number and version of the contacts		Rated data at 50 ... 60 Hz, 380 ... 440 V		DT	Article No.	Price per PU	PU (UNIT, SET, M)	PS*/P. unit	PG	Weight per PU approx.
Main contact elements	Auxiliary contact elements	P/AC-23A	I_u							kg
		kW	A							
Main control and EMERGENCY-STOP switches with door-coupling rotary operating mechanism <ul style="list-style-type: none"> • With shaft • Lockable in 0 position with up to 3 padlocks • Degree of protection at front side IP65 • Door-coupling rotary operating mechanism with integrated tolerance compensation (16 A to 125 A) • All versions with rotary operating mechanism • Exception: 3LD23 and 3LD24 with knob-operated mechanism • Mounting using screws or snap-on mounting on 35 mm standard mounting rail (16 A to 125 A) • Including terminal cover for the infeed side • Front plate <ul style="list-style-type: none"> - 3LD20, 3LD21, 3LD22: 67 mm x 67 mm - 3LD25 to 3LD28: 90 mm x 90 mm - 3LD23 to 3LD24: 96 mm x 96 mm • Mounting dimensions <ul style="list-style-type: none"> - 3LD20, 3LD21, 3LD22: 380 mm - 3LD25 to 3LD28: 390 mm - 3LD23 to 3LD24: 600 mm 										
Four-hole mounting										
 3LD2213-0TK53	3	--	7.5	16	▶	3LD2013-0TK5□	1	1 unit	103	0.400
			9.5	25	▶	3LD2113-0TK5□	1	1 unit	103	0.411
			11.5	32	▶	3LD2213-0TK5□	1	1 unit	103	0.400
			22	63	▶	3LD2514-0TK5□	1	1 unit	103	0.638
			37	100	▶	3LD2714-0TK5□	1	1 unit	103	0.767
			45	125		3LD2814-0TK5□	1	1 unit	103	0.760
			75	160		3LD2318-0TK1□	1	1 unit	103	2.815
			132	250		3LD2418-0TK1□	1	1 unit	103	2.714
	3 + N	--	7.5	16	▶	3LD2013-1TL5□	1	1 unit	103	0.411
			9.5	25		3LD2113-1TL5□	1	1 unit	103	0.431
			11.5	32		3LD2213-1TL5□	1	1 unit	103	0.442
			22	63		3LD2514-1TL5□	1	1 unit	103	0.713
			37	100	▶	3LD2714-0TK5□ + ¹⁾	1	1 unit	103	0.767
					▶	3LD9280-0C	1	1 unit	103	0.099
			45	125		3LD2814-0TK5□ + ¹⁾	1	1 unit	103	0.760
					▶	3LD9280-0C	1	1 unit	103	0.099
		75	160		3LD2318-1TL1□	1	1 unit	103	3.337	
		132	250		3LD2418-1TL1□	1	1 unit	103	3.226	

Actuator color

Black

Red/yellow (EMERGENCY-STOP)

1

3

¹⁾ 4th contact element as N conductor to be ordered separately, see "Accessories".

Switch Disconnectors

3LD Main Control and EMERGENCY-STOP Switches up to 250 A

Floor mounting



3LD2213-0TK53

7

Number and version of the contacts		Rated data at 50 ... 60 Hz, 380 ... 440 V		DT	Article No.	Price per PU	PU (UNIT, SET, M)	PS*/P. unit	PG	Weight per PU approx. kg
Main contact elements	Auxiliary contact elements	P/AC-23A	I_u							
		kW	A							
3	1 NO + 1 NC	7.5	16	▶	3LD2013-0TK5□ ⁺²⁾		1	1 unit	103	0.400
				▶	3LD9200-5C		1	1 unit	103	0.025
		9.5	25	▶	3LD2113-0TK5□ ⁺²⁾		1	1 unit	103	0.411
				▶	3LD9200-5C		1	1 unit	103	0.025
		11.5	32	▶	3LD2213-0TK5□ ⁺²⁾		1	1 unit	103	0.400
				▶	3LD9200-5C		1	1 unit	103	0.025
		22	63	▶	3LD2514-0TK5□ ⁺²⁾		1	1 unit	103	0.638
				▶	3LD9200-5C		1	1 unit	103	0.025
		37	100	▶	3LD2714-0TK5□ ⁺²⁾		1	1 unit	103	0.767
				▶	3LD9200-5C		1	1 unit	103	0.025
		45	125	▶	3LD2814-0TK5□ ⁺²⁾		1	1 unit	103	0.760
				▶	3LD9200-5C		1	1 unit	103	0.025
		75	160	▶	3LD2318-0TK1□ ⁺²⁾		1	1 unit	103	2.815
				▶	3LD9200-5C		1	1 unit	103	0.025
132	250	▶	3LD2418-0TK1□ ⁺²⁾		1	1 unit	103	2.714		
		▶	3LD9200-5C		1	1 unit	103	0.025		
3 + N	1 NO + 1 NC	7.5	16	▶	3LD2013-1TL5□ ⁺²⁾		1	1 unit	103	0.411
				▶	3LD9200-5C		1	1 unit	103	0.025
		9.5	25	▶	3LD2113-1TL5□ ⁺²⁾		1	1 unit	103	0.431
				▶	3LD9200-5C		1	1 unit	103	0.025
		11.5	32	▶	3LD2213-1TL5□ ⁺²⁾		1	1 unit	103	0.442
				▶	3LD9200-5C		1	1 unit	103	0.025
		22	63	▶	3LD2514-1TL5□ ⁺²⁾		1	1 unit	103	0.713
				▶	3LD9200-5C		1	1 unit	103	0.025
		37	100	▶	3LD2714-0TK5□ ⁺¹⁾		1	1 unit	103	0.767
				▶	3LD9280-0C ⁺²⁾		1	1 unit	103	0.099
				▶	3LD9200-5C		1	1 unit	103	0.025
		45	125	▶	3LD2814-0TK5□ ⁺¹⁾		1	1 unit	103	0.760
				▶	3LD9280-0C ⁺²⁾		1	1 unit	103	0.099
				▶	3LD9200-5C		1	1 unit	103	0.025
75	160	▶	3LD2318-1TL1□ ⁺²⁾		1	1 unit	103	3.337		
		▶	3LD9200-5C		1	1 unit	103	0.025		
132	250	▶	3LD2418-1TL1□ ⁺²⁾		1	1 unit	103	3.226		
		▶	3LD9200-5C		1	1 unit	103	0.025		

Actuator color

Black

Red/yellow (EMERGENCY-STOP)

1

3

1) 4th contact element as N conductor to be ordered separately, see "Accessories".

2) Auxiliary switches 1 NO + 1 NC to be ordered separately, see "Accessories".

3LD Main Control and EMERGENCY-STOP Switches up to 250 A

Floor mounting

Number and version of the contacts		Rated data at 50 ... 60 Hz, 380 ... 440 V		DT	Article No.	Price per PU	PU (UNIT, SET, M)	PS*/P. unit	PG	Weight per PU approx.
Main contact elements	Auxiliary contact elements	P/AC-23A	I_U							kg
		kW	A							
Main control and EMERGENCY-STOP switches with door-coupling rotary operating mechanism <ul style="list-style-type: none"> • With shaft • Lockable in 0 position with up to 3 padlocks • Degree of protection at front side IP65 • Door-coupling rotary operating mechanism with integrated tolerance compensation (16 A to 125 A) • All versions with rotary operating mechanism • Exception: 3LD23 and 3LD24 with knob-operated mechanism • Mounting using screws or snap-on mounting on 35 mm standard mounting rail (16 A to 125 A) • Including terminal cover for the infeed side • Front plate <ul style="list-style-type: none"> - 3LD20, 3LD21, 3LD22: 67 mm x 67 mm - 3LD25 to 3LD28: 90 mm x 90 mm - 3LD23 to 3LD24: 96 mm x 96 mm • Mounting dimensions <ul style="list-style-type: none"> - 3LD20, 3LD21, 3LD22: 380 mm - 3LD25 to 3LD28: 390 mm - 3LD23 to 3LD24: 600 mm 										
Center-hole mounting Ø 22.5 mm										
 3LD2144-0TK53	3	--	7.5	16	3LD2044-0TK5□		1	1 unit	103	0.435
			9.5	25	3LD2144-0TK5□		1	1 unit	103	0.434
			11.5	32	3LD2244-0TK5□		1	1 unit	103	0.421
			22	63	3LD2545-0TK5□		1	1 unit	103	0.733
	3 + N	--	7.5	16	3LD2044-1TL5□		1	1 unit	103	0.433
			9.5	25	3LD2144-1TL5□		1	1 unit	103	0.465
			11.5	32	3LD2244-1TL5□		1	1 unit	103	0.465
			22	63	3LD2545-0TK5□ ⁺¹⁾		1	1 unit	103	0.733
					3LD9250-OCA		1	1 unit	103	0.077
	3	1 NO + 1 NC	7.5	16	3LD2044-0TK5□ ⁺²⁾		1	1 unit	103	0.435
					3LD9200-5C		1	1 unit	103	0.025
			9.5	25	3LD2144-0TK5□ ⁺²⁾		1	1 unit	103	0.434
					3LD9200-5C		1	1 unit	103	0.025
			11.5	32	3LD2244-0TK5□ ⁺²⁾		1	1 unit	103	0.421
					3LD9200-5C		1	1 unit	103	0.025
			22	63	3LD2545-0TK5□ ⁺²⁾		1	1 unit	103	0.733
					3LD9200-5C		1	1 unit	103	0.025
	3 + N	1 NO + 1 NC	7.5	16	3LD2044-1TL5□ ⁺²⁾		1	1 unit	103	0.433
					3LD9200-5C		1	1 unit	103	0.025
			9.5	25	3LD2144-1TL5□ ⁺²⁾		1	1 unit	103	0.465
				3LD9200-5C		1	1 unit	103	0.025	
		11.5	32	3LD2244-1TL5□ ⁺²⁾		1	1 unit	103	0.465	
				3LD9200-5C		1	1 unit	103	0.025	
		22	63	3LD2545-0TK5□ ⁺¹⁾		1	1 unit	103	0.733	
				3LD9250-OCA ⁺²⁾		1	1 unit	103	0.077	
				3LD9200-5C		1	1 unit	103	0.025	

Actuator color

Black

Red/yellow (EMERGENCY-STOP)

1
3

1) 4th contact element as N conductor to be ordered separately, see "Accessories".

2) Auxiliary switches 1 NO + 1 NC to be ordered separately, see "Accessories".

Switch Disconnectors

3LD Main Control and EMERGENCY-STOP Switches up to 250 A

Floor mounting

Number and version of the contacts		Rated data at 50 Hz ... 60 Hz, 380 V ... 440 V			DT	Article No.	Price per PU	PU (UNIT, SET, M)	PS*/P. unit	PG	Weight per PU approx.
Main contact elements	Auxiliary contact elements	P/AC-3	P/AC-23A	I_u							kg
		kW	kW	A							
Main control and EMERGENCY-STOP switches with door-coupling rotary operating mechanism (6-pole) <ul style="list-style-type: none"> • Lockable in 0 position with up to 3 padlocks • Degree of protection at front side IP65 • Door-coupling rotary operating mechanism with integrated tolerance compensation (for 3LD21) • All versions with rotary operating mechanism Exception: 3LD23 and 3LD24 with door-coupling rotary operating mechanism as selector switch • Mounting using screws or snap-on mounting on 35 mm standard mounting rails • Including terminal cover for the infeed side • Front plate <ul style="list-style-type: none"> - 3LD20, 3LD21, 3LD22: 67 mm × 67 mm - 3LD23, 3LD24: 96 mm × 96 mm 											

Four-hole mounting



3LD2113-3VK51

6	--	7.5	9.5	25		3LD2113-3VK5□		1	1 unit	103	0.597
6	--	50	75	160		3LD2318-3VK1□		1	1 unit	103	4.450
6	--	110	132	250		3LD2418-3VK1□		1	1 unit	103	4.530
6	1 NO + 1 NC	9.5	9.5	25		3LD2113-4VP5□		1	1 unit	103	0.615

Actuator color

Black
Red/yellow (EMERGENCY-STOP)

1
3

Number and version of the contacts		Rated data at 50 Hz ... 60 Hz, 380 V ... 440 V			DT	Article No.	Price per PU	PU (UNIT, SET, M)	PS*/P. unit	PG	Weight per PU approx.
Main contact elements	Auxiliary contact elements	P/AC-3	P/AC-23A	I_u							kg
		kW	kW	A							
Changeover switches with door-coupling rotary operating mechanism <ul style="list-style-type: none"> • Lockable in 0 position with up to 3 padlocks • Handle and cover black • Door-coupling rotary operating mechanisms as selector switch • Degree of protection at front side IP65 											
Four-hole mounting											
3		50	75	160		3LD2318-7UK01		1	1 unit	103	4.986
3		110	132	250		3LD2418-7UK01		1	1 unit	103	5.003
3 + N		50	75	160		3LD2318-7UL01		1	1 unit	103	6.362
3 + N		110	132	250		3LD2418-7UL01		1	1 unit	103	6.328

Switch Disconnectors

3LD Main Control and EMERGENCY-STOP Switches up to 250 A

Floor mounting

Number and version of the contacts		Rated data at 50 ... 60 Hz, 380 ... 440 V		DT	Article No.	Price per PU	PU (UNIT, SET, M)	PS*/P. unit	PG	Weight per PU approx.
Main contact elements	Auxiliary contact elements	P/AC-23A	I_u							kg
		kW	A							
<p>Main control and EMERGENCY-STOP switches with defeatable door-coupling rotary operating mechanism</p> <p>The 3LD main control and EMERGENCY-STOP switch with defeatable door-coupling rotary operating mechanism enables you to conduct repairs, maintenance work or tests on electrical plants and machines without having to interrupt their operation. With the help of the defeatable door-coupling rotary operating mechanism, an electrician can bypass the interlock in ON position and open the control cabinet door with the plant activated.</p> <p>3LD main and EMERGENCY-STOP switches with defeatable door-coupling rotary operating mechanism are approved according to UL508.</p> <ul style="list-style-type: none"> • With 300 mm switch shaft • Lockable in 0 position with up to 3 padlocks • Degree of protection at front side IP65 • Door-coupling rotary operating mechanism with integrated tolerance compensation • Mounting using screws or snap-on mounting on 35 mm standard mounting rails • Including terminal cover for the infeed side • Front plate 65 mm × 65 mm 										
Four-hole mounting										
 <p>3LD2017-0TK..</p>	3	--	7.5	16	3LD2017-0TK1□		1	1 unit	103	0.426
			11.5	32	3LD2217-0TK1□		1	1 unit	103	0.421
			22	63	3LD2517-0TK1□		1	1 unit	103	0.568
	3 + N	--	7.5	16	3LD2017-1TL1□		1	1 unit	103	0.426
			11.5	32	3LD2217-1TL1□		1	1 unit	103	0.445
			22	63	3LD2517-1TL1□		1	1 unit	103	0.646

Actuator color

Black
Red/yellow (EMERGENCY-STOP)

1
3

7

Switch Disconnectors

3LD Main Control and EMERGENCY-STOP Switches up to 250 A

Floor mounting



Accessories

Defeatable door-coupling rotary operating mechanisms from 100 A - 250 A

For switch disconnectors with door-coupling rotary operating mechanisms, a defeatable door-coupling rotary operating mechanism can be assembled with the following components from the 8UC7 series.

The following components are to be used for this purpose:

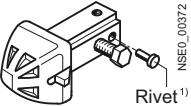
- For 3LD27 and 3LD28 switch disconnectors with door-coupling rotary operating mechanisms:
 - 8UC7110-1BB
 - 8UC7120-3BB
 - 8UC6011
- For 3LD23 and 3LD24 switch disconnectors with door-coupling rotary operating mechanisms:
 - 8UC7410-1BB
 - 8UC7420-3BB
 - 8UC6012

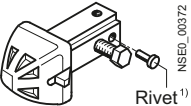
	Rotary operating mechanisms	Size	Cross-section of the actuating shaft	Version ²⁾	DT	Individual parts for 8UC7 door-coupling rotary operating mechanisms Article No. Price per PU	PU (UNIT, SET, M)	PS*/P. unit	PG	Weight per PU approx. kg
	Type		mm × mm							
Components for 3LD27, 3LD28										
	8UC71	1	6 × 6	Standard	EMERGENCY-STOP	8UC7110-1BB 8UC7120-3BB	1	1 unit	103	0.181
8UC71							1	1 unit	103	0.178
	8UC71	1	6 × 6	--		8UC6011	1	1 unit	103	0.076
8UC6011										
Components for 3LD23, 3LD24										
	8UC72	2	8 × 8	Standard	EMERGENCY-STOP	8UC7210-1BB 8UC7220-3BB	1	1 unit	103	0.190
8UC74							1	1 unit	103	0.186
	8UC72	2	8 × 8	--		8UC6012	1	1 unit	103	0.073
8UC6012										

¹⁾ Non-interchangeability features.



²⁾ Standard: Ti-grey handle, light-gray masking plate;
EMERGENCY-STOP: Red handle, yellow masking plate.

Switch Disconnectors

3LD Main Control and EMERGENCY-STOP Switches up to 250 A

Distribution board mounting

Selection and ordering data

Number and version of the contacts		Rated data at 50 ... 60 Hz, 380 ... 440 V		DT	Article No.	Price per PU	PU (UNIT, SET, M)	PS*/P. unit	PG	Weight per PU approx.	
Main contact elements	Auxiliary contact elements	P/AC-23A	I_u							kg	
		kW	A								
ON/OFF and EMERGENCY-STOP switches with masking plate and selector knob <ul style="list-style-type: none"> • With screw fixing • With snap-on mounting on 35 mm standard mounting rail (16 to 125 A) • Lockable in 0 position with up to 2 (160 A and 250 A: max. 3) padlocks • Degree of protection at front side IP44 • Including terminal cover for the infeed and outgoing terminal (160 A and 250 A) 											
 3LD2530-0TK13	3	--	7.5	16		3LD2030-0TK1□		1	1 unit	103	0.169
			9.5	25		3LD2130-0TK1□		1	1 unit	103	0.165
			11.5	32		3LD2230-0TK1□		1	1 unit	103	0.167
			22	63		3LD2530-0TK1□		1	1 unit	103	0.309
			37	100		3LD2730-0TK1□		1	1 unit	103	0.371
			45	125		3LD2830-0TK1□		1	1 unit	103	0.370
			75	160		3LD2330-0TK1□		1	1 unit	103	2.030
 3LD2330-0TK11	3 + N	--	7.5	16		3LD2030-1TL1□		1	1 unit	103	0.178
			9.5	25		3LD2130-0TK1□ ⁺¹⁾		1	1 unit	103	0.165
					▶	3LD9220-0C		1	1 unit	103	0.036
			11.5	32		3LD2230-0TK1□ ⁺¹⁾		1	1 unit	103	0.167
					▶	3LD9220-0C		1	1 unit	103	0.036
			22	63		3LD2530-0TK1□ ⁺¹⁾		1	1 unit	103	0.309
					▶	3LD9250-0CA		1	1 unit	103	0.077
			37	100		3LD2730-0TK1□ ⁺¹⁾		1	1 unit	103	0.371
					▶	3LD9280-0C		1	1 unit	103	0.099
			45	125		3LD2830-0TK1□ ⁺¹⁾		1	1 unit	103	0.370
					▶	3LD9280-0C		1	1 unit	103	0.099
			75	160		3LD2330-0TK1□ ⁺¹⁾		1	1 unit	103	2.030
					▶	3LD9240-0C		1	1 unit	103	0.516
132	250		3LD2430-0TK1□ ⁺¹⁾		1	1 unit	103	2.030			
		▶	3LD9240-0C		1	1 unit	103	0.516			

Actuator color

Black

Red/yellow (EMERGENCY-STOP)



 1
3

¹⁾ 4th contact element as N conductor to be ordered separately; see "Accessories for floor mounting".

Switch Disconnectors

3LD Main Control and EMERGENCY-STOP Switches up to 250 A

Distribution board mounting

	Number and version of the contacts		Rated data at 50 ... 60 Hz, 380 ... 440 V		DT	Article No.	Price per PU	PU (UNIT, SET, M)	PS*/P. unit	PG	Weight per PU approx. kg	
	Main contact elements	Auxiliary contact elements	P/AC-23A	I_u								
			kW	A								
 3LD2530-0TK11	3	1 NO + 1 NC	7.5	16	▶	3LD2030-0TK1□ ⁺²⁾		1	1 unit	103	0.169	
						▶	3LD9200-5C		1	1 unit	103	0.025
			9.5	25	▶	3LD2130-0TK1□ ⁺²⁾		1	1 unit	103	0.165	
						▶	3LD9200-5C		1	1 unit	103	0.025
			11.5	32	▶	3LD2230-0TK1□ ⁺²⁾		1	1 unit	103	0.167	
						▶	3LD9200-5C		1	1 unit	103	0.025
			22	63	▶	3LD2530-0TK1□ ⁺²⁾		1	1 unit	103	0.309	
						▶	3LD9200-5C		1	1 unit	103	0.025
			37	100	▶	3LD2730-0TK1□ ⁺²⁾		1	1 unit	103	0.371	
				▶	3LD9200-5C		1	1 unit	103	0.025		
	45	125	▶	3LD2830-0TK1□ ⁺²⁾		1	1 unit	103	0.370			
				▶	3LD9200-5C		1	1 unit	103	0.025		
	75	160	▶	3LD2330-0TK1□ ⁺²⁾		1	1 unit	103	2.030			
				▶	3LD9200-5C		1	1 unit	103	0.025		
	132	250	▶	3LD2430-0TK1□ ⁺²⁾		1	1 unit	103	2.030			
				▶	3LD9200-5C		1	1 unit	103	0.025		
	3 + N	1 NO + 1 NC	7.5	16	▶	3LD2030-1TL1□ ⁺²⁾		1	1 unit	103	0.178	
						▶	3LD9200-5C		1	1 unit	103	0.025
			9.5	25	▶	3LD2130-0TK1□ ⁺²⁾		1	1 unit	103	0.165	
					▶	3LD9200-5C ⁺¹⁾		1	1 unit	103	0.025	
					▶	3LD9220-0C		1	1 unit	103	0.036	
11.5			32	▶	3LD2230-0TK1□ ⁺²⁾		1	1 unit	103	0.167		
					▶	3LD9200-5C ⁺¹⁾		1	1 unit	103	0.025	
					▶	3LD9220-0C		1	1 unit	103	0.036	
22			63	▶	3LD2530-0TK1□ ⁺²⁾		1	1 unit	103	0.309		
					▶	3LD9200-5C ⁺¹⁾		1	1 unit	103	0.025	
					▶	3LD9250-0CA		1	1 unit	103	0.077	
37			100	▶	3LD2730-0TK1□ ⁺²⁾		1	1 unit	103	0.371		
			▶	3LD9200-5C ⁺¹⁾		1	1 unit	103	0.025			
			▶	3LD9280-0C		1	1 unit	103	0.099			
45	125	▶	3LD2830-0TK1□ ⁺²⁾		1	1 unit	103	0.370				
			▶	3LD9200-5C ⁺¹⁾		1	1 unit	103	0.025			
			▶	3LD9280-0C		1	1 unit	103	0.099			
75	160	▶	3LD2330-0TK1□ ⁺²⁾		1	1 unit	103	2.030				
			▶	3LD9200-5C ⁺¹⁾		1	1 unit	103	0.025			
			▶	3LD9240-0C		1	1 unit	103	0.516			
132	250	▶	3LD2430-0TK1□ ⁺²⁾		1	1 unit	103	2.030				
			▶	3LD9200-5C ⁺¹⁾		1	1 unit	103	0.025			
			▶	3LD9240-0C		1	1 unit	103	0.516			

Actuator color

Black
Red/yellow (EMERGENCY-STOP)

1
3

1) 4th contact element as N conductor to be ordered separately; see "Accessories for floor mounting".

2) Auxiliary switches 1 NO + 1 NC to be ordered separately; see "Accessories".

Switch Disconnectors

3LD Main Control and EMERGENCY-STOP Switches up to 250 A

Molded-plastic enclosures

Selection and ordering data

Number and version of the contacts		Base terminal	Rated data at 50 ... 60 Hz, 380 ... 440 V		DT	Article No.	Price per PU	PU (UNIT, SET, M)	PS*/P. unit	PG	Weight per PU approx.
Main contact elements	Auxiliary contact elements		P/AC-23A	I_u							kg
			kW	A							
Main control and EMERGENCY-STOP switches											
<ul style="list-style-type: none"> • With N and/or PE/ground base terminals • Lockable in 0 position with up to 3 padlocks • Degree of protection IP65 • Rotary operating mechanisms with center-hole mounting • For floor-mounted auxiliary switches • Metric screw connection 											
3	--	PE + N	7.5	16		3LD2064-0TB5□		1	1 unit	103	0.458
		PE + N	9.5	25		3LD2164-0TB5□		1	1 unit	103	0.455
		PE + N	11.5	32		3LD2264-0TB5□		1	1 unit	103	0.458
		PE + N	22	63		3LD2565-0TB5□		1	1 unit	103	0.933
		PE + N	37	100		3LD2766-0TB5□		1	1 unit	103	1.930
		PE + N	45	125		3LD2866-0TB5□		1	1 unit	103	1.974
3 + N	--	PE	7.5	16		3LD2064-1TC5□		1	1 unit	103	0.463
		PE	9.5	25		3LD2164-1TC5□		1	1 unit	103	0.478
		PE	11.5	32		3LD2264-1TC5□		1	1 unit	103	0.460
		PE	22	63		3LD2565-1TC5□		1	1 unit	103	0.957
		PE + N	37	100		3LD2766-0TB5□ ⁺¹⁾		1	1 unit	103	1.930
					▶	3LD9280-0C		1	1 unit	103	0.099
		PE + N	45	125		3LD2866-0TB5□ ⁺¹⁾		1	1 unit	103	1.974
					▶	3LD9280-0C		1	1 unit	103	0.099
3	1 NO + 1 NC	N	7.5	16		3LD2064-1GP5□		1	1 unit	103	0.472
		N	9.5	25		3LD2164-1GP5□		1	1 unit	103	0.468
		N	11.5	32		3LD2264-1GP5□		1	1 unit	103	0.473
		N	22	63		3LD2565-1GP5□		1	1 unit	103	0.890
		N	37	100		3LD2766-1GP5□		1	1 unit	103	1.904
		N	45	125		3LD2866-1GP5□		1	1 unit	103	1.901
3 + N	1 NO + 1 NC	PE	7.5	16		3LD2064-1TC5□ ⁺²⁾		1	1 unit	103	0.463
					▶	3LD9200-5C		1	1 unit	103	0.025
		PE	9.5	25		3LD2164-1TC5□ ⁺²⁾		1	1 unit	103	0.478
					▶	3LD9200-5C		1	1 unit	103	0.025
		PE	11.5	32		3LD2264-1TC5□ ⁺²⁾		1	1 unit	103	0.460
					▶	3LD9200-5C		1	1 unit	103	0.025
		PE	22	63		3LD2565-1TC5□ ⁺²⁾		1	1 unit	103	0.957
					▶	3LD9200-5C		1	1 unit	103	0.025
		N	37	100		3LD2766-1GP5□ ⁺¹⁾		1	1 unit	103	1.904
					▶	3LD9280-0C		1	1 unit	103	0.099
		N	45	125		3LD2866-1GP5□ ⁺¹⁾		1	1 unit	103	1.901
					▶	3LD9280-0C		1	1 unit	103	0.099



3LD2164-0TB53

Actuator color

Black

Red/yellow (EMERGENCY-STOP)



1) 4th contact element as N conductor to be ordered separately; see "Accessories for floor mounting".

2) Auxiliary switches 1 NO + 1 NC to be ordered separately; see "Accessories".

Switch Disconnectors

3LD Main Control and EMERGENCY-STOP Switches up to 250 A

Molded-plastic enclosures

Number and version of the contacts	Base terminal	Rated data at 50 ... 60 Hz, 380 ... 440 V			DT	Article No.	Price per PU	PU (UNIT, SET, M)	PS*/P. unit	PG	Weight per PU approx.
		Main contact elements	Auxiliary contact elements	P/AC-3 kW							

Main control and EMERGENCY-STOP switches with rotary operating mechanism (6-pole)

- With N and/or PE/ground base terminals
- Degree of protection IP65
- Metric screw connection



3LD2165-3VB53

6	--	PE + N	7.5	9.5	25	3LD2165-3VB5□		1	1 unit	103	0.904
		PE + N	9.5	11.5	32	3LD2265-3VB5□		1	1 unit	103	0.892
		PE + N	18.5	22.0	63	3LD2566-3VB5□		1	1 unit	103	2.228
6	1 NO + 1 NC	N	7.5	9.5	25	3LD2165-4VD5□		1	1 unit	103	0.873
		N	9.5	11.5	32	3LD2265-4VD5□		1	1 unit	103	0.881
		PE + N	18.5	22.0	63	3LD2566-4VD5□		1	1 unit	103	2.220

Actuator color

- Black
- Red/yellow (EMERGENCY-STOP)

1
3

Number and version of the contacts	Base terminal	Rated data at 50 ... 60 Hz, 380 ... 440 V			DT	Article No.	Price per PU	PU (UNIT, SET, M)	PS*/P. unit	PG	Weight per PU approx.
		Main contact elements	Auxiliary contact elements	P/AC-3 kW							

Changeover switches with knob-operated mechanism

- With N and/or PE/ground base terminals
- Black actuator
- Lockable in 0 position with up to 3 padlocks (25 A and 32 A)
- Metric screw connection
- Degree of protection IP65



3LD2165-7UB01

3	--	PE + N	7.5	9.5	25	3LD2165-7UB01		1	1 unit	103	0.901
		PE + N	9.5	11.5	32	3LD2265-7UB01		1	1 unit	103	0.890
		PE + N	18.5	22.0	63	3LD2566-7UB01		1	1 unit	103	2.211
		PE + N	30.0	37.0	100	3LD2766-7UB01		1	1 unit	103	2.330

Switch Disconnectors

3LD Main Control and EMERGENCY-STOP Switches up to 250 A

DC applications

Selection and ordering data

Mains voltage	Rated current I_e at 800 V DC		DT	Article No.	Price per PU	PU (UNIT, SET, M)	PS*/ P. unit	PG	Weight per PU approx.
Max. V DC	DC-21A A	DC-22A A							kg
Solar plant isolators in molded-plastic enclosure <ul style="list-style-type: none"> Molded-plastic enclosure IP65 Metric screw connection (W x H x D) 146 mm x 199 mm x 136 mm Conductor cross-sections: <ul style="list-style-type: none"> Solid and stranded 1.5 ... 16 mm² Finely stranded with end sleeve max. 10 mm² Lockable 									
800	32	16		3LD2265-8VQ5□-0AF6		1	1 unit	103	0.942



3LD2265-8VQ5.-0AF6

Actuator color

Black
Red/yellow (EMERGENCY-STOP)

1
3

Mains voltage	Rated current I_e at 800 V DC		DT	Article No.	Price per PU	PU (UNIT, SET, M)	PS*/ P. unit	PG	Weight per PU approx.
Max. V DC	DC-21A A	DC-22A A							kg
Solar plant isolators for distribution board mounting <ul style="list-style-type: none"> Conductor cross-sections: <ul style="list-style-type: none"> Solid and stranded 1.5 ... 16 mm² Finely stranded with end sleeve max. 10 mm² Actuator color: Black 									
800	32	16		3LD2230-8VQ11-0AF6		1	1 unit	103	0.413













3LD2265-8VQ11-0AF6

Switch Disconnectors

3LD Main Control and EMERGENCY-STOP Switches up to 250 A

Accessories









Selection and ordering data

Version	DT	3LD20	PU (UNIT, SET, M)	PS*/ P. unit	PG	Weight per PU approx.
Article No.	Price per PU					kg
For front mounting						
 3LD9200-2B	N or PE terminals Through-type	▶	3LD9200-2B	1	1 unit	103 0.031
 3LD9200-5B	Auxiliary switches For mounting on the left and/or right, lagging switch-on, leading switch-off • 1 NO + 1 NC For mounting on the left and/or right, lagging switch-on, with gold-plated contacts for requesting electronic information, leading switch-off • 1 NO + 1 NC	▶	3LD9200-5B 3LD9200-5BF	1	1 unit	103 0.024 103 0.024
For floor mounting, distribution board mounting or molded-plastic enclosures						
 3LD9200-2C	N or PE terminals Through-type	▶	3LD9200-2C	1	1 unit	103 0.024
 3LD9200-5C (left)	Auxiliary switches For mounting on the left and/or right, lagging switch-on, leading switch-off • 1 NO + 1 NC	▶	3LD9200-5C	1	1 unit	103 0.025
 3LD9200-6C (right)	• 2 NO For mounting on the left and/or right, lagging switch-on, with gold-plated contacts for requesting electronic information, leading switch-off • 1 NO + 1 NC	▶	3LD9200-6C 3LD9200-5CF	1	1 unit	103 0.026 103 0.020
For front and floor mounting						
 3LD9224-1B	Rotary operating mechanisms Lockable in 0 position with up to 3 padlocks • For four-hole mounting, including seal - Black - Red/Yellow		3LD9224-1B 3LD9224-3B	1	1 unit	103 0.075 103 0.075
 3LD9224-3D	• For center-hole mounting, including seal and nut - Black - Red/Yellow		3LD9224-1D 3LD9224-3D	1	1 unit	103 0.076 103 0.078
 3LD9256-0A	Mounting tools For center-hole mounting with nut		3LD9256-0A	1	5 units	103 0.011
	Switching shafts 6 x 6 mm Length 300 mm Length 600 mm		3LD9205-0C 3LD9205-2C	1	5 units	103 0.098 103 0.180
 3LD9286-1A	Inscription labels With English/German inscription (MAIN SWITCH/HAUPTSCHALTER) Without inscription		3LD9286-1A 3LD9286-4A	1	10 units	103 0.002 103 0.005
 3LD9201-2A	Terminal covers as additional touch protection (also for distribution board mounting) Can be snapped on at top and bottom • 1-pole • 3-/4-pole		3LD9201-2A 3LD9201-1A	100	4 units	103 1.300 103 0.007

Switch Disconnectors

3LD Main Control and EMERGENCY-STOP Switches up to 250 A

Accessories

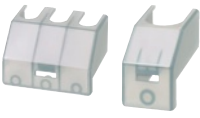
Version	DT	3LD21 and 3LD22	PU (UNIT, SET, M)	PS*/ P. unit	PG	Weight per PU approx.		
		Article No.	Price per PU			kg		
For front mounting								
 <p>3LD9220-0B (left) 3LD9220-2B (right)</p>		4th contact element (N conductor) Leading switch-on, lagging switch-off	▶	3LD9220-0B	1	1 unit	103	0.037
		N or PE terminals Through-type	▶	3LD9220-2B	1	1 unit	103	0.028
 <p>3LD9200-5B</p>		Auxiliary switches For mounting on the left and/or right, lagging switch-on, leading switch-off • 1 NO + 1 NC	▶	3LD9200-5B	1	1 unit	103	0.024
		For mounting on the left and/or right, lagging switch-on, leading switch-off, with gold-plated contacts for requesting electronic information • 1 NO + 1 NC	▶	3LD9200-5BF	1	1 unit	103	0.024
For floor mounting, distribution board mounting or molded-plastic enclosures								
 <p>3LD9220-0C</p>		4th contact element (N conductor) Leading switch-on, lagging switch-off	▶	3LD9220-0C	1	1 unit	103	0.036
		N or PE terminals Through-type	▶	3LD9220-2C	1	1 unit	103	0.038
 <p>3LD9200-5C (left) 3LD9200-6C (right)</p>		Auxiliary switches For mounting on the left and/or right, lagging switch-on, leading switch-off • 1 NO + 1 NC	▶	3LD9200-5C	1	1 unit	103	0.025
		• 2 NO	▶	3LD9200-6C	1	1 unit	103	0.026
		For mounting on the left and/or right, lagging switch-on, leading switch-off, with gold-plated contacts for requesting electronic information • 1 NO + 1 NC	▶	3LD9200-5CF	1	1 unit	103	0.020
For front and floor mounting								
 <p>3LD9224-1B</p>		Rotary operating mechanisms Lockable in 0 position with up to 3 padlocks • For four-hole mounting						
		- Black		3LD9224-1B	1	1 unit	103	0.075
		- Red/Yellow		3LD9224-3B	1	1 unit	103	0.075
	 <p>3LD9224-3D</p>		• For center-hole mounting, including seal and nut					
		- Black		3LD9224-1D	1	1 unit	103	0.076
	- Red/Yellow		3LD9224-3D	1	1 unit	103	0.078	
 <p>3LD9256-0A</p>		Mounting tools For center-hole mounting with nut		3LD9256-0A	1	5 units	103	0.011
		Switching shafts 6 x 6 mm Length 300 mm		3LD9205-0C	1	5 units	103	0.098
		Length 600 mm		3LD9205-2C	1	5 units	103	0.180
 <p>3LD9286-1A</p>		Inscription labels With English/German inscription (MAIN SWITCH/HAUPTSCHALTER)		3LD9286-1A	1	10 units	103	0.002
		Without inscription		3LD9286-4A	1	10 units	103	0.005
 <p>3LD9221-2A (left) 3LD9221-0A (right)</p>		Terminal covers as additional touch protection (also for distribution board mounting) Can be snapped on at top and bottom						
		• 1-pole		3LD9221-2A	100	4 units	103	0.300
	• 3-pole		3LD9221-0A	1	4 units	103	0.007	

* You can order this quantity or a multiple thereof.

Switch Disconnectors

3LD Main Control and EMERGENCY-STOP Switches up to 250 A









Accessories

Version	DT	3LD23 and 3LD24	PU (UNIT, SET, M)	PS*/ P. unit	PG	Weight per PU approx.
		Article No.	Price per PU			kg
For front mounting						
		4th contact element (N conductor) Leading switch-on, lagging switch-off	▶	3LD9240-0B	1	1 unit 103 0.499
		N or PE terminals Through-type	▶	3LD9240-2B	1	1 unit 103 0.446
		Auxiliary switches For mounting on the left and/or right, lagging switch-on, leading switch-off				
		• 1 NO + 1 NC	▶	3LD9200-5B	1	1 unit 103 0.024
		• For mounting on the left and/or right, lagging switch-on, leading switch-off, with gold-plated contacts for requesting electronic information				
		• 1 NO + 1 NC		3LD9200-5BF	1	1 unit 103 0.024
For floor and distribution board mounting						
		Shaft coupling No ON-lock		3LD9242-4F	1	5 units 103 0.036
		4th contact element (N conductor) Leading switch-on, lagging switch-off	▶	3LD9240-0C	1	1 unit 103 0.516
		N or PE terminals Through-type	▶	3LD9240-2C	1	1 unit 103 0.464
		Auxiliary switches For mounting on the left and/or right, lagging switch-on, leading switch-off				
		• 1 NO + 1 NC	▶	3LD9200-5C	1	1 unit 103 0.025
		• 2 NO	▶	3LD9200-6C	1	1 unit 103 0.026
		For mounting on the left and/or right, lagging switch-on, leading switch-off, with gold-plated contacts for requesting electronic information				
		• 1 NO + 1 NC		3LD9200-5CF	1	1 unit 103 0.020
For front and floor mounting						
		Knob-operated mechanism Lockable in 0 position with up to 3 padlocks				
		• For four-hole mounting, including seal				
		- Black		3LD9243-1B	1	1 unit 103 0.216
		- Red/Yellow		3LD9243-3B	1	1 unit 103 0.220
		Switching shafts 8 x 8 mm				
		Length 300 mm		3LD9245-0C	1	5 units 103 0.146
		Length 600 mm		3LD9245-2C	1	5 units 103 0.300
		Inscription labels With English/German inscription (MAIN SWITCH/HAUPTSCHALTER)		3LD9286-1A	1	10 units 103 0.002
		Without inscription		3LD9286-4A	1	10 units 103 0.005
		Terminal covers as additional touch protection (also for distribution board mounting) Can be snapped on at top and bottom				
		• 1-pole		3LD9241-2A	1	4 units 103 0.018

Switch Disconnectors

3LD Main Control and EMERGENCY-STOP Switches up to 250 A

Accessories







Version	DT	3LD25	PU (UNIT, SET, M)	PS*/ P. unit	PG	Weight per PU approx.
		Article No.	Price per PU			kg
For front mounting						
		4th contact element (N conductor) Leading switch-on, lagging switch-off	▶	3LD9250-0BA	1	1 unit 103 0.077
		N or PE terminals Through-type	▶	3LD9250-2BA	1	1 unit 103 0.070
		Auxiliary switches For mounting on the left and/or right, lagging switch-on, leading switch-off				
		• 1 NO + 1 NC	▶	3LD9200-5B	1	1 unit 103 0.024
		For mounting on the left and/or right, lagging switch-on, leading switch-off, with gold-plated contacts for requesting electronic information				
		• 1 NO + 1 NC	▶	3LD9200-5BF	1	1 unit 103 0.024
For floor mounting, distribution board mounting or molded-plastic enclosures						
		4th contact element (N conductor) Leading switch-on, lagging switch-off	▶	3LD9250-0CA	1	1 unit 103 0.077
		N or PE terminals Through-type	▶	3LD9250-2CA	1	1 unit 103 0.063
		Auxiliary switches For mounting on the left and/or right, lagging switch-on, leading switch-off				
		• 1 NO + 1 NC	▶	3LD9200-5C	1	1 unit 103 0.025
		• 2 NO	▶	3LD9200-6C	1	1 unit 103 0.026
		For mounting on the left and/or right, lagging switch-on, leading switch-off, with gold-plated contacts for requesting electronic information				
		• 1 NO + 1 NC	▶	3LD9200-5CF	1	1 unit 103 0.020
For front and floor mounting						
		Rotary operating mechanisms Lockable in 0 position with up to 3 padlocks				
		• For four-hole mounting, including seal				
		- Black		3LD9284-1B	1	1 unit 103 0.146
		- Red/Yellow		3LD9284-3B	1	1 unit 103 0.150
		• For center-hole mounting, including seal and nut				
		- Black		3LD9284-1D	1	1 unit 103 0.152
		- Red/Yellow		3LD9284-3D	1	1 unit 103 0.155
		Mounting tools For center-hole mounting with nut		3LD9256-0A	1	5 units 103 0.011
		Switching shafts 6 x 6 mm				
		Length 300 mm		3LD9205-0C	1	5 units 103 0.098
		Length 600 mm		3LD9205-2C	1	5 units 103 0.180
		Inscription labels With English/German inscription (MAIN SWITCH/HAUPTSCHALTER)		3LD9286-1A	1	10 units 103 0.002
		Without inscription		3LD9286-4A	1	10 units 103 0.005
		Terminal covers as additional touch protection (also for distribution board mounting) Can be snapped on at top and bottom				
		• 1-pole		3LD9251-2A	100	4 units 103 0.500
		• 3-pole		3LD9251-0A	1	4 units 103 0.008

* You can order this quantity or a multiple thereof.

Switch Disconnectors

3LD Main Control and EMERGENCY-STOP Switches up to 250 A

Accessories

Version	DT	3LD27 and 3LD28	PU (UNIT, SET, M)	PS*/ P. unit	PG	Weight per PU approx.
		Article No.	Price per PU			kg
For front mounting						
		4th contact element (N conductor) Leading switch-on, lagging switch-off	▶	3LD9280-0B	1	1 unit 103 0.099
		N or PE terminals Through-type	▶	3LD9280-2B	1	1 unit 103 0.082
3LD9280-0B (left) 3LD9280-2B (right)		Auxiliary switches For mounting on the left and/or right, lagging switch-on, leading switch-off				
		• 1 NO + 1 NC	▶	3LD9200-5B	1	1 unit 103 0.024
3LD9200-5B		For mounting on the left and/or right, lagging switch-on, leading switch-off, with gold-plated contacts for requesting electronic information				
		• 1 NO + 1 NC		3LD9200-5BF	1	1 unit 103 0.024
For floor mounting, distribution board mounting or molded-plastic enclosures						
		4th contact element (N conductor) Leading switch-on, lagging switch-off	▶	3LD9280-0C	1	1 unit 103 0.099
		N or PE terminals Through-type	▶	3LD9280-2C	1	1 unit 103 0.081
3LD9280-0C (left) 3LD9280-2C (right)		Auxiliary switches For mounting on the left and/or right, lagging switch-on, leading switch-off				
		• 1 NO + 1 NC	▶	3LD9200-5C	1	1 unit 103 0.025
		• 2 NO	▶	3LD9200-6C	1	1 unit 103 0.026
3LD9200-5C (left) 3LD9200-6C (right)		For mounting on the left and/or right, lagging switch-on, leading switch-off, with gold-plated contacts for requesting electronic information				
		• 1 NO + 1 NC		3LD9200-5CF	1	1 unit 103 0.020
For front and floor mounting						
		Rotary operating mechanisms for four-hole mounting Lockable in 0 position with up to 3 padlocks, including seal				
3LD9284-1B		• Black		3LD9284-1B	1	1 unit 103 0.146
		• Red/Yellow		3LD9284-3B	1	1 unit 103 0.150
		Switching shafts 6 x 6 mm Length 300 mm		3LD9205-0C	1	5 units 103 0.098
		Length 600 mm		3LD9205-2C	1	5 units 103 0.180
		Inscription labels With English/German inscription (MAIN SWITCH/HAUPTSCHALTER)		3LD9286-1A	1	10 units 103 0.002
3LD9286-1A		Without inscription		3LD9286-4A	1	10 units 103 0.005
		Terminal covers as additional touch protection (also for distribution board mounting) Can be snapped on at top and bottom				
3LD9281-2A		• 1-pole (1 pack = 4 units)		3LD9281-2A	1	4 units 103 0.007

Switch Disconnectors

5TE1 Switch Disconnectors up to 200 A

Introduction

Overview

The 5TE1 switch disconnectors are available from 100 A to 200 A in 3 and 4-pole versions and can be used as main control switches, repair switches, outgoing feeder switches and emergency mains switching off device.

The series corresponds to the requirements of IEC/EN 60947-3 and its key features are its compact and robust design, high short-circuit strength, high DC breaking capacity and comprehensive accessories.

Its small footprint means it is easy to install in all types of enclosures, distribution boards and control cabinets.

The devices are approved to UL 508 and KEMA certified.

Benefits

- Transparent enclosures ensure that the contact position is always visible
- Contacts with double breaks ensure reliable insulation characteristics
- Can be locked in the OFF position to allow for maintenance work.
- With a red knob and yellow cap, it can also be used as an emergency switching off device.

Technical specifications



				5TE1.1	5TE1.2	5TE1.3	5TE1.4
Standards				IEC/EN 60947-3, UL 508			
Approvals				UL508 for the following types: 5TE1320, 5TE1330, 5TE1340, 5TE1420, 5TE1430 and 5TE1440. UL File No. E302554			
Rated operational current I_e With utilization category AC-21A	Per conduct. path	At $U_e =$	400 V A 415 V A 500 V A 690 V A	100 100 100 100	125 125 125 125	160 160 160 160	200 200 200 200
Rated operational current I_e With utilization category AC-22A	Per conduct. path	At $U_e =$	400 V A 415 V A 500 V A 690 V A	100 100 100 63	125 125 100 63	160 160 160 160	200 200 200 200
Rated operational current I_e With utilization category AC-23A	Per conduct. path	At $U_e =$	400 V A 415 V A 500 V A 690 V A	80 80 50 40		125 125 125 63	160 160 125 80
Rated operational current I_e With utilization category DC-23A	2 poles in series 2 poles in series 4 poles in series	110 V A 220 V A 220 V A	A A A	100 -- 100		160 100 160	
Rated operational voltage U_e			V AC	According to UL: 480, acc. to IEC: 690			
Rated insulation voltage U_i			V AC	690			
Rated impulse withstand voltage U_{imp}	2000 m		kV	8			
Impulse test voltage	At sea level		kV	12.3			
Max. rated operational power With utilization category AC-23A		At $U_e =$	400 V kW 415 V kW 500 V kW 690 V kW	44 46 35 36		69 72 86 60	88 92 86 76
Rated thermal current I_{th}	At 40 °C, 50 °C and 60 °C		A	100	125	160	200
Rated making capacity	At 415 V AC-23A		A	1875		3200	4000
Rated breaking capacity	At 415 V AC-23A		A	1000		1920	2400
Rated ultimate short-circuit breaking capacity I_{cm}	Per conduct. path	At $U_e =$	400 V kA 415 V kA 500 V kA 690 V kA	10 10 6.7 6.7			
Rated short-time withstand current I_{cw} (peak value)	Per conduct. path	0.25 s 1 s	kA kA	5 2.5		6 3	
Rated conditional short-circuit current With back-up protection with back-up fuse With identical rated current		At $U_e =$	400 V kA 415 V kA 500 V kA 690 V kA	50 50 50 33	33	20	18
Capacitive load	At 400 V		kVar	50	60	77	97
Number of poles				2/3/4			
Rated power dissipation P_v	Per pole		VA	2.9	4.5	6.5	10
Frequency			Hz	50/60			
Conductor cross-sections • Solid and stranded • AWG cables • Copper busbars			mm ² AWG mm ²	6 ... 50 10 ... 1/0 --		-- 8 max. 20 × 6	
Endurance	Electrical Mechanical		Switching cycles	1500 20000		1000 10000	
Acc. to UL 508							
UL 508 General Use 480 V	I_n		A	--	80	100	125
UL 508 Manual motor controller 230 V	FLA (Full load amperes)		A	--	28	34	40
UL 508 Manual motor controller 480 V	Power		hp	--	10	25	30
UL 508 short-circuit at 480 V	Power		hp	--	20	15	15
	With Class H or K5 fuses		kA	--	10		
	With J fuses		kA	--	50		

Switch Disconnectors

5TE1 Switch Disconnectors up to 200 A

General data

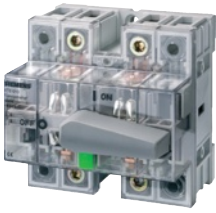
Selection and ordering data







Version	I_e A AC	U_e V AC	Mount- ing width MW	DT	Article No.	Price per PU	PU (UNIT, SET, M)	PS*/ P. unit	PG	Weight per PU approx. kg
 <p>Switch disconnectors, lockable, with gray knob and transparent enclosure, mounting depth 92 mm</p>										
2 NO	100	690	5		5TE1210		1	1 unit	029	0.485
	125				5TE1220		1	1 unit	029	0.492
	160		8		5TE1230		1	1 unit	029	0.646
	200				5TE1240		1	1 unit	029	0.655
3 NO	100	690	5		5TE1310		1	1 unit	029	0.533
	125				5TE1320		1	1 unit	029	0.541
	160		8		5TE1330		1	1 unit	029	0.694
	200				5TE1340		1	1 unit	029	0.697
4 NO	100	690	5		5TE1410		1	1 unit	029	0.602
	125				5TE1420		1	1 unit	029	0.591
	160		8		5TE1430		1	1 unit	029	0.774
	200				5TE1440		1	1 unit	029	0.794
3 NO with N-conductor through-type terminal	100	690	5		5TE1610		1	1 unit	029	0.592
	125				5TE1620		1	1 unit	029	0.606
	160		8		5TE1630		1	1 unit	029	0.791
	200				5TE1640		1	1 unit	029	0.789
 <p>Switch disconnectors with red knob and yellow cap, can be used as emergency mains switching off device acc. to IEC 60204-1, EN 60204-1 (VDE 0113-1) if switch is easily accessible, mounting depth 92 mm</p>										
3 NO	100	690	5		5TE1315		1	1 unit	029	0.545
	125				5TE1325		1	1 unit	029	0.550
	160		8		5TE1335		1	1 unit	029	0.693
	200				5TE1345		1	1 unit	029	0.722
4 NO	100	690	5		5TE1415		1	1 unit	029	0.596
	125				5TE1425		1	1 unit	029	0.609
	160		8		5TE1435		1	1 unit	029	0.803
	200				5TE1445		1	1 unit	029	0.806

Switch Disconnectors

5TE1 Switch Disconnectors up to 200 A

General data

Accessories

	Version	I_e	U_e	DT	Article No.	Price per PU	PU (UNIT, SET, M)	PS*/P. unit	PG	Weight per PU approx.
		A AC	V AC							kg
	Terminal covers Sealable									
	For 100 A and 125 A switch disconnectors				5TE9000		1	1 unit	029	0.043
	For 160 A and 200 A switch disconnectors				5TE9001		1	1 unit	029	0.037
	Cage terminals									
	For 160 A and 200 A switch disconnectors, 14,5 mm terminal diameter for 35 mm ² cables, hexagonal socket head screw 5 mm									
	1 set = 3 units				5TE9003		1	1 set	029	0.245
	1 set = 4 units				5TE9004		1	1 set	029	0.323
	Auxiliary switches									
	Can be mounted optionally left or right or both sides (2 units); minimum contact load 24 V, 50 mA									
	1 CO	6	230		5TE9005		1	1 unit	029	0.042
	2 CO	6	230		5TE9006		1	1 unit	029	0.048
	Locking units									
	For up to three padlocks with max. Ø 8 mm				5TE9014		1	1 unit	029	0.017
	Conversion kits, 4-pole, for 100 A and 125 A for the connection of busbars or cables with cable lugs									
	For busbars max 15 mm wide including terminal cover				5TE9015		1	1 set	029	0.078
	Rotary actuators with extension shafts for mounting on hinged doors or enclosure lids, lockable, IP65									
	Black knob									
	Shaft length 200 mm				5TE9010		1	1 unit	029	0.177
	Shaft length 400 mm				5TE9011		1	1 unit	029	0.234
Red knob										
Shaft length 200 mm				5TE9012		1	1 unit	029	0.175	
Shaft length 400 mm				5TE9013		1	1 unit	029	0.234	

Switch Disconnectors

5TE1 Switch Disconnectors up to 200 A

General data

Dimensional drawings

5TE1 switch disconnectors, 100 A and 125 A

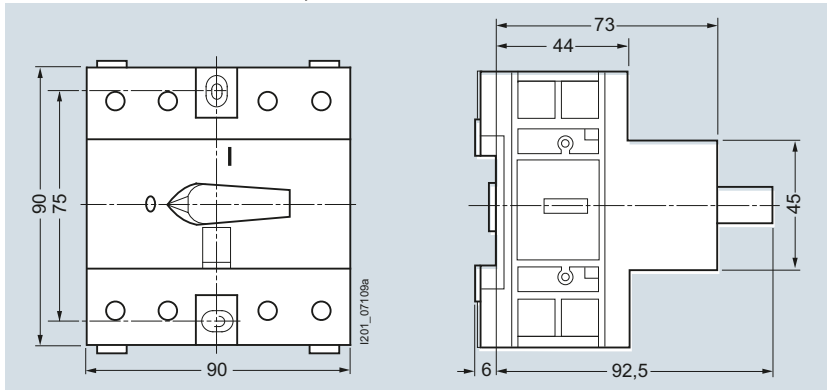

- | | | | |
|---------|---------|---------|---------|
| 5TE1210 | 5TE1310 | 5TE1410 | 5TE1610 |
| 5TE1220 | 5TE1315 | 5TE1415 | 5TE1620 |
| | 5TE1320 | 5TE1420 | |
| | 5TE1325 | 5TE1425 | |

5TE9 auxiliary switches

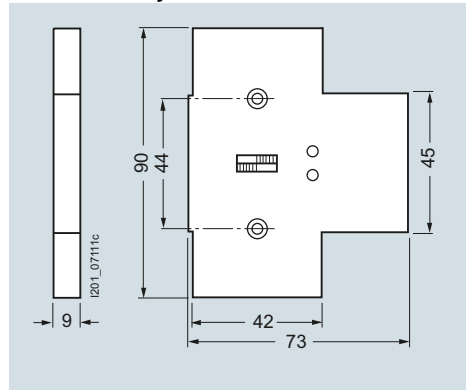

- 5TE9005
5TE9006

5TE1 switch disconnectors, 160 A and 200 A

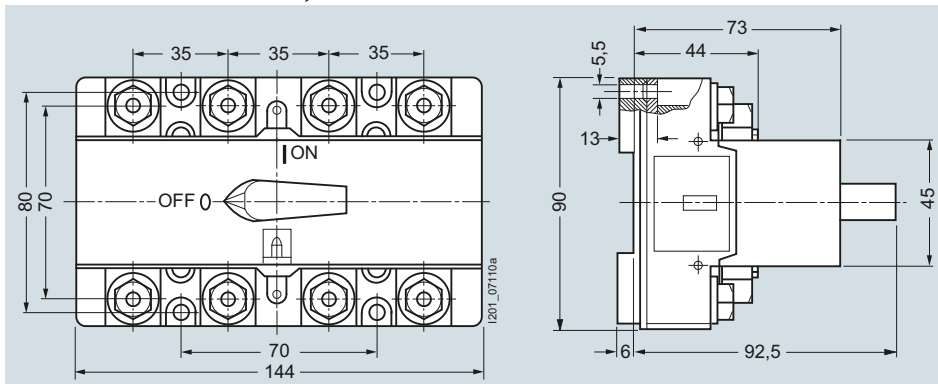

- | | | | |
|---------|---------|---------|---------|
| 5TE1230 | 5TE1330 | 5TE1430 | 5TE1630 |
| 5TE1240 | 5TE1335 | 5TE1435 | 5TE1640 |
| | 5TE1340 | 5TE1440 | |
| | 5TE1345 | 5TE1445 | |

5TE9014 locking units

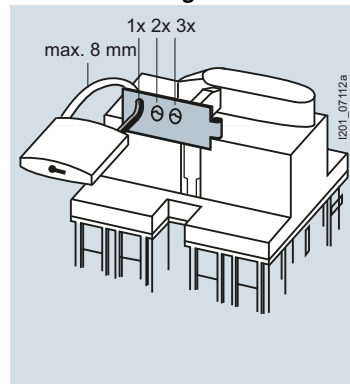

5TE9 rotary actuators with extension shaft

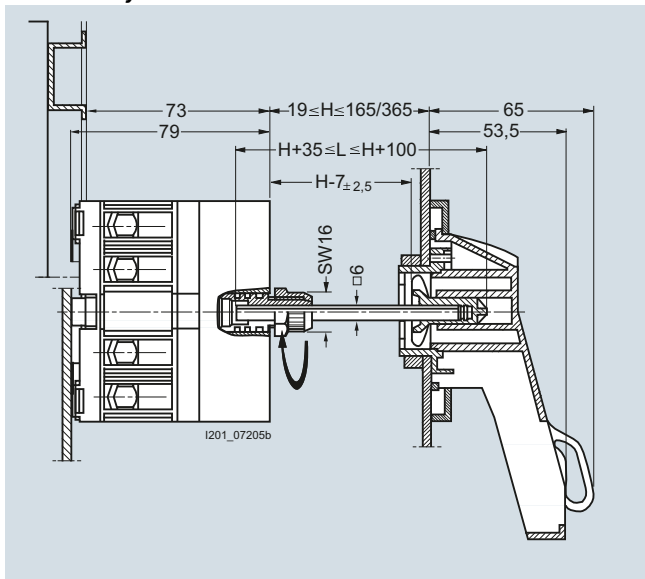

- With switch disconnectors 100 A and 125 A
5TE9010, 5TE9011,
5TE9012, 5TE9013

It is possible to open the door in a disconnected state.

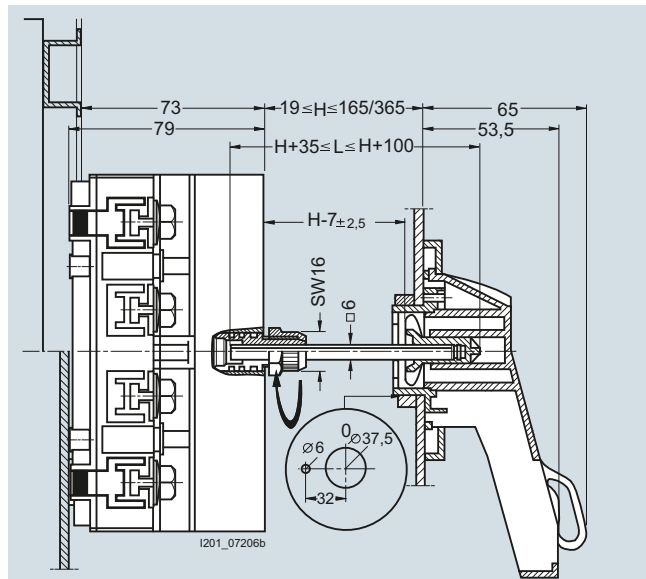

- With switch disconnectors 160 A and 200 A
5TE9010, 5TE9011,
5TE9012, 5TE9013

It is possible to open the door in a disconnected state.

Switch Disconnectors

5TE1 Switch Disconnectors up to 200 A

General data

Circuit diagrams

Graphical symbols



5TE1210
5TE1220
5TE1230
5TE1240



5TE1310
5TE1320
5TE1330
5TE1340



5TE1410
5TE1420
5TE1430
5TE1440



5TE1610
5TE1620
5TE1630
5TE1640



5TE1315
5TE1325
5TE1335
5TE1345



5TE1415
5TE1425
5TE1435
5TE1445

5TE9 auxiliary switches



5TE9005



5TE9006

More information

Connection of 5TE1.3 and 5TE1.4 switches, 160 and 200 A

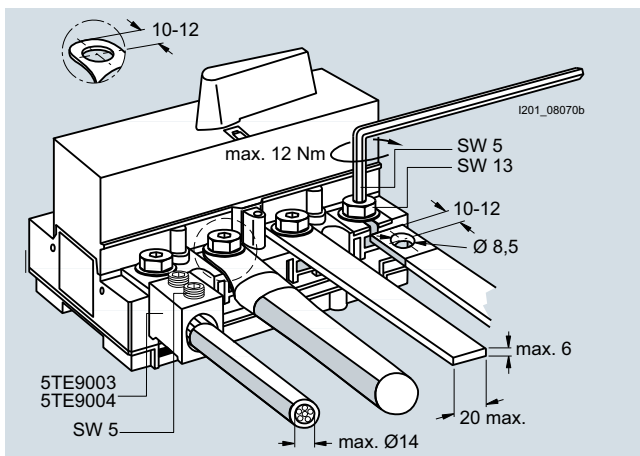

Design

- From 160 A: supplied with one terminal cover
- 160 A and 200 A: version for connection with cable lug
- Screw fixing on base plate
- Installation on standard mounting rail to EN 60715, which is raised at least 5 mm from the base plate.

Switch Disconnectors

3KA, 3KE Switch Disconnectors up to 1000 A

Introduction

Overview

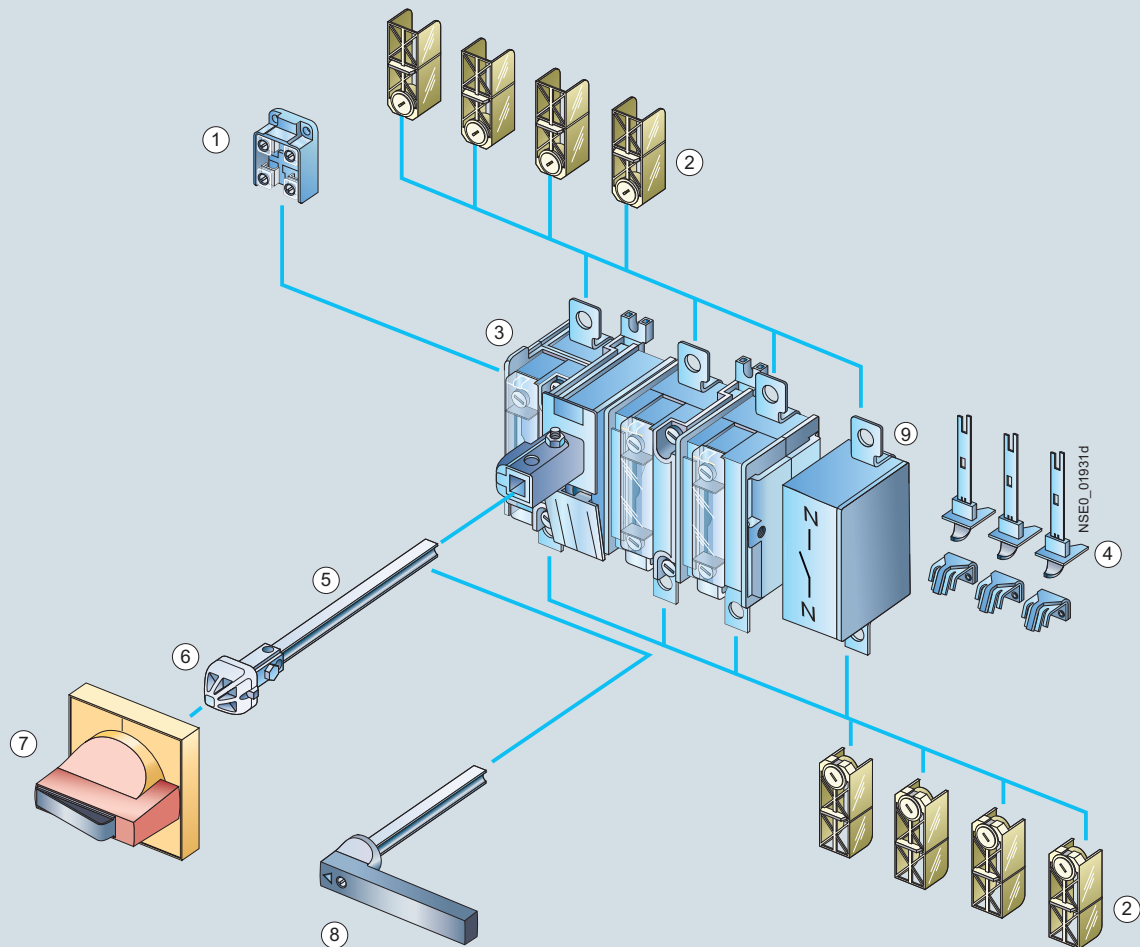

- ① Auxiliary switch (3SB for 3KA; 3KX for 3KE)
- ② IP20 terminal cover (Operator side)
- ③ 3K switch disconnector
- ④ Arcing contacts (only for 3KE)
- ⑤ Extension shaft
- ⑥ Coupling driver
- ⑦ 8UC7 door-coupling rotary operating mechanism in standard version (ti-grey) or EMERGENCY-STOP version (red/yellow).

- ⑧ 8UC9 handle for fixed mounting in standard version (black) or EMERGENCY-STOP version (red).
- ⑨ 4th pole (optional, only for 3KA)

All components from the switch to the actuator are provided with non-interchangeability features.

For the 3KA switch disconnectors, complete kits for standard and EMERGENCY-STOP application are available for installation in the side and rear panels of control cabinets.

A changeover operating mechanism is available for the use of two switch disconnectors of the 3KE series as load changeover switches.

A switch coupling permits simultaneous switching of two 3KE switch disconnectors with identical or different rated operational currents.

Identical accessories for 3KA switch disconnectors and for 3KL and 3KM switch disconnectors with fuses simplify stock keeping.

Application

3KA and 3KE switch disconnectors are used as main control, EMERGENCY-STOP, maintenance and transfer switches in distribution boards for residential and non-residential buildings as well as industrial switchgear. As three and four-pole versions, they ensure making and breaking of the specified rated current under load. At the same time, they constitute a safety isolating function and isolating distance in all low-voltage circuits.

All 3K switch disconnectors are climate-proof and meet the requirements of IEC 60947-1, IEC 60947-3 and VDE 0660 Part 107. Switch disconnectors in the type-tested 8HP molded-plastic distribution board enclosure (degree of protection IP65) are available for use as safety switches.

Additional data, see chapter 17 "Distribution Boards" and chapter 19 "8WH2 Spring-Loaded Terminals".

Switch Disconnectors

3KA, 3KE Switch Disconnectors up to 1000 A

Introduction

Technical specifications

Standards		IEC 60947-1, IEC 60947-3, VDE 0660 Part 107						
Type		3KA50	3KA51	3KA52 ¹⁾	3KA53 ¹⁾	3KA55 ¹⁾	3KA57 ¹⁾	3KA58 ¹⁾
Rated uninterrupted current I_u	A	63	80	125	160	250	400	630 ³⁾
Conventional free-air thermal current I_{th}²⁾	A	63	80	125	160	250	400	630 ³⁾
Rated insulation voltage U_i	V	690	690	1000	1000	1000	1000	1000
Rated impulse withstand voltage U_{imp}	kV	6	6	8	8	8	8	8
Rated operational voltage U_e								
50/60 Hz AC	V	690						
DC	V	440 (3 conducting paths series-connected)						
	V	220 (2 conducting paths series-connected)						
	V	110 (1 conducting path)						
Rated short-circuit making capacity I_{cm} with upstream fuses⁴⁾	kA	220	220	220	220	176	176	105
At 50/60 Hz 690 V AC, peak value								
Rated conditional short-circuit current with upstream fuses⁴⁾	kA	100	100	100	100	80	80	50
At 50/60 Hz 690 V AC, rms value								
Max. rated current I_n of the fuses	A	63	80	160	160	400	400	630
Permissible let-through current of the fuses	kA	8	10	17	17	30 ⁵⁾	30 ⁵⁾	40 ⁵⁾
Maximum permissible let-through I^2t value	kA ² s	55	55	223	223	1000	1000	2600
Permissible let-through current of an upstream circuit breaker	kA	7	8	8	15	25	25	32
At 50/60 Hz 690 V AC, peak value								
Rated short-circuit making capacity without fuses	kA	7	7	7	9	20	25	35
At AC 50 Hz/60 Hz 690 V, peak value								
Breaking capacity (infeed from the top or bottom)								
At 400 V AC								
• Breaking current I_c (at p.f. = 0.35, rms value)	A	500	650	1000	1280	2000	3200	5040
• Rated operational current I_e at								
- AC-21A, AC-22A, AC-23A	A	63	80	125	160	250	400	630 ⁶⁾
• Motor switching capacity AC-23A	kW	30	40	65	80	132	200	350
At 500 V AC								
• Breaking current I_c (at p.f. = 0.35, rms value)	A	500	640	1000	1280	2000	3200	3200
• Rated operational current I_e at								
- AC-21A, AC-22A	A	63	80	125	160	250	400	630
- AC-23A	A	63	80	125	160	250	400	400
• Motor switching capacity AC-23A	kW	40	50	90	110	185	280	280
At 690 V AC								
• Breaking current I_c (at p.f. = 0.35, rms value)	A	500	500	1000	1280	2000	3200	3200
• Rated operational current I_e at								
- AC-21A, AC-22A	A	63	80	125	160	250	400	630
- AC-23A	A	63	63	125	160	250	400	400
• Motor switching capacity AC-23A	kW	50	50	110	150	220	375	375
At 440 V DC (3 conducting paths series-connected) ⁷⁾								
• Breaking current I_c ($L/R = 15$ ms)	A	250	260	500	640	1000 ⁸⁾	1600	1600
• Rated operational current I_e at DC-23A	A	63	63	125	160	250 ⁹⁾	400	400
Rated short-time current I_{cw}	kA	2.5	2.5	3.2	3.2	8	11	15
(1 s current, rms value)								
Permissible ambient temperature	°C	-25 ... +55 for operation ³⁾						
	°C	-50 ... +80 when stored						
Mechanical endurance, operating cycles		15 000	15 000	15 000	15 000	12 000	12 000	12 000
Degree of protection		IP00/IP20 (from the operator side, with busbar and terminal covers)						
Power loss of the switch disconnector at I_{th}	W	7	12	22	22	33	72	170
Main conductor connections								
Busbar systems, max. dimensions (W x T)	mm	25 x 9	25 x 9	45 x 10	45 x 10	40 x 12	40 x 12	40 x 15
Cable lug, max. conductor cross-section (stranded)	mm ²	35	35	70	120	150	2 x 150 or 1 x 240	2 x 240
Tightening torque	Nm	6 ... 7.5	6 ... 7.5	7 ... 10	18 ... 22	35 ... 45	35 ... 45	35 ... 45
Terminal screws		M6	M6	M6	M8	M10	M10	M10
Protective conductor connections								
Flat bars	mm	--	--	--	--	20 x 2.5	20 x 2.5	20 x 2.5
Cable lug, max. conductor cross-section (stranded)	mm ²	--	--	--	--	70	120	120

1) Technical specifications for approval on request.

2) Configuring note: Max. permissible operating temperature at connections 100 °C.

3) With 3KA58 for operation -25 °C ... +35 °C, 570 A at 55 °C.

4) Only available with 3NA38, 3NA32 or 3ND18, 3ND12 fuses (otherwise only 105 kA/50 kA).

5) 3ND1 switchgear protection fuse.

6) AC-23B.

7) 220 V DC (L1 and L3 series-connected) or 110 V DC (one conducting path) at DC-23A.

8) At 440 V $L/R = 4$ ms, at 220 V $L/R = 15$ ms.

9) At 440 V DC-22A, at 220 V DC-23A.

Switch Disconnectors

3KA, 3KE Switch Disconnectors up to 1000 A

Introduction

Standards		IEC 60947-1, IEC 60947-3, VDE 0660 Part 107			
Type		3KE42	3KE43	3KE44	3KE45
Rated uninterrupted current I_U	A	250	400	630	1000
Rated insulation voltage U_i	V	1000 AC, 1200 DC			
Rated impulse withstand voltage U_{imp}	kV	8	8	8	8
Rated operational voltage U_e					
50/60 Hz AC	V	690			
DC	V	440 (3 conducting paths series-connected)			
	V	220 (2 conducting paths series-connected)			
Rated short-circuit making capacity I_{cm}	kA	35	35	60	60
At 50/60 Hz 690 V AC, peak value					
Rated short-circuit making capacity with upstream fuses	kA	105	105	105	84
At 50/60 Hz 690 V AC, peak value					
Rated conditional short-circuit current with upstream fuses	A	50	50	50	40
At 50/60 Hz 690 V AC (rms value)					
Maximum permissible let-through I^2t value	kA ² s	2150	2150	5400	19000
Permissible let-through current of an upstream circuit breaker					
At 50/60 Hz 690 V AC, peak value	kA	35	35	60	60
Max. rated current I_n of the fuse	A	400	400	630	1000
Permissible let-through current of the fuses (peak value)	kA	38	38	60	75
Breaking capacity (infeed from the top or bottom)					
At 400 V AC					
• Breaking current I_c (at p.f. = 0.35, rms value)	A	1000	1000	2520	2520
• Rated operational current I_e at					
- AC-21A	A	250	400	630	1000
- AC-22A	A	250	330	630	800
- AC-23A	A	125	125	315	315
At 500 V AC					
• Breaking current I_c (at p.f. = 0.35, rms value)	A	1000	1000	2520	2520
• Rated operational current I_e at					
- AC-21A	A	250	400	630	1000
- AC-22A	A	250	330	630	800
- AC-23A	A	125	125	315	315
At 690 V AC					
• Breaking current I_c (at p.f. = 0.35, rms value)	A	1000	1000	2520	2520
• Rated operational current I_e at					
- AC-21A	A	250	400	630	1000
- AC-22A	A	250	330	630	800
- AC-23A	A	125	125	315	315
At 440 V DC (3 conducting paths series-connected)					
• Breaking current I_c ($L/R = 5$ ms)	A	1000	1000	2520	2520
• Rated operational current I_e at					
- DC-21A	A	250	400	630	1000
- DC-22A	A	250	250	630	630
Rated short-time current I_{cw}	kA	12.5	12.5	21	21
(1 s current, rms value)					
Permissible ambient temperature	°C	-25 ... +55 for operation			
	°C	-50 ... +80 when stored			
Mechanical endurance, operating cycles		10 000			
Degree of protection		IP00			
Power loss of the switch disconnector at I_{th}	W	15	33	78	180
Main conductor connections					
Busbar systems, max. dimensions (W x T)	mm	25 x 10	25 x 10	2 x 40 x 10	2 x 40 x 10
Cable lug, max. conductor cross-section (stranded)	mm ²	2 x 150	2 x 150, 1 x 240	2 x 240	2 x 240

Switch Disconnectors

3KA, 3KE Switch Disconnectors up to 1000 A

Floor mounting

Application

3KA switch disconnectors are implemented as main control switches and EMERGENCY-STOP switches for normal switching duty and isolation of main circuits and auxiliary circuits. Another field of application is the switching of induction motors and other loads in the event of maintenance and repair.

Main control and EMERGENCY-STOP switches are manually operated switch disconnectors according to IEC 60947-3 and VDE 0660 Part 107 (EN 60947-3) and comply with the conditions for switch disconnectors and the requirements of the machinery directive EN 60204-1.

Selection and ordering data

All switch disconnectors with degree of protection IP00

Conductor connecting screws are generally included in the scope of supply

Rated uninterrupted current I_u A	DT	Article No.	Price per PU	PU (UNIT, SET, M)	PS*	PG	Weight per PU approx. kg
Complete versions with 8UC7 door-coupling rotary operating mechanism (black handle)							
3-pole for motor loads and for power distribution							
63		3KA5030-1GE01		1	1 unit	103	1.372
80		3KA5130-1GE01		1	1 unit	103	1.365
125		3KA5230-1GE01		1	1 unit	103	2.217
160		3KA5330-1GE01		1	1 unit	103	2.398
250		3KA5530-1GE01		1	1 unit	103	5.387
400		3KA5730-1GE01		1	1 unit	103	10.284
630		3KA5830-1GE01		1	1 unit	103	6.065
4-pole¹⁾ for power distribution							
63		3KA5040-1GE01		1	1 unit	103	2.449
80		3KA5140-1GE01		1	1 unit	103	2.474
125		3KA5240-1GE01		1	1 unit	103	2.455
160		3KA5340-1GE01		1	1 unit	103	0.002
250		3KA5540-1GE01		1	1 unit	103	5.979
400		3KA5740-1GE01		1	1 unit	103	10.824
630		3KA5840-1GE01		1	1 unit	103	6.570
Basic switch versions without handle							
3-pole for motor loads and for power distribution							
63		3KA5030-1AE01		1	1 unit	103	0.905
80		3KA5130-1AE01		1	1 unit	103	0.903
125		3KA5230-1AE01		1	1 unit	103	1.874
160		3KA5330-1AE01		1	1 unit	103	1.997
250		3KA5530-1AE01		1	1 unit	103	4.450
400		3KA5730-1AE01		1	1 unit	103	4.582
630		3KA5830-1AE01		1	1 unit	103	5.096
4-pole¹⁾ for power distribution							
63		3KA5040-1AE01		1	1 unit	103	2.080
80		3KA5140-1AE01		1	1 unit	103	2.113
125		3KA5240-1AE01		1	1 unit	103	2.105
160		3KA5340-1AE01		1	1 unit	103	2.220
250		3KA5540-1AE01		1	1 unit	103	4.970
400		3KA5740-1AE01		1	1 unit	103	5.120
630		3KA5840-1AE01		1	1 unit	103	5.641
8UC7 EMERGENCY-STOP door-coupling rotary operating mechanisms (red handle, yellow indicator plate) for basic switch versions w/o handle							
3-pole for motor loads and for power distribution							
63		8UC7121-3BB10		1	1 unit	103	0.368
80		8UC7121-3BB10		1	1 unit	103	0.368
125		8UC7222-3BB20		1	1 unit	103	0.423
160		8UC7222-3BB20		1	1 unit	103	0.423
250		8UC7323-3BB30		1	1 unit	103	1.016
400		8UC7323-3BB30		1	1 unit	103	1.016
630		8UC7323-3BB30		1	1 unit	103	1.016
4-pole¹⁾ for power distribution							
63		8UC7222-3BB20		1	1 unit	103	0.423
80		8UC7222-3BB20		1	1 unit	103	0.423
125		8UC7222-3BB20		1	1 unit	103	0.423
160		8UC7222-3BB20		1	1 unit	103	0.423
250		8UC7323-3BB30		1	1 unit	103	1.016
400		8UC7323-3BB30		1	1 unit	103	1.016
630		8UC7323-3BB30		1	1 unit	103	1.016



3KA5330-1AE01

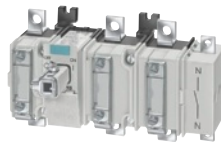

3KA5340-1AE01



8UC7121-3BB10

¹⁾ Rated values reduced in the event of strong harmonics caused by frequency converter operation.

For 8UC7 EMERGENCY-STOP door-coupling rotary operating mechanisms (red handle, yellow indicator plate), see [Accessories](#).

Switch Disconnectors

3KA, 3KE Switch Disconnectors up to 1000 A

Floor mounting

Rated uninterrupted current I_u	DT	3-pole, assembly kits for mounting in control cabinet side panels Assembly kits (front IP40) Comprising: Lockable handle and three terminal covers for the infeed side	PU (UNIT, SET, M)	PS*/ P. unit	PG	Weight per PU approx.	
A		Article No.	Price per PU			kg	
Black handle							
 <p>3KA5330-1AE01 with 3KX3536-2AA</p>	63	3KX3516-2AA	1	1 unit	103	0.580	
	80	3KX3516-2AA	1	1 unit	103	0.580	
	125	3KX3536-2AA	1	1 unit	103	0.828	
	160	3KX3536-2AA	1	1 unit	103	0.828	
	250	3KX3556-2AA	1	1 unit	103	1.567	
	400	3KX3556-2AA	1	1 unit	103	1.567	
	630	3KX3556-2AA	1	1 unit	103	1.567	
	EMERGENCY-STOP red handle						
	63	3KX3516-2BA	1	1 unit	103	0.587	
	80	3KX3516-2BA	1	1 unit	103	0.587	
125	3KX3536-2BA	1	1 unit	103	0.840		
160	3KX3536-2BA	1	1 unit	103	0.840		
250	3KX3556-2BA	1	1 unit	103	1.500		
400	3KX3556-2BA	1	1 unit	103	1.500		
630	3KX3556-2BA	1	1 unit	103	1.500		

7

Switch Disconnectors

3KA, 3KE Switch Disconnectors up to 1000 A

Floor mounting
All switch disconnectors with degree of protection IP00
With high speed closing and opening
Conductor connecting screws are generally included in the scope of supply

Rated uninterrupted current I_U	DT	3-pole, operating mechanism and actuation from the front Direct operating mechanisms	PU (UNIT, SET, M)	PS*/ P. unit	PG	Weight per PU approx.
A		Article No.	Price per PU			kg
Complete versions with black handle						
250		3KE4230-0BA	1	1 unit	103	3.828
400		3KE4330-0BA	1	1 unit	103	4.157
630		3KE4430-0BA	1	1 unit	103	7.252
1000		3KE4530-0BA	1	1 unit	103	7.764
Basic switch versions without handle						
250		3KE4230-0AA	1	1 unit	103	3.886
400		3KE4330-0AA	1	1 unit	103	3.810
630		3KE4430-0AA	1	1 unit	103	6.876
1000		3KE4530-0AA	1	1 unit	103	7.430
EMERGENCY-STOP red handles + coupling sockets for basic switch versions without handle						
250		8UC9371 + 3KX2210-0H	1	1 unit	103	0.142
			1	1 unit	103	0.203
400		8UC9371 + 3KX2210-0H	1	1 unit	103	0.142
			1	1 unit	103	0.203
630		8UC9375 + 3KX2210-0H	1	1 unit	103	0.160
			1	1 unit	103	0.203
1000		8UC9375 + 3KX2210-0H	1	1 unit	103	0.160
			1	1 unit	103	0.203

Rated uninterrupted current I_U	DT	3-pole, operating mechanism and actuation from the front Door-coupling rotary operating mechanisms (lockable)	PU (UNIT, SET, M)	PS*/ P. unit	PG	Weight per PU approx.
A		Article No.	Price per PU			kg
Complete versions with 8UC7 door-coupling rotary operating mechanism (black handle)						
250		3KE4230-0GA	1	1 unit	103	4.983
400		3KE4330-0GA	1	1 unit	103	5.046
630		3KE4430-0GA	1	1 unit	103	7.740
1000		3KE4530-0GA	1	1 unit	103	8.267
Basic switch versions without handle						
250		3KE4230-0AA	1	1 unit	103	3.886
400		3KE4330-0AA	1	1 unit	103	3.810
630		3KE4430-0AA	1	1 unit	103	6.876
1000		3KE4530-0AA	1	1 unit	103	7.430
8UC7 EMERGENCY-STOP door-coupling rotary operating mechanisms (red handle, yellow indicator plate) for basic switch versions without handle						
250, 400, 630, 1000		8UC7324-3BB44	1	1 unit	103	1.186

Switch Disconnectors

3KA, 3KE Switch Disconnectors up to 1000 A

Floor mounting

Rated uninterrupted current I_u	DT	3-pole, rear operating mechanism and actuation	PU (UNIT, SET, M)	PS*/P. unit	PG	Weight per PU approx.
A		Article No.	Price per PU			kg
Basic switch versions without handle						
Direct operating mechanisms						
250		3KE4230-0CA	1	1 unit	103	4.964
400		3KE4330-0CA	1	1 unit	103	4.946
630		3KE4430-0CA	1	1 unit	103	7.377
1000		3KE4530-0CA	1	1 unit	103	7.907
Direct operating mechanisms (lockable)						
250		3KE4230-0CA	1	1 unit	103	4.964
400		3KE4330-0CA	1	1 unit	103	4.946
630		3KE4430-0CA	1	1 unit	103	7.377
1000		3KE4530-0CA	1	1 unit	103	7.907
Handles (black) + masking plates + display plates (silver) for basic switch versions without handle						
Direct operating mechanisms						
250		8UC9370	1	1 unit	103	0.124
		+ 8UB9530	1	1 unit	103	0.026
		+ 8UC9631-0B	1	1 unit	103	0.010
400		8UC9370	1	1 unit	103	0.124
		+ 8UB9530	1	1 unit	103	0.026
		+ 8UC9631-0B	1	1 unit	103	0.010
630		8UC9374	1	1 unit	103	0.143
		+ 8UB9530	1	1 unit	103	0.026
		+ 8UC9631-0B	1	1 unit	103	0.010
1000		8UC9374	1	1 unit	103	0.143
		+ 8UB9530	1	1 unit	103	0.026
		+ 8UC9631-0B	1	1 unit	103	0.010
Direct operating mechanisms (lockable)						
250		8UC9370	1	1 unit	103	0.124
		+ 8UC9563	1	1 unit	103	0.270
		+ 8UC9631-0B	1	1 unit	103	0.010
400		8UC9370	1	1 unit	103	0.124
		+ 8UC9563	1	1 unit	103	0.270
		+ 8UC9631-0B	1	1 unit	103	0.010
630		8UC9374	1	1 unit	103	0.143
		+ 8UC9563	1	1 unit	103	0.270
		+ 8UC9631-0B	1	1 unit	103	0.010
1000		8UC9374	1	1 unit	103	0.143
		+ 8UC9563	1	1 unit	103	0.270
		+ 8UC9631-0B	1	1 unit	103	0.010

7

Switch Disconnectors

3KA, 3KE Switch Disconnectors up to 1000 A

Floor mounting

Rated uninterrupted current I_u	DT	3-pole, rear operating mechanism and actuation	PU (UNIT, SET, M)	PS*/P. unit	PG	Weight per PU approx.
A		Article No.	Price per PU			kg
EMERGENCY-STOP red handles + masking plates + display plates (yellow) for basic switch versions without handle						
Direct operating mechanisms						
250		8UC9371	1	1 unit	103	0.142
		+ 8UB9530	1	1 unit	103	0.026
		+ 8UC9633-0B	1	1 unit	103	0.010
400		8UC9371	1	1 unit	103	0.142
		+ 8UB9530	1	1 unit	103	0.026
		+ 8UC9633-0B	1	1 unit	103	0.010
630		8UC9375	1	1 unit	103	0.160
		+ 8UB9530	1	1 unit	103	0.026
		+ 8UC9633-0B	1	1 unit	103	0.010
1000		8UC9375	1	1 unit	103	0.160
		+ 8UB9530	1	1 unit	103	0.026
		+ 8UC9633-0B	1	1 unit	103	0.010
Direct operating mechanisms (lockable)						
250		8UC9371	1	1 unit	103	0.142
		+ 8UC9563	1	1 unit	103	0.270
		+ 8UC9633-0B	1	1 unit	103	0.010
400		8UC9371	1	1 unit	103	0.142
		+ 8UC9563	1	1 unit	103	0.270
		+ 8UC9633-0B	1	1 unit	103	0.010
630		8UC9375	1	1 unit	103	0.160
		+ 8UC9563	1	1 unit	103	0.270
		+ 8UC9633-0B	1	1 unit	103	0.010
1000		8UC9375	1	1 unit	103	0.160
		+ 8UC9563	1	1 unit	103	0.270
		+ 8UC9633-0B	1	1 unit	103	0.010
3-pole, rear rotary operating mechanisms (lockable)						
Door-coupling rotary operating mechanisms (lockable)						
Article No.						
Price per PU						
kg						
Basic switch versions without handle						
250		3KE4230-0CA	1	1 unit	103	4.964
400		3KE4330-0CA	1	1 unit	103	4.946
630		3KE4430-0CA	1	1 unit	103	7.377
1000		3KE4530-0CA	1	1 unit	103	7.907
8UC7 door-coupling rotary operating mechanisms (black handle) for basic switch versions without handle						
250, 400, 630, 1000		8UC7314-1BB44	1	1 unit	103	1.170
8UC7 EMERGENCY-STOP door-coupling rotary operating mechanisms (red handle, yellow indicator plate) for basic switch versions without handle						
250, 400, 630, 1000		8UC7324-3BB44	1	1 unit	103	1.186

Switch Disconnectors

3KA, 3KE Switch Disconnectors up to 1000 A

Molded-plastic enclosures

Benefits

- Lockable with 3 padlocks
- Generous terminal compartment
- Degree of protection IP65
- Maintenance-free
- Easy mounting

Application

Our main control and EMERGENCY-STOP switches provide absolute safety, even during maintenance and repair work. All-round safety for people and machines.

With their high degree of protection IP65, they can even withstand dust and water spray, providing unparalleled safety in the

building and industrial installations as well as the food and chemical industry. Even with the enclosure open, they comply with protection class 2. IP20 is the minimum!

Selection and ordering data

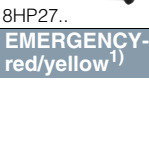
	Main contact elements	Aux. contact elements	P/AC-23A		I_u	Conductor cross-section of main conductor/PEN	DT	Article No.	Price per PU	PU (UNIT, SET, M)	PS*/P. unit	PG	Weight per PU approx. kg
			At 380 ... 400 V	At 660/690 V	A	mm ²							
Main control switches complete with rotary operating mechanism, black¹⁾													
	3	--	65	110	125	35/35 ²⁾		8HP2707		1	1 unit	046	5.240
			80	150	160	120/70 ²⁾		8HP2711		1	1 unit	046	8.039
			132	220	250	150/70 ²⁾		8HP2712		1	1 unit	046	12.242
			200	375	400	2 × 150 or 1 × 240/120		8HP2717		1	1 unit	046	12.378
			350	375	630	2 × 240/120		8HP2718		1	1 unit	046	13.050
			315	315	800 ³⁾	2 × 240/240		8HP2738		1	1 unit	046	14.290
EMERGENCY-STOP switches complete with rotary operating mechanism, red/yellow¹⁾													
	3	--	65	110	125	35/35 ²⁾		8HP2747		1	1 unit	046	5.217
			80	150	160	120/70 ²⁾		8HP2748		1	1 unit	046	7.992
			132	220	250	150/70 ²⁾		8HP2761		1	1 unit	046	12.340
			200	375	400	2 × 150 or 1 × 240/120		8HP2762		1	1 unit	046	12.354
			350	375	630	2 × 240/120		8HP2763		1	1 unit	046	12.875
			315	315	800 ³⁾	2 × 240/240		8HP2758		1	1 unit	046	14.329

¹⁾ With PE/ground or N terminal.

²⁾ For a fifth conductor, the same terminal can be fitted additionally.

³⁾ At ambient temperatures up to 35 °C.

Switch Disconnectors

3KA, 3KE Switch Disconnectors up to 1000 A

Accessories

Selection and ordering data



Version	DT	Article No.	Price per PU	PU (UNIT, SET, M)	PS*/P. unit	PG	Weight per PU approx. kg
3KA5030/3KA5130							
	▶	Terminal covers					
		For 3-pole devices (1 set = 6 units)	3KX3552-3DA01	1	1 unit	103	0.078
		For 4-pole devices (1 set = 8 units)	3KX3552-3DB01	1	1 unit	103	0.096
	▶	Door-coupling rotary operating mechanisms IP65					
		Black handle, shaft 300 mm	8UC7111-1BB10	1	1 unit	103	0.358
		EMERGENCY-STOP (yellow/red), shaft 300 mm	8UC7121-3BB10	1	1 unit	103	0.368
	▶	Operating mechanisms for fixed mounting					
		Black handle, shaft 250 mm	3KX3516-1AA	1	1 unit	103	0.102
	▶	Extension shaft 300 mm long					
			8UC6031	1	1 unit	103	0.068
	▶	Extension shaft 600 mm long					
			8UC6081	1	1 unit	103	0.136
	▶	Shaft connecting pieces					
			8UC6021	1	1 unit	103	0.027
	▶	Auxiliary switches					
		1 NO + 1 NC	3SB1400-0A	1	1 unit	41J	0.019
		2 NO	3SB1400-0G	1	1 unit	41J	0.019
		2 NC	3SB1400-0H	1	1 unit	41J	0.020
3KA5040/3KA5140/3KA52/3KA53							
	▶	Terminal covers					
		For 3-pole 3KA52 devices (1 set = 6 units)	3KX3552-3DA01	1	1 unit	103	0.078
		For 3KA53	3KX3553-3DA01	1	1 unit	103	0.151
	▶	Door-coupling rotary operating mechanisms IP65					
		Black handle, shaft 300 mm	8UC7212-1BB20	1	1 unit	103	0.404
		EMERGENCY-STOP (yellow/red), shaft 300 mm	8UC7222-3BB20	1	1 unit	103	0.423
	▶	Operating mechanisms for fixed mounting					
		Black handle, shaft 250 mm	3KX3536-1AA	1	1 unit	103	0.150
	▶	Extension shaft 300 mm long					
			8UC6032	1	1 unit	103	0.135
	▶	Extension shaft 600 mm long					
			8UC6082	1	1 unit	103	0.265
	▶	Shaft connecting pieces					
			8UC6022	1	1 unit	103	0.022
	▶	Auxiliary switches					
		1 NO + 1 NC	3SB1400-0A	1	1 unit	41J	0.019
		2 NO	3SB1400-0G	1	1 unit	41J	0.019
		2 NC	3SB1400-0H	1	1 unit	41J	0.020
		1 NO + 1 NC, 20 ms leading	3KX3552-3EA01	1	1 unit	103	0.022
3KA55/3KA57/3KA58							
	▶	Terminal covers					
		For 3-pole devices (1 set = 6 units)	3KX3557-3DA01	1	1 unit	103	0.293
		For 4-pole devices (1 set = 8 units)	3KX3557-3DB01	1	1 unit	103	0.370
	▶	Door-coupling rotary operating mechanisms IP65					
		Black handle, shaft 300 mm	8UC7313-1BB30	1	1 unit	103	0.998
		EMERGENCY-STOP (yellow/red), shaft 300 mm	8UC7323-3BB30	1	1 unit	103	1.016
	▶	Operating mechanisms for fixed mounting					
		Black handle, shaft 250 mm	3KX3176-1E	1	1 unit	103	0.287
	▶	Extension shaft 300 mm long					
			8UC6033	1	1 unit	103	0.215
	▶	Extension shaft 600 mm long					
			8UC6083	1	1 unit	103	0.424
	▶	Shaft connecting pieces					
			8UC6023	1	1 unit	103	0.083
	▶	Auxiliary switches					
		1 NO + 1 NC	3SB1400-0A	1	1 unit	41J	0.019
		2 NO	3SB1400-0G	1	1 unit	41J	0.019
		2 NC	3SB1400-0H	1	1 unit	41J	0.020
		1 NO + 1 NC, 20 ms leading	3KX3552-3EA01	1	1 unit	103	0.022

* You can order this quantity or a multiple thereof.

Switch Disconnectors

3KA, 3KE Switch Disconnectors up to 1000 A

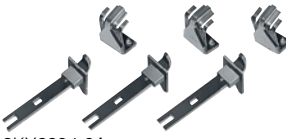

Accessories

Version	DT	Article No.	Price per PU	PU (UNIT, SET, M)	PS*/P. unit	PG	Weight per PU approx. kg
3KE42/3KE43							
Changeover switches							
 <p>3KX2210-0D</p>	Changeover switches with break-before-make feature Switch I ON – Switch II OFF Switch I OFF – Switch II OFF Switch I OFF – Switch II ON		3KX2210-0D	1	1 unit	103	2.450
	Door-coupling rotary operating mechanisms IP65 Black handle for changeover switch with break-before-make feature, shaft 300 mm		8UC7414-1BF44	1	1 unit	103	1.208
	Direct operating mechanisms Handle (black) for fixed mounting		8UC9381	1	1 unit	103	0.270
	Changeover switches without break-before-make feature Switch I ON – Switch II OFF Switch I ON – Switch II ON Switch I OFF – Switch II ON		3KX2210-0E	1	1 unit	103	2.451
	Door-coupling rotary operating mechanisms IP65 Black handle for changeover switch without break-before-make feature, shaft 300 mm		8UC7414-1FG44	1	1 unit	103	1.113
	Direct operating mechanisms Handle (black) for fixed mounting		8UC9381	1	1 unit	103	0.270
	Parallel switches Switch I ON – Switch II ON Switch I OFF – Switch II OFF		3KX2250-1A	1	1 unit	103	0.780
	Door-coupling rotary operating mechanisms IP65 Handle (black), shaft 300 mm		8UC7414-1BB44	1	1 unit	103	1.159
	EMERGENCY-STOP door-coupling rotary operating mechanisms IP65 Handle (red), shaft 300 mm		8UC7424-3BB44	1	1 unit	103	1.120
	Direct operating mechanisms Handle (black) for fixed mounting		8UC9381	1	1 unit	103	0.270
Further accessories							
 <p>3KX3557-3DA01</p>	Terminal covers (1 set = 6 units)		3KX3557-3DA01	1	1 unit	103	0.293
	Door-coupling rotary operating mechanisms IP65 Black handle, shaft 300 mm EMERGENCY-STOP (yellow/red), shaft 300 mm		8UC7314-1BB44 8UC7324-3BB44	1	1 unit	103	1.170 1.186
Extension shaft 300 mm long		8UC6034	1	1 unit	103	0.316	
Extension shaft 600 mm long		8UC6084	1	1 unit	103	0.628	
 <p>3KX2231-1A</p>	Auxiliary switches with switching cam 1 NO + 1 NC (complete mounting kit)		3KX2231-1A	1	1 unit	103	0.051
	Grounding brackets		3KX2252-1A	1	1 unit	103	0.050
Arc chutes (spare part with 3 arc-splitter assemblies)		3KY2202-0B	1	1 unit	103	0.600	
 <p>3KY2204-0A</p>	Arcing contacts (spare part with 3 fixed and 3 movable contacts)		3KY2204-0A	1	1 unit	103	0.201

Switch Disconnectors

3KA, 3KE Switch Disconnectors up to 1000 A

Accessories

Version	DT	Article No.	Price per PU	PU (UNIT, SET, M)	PS*/P. unit	PG	Weight per PU approx. kg	
3KE44/3KE45								
Changeover switches								
 3KX2210-0D		Changeover switches with break-before-make feature Switch I ON – Switch II OFF Switch I OFF – Switch II OFF Switch I OFF – Switch II ON	3KX2210-0D	1	1 unit	103	2.450	
		Door-coupling rotary operating mechanisms IP65 Black handle for changeover switch with break-before-make feature, shaft 300 mm	8UC7414-1BF44	1	1 unit	103	1.208	
		Direct operating mechanisms Handle (black) for fixed mounting	8UC9381	1	1 unit	103	0.270	
		Changeover switches without break-before-make feature Switch I ON – Switch II OFF Switch I ON – Switch II ON Switch I OFF – Switch II ON	3KX2210-0E	1	1 unit	103	2.451	
		Door-coupling rotary operating mechanisms IP65 Black handle for changeover switch without break-before-make feature, shaft 300 mm	8UC7414-1FG44	1	1 unit	103	1.113	
		Direct operating mechanisms Handle (black) for fixed mounting	8UC9381	1	1 unit	103	0.270	
		Parallel switches Switch I ON – Switch II ON Switch I OFF – Switch II OFF	3KX2250-1A	1	1 unit	103	0.780	
		Door-coupling rotary operating mechanisms IP65 Handle (black), shaft 300 mm	8UC7414-1BB44	1	1 unit	103	1.159	
		EMERGENCY-STOP door-coupling rotary operating mechanisms IP65 Handle (red), shaft 300 mm	8UC7424-3BB44	1	1 unit	103	1.120	
		Direct operating mechanisms Handle (black) for fixed mounting	8UC9381	1	1 unit	103	0.270	
		Further accessories						
		Terminal covers (top and bottom)	3KX2252-0C	1	1 unit	103	0.418	
		Door-coupling rotary operating mechanisms IP65 Black handle, shaft 300 mm	8UC7314-1BB44	1	1 unit	103	1.170	
		EMERGENCY-STOP (yellow/red), shaft 300 mm	8UC7324-3BB44	1	1 unit	103	1.186	
		Extension shaft 300 mm long	8UC6034	1	1 unit	103	0.316	
		Extension shaft 600 mm long	8UC6084	1	1 unit	103	0.628	
		Auxiliary switches 1 NO + 1 NC (complete mounting kit)	3KX2231-1A	1	1 unit	103	0.051	
	Grounding brackets	3KX2252-1A	1	1 unit	103	0.050		
	Arc chutes (spare part with 3 arc-splitter assemblies)	3KY2232-0A	1	1 unit	103	1.031		
	Arcing contacts Spare part with 3 fixed and 3 movable contacts	3KY2234-0A	1	1 unit	103	0.110		
 3KX2231-1A								
 3KY2232-0A								

Switch Disconnectors

3VT Switch Disconnectors up to 1600 A

Introduction

Overview

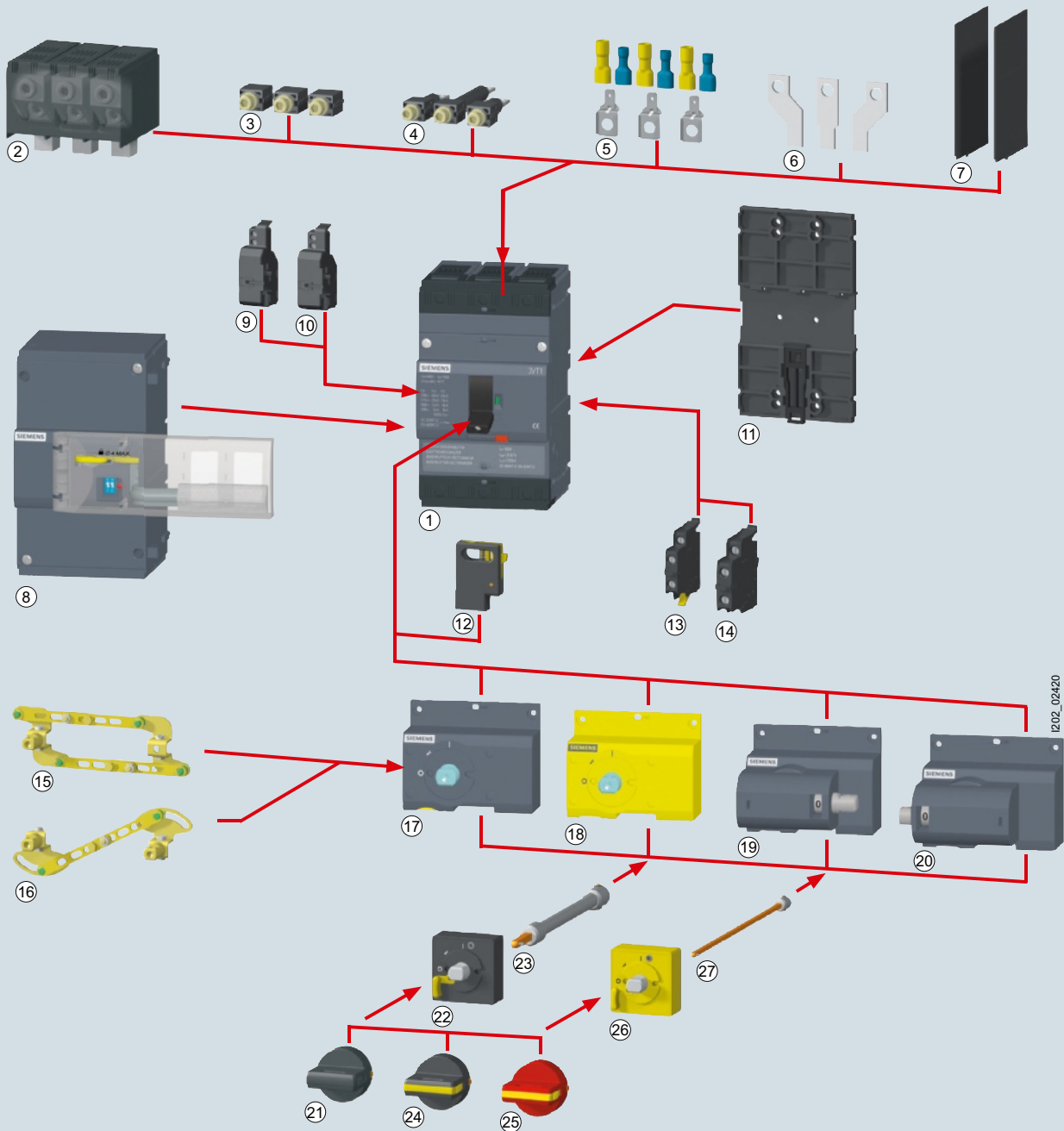

- | | | |
|--|--|--|
| ① Switch disconnector | ⑩ Undervoltage release | ⑲ Lateral manual operating mechanism (right) |
| ② Circular conductor terminal | ⑪ Adapter to install on 35 mm DIN rail | ⑳ Lateral manual operating mechanism (left) |
| ③ Front connection | ⑫ Locking type lever | ㉑ Non lockable knob |
| ④ Rear connection | ⑬ Signal switch | ㉒ Coupling driver |
| ⑤ Auxiliary conductor terminal | ⑭ Auxiliary switch | ㉓ Telescopic extension shaft |
| ⑥ Front connecting bus with increased pole spacing | ⑮ Mechanical parallel switching | ㉔ Lockable knob |
| ⑦ Insulating barriers | ⑯ Mechanical interlocking | ㉕ Lockable knob |
| ⑧ Lateral rotary operating mechanism | ⑰ Front manual operating mechanism | ㉖ Coupling driver |
| ⑨ Shunt release | ⑱ Front manual operating mechanism | ㉗ Extension shaft |

The 3VT switch disconnectors are a derivative of the corresponding 3VT circuit breakers. This has the advantage that they can be equipped with accessory components in a wide range of ways.

The only difference between this version of the switch connectors and the circuit breakers is the absence of a release. They can be used up to a rated voltage of 690 V AC and 440 V DC.

Switch Disconnectors

3VT Switch Disconnectors up to 1600 A

Introduction

Application

3VT switch disconnectors can be used as main control switches for sub-distribution boards, repair and transfer switches for cables, busbars or unit combinations.

As three and four-pole versions, they ensure making and breaking of the specified rated current under load. At the same time, they constitute a safety isolating function and isolating distance in all low-voltage circuits.

The position of the operating toggle lever always matches that of the contacts (positive operation).

All 3VT switch disconnectors meet the requirements of IEC 60947-1 and IEC 60947-3.

Technical specifications





Rated current I_n	A	160	250	630	1000	1600	
Number of poles		3 and 4	3 and 4	3 and 4	3	3	
Rated insulation voltage U_i	V	690					
Rated impulse withstand voltage U_{imp}	kA _{rms} /1s	2	3	7.5	15	20	
Utilization category		AC-23A DC-22A		AC-23B DC-23B			
Rated operational voltage U_e	V	690 440 (3 conducting paths series-connected)					
Rated short-time withstand current I_{cw}	kA _{rms} /1s	2	3	7.5	15	20	
Rated impulse withstand voltage U_{imp}	kV	8					
Rated short-circuit making capacity I_{cm}/U_e		2.8		4.26		12.5	
• At 415 V AC	kA	2.8	4.26	12.5	30	40	
• At 440 V DC	kA	2.8	4.26	12.5	30	40	
Endurance							
• Mechanical	Operating cycles	20 000	30 000	20 000	10 000	10 000	
• Electrical	Operating cycles	6 000	3 000	5 000	4 000	4 000	
Switching frequency	1/h	120					
Power loss per pole	W	15	18	75	100	120	

Switch Disconnectors

3VT Switch Disconnectors up to 1600 A





3VT1 switch disconnectors up to 160 A

Selection and ordering data

Version	Rated current I_n A	DT	Article No.	Price per PU	PU (UNIT, SET, M)	PS*/ P. unit	PG	Weight per PU approx. kg
3VT1 switch disconnectors								
Switch disconnectors								
	3-pole	160	3VT1716-2DE36-0AA0		1	1 unit	193	1.015
	4-pole	160	3VT1716-2EE46-0AA0		1	1 unit	193	1.336

Accessories

Auxiliary switches and auxiliary releases



Rated operational voltage U_s V	Frequency Hz	DT	Article No.	Price per PU	PU (UNIT, SET, M)	PS*/ P. unit	PG	Weight per PU approx. kg
Auxiliary switches								
CO contacts								
	• 60 ... 250 AC/DC	50/60	3VT9100-2AB10		1	1 unit	193	0.020
	• 5 ... 60 AC/DC	50/60	3VT9100-2AB20		1	1 unit	193	0.010
Alarm switches								
CO contacts								
	• 60 ... 250 AC/DC	50/60	3VT9100-2AH10		1	1 unit	193	0.020
	• 5 ... 60 AC/DC	50/60	3VT9100-2AH20		1	1 unit	193	0.010
Shunt releases								
	• 12 DC	--	3VT9100-1SB00		1	1 unit	193	0.050
	• 24, 48 AC/DC	50/60	3VT9100-1SC00		1	1 unit	193	0.050
	• 110, 230 AC 110, 220 DC	50/60	3VT9100-1SD00		1	1 unit	193	0.050
	• 230, 400 AC 220 DC	50/60	3VT9100-1SE00		1	1 unit	193	0.050
Undervoltage releases								
	• 24, 48 AC	50/60	3VT9100-1UC00		1	1 unit	193	0.050
	• 110, 230 AC	50/60	3VT9100-1UD00		1	1 unit	193	0.050
	• 230, 400 AC	50/60	3VT9100-1UE00		1	1 unit	193	0.050
	• 24, 48 DC	--	3VT9100-1UU00		1	1 unit	193	0.050
	• 110, 220 DC	--	3VT9100-1UV00		1	1 unit	193	0.050

Switch Disconnectors

3VT Switch Disconnectors up to 1600 A

3VT1 switch disconnectors up to 160 A

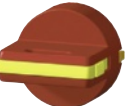





Manual operating mechanisms

Version	Color	DT	Article No.	Price per PU	PU (UNIT, SET, M)	PS*/P. unit	PG	Weight per PU approx. kg
Manual operating mechanisms								
Rotary operating mechanisms								
	• Interlocking not available	Gray	3VT9100-3HA10		1	1 unit	193	0.079
	• Lockable with padlock	Gray	3VT9100-3HA20		1	1 unit	193	0.122
	• Lockable with padlock	Yellow	3VT9100-3HB20		1	1 unit	193	0.079
	• For lateral operation, mounted on left side, interlocking not available	Gray	3VT9100-3HC10		1	1 unit	193	0.137
	• For lateral operation, mounted on right side, interlocking not available	Gray	3VT9100-3HD10		1	1 unit	193	0.137
Handle for manual operating mechanism								
  	• Interlocking not available	Black	3VT9100-3HE10		1	1 unit	193	0.019
	• Lockable with padlock	Black	3VT9100-3HE20		1	1 unit	193	0.021
	• Lockable with padlock	Red	3VT9100-3HF20		1	1 unit	193	0.019
Coupling drivers for door-coupling operating mechanism, can be defeated								
	For use with black handle 3VT9100-3HE..							
	• Degree of protection IP40	Black	3VT9100-3HG10		1	1 unit	193	0.042
	• Degree of protection IP66	Black	3VT9100-3HG20		1	1 unit	193	0.098
	For use with red handle 3VT9100-3HF20							
	• Degree of protection IP40	Yellow	3VT9100-3HH10		1	1 unit	193	0.042
	• Degree of protection IP66	Yellow	3VT9100-3HH20		1	1 unit	193	0.098

Switch Disconnectors

3VT Switch Disconnectors up to 1600 A

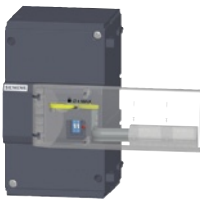
3VT1 switch disconnectors up to 160 A

Version	Color	DT	Article No.	Price per PU	PU (UNIT, SET, M)	PS*/P. unit	PG	Weight per PU approx. kg	
Extension shafts									
			3VT9100-3HJ10		1	1 unit	193	0.113	
• Length 350 mm, can be shortened									
			3VT9100-3HJ20		1	1 unit	193	0.092	
• Length 199 ... 352 mm, extendable									
Mechanical interlocks									
			3VT9100-8LA00		1	1 unit	193	0.089	
Mechanical interlocks									
Mechanical parallel switching									
			3VT9100-8LB00		1	1 unit	193	0.109	
Mechanical parallel switching									
Motorized operating mechanisms									
Rated operational voltage U_s		Frequency	DT	Article No.	Price per PU	PU (UNIT, SET, M)	PS*/P. unit	PG	Weight per PU approx. kg
V		Hz							
Motorized operating mechanisms, lateral mounting									
	With locking mechanism for 3 padlocks								
	24 AC/DC	50/60	3VT9100-3MA00		1	1 unit	193	0.900	
	48 AC/DC	50/60	3VT9100-3MB00		1	1 unit	193	0.900	
	110 AC/DC	50/60	3VT9100-3MD00		1	1 unit	193	0.900	
	230 AC, 220 DC	50/60	3VT9100-3ME00		1	1 unit	193	0.900	
Accessories for motorized operating mechanisms									
	Extension cables for motorized operating mechanism								
	12 cables, length 60 cm		3VT9100-3MF00		1	1 unit	193	0.056	

Switch Disconnectors

3VT Switch Disconnectors up to 1600 A

3VT1 switch disconnectors up to 160 A

Connection accessories



	Version	Conductor cross-sections mm ²	Connection type	DT	Article No.	Price per PU	PU (UNIT, SET, M)	PS*/P. unit	PG	Weight per PU approx. kg
Connection combinations										
	Connection combinations for 3-pole version									
	Front connecting bars	--	Al/Cu busbars, cable lugs		3VT9100-4ED30		1	1 unit	193	0.108
For increased pole spacing										
	Front terminals	--	Al/Cu busbars, cable lugs		3VT9100-4TA30		1	1 unit	193	0.055
	Rear terminals	--	Al/Cu busbars, cable lugs		3VT9100-4RC30		1	1 unit	193	0.179
	Multiple feed-in terminals	2 x 25 ... 120	Cu/Al cables		3VT9100-4TF30		1	1 unit	193	0.240
Terminal covers, degree of protection IP20 (included in scope of supply)										
	Auxiliary conductor terminals	1.5 ... 2.5; 4 ... 6	Flexible Cu conductors		3VT9100-4TN30		1	1 unit	193	0.010
	Terminals for 4-pole version									
	Front terminals	--	Al/Cu busbars, cable lugs		3VT9100-4TA00		1	1 unit	193	0.015
For 4th pole (for use with connection combination 3VT9100-4TA30)										
	Rear terminals	--	Al/Cu busbars, cable lugs		3VT9100-4RC00		1	1 unit	193	0.080
For 4th pole (for use with connection combination 3VT9100-4RC30)										
	Multiple feed-in terminals	2 x 25 ... 120	Cu/Al cables		3VT9100-4TF40		1	1 unit	193	0.250
Terminal covers, degree of protection IP20 (included in scope of supply)										
	Auxiliary conductor terminals	1.5 ... 2.5; 4 ... 6	Flexible Cu conductors		3VT9100-4TN00		1	1 unit	193	0.005
For 4th pole (for use with connection combination 3VT9100-4TN30)										

Switch Disconnectors

3VT Switch Disconnectors up to 1600 A

3VT1 switch disconnectors up to 160 A

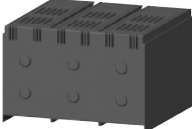
Mounting accessories

Version	DT	Article No.	Price per PU	PU (UNIT, SET, M)	PS*/P. unit	PG	Weight per PU approx. kg
Mounting accessories							
	Phase barriers Included in scope of supply of switch disconnector. If infeed is from below, the units must also be fitted on the sides of terminals 2, 4 and 6 with these phase barriers.						
	<ul style="list-style-type: none"> • For 3-pole version, 2 units • For 4-pole version, 1 unit 						
		3VT9100-8CE30 3VT9100-8CE00			1	1 unit	193 0.053 193 0.020
	Terminal covers, degree of protection IP20 Increases degree of protection of connection point to IP20, e.g. when used with cable lugs.						
	<ul style="list-style-type: none"> • For 3-pole version • For 4-pole version 						
		3VT9100-8CA30 3VT9100-8CA40			1	1 unit	193 0.091 193 0.080
	Locking devices for knob <ul style="list-style-type: none"> • Allows the switch disconnector to be locked in the "manual off" position. • Locking is by means of a padlock with a diameter of up to 3 ... 4 mm. 						
		3VT9100-3HL00			1	1 unit	193 0.015
Mounting adapters							
	3/4-pole version For mounting on a 35 mm standard mounting rail						
		3VT9100-4PP30			1	1 unit	193 0.065

Switch Disconnectors

3VT Switch Disconnectors up to 1600 A





3VT2 switch disconnectors up to 250 A

Selection and ordering data

Version	Rated current I_n	DT	Article No.	Price per PU	PU (UNIT, SET, M)	PS*/P. unit	PG	Weight per PU approx.
	A							kg
Switching units								
Switch disconnectors								
	3-pole	250	3VT2725-2DE36-0AA0		1	1 unit	193	3.600
	4-pole	250	3VT2725-2EE46-0AA0		1	1 unit	193	4.300

Accessories



Auxiliary switches and auxiliary releases

Rated operational voltage U_g	Frequency	DT	Article No.	Price per PU	PU (UNIT, SET, M)	PS*/P. unit	PG	Weight per PU approx.
V	Hz							kg
Auxiliary switches and alarm switches								
Individual NO contacts								
	60 ... 500 AC/DC	50/60	3VT9300-2AC10		1	1 unit	193	0.035
	5 ... 60 AC/DC	50/60	3VT9300-2AC20		1	1 unit	193	0.036
Individual NC contacts								
	60 ... 500 AC/DC	50/60	3VT9300-2AD10		1	1 unit	193	0.013
	5 ... 60 AC/DC	50/60	3VT9300-2AD20		1	1 unit	193	0.013
Double contacts (2 x NO contacts)								
	60 ... 500 AC/DC	50/60	3VT9300-2AE10		1	1 unit	193	0.038
	5 ... 60 AC/DC	50/60	3VT9300-2AE20		1	1 unit	193	0.038
Double contacts (NO contact and NC contact)								
	60 ... 500 AC/DC	50/60	3VT9300-2AF10		1	1 unit	193	0.038
	5 ... 60 AC/DC	50/60	3VT9300-2AF20		1	1 unit	193	0.038
Double contacts (2 x NC contacts)								
	60 ... 500 AC/DC	50/60	3VT9300-2AG10		1	1 unit	193	0.038
	5 ... 60 AC/DC	50/60	3VT9300-2AG20		1	1 unit	193	0.038
CO contacts								
	60 ... 250 AC/DC	50/60	3VT9300-2AH10		1	1 unit	193	0.013
	5 ... 60 AC/DC	50/60	3VT9300-2AH20		1	1 unit	193	0.013
Leading contacts								
	60 ... 500 AC/DC	50/60	3VT9300-2AJ00		1	1 unit	193	0.040

Switch Disconnectors





3VT Switch Disconnectors up to 1600 A

3VT2 switch disconnectors up to 250 A

	Rated operational voltage U_s	Frequency	DT	Article No.	Price per PU	PU (UNIT, SET, M)	PS*/P. unit	PG	Weight per PU approx. kg
	V	Hz							
Shunt releases									
	12 DC	--		3VT9100-1SE00		1	1 unit	193	0.050
	24, 40, 48 AC/DC	50/60		3VT9300-1SC00		1	1 unit	193	0.140
	110 AC/DC	50/60		3VT9300-1SE00		1	1 unit	193	0.154
	230, 400, 500 AC/220 DC	50/60		3VT9300-1SE00		1	1 unit	193	0.154
Undervoltage releases									
	24, 40, 48 AC/DC	50/60		3VT9300-1UC00		1	1 unit	193	0.151
	110 AC/DC	50/60		3VT9300-1UD00		1	1 unit	193	0.110
	230, 400, 500 AC/220 DC	50/60		3VT9300-1UE00		1	1 unit	193	0.110
	With leading contact¹⁾								
	24, 40, 48 AC/DC	50/60		3VT9300-1UC10		1	1 unit	193	0.120
	110 AC/DC	50/60		3VT9300-1UD10		1	1 unit	193	0.140
230, 400, 500 AC/220 DC	50/60		3VT9300-1UE10		1	1 unit	193	0.120	

¹⁾ Not suitable for 3VT9200-3M...0 motorized operating mechanism.

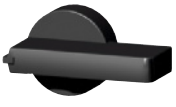
Manual operating mechanisms

	Version	Color	DT	Article No.	Price per PU	PU (UNIT, SET, M)	PS*/P. unit	PG	Weight per PU approx. kg
Rotary operating mechanisms									
	• Interlocking not available	Gray		3VT9200-3HA10		1	1 unit	193	0.223
	• Lockable with padlock	Gray		3VT9200-3HA20		1	1 unit	193	0.223
	• Lockable with padlock	Yellow label		3VT9200-3HB20		1	1 unit	193	0.223
	• For lateral operation, mounted on left side, interlocking not available	Gray		3VT9200-3HC10		1	1 unit	193	0.700
	• For lateral operation, mounted on right side, interlocking not available	Gray		3VT9200-3HD10		1	1 unit	193	0.700
Handle for manual operating mechanism									
	• Interlocking not available	Black		3VT9300-3HE10		1	1 unit	193	0.075
	• Lockable with padlock	Black		3VT9300-3HE20		1	1 unit	193	0.075
	• Lockable with padlock	Red		3VT9300-3HF20		1	1 unit	193	0.075

Switch Disconnectors

3VT Switch Disconnectors up to 1600 A

3VT2 switch disconnectors up to 250 A





Version	Color	DT	Article No.	Price per PU	PU (UNIT, SET, M)	PS*/P. unit	PG	Weight per PU approx. kg
Coupling drivers for door-coupling operating mechanism								
	For use with black handle 3VT9300-3HE..							
	<ul style="list-style-type: none"> Degree of protection IP40 Degree of protection IP66 	Black	3VT9300-3HG10		1	1 unit	193	0.146
	For use with red handle 3VT9300-3HF20							
	<ul style="list-style-type: none"> Degree of protection IP40 Degree of protection IP66 	Black	3VT9300-3HG20		1	1 unit	193	0.146
	For use with red handle 3VT9300-3HF20							
	<ul style="list-style-type: none"> Degree of protection IP40 Degree of protection IP66 	Yellow	3VT9300-3HH10		1	1 unit	193	0.140
	For use with red handle 3VT9300-3HF20							
	<ul style="list-style-type: none"> Degree of protection IP66 	Yellow	3VT9300-3HH20		1	1 unit	193	0.200
Coupling drivers for door-coupling operating mechanism, can be defeated								
	For use with black handle 3VT9300-3HE..							
	<ul style="list-style-type: none"> Degree of protection IP40 	Black	3VT9300-3HG30		1	1 unit	193	0.211
	For use with red handle 3VT9300-3HF20							
	<ul style="list-style-type: none"> Degree of protection IP40 	Yellow	3VT9300-3HH30		1	1 unit	193	0.209
Extension shafts								
	<ul style="list-style-type: none"> Length 365 mm, can be shortened 							
			3VT9300-3HJ10		1	1 unit	193	0.205
	<ul style="list-style-type: none"> Length 245 ... 410 mm, extendable 							
			3VT9300-3HJ20		1	1 unit	193	0.255

Switch Disconnectors

3VT Switch Disconnectors up to 1600 A

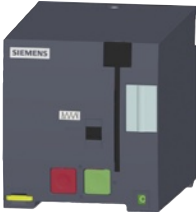
3VT2 switch disconnectors up to 250 A

Motorized operating mechanisms

	Rated operational voltage U_s	Frequency	DT	Article No.	Price per PU	PU (UNIT, SET, M)	PS*/P. unit	PG	Weight per PU approx. kg
	V	Hz							
Motorized operating mechanisms with stored-energy mechanism									
	With locking mechanism for 3 padlocks, degree of protection IP00								
	24 AC/DC	50/60		3VT9200-3MJ00		1	1 unit	193	1.529
	48 AC/DC	50/60		3VT9200-3ML00		1	1 unit	193	1.529
	110 AC/DC	50/60		3VT9200-3MN00		1	1 unit	193	1.529
	230 AC/220 DC	50/60		3VT9200-3MQ00		1	1 unit	193	1.564
	Motorized operating mechanism with counter								
	24 AC/DC	50/60		3VT9200-3MJ10		1	1 unit	193	1.546
	48 AC/DC	50/60		3VT9200-3ML10		1	1 unit	193	1.546
	110 AC/DC	50/60		3VT9200-3MN10		1	1 unit	193	1.546
	230 AC/220 DC	50/60		3VT9200-3MQ10		1	1 unit	193	1.546
Accessories for motorized operating mechanisms									
	Counter with cable, length 110 cm			3VT9300-3MF10		1	1 unit	193	0.003
		Extension cables for motorized operating mechanism, 12 cables, length 60 cm			3VT9300-3MF00		1	1 unit	193

Mounting accessories

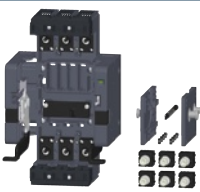









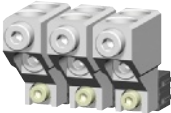

	Version	DT	Article No.	Price per PU	PU (UNIT, SET, M)	PS*/P. unit	PG	Weight per PU approx. kg
Plug-in base assembly kits								
	3-pole		3VT9200-4PA30		1	1 unit	193	1.766
	4-pole		3VT9200-4PA40		1	1 unit	193	2.100
Withdrawable versions								
	3-pole		3VT9200-4WA30		1	1 unit	193	3.497
	4-pole		3VT9200-4WA40		1	1 unit	193	3.200

Switch Disconnectors

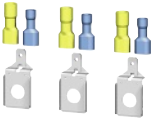
3VT Switch Disconnectors up to 1600 A

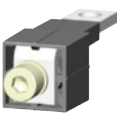
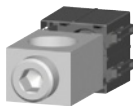
3VT2 switch disconnectors up to 250 A

Connection accessories

	Version	Conductor cross-section S mm ²	Connection type	DT	Article No.	Price per PU	PU (UNIT, SET, M)	PS*/P. unit	PG	Weight per PU approx. kg
Connection combinations										
Connection combinations for 3-pole version										
	Front connecting bars									
	For increased pole spacing, short	--	Al/Cu busbars/ cable lugs, flexibars		3VT9200-4ED30		1	1 unit	193	0.303
	For increased pole spacing, long	--	Al/Cu busbars/ cable lugs, flexibars		3VT9200-4EE30		1	1 unit	193	0.447
	Front terminals									
	Included in scope of supply of all switching units	--	Al/Cu busbars/ cable lugs, flexibars		3VT9200-4TA30		1	1 unit	193	0.120
	Rear terminals									
		--	Al/Cu busbars/ cable lugs		3VT9200-4RC30		1	1 unit	193	0.250
Multiple feed-in terminals¹⁾										
	For 1 cable	1 x 25 ... 150	Cu/Al cables		3VT9215-4TD30		1	1 unit	193	0.200
		1 x 150 ... 240	Cu/Al cables		3VT9224-4TD30		1	1 unit	193	0.339
	For 2 cables	2 x 25 ... 150	Cu/Al cables		3VT9215-4TF30		1	1 unit	193	0.520
		2 x 150 ... 240	Cu/Al cables		3VT9224-4TF30		1	1 unit	193	0.630
	For 6 cables	6 x 6 ... 35	Cu/Al cables		3VT9203-4TF30		1	1 unit	193	0.300
	Auxiliary conductor terminals									
		1.5 ... 2.5; 4 ... 6	Flexible Cu conductors		3VT9200-4TN30		1	1 unit	193	0.017
	Box terminals									
		16 ... 150	Cu cables, flexibars		3VT9200-4TC30		1	1 unit	193	0.240
Terminals for 4-pole version										
	Rear terminals									
		--	Al/Cu busbars/ cable lugs		3VT9200-4RC00		1	1 unit	193	0.320
Multiple feed-in terminals										
	For 1 cable	1 x 25 ... 150	Cu/Al cables		3VT9215-4TD00		1	1 unit	193	0.280
		1 x 150 ... 240	Cu/Al cables		3VT9224-4TD00		1	1 unit	193	0.430
	For 2 cables	2 x 25 ... 150	Cu/Al cables		3VT9215-4TF00		1	1 unit	193	0.680
		2 x 150 ... 240	Cu/Al cables		3VT9224-4TF00		1	1 unit	193	0.830
	For 6 cables	6 x 6 ... 35	Cu/Al cables		3VT9203-4TF00		1	1 unit	193	0.100
	Box terminals									
		16 ... 150	Cu cables, flexibars		3VT9200-4TC00		1	1 unit	193	0.320







¹⁾ Use terminal cover 3VT9200-8CB30 to increase termination point protection to IP20.

Switch Disconnectors

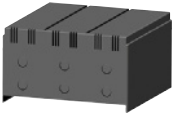
3VT Switch Disconnectors up to 1600 A

3VT2 switch disconnectors up to 250 A

Further accessories

Version	DT	Article No.	Price per PU	PU (UNIT, SET, M)	PS*/P. unit	PG	Weight per PU approx. kg
Phase barriers							
Included in scope of supply of switching unit. If infeed is from below, the units must also be fitted on the sides of terminals 2, 4 and 6 with these phase barriers.							
		3VT9300-8CE30		1	1 unit	193	0.090
		3VT9300-8CE00		1	1 unit	193	0.040
Terminal covers, degree of protection IP20							
Increases degree of protection of connection point to IP20 when using circular conductor terminals 3VT9224-4TD30, 3VT9215-4TF30, 3VT9224-4TF30 or 3VT9203-4TF30, designed for fixed-mounted, plug-in and withdrawable versions.							
		3VT9200-8CB30		1	1 unit	193	0.140
		3VT9200-8CB40		1	1 unit	193	0.081
Locking devices for knob							
• Allows the switch disconnector to be locked in the "manual off" position. • Locking is by means of up to 3 padlocks with a diameter of up to 6 mm.							
		3VT9200-3HL00		1	1 unit	193	0.013
Sealing devices							
Sealing for: • Overcurrent releases • Accessory compartment covers • Terminal covers • Manual operating mechanisms • Motorized operating mechanisms							
		3VT9200-8BN00		1	1 unit	193	0.001
Connecting cables							
For connecting switch disconnector accessories for withdrawable versions (can also be used for plug-in and fixed-mounted versions)							
		3VT9300-4PL00		1	1 unit	193	0.167
Position signaling switches							
For indicating the position of the switch disconnector in plug-in or withdrawable devices							
		3VT9300-4WL00		1	1 unit	193	0.020
Coding sets							
Prevents use of the wrong switching unit in plug-in or withdrawable devices							
		3VT9200-4WN00		1	1 unit	193	0.002
Covers for pushbuttons							
For motorized operating mechanisms; the cover may be equipped with a sealing device.							
		3VT9300-3MF20		1	1 unit	193	0.054

Switch Disconnectors

3VT Switch Disconnectors up to 1600 A

3VT3 switch disconnectors up to 630 A

Selection and ordering data

Version	Rated current I_n A	DT	Article No.	Price per PU	PU (UNIT, SET, M)	PS*/ P. unit	PG	Weight per PU approx. kg
Switching units								
Switch disconnectors								
3-pole	630		3VT3763-2DE36-0AA0		1	1 unit	193	6.200
4-pole	630		3VT3763-2EE46-0AA0		1	1 unit	193	7.060



Accessories



Auxiliary switches and auxiliary releases

Rated operational voltage U_s V	Frequency Hz	DT	Article No.	Price per PU	PU (UNIT, SET, M)	PS*/ P. unit	PG	Weight per PU approx. kg
Auxiliary switches and alarm switches								
Individual NO contacts								
60 ... 500 AC/DC	50/60		3VT9300-2AC10		1	1 unit	193	0.035
5 ... 60 AC/DC	50/60		3VT9300-2AC20		1	1 unit	193	0.036
Individual NC contacts								
60 ... 500 AC/DC	50/60		3VT9300-2AD10		1	1 unit	193	0.013
5 ... 60 AC/DC	50/60		3VT9300-2AD20		1	1 unit	193	0.013
Double contacts (2 x NO contacts)								
60 ... 500 AC/DC	50/60		3VT9300-2AE10		1	1 unit	193	0.038
5 ... 60 AC/DC	50/60		3VT9300-2AE20		1	1 unit	193	0.038
Double contacts (NO contact and NC contact)								
60 ... 500 AC/DC	50/60		3VT9300-2AF10		1	1 unit	193	0.038
5 ... 60 AC/DC	50/60		3VT9300-2AF20		1	1 unit	193	0.038
Double contacts (2 x NC contacts)								
60 ... 500 AC/DC	50/60		3VT9300-2AG10		1	1 unit	193	0.038
5 ... 60 AC/DC	50/60		3VT9300-2AG20		1	1 unit	193	0.038
CO contacts								
60 ... 250 AC/DC	50/60		3VT9300-2AH10		1	1 unit	193	0.013
5 ... 60 AC/DC	50/60		3VT9300-2AH20		1	1 unit	193	0.013
Leading contacts								
60 ... 500 AC/DC	50/60		3VT9300-2AJ00		1	1 unit	193	0.040

Switch Disconnectors

3VT Switch Disconnectors up to 1600 A

3VT3 switch disconnectors up to 630 A

	Rated operational voltage U_s	Frequency	DT	Article No.	Price per PU	PU (UNIT, SET, M)	PS*/P. unit	PG	Weight per PU approx. kg
	V	Hz							
Shunt releases									
	24, 40, 48 AC/DC	50/60		3VT9300-1SC00		1	1 unit	193	0.140
	110 AC/DC	50/60		3VT9300-1SD00		1	1 unit	193	0.140
	230, 400, 500 AC/220 DC	50/60		3VT9300-1SE00		1	1 unit	193	0.154
Undervoltage releases									
	24, 40, 48 AC/DC	50/60		3VT9300-1UC00		1	1 unit	193	0.151
	110 AC/DC	50/60		3VT9300-1UD00		1	1 unit	193	0.110
	230, 400, 500 AC/220 DC	50/60		3VT9300-1UE00		1	1 unit	193	0.110
	With leading contact ¹⁾								
	24, 40, 48 AC/DC	50/60		3VT9300-1UC10		1	1 unit	193	0.120
	110 AC/DC	50/60		3VT9300-1UD10		1	1 unit	193	0.140
230, 400, 500 AC/220 DC	50/60		3VT9300-1UE10		1	1 unit	193	0.120	

¹⁾ Not suitable for 3VT9300-3M..0 motorized operating mechanism.







Manual operating mechanisms

	Version	Color	DT	Article No.	Price per PU	PU (UNIT, SET, M)	PS*/P. unit	PG	Weight per PU approx. kg
Rotary operating mechanisms									
	Rotary operating mechanisms								
	• Interlocking not available	Gray		3VT9300-3HA10		1	1 unit	193	0.243
	• Lockable with padlock	Gray		3VT9300-3HA20		1	1 unit	193	0.243
	• Lockable with padlock	Yellow label		3VT9300-3HB20		1	1 unit	193	0.243
	• For lateral operation, mounted on left side, interlocking not available	Gray		3VT9300-3HC10		1	1 unit	193	0.700
	• For lateral operation, mounted on right side, interlocking not available	Gray		3VT9300-3HD10		1	1 unit	193	0.700
	Handle for manual operating mechanism								
	• Interlocking not available	Black		3VT9300-3HE10		1	1 unit	193	0.075
	• Lockable with padlock	Black		3VT9300-3HE20		1	1 unit	193	0.075
	• Lockable with padlock	Red		3VT9300-3HF20		1	1 unit	193	0.075

Switch Disconnectors

3VT Switch Disconnectors up to 1600 A

3VT3 switch disconnectors up to 630 A





Version	Color	DT	Article No.	Price per PU	PU (UNIT, SET, M)	PS*/P. unit	PG	Weight per PU approx. kg
Coupling drivers for door-coupling operating mechanism								
For use with black handle 3VT9300-3HE10 or 3VT9300-3HE20								
			3VT9300-3HG10		1	1 unit	193	0.146
			3VT9300-3HG20		1	1 unit	193	0.146
For use with red handle 3VT9300-3HF20								
			3VT9300-3HH10		1	1 unit	193	0.140
			3VT9300-3HH20		1	1 unit	193	0.200
Coupling drivers for door-coupling operating mechanism, can be defeated								
For use with black handle 3VT9300-3HE..								
			3VT9300-3HG30		1	1 unit	193	0.211
For use with red handle 3VT9300-3HF20								
			3VT9300-3HH30		1	1 unit	193	0.209
Extension shafts								
• Length 365 mm, can be shortened								
			3VT9300-3HJ10		1	1 unit	193	0.205
• Length 245 ... 410 mm, extendable								
			3VT9300-3HJ20		1	1 unit	193	0.255

Switch Disconnectors



3VT Switch Disconnectors up to 1600 A

3VT3 switch disconnectors up to 630 A

Motorized operating mechanisms

	Rated operational voltage U_s	Frequency (with AC)	DT	Article No.	Price per PU	PU (UNIT, SET, M)	PS*/P. unit	PG	Weight per PU approx. kg
	V	Hz							
Motorized operating mechanism with stored-energy mechanism									
	With locking mechanism for 3 padlocks, degree of protection IP00								
	24 V AC/DC	50/60		3VT9300-3MJ00		1	1 unit	193	1.691
	48 V AC/DC	50/60		3VT9300-3ML00		1	1 unit	193	1.691
	110 V AC/DC	50/60		3VT9300-3MN00		1	1 unit	193	1.752
	230 V AC/220 V DC	50/60		3VT9300-3MQ00		1	1 unit	193	1.746
	Motorized operating mechanism with counter								
	24 V AC/DC	50/60		3VT9300-3MJ10		1	1 unit	193	1.708
	48 V AC/DC	50/60		3VT9300-3ML10		1	1 unit	193	1.708
	110 V AC/DC	50/60		3VT9300-3MN10		1	1 unit	193	1.708
	230 V AC/220 V DC	50/60		3VT9300-3MQ10		1	1 unit	193	1.754
Accessories for motorized operating mechanisms									
	Counter with cable Length 110 cm			3VT9300-3MF10		1	1 unit	193	0.003
		Extension cables for motorized operating mechanism 12 cables, length 60 cm			3VT9300-3MF00		1	1 unit	193

Mounting accessories

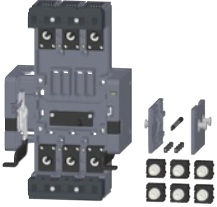
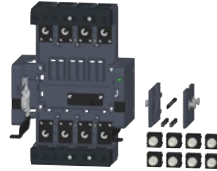



	Version	DT	Article No.	Price per PU	PU (UNIT, SET, M)	PS*/P. unit	PG	Weight per PU approx. kg
Plug-in base assembly kits								
	3-pole		3VT9300-4PA30		1	1 unit	193	2.610
	4-pole		3VT9300-4PA40		1	1 unit	193	3.400
								
Withdrawable versions								
	3-pole		3VT9300-4WA30		1	1 unit	193	4.986
	4-pole		3VT9300-4WA40		1	1 unit	193	4.500
								

Switch Disconnectors

3VT Switch Disconnectors up to 1600 A

3VT3 switch disconnectors up to 630 A

Connection accessories

Version	Max. permissible cross-section S mm ²	Connection type	DT	Article No.	Price per PU	PU (UNIT, SET, M)	PS*/ P. unit	PG	Weight per PU approx. kg
Connection combinations									
Connection combinations for 3-pole version									
Front connecting bars									
	For increased pole spacing, short	--	Al/Cu busbars/ cable lugs, flexibars	3VT9300-4ED30		1	1 unit	193	0.489
	For increased pole spacing, long	--	Al/Cu busbars/ cable lugs, flexibars	3VT9300-4EE30		1	1 unit	193	0.656
	Front terminals Included in scope of supply of all switching units	--	Al/Cu busbars, cable lugs, flexibars	3VT9300-4TA30		1	1 unit	193	0.186
	Rear terminals	--	Al/Cu busbars, cable lugs	3VT9300-4RC30		1	1 unit	193	0.558
Multiple feed-in terminals¹⁾									
	For 1 cable	1 x 25 ... 150	Cu/Al cables	3VT9315-4TD30		1	1 unit	193	0.302
		1 x 150 ... 240	Cu/Al cables	3VT9324-4TD30		1	1 unit	193	0.300
	For 2 cables	2 x 25 ... 150	Cu/Al cables	3VT9315-4TF30		1	1 unit	193	0.900
		2 x 150 ... 240	Cu/Al cables	3VT9324-4TF30		1	1 unit	193	0.721
	For 6 cables	6 x 6 ... 35	Cu/Al cables	3VT9303-4TF30		1	1 unit	193	0.300
	Auxiliary conductor terminals	1.5 ... 2.5; 4 ... 6	Flexible Cu conductors	3VT9300-4TN30		1	1 unit	193	0.021
	Box terminals	35 ... 240	Cu cables, flexibars	3VT9300-4TC30		1	1 unit	193	0.440
Terminals for 4-pole version									
	Rear terminals	--	Al/Cu busbars, cable lugs	3VT9300-4RC00		1	1 unit	193	0.200
Multiple feed-in terminals									
	For 1 cable	1 x 25 ... 150	Cu/Al cables	3VT9315-4TD00		1	1 unit	193	0.126
		1 x 150 ... 240	Cu/Al cables	3VT9324-4TD00		1	1 unit	193	0.110
	For 2 cables	2 x 25 ... 150	Cu/Al cables	3VT9315-4TF00		1	1 unit	193	0.285
		2 x 150 ... 240	Cu/Al cables	3VT9324-4TF00		1	1 unit	193	0.285
	For 6 cables	6 x 6 ... 35	Cu/Al cables	3VT9303-4TF00		1	1 unit	193	0.100
	Box terminals	35 ... 240	Cu cables, flexibars	3VT9300-4TC00		1	1 unit	193	0.580







¹⁾ Use terminal cover 3VT9300-8CB30 to increase termination point protection to IP20.

Switch Disconnectors

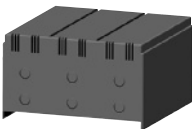
3VT Switch Disconnectors up to 1600 A

3VT3 switch disconnectors up to 630 A

Further accessories

Version	DT	Article No.	Price per PU	PU (UNIT, SET, M)	PS*/P. unit	PG	Weight per PU approx. kg
Phase barriers							
		Included in scope of supply of switching unit. If infeed is from below, the units must also be fitted on the sides of terminals 2, 4 and 6 with these phase barriers.					
		<ul style="list-style-type: none"> For 3-pole version, 2 units For 4-pole version, 1 unit 					
		3VT9300-8CE30		1	1 unit	193	0.090
		3VT9300-8CE00		1	1 unit	193	0.040
Terminal covers, degree of protection IP20							
		Increases degree of protection of connection point to IP20 when using block terminals 3VT9324-4TD30, 3VT9315-4TF30, 3VT9324-4TF30 or 3VT9303-4TF30, designed for fixed-mounted, plug-in and withdrawable versions.					
		<ul style="list-style-type: none"> 3-pole version 4-pole version 					
		3VT9300-8CB30		1	1 unit	193	0.217
		3VT9300-8CB40		1	1 unit	193	0.209
Locking devices for knob							
		Allows the switch disconnector to be locked in the "manual off" position.					
		<ul style="list-style-type: none"> Locking is by means of up to 3 padlocks with a diameter of up to 6 mm. 					
		3VT9300-3HL00		1	1 unit	193	0.026
Sealing devices							
		Sealing for:					
		<ul style="list-style-type: none"> Overcurrent releases Accessory compartment covers Terminal covers Manual operating mechanisms Motorized operating mechanisms 					
		3VT9200-8BN00		1	1 unit	193	0.001
Connecting cables							
		For connecting switch disconnector accessories for withdrawable versions (can also be used for plug-in and fixed-mounted versions)					
		3VT9300-4PL00		1	1 unit	193	0.167
Position signaling switches							
		For indicating the position of the switch disconnector in plug-in or withdrawable devices					
		3VT9300-4WL00		1	1 unit	193	0.020
Coding sets							
		Prevents use of the wrong switching unit in plug-in or withdrawable devices					
		3VT9300-4WN00		1	1 unit	193	0.005
Covers for pushbuttons							
		For motorized operating mechanisms; the cover may be equipped with a sealing device.					
		3VT9300-3MF20		1	1 unit	193	0.054

Switch Disconnectors

3VT Switch Disconnectors up to 1600 A

3VT4 switch disconnectors up to 1000 A

Selection and ordering data

Version	Rated current I_n	DT	Article No.	Price per PU	PU (UNIT, SET, M)	PS*/P. unit	PG	Weight per PU approx. kg
	A							
Switching units								
Fixed-mounted version								
	3-pole	1000	3VT4710-2DE36-0AA0		1	1 unit	193	20.410

For accessories see "3VT5 Switch Disconnectors up to 1600 A" on next page

Switch Disconnectors

3VT Switch Disconnectors up to 1600 A

3VT5 switch disconnectors up to 1600 A

Selection and ordering data

Version	Rated current I_n	DT	Article No.	Price per PU	PU (UNIT, SET, M)	PS*/P. unit	PG	Weight per PU approx. kg
A								
Switching units								
Fixed-mounted version								
	3-pole	1600	3VT5716-2DE36-0AA0		1	1 unit	193	23.000

Accessories

Auxiliary switches and shunt releases

Rated operational voltage U_s	Frequency	DT	Article No.	Price per PU	PU (UNIT, SET, M)	PS*/P. unit	PG	Weight per PU approx. kg
V	Hz							

Auxiliary switches and alarm switches

	2 x NC, 2 x NO		3VT9500-2AF10		1	1 unit	193	0.041
	60 ... 500 AC / 60 ... 240 DC	50/60	3VT9500-2AF20		1	1 unit	193	0.041
	5 ... 60 AC/DC	50/60						

Shunt releases

	24 AC/DC	50/60	3VT9500-1SF00		1	1 unit	193	0.199
	48 AC/DC	50/60	3VT9500-1SG00		1	1 unit	193	0.220
	110 AC/DC	50/60	3VT9500-1SH00		1	1 unit	193	0.220
	230 AC/220 DC	50/60	3VT9500-1SJ00		1	1 unit	193	0.237
	400 AC	50/60	3VT9500-1SK00		1	1 unit	193	0.220
	500 AC	50/60	3VT9500-1SL00		1	1 unit	193	0.220

Undervoltage releases





	24 AC/DC	50/60	3VT9500-1UF00		1	1 unit	193	0.220
	48 AC/DC	50/60	3VT9500-1UG00		1	1 unit	193	0.220
	110 AC/DC	50/60	3VT9500-1UH00		1	1 unit	193	0.220
	230 AC/220 DC	50/60	3VT9500-1UJ00		1	1 unit	193	0.220
	400 AC	50/60	3VT9500-1UK00		1	1 unit	193	0.220
	500 AC	50/60	3VT9500-1UL00		1	1 unit	193	0.220

Switch Disconnectors



3VT Switch Disconnectors up to 1600 A

3VT5 switch disconnectors up to 1600 A

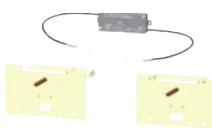
Manual operating mechanisms

Version	DT	Article No.	Price per PU	PU (UNIT, SET, M)	PS*/P. unit	PG	Weight per PU approx. kg
Rotary operating mechanisms							
 <p>Rotary operating mechanisms</p> <ul style="list-style-type: none"> Lockable with padlock 		3VT9500-3HA10		1	1 unit	193	0.230
 <p>Handle for manual operating mechanism</p> <ul style="list-style-type: none"> Lockable with padlock Black Lockable with padlock Red 		3VT9500-3HE10		1	1 unit	193	0.261
			3VT9500-3HF10		1	1 unit	193
 <p>Coupling drivers for door-coupling rotary operating mechanisms</p> <ul style="list-style-type: none"> IP44 degree of protection Degree of protection IP66 		3VT9500-3HG10		1	1 unit	193	0.265
			3VT9500-3HG20		1	1 unit	193
 <p>Extension shafts</p> <ul style="list-style-type: none"> Length 365 mm, can be shortened 		3VT9500-3HJ10		1	1 unit	193	0.352
Mechanical interlocks							
 <p>Mechanical interlock</p> <p>For manual operating mechanism For switch disconnectors, fixed-mounted versions Both switch disconnectors must be equipped with one manual operating mechanism and one knob as a minimum.</p>		3VT9500-8LA00		1	1 unit	193	0.120
 <p>Mechanical interlock by means of Bowden wire</p> <p>Mechanical interlock by means of Bowden wire is intended for withdrawable and fixed-mounted versions</p> <ul style="list-style-type: none"> For switch disconnectors, fixed-mounted versions 		3VT9500-8LC10		1	1 unit	193	0.400

Motorized operating mechanisms







Rated operational voltage U_s	Frequency	DT	Article No.	Price per PU	PU (UNIT, SET, M)	PS*/P. unit	PG	Weight per PU approx. kg
V	Hz							
Motorized operating mechanisms								
 <p>Motorized operating mechanisms</p>	110 AC/DC	50/60	3VT9500-3MN00		1	1 unit	193	4.350
	230 V AC/220 DC	50/60	3VT9500-3MQ00		1	1 unit	193	4.454
Motorized operating mechanism with counter								
 <p>Motorized operating mechanism with counter</p>	110 AC/DC	50/60	3VT9500-3MN10		1	1 unit	193	4.400
	230 V AC/220 DC	50/60	3VT9500-3MQ10		1	1 unit	193	4.400

Switch Disconnectors

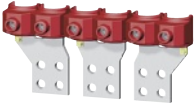
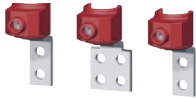
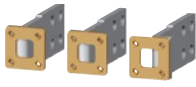
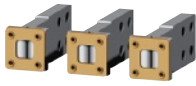
3VT Switch Disconnectors up to 1600 A

3VT5 switch disconnectors up to 1600 A

Connection accessories







Version	Max. permissible cross-section S mm ²	Cable type	DT	Article No.	Price per PU	PU (UNIT, SET, M)	PS*/P. unit	PG	Weight per PU approx. kg
Connection combinations									
	Box terminals, double In order to connect four 70 ... 240 mm ² cables, two 3VT9524-4TG30 connection combinations can be used. Not for switching unit 3VT4710-3AA30-0AA0.	2 x 70 ... 240	Cu/Al cables	3VT9524-4TG30		1	1 unit	193	1.475
	Box terminals In order to connect three 70 ... 240 mm ² cables it is possible to combine connection combinations 3VT9524-4TF30 and 3VT9524-4TF30 with one another.	70 ... 240 mm	Cu/Al cables	3VT9524-4TF30		1	1 unit	193	0.663
	Rear terminals • Up to 1000 A	--	Busbars	3VT9400-4RC30		1	1 unit	193	1.420
	• Up to 1600 A	--	Busbars	3VT9500-4RC30		1	1 unit	193	2.678
	Front terminals For withdrawable version	--	Busbars	3VT9500-4EF30		1	1 unit	193	2.730
	Rear terminals For withdrawable version	--	Busbars	3VT9500-4RD30		1	1 unit	193	3.420
	Terminals for circular conductors • For 2 cables	150 ... 300	Cu/Al cables	3VT9532-4TF30		1	1 unit	193	1.040
	• For 3 cables	150 ... 300	Cu/Al cables	3VT9533-4TF30		1	1 unit	193	1.948
	• For 4 cables	150 ... 300	Cu/Al cables	3VT9534-4TF30		1	1 unit	193	1.800

Switch Disconnectors

3VT Switch Disconnectors up to 1600 A

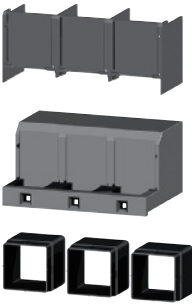
3VT5 switch disconnectors up to 1600 A

Further accessories

Version	DT	Article No.	Price per PU	PU (UNIT, SET, M)	PS*/P. unit	PG	Weight per PU approx. kg
Accessories							
 3VT9500-8CE30		Phase barriers In the case of a reversed connection (supply via terminals 2, 4 and 6) the phase barriers must also be installed on the underside. Not included in all switching units for the fixed-mounted version. <ul style="list-style-type: none"> • For switching units, fixed-mounted versions • For withdrawable versions 					
		3VT9500-8CE30 3VT9500-8CF30			1	1 unit	193
 3VT9500-8CE30		Terminal covers Increases the degree of protection to IP20. Designed for withdrawable versions with front terminals. To improve safety during maintenance of the electrical device, we recommend installation of a terminal cover on both sides of the withdrawable device. <ul style="list-style-type: none"> • For fixed-mounted versions with rear terminals • For withdrawable versions with front terminals 					
		3VT9500-8CD30 3VT9500-8CC30			1	1 unit	193
		Insulator seals Designed for fixed-mounted and withdrawable versions of switching units with rear terminals. The insulation seals are used to insulate the connection combinations for rear connection of the switchgear. Installation is recommended for all connection combinations with rear terminals. <ul style="list-style-type: none"> • For rear terminals 					
		3VT9500-8CG30 3VT9500-3HL00			1	1 unit	193
		Locking devices for knob Allows switch disconnector to be locked in the "manual off" position. For locking purposes up to three padlocks with a max. diameter of 4 ... 6 mm can be used.					
		3VT9500-8BN00			1	1 unit	193
		Sealing devices Sealing for: <ul style="list-style-type: none"> • Overcurrent releases • Accessory compartment covers 					
		3VT9500-4SA40			1	1 unit	193
		Fixing screws <ul style="list-style-type: none"> • For withdrawable versions 					
		3VT9500-3MF20			1	1 unit	193
		Covers for pushbuttons <ul style="list-style-type: none"> • In the case of motorized operating mechanisms the cover is sealable. 					
		3VT9500-3MF20			1	1 unit	193

Switch Disconnectors

3KL Switch Disconnectors with Fuses up to 800 A

Introduction

Overview

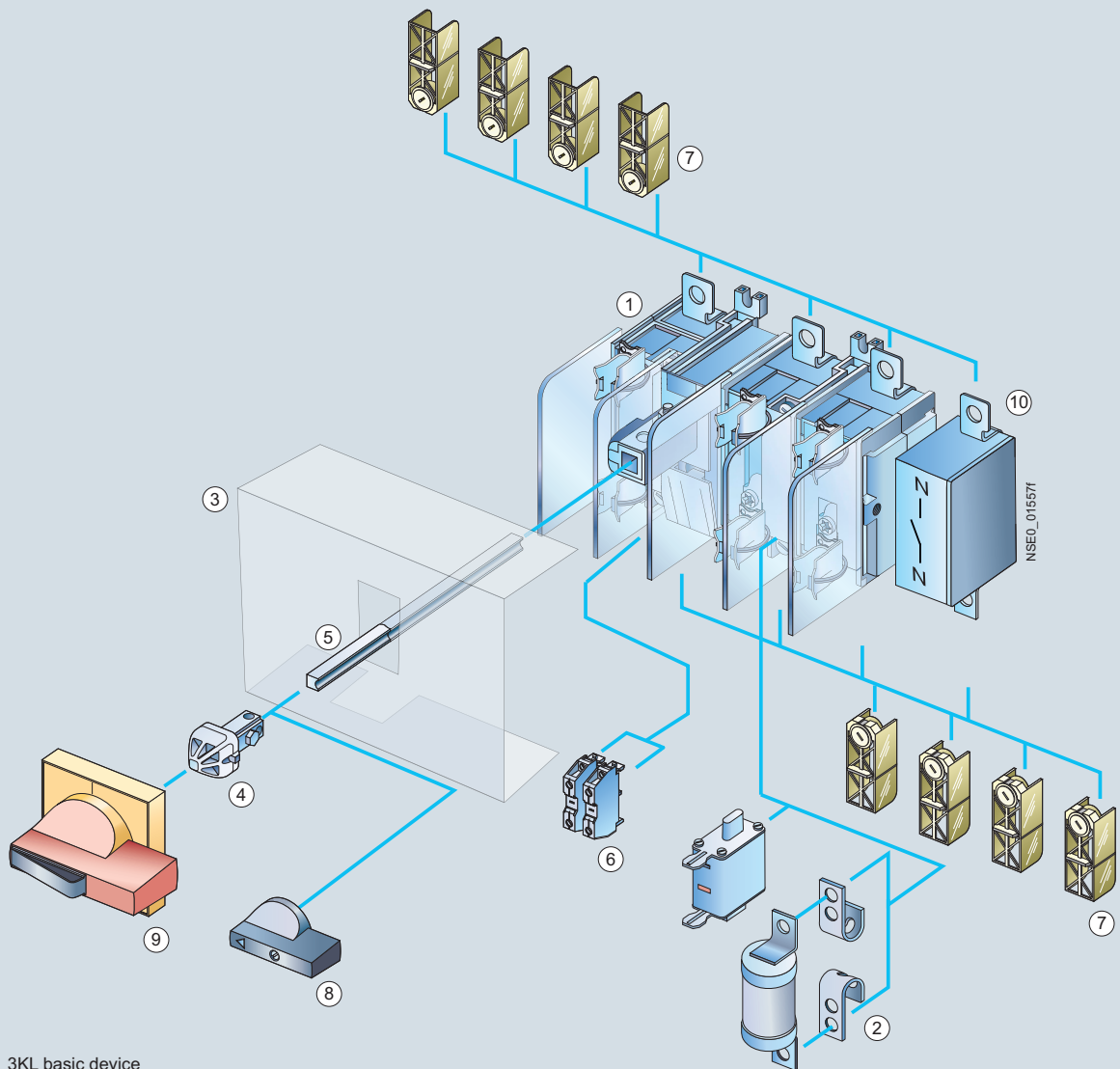

- ① 3KL basic device
- ② Fuses, optionally BS 88 or LV HRC fuses
- ③ Terminal cover, IP20 (vertical to operator side)
- ④ Coupling driver
- ⑤ Extension shaft
- ⑥ Standard products from the Siemens 3SB1 range are used as auxiliary switches.

All components from the switch to the actuator are provided with non-interchangeability features.

Optional

- ⑦ Single-pole terminal cover from 63 A to 630 A, IP20 (vertical to operator side)
- ⑧ 8UC9 knob for fixed mounting in standard version (black) or EMERGENCY-STOP version (red), or
- ⑨ 8UC7 door-coupling rotary operating mechanism in standard version (ti-grey) or EMERGENCY-STOP version (red/yellow)
- ⑩ 4th pole (optional)

All switch disconnectors feature double contact interruption and an isolating distance. As a result, the fuses of the switch disconnectors are de-energized in the OFF position. Generally all 3K.5 switch disconnectors can be secured to the shaft with padlock against unauthorized reclosing.

Identical accessories for 3KA switch disconnectors and 3KL and 3KM switch disconnectors with fuses simplify stock keeping. Please inquire about a special version with reduced values that is particularly resistant to atmospheres high in sulfur, e.g. in the paper and cellulose processing industries.

Application

3KL switch disconnectors with fuses protect against overload and short-circuits as main control and EMERGENCY-STOP switches of switchgear assemblies, distribution boards, power supply and motor outgoing feeders. In conjunction with Siemens SITOP semiconductor fuses, they are also used in UPS systems, frequency converters and capacitor control systems.

All 3K switch disconnectors are climate-proof and meet the requirements of IEC 60947-1, IEC 60947-3 and VDE 0660 Part 107.

Switch Disconnectors

3KL Switch Disconnectors with Fuses up to 800 A

Introduction

Technical specifications

Standards	IEC 60947-1, IEC 60947-3, VDE 0660 Part 107							
	Type	3KL50	3KL52 ¹⁾	3KL53 ¹⁾	3KL55 ¹⁾	3KL57 ¹⁾	3KL61 ¹⁾	3KL62 ¹⁾
Rated uninterrupted current I_u For fuse links according to DIN 43620, (when SITOR semiconductor fuses are used, a reduction of rated current is necessary, see reference to technical information at start of chapter)	A Size	63 00 and 000	125 00 and 000	160 00 and 000	250 1 and 2	400 1 and 2	630 3 and 2	800 3 and 2
Conventional free-air thermal current I_{th}²⁾	A	63	125	160	250	400	630	800
Rated insulation voltage U_i	V	690	1000	1000	1000	1000	1000	1000
Rated impulse withstand voltage U_{imp}	kV	6	8	8	8	8	8	8
Rated operational voltage U_e 50/60 Hz AC DC	V V	690 440 (3 conducting paths series-connected) 220 (2 conducting paths series-connected) ³⁾						
Rated short-circuit making capacity with fuses Peak value at 50/60 Hz 690 V AC	kA	220	220	220	176	176	105	105
Rated conditional short-circuit current with fuses At 50/60 Hz 690 V AC (rms value)	kA	100	100	100	80	80	50	50
Max. rated current I_n of the fuses	A	80	160	160	400	400	630 ⁴⁾	800
Max. permissible power loss of the installed fuse								
• NH	W	6	9	11.5	32	45	48	62
• BS	W	8 (A2/A3)	11.5 (A4)	11.5	32	45	48	60.5
Permissible let-through current of the fuses	kA	8	17	17	30 ⁵⁾	30 ⁵⁾	50	50
Max. permissible let-through I^2t value	kA ² s	55	223	223	1000	1000	5400	10500
Breaking capacity (inferred from the top or bottom)								
At 400 V AC								
• Breaking current I_c (at p.f. = 0.35, rms value)	A	500	1000	1280	2000	3200	5100	6400
• Rated operational current I_e with AC-21A, AC-22A, AC-23A	A	63	125	160	250	400	630 ⁶⁾	800 ⁶⁾
• Motor switching capacity AC-23A	kW	30	65	80	132	200	335	400
At 500 V AC								
• Breaking current I_c (at p.f. = 0.35, rms value)	A	500	1000	1280	2000	3200	5100	6400
• Rated operational current I_e with AC-21A, AC-22A, AC-23A	A	63	125	160	250	400	630 ⁶⁾	800 ⁶⁾
• Motor switching capacity AC-23A	kW	40	90	110	185	280	425	500
At 690 V AC								
• Breaking current I_c (at p.f. = 0.35, rms value)	A	500	1000	1280	2000	3200	5100	6400
• Rated operational current I_e with AC-21A, AC-22A, AC-23A	A	63	125	160	250	400	630 ⁶⁾	800 ⁶⁾
• Motor switching capacity AC-23A	kW	50	110	150	220	375	560	700
At 440 V DC (3 conducting paths series-connected) ⁷⁾								
• Breaking current I_c ($L/R = 15$ ms)	A	250	500	640	1000 ⁸⁾	1600	2520 ⁹⁾	2520 ⁹⁾
• Rated operational current I_e at DC-23A	A	63	125	160	250 ¹⁰⁾	400	630 ¹⁰⁾	630 ¹⁰⁾
Rated short-time current I_{cw} (1 s current, rms value)	kA	2.5	3.2	3.2	8	11	32	32
Permissible ambient temperature	°C °C	-25 ... +55 for operation ⁴⁾ , -50 ... +80 when stored						
Mechanical endurance , operating cycles		15000	15000	15000	12000	12000	3000	3000
Degree of protection		IP00/IP20 (from the operator side, with fuse and terminal covers)						
Power loss of the switch disconnector at I_{th} (plus power loss of the fuses)	W	8.5	22	36	33	86	140	225
Main conductor connections								
Busbar systems, max. dimensions (W x T)	mm	25 x 9	45 x 10	45 x 10	40 x 12	40 x 15	40 x 17	40 x 17
Cable lug, max. conductor cross-section (stranded)	mm ²	35	70	120	150	2 x 150 or 1 x 240	2 x 240	2 x 240
Tightening torque Terminal screws	Nm	6 ... 7.5 M6	7 ... 10 M6	18 ... 22 M8	35 ... 45 M10	35 ... 45 M10	56 M12	56 M12
Protective conductor connections								
Flat bars	mm	--	--	--	20 x 2.5	20 x 2.5	--	--
Cable lug, max. conductor cross-section (stranded)	mm ²	--	--	--	70	120	--	--

1) Technical specifications for approval on request.

2) Configuring note: Max. permissible operating temperature for fuse blades 135 °C, for connections 100 °C.

3) 110 V (one conducting path).

4) With 3KL61 for operation -25 °C ... +35 °C, at +55 °C: $I_{th} = 570$ A.

5) With 3ND1 switchgear protection fuse.

6) AC-23B.

7) 220 V DC (L1 and L3 series-connected) or 110 V DC (one conducting path) at DC-23A.

8) At 440 V $L/R = 4$ ms, at 220 V $L/R = 15$ ms.

9) Only DC-22A ($L/R = 2.5$ ms).

10) At 440 V DC-22A, at 220 V DC-23A.

Note:

For the 3KL switch disconnectors, complete kits for standard and EMERGENCY-STOP application are available for installation in the side and rear panels of control cabinets.

Switch Disconnectors



3KL Switch Disconnectors with Fuses up to 800 A

Floor mounting

Selection and ordering data

All switch disconnectors with degree of protection IP00

Conductor connecting screws and fuse partitions are generally included in the scope of supply.

Rated uninterrupted current I_u	LV HRC fuse links ¹⁾ acc. to DIN 43620 ²⁾	DT	Article No.	Price per PU	PU (UNIT, SET, M)	PS*/P. unit	PG	Weight per PU approx.
A	Size	Operational class						kg
Complete versions with 8UC7 door-coupling rotary operating mechanism (black handle)								
3-pole for NH fuse systems								
63	00 and 000	gG, aM	3KL5030-1GB01		1	1 unit	103	1.469
125	00 and 000	gG, aM	3KL5230-1GB01		1	1 unit	103	2.369
160	00 and 000	gG, aM	3KL5330-1GB01		1	1 unit	103	2.500
250	1 and 2	gG, aM	3KL5530-1GB01		1	1 unit	103	6.043
400	2 and 1	gG, aM	3KL5730-1GB01		1	1 unit	103	6.248
630 ³⁾	3 and 2	gG, aM	3KL6130-1GB00		1	1 unit	113	18.680
630 ³⁾	3 and 2 ³⁾	gG, aM ³⁾	3KL6130-1GB02		1	1 unit	113	16.207
800 ³⁾	3 and 2 ³⁾	gG, aM ³⁾	3KL6230-1GB02		1	1 unit	113	17.271
4-pole for NH fuse systems								
63	00 and 000	gG, aM	3KL5040-1GB01		1	1 unit	103	2.578
125	00 and 000	gG, aM	3KL5240-1GB01		1	1 unit	103	2.592
160	00 and 000	gG, aM	3KL5340-1GB01		1	1 unit	103	2.733
250	1 and 2	gG, aM	3KL5540-1GB01		1	1 unit	103	6.618
400	2 and 1	gG, aM	3KL5740-1GB01		1	1 unit	103	6.836
630	3 and 2	gG, aM	3KL6140-1GB00		1	1 unit	113	17.340
3-pole for fuses acc. to BS 88								
63	Form A2/A3		3KL5030-1GG01		1	1 unit	103	1.391
125	Form A2/A3		3KL5230-1GG01		1	1 unit	103	2.325
125	Form A4		3KL5230-1GJ01		1	1 unit	103	2.351
160	Form A4		3KL5330-1GJ01		1	1 unit	103	2.522
250	Form B1-B3		3KL5530-1GG01		1	1 unit	103	4.500
400	Form B1-B3		3KL5730-1GG01		1	1 unit	103	6.538
630	Form C1-C3		3KL6130-1GG00		1	1 unit	113	17.880
800	Form C1-C3		3KL6230-1GG00		1	1 unit	113	16.576
4-pole for fuses acc. to BS 88								
63	Form A2/A3		3KL5040-1GG01		1	1 unit	103	2.529
125	Form A2/A3		3KL5240-1GG01		1	1 unit	103	2.522
125	Form A4		3KL5240-1GJ01		1	1 unit	103	2.603
160	Form A4		3KL5340-1GJ01		1	1 unit	103	2.749
250	Form B1-B3		3KL5540-1GG01		1	1 unit	103	6.616
400	Form B1-B3		3KL5740-1GG01		1	1 unit	103	7.090
630	Form C1-C3		3KL6140-1GG00		1	1 unit	113	16.996
Basic switch versions without handle								
3-pole for NH fuse systems								
	63	00 and 000	gG, aM	▶ 3KL5030-1AB01	1	1 unit	103	1.014
	125	00 and 000	gG, aM	▶▶ 3KL5230-1AB01	1	1 unit	103	1.965
	160	00 and 000	gG, aM	▶▶▶ 3KL5330-1AB01	1	1 unit	103	2.140
	250	1 and 2	gG, aM	▶▶▶▶ 3KL5530-1AB01	1	1 unit	103	5.344
	400	2 and 1	gG, aM	▶▶▶▶▶ 3KL5730-1AB01	1	1 unit	103	5.390
	630 ³⁾	3 and 2	gG, aM	▶▶▶▶▶▶ 3KL6130-1AB0	1	1 unit	113	17.640
	630 ³⁾	3 and 2 ³⁾	gG, aM ³⁾	▶▶▶▶▶▶▶ 3KL6130-1AB02	1	1 unit	113	14.720
	800 ³⁾	3 and 2 ³⁾	gG, aM ³⁾	▶▶▶▶▶▶▶▶ 3KL6230-1AB02	1	1 unit	113	16.120
4-pole for NH fuse systems								
	63	00 and 000	gG, aM	3KL5040-1AB01	1	1 unit	103	2.169
	125	00 and 000	gG, aM	3KL5240-1AB01	1	1 unit	103	2.125
	160	00 and 000	gG, aM	3KL5340-1AB01	1	1 unit	103	2.344
	250	1 and 2	gG, aM	3KL5540-1AB01	1	1 unit	103	5.577
	400	2 and 1	gG, aM	3KL5740-1AB01	1	1 unit	103	5.880
	630	3 and 2	gG, aM	3KL6140-1AB00	1	1 unit	113	16.520
3-pole for fuses acc. to BS 88								
	63	Form A2/A3		3KL5030-1AG01	1	1 unit	103	0.975
	125	Form A2/A3		3KL5230-1AG01	1	1 unit	103	1.939
	125	Form A4		3KL5230-1AJ01	1	1 unit	103	1.975
	160	Form A4		3KL5330-1AJ01	1	1 unit	103	2.170
	250	Form B1-B3		3KL5530-1AG01	1	1 unit	103	5.051
	400	Form B1-B3		3KL5730-1AG01	1	1 unit	103	5.666
	630	Form C1-C3		3KL6130-1AG00	1	1 unit	113	15.075
	800	Form C1-C3		3KL6230-1AG00	1	1 unit	113	10.100

Fuse monitoring through 5TT3170 safety monitor with a floating 1 NO signaling contact, see chapter 5 "Fuse Systems".

Footnotes see page 7/71.

Switch Disconnectors

3KL Switch Disconnectors with Fuses up to 800 A

Floor mounting

Rated uninterrupted current I_U	LV HRC fuse links ¹⁾ acc. to DIN 43620 ²⁾		DT	Article No.	Price per PU	PU (UNIT, SET, M)	PS*/P. unit	PG	Weight per PU approx. kg
	Size	Operational class							
4-pole for fuses acc. to BS 88									
63	Form A2/A3			3KL5040-1AG01		1	1 unit	103	2.075
125	Form A2/A3			3KL5240-1AG01		1	1 unit	103	2.161
125	Form A4			3KL5240-1AJ01		1	1 unit	103	2.230
160	Form A4			3KL5340-1AJ01		1	1 unit	103	2.390
250	Form B1-B3			3KL5540-1AG01		1	1 unit	103	5.624
400	Form B1-B3			3KL5740-1AG01		1	1 unit	103	6.134
630	Form C1-C3			3KL6140-1AG00		1	1 unit	113	17.020
8UC7 EMERGENCY-STOP door-coupling rotary operating mechanisms (red handle, yellow indicator plate) for basic switch versions without handle									
3-pole for NH fuse systems									
63	00 and 000	gG, aM		8UC7121-3BB10		1	1 unit	103	0.368
125	00 and 000	gG, aM		8UC7222-3BB20		1	1 unit	103	0.423
160	00 and 000	gG, aM		8UC7222-3BB20		1	1 unit	103	0.423
250	1 and 2	gG, aM		8UC7323-3BB30		1	1 unit	103	1.016
400	2 and 1	gG, aM		8UC7323-3BB30		1	1 unit	103	1.016
630	3 and 2	gG, aM		8UC7424-3BB44		1	1 unit	103	1.120
				+					
				8UC9253		1	1 unit	103	0.113
800	3 and 2	gG, aM		8UC7424-3BB44		1	1 unit	103	1.120
				+					
				8UC9253		1	1 unit	103	0.113
4-pole for NH fuse systems									
63	00 and 000	gG, aM		8UC7222-3BB20		1	1 unit	103	0.423
125	00 and 000	gG, aM		8UC7222-3BB20		1	1 unit	103	0.423
160	00 and 000	gG, aM		8UC7222-3BB20		1	1 unit	103	0.423
250	1 and 2	gG, aM		8UC7323-3BB30		1	1 unit	103	1.016
400	2 and 1	gG, aM		8UC7323-3BB30		1	1 unit	103	1.016
630	3 and 2	gG, aM		8UC7424-3BB44		1	1 unit	103	1.120
				+					
				8UC9253		1	1 unit	103	0.113
3-pole for fuses acc. to BS 88									
63	Form A2/A3			8UC7121-3BB10		1	1 unit	103	0.368
125	Form A2/A3			8UC7222-3BB20		1	1 unit	103	0.423
125	Form A4			8UC7222-3BB20		1	1 unit	103	0.423
160	Form A4			8UC7222-3BB20		1	1 unit	103	0.423
250	Form B1-B3			8UC7323-3BB30		1	1 unit	103	1.016
400	Form B1-B3			8UC7323-3BB30		1	1 unit	103	1.016
630	Form C1-C3			8UC7424-3BB44		1	1 unit	103	1.120
				+					
				8UC9253		1	1 unit	103	0.113
800	Form C1-C3			8UC7424-3BB44		1	1 unit	103	1.120
				+					
				8UC9253		1	1 unit	103	0.113
4-pole for fuses acc. to BS 88									
63	Form A2/A3			8UC7222-3BB20		1	1 unit	103	0.423
125	Form A2/A3			8UC7222-3BB20		1	1 unit	103	0.423
125	Form A4			8UC7222-3BB20		1	1 unit	103	0.423
160	Form A4			8UC7222-3BB20		1	1 unit	103	0.423
250	Form B1-B3			8UC7323-3BB30		1	1 unit	103	1.016
400	Form B1-B3			8UC7323-3BB30		1	1 unit	103	1.016
630	Form C1-C3			8UC7424-3BB44		1	1 unit	103	1.120
				+					
				8UC9253		1	1 unit	103	0.113



3KL5240-1AJ01 with fuses



8UC7121-3BB10

Fuse monitoring through 5TT3170 safety monitor with a floating 1 NO signaling contact, see chapter 5 "Fuse Systems".

Footnotes for page 7/70 and page 7/71:

- Silver-plated fuse blades. Silver-plated isolating blades can be used if desired.
- For the assignment of semiconductor fuses see page 7/75.
- With SITOR 3NE fuse links eNus-approved.

Switch Disconnectors

3KL Switch Disconnectors with Fuses up to 800 A

Front mounting

Selection and ordering data

All switch disconnectors with degree of protection IP00

Conductor connecting screws and fuse partitions are generally included in the scope of supply.

Rated uninterrupted current I_u	LV HRC fuse links ¹⁾ acc. to DIN 43620 ²⁾	DT	Article No.	Price per PU	PU (UNIT, SET, M)	PS*/ P. unit	PG	Weight per PU approx.
	Size	Operational class						kg
A								
Assembly kits (IP40) comprising: lockable handle, cover for NH fuse systems (locked in ON state) and three terminal covers for infeed side for basic switch versions without handle								
3-pole, assembly kits for mounting in control cabinet side panels								
• Black handle								
63	00	gG, aM	3KX3516-3AA		1	1 unit	103	0.667
125	00	gG, aM	3KX3526-3AA		1	1 unit	103	0.840
160	00	gG, aM	3KX3536-3AA		1	1 unit	103	0.850
250	1 and 2	gG, aM	3KX3556-3AA		1	1 unit	103	1.700
400	2 and 1	gG, aM	3KX3556-3AA		1	1 unit	103	1.700
• EMERGENCY-STOP red handle								
63	00	gG, aM	3KX3516-3BA		1	1 unit	103	0.590
125	00	gG, aM	3KX3526-3BA		1	1 unit	103	0.800
160	00	gG, aM	3KX3536-3BA		1	1 unit	103	0.870
250	1 and 2	gG, aM	3KX3556-3BA		1	1 unit	103	1.670
400	2 and 1	gG, aM	3KX3556-3BA		1	1 unit	103	1.670

Fuse monitoring through 5TT3170 safety monitor with a floating 1 NO signaling contact, see chapter 5 "Fuse Systems".

¹⁾ Silver-plated fuse blades. Silver-plated isolating blades can be used if desired.







²⁾ For the assignment of semiconductor fuses see page 7/75.

Switch Disconnectors

3KL Switch Disconnectors with Fuses up to 800 A

Accessories

Selection and ordering data

Version	DT	Article No.	Price per PU	PU (UNIT, SET, M)	PS*/P. unit	PG	Weight per PU approx. kg
3KL5030							
 3KL5030-3DA01		Terminal covers For 3-pole devices (1 set = 6 units)	▶	3KX3552-3DA01	1	1 unit	103 0.078
 3KL5030-3AA		Fuse covers (interlock only detachable in the OFF position)	▶	3KX3517-3AA	1	1 unit	103 0.041
		Cover IP20 For 3-pole devices	▶	3KX3507-0CA02	1	1 unit	103 0.530
		Fuse partitions (1 set = 5 units)	▶	3KX3507-0AA01	1	1 unit	103 0.040
 3KL5030-0BA01		Lyre-shaped fuse covers (1 set = 6 units)		3KX3507-0BA01	1	1 unit	103 0.030
		Door-coupling rotary operating mechanisms IP65 Black handle, shaft 300 mm		8UC7111-1BB10	1	1 unit	103 0.358
		EMERGENCY-STOP (yellow/red), shaft 300 mm		8UC7121-3BB10	1	1 unit	103 0.368
		Operating mechanisms for fixed mounting Black handle, shaft 250 mm	▶	3KX3516-1AA	1	1 unit	103 0.102
		Extension shaft 300 mm long		8UC6031	1	1 unit	103 0.068
		Extension shaft 600 mm long		8UC6081	1	1 unit	103 0.136
		Shaft connecting pieces		8UC6021	1	1 unit	103 0.027
		Auxiliary switches 1 NO + 1 NC		3SB1400-0A	1	1 unit	41J 0.019
		2 NO		3SB1400-0G	1	1 unit	41J 0.019
		2 NC		3SB1400-0H	1	1 unit	41J 0.020
 3KL5030-0AA		Fuse monitor connections (1 set = 6 units)		3KX3505-0AA	1	1 unit	103 0.021
3KL5040/3KL52/3KL53							
 3KL5040-3DA01		Terminal covers For 3-pole devices (1 set = 6 units)		3KX3552-3DA01	1	1 unit	103 0.078
		• 3KL52	▶	3KX3552-3DA01	1	1 unit	103 0.078
		• 3KL53	▶	3KX3553-3DA01	1	1 unit	103 0.151
		For 4-pole devices (1 set = 8 units)		3KX3552-3DB01	1	1 unit	103 0.096
		• 3KL5040, 3KL52		3KX3553-3DB01	1	1 unit	103 0.167
		• 3KL53		3KX3553-3DB01	1	1 unit	103 0.167
 3KL5040-3AA		Fuse covers¹⁾ (interlock only detachable in the OFF position)	▶	3KX3527-3AA	1	1 unit	103 0.070
		Cover IP20 For 3KL52 3-pole devices	▶	3KX3527-0CA02	1	1 unit	103 0.745
		Cover IP20 For 3KL53 3-pole devices	▶	3KX3537-0CA02	1	1 unit	103 0.725
		Fuse partitions (1 set = 5 units)	▶	3KX3507-0AA01	1	1 unit	103 0.040
 3KL5040-0BA01		Lyre-shaped fuse covers (1 set = 6 units)		3KX3507-0BA01	1	1 unit	103 0.030

¹⁾ Für 3KX3527-3AA: Not suitable for use with type A4 BS fuses.

Switch Disconnectors

3KL Switch Disconnectors with Fuses up to 800 A

Accessories

Version	DT	Article No.	Price per PU	PU (UNIT, SET, M)	PS*/P. unit	PG	Weight per PU approx. kg
Door-coupling rotary operating mechanisms IP65							
Black handle, shaft 300 mm		8UC7212-1BB20		1	1 unit	103	0.404
EMERGENCY-STOP (yellow/red), shaft 300 mm		8UC7222-3BB20		1	1 unit	103	0.423
Operating mechanisms for fixed mounting							
Black handle, shaft 250 mm	▶	3KX3536-1AA		1	1 unit	103	0.150
Extension shaft 300 mm long							
		8UC6032		1	1 unit	103	0.135
Extension shaft 600 mm long							
		8UC6082		1	1 unit	103	0.265
Shaft connecting pieces							
		8UC6022		1	1 unit	103	0.022
Auxiliary switches							
1 NO + 1 NC		3SB1400-0A		1	1 unit	41J	0.019
2 NO		3SB1400-0G		1	1 unit	41J	0.019
2 NC		3SB1400-0H		1	1 unit	41J	0.020
1 NO + 1 NC, 20 ms leading		3KX3552-3EA01		1	1 unit	103	0.022
Fuse monitor connections							
(1 set = 6 units)		3KX3505-0AA		1	1 unit	103	0.021
3KL55/3KL57							
Terminal covers							
For 3-pole devices (1 set = 6 units)	▶	3KX3557-3DA01		1	1 unit	103	0.293
For 4-pole devices (1 set = 8 units)		3KX3557-3DB01		1	1 unit	103	0.370
Fuse covers							
(interlock only detachable in the OFF position)	▶	3KX3557-3AA		1	1 unit	103	0.231
Cover IP20							
For 3-pole devices	▶	3KX3557-0CA02		1	1 unit	103	1.255
Fuse partitions							
(1 set = 5 units)	▶	3KX3557-0AA01		1	1 unit	103	0.122
Door-coupling rotary operating mechanisms IP65							
Black handle, shaft 300 mm		8UC7313-1BB30		1	1 unit	103	0.998
EMERGENCY-STOP (yellow/red), shaft 300 mm		8UC7323-3BB30		1	1 unit	103	1.016
Operating mechanisms for fixed mounting, size 3							
Black handle, shaft 250 mm	▶	3KX3176-1E		1	1 unit	103	0.287
Extension shaft 300 mm long							
		8UC6033		1	1 unit	103	0.215
Extension shaft 600 mm long							
		8UC6083		1	1 unit	103	0.424
Shaft connecting pieces							
		8UC6023		1	1 unit	103	0.083
Auxiliary switches							
1 NO + 1 NC		3SB1400-0A		1	1 unit	41J	0.019
2 NO		3SB1400-0G		1	1 unit	41J	0.019
2 NC		3SB1400-0H		1	1 unit	41J	0.020
1 NO + 1 NC, 20 ms leading		3KX3552-3EA01		1	1 unit	103	0.022
Fuse monitor connections							
(1 set = 6 units)		3KX3505-0AA		1	1 unit	103	0.021
3KL61/3KL62							
Terminal covers							
For 3-pole devices (1 set = 6 units)	▶	3KX3561-3DA01		1	1 unit	103	0.282
For 4-pole devices (1 set = 8 units)		3KX3561-3DB01		1	1 unit	103	0.380
Fuse covers							
Cover plate		3KX3561-0AA00		1	1 unit	113	0.376
Complete covers ¹⁾		3KX3561-1AA00		1	1 unit	113	0.408
Door-coupling rotary operating mechanisms IP65							
Black handle, shaft 300 mm		8UC7414-1BB44		1	1 unit	103	1.159
	▶	+ 8UC9253		1	1 unit	103	0.113
EMERGENCY-STOP (yellow/red), shaft 300 mm		8UC7424-3BB44		1	1 unit	103	1.120
	▶	+ 8UC9253		1	1 unit	103	0.113
Operating mechanisms for fixed mounting, size 5							
Black handle, shaft 250 mm	▶	3KX3616-1A		1	1 unit	103	0.500
Extension shaft 300 mm long							
		8UC6034		1	1 unit	103	0.316
Extension shaft 600 mm long							
		8UC6084		1	1 unit	103	0.628
Shaft connecting pieces							
		8UC6024		1	1 unit	103	0.078
Auxiliary switches²⁾							
1 NO + 1 NC		3KX3612-1B		1	1 unit	113	0.130

¹⁾ Only for NH fuse systems

²⁾ For more 3SB3400-0. contact blocks with other contact types, see IC 10 catalog, chapter 10 "Pushbutton Units and Indicator Lights"

Switch Disconnectors

3KL Switch Disconnectors with Fuses up to 800 A

Fuses

Overview

The 3KL switch disconnectors with fuses are suitable for all fuses in LV HRC design, [see chapter 5](#). SITOR semiconductor fuses in LV HRC design can also be used, although it must be noted that, compared to cable and line protection fuses, these get much hotter during operation. For this reason, the fuse must be operated below the rated current I_n of the device (derating) when installed in a closed switching device.

The following table shows the permissible load currents of the SITOR semiconductor fuses for installation in 3KL. The values were determined using the conductor cross-sections specified in the table.

Note

If using smaller cross-sections, a considerably higher derating is required due to the lower heat dissipation.

SITOR semiconductor fuses for 3KL fuse switch disconnectors: Assignment table

SITOR semiconductor fuse data						Permissible load currents of fuse when installed in 3KL for floor mounting					
Type ¹⁾	Rated current I_n	Rated voltage ²⁾	Operational class	Size	Required conductor cross-section Cu mm ²	Type 3KL			Alternative type - 3KL		
						Type	Size	Permissible load current ³⁾	Type	Size	Permissible load current ³⁾
	A	V AC					A			A	
3NC423..	150	500	gR	3	70	3KL61	3	145	3KL62	3	150
3NC425..	200	500	gR	3	95	3KL61	3	180	3KL62	3	190
3NC427..	250	500	gR	3	120	3KL61	3	225	3KL62	3	240
3NC428..	300	500	gR	3	185	3KL61	3	255	3KL62	3	270
3NC431..	350	500	gR	3	240	3KL61	3	330	3KL62	3	345
3NC432..	400	500	aR	3	240	3KL61	3	400	3KL62	3	400
3NC3336-1	630	1000	aR	3	2x (40x5)	3KL62	3	500	3KL61	3	480
3NC3337-1	710	1000	aR	3	2x (50x5)	3KL62	3	540	--	--	--
3NC3338-1	800	1000	aR	3	2x (40x8)	3KL62	3	600	--	--	--
3NC3340-1	900	1000	aR	3	2x (40x8)	3KL62	3	650	--	--	--
3NC3341-1	1000	1000	aR	3	2x (50x8)	3KL62	3	720	--	--	--
3NC3342-1	1100	800	aR	3	2x (50x8)	3KL62	3	800	--	--	--
3NC3343-1	1250	800	aR	3	2x (50x8)	3KL62	3	800	--	--	--
3NC3430-1	315	1250	aR	3	2x95	3KL61	3	285	3KL62	3	300
3NC3432-1	400	1250	aR	3	2x120	3KL61	3	365	3KL62	3	380
3NC3434-1	500	1250	aR	3	2x150	3KL61	3	425	3KL62	3	450
3NC3436-1	630	1250	aR	3	2x (40x5)	3KL61	3	500	3KL62	3	540
3NC3438-1	800	1100	aR	3	2x (40x8)	3KL62	3	650	--	--	--
3NC8423..	150	660	gR	3	70	3KL61	3	135	3KL62	3	140
3NC8425..	200	660	gR	3	95	3KL61	3	180	3KL62	3	190
3NC8427..	250	660	gR	3	120	3KL61	3	225	3KL62	3	240
3NC8431..	350	660	gR	3	240	3KL61	3	300	3KL62	3	315
3NC8434..	500	660	gR	3	2x 150	3KL61	3	425	3KL62	3	450
3NC8444..	1000	600	aR	3	2x (60x6)	3KL62	3	800	3KL61	3	630
3NE1020-2	80	690	gR	00	25	3KL52	00	80	3KL53	00	80
3NE1021-0	100	690	gS	00	35	3KL52	00	100	3KL53	00	100
3NE1021-2	100	690	gR	00	35	3KL52	00	100	3KL53	00	100
3NE1022-0	125	690	gS	00	50	3KL52	00	125	3KL53	00	125
3NE1022-2	125	690	gR	00	50	3KL52	00	125	3KL53	00	125
3NE1224-0	160	690	gS	1	70	3KL55	1	160	3KL57	2	160
3NE1224-2/-3	160	690	gR	1	70	3KL55	1	160	3KL57	2	160
3NE1225-0	200	690	gS	1	95	3KL55	1	200	3KL57	2	200
3NE1225-2/-3	200	690	gR	1	95	3KL55	1	200	3KL57	2	200
3NE1227-0	250	690	gS	1	120	3KL55	1	250	3KL57	2	250
3NE1227-2/-3	250	690	gR	1	120	3KL55	1	245	3KL57	2	250
3NE1230-0	315	690	gS	1	2x 70	3KL57	2	315	--	--	--
3NE1230-2/-3	315	690	gR	1	2x 70	3KL57	2	280	--	--	--
3NE1331-0	350	690	gS	2	2x 95	3KL57	2	330	3KL61	3	350
3NE1331-2/-3	350	690	gR	2	2x 95	3KL57	2	300	3KL61	3	350
3NE1332-0	400	690	gS	2	2x 95	3KL57	2	375	3KL61	3	400
3NE1332-2/-3	400	690	gR	2	2x 95	3KL57	2	340	3KL61	3	400
3NE1333-0	450	690	gS	2	2x 120	3KL61	3	450	3KL62	3	450
3NE1333-2/-3	450	690	gR	2	2x 120	3KL61	3	450	3KL62	3	450
3NE1334-0	500	690	gS	2	2x 120	3KL61	3	500	3KL62	3	500
3NE1334-2/-3	500	690	gR	2	2x 120	3KL61	3	500	3KL62	3	500
3NE1435-0	560	690	gS	3	2x 150	3KL61	3	560	3KL62	3	560
3NE1435-2/-3	560	690	gR	3	2x 150	3KL61	3	560	3KL62	3	560

Switch Disconnectors

3KL Switch Disconnectors with Fuses up to 800 A

Fuses

SITOR semiconductor fuse data						Permissible load currents of fuse when installed in 3KL for floor mounting					
Type ¹⁾	Rated current I_n A	Rated voltage ²⁾ V AC	Operational class	Size	Required conductor cross-section Cu mm ²	Type 3KL			Alternative type - 3KL		
						Type	Size	Permissible load current ³⁾ A	Type	Size	Permissible load current ³⁾ A
3NE1436-0	630	690	gS	3	2x 185	3KL61	3	630	3KL62	3	630
3NE1436-2/-3	630	690	gR	3	2x 185	3KL61	3	615	3KL62	3	630
3NE1437-0	710	690	gS	3	2x (40x5)	3KL61	3	630	3KL62	3	710
3NE1437-1	710	600	gR	3	2x (40x5)	3KL61	3	630	3KL62	3	710
3NE1437-2/-3	710	690	gR	3	2x (40x5)	3KL61	3	630	3KL62	3	700
3NE1438-0	800	690	gS	3	2x (50x5)	3KL61	3	630	3KL62	3	800
3NE1438-1	800	600	gR	3	2x (50x5)	3KL61	3	630	3KL62	3	800
3NE1438-2/-3	800	690	gR	3	2x (50x5)	3KL61	3	630	3KL62	3	760
3NE1447-2/-3	670	690	gR	3	2x (40x5)	3KL61	3	630	3KL62	3	670
3NE1448-2/-3	850	690	gR	3	2x (40x8)	3KL61	3	630	3KL62	3	790
3NE1802-0	40	690	gS	000	10	3KL50	00	40	3KL52	00	40
3NE1803-0	35	690	gS	000	6	3KL50	00	35	3KL52	00	35
3NE1813-0	16	690	gS	000	1.5	3KL50	00	16	3KL52	00	16
3NE1814-0	20	690	gS	000	2.5	3KL50	00	20	3KL52	00	20
3NE1815-0	25	690	gS	000	4	3KL50	00	25	3KL52	00	25
3NE1817-0	50	690	gS	000	10	3KL50	00	50	3KL52	00	50
3NE1818-0	63	690	gS	000	16	3KL50	00	63	3KL52	00	63
3NE1820-0	80	690	gS	000	25	3KL52	00	80	--	--	--
3NE3221	100	1000	aR	1	35	3KL55	1	90	3KL57	2	95
3NE3222	125	1000	aR	1	50	3KL55	1	110	3KL57	2	115
3NE3224	160	1000	aR	1	70	3KL55	1	140	3KL57	2	150
3NE3225	200	1000	aR	1	95	3KL55	1	175	3KL57	2	180
3NE3227	250	1000	aR	1	120	3KL55	1	210	3KL57	2	220
3NE3230-0B	315	1000	aR	1	185	3KL57	2	240	--	--	--
3NE3231	350	1000	aR	1	240	3KL57	2	265	--	--	--
3NE3232-0B	400	1000	aR	1	240	3KL57	2	290	--	--	--
3NE3233	450	1000	aR	1	2x 150	3KL57	2	320	--	--	--
3NE3332-0B	400	1000	aR	2	240	3KL61	3	340	3KL62	3	360
3NE3333	450	1000	aR	2	2x 150	3KL61	3	380	3KL62	3	400
3NE3334-0B	500	1000	aR	2	2x 150	3KL61	3	440	3KL62	3	470
3NE3335	560	1000	aR	2	2x 185	3KL61	3	500	3KL62	3	530
3NE3336	630	1000	aR	2	2x 185	3KL61	3	540	3KL62	3	580
3NE3337-8	710	900	aR	2	2x (40x5)	3KL61	3	600	3KL62	3	640
3NE3338-8	800	800	aR	2	2x 240	3KL61	3	630	3KL62	3	720
3NE3340-8	900	690	aR	2	2x (40x8)	3KL61	3	630	3KL62	3	800
3NE4101	32	1000	gR	0	6	3KL55	1	32	--	--	--
3NE4102	40	1000	gR	0	10	3KL55	1	40	--	--	--
3NE4117	50	1000	gR	0	10	3KL55	1	50	--	--	--
3NE4118	63	1000	aR	0	16	3KL55	1	63	--	--	--
3NE4120	80	1000	aR	0	25	3KL55	1	80	--	--	--
3NE4121	100	1000	aR	0	35	3KL55	1	95	--	--	--
3NE4122	125	1000	aR	0	50	3KL55	1	120	--	--	--
3NE4124	160	1000	aR	0	70	3KL55	1	150	--	--	--
3NE4327-0B	250	800	aR	2	150	3KL57	2	175	3KL61	3	200
3NE4330-0B	315	800	aR	2	240	3KL57	2	230	3KL61	3	260
3NE4333-0B	450	800	aR	2	2x (30x5)	3KL57	2	340	3KL61	3	370
3NE4334-0B	500	800	aR	2	2x (30x5)	3KL61	3	425	3KL62	3	450
3NE4337	710	800	aR	2	2x (50x5)	3KL61	3	600	3KL62	3	630
3NE8015-1	25	690	gR	00	4	3KL50	00	25	3KL52	00	25
3NE8003-1	35	690	gR	00	6	3KL50	00	33	3KL52	00	35
3NE8017-1	50	690	gR	00	10	3KL50	00	45	3KL52	00	50
3NE8018-1	63	690	gR	00	16	3KL50	00	54	3KL52	00	60
3NE8020-1	80	690	aR	00	25	3KL52	00	68	--	--	--
3NE8021-1	100	690	aR	00	35	3KL52	00	89	--	--	--
3NE8022-1	125	690	aR	00	50	3KL52	00	106	--	--	--
3NE8024-1	160	690	aR	00	70	3KL52	00	130 ⁴⁾	--	--	--

¹⁾ Due to the mechanical stress on the relatively long fuse blades, SITOR 3NE41 semiconductor fuses should only be switched occasionally and only at zero current.

²⁾ Fuses with a rated voltage of >690 V may only be operated at max. 690 V (rated voltage of the 3KL) when installed in 3KL.

³⁾ In the case of cyclic loads, the currents may have to be further reduced (precise values on request).

⁴⁾ The fuse can also be operated at a higher rated uninterrupted current than the 125 A current of the 3KL52. However, in this case, the 3KL52 must not be switched under load (utilization category AC-20)

Overview

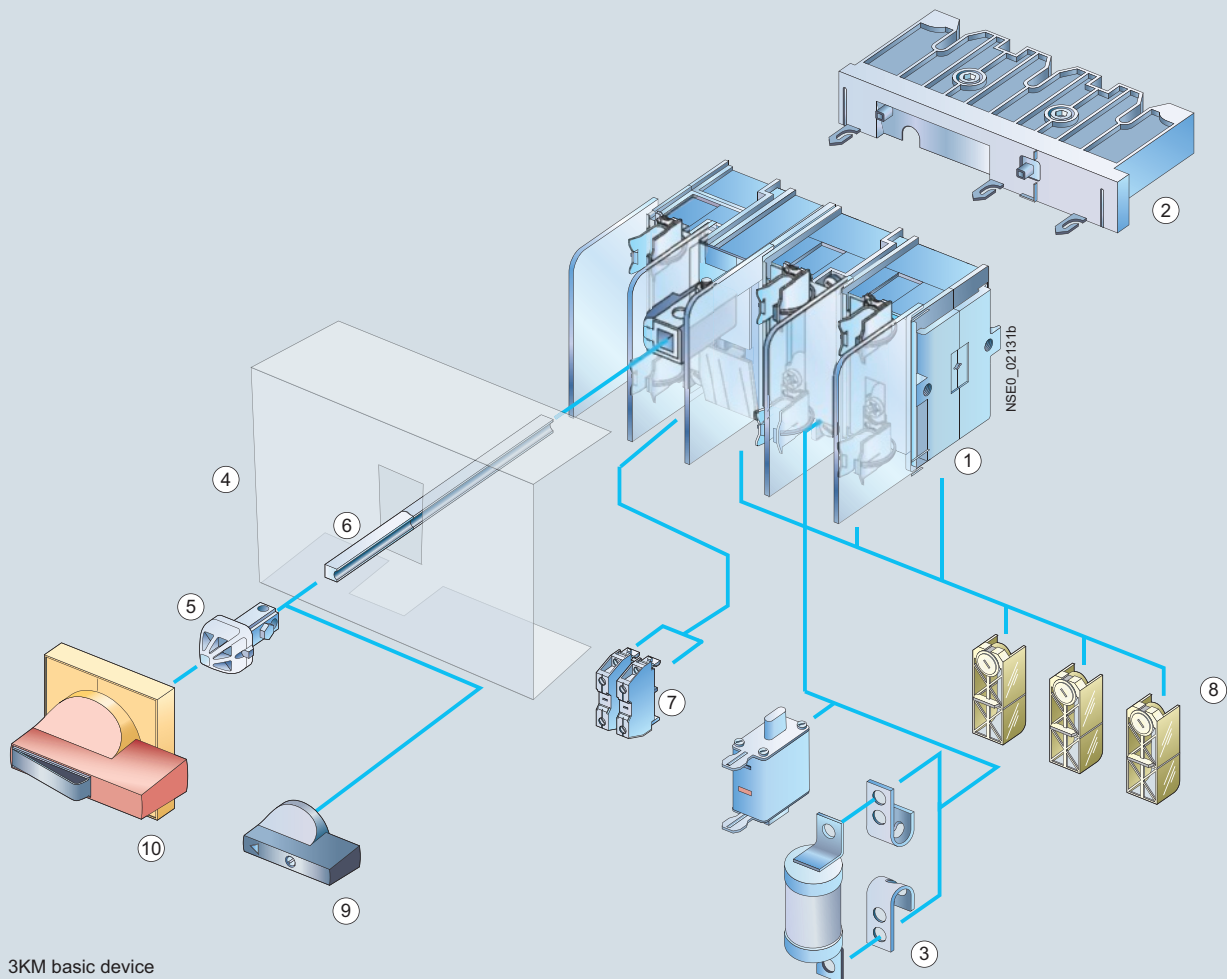

- ① 3KM basic device
- ② Plug-in contact strip for 3KM (part of basic device)
- ③ Fuses, optionally BS 88 or LV HRC fuses
- ④ Terminal cover, IP20 (vertical to operator side)
- ⑤ Coupling driver
- ⑥ Extension shaft
- ⑦ Standard products from the Siemens 3SB1 range are used as auxiliary switches.

All components from the switch to the actuator are provided with non-interchangeability features.

Optional

- ⑧ Single-pole terminal cover from 63 A to 630 A, IP20 (vertical to operator side)
- ⑨ 8UC9 knob for fixed mounting in standard version (black) or EMERGENCY-STOP version (red), or
- ⑩ 8UC7 door-coupling rotary operating mechanism in standard version (ti-grey) or EMERGENCY-STOP version (red/yellow)

All switch disconnectors feature double contact interruption and an isolating distance. As a result, the fuses are de-energized when the switch disconnectors are in the disconnected position.

The 3KM switch disconnectors with fuses also feature an isolating plug connector. This facilitates mounting and contact establishment in motor control centers (MCCs) in conjunction with vertical busbars. Generally all 3K.5 switch disconnectors can be

secured to the shaft with padlock against unauthorized reclosing.

Identical accessories for 3KA switch disconnectors and for 3KL and 3KM switch disconnectors with fuses simplify stock keeping.

Please inquire about a special variant with reduced values that is particularly resistant to atmospheres high in sulfur, e.g. in the paper and cellulose processing industries.

Application

3KM switch disconnectors with fuses protect against overload and short-circuits as main control and EMERGENCY-STOP switches of switchgear assemblies, distribution boards, power supply and motor outgoing feeders.

In conjunction with SITOR semiconductor fuses, they are also used in UPS systems, frequency converters and capacitor control systems.

All 3K switch disconnectors are climate-proof and meet the requirements of IEC 60947-1, IEC 60947-3 and VDE 0660 Part 107.

Switch Disconnectors

3KM Switch Disconnectors with Fuses and Isolating Plug Connector up to 400 A

Introduction

Technical specifications

Standards	IEC 60947-1, IEC 60947-3, VDE 0660 Part 107					
	Type	3KM50	3KM52	3KM53	3KM55	3KM57
Rated uninterrupted current I_u For fuse links according to DIN 43620, (when SITOR semiconductor fuses are used, a reduction of rated current is necessary, see reference to technical information at start of chapter)	A Size	63 00 and 000	125 00 and 000	160 00 and 000	250 1 and 2	400 1 and 2
Conventional free-air thermal current $I_{th}^{(1)}$	A	63	125	160	250	400
Rated insulation voltage U_i	V	690	1000	1000	1000	1000
Rated impulse withstand voltage U_{imp}	kV	6	8	8	8	8
Rated operational voltage U_e						
50/60 Hz AC	V	690				
DC	V	440 (3 conducting paths series-connected)				
	V	220 (2 conducting paths series-connected) ²⁾				
Rated short-circuit making capacity with fuses (peak value, at 50/60 Hz 690 V AC)	kA	220	220	220	176	176
Rated conditional short-circuit current with fuses At 50/60 Hz 690 V AC (rms value)	kA	100	100	100	80	80
Max. rated current I_n of the fuses	A	80	160	160	400	400
Max. permissible power loss of the installed fuse						
• NH	W	6	9	11.5	32	45
• BS	W	8 (A2/A3)	11.5 (A4)	11.5	32	45
Permissible let-through current of the fuses	kA	8	17	17	30 ³⁾	30 ³⁾
Maximum permissible let-through I^2t value	kA ² s	55	223	223	1000	1000
Breaking capacity (infeed from the top or bottom)						
At 400 V AC						
• Breaking current I_c (at p.f. = 0.35, rms value)	A	500	1000	1280	2000	3200
• Rated operational current I_e with AC-21A, AC-22A, AC-23A	A	63	125	160	250	400
• Motor switching capacity AC-23A	kW	30	65	80	132	200
At 500 V AC						
• Breaking current I_c (at p.f. = 0.35, rms value)	A	500	1000	1280	2000	3200
• Rated operational current I_e with AC-21A, AC-22A, AC-23A	A	63	125	160	250	400
• Motor switching capacity AC-23A	kW	40	90	110	185	280
At 690 V AC						
• Breaking current I_c (at p.f. = 0.35, rms value)	A	500	1000	1280	2000	3200
• Rated operational current I_e with AC-21A, AC-22A, AC-23A	A	63	125	160	250	400
• Motor switching capacity AC-23A	kW	50	110	150	220	375
At 440 V DC (3 conducting paths series-connected) ⁴⁾						
• Breaking current I_c ($L/R = 15$ ms)	A	250	500	640	1000 ⁴⁾	1600
• Rated operational current I_e at DC-23A	A	63	125	160	250 ⁵⁾	400
Rated short-time current (1 s current), rms value	kA	2.5	3.2	3.2	8	11
Permissible ambient temperature	°C	-25 ... +55 for operation ⁶⁾				
	°C	-50 ... +80 when stored				
Mechanical endurance , operating cycles		15000	15000	15000	12000	12000
Degree of protection		IP00/IP20 (from the operator side, with fuse and terminal covers)				
Power loss of the switch disconnector at I_{th} (plus power loss of the fuses)	W	8.5	22	36	33	86
Main conductor connections						
Busbar systems, max. dimensions (W × T)	mm	25 × 9	45 × 10	45 × 10	40 × 12	40 × 15
Cable lug, max. conductor cross-section (stranded)	mm ²	35	70	120	150	2 × 150 or 1 × 240
Busbar systems, max. dimensions (W × T)	mm	25 × 9	45 × 10	45 × 10	40 × 12	40 × 15
Tightening torque	Nm	6 ... 7.5	7 ... 10	18 ... 22	35 ... 45	35 ... 45
Terminal screws		M6	M6	M8	M10	M10
Protective conductor connections						
Flat bars	mm	--	--	--	20 × 2.5	20 × 2.5
Cable lug, max. conductor cross-section (stranded)	mm ²	--	--	--	70	120

¹⁾ Configuring note: Max. permissible operating temperature for fuse blades 135 °C, for connections 100 °C.

²⁾ 110 V (one conducting path).

³⁾ 220 V DC (L1 and L3 series-connected) or 110 V DC (one conducting path) at DC-23A.

⁴⁾ At 440 V $L/R = 4$ ms, at 220 V $L/R = 1$ ms.

⁵⁾ At 440 V DC-22A, at 220 V DC-23A.

⁶⁾ 3ND1 switchgear protection fuse.

3KM Switch Disconnectors with Fuses and Isolating Plug Connector up to 400 A

For snapping onto busbars

Selection and ordering data

All switch disconnectors with degree of protection IP00

Mounting on vertical busbars with busbar center-to-center spacing of 60 mm and bar thickness from 5 mm to 6.35 mm
Conductor connecting screws and fuse partitions are generally included in the scope of supply.

Rated uninterrupted current I_U	LV HRC fuse links ¹⁾ acc. to DIN 43620 ²⁾		DT	Article No.	Price per PU	PU (UNIT, SET, M)	PS*/P. unit	PG	Weight per PU approx.
	Size	Operational class							
A									kg
Complete versions with 8UC7 door-coupling rotary operating mechanisms									
3-pole for NH fuse systems									
• (black handle)									
63	00 and 000	gG, aM		3KM5030-1GB01		1	1 unit	103	1.855
125	00 and 000	gG, aM		3KM5230-1GB01		1	1 unit	103	2.796
160	00 and 000	gG, aM		3KM5330-1GB01		1	1 unit	103	2.857
250	1 and 2	gG, aM		3KM5530-1GB01		1	1 unit	103	6.528
400	2 and 1	gG, aM		3KM5730-1GB01		1	1 unit	103	6.829
3-pole for fuses acc. to BS 88									
• Complete versions with 8UC7 door-coupling rotary operating mechanism (black handle)									
125	Form A2/A3			3KM5230-1GG01		1	1 unit	103	2.747
125	Form A4			3KM5230-1GJ01		1	1 unit	103	2.821
160	Form A4			3KM5330-1GJ01		1	1 unit	103	2.933
250	Form B1-B3			3KM5530-1GG01		1	1 unit	103	6.571
400	Form B1-B3			3KM5730-1GG01		1	1 unit	103	7.110
Basic switch versions without handle									
3-pole for NH fuse systems									
63	00 and 000	gG, aM		3KM5030-1AB01		1	1 unit	103	1.507
125	00 and 000	gG, aM		3KM5230-1AB01		1	1 unit	103	2.415
160	00 and 000	gG, aM		3KM5330-1AB01		1	1 unit	103	2.505
250	1 and 2	gG, aM		3KM5530-1AB01		1	1 unit	103	5.598
400	2 and 1	gG, aM		3KM5730-1AB01		1	1 unit	103	5.894
3-pole for fuses acc. to BS 88									
63	Form A2/A3			3KM5030-1AG01		1	1 unit	103	1.450
125	Form A2/A3			3KM5230-1AG01		1	1 unit	103	2.335
125	Form A4			3KM5230-1AJ01		1	1 unit	103	2.400
160	Form A4			3KM5330-1AJ01		1	1 unit	103	2.507
250	Form B1-B3			3KM5530-1AG01		1	1 unit	103	5.689
400	Form B1-B3			3KM5730-1AG01		1	1 unit	103	6.250
8UC7 EMERGENCY-STOP door-coupling rotary operating mechanisms (red handle, yellow indicator plate) for basic switch versions without handle									
63	00 and 000	gG, aM		8UC7121-3BB10		1	1 unit	103	0.368
125	00 and 000	gG, aM		8UC7222-3BB20		1	1 unit	103	0.423
160	00 and 000	gG, aM		8UC7222-3BB20		1	1 unit	103	0.423
250	1 and 2	gG, aM		8UC7323-3BB30		1	1 unit	103	1.016
400	2 and 1	gG, aM		8UC7323-3BB30		1	1 unit	103	1.016
• 8UC7 EMERGENCY-STOP door-coupling rotary operating mechanisms (red handle, yellow indicator plate)									
63	Form A2/A3			8UC7121-3BB10		1	1 unit	103	0.368
125	Form A2/A3			8UC7222-3BB20		1	1 unit	103	0.423
125	Form A4			8UC7222-3BB20		1	1 unit	103	0.423
160	Form A4			8UC7222-3BB20		1	1 unit	103	0.423
250	Form B1-B3			8UC7323-3BB30		1	1 unit	103	1.016
400	Form B1-B3			8UC7323-3BB30		1	1 unit	103	1.016



3KM5330-1AB01 with fuses



3KM5530-1AG01 with fuses



8UC7121-3BB10

Fuse monitoring through 5TT3170 safety monitor with a floating 1 NO signaling contact, see chapter 5 "Fuse systems".



¹⁾ Silver-plated fuse blades. Silver-plated isolating blades can be used if desired.²⁾ For assignment of semiconductor fuses see page 7/82

Switch Disconnectors

3KM Switch Disconnectors with Fuses and Isolating Plug Connector up to 400 A

Accessories

Selection and ordering data

Version	DT	Article No.	Price per PU	PU (UNIT, SET, M)	PS*/P. unit	PG	Weight per PU approx.
							kg
3KM50							
 3KX35.7-3AA		Terminal covers For 3-pole devices (1 set = 6 units)	▶	3KX3552-3DA01	1	1 unit	103 0.078
		Fuse covers (interlock only detachable in the OFF position)	▶	3KX3517-3AA	1	1 unit	103 0.041
		Fuse partitions (1 set = 5 units)	▶	3KX3507-0AA01	1	1 unit	103 0.040
		Lyre-shaped fuse covers (1 set = 6 units)		3KX3507-0BA01	1	1 unit	103 0.030
		Door-coupling rotary operating mechanisms IP65 Black handle, shaft 300 mm		8UC7111-1BB10	1	1 unit	103 0.358
		EMERGENCY-STOP (yellow/red), shaft 300 mm		8UC7121-3BB10	1	1 unit	103 0.368
		Operating mechanisms for fixed mounting Black handle, shaft 250 mm	▶	3KX3516-1AA	1	1 unit	103 0.102
		Extension shaft 300 mm long		8UC6031	1	1 unit	103 0.068
		Extension shaft 600 mm long		8UC6081	1	1 unit	103 0.136
		Shaft connecting pieces		8UC6021	1	1 unit	103 0.027
		Auxiliary switches 1 NO + 1 NC		3SB1400-0A	1	1 unit	41J 0.019
		2 NO		3SB1400-0G	1	1 unit	41J 0.019
		2 NC		3SB1400-0H	1	1 unit	41J 0.020
		Fuse monitor connections (1 set = 6 units)		3KX3505-0AA	1	1 unit	103 0.021
3KM52/3KM53							
 3KX35.7-3AA		Terminal covers For 3-pole devices (1 set = 6 units)	▶	3KX3552-3DA01	1	1 unit	103 0.078
			▶	3KX3553-3DA01	1	1 unit	103 0.151
		Fuse covers¹⁾ (interlock only detachable in the OFF position)	▶	3KX3527-3AA	1	1 unit	103 0.070
		Fuse partitions (1 set = 5 units)	▶	3KX3507-0AA01	1	1 unit	103 0.040
		Lyre-shaped fuse covers (1 set = 6 units)		3KX3507-0BA01	1	1 unit	103 0.030
		Door-coupling rotary operating mechanisms IP65 Black handle, shaft 300 mm		8UC7212-1BB20	1	1 unit	103 0.404
		EMERGENCY-STOP (yellow/red), shaft 300 mm		8UC7222-3BB20	1	1 unit	103 0.423
		Operating mechanisms for fixed mounting Black handle, shaft 250 mm	▶	3KX3536-1AA	1	1 unit	103 0.150

¹⁾ Für 3KX3527-3AA: Not suitable for use with type A4 BS fuses.

3KM Switch Disconnectors with Fuses and Isolating Plug Connector up to 400 A

Accessories

Version	DT	Article No.	Price per PU	PU (UNIT, SET, M)	PS*/P. unit	PG	Weight per PU approx. kg
Extension shaft 300 mm long		8UC6032		1	1 unit	103	0.135
Extension shaft 600 mm long		8UC6082		1	1 unit	103	0.265
Shaft connecting pieces		8UC6022		1	1 unit	103	0.022
Auxiliary switches							
1 NO + 1 NC		3SB1400-0A		1	1 unit	41J	0.019
2 NO		3SB1400-0G		1	1 unit	41J	0.019
2 NC		3SB1400-0H		1	1 unit	41J	0.020
1 NO + 1 NC, 20 ms leading		3KX3552-3EA01		1	1 unit	103	0.022
Fuse monitor connections (1 set = 6 units)		3KX3505-0AA		1	1 unit	103	0.021
3KM55/3KM57							
Terminal covers							
For 3-pole devices (1 set = 6 units)	▶	3KX3557-3DA01		1	1 unit	103	0.293
For 4-pole devices (1 set = 8 units)		3KX3557-3DB01		1	1 unit	103	0.370
Fuse covers (interlock only detachable in the OFF position)	▶	3KX3557-3AA		1	1 unit	103	0.231
Fuse partitions (1 set = 5 units)	▶	3KX3557-0AA01		1	1 unit	103	0.122
Door-coupling rotary operating mechanisms IP65							
Black handle, shaft 300 mm		8UC7313-1BB30		1	1 unit	103	0.998
EMERGENCY-STOP (yellow/red), shaft 300 mm		8UC7323-3BB30		1	1 unit	103	1.016
Operating mechanisms for fixed mounting, size 3	▶	3KX3176-1E		1	1 unit	103	0.287
Black handle, shaft 250 mm							
Extension shaft 300 mm long		8UC6033		1	1 unit	103	0.215
Extension shaft 600 mm long		8UC6083		1	1 unit	103	0.424
Shaft connecting pieces		8UC6023		1	1 unit	103	0.083
Auxiliary switches							
1 NO + 1 NC		3SB1400-0A		1	1 unit	41J	0.019
2 NO		3SB1400-0G		1	1 unit	41J	0.019
2 NC		3SB1400-0H		1	1 unit	41J	0.020
1 NO + 1 NC, 20 ms leading		3KX3552-3EA01		1	1 unit	103	0.022
Fuse monitor connections (1 set = 6 units)		3KX3505-0AA		1	1 unit	103	0.021



3SB1400-0A



3KX35.7-3AA



3KX3557-0AA01

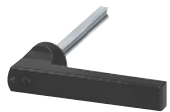

3KX3176-1E



3SB1400-0A

Switch Disconnectors

3KM Switch Disconnectors with Fuses and Isolating Plug Connector up to 400 A

Fuses

Overview

The 3KM switch disconnectors with fuses are suitable for all fuses in LV HRC design, [see chapter 5](#).

SITOR semiconductor fuses in LV HRC design can also be used, although it must be noted that, compared to cable and line protection fuses, these get much hotter during operation. For this reason, the fuse must be operated below the rated current I_n of the device (derating) when installed in a closed switching device.

The following table shows the permissible load currents of the SITOR semiconductor fuses for installation in 3KM. The values were determined using the conductor cross-sections specified in the table.

SITOR semiconductor fuses for 3KM fuse switch disconnectors: Assignment table

Note

If using smaller cross-sections, a considerably higher derating is required due to the lower heat dissipation.

SITOR semiconductor fuse data						Permissible load currents of fuse when installed in 3KM for busbar mounting					
Type ¹⁾	Rated current I_n	Rated voltage ²⁾ V AC	Operational class	Size	Required conductor cross-section Cu mm ²	Type 3KM			Alternative type 3KM		
						Type	Size	Permissible load current ³⁾ A	Type	Size	Permissible load current ³⁾ A
3NE1020-2	80	690	gR	00	25	3KM52	00	80	3KM53	00	80
3NE1021-0	100	690	gS	00	35	3KM52	00	100	3KM53	00	100
3NE1021-2	100	690	gR	00	35	3KM52	00	100	3KM53	00	100
3NE1022-0	125	690	gS	00	50	3KM52	00	125	3KM53	00	125
3NE1022-2	125	690	gR	00	50	3KM52	00	125	3KM53	00	125
3NE1224-0	160	690	gS	1	70	3KM55	1	160	3KM57	2	160
3NE1224-2/-3	160	690	gR	1	70	3KM55	1	160	3KM57	2	160
3NE1225-0	200	690	gS	1	95	3KM55	1	200	3KM57	2	200
3NE1225-2/-3	200	690	gR	1	95	3KM55	1	200	3KM57	2	200
3NE1227-0	250	690	gS	1	120	3KM55	1	250	3KM57	2	250
3NE1227-2/-3	250	690	gR	1	120	3KM55	1	245	3KM57	2	250
3NE1230-0	315	690	gS	1	2x 70	3KM57	2	315	--	--	--
3NE1230-2/-3	315	690	gR	1	2x 70	3KM57	2	280	--	--	--
3NE1331-0	350	690	gS	2	2x 95	3KM57	2	330	--	--	--
3NE1331-2/-3	350	690	gR	2	2x 95	3KM57	2	300	--	--	--
3NE1332-0	400	690	gS	2	2x 95	3KM57	2	375	--	--	--
3NE1332-2/-3	400	690	gR	2	2x 95	3KM57	2	315	--	--	--
3NE1333-0	450	690	gS	2	2x 120	3KM57	2	400	--	--	--
3NE1333-2/-3	450	690	gR	2	2x 120	3KM57	2	325	--	--	--
3NE1334-0	500	690	gS	2	2x 120	3KM57	2	400	--	--	--
3NE1334-2/-3	500	690	gR	2	2x 120	3KM57	2	350	--	--	--
3NE1802-0	40	690	gS	000	10	3KM50	00	40	3KM52	00	40
3NE1803-0	35	690	gS	000	6	3KM50	00	35	3KM52	00	35
3NE1813-0	16	690	gS	000	1.5	3KM50	00	16	3KM52	00	16
3NE1814-0	20	690	gS	000	2.5	3KM50	00	20	3KM52	00	20
3NE1815-0	25	690	gS	000	4	3KM50	00	25	3KM52	00	25
3NE1817-0	50	690	gS	000	10	3KM50	00	50	3KM52	00	50
3NE1818-0	63	690	gS	000	16	3KM50	00	63	3KM52	00	63
3NE1820-0	80	690	gS	000	25	3KM52	00	80	--	--	--
3NE3221	100	1000	aR	1	35	3KM55	1	90	3KM57	2	95
3NE3222	125	1000	aR	1	50	3KM55	1	110	3KM57	2	115
3NE3224	160	1000	aR	1	70	3KM55	1	140	3KM57	2	150
3NE3225	200	1000	aR	1	95	3KM55	1	175	3KM57	2	180
3NE3227	250	1000	aR	1	120	3KM55	1	210	3KM57	2	220
3NE3230-0B	315	1000	aR	1	185	3KM57	2	240	--	--	--
3NE3231	350	1000	aR	1	240	3KM57	2	265	--	--	--
3NE3232-0B	400	1000	aR	1	240	3KM57	2	290	--	--	--
3NE3233	450	1000	aR	1	2x 150	3KM57	2	320	--	--	--
3NE3332-0B	400	1000	aR	2	240	3KM57	2	290	--	--	--
3NE3333	450	1000	aR	2	2x 150	3KM57	2	320	--	--	--
3NE3334-0B	500	1000	aR	2	2x 150	3KM57	2	360	--	--	--
3NE3335	560	1000	aR	2	2x 185	3KM57	2	400	--	--	--

3KM Switch Disconnectors with Fuses and Isolating Plug Connector up to 400 A

Fuses

SITOR semiconductor fuse data						Permissible load currents of fuse when installed in 3KM for busbar mounting					
Type ¹⁾	Rated current I_n	Rated voltage ²⁾	Operational class	Size	Required conductor cross-section Cu	Type 3KM			Alternative type 3KM		
						Type	Size	Permissible load current ³⁾	Type	Size	Permissible load current ³⁾
	A	V AC			mm ²			A			A
3NE3336	630	1000	aR	2	2x 185	3KM57	2	400	--	--	--
3NE3337-8	710	900	aR	2	2x (40x5)	3KM57	2	400	--	--	--
3NE3338-8	800	800	aR	2	2x 240	3KM57	2	400	--	--	--
3NE3340-8	900	690	aR	2	2x (40x8)	3KM57	2	400	--	--	--
3NE4101	32	1000	gR	0	6	3KM55	1	32	--	--	--
3NE4102	40	1000	gR	0	10	3KM55	1	40	--	--	--
3NE4117	50	1000	gR	0	10	3KM55	1	50	--	--	--
3NE4118	63	1000	aR	0	16	3KM55	1	63	--	--	--
3NE4120	80	1000	aR	0	25	3KM55	1	80	--	--	--
3NE4121	100	1000	aR	0	35	3KM55	1	95	--	--	--
3NE4122	125	1000	aR	0	50	3KM55	1	120	--	--	--
3NE4124	160	1000	aR	0	70	3KM55	1	150	--	--	--
3NE4327-0B	250	800	aR	2	150	3KM57	2	175	--	--	--
3NE4330-0B	315	800	aR	2	240	3KM57	2	230	--	--	--
3NE4333-0B	450	800	aR	2	2x (30x5)	3KM57	2	340	--	--	--
3NE4334-0B	500	800	aR	2	2x (30x5)	3KM57	2	380	--	--	--
3NE4337	710	800	aR	2	2x (50x5)	3KM57	2	400	--	--	--
3NE8015-1	25	690	gR	00	4	3KM50	00	25	3KM52	00	25
3NE8003-1	35	690	gR	00	6	3KM50	00	33	3KM52	00	35
3NE8017-1	50	690	gR	00	10	3KM50	00	45	3KM52	00	50
3NE8018-1	63	690	gR	00	16	3KM50	00	54	3KM52	00	60
3NE8020-1	80	690	aR	00	25	3KM52	00	68	--	--	--
3NE8021-1	100	690	aR	00	35	3KM52	00	89	--	--	--
3NE8022-1	125	690	aR	00	50	3KM52	00	106	--	--	--
3NE8024-1	160	690	aR	00	70	3KM52	00	130 ⁴⁾	--	--	--

¹⁾ Due to the mechanical stress on the relatively long fuse blades, SITOR 3NE41 semiconductor fuses should only be switched occasionally and only at zero current.

²⁾ Fuses with a rated voltage >690 V may only be operated at max. 690 V (rated voltage of the 3KM) when installed in 3KM

³⁾ In the case of cyclic loads, the currents may have to be further reduced (precise values on request).

⁴⁾ The fuse can also be operated at a higher rated uninterrupted current than the 125 A current of the 3KM52. However, in this case, the 3KM52 must not be switched under load (utilization category AC-20).

Switch Disconnectors

8UC7 Door-Coupling Rotary Operating Mechanisms

For 3K switch disconnectors

Overview

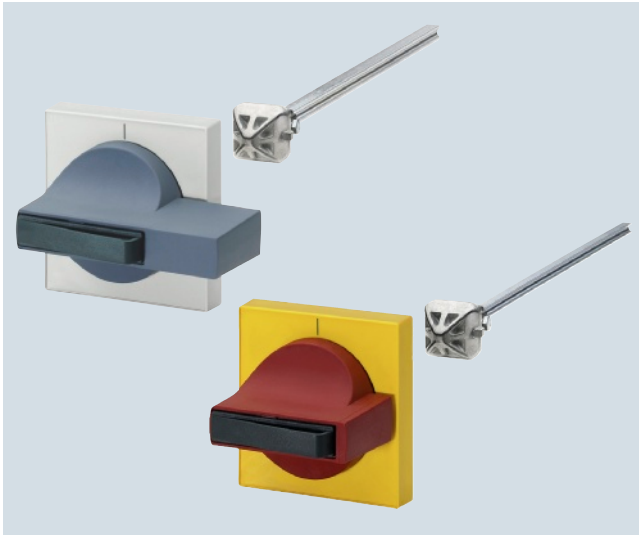

8UC7 rotary operating mechanism in STANDARD version (left) and EMERGENCY-STOP version (right)

With door-coupling rotary operating mechanisms it is also possible to operate switch disconnectors from the outside with the control cabinet doors closed.

The rotary operating mechanisms are available in "STANDARD" and "EMERGENCY-STOP" versions with the following differences:

- STANDARD version: Masking plates in light-gray with black inscription, handles in ti-grey
- EMERGENCY-STOP version: Masking plates in yellow with black inscription, handles in red

Available sizes

Rotary operating mechanisms	Size	Rated torque ¹⁾	Shaft profile	Masking plate
		Nm	mm x mm	mm x mm
8UC71	1	4	6 x 6	75 x 75
8UC72	2	9	8 x 8	75 x 75
8UC73	3	25	10 x 10 or 12 x 12	100 x 100
8UC74	4	40/55 ²⁾	12 x 12	100 x 100

¹⁾ Operating mechanisms tested with triple torque (according to EN 60947-3). They are therefore also suitable for applications in this area.

²⁾ Operation with two hands.

Degree of protection

Degree of protection when installed is IP65.

Standards

8UC7 door-coupling rotary operating mechanisms are in line with for example the following standards:

Standard	Title
IEC 60204-1, EN 60204-1 (VDE 0113 Part 1)	Safety of machinery; electrical equipment of machines
IEC 60439-1, EN 60439-1 (VDE 0660 Part 500)	Low-voltage switchgear and controlgear assemblies
IEC 60947-3, EN 60947-3 (VDE 0660 Part 107)	Low-voltage switchgear and controlgear; Switches, disconnectors, switch disconnectors and fuse-combination units

Benefits

Can be locked

The retractable locking device integrated in the handles is suitable for padlocks with shackle diameters of 4.5 mm to 8.5 mm (locks according to DIN 7465).

Up to three padlocks with a shackle diameter of 8.5 mm and up to five padlocks with a shackle diameter of 6 mm can be fitted simultaneously.

Non-interchangeability

In order to ensure that, when installing switches and door-coupling operating mechanisms, all components are assembled in the correct position with respect to one another, the components are provided with non-interchangeability features (rivet and lug).

Stops

Stops are used to prevent damage occurring as the result of excessive torque. These stops are supplied loose with the rotary operating mechanisms and can be fitted as required. Stops are fitted at the factory to size 1 and 2 rotary operating mechanisms with a 90° operating angle (exception: 3RV motor starter protectors/circuit breakers).

Tolerance compensation

8UC7 rotary operating mechanisms are capable of taking up a radial eccentricity of max. 3 mm between the actuating shaft of the switching device and the door-coupling rotary operating mechanism. Supporting the extension shaft is recommended with greater tolerances.

Coupling drivers	a	b	Shaft length
With tolerance compensation	+3	±5	x
Without tolerance compensation	+1.5	±2.5	x+23.5

Permissible radial eccentricity and axial tolerance compensation in mm

Pull-out strength

The pull-out strength of interlocked operating mechanisms, e.g. pulling off the shaft or destruction of the operating mechanism, amounts to 800 N when the pulling force acts directly onto the operating mechanism in direction of shaft.

Switch Disconnectors

8UC7 Door-Coupling Rotary Operating Mechanisms

For 3K switch disconnectors

Application

8UC7 door-coupling rotary operating mechanisms can be used in electrical controls, distribution boards and switchgear in cases where switches have to be mounted behind covers, end plates and doors that must be opened and where they are to be operated manually from outside.

Interlocking conditions

The basic versions of the rotary operating mechanisms comply with the following interlocking conditions:

- Operating mechanism and switching device in "0" (OFF) position: The control cabinet door can be opened. With padlocks fitted, the control cabinet door remains locked however.
- Operating mechanism and switching device in "I" (ON) position: The control cabinet door cannot be opened in this position. However, the interlock can be overridden and the control cabinet door opened by trained personnel for performing checks. No padlocks can be fitted in "I" position.

Other interlocking conditions:

- If no door interlock is required, the user can remove the door interlocking plate of the rotary operating mechanism.
- It is easy for the user to fit padlocks to the rotary operating mechanisms in the "I" position as well. In this case the door cannot be opened, the operating mechanism cannot be actuated and the door interlock cannot be overridden.

Operating conditions and ambient conditions

The temperature range for operation of the rotary operating mechanisms is between -25 °C and $+60\text{ °C}$.

Thanks to the use of glass fiber-reinforced molded plastic for handles and masking plates as well as metal components with surface protection, the rotary operating mechanisms are suitable for rough conditions, high air humidity and aggressive atmospheres.

Design

Components

The rotary operating mechanisms consist of a masking plate with handle, including seal and fixing screws for door installation, an extension shaft (300 mm) and a coupling driver to be mounted onto the switch shaft.

Operating mechanisms for 3KA / 3KL / 3KM switch disconnectors do not have a shaft coupling since the extension shaft is fitted directly into the switch. Extension shafts with a length of 600 mm are also available.

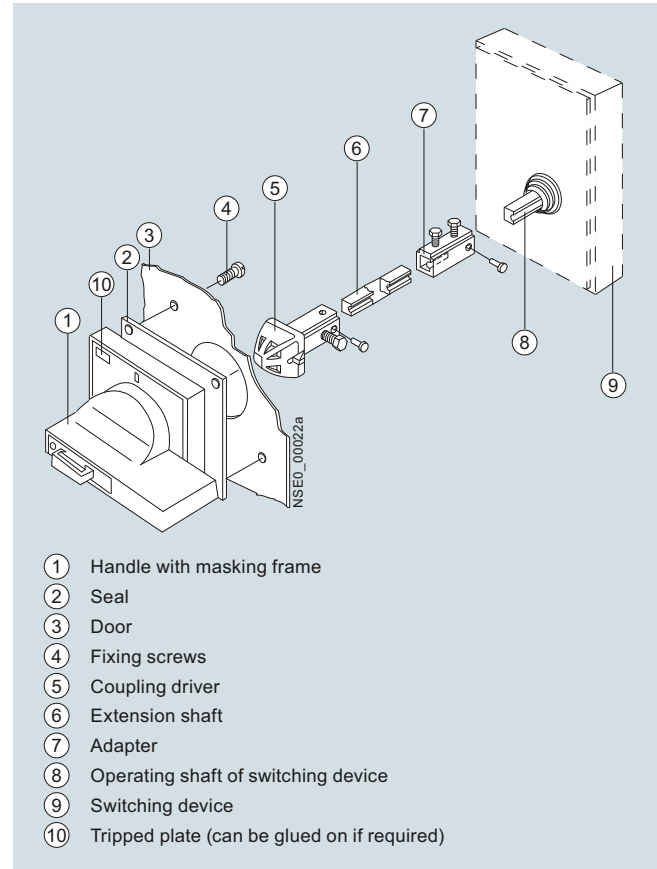

Design, schematic representation

Switch position

In order to ensure compliance with locking and interlocking conditions, the controls and operating mechanisms must be installed such that, with two-position switches the "0" position lies at 9 o'clock and the "I" position at 12 o'clock.

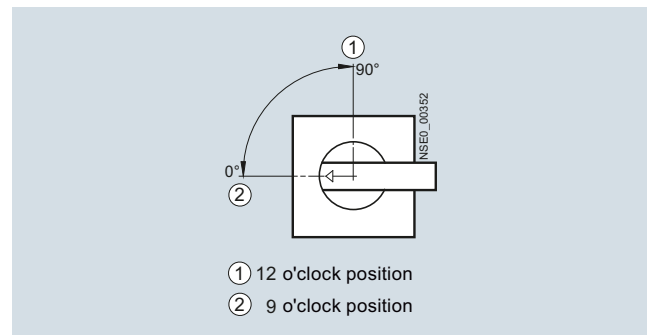

Positions for two-position switches with 90° operating angle

Switch Disconnectors

8UC7 Door-Coupling Rotary Operating Mechanisms

For 3K switch disconnectors

Selection and ordering data

Door-coupling rotary operating mechanisms, fully lockable with padlocks, with door interlock supplied with seal and fixing screws

Switchgear	Rated current	Cross-section of the actuating shaft	Torque	Rotary operating mechanisms	Illustrated: Handle, masking plate
------------	---------------	--------------------------------------	--------	-----------------------------	------------------------------------

Type	A	mm	Nm	Size
------	---	----	----	------

8UC71



For switch disconnectors with or without fuses

3KL50 ¹⁾ , 3KM50 ¹⁾	63	6 x 6	3	1
3KA50 ¹⁾	63	6 x 6	3	
3KA51 ¹⁾	80	6 x 6	3	



8UC72



For switch disconnectors with or without fuses

3KL52, 3KM52	125	8 x 8	7.5	2
3KL53, 3KM53	160	8 x 8	7.5	
3KA52	125	8 x 8	7.5	
3KA53	160	8 x 8	7.5	

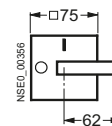

8UC73



For switch disconnectors with or without fuses

3KL55, 3KM55	250	10 x 10	16	3
3KL57, 3KM57	400	10 x 10	16	
3KA55	250	10 x 10	16	
3KA57	400	10 x 10	16	
3KA58	630	10 x 10	16	

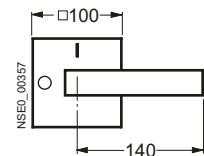

For switch disconnectors without fuses

3KE42	250	12 x 12	15	3
3KE43	400	12 x 12	15	
3KE44	630	12 x 12	24	
3KE45	1000	12 x 12	24	

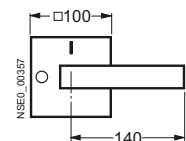

8UC74



For switch disconnectors with fuses

3KL61 ²⁾	630	12 x 12	30	4
3KL62 ²⁾	800	12 x 12	30	

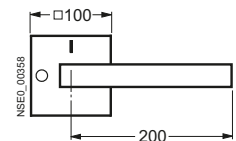

For switch disconnectors as changeover switches with break-before-make feature

3KE42 (2 units)	250	12 x 12	20	4
3KE43 (2 units)	400	12 x 12	20	
3KE44 (2 units)	630	12 x 12	30	
3KE45 (2 units)	1000	12 x 12	30	

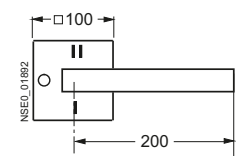

For switch disconnectors as changeover switches without break-before-make feature

3KE42 (2 units)	250	12 x 12	40	4
3KE43 (2 units)	400	12 x 12	40	
3KE44 (2 units)	630	12 x 12	55	
3KE45 (2 units)	1000	12 x 12	55	

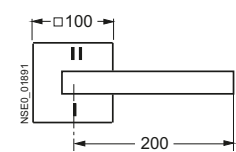

For switch disconnectors as parallel switches

3KE42 (2 units)	250	12 x 12	40	4
3KE43 (2 units)	400	12 x 12	40	
3KE44 (2 units)	630	12 x 12	55	
3KE45 (2 units)	1000	12 x 12	55	

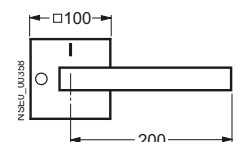

- ¹⁾ Valid only for 3-pole switching devices. For 4-pole switching devices, an operating mechanism with 8 x 8 mm actuating shaft must be used, see row below for 3KA52, 3KL52 or 3KM52.
- ²⁾ Additionally required for 3KL61: 1 shaft coupling, Article No. 8UC9253, see individual parts, table, page 7/88.

- ³⁾ The door interlocking plate must be removed.
- ⁴⁾ With shortened 8UC6016/8UC6017 coupling driver and reduced tolerance compensation, see "Dimensional Drawings".

Switch Disconnectors

8UC7 Door-Coupling Rotary Operating Mechanisms

For 3K switch disconnectors







Version	DT	Rotary operating mechanisms, complete	PU (UNIT, SET, M)	PS*/P. unit	PG	Weight per PU approx. kg	Individual parts						
							Handle with masking plate	Coupling drivers	Extension shaft length 300 mm	Shaft couplings			
		Article No.	Price per PU				Article No.	Article No.	Article No.	Article No.			
Standard Standard ⁴⁾ EMERGENCY-STOP		8UC7111-1BB10		1	1 unit	103	0.358	8UC7110-1BB	□ 6 mm	8UC6011	□ 6 mm	8UC6031	□ 6 mm by 6 mm
		8UC7161-1BB10		1	1 unit	103	0.328	8UC7110-1BB		8UC6016		8UC6031	Not required
		8UC7121-3BB10		1	1 unit	103	0.368	8UC7120-3BB		8UC6011		8UC6031	Not required
Standard Standard ⁴⁾ EMERGENCY-STOP		8UC7212-1BB20		1	1 unit	103	0.404	8UC7210-1BB	□ 8 mm	8UC6012	□ 8 mm	8UC6032	□ 8 mm by 8 mm
		8UC7262-1BB20		1	1 unit	103	0.392	8UC7210-1BB		8UC6017		8UC6032	Not required
		8UC7222-3BB20		1	1 unit	103	0.423	8UC7220-3BB		8UC6012		8UC6032	Not required
Standard EMERGENCY-STOP		8UC7313-1BB30		1	1 unit	103	0.998	8UC7310-1BB	□ 10 mm	8UC6013	□ 10 mm	8UC6033	□ 10 mm by 10 mm
		8UC7323-3BB30		1	1 unit	103	1.016	8UC7320-3BB		8UC6013		8UC6033	Not required
Standard EMERGENCY-STOP		8UC7314-1BB44		1	1 unit	103	1.170	8UC7310-1BB	□ 12 mm	8UC6014	□ 12 mm	8UC6034	□ 12 mm by 12 mm
		8UC7324-3BB44		1	1 unit	103	1.186	8UC7320-3BB		8UC6014		8UC6034	8UC6024
Standard EMERGENCY-STOP		8UC7414-1BB44		1	1 unit	103	1.159	8UC7410-1BB	□ 12 mm	8UC6014	□ 12 mm	8UC6034	□ 12 mm by 12 mm
		8UC7424-3BB44		1	1 unit	103	1.120	8UC7420-3BB		8UC6014		8UC6034	8UC6024
Standard		8UC7414-1BF44		1	1 unit	103	1.208	8UC7410-1BF	□ 12 mm	8UC6014	□ 12 mm	8UC6034	□ 12 mm by 12 mm
Standard		8UC7414-1FG44		1	1 unit	103	1.113	8UC7410-1FG	□ 12 mm	8UC6014	□ 12 mm	8UC6034	□ 12 mm by 12 mm
Standard		8UC7414-1BB44		1	1 unit	103	1.159	8UC7410-1BB	□ 12 mm	8UC6014	□ 12 mm	8UC6034	□ 12 mm by 12 mm

Switch Disconnectors

8UC7 Door-Coupling Rotary Operating Mechanisms

Individual parts

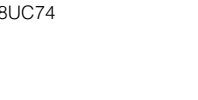
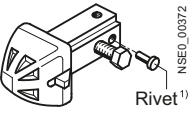
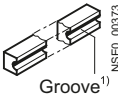
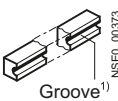
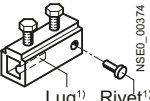
Selection and ordering data

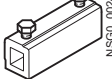
	Switchgear	Rotary operating mechanisms	Size	Cross-section of the actuating shaft	Version ⁴⁾	DT	Individual parts for 8UC7 door-coupling rotary operating mechanisms Article No.	Price per PU	PU (UNIT, SET, M)	PS*/P. unit	PG	Weight per PU approx. kg
	Type	Type	mm × mm									
Handles with masking plate (including flat gasket and fixing screws)												
	3KL50, 3KM50, 3KA50, 3KA51	8UC71	1	6 × 6	Standard		8UC7110-1BB 8UC7120-3BB		1 1	1 unit 1 unit	103 103	0.181 0.178
8UC71												
	3KL52, 3KM52, 3KL53, 3KM53, 3KA52, 3KA53	8UC72	2	8 × 8	Standard		8UC7210-1BB 8UC7220-3BB		1 1	1 unit 1 unit	103 103	0.190 0.186
8UC74												
	3KL55, 3KM55, 3KL57, 3KM57, 3KA55, 3KA57, 3KE42, 3KE43, 3KE44, 3KE45	8UC73	3	10 × 10 or 12 × 12	Standard		8UC7310-1BB 8UC7320-3BB		1 1	1 unit 1 unit	103 103	0.493 0.472
8UC74												
	3KL61, 3KL62	8UC74	4	12 × 12	Standard		8UC7410-1BB 8UC7420-3BB		1 1	1 unit 1 unit	103 103	0.514 0.488
8UC74												
	3KE42, 3KE43, 3KE44, 3KE45	8UC74 ³⁾	4	12 × 12	Standard		8UC7410-1BF 8UC7410-1FG 8UC7410-1BB		1 1 1	1 unit 1 unit 1 unit	103 103 103	0.496 0.435 0.514
8UC74												
	Rotary operating mechanisms		Cross-section of the actuating shaft		DT	Individual parts for 8UC6 door-coupling rotary operating mechanisms Article No.	Price per PU	PU (UNIT, SET, M)	PS*/P. unit	PG	Weight per PU approx. kg	
	Type		mm × mm									
Coupling drivers, extension shafts, shaft couplings and reducers												
	Coupling drivers for 3K											
8UC6011	8UC71		6 × 6			8UC6011		1	1 unit	103	0.076	
	8UC71 ²⁾		6 × 6			8UC6016		1	1 unit	103	0.045	
	8UC72		8 × 8			8UC6012		1	1 unit	103	0.073	
	8UC72 ²⁾		8 × 8			8UC6017		1	1 unit	103	0.041	
	8UC73		10 × 10			8UC6013		1	1 unit	103	0.235	
	8UC73/74		12 × 12			8UC6014		1	1 unit	103	0.233	
	Extension shafts 300 mm long											
	8UC71		6 × 6			8UC6031		1	1 unit	103	0.068	
8UC6031 ... 34	8UC72		8 × 8			8UC6032		1	1 unit	103	0.135	
	8UC73		10 × 10			8UC6033		1	1 unit	103	0.215	
	8UC73/74		12 × 12			8UC6034		1	1 unit	103	0.316	
	Extension shafts 600 mm long											
	8UC71		6 × 6			8UC6081		1	1 unit	103	0.136	
8UC6081 ... 84	8UC72		8 × 8			8UC6082		1	1 unit	103	0.265	
	8UC73		10 × 10			8UC6083		1	1 unit	103	0.424	
	8UC73/74		12 × 12			8UC6084		1	1 unit	103	0.628	
	Shaft couplings											
	8UC71		6 × 6			8UC6021		1	1 unit	103	0.027	
8UC6021 to 8UC6024	8UC72		8 × 8			8UC6022		1	1 unit	103	0.022	
	8UC73		10 × 10			8UC6023		1	1 unit	103	0.083	
	8UC73/74		12 × 12			8UC6024		1	1 unit	103	0.078	
	8UC74 (3KL61)		12 × 12			8UC9253		1	1 unit	103	0.113	
	Reducers											
	8UC71		8 × 8 to 6 × 6			8UC7058		1	1 unit	103	0.024	
8UC70 58	8UC72		12 × 12 to 8 × 8			8UC7050		1	1 unit	103	0.081	
												
8UC70 50												

¹⁾ Non-interchangeability features.

²⁾ Shortened coupling driver with reduced tolerance compensation.

³⁾ For switch disconnectors as changeover switches in various versions, see table on page 7/86.







⁴⁾ Standard: Ti-grey handle, light-gray masking plate; EMERGENCY-STOP: Red handle, yellow masking plate.

Switch Disconnectors

8UC7 Door-Coupling Rotary Operating Mechanisms

Operating mechanisms for fixed mounting

Selection and ordering data

	Switch-gear	Cross-section of the actuating shaft	Torque of the operating mechanism ¹⁾	Operating mechanisms	Color of handle	DT	Operating mechanisms for fixed mounting		PU (UNIT, SET, M)	PS*/P. unit	PG	Weight per PU approx.
	Type	mm × mm	Nm	Size			Article No.	Price per PU				kg
 8UC9354	3KA50, 3KA51, 3KL50, 3KM50	6 × 6	4	1	Black	²⁾	8UC9354		1	1 unit	103	0.036
			7.5	2	Black	²⁾	8UC9360		1	1 unit	103	0.046
 8UC9360	3KA52, 3KA53, 3KL52, 3KM52, 3KL53, 3KM53	8 × 8	7.5	2	Black		8UC9362		1	1 unit	103	0.050
					Red		8UC9363		1	1 unit	103	0.049
 8UC9365	3KL55, 3KM55, 3KL57, 3KM57	10 × 10	16	3	Black		8UC9365		1	1 unit	103	0.137
					Red		8UC9366		1	1 unit	103	0.120
 8UC9374	3KE42, 3KE43	12 × 12	16	3	Black	³⁾	8UC9370		1	1 unit	103	0.124
					Red	³⁾	8UC9371		1	1 unit	103	0.142
					Black	³⁾	8UC9374		1	1 unit	103	0.143
 8UC9375	3KE44, 3KE45	12 × 12	30	4	Black	³⁾	8UC9375		1	1 unit	103	0.160
					Red	³⁾			1	1 unit	103	0.160
 8UC9381	3KL61	12 × 12	55	5	Black		8UC9381		1	1 unit	103	0.270
					Red		8UC9382		1	1 unit	103	0.263

¹⁾ Operating mechanisms were tested with triple torque (DIN VDE 0660 Part 107). They are therefore qualified for use in all controls, especially for disconnectors.

²⁾ Red handle available on request.

³⁾ Also required: 3KX2210-0H coupling socket.

Switch Disconnectors

3NJ62 In-Line Switch Disconnectors with Fuses up to 630 A

Introduction

Overview



3NJ62 switch disconnectors with fuses

All key product features at a glance

- In-line design
- Type-tested according to IEC EN 60947-3
- Voltage levels up to 690 V AC/440 V DC
- 160 A to 630 A for LV HRC and BS 88 fuse links, according to IEC 60269-1/EN 60269-1
- 2-, 3- and 4-pole versions available
- 185 mm phase center distance of plug-in contacts
- Manually operated or with motorized operating mechanism
- Electronic fuse monitoring (EFM)
- Developed for switchgear in plug-in design
- Horizontal or vertical mounting position
- Front panel locked in ON position
- Degree of protection IP41

Overview of all components and accessory parts

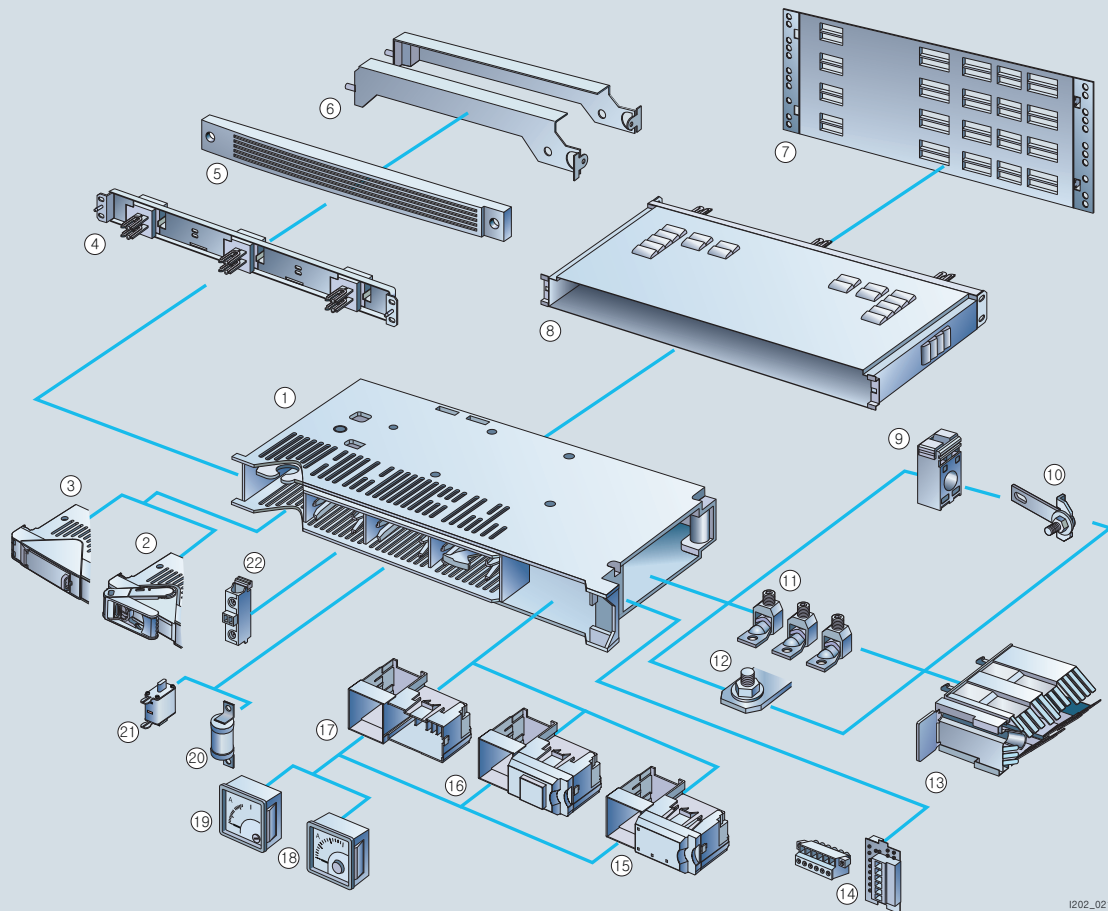

- 1 3NJ62 switch disconnector basic device here in size 00, open, without front cover
- 2 Manual operating mechanism
- 3 Motorized operating mechanism
- 4 Connection module
- 5 Blanking cover
- 6 Guide rails
- 7 Busbar cover
- 8 Contact extension
- 9 Current transformer
- 10 Current transformer bar
- 11 Connection terminals
- 12 Stud terminal
- 13 Terminal cover
- 14 Multifunction plug
- 15 Holder for measuring device with electronic fuse monitoring (EFM 10)
- 16 Holder for measuring device with electronic fuse monitoring (EFM 20/25)
- 17 Holder for measuring device without EFM
- 18 Bimetal current measuring device
- 19 Moving-iron current measuring device
- 20 BS fuse
- 21 LV MRC fuse
- 22 Auxiliary switch

I202_02142

Switch Disconnectors

3NJ62 In-Line Switch Disconnectors with Fuses up to 630 A

Introduction

Benefits

Key advantages for switchgear manufacturers due to the following:

- Compact, modular design
- Simple and efficient mounting due to incoming plug-in contact
- High packing density in the field
- Cable connection with cable clamps or cable lugs
- Can be mounted in different control cabinet depths
- Comprehensive range of accessories

The advantages for users are:

- Conversion, retrofitting and replacement without switching off the switchgear
- Dead-state fuse replacement
- Maintenance-free
- High personal safety
- Operating handle can be locked in OFF position
- Clear and unambiguous switch position indicator

Application

The plug-in 3NJ6 switch disconnectors with fuses are installed in low-voltage distribution boards where a minimum amount of space is available for a maximum number of cable ducts to the power distribution. They can be easily fitted in all common control cabinets (minimum depth: 400 mm).

The plug-in 3NJ62 switch disconnectors with fuses are available for rated uninterrupted currents from 160 A to 630 A.

LV HRC fuse links according to IEC 60269-1/EN 60269-1 (sizes NH 00 to NH 3) or BS fuse links according to BS 88 provide overload and short-circuit protection up to 690 V AC.

The switch disconnectors can be retrofitted at any time with auxiliary switches, an ammeter (48 mm x 48 mm) and current transformers, with no extra space required. For installation in control cabinets of > 400 mm depth, the mounting depth of the disconnectors can be increased by 200 mm using a contact extension. Further installation accessories, such as guide rails and blanking covers, complete the product range.

Function

Fuse monitoring

Fuse monitoring is used to detect, indicate and report faults. The electronic fuse monitoring devices are available in 2 versions.

EFM 10 electronic fuse monitoring devices:

- For use up to 690 V AC
- Operational voltage < 20 V
- Display: ready-to-run
- Individual fault display per phase
- 1 CO contact as centralized fault signaling unit

EFM 20/25 electronic fuse monitoring and line monitoring devices:

- EFM 20 for use up to 690 V AC, EFM 25 for use up to 440 V DC
- Operational voltage < 13 V (EFM 20) < 20 V (EFM 25)
- Test function
- Closed-circuit principle or open-circuit principle
- 2 CO contacts as centralized fault signaling unit incl. line monitoring functions with phase failure detection (EFM 20), undervoltage/overvoltage detection



EFM 10 electronic fuse monitoring device

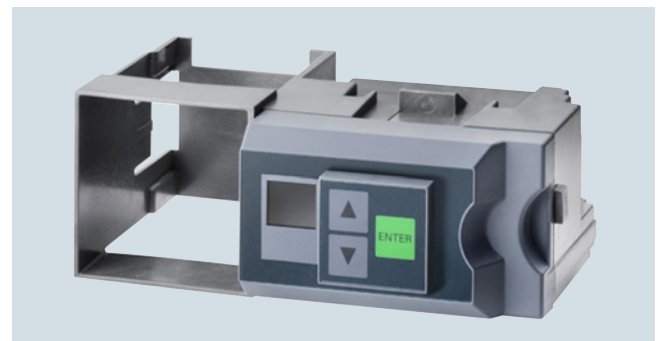

EFM 20/25 electronic fuse monitoring device

Switch Disconnectors

3NJ62 In-Line Switch Disconnectors with Fuses up to 630 A

Introduction

Technical specifications

Main devices of sizes 00 and 1

Size	00								1				
Switch disconnectors with fuses type 3NJ62...	NH			...02-3 ...02-4		...03-1 ...04-1 ...04-2		...03-3 ...03-4		...12-3 ...12-4	...13-1 ...14-1 ...14-2	...13-3 ...13-4	
	BS	...43-3	...53-3	...62-3 ...62-4				...63-3 ...63-4		...72-3 ...72-4	...74-1 ...74-2	...73-3 ...73-4	
Breaking capacity		H	H	H		S		H		H	S	H	
Rated insulation voltage U_i	V	1000											
Rated impulse withstand voltage U_{imp}	V	8000											
Rated operational current I_e	A	63	100	160	-	160	125	160	125	250			
For LV HRC fuse links acc. to IEC 60269		-	-	00 and 000						1			
For BS fuse links acc. to BS 88		A3	A3	00T ¹⁾						B2			
Rated operational voltage U_e													
• At 50/60Hz rated frequency	V	690		--	--	500	690	500	690	690			
• At DC	V	--	--	230	440	--	--	--	--	230	440	-	-
Utilization category		AC23B		DC23B	DC21B	AC22B		AC23B		DC23B	DC21B	AC22B	AC23B
Rated conditional short-circuit current													
• Short-circuit strength (rms value)	kA	100		60		100		100		60		100	
• Short-circuit making capacity (rms value)	kA	66		60		55		66		60		55	66
Rated making capacity													
• p.f. = 0.65	A	--	--	--	--	480	375	--	--	--	--	750	--
• p.f. = 0.45	A	630	1000	--	--	--	--	--	--	--	--	--	--
• p.f. = 0.35	A	--	--	--	--	--	--	1600	1250	--	--	--	2500
Rated breaking capacity													
• p.f. = 0.65	A	--	--	--	--	480	375	--	--	--	--	750	--
• p.f. = 0.45	A	504	800	--	--	--	--	--	--	--	--	--	--
• p.f. = 0.35	A	--	--	--	--	--	--	1280	1000	--	--	--	2000
Endurance													
Operating cycles total		2000		1600				1600					
• Electrical (690 V, p.f. = 0.65)		300		200				200					
Power loss (no fuse links)	W	7	17	43				78					
Permissible ambient temperature	°C	-5...+55											
Permissible mounting positions		Horizontal and vertical with bottom connection											
Degree of protection (in operating state)		IP41											
Connection type		Main conductor connections											
Cable lug connection													
• Conductor cross-section (Al/Cu, solid or stranded) according to DIN 46235 (Cu) and DIN 46239 (Al)	mm ²	1x 10-95 2x 16-70								1x 25-240 2x 25-70			
• Screw size		M8								M12			
• Torque	Nm	15								30			
Terminal connection													
• Conductor cross-section (Al/Cu), rm	mm ²	1x 10-50								1x 16-185			
• Conductor cross-section (Al/Cu), re	mm ²	1x 10-50								1x 16-150			
• Conductor cross-section (Al/Cu), sm	mm ²	1x 16-95								1x 35-240			
• Conductor cross-section (Al/Cu), se	mm ²	1x 16-95								1x 35-300			
• Required torque	Nm	15								25			

¹⁾ The fuse is available from Lawson Fuses (UK) and does not correspond to BS 88.

Switch Disconnectors

3NJ62 In-Line Switch Disconnectors with Fuses up to 630 A

Introduction

Main devices of sizes 2 and 3

Size	2				3					
Switch disconnectors with fuses type 3NJ62...	NH	...22-3 ...22-4	...23-1 ...24-1 ...24-2	...23-3 ...23-4	...32-3 ...32-4	...33-1 ...34-1 ...34-2	...33-3 ...33-4			
	BS	...82-3 ...82-4		...83-3 ...83-4	...92-3 ...92-4	...94-1 ...94-2	...93-3 ...93-4 ...33-3 ...33-4			
Breaking capacity		H	S	H	H	S	H			
Rated insulation voltage U_i	V	1000								
Rated impulse withstand voltage U_{imp}	V	8000								
Rated operational current I_e	A	400		630		500	630	500		
• For fuse links according to IEC 60269/ BS 88										
For fuse links according to IEC 60269		2 and 1			3 and 2					
For BS fuse links acc. to BS 88		B4			3T ¹⁾					
Rated operational voltage U_e	V	--	--	690	230	440	500	690	500	690
• At 50/60Hz rated frequency	V	230	440	--	--	--	--	--	--	--
• At DC	V	--	--	--	--	--	--	--	--	--
Utilization category		DC23B	DC21B	AC22B	AC23B	DC23B	DC21B	AC22B	AC23B	
Rated conditional short-circuit current										
• Short-circuit strength (rms value)	kA	60		100	60	100		66		
• Short-circuit making capacity (rms value)	kA	60		55	66	60		55		
Rated making capacity	A	--	--	1200	--	--	1890	1500	--	--
• p.f. = 0.65	A	--	--	--	--	--	--	--	--	--
• p.f. = 0.45	A	--	--	--	4000	--	--	--	6300	5000
• p.f. = 0.35	A	--	--	--	--	--	--	--	--	--
Rated breaking capacity	A	--	--	1200	--	--	1890	1500	--	--
• p.f. = 0.65	A	--	--	--	--	--	--	--	--	--
• p.f. = 0.45	A	--	--	--	--	--	--	--	--	--
• p.f. = 0.35	A	--	--	--	3200	--	--	--	5040	4000
Endurance										
Operating cycles total		1000			1000					
• Electrical (690 V, p.f. = 0.65)		200			200					
Power loss (no fuse links)	W	158			357					
Permissible ambient temperature	°C	-5...+55								
Permissible mounting positions		Horizontal and vertical with bottom connection								
Degree of protection (in operating state)		IP41								
Connection type		Main conductor connections								
Cable lug connection										
Conductor cross-section	mm ²	1x 25-300 2x 25-240			1x 25-300 2x 25-240					
• Conductor cross-section (Al/Cu, solid or stranded) according to DIN46235 (Cu) and DIN46239 (Al)										
• Screw size	Nm	2x M12			2x M12					
• Torque	Nm	30			30					
Terminal connection										
• Conductor cross-section (Al/Cu), rm	mm ²	2x 16-185			2x 16-185					
• Conductor cross-section (Al/Cu), re	mm ²	2x 16-150			2x 16-150					
• Conductor cross-section (Al/Cu), sm	mm ²	2x 35-240			2x 35-240					
• Conductor cross-section (Al/Cu), se	mm ²	2x 35-300			2x 35-300					
• Required torque	Nm	25			25					

¹⁾ The fuse is available from Lawson Fuses (UK) and does not correspond to BS 88.

Switch Disconnectors

3NJ62 In-Line Switch Disconnectors with Fuses up to 630 A

Introduction

Auxiliary switches

Acc. to IEC 60947-5-1		
Rated insulation voltage U_i	V	690
Rated impulse withstand voltage U_{imp}	V	8000
Rated operational current I_e		
• At AC15, $U_e = 120$ V	A	8
• At AC15, $U_e = 230$ V	A	6
• At AC15, $U_e = 400$ V	A	4
• At AC15, $U_e = 690$ V	A	2

Electronic fuse monitoring, AC version (EFM 10)

Size	00	1	2/3	
Apparent power consumption	VA	S approx. 2.5		
Internal resistance of measurement circuit	MΩ	$R_{in} > 6$		
Storage temperature	°C	-20 ... +80		
Operating temperature	°C	-5 ... +55		
Operating temperature (500 V and/or 500 A)	°C	-5 ... +35		
Prot. rating in closed in-line connector		IP40		
Rated operating voltage of the main control switching devices	V AC	230 ... 690		
	Hz	50/60		
Voltage limits	%	±15		
Signaling relay acc. to IEC 60947-5-1	A	$I_{th} = 1.5$		
	kV	$U_{imp} = 4$		
	V	$U_i = 250$		
Load capacity of the signaling relay				
• U_e	V	24	125	240
• DC - 13; I_e	A	1	0.2	0.1
• AC - 15; I_e	A	1.5		
Short-circuit protection		Max. fuse protection DIAZED 2 A gLgG		

Electronic fuse monitoring, AC version (EFM 20)

Size	00	1	2/3	
Apparent power consumption	VA	S approx. 2.5		
Internal resistance of measurement circuit	MΩ	$R_{in} > 6$		
Storage temperature	°C	-20 ... +80		
Operating temperature	°C	-5 ... +55		
Operating temperature (500 V and/or 500 A)	°C	-5 ... +35		
Protection rating in closed in-line connector		IP40		
Rated operating voltage of the main control switching devices	V AC	230 ... 690		
	Hz	50/60		
Voltage limits	%	±15		
Undervoltage	V	375		
Overvoltage	V	425		
Voltage drop for faulty fuses	V	> 13		
Delay time	s	0.1		
Relay 2		As relay 1 (fuse monitoring)		
Storage function		Off		
Open/closed-circuit principle		Closed-circuit principle		
Mode		Run mode		
Menu option		Display of voltage values/signals		
Signaling relay acc. to IEC 60947-5-1	A	$I_{th} = 1.5$		
	kV	$U_{imp} = 4$		
	V	$U_i = 250$		
Signaling relay 1		1 changeover contact for fuse monitoring only		
Signaling relay 2		1 changeover contact as output for central fault OR as signaling relay 1 (presetting)		
Load capacity of the signaling relay				
• U_e	V	24	125	240
• DC - 13; I_e	A	1	0.2	0.1
• AC - 15; I_e	A	1.5		
Short-circuit protection		Max. fuse protection DIAZED 2 A gLgG		

Electronic fuse monitoring, DC version (EFM 25)

Size	00	1	2/3	
Apparent power consumption	VA	S approx. 2.5		
Internal resist. of measurement circuit	MΩ	$R_{in} > 6$		
Storage temperature	°C	-20 ... +80		
Operating temperature	°C	-5 ... +55		
Operating temperature (500 V and/or 500 A)	°C	-5 ... +35		
Protection rating in closed in-line connector		IP40		
Rated operating voltage of the main control switching devices	V DC	220 ... 440		
Voltage limits	%	±15		
Undervoltage	V	200		
Overvoltage	V	240		
Voltage drop for faulty fuses	V	> 20		
Delay time	s	0.1		
Relay 2		As relay 1 (fuse monitoring)		
Storage function		Off		
Open/closed-circuit principle		Closed-circuit principle		
Mode		Run mode		
Menu option		Display of voltage values/signals		
Signaling relay acc. to IEC 60947-5-1	A	$I_{th} = 1.5$		
	kV	$U_{imp} = 4$		
	V	$U_i = 250$		
Signaling relay 1		1 changeover contact for fuse monitoring only		
Signaling relay 2		1 changeover contact as output for central fault OR as signaling relay 1 (presetting)		
Load capacity of the signaling relay				
• U_e	V	24	125	240
• DC - 13; I_e	A	1	0.2	0.1
• AC - 15; I_e	A	1.5		
Short-circuit protection		Max. fuse protection DIAZED 2 A gLgG		

Ammeters

Inputs		x/1 A or x/5 A	
Overload		1.2 times	
• Moving-iron measuring instruments		2 times	
• Bi-metal measuring instruments			
Slave pointer		--	
• Moving-iron measuring instruments	min	15	
• Bi-metal measuring instruments	min		
Power consumption		0.6	
• Moving-iron measuring instruments	VA	1	
• Bi-metal measuring instruments	VA		

Motorized operating mechanism

Size	00	1	2/3	
Control supply voltage	V DC	24 ± 2		
Power consumption	A	1.1	1.3	2.8
Service life (no limitation of switch disconnector according to IEC 60947-3)		1600		
Operating cycles total		200		
Switch cycles under load				
Signal duration	s	Min. 0.5 or continuous signal		

Switch Disconnectors

3NJ62 In-Line Switch Disconnectors with Fuses up to 630 A

For LV HRC fuse links

Selection and ordering data

Rated current I_n	Size	DT	Article No.	Price per PU	PU (UNIT, SET, M)	PS*/P. unit	PG	Weight per PU approx. kg
2-pole, high breaking capacity H								
Manually operated								
160	00		3NJ6202-3AA0□-0AA0		1	1 unit	143	3.630
250	1		3NJ6212-3AA0□-0AA0		1	1 unit	143	6.750
400	2		3NJ6222-3AA0□-0AA0		1	1 unit	143	15.000
630	3		3NJ6232-3AA0□-0AA0		1	1 unit	143	15.360
Manually operated, EFM 25								
160	00		3NJ6202-3AE0□-0AA0		1	1 unit	143	3.830
250	1		3NJ6212-3AE0□-0AA0		1	1 unit	143	6.950
400	2		3NJ6222-3AE0□-0AA0		1	1 unit	143	15.200
630	3		3NJ6232-3AE0□-0AA0		1	1 unit	143	15.560
Motorized operating mechanism								
160	00		3NJ6202-4AA0□-0AA0		1	1 unit	143	3.630
250	1		3NJ6212-4AA0□-0AA0		1	1 unit	143	6.750
400	2		3NJ6222-4AA0□-0AA0		1	1 unit	143	15.000
630	3		3NJ6232-4AA0□-0AA0		1	1 unit	143	15.360
Mot. operat. mechanism, EFM 25								
160	00		3NJ6202-4AE0□-0AA0		1	1 unit	143	4.330
250	1		3NJ6212-4AE0□-0AA0		1	1 unit	143	7.450
400	2		3NJ6222-4AE0□-0AA0		1	1 unit	143	15.700
630	3		3NJ6232-4AE0□-0AA0		1	1 unit	143	16.060
3-pole, standard breaking capacity S								
Manually operated								
160	00		3NJ6203-1AA0□-□□□□		1	1 unit	143	3.630
250	1		3NJ6213-1AA0□-□□□□		1	1 unit	143	6.750
400	2		3NJ6223-1AA0□-□□□□		1	1 unit	143	15.000
630	3		3NJ6233-1AA0□-□□□□		1	1 unit	143	15.360
Manually operated, EFM 10								
160	00		3NJ6203-1AB0□-□□□□		1	1 unit	143	3.830
250	1		3NJ6213-1AB0□-□□□□		1	1 unit	143	6.950
400	2		3NJ6223-1AB0□-□□□□		1	1 unit	143	15.200
630	3		3NJ6233-1AB0□-□□□□		1	1 unit	143	15.560
Manually operated, EFM 20								
160	00		3NJ6203-1AC0□-□□□□		1	1 unit	143	3.830
250	1		3NJ6213-1AC0□-□□□□		1	1 unit	143	6.950
400	2		3NJ6223-1AC0□-□□□□		1	1 unit	143	15.200
630	3		3NJ6233-1AC0□-□□□□		1	1 unit	143	15.560
3-pole, high breaking capacity H								
Manually operated								
160	00		3NJ6203-3AA0□-□□□□		1	1 unit	143	3.630
250	1		3NJ6213-3AA0□-□□□□		1	1 unit	143	6.750
400	2		3NJ6223-3AA0□-□□□□		1	1 unit	143	15.000
630	3		3NJ6233-3AA0□-□□□□		1	1 unit	143	15.360
Manually operated, EFM 10								
160	00		3NJ6203-3AB0□-□□□□		1	1 unit	143	3.830
250	1		3NJ6213-3AB0□-□□□□		1	1 unit	143	6.950
400	2		3NJ6223-3AB0□-□□□□		1	1 unit	143	15.200
630	3		3NJ6233-3AB0□-□□□□		1	1 unit	143	15.560
Manually operated, EFM 20								
160	00		3NJ6203-3AC0□-□□□□		1	1 unit	143	3.830
250	1		3NJ6213-3AC0□-□□□□		1	1 unit	143	6.950
400	2		3NJ6223-3AC0□-□□□□		1	1 unit	143	15.200
630	3		3NJ6233-3AC0□-□□□□		1	1 unit	143	15.560
Motorized operating mechanism								
160	00		3NJ6203-4AA0□-□□□□		1	1 unit	143	3.630
250	1		3NJ6213-4AA0□-□□□□		1	1 unit	143	6.750
400	2		3NJ6223-4AA0□-□□□□		1	1 unit	143	15.000
630	3		3NJ6233-4AA0□-□□□□		1	1 unit	143	15.360
Mot. operat. mechanism, EFM 10								
160	00		3NJ6203-4AB0□-□□□□		1	1 unit	143	4.330
250	1		3NJ6213-4AB0□-□□□□		1	1 unit	143	7.450
400	2		3NJ6223-4AB0□-□□□□		1	1 unit	143	15.700
630	3		3NJ6233-4AB0□-□□□□		1	1 unit	143	16.060
Mot. operat. mechanism, EFM 20								
160	00		3NJ6203-4AC0□-□□□□		1	1 unit	143	4.330
250	1		3NJ6213-4AC0□-□□□□		1	1 unit	143	7.450
400	2		3NJ6223-4AC0□-□□□□		1	1 unit	143	15.700
630	3		3NJ6233-4AC0□-□□□□		1	1 unit	143	16.060

Article No. supplement

Add. price

Standard Article No. supplement
(more Article No. supplements from page 7/99 onwards)

Without aux. switches, ammeters, current transform. ▶



None

Switch Disconnectors

3NJ62 In-Line Switch Disconnectors with Fuses up to 630 A

For LV HRC fuse links

Rated current I_n	Size	DT	Article No.	Price per PU	PU (UNIT, SET, M)	PS*/P. unit	PG	Weight per PU approx. kg
4-pole, standard breaking capacity S								
Manually operated								
160	00		3NJ6204-1AA0□-□□□□		1	1 unit	143	6.160
250	1		3NJ6214-1AA0□-□□□□		1	1 unit	143	10.380
400	2		3NJ6224-1AA0□-□□□□		1	1 unit	143	18.900
630	3		3NJ6234-1AA0□-□□□□		1	1 unit	143	20.000
Manually operated, EFM 10								
160	00		3NJ6204-1AB0□-□□□□		1	1 unit	143	6.830
250	1		3NJ6214-1AB0□-□□□□		1	1 unit	143	9.950
400	2		3NJ6224-1AB0□-□□□□		1	1 unit	143	18.200
630	3		3NJ6234-1AB0□-□□□□		1	1 unit	143	18.560
Manually operated, EFM 20								
160	00		3NJ6204-1AC0□-□□□□		1	1 unit	143	6.830
250	1		3NJ6214-1AC0□-□□□□		1	1 unit	143	9.950
400	2		3NJ6224-1AC0□-□□□□		1	1 unit	143	18.200
630	3		3NJ6234-1AC0□-□□□□		1	1 unit	143	18.560
Motorized operating mechanism								
160	00		3NJ6204-2AA0□-□□□□		1	1 unit	143	6.160
250	1		3NJ6214-2AA0□-□□□□		1	1 unit	143	10.380
400	2		3NJ6224-2AA0□-□□□□		1	1 unit	143	18.900
630	3		3NJ6234-2AA0□-□□□□		1	1 unit	143	20.000
Mot. operat. mechanism, EFM 10								
160	00		3NJ6204-2AB0□-□□□□		1	1 unit	143	7.330
250	1		3NJ6214-2AB0□-□□□□		1	1 unit	143	10.450
400	2		3NJ6224-2AB0□-□□□□		1	1 unit	143	18.700
630	3		3NJ6234-2AB0□-□□□□		1	1 unit	143	19.060
Mot. operat. mechanism, EFM 20								
160	00		3NJ6204-2AC0□-□□□□		1	1 unit	143	7.330
250	1		3NJ6214-2AC0□-□□□□		1	1 unit	143	10.450
400	2		3NJ6224-2AC0□-□□□□		1	1 unit	143	18.700
630	3		3NJ6234-2AC0□-□□□□		1	1 unit	143	19.060

Article No. supplement

Additional price

Standard Article No. supplement
(more Article No. supplements from page 7/99 onwards)

Without auxiliary switches, ammeters, current transformers ▶



None

Switch Disconnectors

3NJ62 In-Line Switch Disconnectors with Fuses up to 630 A

For BS fuse links

Selection and ordering data

Rated current I_n	Size	DT	Article No.	Price per PU	PU (UNIT, SET, M)	PS*/P. unit	PG	Weight per PU approx. kg
2-pole, high breaking capacity H								
Manually operated								
160	00T ¹⁾		3NJ6262-3AA0□-0AA0		1	1 unit	143	3.630
250	B2		3NJ6272-3AA0□-0AA0		1	1 unit	143	6.750
400	B4		3NJ6282-3AA0□-0AA0		1	1 unit	143	15.000
630	3T ¹⁾		3NJ6292-3AA0□-0AA0		1	1 unit	143	15.360
Manually operated, EFM 25								
160	00T ¹⁾		3NJ6262-3AE0□-0AA0		1	1 unit	143	3.830
250	B2		3NJ6272-3AE0□-0AA0		1	1 unit	143	6.950
400	B4		3NJ6282-3AE0□-0AA0		1	1 unit	143	15.200
630	3T ¹⁾		3NJ6292-3AE0□-0AA0		1	1 unit	143	15.560
Motorized operating mechanism								
160	00T ¹⁾		3NJ6262-4AA0□-0AA0		1	1 unit	143	3.630
250	B2		3NJ6272-4AA0□-0AA0		1	1 unit	143	6.750
400	B4		3NJ6282-4AA0□-0AA0		1	1 unit	143	15.000
630	3T ¹⁾		3NJ6292-4AA0□-0AA0		1	1 unit	143	15.360
Mot. operat. mechanism, EFM 25								
160	00T ¹⁾		3NJ6262-4AE0□-0AA0		1	1 unit	143	4.330
250	B2		3NJ6272-4AE0□-0AA0		1	1 unit	143	7.450
400	B4		3NJ6282-4AE0□-0AA0		1	1 unit	143	15.700
630	3T ¹⁾		3NJ6292-4AE0□-0AA0		1	1 unit	143	16.060
3-pole, high breaking capacity H								
Manually operated								
63	A3		3NJ6243-3AA0□-□□□□		1	1 unit	143	3.630
100	A3		3NJ6253-3AA0□-□□□□		1	1 unit	143	3.630
160	00T ¹⁾		3NJ6263-3AA0□-□□□□		1	1 unit	143	3.630
250	B2		3NJ6273-3AA0□-□□□□		1	1 unit	143	6.750
400	B4		3NJ6283-3AA0□-□□□□		1	1 unit	143	15.000
630	3T ¹⁾		3NJ6293-3AA0□-□□□□		1	1 unit	143	15.360
Manually operated, EFM 10								
160	00T ¹⁾		3NJ6263-3AB0□-□□□□		1	1 unit	143	3.830
250	B2		3NJ6273-3AB0□-□□□□		1	1 unit	143	6.950
400	B4		3NJ6283-3AB0□-□□□□		1	1 unit	143	15.200
630	3T ¹⁾		3NJ6293-3AB0□-□□□□		1	1 unit	143	15.560
Manually operated, EFM 20								
160	00T ¹⁾		3NJ6263-3AC0□-□□□□		1	1 unit	143	3.830
250	B2		3NJ6273-3AC0□-□□□□		1	1 unit	143	6.950
400	B4		3NJ6283-3AC0□-□□□□		1	1 unit	143	15.200
630	3T ¹⁾		3NJ6293-3AC0□-□□□□		1	1 unit	143	15.560
Motorized operating mechanism								
160	00T ¹⁾		3NJ6263-4AA0□-□□□□		1	1 unit	143	3.630
250	B2		3NJ6273-4AA0□-□□□□		1	1 unit	143	6.750
400	B4		3NJ6283-4AA0□-□□□□		1	1 unit	143	15.000
630	3T ¹⁾		3NJ6293-4AA0□-□□□□		1	1 unit	143	15.360
Mot. operat. mechanism, EFM 10								
160	00T ¹⁾		3NJ6263-4AB0□-□□□□		1	1 unit	143	4.330
250	B2		3NJ6273-4AB0□-□□□□		1	1 unit	143	7.450
400	B4		3NJ6283-4AB0□-□□□□		1	1 unit	143	15.700
630	3T ¹⁾		3NJ6293-4AB0□-□□□□		1	1 unit	143	16.060
Mot. operat. mechanism, EFM 20								
160	00T ¹⁾		3NJ6263-4AC0□-□□□□		1	1 unit	143	4.330
250	B2		3NJ6273-4AC0□-□□□□		1	1 unit	143	7.450
400	B4		3NJ6283-4AC0□-□□□□		1	1 unit	143	15.700
630	3T ¹⁾		3NJ6293-4AC0□-□□□□		1	1 unit	143	16.060

Article No. supplement

Additional price

Standard Article No. supplement
 (more Article No. supplements from page 7/99 onwards)

Without auxiliary switches, ammeters, current transformers



None

¹⁾ The fuse is available from Lawson Fuses (UK) and does not correspond to BS 88.

Switch Disconnectors

3NJ62 In-Line Switch Disconnectors with Fuses up to 630 A

For BS fuse links

Rated current I_n	Size	DT	Article No.	Price per PU	PU (UNIT, SET, M)	PS*/P. unit	PG	Weight per PU approx. kg
4-pole, standard breaking capacity S								
Manually operated								
160	00T ¹⁾		3NJ6264-1AA0□-□□□□		1	1 unit	143	6.160
250	B2		3NJ6274-1AA0□-□□□□		1	1 unit	143	10.380
400	B4		3NJ6284-1AA0□-□□□□		1	1 unit	143	18.900
630	3T ¹⁾		3NJ6294-1AA0□-□□□□		1	1 unit	143	20.000
Manually operated, EFM 10								
160	00T ¹⁾		3NJ6264-1AB0□-□□□□		1	1 unit	143	6.830
250	B2		3NJ6274-1AB0□-□□□□		1	1 unit	143	9.950
400	B4		3NJ6284-1AB0□-□□□□		1	1 unit	143	18.200
630	3T ¹⁾		3NJ6294-1AB0□-□□□□		1	1 unit	143	18.560
Manually operated, EFM 20								
160	00T ¹⁾		3NJ6264-1AC0□-□□□□		1	1 unit	143	6.830
250	B2		3NJ6274-1AC0□-□□□□		1	1 unit	143	9.950
400	B4		3NJ6284-1AC0□-□□□□		1	1 unit	143	18.200
630	3T ¹⁾		3NJ6294-1AC0□-□□□□		1	1 unit	143	18.560
Motorized operating mechanism								
160	00T ¹⁾		3NJ6264-2AA0□-□□□□		1	1 unit	143	6.160
250	B2		3NJ6274-2AA0□-□□□□		1	1 unit	143	10.380
400	B4		3NJ6284-2AA0□-□□□□		1	1 unit	143	18.900
630	3T ¹⁾		3NJ6294-2AA0□-□□□□		1	1 unit	143	20.000
Mot. operat. mechanism, EFM 10								
160	00T ¹⁾		3NJ6264-2AB0□-□□□□		1	1 unit	143	7.330
250	B2		3NJ6274-2AB0□-□□□□		1	1 unit	143	10.450
400	B4		3NJ6284-2AB0□-□□□□		1	1 unit	143	18.700
630	3T ¹⁾		3NJ6294-2AB0□-□□□□		1	1 unit	143	19.060
Mot. operat. mechanism, EFM 20								
160	00T ¹⁾		3NJ6264-2AC0□-□□□□		1	1 unit	143	7.330
250	B2		3NJ6274-2AC0□-□□□□		1	1 unit	143	10.450
400	B4		3NJ6284-2AC0□-□□□□		1	1 unit	143	18.700
630	3T ¹⁾		3NJ6294-2AC0□-□□□□		1	1 unit	143	19.060

Article No. supplement

Additional price

Standard Article No. supplement
(more Article No. supplements from page 7/99 onwards)

Without auxiliary switches, ammeters, current transformers ▶



None

Switch Disconnectors

3NJ62 In-Line Switch Disconnectors with Fuses up to 630 A

For LV HRC and BS fuse links

Options

1st Article No. supplement:
Auxiliary switch wired to multi-function plug

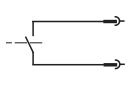
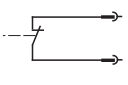
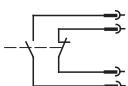
		DT	Article No. supplement 3NJ62...-...□-....	Additional price	PS*/ P. unit
Without		▶	0	None	1 unit
	1 NO contact		1	✓	1 unit
	1 NC contact		2	✓	1 unit
	1 NO contact + 1 NC contact		3	✓	1 unit

2nd Article No. supplement:
Ammeter and current transformer wired

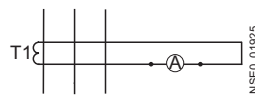
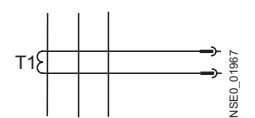
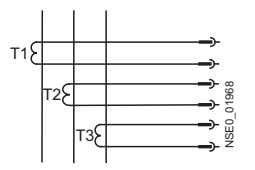
	Ammeters	Current transformers			DT	Article No. supplement 3NJ62...-...□□□□	Additional price	PS*/ P. unit	
		Primary current A	Secondary current A	Accuracy class					
For size 00 and 00T									
Without		Without	Without	Without	▶	0 A A 0	None	1 unit	
1 current transformer to 1 ammeter									
	Moving iron	50	1	1		1 DB 1	✓	1 unit	
	Moving iron	50	5	1		1 DB 4	✓	1 unit	
	Moving iron	100	1	1		1 DD 1	✓	1 unit	
	Moving iron	100	5	1		1 DD 4	✓	1 unit	
	Moving iron	150	1	1		1 DE 1	✓	1 unit	
	Moving iron	150	5	1		1 DE 4	✓	1 unit	
	Bi-metal	50	1	1		2 DB 1	✓	1 unit	
	Bi-metal	50	5	1		2 DB 4	✓	1 unit	
	Bi-metal	100	1	1		2 DD 1	✓	1 unit	
	Bi-metal	100	5	1		2 DD 4	✓	1 unit	
	Bi-metal	150	1	1		2 DE 1	✓	1 unit	
	Bi-metal	150	5	1		2 DE 4	✓	1 unit	
1 current transformer to multi-function plug									
	Without	50	1	1		0 BB 1	✓	1 unit	
	Without	50	5	1		0 BB 4	✓	1 unit	
	Without	100	1	1		0 BD 1	✓	1 unit	
	Without	100	1	0.5		0 BD 2	✓	1 unit	
	Without	100	1	0.5 calibrated		0 BD 3	✓	1 unit	
	Without	100	5	1		0 BD 4	✓	1 unit	
	Without	100	5	0.5		0 BD 5	✓	1 unit	
	Without	100	5	0.5 calibrated		0 BD 6	✓	1 unit	
	Without	150	1	1		0 BE 1	✓	1 unit	
	Without	150	1	0.5		0 BE 2	✓	1 unit	
	Without	150	1	0.5 calibrated		0 BE 3	✓	1 unit	
	Without	150	5	1		0 BE 4	✓	1 unit	
	Without	150	5	0.5		0 BE 5	✓	1 unit	
	Without	150	5	0.5 calibrated		0 BE 6	✓	1 unit	
	3 current transformers to multi-function plug								
		Without	50	1	1		0 CB 1	✓	1 unit
		Without	50	5	1		0 CB 4	✓	1 unit
		Without	100	1	1		0 CD 1	✓	1 unit
Without		100	1	0.5		0 CD 2	✓	1 unit	
Without		100	1	0.5 calibrated		0 CD 3	✓	1 unit	
Without		100	5	1		0 CD 4	✓	1 unit	
Without		100	5	0.5		0 CD 5	✓	1 unit	
Without		100	5	0.5 calibrated		0 CD 6	✓	1 unit	
Without		150	1	1		0 CE 1	✓	1 unit	
Without		150	1	0.5		0 CE 2	✓	1 unit	
Without		150	1	0.5 calibrated		0 CE 3	✓	1 unit	
Without		150	5	1		0 CE 4	✓	1 unit	
Without		150	5	0.5		0 CE 5	✓	1 unit	
Without		150	5	0.5 calibrated		0 CE 6	✓	1 unit	

* You can order this quantity or a multiple thereof.



Switch Disconnectors

3NJ62 In-Line Switch Disconnectors with Fuses up to 630 A

For LV HRC and BS fuse links

	Ammeters	Current transformers			DT	Article No. supplement 3NJ62...-.....□□□□ ↑↑↑↑	Additional price	PS*/ P. unit
		Primary current A	Secondary current A	Accuracy class				
For size 00 and 00T (continued)								
1 current transformer to 1 ammeter and multi-function plug								
	Moving iron	50	1	1		1EB1	✓	1 unit
	Moving iron	50	5	1		1EB4	✓	1 unit
	Moving iron	100	1	1		1ED1	✓	1 unit
	Moving iron	100	1	0.5		1ED2	✓	1 unit
	Moving iron	100	1	0.5 calibrated		1ED3	✓	1 unit
	Moving iron	100	5	1		1ED4	✓	1 unit
	Moving iron	100	5	0.5		1ED5	✓	1 unit
	Moving iron	100	5	0.5 calibrated		1ED6	✓	1 unit
	Moving iron	150	1	1		1EE1	✓	1 unit
	Moving iron	150	1	0.5		1EE2	✓	1 unit
	Moving iron	150	1	0.5 calibrated		1EE3	✓	1 unit
	Moving iron	150	5	1		1EE4	✓	1 unit
	Moving iron	150	5	0.5		1EE5	✓	1 unit
	Moving iron	150	5	0.5 calibrated		1EE6	✓	1 unit
	Bi-metal	50	1	1		2EB1	✓	1 unit
	Bi-metal	50	5	1		2EB4	✓	1 unit
	Bi-metal	100	1	1		2ED1	✓	1 unit
	Bi-metal	100	1	0.5		2ED2	✓	1 unit
	Bi-metal	100	1	0.5 calibrated		2ED3	✓	1 unit
	Bi-metal	100	5	1		2ED4	✓	1 unit
	Bi-metal	100	5	0.5		2ED5	✓	1 unit
	Bi-metal	100	5	0.5 calibrated		2ED6	✓	1 unit
	Bi-metal	150	1	1		2EE1	✓	1 unit
	Bi-metal	150	1	0.5		2EE2	✓	1 unit
Bi-metal	150	1	0.5 calibrated		2EE3	✓	1 unit	
Bi-metal	150	5	1		2EE4	✓	1 unit	
Bi-metal	150	5	0.5		2EE5	✓	1 unit	
Bi-metal	150	5	0.5 calibrated		2EE6	✓	1 unit	
3 current transformers to 1 ammeter and multi-function plug								
	Moving iron	50	1	1		1FB1	✓	1 unit
	Moving iron	50	5	1		1FB4	✓	1 unit
	Moving iron	100	1	1		1FD1	✓	1 unit
	Moving iron	100	1	0.5		1FD2	✓	1 unit
	Moving iron	100	1	0.5 calibrated		1FD3	✓	1 unit
	Moving iron	100	5	1		1FD4	✓	1 unit
	Moving iron	100	5	0.5		1FD5	✓	1 unit
	Moving iron	100	5	0.5 calibrated		1FD6	✓	1 unit
	Moving iron	150	1	1		1FE1	✓	1 unit
	Moving iron	150	5	0.5		1FE2	✓	1 unit
	Moving iron	150	5	0.5 calibrated		1FE3	✓	1 unit
	Moving iron	150	5	1		1FE4	✓	1 unit
	Moving iron	150	5	0.5		1FE5	✓	1 unit
	Moving iron	150	5	0.5 calibrated		1FE6	✓	1 unit
	Bi-metal	50	1	1		2FB1	✓	1 unit
	Bi-metal	50	5	1		2FB4	✓	1 unit
	Bi-metal	100	1	1		2FD1	✓	1 unit
	Bi-metal	100	1	0.5		2FD2	✓	1 unit
	Bi-metal	100	1	0.5 calibrated		2FD3	✓	1 unit
	Bi-metal	100	5	1		2FD4	✓	1 unit
	Bi-metal	100	5	0.5		2FD5	✓	1 unit
	Bi-metal	100	5	0.5 calibrated		2FD6	✓	1 unit
	Bi-metal	150	1	1		2FE1	✓	1 unit
	Bi-metal	150	1	0.5		2FE2	✓	1 unit
Bi-metal	150	1	0.5 calibrated		2FE3	✓	1 unit	
Bi-metal	150	5	1		2FE4	✓	1 unit	
Bi-metal	150	5	0.5		2FE5	✓	1 unit	
Bi-metal	150	5	0.5 calibrated		2FE6	✓	1 unit	

Switch Disconnectors

3NJ62 In-Line Switch Disconnectors with Fuses up to 630 A

For LV HRC and BS fuse links

	Ammeters	Current transformers			DT	Article No. supplement 3NJ62...-.....□□□□ ↑↑↑↑↑	Additional price	PS*/ P. unit	
		Primary current A	Secondary current A	Accuracy class					
For size 1 and B2									
	Without	Without	Without	Without		0AA0	None	1 unit	
	1 current transformer to 1 ammeter								
<p>NSE0_01925</p>	Moving iron	50	1	1		1DB1	✓	1 unit	
	Moving iron	50	5	1		1DB4	✓	1 unit	
	Moving iron	100	1	1		1DD1	✓	1 unit	
	Moving iron	100	5	1		1DD4	✓	1 unit	
	Moving iron	150	1	1		1DE1	✓	1 unit	
	Moving iron	150	5	1		1DE4	✓	1 unit	
	Moving iron	200	1	1		1DF1	✓	1 unit	
	Moving iron	200	5	1		1DF4	✓	1 unit	
	Moving iron	250	1	1		1DG1	✓	1 unit	
	Moving iron	250	5	1		1DG4	✓	1 unit	
	Bi-metal	50	1	1		2DB1	✓	1 unit	
	Bi-metal	50	5	1		2DB4	✓	1 unit	
	Bi-metal	100	1	1		2DD1	✓	1 unit	
	Bi-metal	100	5	1		2DD4	✓	1 unit	
Bi-metal	150	1	1		2DE1	✓	1 unit		
Bi-metal	150	5	1		2DE4	✓	1 unit		
Bi-metal	200	1	1		2DF1	✓	1 unit		
Bi-metal	200	5	1		2DF4	✓	1 unit		
Bi-metal	250	1	1		2DG1	✓	1 unit		
Bi-metal	250	5	1		2DG4	✓	1 unit		
	1 current transformer to multi-function plug								
<p>NSE0_01967</p>	Without	50	1	1		0BB1	✓	1 unit	
	Without	50	5	1		0BB4	✓	1 unit	
	Without	100	1	1		0BD1	✓	1 unit	
	Without	100	1	0.5		0BD2	✓	1 unit	
	Without	100	5	1		0BD4	✓	1 unit	
	Without	100	5	0.5		0BD5	✓	1 unit	
	Without	150	1	1		0BE1	✓	1 unit	
	Without	150	1	0.5		0BE2	✓	1 unit	
	Without	150	5	1		0BE4	✓	1 unit	
	Without	150	5	0.5		0BE5	✓	1 unit	
	Without	200	1	1		0BF1	✓	1 unit	
	Without	200	1	0.5		0BF2	✓	1 unit	
	Without	200	5	1		0BF4	✓	1 unit	
	Without	200	5	0.5		0BF5	✓	1 unit	
	Without	250	1	1		0BG1	✓	1 unit	
	Without	250	1	0.5		0BG2	✓	1 unit	
	Without	250	5	1		0BG4	✓	1 unit	
	Without	250	5	0.5		0BG5	✓	1 unit	
		3 current transformers to multi-function plug							
	<p>NSE0_01968</p>	Without	50	1	1		0CB1	✓	1 unit
Without		50	5	1		0CB4	✓	1 unit	
Without		100	1	1		0CD1	✓	1 unit	
Without		100	1	0.5		0CD2	✓	1 unit	
Without		100	5	1		0CD4	✓	1 unit	
Without		100	5	0.5		0CD5	✓	1 unit	
Without		150	1	1		0CE1	✓	1 unit	
Without		150	1	0.5		0CE2	✓	1 unit	
Without		150	5	1		0CE4	✓	1 unit	
Without		150	5	0.5		0CE5	✓	1 unit	
Without		200	1	1		0CF1	✓	1 unit	
Without		200	1	0.5		0CF2	✓	1 unit	
Without		200	5	1		0CF4	✓	1 unit	
Without		200	5	0.5		0CF5	✓	1 unit	
Without		250	1	1		0CG1	✓	1 unit	
Without		250	1	0.5		0CG2	✓	1 unit	
Without		250	5	1		0CG4	✓	1 unit	
Without		250	5	0.5		0CG5	✓	1 unit	

Switch Disconnectors

3NJ62 In-Line Switch Disconnectors with Fuses up to 630 A

For LV HRC and BS fuse links

Ammeters	Current transformers			DT	Article No. supplement 3NJ62...-...-□□□□ ↑↑↑↑	Additional price	PS*/ P. unit
	Primary current A	Secondary current A	Accuracy class				

For size 1 and B2 (continued)

1 current transformer to 1 ammeter and multi-function plug

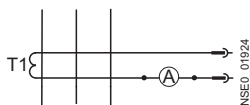

Moving iron	50	1	1	1EB1	✓	1 unit
Moving iron	50	5	1	1EB4	✓	1 unit
Moving iron	100	1	1	1ED1	✓	1 unit
Moving iron	100	1	0.5	1ED2	✓	1 unit
Moving iron	100	5	1	1ED4	✓	1 unit
Moving iron	100	5	0.5	1ED5	✓	1 unit
Moving iron	150	1	1	1EE1	✓	1 unit
Moving iron	150	1	0.5	1EE2	✓	1 unit
Moving iron	150	5	1	1EE4	✓	1 unit
Moving iron	150	5	0.5	1EE5	✓	1 unit
Moving iron	200	1	1	1EF1	✓	1 unit
Moving iron	200	1	0.5	1EF2	✓	1 unit
Moving iron	200	5	1	1EF4	✓	1 unit
Moving iron	200	5	0.5	1EF5	✓	1 unit
Moving iron	250	1	1	1EG1	✓	1 unit
Moving iron	250	1	0.5	1EG2	✓	1 unit
Moving iron	250	5	1	1EG4	✓	1 unit
Moving iron	250	5	0.5	1EG5	✓	1 unit
Bi-metal	50	1	1	2EB1	✓	1 unit
Bi-metal	50	5	1	2EB4	✓	1 unit
Bi-metal	100	1	1	2ED1	✓	1 unit
Bi-metal	100	1	0.5	2ED2	✓	1 unit
Bi-metal	100	5	1	2ED4	✓	1 unit
Bi-metal	100	5	0.5	2ED5	✓	1 unit
Bi-metal	150	1	1	2EE1	✓	1 unit
Bi-metal	150	1	0.5	2EE2	✓	1 unit
Bi-metal	150	5	1	2EE4	✓	1 unit
Bi-metal	150	5	0.5	2EE5	✓	1 unit
Bi-metal	200	1	1	2EF1	✓	1 unit
Bi-metal	200	1	0.5	2EF2	✓	1 unit
Bi-metal	200	5	1	2EF4	✓	1 unit
Bi-metal	200	5	0.5	2EF5	✓	1 unit
Bi-metal	250	1	1	2EG1	✓	1 unit
Bi-metal	250	1	0.5	2EG2	✓	1 unit
Bi-metal	250	5	1	2EG4	✓	1 unit
Bi-metal	250	5	0.5	2EG5	✓	1 unit

3 current transformers to 1 ammeter and multi-function plug

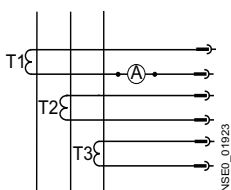

Moving iron	50	1	1	1FB1	✓	1 unit
Moving iron	50	5	1	1FB4	✓	1 unit
Moving iron	100	1	1	1FD1	✓	1 unit
Moving iron	100	1	0.5	1FD2	✓	1 unit
Moving iron	100	5	1	1FD4	✓	1 unit
Moving iron	100	5	0.5	1FD5	✓	1 unit
Moving iron	150	1	1	1FE1	✓	1 unit
Moving iron	150	1	0.5	1FE2	✓	1 unit
Moving iron	150	5	1	1FE4	✓	1 unit
Moving iron	150	5	0.5	1FE5	✓	1 unit
Moving iron	200	1	1	1FF1	✓	1 unit
Moving iron	200	1	0.5	1FF2	✓	1 unit
Moving iron	200	5	1	1FF4	✓	1 unit
Moving iron	200	5	0.5	1FF5	✓	1 unit
Moving iron	250	1	1	1FG1	✓	1 unit
Moving iron	250	1	0.5	1FG2	✓	1 unit
Moving iron	250	5	1	1FG4	✓	1 unit
Moving iron	250	5	0.5	1FG5	✓	1 unit
Bi-metal	50	1	1	2FB1	✓	1 unit
Bi-metal	50	5	1	2FB4	✓	1 unit
Bi-metal	100	1	1	2FD1	✓	1 unit
Bi-metal	100	1	0.5	2FD2	✓	1 unit
Bi-metal	100	5	1	2FD4	✓	1 unit
Bi-metal	100	5	0.5	2FD5	✓	1 unit
Bi-metal	150	1	1	2FE1	✓	1 unit
Bi-metal	150	1	0.5	2FE2	✓	1 unit
Bi-metal	150	5	1	2FE4	✓	1 unit
Bi-metal	150	5	0.5	2FE5	✓	1 unit
Bi-metal	200	1	1	2FF1	✓	1 unit
Bi-metal	200	1	0.5	2FF2	✓	1 unit
Bi-metal	200	5	1	2FF4	✓	1 unit
Bi-metal	200	5	0.5	2FF5	✓	1 unit
Bi-metal	250	1	1	2FG1	✓	1 unit
Bi-metal	250	1	0.5	2FG2	✓	1 unit
Bi-metal	250	5	1	2FG4	✓	1 unit
Bi-metal	250	5	0.5	2FG5	✓	1 unit

Switch Disconnectors

3NJ62 In-Line Switch Disconnectors with Fuses up to 630 A

For LV HRC and BS fuse links

	Ammeters	Current transformers			DT	Article No. supplement 3NJ62...-.....□□□□ ↑↑↑↑	Additional price	PS*/ P. unit	
		Primary current A	Secondary current A	Accuracy class					
For size 2 and B4									
	Without	Without	Without			0AA0	None	1 unit	
	1 current transformer to 1 ammeter								
	Moving iron	300	1	1		1DH1	✓	1 unit	
	Moving iron	300	5	1		1DH4	✓	1 unit	
	Moving iron	400	1	1		1DJ1	✓	1 unit	
	Moving iron	400	5	1		1DJ4	✓	1 unit	
	Bi-metal	300	1	1		2DH1	✓	1 unit	
	Bi-metal	300	5	1		2DH4	✓	1 unit	
	Bi-metal	400	1	1		2DJ1	✓	1 unit	
	Bi-metal	400	5	1		2DJ4	✓	1 unit	
	1 current transformer to multi-function plug								
	Without	300	1	1		0BH1	✓	1 unit	
	Without	300	1	0.5		0BH2	✓	1 unit	
	Without	300	1	0.5 calibrated		0BH3	✓	1 unit	
	Without	300	5	1		0BH4	✓	1 unit	
	Without	300	5	0.5		0BH5	✓	1 unit	
	Without	300	5	0.5 calibrated		0BH6	✓	1 unit	
	Without	400	1	1		0BJ1	✓	1 unit	
	Without	400	1	0.5		0BJ2	✓	1 unit	
	Without	400	1	0.5 calibrated		0BJ3	✓	1 unit	
	Without	400	5	1		0BJ4	✓	1 unit	
	Without	400	5	0.5		0BJ5	✓	1 unit	
	Without	400	5	0.5 calibrated		0BJ6	✓	1 unit	
		3 current transformers to multi-function plug							
		Without	300	1	1		0CH1	✓	1 unit
Without		300	1	0.5		0CH2	✓	1 unit	
Without		300	1	0.5 calibrated		0CH3	✓	1 unit	
Without		300	5	1		0CH4	✓	1 unit	
Without		300	5	0.5		0CH5	✓	1 unit	
Without		300	5	0.5 calibrated		0CH6	✓	1 unit	
Without		400	1	1		0CJ1	✓	1 unit	
Without		400	1	0.5		0CJ2	✓	1 unit	
Without		400	1	0.5 calibrated		0CJ3	✓	1 unit	
Without		400	5	1		0CJ4	✓	1 unit	
Without		400	5	0.5		0CJ5	✓	1 unit	
Without		400	5	0.5 calibrated		0CJ6	✓	1 unit	
		1 current transformer to 1 ammeter and multi-function plug							
		Moving iron	300	1	1		1EH1	✓	1 unit
	Moving iron	300	1	0.5		1EH2	✓	1 unit	
	Moving iron	300	1	0.5 calibrated		1EH3	✓	1 unit	
	Moving iron	300	5	1		1EH4	✓	1 unit	
	Moving iron	300	5	0.5		1EH5	✓	1 unit	
	Moving iron	300	5	0.5 calibrated		1EH6	✓	1 unit	
	Moving iron	400	1	1		1EJ1	✓	1 unit	
	Moving iron	400	1	0.5		1EJ2	✓	1 unit	
	Moving iron	400	1	0.5 calibrated		1EJ3	✓	1 unit	
	Moving iron	400	5	1		1EJ4	✓	1 unit	
	Moving iron	400	5	0.5		1EJ5	✓	1 unit	
	Moving iron	400	5	0.5 calibrated		1EJ6	✓	1 unit	
	Bi-metal	300	1	1		2EH1	✓	1 unit	
	Bi-metal	300	1	0.5		2EH2	✓	1 unit	
	Bi-metal	300	1	0.5 calibrated		2EH3	✓	1 unit	
	Bi-metal	300	5	1		2EH4	✓	1 unit	
	Bi-metal	300	5	0.5		2EH5	✓	1 unit	
	Bi-metal	300	5	0.5 calibrated		2EH6	✓	1 unit	
	Bi-metal	400	1	1		2EJ1	✓	1 unit	
	Bi-metal	400	1	0.5		2EJ2	✓	1 unit	
Bi-metal	400	1	0.5 calibrated		2EJ3	✓	1 unit		
Bi-metal	400	5	1		2EJ4	✓	1 unit		
Bi-metal	400	5	0.5		2EJ5	✓	1 unit		
Bi-metal	400	5	0.5 calibrated		2EJ6	✓	1 unit		

Switch Disconnectors

3NJ62 In-Line Switch Disconnectors with Fuses up to 630 A

For LV HRC and BS fuse links

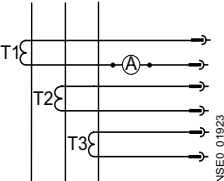
	Ammeters	Current transformers			DT	Article No. supplement 3NJ62...-.....□□□□ ↑↑↑↑	Additional price	PS*/ P. unit
		Primary current A	Secondary current A	Accuracy class				
For size 2 and B4 (continued)								
3 current transformers to 1 ammeter and multi-function plug								
	Moving iron	300	1	1		1FH1	✓	1 unit
	Moving iron	300	1	0.5		1FH2	✓	1 unit
	Moving iron	300	1	0.5 calibrated		1FH3	✓	1 unit
	Moving iron	300	5	1		1FH4	✓	1 unit
	Moving iron	300	5	0.5		1FH5	✓	1 unit
	Moving iron	300	5	0.5 calibrated		1FH6	✓	1 unit
	Moving iron	400	1	1		1FJ1	✓	1 unit
	Moving iron	400	1	0.5		1FJ2	✓	1 unit
	Moving iron	400	1	0.5 calibrated		1FJ3	✓	1 unit
	Moving iron	400	5	1		1FJ4	✓	1 unit
	Moving iron	400	5	0.5		1FJ5	✓	1 unit
	Moving iron	400	5	0.5 calibrated		1FJ6	✓	1 unit
	Bi-metal	300	1	1		2FH1	✓	1 unit
	Bi-metal	300	1	0.5		2FH2	✓	1 unit
	Bi-metal	300	1	0.5 calibrated		2FH3	✓	1 unit
	Bi-metal	300	5	1		2FH4	✓	1 unit
	Bi-metal	300	5	0.5		2FH5	✓	1 unit
	Bi-metal	300	5	0.5 calibrated		2FH6	✓	1 unit
	Bi-metal	400	1	1		2FJ1	✓	1 unit
	Bi-metal	400	1	0.5		2FJ2	✓	1 unit
	Bi-metal	400	1	0.5 calibrated		2FJ3	✓	1 unit
	Bi-metal	400	5	1		2FJ4	✓	1 unit
	Bi-metal	400	5	0.5		2FJ5	✓	1 unit
	Bi-metal	400	5	0.5 calibrated		2FJ6	✓	1 unit

7

Switch Disconnectors

3NJ62 In-Line Switch Disconnectors with Fuses up to 630 A

For LV HRC and BS fuse links

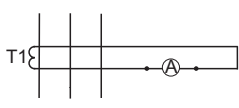
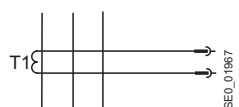
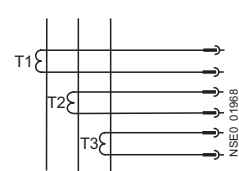
	Ammeters	Current transformers			DT	Article No. supplement 3NJ62...-.....□□□□ ↑↑↑↑	Additional price	PS*/P. unit	
		Primary current A	Secondary current A	Accuracy class					
For size 3 and 3T									
	Without	Without	Without	Without		0AA0	None	1 unit	
	1 current transformer to 1 ammeter								
 NSE0_01925	Moving iron	300	1	1		1DH1	✓	1 unit	
	Moving iron	300	5	1		1DH4	✓	1 unit	
	Moving iron	400	1	1		1DJ1	✓	1 unit	
	Moving iron	400	5	1		1DJ4	✓	1 unit	
	Moving iron	500	1	1		1DK1	✓	1 unit	
	Moving iron	500	5	1		1DK4	✓	1 unit	
	Moving iron	600	1	1		1DL1	✓	1 unit	
	Moving iron	600	5	1		1DL4	✓	1 unit	
	Bi-metal	300	1	1		2DH1	✓	1 unit	
	Bi-metal	300	5	1		2DH4	✓	1 unit	
	Bi-metal	400	1	1		2DJ1	✓	1 unit	
	Bi-metal	400	5	1		2DJ4	✓	1 unit	
	Bi-metal	500	1	1		2DK1	✓	1 unit	
	Bi-metal	500	5	1		2DK4	✓	1 unit	
Bi-metal	600	1	1		2DL1	✓	1 unit		
Bi-metal	600	5	1		2DL4	✓	1 unit		
	1 current transformer to multi-function plug								
 NSE0_01967	Without	300	1	1		0BH1	✓	1 unit	
	Without	300	1	0.5		0BH2	✓	1 unit	
	Without	300	1	0.5 calibrated		0BH3	✓	1 unit	
	Without	300	5	1		0BH4	✓	1 unit	
	Without	300	5	0.5		0BH5	✓	1 unit	
	Without	300	5	0.5 calibrated		0BH6	✓	1 unit	
	Without	400	1	1		0BJ1	✓	1 unit	
	Without	400	1	0.5		0BJ2	✓	1 unit	
	Without	400	1	0.5 calibrated		0BJ3	✓	1 unit	
	Without	400	5	1		0BJ4	✓	1 unit	
	Without	400	5	0.5		0BJ5	✓	1 unit	
	Without	400	5	0.5 calibrated		0BJ6	✓	1 unit	
	Without	500	1	1		0BK1	✓	1 unit	
	Without	500	1	0.5		0BK2	✓	1 unit	
	Without	500	1	0.5 calibrated		0BK3	✓	1 unit	
	Without	500	5	1		0BK4	✓	1 unit	
	Without	500	5	0.5		0BK5	✓	1 unit	
	Without	500	5	0.5 calibrated		0BK6	✓	1 unit	
	Without	600	1	1		0BL1	✓	1 unit	
	Without	600	1	0.5		0BL2	✓	1 unit	
	Without	600	1	0.5 calibrated		0BL3	✓	1 unit	
	Without	600	5	1		0BL4	✓	1 unit	
	Without	600	5	0.5		0BL5	✓	1 unit	
	Without	600	5	0.5 calibrated		0BL6	✓	1 unit	
	3 current transformers to multi-function plug								
 NSE0_01968	Without	300	1	1		0CH1	✓	1 unit	
	Without	300	1	0.5		0CH2	✓	1 unit	
	Without	300	1	0.5 calibrated		0CH3	✓	1 unit	
	Without	300	5	1		0CH4	✓	1 unit	
	Without	300	5	0.5		0CH5	✓	1 unit	
	Without	300	5	0.5 calibrated		0CH6	✓	1 unit	
	Without	400	1	1		0CJ1	✓	1 unit	
	Without	400	1	0.5		0CJ2	✓	1 unit	
	Without	400	1	0.5 calibrated		0CJ3	✓	1 unit	
	Without	400	5	1		0CJ4	✓	1 unit	
	Without	400	5	0.5		0CJ5	✓	1 unit	
	Without	400	5	0.5 calibrated		0CJ6	✓	1 unit	
	Without	500	1	1		0CK1	✓	1 unit	
	Without	500	1	0.5		0CK2	✓	1 unit	
	Without	500	1	0.5 calibrated		0CK3	✓	1 unit	
	Without	500	5	1		0CK4	✓	1 unit	
	Without	500	5	0.5		0CK5	✓	1 unit	
	Without	500	5	0.5 calibrated		0CK6	✓	1 unit	
	Without	600	1	1		0CL1	✓	1 unit	
	Without	600	1	0.5		0CL2	✓	1 unit	
	Without	600	1	0.5 calibrated		0CL3	✓	1 unit	
	Without	600	5	1		0CL4	✓	1 unit	
	Without	600	5	0.5		0CL5	✓	1 unit	
	Without	600	5	0.5 calibrated		0CL6	✓	1 unit	

7

* You can order this quantity or a multiple thereof.

Switch Disconnectors

3NJ62 In-Line Switch Disconnectors with Fuses up to 630 A

For LV HRC and BS fuse links

	Ammeters	Current transformers			DT	Article No. supplement 3NJ62...-.....-□□□□ ↑↑↑↑	Additional price	PS*/ P. unit
		Primary current A	Secondary current A	Accuracy class				
For size 3 and 3T (continued)								
1 current transformer to 1 ammeter and multi-function plug								
	Moving iron	400	1	1		1EH1	✓	1 unit
	Moving iron	400	1	0.5		1EH2	✓	1 unit
	Moving iron	300	1	0.5 calibrated		1EH3	✓	1 unit
	Moving iron	300	5	1		1EH4	✓	1 unit
	Moving iron	300	5	0.5		1EH5	✓	1 unit
	Moving iron	300	5	0.5 calibrated		1EH6	✓	1 unit
	Moving iron	400	1	1		1EJ1	✓	1 unit
	Moving iron	400	1	0.5		1EJ2	✓	1 unit
	Moving iron	400	1	0.5 calibrated		1EJ3	✓	1 unit
	Moving iron	400	5	1		1EJ4	✓	1 unit
	Moving iron	400	5	0.5		1EJ5	✓	1 unit
	Moving iron	400	5	0.5 calibrated		1EJ6	✓	1 unit
	Moving iron	500	1	1		1EK1	✓	1 unit
	Moving iron	500	1	0.5		1EK2	✓	1 unit
	Moving iron	500	1	0.5 calibrated		1EK3	✓	1 unit
	Moving iron	500	5	1		1EK4	✓	1 unit
	Moving iron	500	5	0.5		1EK5	✓	1 unit
	Moving iron	500	5	0.5 calibrated		1EK6	✓	1 unit
	Moving iron	600	1	1		1EL1	✓	1 unit
	Moving iron	600	1	0.5		1EL2	✓	1 unit
	Moving iron	600	1	0.5 calibrated		1EL3	✓	1 unit
	Moving iron	600	5	1		1EL4	✓	1 unit
	Moving iron	600	5	0.5		1EL5	✓	1 unit
	Moving iron	600	5	0.5 calibrated		1EL6	✓	1 unit
	Bi-metal	300	1	1		2EH1	✓	1 unit
	Bi-metal	300	1	0.5		2EH2	✓	1 unit
	Bi-metal	300	1	0.5 calibrated		2EH3	✓	1 unit
	Bi-metal	300	5	1		2EH4	✓	1 unit
	Bi-metal	300	5	0.5		2EH5	✓	1 unit
	Bi-metal	300	5	0.5 calibrated		2EH6	✓	1 unit
	Bi-metal	400	1	1		2EJ1	✓	1 unit
	Bi-metal	400	1	0.5		2EJ2	✓	1 unit
	Bi-metal	400	1	0.5 calibrated		2EJ3	✓	1 unit
	Bi-metal	400	5	1		2EJ4	✓	1 unit
	Bi-metal	400	5	0.5		2EJ5	✓	1 unit
	Bi-metal	400	5	0.5 calibrated		2EJ6	✓	1 unit
Bi-metal	500	1	1		2EK1	✓	1 unit	
Bi-metal	500	1	0.5		2EK2	✓	1 unit	
Bi-metal	500	1	0.5 calibrated		2EK3	✓	1 unit	
Bi-metal	500	5	1		2EK4	✓	1 unit	
Bi-metal	500	5	0.5		2EK5	✓	1 unit	
Bi-metal	500	5	0.5 calibrated		2EK6	✓	1 unit	
Bi-metal	600	1	1		2EL1	✓	1 unit	
Bi-metal	600	1	0.5		2EL2	✓	1 unit	
Bi-metal	600	1	0.5 calibrated		2EL3	✓	1 unit	
Bi-metal	600	5	1		2EL4	✓	1 unit	
Bi-metal	600	5	0.5		2EL5	✓	1 unit	
Bi-metal	600	5	0.5 calibrated		2EL6	✓	1 unit	

Switch Disconnectors

3NJ62 In-Line Switch Disconnectors with Fuses up to 630 A

For LV HRC and BS fuse links

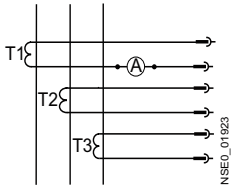

Ammeters	Current transformers			DT	Article No. supplement 3NJ62...-.....□□□□ ↑↑↑↑	Additional price	PS*/P. unit	
	Primary current A	Secondary current A	Accuracy class					
For size 3 and 3T (continued)								
3 current transformers to 1 ammeter and multi-function plug								
	Moving iron	300	1	1			1 unit	
	Moving iron	300	1	0.5		1FH1	✓	1 unit
	Moving iron	300	1	0.5 calibrated		1FH2	✓	1 unit
	Moving iron	300	5	1		1FH3	✓	1 unit
	Moving iron	300	5	0.5		1FH4	✓	1 unit
	Moving iron	300	5	0.5 calibrated		1FH5	✓	1 unit
	Moving iron	300	5	0.5 calibrated		1FH6	✓	1 unit
	Moving iron	400	1	1		1FJ1	✓	1 unit
	Moving iron	400	1	0.5		1FJ2	✓	1 unit
	Moving iron	400	1	0.5 calibrated		1FJ3	✓	1 unit
	Moving iron	400	5	1		1FJ4	✓	1 unit
	Moving iron	400	5	0.5		1FJ5	✓	1 unit
	Moving iron	400	5	0.5 calibrated		1FJ6	✓	1 unit
	Moving iron	500	1	1		1FK1	✓	1 unit
	Moving iron	500	1	0.5		1FK2	✓	1 unit
	Moving iron	500	1	0.5 calibrated		1FK3	✓	1 unit
	Moving iron	500	5	1		1FK4	✓	1 unit
	Moving iron	500	5	0.5		1FK5	✓	1 unit
	Moving iron	500	5	0.5 calibrated		1FK6	✓	1 unit
	Moving iron	600	1	1		1FL1	✓	1 unit
	Moving iron	600	1	0.5		1FL2	✓	1 unit
	Moving iron	600	1	0.5 calibrated		1FL3	✓	1 unit
	Moving iron	600	5	1		1FL4	✓	1 unit
	Moving iron	600	5	0.5		1FL5	✓	1 unit
	Moving iron	600	5	0.5 calibrated		1FL6	✓	1 unit
	Bi-metal	300	1	1		2FH1	✓	1 unit
	Bi-metal	300	1	0.5		2FH2	✓	1 unit
	Bi-metal	300	1	0.5 calibrated		2FH3	✓	1 unit
	Bi-metal	300	5	1		2FH4	✓	1 unit
	Bi-metal	300	5	0.5		2FH5	✓	1 unit
	Bi-metal	300	5	0.5 calibrated		2FH6	✓	1 unit
	Bi-metal	400	1	1		2FJ1	✓	1 unit
	Bi-metal	400	1	0.5		2FJ2	✓	1 unit
	Bi-metal	400	1	0.5 calibrated		2FJ3	✓	1 unit
	Bi-metal	400	5	1		2FJ4	✓	1 unit
	Bi-metal	400	5	0.5		2FJ5	✓	1 unit
	Bi-metal	400	5	0.5 calibrated		2FJ6	✓	1 unit
	Bi-metal	500	1	1		2FK1	✓	1 unit
	Bi-metal	500	1	0.5		2FK2	✓	1 unit
	Bi-metal	500	1	0.5 calibrated		2FK3	✓	1 unit
	Bi-metal	500	5	1		2FK4	✓	1 unit
	Bi-metal	500	5	0.5		2FK5	✓	1 unit
	Bi-metal	500	5	0.5 calibrated		2FK6	✓	1 unit
	Bi-metal	600	1	1		2FL1	✓	1 unit
	Bi-metal	600	1	0.5		2FL2	✓	1 unit
	Bi-metal	600	1	0.5 calibrated		2FL3	✓	1 unit
	Bi-metal	600	5	1		2FL4	✓	1 unit
	Bi-metal	600	5	0.5		2FL5	✓	1 unit
Bi-metal	600	5	0.5 calibrated		2FL6	✓	1 unit	

Switch Disconnectors

3NJ62 In-Line Switch Disconnectors with Fuses up to 630 A

Accessories













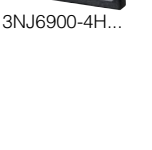

Selection and ordering data

Version	DT	Article No.	Price per PU	PU (UNIT, SET, M)	PS*/P. unit	PG	Weight per PU approx. kg	
For size 00, A3 and 00T								
Terminals								
 3NJ6923-1BA00		Single terminal for 2-/3-pole devices, 10 ... 95 mm ² (1 set = 3 units)	3NJ6923-1BA00	1	1 unit	143	0.226	
		Single terminal for 4-pole devices, 10 ... 95 mm ² (1 set = 4 units)	3NJ6924-1BA00	1	1 unit	143	0.320	
Terminal covers								
 3NJ6923-1DA00		For 2-/3-pole devices	3NJ6923-1DA00	1	1 unit	143	0.091	
		Only for 4th pole	3NJ6904-1DA00	1	1 unit	143	0.095	
Contact extensions								
 3NJ6923-1EB00		3-pole	3NJ6923-1EB00	1	1 unit	143	1.998	
		4-pole	3NJ6924-1EB00	1	1 unit	143	2.810	
Electronic fuse monitoring and line monitoring								
 3NJ6923-3FB00		EFM 10 - fuse monitoring for AC networks	3NJ6920-3FB00	1	1 unit	143	0.100	
		EFM 20 - fuse monitoring and line monitoring for AC networks	3NJ6920-3FC00	1	1 unit	143	0.100	
 3NJ6923-3FC00		EFM 25 - fuse monitoring and line monitoring for DC networks	3NJ6920-3FE00	1	1 unit	143	0.100	
Auxiliary switches								
 3NJ6920-2BB00		1 NO contact (1 NO) with cover	3NJ6920-2BB00	1	1 unit	143	0.108	
		1 NO contact (1 NO)	3NJ6900-2BC00	1	1 unit	143	0.015	
		1 NC contact (1 NC) with cover	3NJ6920-2CB00	1	1 unit	143	0.092	
 3NJ6900-2BC00		1 NC contact (1 NC)	3NJ6900-2CC00	1	1 unit	143	0.018	
Current transformers for main devices and contact extensions								
		∅ = Feed-through opening diameter						
	50 A/1 A	Class 1	1 VA, ∅ 21 mm	3NJ6920-3BB11	1	1 unit	143	0.171
	50 A/5 A	Class 1	1 VA, ∅ 21 mm	3NJ6920-3BB21	1	1 unit	143	0.168
	100 A/1 A	Class 1	2.5 VA, ∅ 21 mm	3NJ6920-3BD11	1	1 unit	143	0.182
	100 A/1 A	Class 0.5	1.5 VA, ∅ 21 mm	3NJ6920-3BD12	1	1 unit	143	0.173
	100 A/1 A	Class 0.5 calibrated	1.5 VA, ∅ 14 mm	3NJ6920-3BD13	1	1 unit	143	0.223
	100 A/5 A	Class 1	2.5 VA, ∅ 21 mm	3NJ6920-3BD21	1	1 unit	143	0.175
	100 A/5 A	Class 0.5	1.5 VA, ∅ 21 mm	3NJ6920-3BD22	1	1 unit	143	0.173
	100 A/5 A	Class 0.5 calibrated	1.5 VA, ∅ 14mm	3NJ6920-3BD23	1	1 unit	143	0.188
	150 A/1 A	Class 1	2.5 VA, ∅ 21 mm	3NJ6920-3BE11	1	1 unit	143	0.175
	150 A/1 A	Class 0.5	1.5 VA, ∅ 21 mm	3NJ6920-3BE12	1	1 unit	143	0.182
	150 A/1 A	Class 0.5 calibrated	2.5 VA, ∅ 14 mm	3NJ6920-3BE13	1	1 unit	143	0.170
	150 A/5 A	Class 1	1.5 VA, ∅ 21 mm	3NJ6920-3BE21	1	1 unit	143	0.185
	150 A/5 A	Class 0.5	1.5 VA, ∅ 21 mm	3NJ6920-3BE22	1	1 unit	143	0.183
	150 A/5 A	Class 0.5 calibrated	2.5 VA, ∅ 14 mm	3NJ6920-3BE23	1	1 unit	143	0.182

Switch Disconnectors

3NJ62 In-Line Switch Disconnectors with Fuses up to 630 A

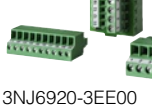
Accessories

Version	DT	Article No.	Price per PU	PU (UNIT, SET, M)	PS*/P. unit	PG	Weight per PU approx. kg	
For size 00, A3 and 00T (continued)								
 3NJ6920-3DB00	Current transformer busbars for current transformers with feed-through opening \varnothing 21 mm							
	For 1 current transformer		3NJ6920-3DB00	1	1 unit	143	0.065	
	For 3 current transformers		3NJ6920-3DC00	1	1 unit	143	0.192	
 3NJ6920-3DC00	For 4 current transformers ¹⁾		3NJ6920-3DD00	1	1 unit	143	0.259	
	Current transformer busbars for current transformers with feed-through opening \varnothing 14 mm							
	For 1 current transformer		3NJ6920-3DE00	1	1 unit	143	0.062	
 3NJ6920-3DC00	For 3 current transformers		3NJ6920-3DF00	1	1 unit	143	0.182	
	For 4 current transformers ¹⁾		3NJ6920-3DG00	1	1 unit	143	0.248	
	 3NJ6920-3DD00							
 3NJ6900-4GA00	Holders for ammeters		3NJ6900-4GA00	1	1 unit	143	0.052	
	For sizes 00, 1, 2, 3							
 3NJ6900-4H...	Ammeters							
	Moving-iron measuring instruments for measurements on transformer x/1A with double overload							
	50 A/1 A	0.6 VA	3NJ6900-4HB11	1	1 unit	143	0.078	
	100 A/1 A	0.6 VA	3NJ6900-4HD11	1	1 unit	143	0.086	
 3NJ6900-4H...	150 A/1 A		0.6 VA	3NJ6900-4HE11	1	1 unit	143	0.085
	Moving-iron measuring instruments for measurements on transformer x/5A with double overload							
	50 A/5 A	0.6 VA	3NJ6900-4HB21	1	1 unit	143	0.092	
	100 A/5 A	0.6 VA	3NJ6900-4HD21	1	1 unit	143	0.093	
 3NJ6900-4H...	150 A/5 A		0.6 VA	3NJ6900-4HE21	1	1 unit	143	0.092
	Bi-metal measuring instruments for measurements on transformer x/1A with 1.2-times overload							
	50 A/1 A	1 VA	3NJ6900-4HB12	1	1 unit	143	0.063	
	100 A/1 A	1 VA	3NJ6900-4HD12	1	1 unit	143	0.068	
 3NJ6900-4H...	150 A/1 A		1 VA	3NJ6900-4HE12	1	1 unit	143	0.068
	Bi-metal measuring instruments for measurements on transformer x/5A with 1.2-times overload							
	50 A/5 A	1 VA	3NJ6900-4HB22	1	1 unit	143	0.067	
	100 A/5 A	1 VA	3NJ6900-4HD22	1	1 unit	143	0.065	
 3NJ6920-3EB00	150 A/5 A		1 VA	3NJ6900-4HE22	1	1 unit	143	0.065
	Multi-function plugs							
	6 x 2.5 mm ² , with fixing screws		3NJ6920-3EB00	1	1 unit	143	0.045	
	8 x 2.5 mm ² , without fixing screws		3NJ6920-3ED00	1	1 unit	143	0.053	
 3NJ6920-3ED00	10 x 1.5 mm ² and 8 x 2.5 mm ² , without fixing screws		3NJ6920-3EE00	1	1 unit	143	0.073	
	 3NJ6920-3EE00							
	 3NJ6920-3EE00							
 3NJ6923-4BB00	Front panel		3NJ6923-4BB00	1	1 unit	143	0.345	
	For NH: 3NJ6203-1AA... and 3NJ6203-3AA... without/with EFM		3NJ6923-4BC00	1	1 unit	143	0.400	
For BS: 3NJ6203-1AA... and 3NJ6203-3AA... without/with EFM								

¹⁾ Not available in combination with multi-function plugs.

* You can order this quantity or a multiple thereof.

Switch Disconnectors

3NJ62 In-Line Switch Disconnectors with Fuses up to 630 A







Accessories

Version	DT	Article No.	Price per PU	PU (UNIT, SET, M)	PS*/P. unit	PG	Weight per PU approx. kg	
For size 1 and B2								
 3NJ6933-1BA00		Terminals Single terminal for 2-/3-pole devices, 16 ... 300 mm ² (1 set = 3 units)		1	1 unit	143	0.440	
		Single terminal for 4-pole devices, 16 ... 300 mm ² (1 set = 4 units)	3NJ6934-1BA00	1	1 unit	143	0.591	
 3NJ6933-1DB00		Terminal covers For 2-/3-pole devices		1	1 unit	143	0.192	
		Internal terminal covers for 2-/3-pole devices	3NJ6933-1DB00	1	1 unit	143	0.022	
		Only for 4th pole	3NJ6904-1DA00	1	1 unit	143	0.095	
 3NJ6933-1EB00		Contact extensions 3-pole		1	1 unit	143	2.820	
		4-pole	3NJ6934-1EB00	1	1 unit	143	4.103	
 3NJ6923-3FB00		Electronic fuse monitoring and line monitoring EFM 10 - fuse monitoring for AC networks		1	1 unit	143	0.100	
		EFM 20 - fuse monitoring and line monitoring for AC networks	3NJ6930-3FC00	1	1 unit	143	0.110	
		EFM 25 - fuse monitoring and line monitoring for DC networks	3NJ6930-3FE00	1	1 unit	143	0.100	
 3NJ6923-3FC00		Auxiliary switches 1 NO contact (1 NO) with cover		1	1 unit	143	0.069	
		1 NO contact (1 NO)	3NJ6900-2BC00	1	1 unit	143	0.015	
 3NJ6930-2BB00		1 NC contact (1 NC) with cover	3NJ6930-2CB00	1	1 unit	143	0.063	
		1 NC contact (1 NC)	3NJ6900-2CC00	1	1 unit	143	0.018	
 3NJ6900-2BC00		Current transformers for main devices and contact extensions Ø = Feed-through opening diameter						
	 3NJ6920-3BD11	50 A/1 A	Class 1	1 VA, Ø 21 mm	3NJ6920-3BB11	1	1 unit	143
50 A/5 A		Class 1	1 VA, Ø 21 mm	3NJ6920-3BB21	1	1 unit	143	0.168
100 A/1 A		Class 1	2.5 VA, Ø 21 mm	3NJ6920-3BD11	1	1 unit	143	0.182
100 A/1 A		Class 0.5	1.5 VA, Ø 21 mm	3NJ6920-3BD12	1	1 unit	143	0.173
100 A/5 A		Class 1	2.5 VA, Ø 21 mm	3NJ6920-3BD21	1	1 unit	143	0.175
100 A/5 A		Class 0.5	1.5 VA, Ø 21 mm	3NJ6920-3BD22	1	1 unit	143	0.173
150 A/1 A		Class 1	2.5 VA, Ø 21 mm	3NJ6920-3BE11	1	1 unit	143	0.175
150 A/1 A		Class 0.5	1.5 VA, Ø 21 mm	3NJ6920-3BE12	1	1 unit	143	0.182
150 A/5 A		Class 1	1.5 VA, Ø 21 mm	3NJ6920-3BE21	1	1 unit	143	0.185
150 A/5 A		Class 0.5	1.5 VA, Ø 21 mm	3NJ6920-3BE22	1	1 unit	143	0.183
200 A/1 A		Class 1	2.5 VA, Ø 21 mm	3NJ6930-3BF11	1	1 unit	143	0.179
200 A/1 A		Class 0.5	5 VA, Ø 21 mm	3NJ6930-3BF12	1	1 unit	143	0.177
200 A/5 A		Class 1	2.5 VA, Ø 21 mm	3NJ6930-3BF21	1	1 unit	143	0.184
200 A/5 A		Class 0.5	2.5 VA, Ø 21 mm	3NJ6930-3BF22	1	1 unit	143	0.177
250 A/1 A		Class 1	5 VA, Ø 21 mm	3NJ6930-3BG11	1	1 unit	143	0.192
250 A/1 A		Class 0.5	5 VA, Ø 21 mm	3NJ6930-3BG12	1	1 unit	143	0.186
250 A/5 A	Class 1	2.5 VA, Ø 21 mm	3NJ6930-3BG21	1	1 unit	143	0.181	
250 A/5 A	Class 0.5	2.5 VA, Ø 21 mm	3NJ6930-3BG22	1	1 unit	143	0.177	

Switch Disconnectors

3NJ62 In-Line Switch Disconnectors with Fuses up to 630 A

Accessories









Version	DT	Article No.	Price per PU	PU (UNIT, SET, M)	PS*/P. unit	PG	Weight per PU approx. kg
For size 1 and B2 (continued)							
 3NJ6930-3DB00	Current transformer busbars for current transformers with feed-through opening \varnothing 21 mm For 1 current transformer For 3 current transformers For 4 current transformers ¹⁾		3NJ6930-3DB00 3NJ6930-3DC00 3NJ6930-3DD00	1 1 1	1 unit 1 unit 1 unit	143 143 143	0.127 0.358 0.382
	 3NJ6930-3DC00  3NJ6930-3DD00						
 3NJ6900-4GA00	Holders for ammeters For sizes 00, 1, 2, 3		3NJ6900-4GA00	1	1 unit	143	0.052
 3NJ6900-4H...	Ammeters Moving-iron measuring instruments for measurements on transformer x/1A with double overload		3NJ6900-4HB11 3NJ6900-4HD11 3NJ6900-4HE11 3NJ6900-4HF11 3NJ6900-4HG11	1 1 1 1 1	1 unit 1 unit 1 unit 1 unit 1 unit	143 143 143 143 143	0.078 0.086 0.085 0.085 0.085
	Moving-iron measuring instruments for measurements on transformer x/5A with double overload		3NJ6900-4HB21 3NJ6900-4HD21 3NJ6900-4HE21 3NJ6900-4HF21 3NJ6900-4HG21	1 1 1 1 1	1 unit 1 unit 1 unit 1 unit 1 unit	143 143 143 143 143	0.092 0.093 0.092 0.092 0.089
	Bi-metal measuring instruments for measurements on transformer x/1A with 1.2-times overload		3NJ6900-4HB12 3NJ6900-4HD12 3NJ6900-4HE12 3NJ6900-4HF12 3NJ6900-4HG12	1 1 1 1 1	1 unit 1 unit 1 unit 1 unit 1 unit	143 143 143 143 143	0.063 0.068 0.068 0.067 0.064
	Bi-metal measuring instruments for measurements on transformer x/5A with 1.2-times overload		3NJ6900-4HB22 3NJ6900-4HD22 3NJ6900-4HE22 3NJ6900-4HF22 3NJ6900-4HG22	1 1 1 1 1	1 unit 1 unit 1 unit 1 unit 1 unit	143 143 143 143 143	0.067 0.065 0.065 0.068 0.066
	Multi-function plugs 6 x 2.5 mm ² , with fixing screws 8 x 2.5 mm ² , without fixing screws 10 x 1.5 mm ² and 8 x 2.5 mm ² , without fixing screws		3NJ6920-3EB00 3NJ6920-3ED00 3NJ6920-3EE00	1 1 1	1 unit 1 unit 1 unit	143 143 143	0.045 0.053 0.073
 3NJ6933-4BB00	Front panel For NH: 3NJ6213-1AA... and 3NJ6213-3AA... without/with EFM For BS: 3NJ6213-1AA... and 3NJ6213-3AA... without/with EFM		3NJ6933-4BB00 3NJ6933-4BC00	1 1	1 unit 1 unit	143 143	0.521 0.500

¹⁾ Not available in combination with multi-function plug.

Switch Disconnectors

3NJ62 In-Line Switch Disconnectors with Fuses up to 630 A





Accessories

Version	DT	Article No.	Price per PU	PU (UNIT, SET, M)	PS*/P. unit	PG	Weight per PU approx. kg
For size 2, 3, B4 and 3T							
 3NJ6943-1CA00	Terminals						
	Double terminal for 2-/3-pole devices, 2 x (16 mm ² ... 300 mm ² , 1 set = 6 units) Double terminal for 4-pole devices, 2 x (16 mm ² ... 300 mm ² , 1 set = 8 units)	3NJ6943-1CA00		1	1 unit	143	0.920
 3NJ6943-1DA00	Terminal covers						
	For 2-/3-pole devices Only for 4th pole	3NJ6943-1DA00 3NJ6904-1DA00		1 1	1 unit 1 unit	143 143	0.198 0.095
 3NJ6944-1EB00	Contact extensions						
	3-pole 4-pole	3NJ6943-1EB00 3NJ6944-1EB00		1 1	1 unit 1 unit	143 143	4.200 8.620
 3NJ6923-3FB00	Electronic fuse monitoring and line monitoring						
	EFM 10 - fuse monitoring for AC networks	3NJ6940-3FB00		1	1 unit	143	0.100
	EFM 20 - fuse monitoring and line monitoring for AC networks	3NJ6940-3FC00		1	1 unit	143	0.110
 3NJ6923-3FE00	EFM 25 - fuse monitoring and line monitoring for DC networks	3NJ6940-3FE00		1	1 unit	143	0.100
	Auxiliary switches						
 3NJ6940-2BB00	1 NO contact (1 NO) with cover	3NJ6940-2BB00		1	1 unit	143	0.028
	1 NO contact (1 NO)	3NJ6900-2BC00		1	1 unit	143	0.015
	1 NC contact (1 NC) with cover	3NJ6940-2CB00		1	1 unit	143	0.024
	1 NC contact (1 NC)	3NJ6900-2CC00		1	1 unit	143	0.018
 3NJ6900-2BC00							
 3NJ6940-3B...	Current transformers for main devices and contact extensions						
	300 A/1 A Class 1 5 VA	3NJ6940-3BH11		1	1 unit	143	0.329
	300 A/1 A Class 0.5 5 VA	3NJ6940-3BH12		1	1 unit	143	0.503
	300 A/1 A Class 0.5 calibrated 5 VA	3NJ6940-3BH13		1	1 unit	143	0.433
	300 A/5 A Class 1 5 VA	3NJ6940-3BH21		1	1 unit	143	0.324
	300 A/5 A Class 0.5 5 VA	3NJ6940-3BH22		1	1 unit	143	0.495
	300 A/5 A Class 0.5 calibrated 5 VA	3NJ6940-3BH23		1	1 unit	143	0.429
	400 A/1 A Class 1 5 VA	3NJ6940-3BJ11		1	1 unit	143	0.353
	400 A/1 A Class 0.5 5 VA	3NJ6940-3BJ12		1	1 unit	143	0.362
	400 A/1 A Class 0.5 calibrated 5 VA	3NJ6940-3BJ13		1	1 unit	143	0.384
	400 A/5 A Class 1 5 VA	3NJ6940-3BJ21		1	1 unit	143	0.332
	400 A/5 A Class 0.5 5 VA	3NJ6940-3BJ22		1	1 unit	143	0.356
	400 A/5 A Class 0.5 calibrated 5 VA	3NJ6940-3BJ23		1	1 unit	143	0.364
	500 A/1 A Class 1 5 VA	3NJ6940-3BK11		1	1 unit	143	0.312
	500 A/1 A Class 0.5 5 VA	3NJ6940-3BK12		1	1 unit	143	0.359
	500 A/1 A Class 0.5 calibrated 5 VA	3NJ6940-3BK13		1	1 unit	143	0.460
	500 A/5 A Class 1 5 VA	3NJ6940-3BK21		1	1 unit	143	0.342
	500 A/5 A Class 0.5 5 VA	3NJ6940-3BK22		1	1 unit	143	0.339
	500 A/5 A Class 0.5 calibrated 5 VA	3NJ6940-3BK23		1	1 unit	143	0.374
	600 A/1 A Class 1 5 VA	3NJ6940-3BL11		1	1 unit	143	0.462
	600 A/1 A Class 0.5 5 VA	3NJ6940-3BL12		1	1 unit	143	0.432
	600 A/1 A Class 0.5 calibrated 5 VA	3NJ6940-3BL13		1	1 unit	143	0.337
	600 A/5 A Class 1 5 VA	3NJ6940-3BL21		1	1 unit	143	0.364
	600 A/5 A Class 0.5 5 VA	3NJ6940-3BL22		1	1 unit	143	0.308
600 A/5 A Class 0.5 calibrated 5 VA	3NJ6940-3BL23		1	1 unit	143	0.389	

Switch Disconnectors

3NJ62 In-Line Switch Disconnectors with Fuses up to 630 A





Accessories

Version	DT	Article No.	Price per PU	PU (UNIT, SET, M)	PS*/P. unit	PG	Weight per PU approx. kg
For size 2, 3, B4 and 3T (continued)							
		Holders for ammeters For sizes 00, 1, 2, 3		3NJ6900-4GA00	1	1 unit	143 0.052
		Ammeters Moving-iron measuring instruments for measuring input on transformer x/1A with double overload					
		300 A/1 A 0.6 VA		3NJ6900-4HH11	1	1 unit	143 0.085
		400 A/1 A 0.6 VA		3NJ6900-4HJ11	1	1 unit	143 0.085
		500 A/1 A 0.6 VA		3NJ6900-4HK11	1	1 unit	143 0.085
		600 A/1 A 0.6 VA		3NJ6900-4HL11	1	1 unit	143 0.086
		Moving-iron measuring instruments for measuring input on transformer x/5A with double overload					
		300 A/5 A 0.6 VA		3NJ6900-4HH21	1	1 unit	143 0.092
		400 A/5 A 0.6 VA		3NJ6900-4HJ21	1	1 unit	143 0.093
		500 A/5 A 0.6 VA		3NJ6900-4HK21	1	1 unit	143 0.084
		600 A/5 A 0.6 VA		3NJ6900-4HL21	1	1 unit	143 0.086
		Bi-metal measuring instruments for measurements on transformer x/1A with 1.2-times overload					
		300 A/1 A 1 VA		3NJ6900-4HH12	1	1 unit	143 0.067
		400 A/1 A 1 VA		3NJ6900-4HJ12	1	1 unit	143 0.063
		500 A/1 A 1 VA		3NJ6900-4HK12	1	1 unit	143 0.067
		600 A/1 A 1 VA		3NJ6900-4HL12	1	1 unit	143 0.062
		Bi-metal measuring instruments for measurements on transformer x/5A with 1.2-times overload					
		300 A/5 A 1 VA		3NJ6900-4HH22	1	1 unit	143 0.068
		400 A/5 A 1 VA		3NJ6900-4HJ22	1	1 unit	143 0.064
		500 A/5 A 1 VA		3NJ6900-4HK22	1	1 unit	143 0.065
		600 A/5 A 1 VA		3NJ6900-4HL22	1	1 unit	143 0.068
		Multi-function plugs 8 x 2.5 mm ² , with fixing screws 8 x 2.5 mm ² , without fixing screws 12 x 1.5 mm ² and 8 x 2.5 mm ² , without fixing screws		3NJ6940-3EC00	1	1 unit	143 0.085
				3NJ6940-3ED00	1	1 unit	143 0.084
				3NJ6940-3EF00	1	1 unit	143 0.107
		Front panel For NH: 3NJ6223-1AA... and 3NJ6223-3AA... without/with EFM		3NJ6943-4BB00	1	1 unit	143 0.851
		For BS: 3NJ6223-1AA... and 3NJ6223-3AA... without/with EFM		3NJ6943-4BC00	1	1 unit	143 0.700
		For NH: 3NJ6233-1AA... and 3NJ6233-3AA... without/with EFM		3NJ6953-4BB00	1	1 unit	143 0.780
		For BS: 3NJ6233-1AA... and 3NJ6233-3AA... without/with EFM		3NJ6953-4BC00	1	1 unit	143 0.700

Switch Disconnectors

3NJ62 In-Line Switch Disconnectors with Fuses up to 630 A

Accessories

Version	DT	Article No.	Price per PU	PU (UNIT, SET, M)	PS*/P. unit	PG	Weight per PU approx. kg
Common accessories							
 3NJ6916-4EA00		Busbar covers Mounting height 200 mm, IP20		3NJ6916-4EA00	1	1 unit	113 0.490
 3NJ6900-4CB00		Blanking covers Mounting height 50 mm, IP41		3NJ6900-4CB00	1	1 unit	143 0.335
 3NJ6915-3BA00		Connection modules For power takeoff from field distribution bus up to 400 A		3NJ6915-3BA00	1	1 unit	113 1.578
 3NJ6900-4FB00		Guide rails Depth 200 mm (1 x left and 1 x right) Depth 400 mm (1 x left and 1 x right)		3NJ6900-4FB00 3NJ6900-4FC00	1 1	1 unit 1 unit	143 0.280 143 0.513
 3NJ6900-4FC00		NH fuse puller tongs For NH00 For NH1, 2, 3		XPT:8PT9624 XPT:8PT9625	1 1	1 unit 1 unit	195 0.497 195 0.505

7

Switch Disconnectors

3NP1 Fuse Switch Disconnectors up to 630 A

Introduction

Overview



3NP1 fuse switch disconnectors

All key product features at a glance

- Box terminals available for all sizes
- Connection of circular conductors and laminated conductors
- Fuse monitoring possible throughout
- Busbar supports can be built over
- Conversion of 5/10 mm thick busbars without parts which can be lost or broken off
- Convertibility of cable feeder at top/bottom without intervention in the internal conducting paths
- Optimum integration in various system environments through cover levels and on busbar systems with/without base
- Touch protection also with rear incoming feeder
- Fuses are removed using a release shaft without the fuses being touched
- All units can be sealed and locked

Overview of all components and accessory parts

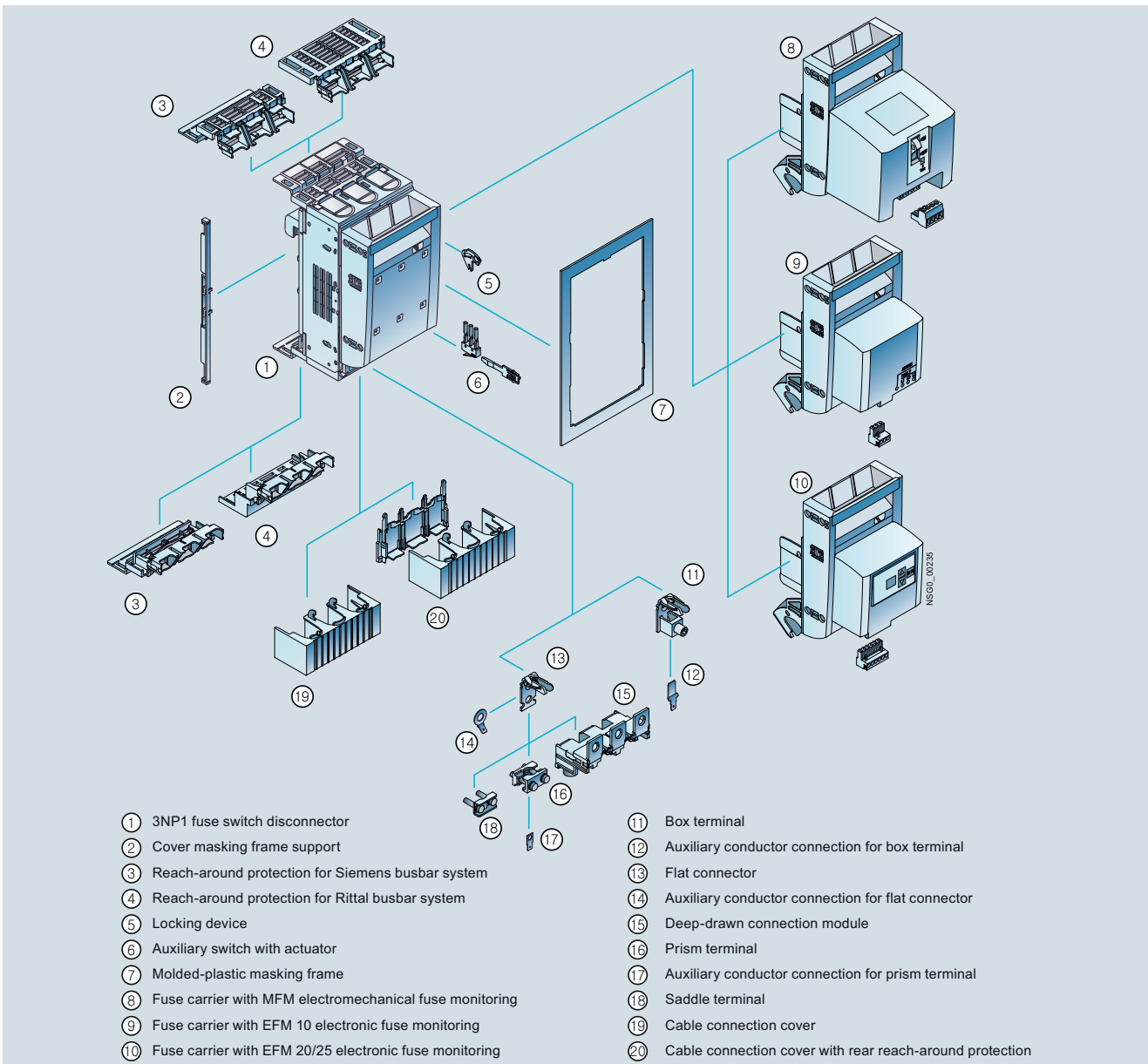

Switch Disconnectors

3NP1 Fuse Switch Disconnectors up to 630 A

Introduction

Benefits

Advantages during planning and configuration

- Low level of equipment variation due to easy convertibility of cable feeder at top/bottom (delivered from factory with cable feeder at bottom).
- Only one device variant for applications in industry and infrastructure thanks to touch and reach-around protection as a standard feature.
- Uniform grid sizes for easy configuration.

Advantages during operation and service

- The optional rear covers for the cable connections ensure optimum touch protection even for switchgear assemblies with rear access.
- Innovative design enables the highest safety for equipment and personnel.
- Fuses can be released and removed using a release shaft.
- Lockable and sealable design enables safe working and prevents unauthorized access.

Advantages during installation

- Only one device version is required for cable feeders at top/bottom and there is no need to intervene in the internal conducting paths.
- One device version with very high short-circuit values dispenses with having to order and install arc splitters to increase the electrical values.
- On all sizes it is possible to install 2 CO contacts for indicating the switching position.
- All devices feature all-round touch protection.
- Box terminals are available for all sizes and shorten the mounting time appreciably.
- Snapping on the sizes NH000 and NH00 shortens the mounting time greatly compared to fixing with screws.
- The screw-fixing method on sizes NH1, NH2 and NH3 provides for easy positioning and at the same time secure contacting of the larger and heavier device versions.
- Small space requirement through compact devices and busbar supports which can be built over.
- Device versions for busbar mounting can be converted to 5 mm or 10 mm thick busbars without parts which can be lost or broken off.

Application

Possible uses

3NP1 fuse switch disconnectors can be used for protecting and switching the most diverse electrical loads:

- Motor starter combinations
- In conjunction with SITOR semiconductor fuses for the protection of frequency converters and soft starters
- Fusing of compensation modules
- Cable feeders
- Group fusing of small loads

The devices are optimized for operation in all kinds of system environments:

- Low-voltage switchgear assemblies for power distribution and MCCs (e.g. main and sub-distribution boards)
- Distribution systems with cover levels of 32 and 70 mm or 45 and 70 mm
- Mechanical engineering
- Railway applications

Fuse monitoring

Fuse monitoring is used to detect, indicate and report faults:

- MFM – electromechanical fuse monitoring for AC/DC networks
- EFM 10 – electronic fuse monitoring for AC networks
- EFM 20 – electronic fuse monitoring with line monitoring for AC networks
- EFM 25 – electronic fuse monitoring with line monitoring for DC networks

Standards and specifications

The 3NP1 fuse switch disconnectors are compliant with:

- IEC 60947-1, EN 60947-1
- IEC 60947-3, EN 60947-3

Mounting

Floor mounting

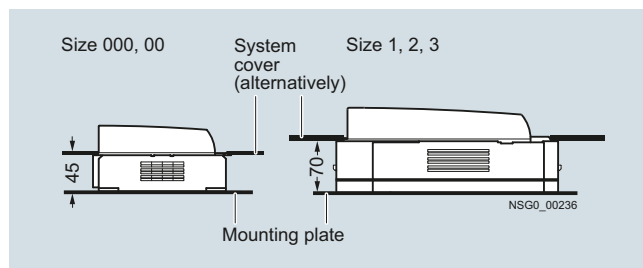

3NP1 fuse switch disconnector for floor mounting

Busbar mounting

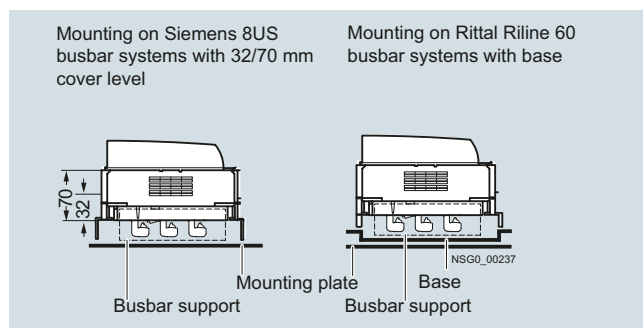

3NP1 fuse switch disconnector for busbar mounting

Switch Disconnectors

3NP1 Fuse Switch Disconnectors up to 630 A

Introduction

Technical specifications

Standards		IEC / EN 60947-1, IEC / EN 60947-3, VDE 0660 Part 7					
Type		3NP1123...	3NP1133...	3NP1143...	3NP1153...	3NP1163...	
Rated uninterrupted current I_u	A	160 ¹⁾	160	250	400	630	
For fuse links acc. to IEC 60269-2	Size	000	00 and 000	1 and 0	2 and 1	3 and 2	
Conventional free air thermal current I_{th}	A	160	160	250	400	630	
Rated operational voltage U_e							
• At 50 Hz/60 Hz AC	V	690	690	690	690	690	
• With DC (3 conducting paths series-connected)	V	440	440	440	440	440	
• With DC (2 conducting paths series-connected)	V	220/240	220/240	220/240	220/240	220/240	
• With utilization category AC-20 or DC-20 Max.	V	1000					
Rated insulation voltage $U_i^{2)}$	V	1000	1000	1000	1000	1000	
Rated impulse withstand voltage U_{imp}	kV	8	8	8	8	8	
Rated conditional short-circuit current with fuses (by fast switch on)	Size/A	000/160	00/160	1/250	2/400	3/630	
• Rated current at 500 V / 690 V AC	kA	80/80	80/80	80/50	80/50	50/50	
• Permissible let-through current of the fuses, peak value	kA	10	15	25	40	50	
Short-circuit strength with fuses (with closed disconnector)	Size/A	000/160	00/160	1/250	2/400	3/630	
• Rated current at 500 V / 690 V, rms value	kA	120/120	120/120	120/100	100/100	100/100	
• Let-through I^2t value	kA ² s	56	158	780	2150	5400	
• Permissible let-through current of the fuses, peak value	kA	15	23	32	40	60	
Rated making capacity with isolating blades at 500 V AC	kA	2	6	17	17	17	
Rated making and breaking capacity							
• At AC-21B, 22B, 23B	400 V AC	A	160	160	250	400	630
• At AC-21B	500 V AC	A	160	160	250	400	630
• At AC-22B	500 V AC	A	125	160	250	400	630
• At AC-23B	500 V AC	A	40	63	200	315	500
• At AC-21B	690 V AC	A	160	160	250	400	630
• At AC-22B	690 V AC	A	50	125	250	400	500
• At AC-23B	690 V AC	A	25	35	100	125	200
• With DC-21B (2 conduct. paths series-connected)	240 V DC	A	160	160	250	400	630
• With DC-22B (2 conduct. paths series-connected)	240 V DC	A	100	160	250	400	630
• With DC-23B (2 conduct. paths series-connected)	240 V DC	A	80	100	200	250	400
• With DC-21B (3 conduct. paths series-connected)	440 V DC	A	100	160	250	400	630
• With DC-22B (3 conduct. paths series-connected)	440 V DC	A	50	125	200	315	500
• With DC-23B (3 conduct. paths series-connected)	440 V DC	A	25	63	100	160	250
Capacitor switching capacity							
At 400 V AC							
• Capacitor rating	kvar	50	50	50	50	50	
• Rated current I_N	A	72	72	72	72	72	
At 525 V AC							
• Capacitor rating	kvar	50	50	50	50	50	
• Rated current I_N	A	55	55	55	55	55	
Permissible ambient temperature³⁾	°C	-25 ... +55 for operation, -50 ... +80 during storage					
Mechanical endurance, operating cycles		2000	2000	1600	1000	1000	
Degree of protection (operator side)							
W/o molded-plastic masking frame / cable lug cover		IP30 (switch closed) / IP20 (switch open)					
With molded-plastic masking frame / cable lug cover		IP40 (switch closed) / IP20 (switch open)					
Power loss of switch at I_{th} (plus fuses)	W	9	12	23	34	48	
Maximum power loss of the usable fuses (per fuse)⁴⁾	W	7.5 ⁵⁾	12	23	34	48	
Max. conductor cross-section of main conductor connection							
Flat terminals	mm ²		Up to 95 (M8)	Up to 150 (M10)	Up to 240 (M10)	Up to 300 (M10)	
Box terminals	mm ²	1.5 ... 50	6 ... 70	70 ... 185	120 ... 240	150 ... 300	
Prism terminals	mm ²	--	35 ... 95	70 ... 150	120 ... 240	150 ... 300	
Saddle terminals	mm ²	--	1.5 ... 70	70 ... 120	120 ... 240	150 ... 300	
Laminated conductors in box terminal	mm	8 x 8	9 x 8	10 x 20	10 x 32	20 x 32	
Rated operational current of auxiliary switch (at max. 250 V AC)							
3NP19...-1FA00 auxiliary switch	A	0.25 ($I_{th} = 5$ A)					
3NP19...-1FB00 auxiliary switch (solid-state compatible)	A	0.1 ($I_{th} = 0.1$ A)					
Permissible mounting positions		Vertical and horizontal (no derating)					

1) 160 A available in combination with feeder terminal 3NP1923-1BD00, otherwise max. 100 A

2) Up to pollution degree 2, above this $U_i = 690$ V.

3) Only with isolating blades; otherwise, please observe specifications of fuse manufacturer.

4) Values are valid when using LV HRC fuse systems with characteristic gG. If using fuses for semiconductor protection, please refer to the assignment table, see page 7/132.

5) For operation up to 160 A, max. 9W.

Switch Disconnectors

3NP1 Fuse Switch Disconnectors up to 630 A

Floor mounting

Selection and ordering data





	Rated current I_u	Size	DT	Article No.	Price per PU	PU (UNIT, SET, M)	PS*/P. unit	PG	Weight per PU approx. kg
For 45 mm cover level									
Basic units									
	Flat terminals			3NP1133-1CA10		1	1 unit	143	0.842
	160	00							
	Box terminals			3NP1123-1CA20		1	1 unit	143	0.551
	100 ¹⁾	000							
160	00		3NP1133-1CA20		1	1 unit	143	0.849	
With MFM electromechanical fuse monitoring									
	Flat terminals			3NP1133-1CA11		1	1 unit	143	1.399
	160	00							
	Box terminals			3NP1133-1CA21		1	1 unit	143	1.399
	160	00							
With EFM 10 electronic fuse monitoring									
	Flat terminals			3NP1133-1CA12		1	1 unit	143	1.103
	160	00							
	Box terminals			3NP1123-1CA22		1	1 unit	143	0.697
	100 ¹⁾	000		3NP1133-1CA22		1	1 unit	143	1.126
160	00								
With EFM 20 electronic fuse monitoring and line monitoring									
	Flat terminals			3NP1133-1CA13		1	1 unit	143	1.134
	160	00							
	Box terminals			3NP1123-1CA23		1	1 unit	143	0.716
	100 ¹⁾	000		3NP1133-1CA23		1	1 unit	143	1.142
160	00								

¹⁾ 160 A available in combination with feeder terminal 3NP1923-1BD00

Switch Disconnectors

3NP1 Fuse Switch Disconnectors up to 630 A

Floor mounting

	Rated current I_u	Size	DT	Article No.	Price per PU	PU (UNIT, SET, M)	PS*/P. unit	PG	Weight per PU approx. kg
For 70 mm cover level									
Basic units									
 3NP1143-1DA20	Flat terminals								
	250	1		3NP1143-1DA10		1	1 unit	143	2.789
	400	2		3NP1153-1DA10		1	1 unit	143	3.675
	630	3		3NP1163-1DA10		1	1 unit	143	4.639
	Box terminals								
	250	1		3NP1143-1DA20		1	1 unit	143	2.950
	400	2		3NP1153-1DA20		1	1 unit	143	5.000
	630	3		3NP1163-1DA20		1	1 unit	143	5.220
	With MFM electromechanical fuse monitoring								
 3NP1143-1DA21	Flat terminals								
	250	1		3NP1143-1DA11		1	1 unit	143	3.590
	400	2		3NP1153-1DA11		1	1 unit	143	6.500
	630	3		3NP1163-1DA11		1	1 unit	143	5.300
	Box terminals								
	250	1		3NP1143-1DA21		1	1 unit	143	3.630
	400	2		3NP1153-1DA21		1	1 unit	143	5.115
	630	3		3NP1163-1DA21		1	1 unit	143	5.908
	With EFM 10 electronic fuse monitoring								
 3NP1143-1DA22	Flat terminals								
	250	1		3NP1143-1DA12		1	1 unit	143	3.141
	400	2		3NP1153-1DA12		1	1 unit	143	4.122
	630	3		3NP1163-1DA12		1	1 unit	143	4.950
	Box terminals								
	250	1		3NP1143-1DA22		1	1 unit	143	3.270
	400	2		3NP1153-1DA22		1	1 unit	143	4.762
	630	3		3NP1163-1DA22		1	1 unit	143	5.540
	With EFM 20 electronic fuse monitoring and line monitoring								
 3NP1143-1DA23	Flat terminals								
	250	1		3NP1143-1DA13		1	1 unit	143	3.151
	400	2		3NP1153-1DA13		1	1 unit	143	4.104
	630	3		3NP1163-1DA13		1	1 unit	143	4.972
	Box terminals								
	250	1		3NP1143-1DA23		1	1 unit	143	3.307
	400	2		3NP1153-1DA23		1	1 unit	143	4.792
	630	3		3NP1163-1DA23		1	1 unit	143	5.594

7

Switch Disconnectors

3NP1 Fuse Switch Disconnectors up to 630 A

For 40 mm busbar system

Selection and ordering data

Rated current I_u	Size	DT	Article No.	Price per PU	PU (UNIT, SET, M)	PS*/P. unit	PG	Weight per PU approx. kg
A								
With reach-around protection suitable for Siemens 8US busbar system and Rittal 40mm busbar system without base¹⁾								
Basic units								
Flat terminals								
160	00		3NP1133-1BB10		1	1 unit	143	1.112
Box terminals								
100 ²⁾	000		3NP1123-1BB20		1	1 unit	143	0.950
160	00		3NP1133-1BB20		1	1 unit	143	1.135
With MFM electromechanical fuse monitoring								
Flat terminals								
160	00		3NP1133-1BB11		1	1 unit	143	1.756
Box terminals								
160	00		3NP1133-1BB21		1	1 unit	143	1.743
With EFM 10 electronic fuse monitoring								
Flat terminals								
160	00		3NP1133-1BB12		1	1 unit	143	1.389
Box terminals								
100 ²⁾	000		3NP1123-1BB22		1	1 unit	143	1.099
160	00		3NP1133-1BB22		1	1 unit	143	4.133
With EFM 20 electronic fuse monitoring and line monitoring								
Flat terminals								
160	00		3NP1133-1BB13		1	1 unit	143	1.120
Box terminals								
100 ²⁾	000		3NP1123-1BB23		1	1 unit	143	1.107
160	00		3NP1133-1BB23		1	1 unit	143	1.120

¹⁾ Cannot be used with T profile rails

²⁾ 160 A available in combination with feeder terminal 3NP1923-1BD00

Note:

Delivered from factory with cable feeder at bottom and convertible by the customer

Switch Disconnectors

3NP1 Fuse Switch Disconnectors up to 630 A

For 40 mm busbar system

Rated current I_u	Size	DT	Article No.	Price per PU	PU (UNIT, SET, M)	PS*/P. unit	PG	Weight per PU approx. kg
A								
With reach-around protection suitable for Rittal 40mm busbar system with base¹⁾								
Basic units								
Flat terminals								
160	00		3NP1133-1JB10		1	1 unit	143	1.115
Box terminals								
100 ¹⁾	000		3NP1123-1JB20		1	1 unit	143	0.907
160	00		3NP1133-1JB20		1	1 unit	143	1.118
With MFM electromechanical fuse monitoring								
Flat terminals								
160	00		3NP1133-1JB11		1	1 unit	143	1.670
Box terminals								
160	00		3NP1133-1JB21		1	1 unit	143	1.690
With EFM 10 electronic fuse monitoring								
Flat terminals								
160	00		3NP1133-1JB12		1	1 unit	143	1.120
Box terminals								
100 ¹⁾	000		3NP1123-1JB22		1	1 unit	143	0.940
160	00		3NP1133-1JB22		1	1 unit	143	1.120
With EFM 20 electronic fuse monitoring and line monitoring								
Flat terminals								
160	00		3NP1133-1JB13		1	1 unit	143	1.120
Box terminals								
100 ¹⁾	000		3NP1123-1JB23		1	1 unit	143	0.940
160	00		3NP1133-1JB23		1	1 unit	143	1.414

¹⁾ Cannot be used with T profile rails

²⁾ 160 A available in combination with feeder terminal 3NP1923-1BD00

Note:





Delivered from factory with cable feeder at bottom and convertible by the customer

Switch Disconnectors

3NP1 Fuse Switch Disconnectors up to 630 A

For 60 mm busbar system

Selection and ordering data

	Rated current I_n	Size	DT	Article No.	Price per PU	PU (UNIT, SET, M)	PS*/P. unit	PG	Weight per PU approx. kg
A									
With reach-around protection suitable for Siemens 8US, Wöhner Classic, and Rittal RiLine60 busbar systems without base									
Basic units									
 3NP1133-1BC20	Flat terminals								
	160	00		3NP1133-1BC10		1	1 unit	143	1.155
	250	1		3NP1143-1BC10		1	1 unit	143	3.245
	400	2		3NP1153-1BC10		1	1 unit	143	4.314
	630	3		3NP1163-1BC10		1	1 unit	143	5.260
	Box terminals								
	100 ¹⁾	000		3NP1123-1BC20		1	1 unit	143	0.971
	160	00		3NP1133-1BC20		1	1 unit	143	1.146
	250	1		3NP1143-1BC20		1	1 unit	143	3.306
	400	2		3NP1153-1BC20		1	1 unit	143	4.672
630	3		3NP1163-1BC20		1	1 unit	143	5.538	
With MFM electromechanical fuse monitoring									
 3NP1133-1BC21	Flat terminals								
	160	00		3NP1133-1BC11		1	1 unit	143	1.698
	250	1		3NP1143-1BC11		1	1 unit	143	3.914
	400	2		3NP1153-1BC11		1	1 unit	143	5.016
	630	3		3NP1163-1BC11		1	1 unit	143	5.910
	Box terminals								
	160	00		3NP1133-1BC21		1	1 unit	143	1.702
	250	1		3NP1143-1BC21		1	1 unit	143	3.993
	400	2		3NP1153-1BC21		1	1 unit	143	5.500
	630	3		3NP1163-1BC21		1	1 unit	143	6.223
With EFM 10 electronic fuse monitoring									
 3NP1133-1BC22	Flat terminals								
	160	00		3NP1133-1BC12		1	1 unit	143	1.394
	250	1		3NP1143-1BC12		1	1 unit	143	3.564
	400	2		3NP1153-1BC12		1	1 unit	143	4.666
	630	3		3NP1163-1BC12		1	1 unit	143	5.555
	Box terminals								
	100 ¹⁾	000		3NP1123-1BC22		1	1 unit	143	1.109
	160	00		3NP1133-1BC22		1	1 unit	143	1.406
	250	1		3NP1143-1BC22		1	1 unit	143	3.650
	400	2		3NP1153-1BC22		1	1 unit	143	5.014
630	3		3NP1163-1BC22		1	1 unit	143	5.826	
With EFM 20 electronic fuse monitoring and line monitoring									
 3NP1133-1BC23	Flat terminals								
	160	00		3NP1133-1BC13		1	1 unit	143	1.411
	250	1		3NP1143-1BC13		1	1 unit	143	3.641
	400	2		3NP1153-1BC13		1	1 unit	143	4.750
	630	3		3NP1163-1BC13		1	1 unit	143	5.611
	Box terminals								
	100 ¹⁾	000		3NP1123-1BC23		1	1 unit	143	1.121
	160	00		3NP1133-1BC23		1	1 unit	143	1.470
	250	1		3NP1143-1BC23		1	1 unit	143	3.685
	400	2		3NP1153-1BC23		1	1 unit	143	5.090
630	3		3NP1163-1BC23		1	1 unit	143	5.920	

¹⁾ 160 A available in combination with feeder terminal 3NP1923-1BD00





Note:

Delivered from factory with cable feeder at bottom and convertible by the customer

Switch Disconnectors

3NP1 Fuse Switch Disconnectors up to 630 A

For 60 mm busbar system

	Rated current I_u	Size	DT	Article No.	Price per PU	PU (UNIT, SET, M)	PS*/P. unit	PG	Weight per PU approx. kg	
A										
With reach-around protection suitable for Rittal RiLine60 busbar system with base										
Basic units										
	Flat terminals									
	160	00		3NP1133-1JC10		1	1 unit	143	1.125	
	250	1		3NP1143-1JC10		1	1 unit	143	3.246	
	400	2		3NP1153-1JC10		1	1 unit	143	4.316	
	630	3		3NP1163-1JC10		1	1 unit	143	5.244	
	Box terminals									
	100 ¹⁾	000		3NP1123-1JC20		1	1 unit	143	0.912	
	160	00		3NP1133-1JC20		1	1 unit	143	1.123	
	250	1		3NP1143-1JC20		1	1 unit	143	3.323	
	400	2		3NP1153-1JC20		1	1 unit	143	4.670	
	630	3		3NP1163-1JC20		1	1 unit	143	5.522	
	With MFM electromechanical fuse monitoring									
		Flat terminals								
160		00		3NP1133-1JC11		1	1 unit	143	1.700	
250		1		3NP1143-1JC11		1	1 unit	143	3.960	
400		2		3NP1153-1JC11		1	1 unit	143	5.050	
630		3		3NP1163-1JC11		1	1 unit	143	6.012	
Box terminals										
160		00		3NP1133-1JC21		1	1 unit	143	1.715	
250		1		3NP1143-1JC21		1	1 unit	143	4.100	
400		2		3NP1153-1JC21		1	1 unit	143	5.400	
630		3		3NP1163-1JC21		1	1 unit	143	6.310	
With EFM 10 electronic fuse monitoring										
		Flat terminals								
		160	00		3NP1133-1JC12		1	1 unit	143	1.380
	250	1		3NP1143-1JC12		1	1 unit	143	3.638	
	400	2		3NP1153-1JC12		1	1 unit	143	4.721	
	630	3		3NP1163-1JC12		1	1 unit	143	6.980	
	Box terminals									
	100 ¹⁾	000		3NP1123-1JC22		1	1 unit	143	1.065	
	160	00		3NP1133-1JC22		1	1 unit	143	1.397	
	250	1		3NP1143-1JC22		1	1 unit	143	3.700	
	400	2		3NP1153-1JC22		1	1 unit	143	5.074	
	630	3		3NP1163-1JC22		1	1 unit	143	7.180	
	With EFM 20 electronic fuse monitoring and line monitoring									
		Flat terminals								
160		00		3NP1133-1JC13		1	1 unit	143	1.401	
250		1		3NP1143-1JC13		1	1 unit	143	3.667	
400		2		3NP1153-1JC13		1	1 unit	143	4.740	
630		3		3NP1163-1JC13		1	1 unit	143	6.980	
Box terminals										
100 ¹⁾		000		3NP1123-1JC23		1	1 unit	143	1.086	
160		00		3NP1133-1JC23		1	1 unit	143	1.413	
250		1		3NP1143-1JC23		1	1 unit	143	3.690	
400		2		3NP1153-1JC23		1	1 unit	143	5.130	
630		3		3NP1163-1JC23		1	1 unit	143	7.180	

¹⁾ 160 A available in combination with feeder terminal 3NP1923-1BD00

Note:







Delivered from factory with cable feeder at bottom and convertible by the customer

Switch Disconnectors

3NP1 Fuse Switch Disconnectors up to 630 A

Accessories

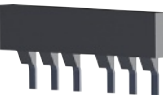







Selection and ordering data

Version	DT	Article No.	Price per PU	PU (UNIT, SET, M)	PS*/P. unit	PG	Weight per PU approx. kg
For size 000							
 3NP1923-1BD00	Connection methods Feeder terminals , 16 ... 95 mm ² (1 set = 3 units)		3NP1923-1BD00	1	1 unit	143	0.261
	<ul style="list-style-type: none"> For 3NP1123 with box terminal for use up to 160 A For infeed when using the 3-phase busbar For connection of copper conductors 						
 3NP1923-1BE20	Three-tier terminals , 3 x 2.5 ... 16 mm ² , (1 set = 3 units)		3NP1923-1BE20	1	1 unit	143	0.130
	<ul style="list-style-type: none"> For 3NP1123 with box terminal For connection of copper conductors 						
 3NP1923-1BF10	Covering caps For 1 blank space on a three-phase busbar (1 set = 20 units)		3NP1923-1BF10	1	1 unit	143	0.011
 3NP1933-1BF30	3-phase busbar $I_U = \text{max. } 225 \text{ A}$ (1 set = 5 units)		3NP1923-1BF20 3NP1923-1BF30 3NP1923-1BF40 3NP1923-1BF50	1	1 unit	143	0.267
	<ul style="list-style-type: none"> For 2x NH000 						
	<ul style="list-style-type: none"> For 3x NH000 						
	<ul style="list-style-type: none"> For 4x NH000 						
	Link rail , $I_U = \text{max. } 225 \text{ A}$ For 3-phase busbars (1 set = 3 units)						
 3NP1933-1BF50			3NP1923-1BF50	1	1 unit	143	0.262
 3NP1933-1BG40	Auxiliary conductor connections For flat tab sleeve 6.3 x 0.8 mm, max. 5 A (1 set = 3 units) For 3NP1123 with box terminal		3NP1923-1BG40	1	1 unit	143	0.006

Switch Disconnectors

3NP1 Fuse Switch Disconnectors up to 630 A









Accessories

Version	DT	Article No.	Price per PU	PU (UNIT, SET, M)	PS*/P. unit	PG	Weight per PU approx. kg
For size 000 (continued)							
Device covers, auxiliary switches							
Reach-around protection for busbar mounting							
1x top, 1x bottom Spare part, included in scope of delivery of the 3NP1, can also be used for retrofitting to a different busbar system							
		3NP1923-1CA10		1	1 unit	143	0.053
3NP1923-1CA10		3NP1923-1CA20		1	1 unit	143	0.057
		3NP1923-1CB00		1	1 unit	143	0.046
3NP1923-1CB00							
Cable connection covers							
Only for busbar systems 40 mm / 60 mm, top and bottom							
Masking frame supports							
		3NP1923-1CF00		1	1 unit	143	0.016
3NP1923-1CF00							
System masking frames							
		3NP1923-1DA00		1	1 unit	143	0.061
3NP1923-1DA00							
Fixing kits							
		3NP1923-1EA00		1	1 unit	143	0.067
3NP1923-1EA00							
		3NP1920-1FA00		1	1 unit	143	0.018
3NP1920-1FA00		3NP1920-1FB00		1	1 unit	143	0.016
Auxiliary switches							
1 CO contact							
1 CO contact, solid-state compatible							
Fuse carriers							
Spare part, included in scope of delivery of the 3NP1, fuse monitoring can be retrofitted by replacing the fuse carrier							
		3NP1923-1GA00		1	1 unit	143	0.159
3NP1923-1GA00		3NP1923-1GA00		1	1 unit	143	0.159
		3NP1923-1GB20		1	1 unit	143	0.316
		3NP1923-1GB30		1	1 unit	143	0.348
		3NP1923-1GB50		1	1 unit	143	0.338
Locking devices							
		3NP1900-1HA00		1	1 unit	143	0.023
3NP1900-1HA00							

Switch Disconnectors

3NP1 Fuse Switch Disconnectors up to 630 A





Accessories

Version	DT	Article No.	Price per PU	PU (UNIT, SET, M)	PS*/P. unit	PG	Weight per PU approx. kg
For size 00							
 3NP1933-1BA00		Connection methods Saddle terminals , 1.5 ... 70 mm ² (1 set = 3 units) • For 3NP1133 with flat terminal • For connection of copper conductors					
		3NP1933-1BA00		1	1 unit	143	0.047
 3NP1933-1BB10		Prism terminals single, 35 ... 95 mm ² (1 set = 3 units) • For 3NP1133 with flat terminal • For connection of copper or aluminum conductors					
		3NP1933-1BB10		1	1 unit	143	0.126
 3NP1933-1BC00		Terminal kits , 6 ... 70 mm ² For 32-mm cover level with box terminal • For 3NP1133 with flat terminal • For connection of copper conductors					
		3NP1933-1BC00		1	1 unit	143	0.193
 3NP1933-1BE10		Three-tier terminals , 3 x 2.5 ... 16 mm ² (1 set = 3 units) • For 3NP1133 with flat terminal • For connection of copper conductors					
		3NP1933-1BE10		1	1 unit	143	0.113
 3NP1923-1BE20		Three-tier terminals , 3 x 2.5 ... 16 mm ² (1 set = 3 units) • For 3NP1133 with box terminal • For connection of copper conductors					
		3NP1923-1BE20		1	1 unit	143	0.130
 3NP1933-1BG10		Auxiliary conductor connections For flat tab sleeve 6.3 x 0.8 mm, max. 5 A For flat terminal (1 set = 3 units)					
		3NP1933-1BG10		1	1 unit	143	0.006
 3NP1933-1BG30		Auxiliary conductor connections For flat tab sleeve 6.3 x 0.8 mm, max. 5A For prism terminal (1 set = 3 units)					
		3NP1933-1BG30		1	1 unit	143	0.004
 3NP1933-1BG40		Auxiliary conductor connections For flat tab sleeve 6.3 x 0.8 mm, max. 5 A For box terminal (1 set = 3 units)					
		3NP1933-1BG40		1	1 unit	143	0.007

Switch Disconnectors

3NP1 Fuse Switch Disconnectors up to 630 A

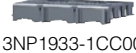
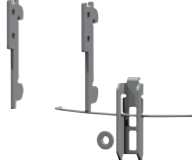





Accessories

Version	DT	Article No.	Price per PU	PU (UNIT, SET, M)	PS*/P. unit	PG	Weight per PU approx. kg
For size 00 (continued)							
Device covers, auxiliary switches							
Reach-around protection for busbar mounting							
 3NP1933-1CA10							
1x top, 1x bottom Spare part, included in scope of delivery of the 3NP1, can also be used for retrofitting to a different busbar system							
<ul style="list-style-type: none"> • For Siemens 8US system • For Rittal system 		3NP1933-1CA10		1	1 unit	143	0.062
		3NP1933-1CA20		1	1 unit	143	0.051
Cable connection covers (at top and bottom)							
 3NP1933-1CB00							
For flat terminal		3NP1933-1CB00		1	1 unit	143	0.063
Cable connection covers with rear reach-around protection in case of busbar mounting (at top and bottom)							
 3NP1933-1CC00							
For flat terminal		3NP1933-1CC00		1	1 unit	143	0.112
Cable connection covers with rear reach-around protection in case of busbar mounting (at top and bottom)							
 3NP1933-1CD00							
For flat terminal		3NP1933-1CD00		1	1 unit	143	0.132
Masking frame supports							
 3NP1933-1CF00							
(1 set = 2 units)		3NP1933-1CF00		1	1 unit	143	0.021
System masking frames							
External dimensions (H x W) 215 x 130 mm		3NP1933-1DA00		1	1 unit	143	0.035
Fixing kits							
 3NP1933-1EB00							
For 2 standard mounting rails 125/150 mm		3NP1933-1EB00		1	1 unit	143	0.053
Auxiliary switches							
 3NP1930-1FB00							
1 CO contact		3NP1930-1FA00		1	1 unit	143	0.018
1 CO contact, solid-state compatible		3NP1930-1FB00		1	1 unit	143	0.019
Fuse carriers							
 3NP1933-1GB10							
Spare part, included in scope of delivery of the 3NP1, fuse monitoring can be retrofitted by replacing the fuse carrier							
<ul style="list-style-type: none"> • Standard • With MFM electromechanical fuse monitoring • With EFM 10 electronic fuse monitoring • With EFM 20 electronic fuse monitoring and line monitoring • With EFM 25 electronic fuse monitoring and line monitoring 		3NP1933-1GA00		1	1 unit	143	0.220
		3NP1933-1GB10		1	1 unit	143	0.687
		3NP1933-1GB20		1	1 unit	143	0.395
		3NP1933-1GB30		1	1 unit	143	0.410
		3NP1933-1GB50		1	1 unit	143	0.407
Locking devices							
(1 set = 10 units)		3NP1900-1HA00		1	1 unit	143	0.023

Switch Disconnectors

3NP1 Fuse Switch Disconnectors up to 630 A

Accessories

Version	DT	Article No.	Price per PU	PU (UNIT, SET, M)	PS*/P. unit	PG	Weight per PU approx. kg
For size 1							
 3NP1943-1BA00		Connection methods Saddle terminals , 70 ... 120 mm ² (1 set = 3 units) • For 3NP1143 with flat terminal • For connection of copper conductors			1	1 unit	143 0.127
 3NP1943-1BB10		Prism terminals single, 70 ... 150 mm ² (1 set = 3 units) • For 3NP1143 with flat terminal • For connection of copper or aluminum conductors			1	1 unit	143 0.321
 3NP1943-1BB20		Prism terminals double, 2 x 35 ... 70 mm ² (1 set = 3 units) • For 3NP1143 with flat terminal • For connection of copper or aluminum conductors			1	1 unit	143 0.457
 3NP1943-1BG10		Auxiliary conductor connections For flat tab sleeve 6.3 x 0.8 mm, max. 5 A For flat terminal (1 set = 3 units)			1	1 unit	143 0.006
 3NP1943-1BG30		Auxiliary conductor connections For flat tab sleeve 6.3 x 0.8 mm; max. 5 A for saddle-type or prism terminals (1 set = 3 units)			1	1 unit	143 0.007
 3NP1943-1BG40		Auxiliary conductor connections For flat tab sleeve 6.3 x 0.8 mm; max. 5 A for box terminal (1 set = 3 units)			1	1 unit	143 0.015

Switch Disconnectors

3NP1 Fuse Switch Disconnectors up to 630 A



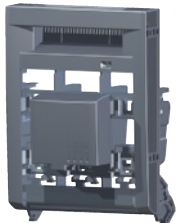







Accessories

Version	DT	Article No.	Price per PU	PU (UNIT, SET, M)	PS*/P. unit	PG	Weight per PU approx. kg
For size 1 (continued)							
Device covers, auxiliary switches							
Reach-around protection for busbar mounting							
 3NP1943-1CA10							
1x top, 1x bottom Spare part, included in scope of delivery of the 3NP1, can also be used for retrofitting to a different busbar system							
<ul style="list-style-type: none"> • For Siemens 8US system • For Rittal system 		3NP1943-1CA10		1	1 unit	143	0.034
		3NP1943-1CA20		1	1 unit	143	0.045
Cable connection covers (at top and bottom)							
 3NP1943-1CB00							
		3NP1943-1CB00		1	1 unit	143	0.182
Cable connection covers							
 3NP1943-1CD00							
With rear reach-around protection (at top and bottom)		3NP1943-1CD00		1	1 unit	143	0.369
Masking frame supports (1 set = 2 units)							
		3NP1943-1CF00		1	1 unit	143	0.042
System masking frames							
External dimensions (H x W) 375 x 220 mm		3NP1943-1DA00		1	1 unit	143	0.123
Fixing kits							
 3NP1943-1EB00							
For 2 standard mounting rails 125/150 mm		3NP1943-1EB00		1	1 unit	143	0.055
Auxiliary switches							
 3NP1940-1FA00							
1 CO contact		3NP1940-1FA00		1	1 unit	143	0.020
1 CO contact, solid-state compatible		3NP1940-1FB00		1	1 unit	143	0.021
Fuse carriers							
 3NP1943-1GB20							
Spare part, included in scope of delivery of the 3NP1, fuse monitoring can be retrofitted by replacing the fuse carrier							
<ul style="list-style-type: none"> • Standard • With MFM electromechanical fuse monitoring • With EFM 10 electronic fuse monitoring • With EFM 20 electronic fuse monitoring and line monitoring • With EFM 25 electronic fuse monitoring and line monitoring 		3NP1943-1GA00		1	1 unit	143	0.776
		3NP1943-1GB10		1	1 unit	143	1.319
		3NP1943-1GB20		1	1 unit	143	0.999
		3NP1943-1GB30		1	1 unit	143	1.004
		3NP1943-1GB50		1	1 unit	143	0.085
Locking devices							
(1 set = 10 units)		3NP1900-1HA00		1	1 unit	143	0.023

Switch Disconnectors

3NP1 Fuse Switch Disconnectors up to 630 A











Accessories

Version	DT	Article No.	Price per PU	PU (UNIT, SET, M)	PS*/P. unit	PG	Weight per PU approx. kg
For size 2							
Connection methods							
 3NP1953-1BA00		Saddle terminals , 120 ... 240 mm ² (1 set = 3 units) • For 3NP1153 with flat terminal • For connection of copper conductors			1	1 unit	143 0.374
 3NP1953-1BB10		Prism terminals single, 120 ... 240 mm ² (1 set = 3 units) • For 3NP1153 with flat terminal • For connection of copper or aluminum conductors			1	1 unit	143 0.552
 3NP1953-1BB20		Prism terminals double, 2 x 70 ... 120 mm ² (1 set = 3 units) • For 3NP1153 with flat terminal • For connection of copper or aluminum conductors			1	1 unit	143 0.770
 3NP1943-1BG10		Auxiliary conductor connections For flat tab sleeve 6.3 x 0.8 mm, max. 5 A For flat terminal (1 set = 3 units)			1	1 unit	143 0.006
 3NP1953-1BG30		Auxiliary conductor connections For flat tab sleeve 6.3 x 0.8 mm; max. 5 A For saddle-type or prism terminals (1 set = 3 units)			1	1 unit	143 0.008
 3NP1953-1BG40		Auxiliary conductor connections For flat tab sleeve 6.3 x 0.8 mm; max. 5 A For box terminal (1 set = 3 units)			1	1 unit	143 0.032
Device covers, auxiliary switches							
Reach-around protection for busbar mounting							
 3NP1953-1CA10		1x top, 1x bottom Spare part, included in scope of delivery of the 3NP1, can also be used for retrofitting to a different busbar system • For Siemens 8US system • For Rittal system			1	1 unit	143 0.038
					1	1 unit	143 0.042
 3NP1953-1CB00		Cable connection covers (at top and bottom) Cable connection covers With rear reach-around protection (at top and bottom)			1	1 unit	143 0.300
					1	1 unit	143 0.474
		Masking frame supports (1 set = 2 units)			1	1 unit	143 0.042
		System masking frames External dimensions (H x W) 375 x 245 mm			1	1 unit	143 0.101
		Auxiliary switches 1 CO contact 1 CO contact, solid-state compatible			1	1 unit	143 0.020
 3NP1940-1FA00					1	1 unit	143 0.021
					1	1 unit	143 0.021
Fuse carriers							
 3NP1953-1GB30		Spare part, included in scope of delivery of the 3NP1, fuse monitoring can be retrofitted by replacing the fuse carrier • Standard • With MFM electromechanical fuse monitoring • With EFM 10 electronic fuse monitoring • With EFM 20 electronic fuse monitoring and line monitoring • With EFM 25 electronic fuse monitoring and line monitoring			1	1 unit	143 0.833
					1	1 unit	143 1.399
					1	1 unit	143 1.049
					1	1 unit	143 1.079
					1	1 unit	143 3.000
		Locking devices (1 set = 10 units)			1	1 unit	143 0.023
					1	1 unit	143 0.023

Switch Disconnectors

3NP1 Fuse Switch Disconnectors up to 630 A

Accessories

Version	DT	Article No.	Price per PU	PU (UNIT, SET, M)	PS*/P. unit	PG	Weight per PU approx. kg
For size 3							
		Connection methods Saddle terminals , 150 ... 300 mm ² (1 set = 3 units) • For 3NP1163 with flat terminal • For connection of copper conductors					
3NP1963-1BA00		3NP1963-1BA00		1	1 unit	143	0.385
		Prism terminals single, 150 ... 300 mm ² (1 set = 3 units) • For 3NP1163 with flat terminal • For connection of copper or aluminum conductors					
3NP1963-1BB10		3NP1963-1BB10		1	1 unit	143	0.681
		Prism terminals double, 2 x 150 ... 185 mm ² (1 set = 3 units) • For 3NP1163 with flat terminal • For connection of copper or aluminum conductors					
3NP1963-1BB20		3NP1963-1BB20		1	1 unit	143	1.068
		Auxiliary conductor connections For flat tab sleeve 6.3 x 0.8 mm, max. 5 A For flat terminal (1 set = 3 units)					
3NP1943-1BG10		3NP1943-1BG10		1	1 unit	143	0.006
		Auxiliary conductor connections For flat tab sleeve 6.3 x 0.8 mm, max. 5 A For saddle-type or prism terminal (1 set = 3 units)					
3NP1953-1BG30		3NP1953-1BG30		1	1 unit	143	0.008
		Auxiliary conductor connections For flat tab sleeve 6.3 x 0.8 mm, max. 5 A For box terminal (1 set = 3 units)					
3NP1953-1BG40		3NP1953-1BG40		1	1 unit	143	0.032
Device covers, auxiliary switches							
		Reach-around protection for busbar mounting 1x top, 1x bottom Spare part, included in scope of delivery of the 3NP1, can also be used for retrofitting to a different busbar system • For Siemens 8US system • For Rittal system					
3NP1963-1CA10		3NP1963-1CA10		1	1 unit	143	0.043
		3NP1963-1CA20		1	1 unit	143	0.051
		Cable connection covers (at top and bottom) Cable connection covers With rear reach-around protection (at top and bottom)					
3NP1963-1CB00		3NP1963-1CB00		1	1 unit	143	0.274
		3NP1963-1CD00		1	1 unit	143	0.550
		Masking frame supports (1 set = 2 units)		1	1 unit	143	0.042
		System masking frames External dimensions (H x W) 375 x 290 mm					
		3NP1963-1DA00		1	1 unit	143	0.148
		Auxiliary switches 1 CO contact 1 CO contact, solid-state compatible					
3NP1940-1FA00		3NP1940-1FA00		1	1 unit	143	0.020
		3NP1940-1FB00		1	1 unit	143	0.021
		Fuse carriers Spare part, included in scope of delivery of the 3NP1, fuse monitoring can be retrofitted by replacing the fuse carrier • Standard • With MFM electromechanical fuse monitoring • With EFM 10 electronic fuse monitoring • With EFM 20 electronic fuse monitoring and line monitoring • With EFM 25 electronic fuse monitoring and line monitoring					
3NP1963-1GB50		3NP1963-1GA00		1	1 unit	143	1.011
		3NP1963-1GB10		1	1 unit	143	1.551
		3NP1963-1GB20		1	1 unit	143	1.198
		3NP1963-1GB30		1	1 unit	143	1.239
		3NP1963-1GB50		1	1 unit	143	1.211
		Locking devices (1 set = 10 units)					
		3NP1900-1HA00		1	1 unit	143	0.023

Switch Disconnectors

3NP1 Fuse Switch Disconnectors up to 630 A

Fuses

Overview

The 3NP1 fuse switch disconnectors are suitable for all fuses in LV HRC design, see chapter 5.

SITOR semiconductor fuses in LV HRC design can also be used, although it must be noted that, compared to cable and line protection fuses, these get much hotter during operation. For this reason, the fuse must be operated below the rated current I_n of the device (derating) when installed in a closed switching device.

The following table shows the permissible load currents of the SITOR semiconductor fuses for installation in 3NP1. The values were determined using the conductor cross-sections specified in the table.

SITOR semiconductor fuses for 3NP1 fuse switch disconnectors: Assignment table

Note

If using smaller cross-sections, a considerably higher derating is required due to the lower heat dissipation.

SITOR semiconductor fuse data						Permissible load currents of fuse when installed in					
Type ¹⁾	Rated current I_n A	Rated voltage ²⁾ V AC	Operational class	Size	Required conductor cross-section Cu mm ²	3NP1 for floor mounting			3NP1 for busbar mounting		
						Type	Size	Permissible load current ³⁾ A	Type	Size	Permissible load current ^{3) 4)} A
3NC23..	150	500	gR	3	70	3NP1163	3	140	3NP1163	3	150
3NC2425..	200	500	gR	3	95	3NP1163	3	175	3NP1163	3	190
3NC2427..	250	500	gR	3	120	3NP1163	3	220	3NP1163	3	237
3NC2428..	300	500	gR	3	185	3NP1163	3	250	3NP1163	3	285
3NC2431..	350	500	gR	3	240	3NP1163	3	320	3NP1163	3	332
3NC2432..	400	500	aR	3	240	3NP1163	3	370	3NP1163	3	380
3NC3336-1	630	1000	aR	3	2x (40x5)	3NP1163	3	500	3NP1163	3	500
3NC3430-1	315	1250	aR	3	2x95	3NP1163	3	280	3NP1163	3	285
3NC3432-1	400	1250	aR	3	2x120	3NP1163	3	340	3NP1163	3	340
3NC3434-1	500	1250	aR	3	2x150	3NP1163	3	400	3NP1163	3	425
3NC3436-1	630	1250	aR	3	2x (40x5)	3NP1163	3	460	3NP1163	3	535
3NC8423..	150	660	gR	3	70	3NP1163	3	120	3NP1163	3	140
3NC8425..	200	660	gR	3	95	3NP1163	3	160	3NP1163	3	190
3NC8427..	250	660	gR	3	120	3NP1163	3	200	3NP1163	3	240
3NC8431..	350	660	gR	3	240	3NP1163	3	270	3NP1163	3	300
3NC8434..	500	660	gR	3	2x 150	3NP1163	3	385	3NP1163	3	385
3NE1020-2	80	690	gR	00	25	3NP1133	00	80	3NP1133	00	80
3NE1021-0	100	690	gS	00	35	3NP1133	00	100	3NP1133	00	100
3NE1021-2	100	690	gR	00	35	3NP1133	00	95	3NP1133	00	95
3NE1022-0	125	690	gS	00	50	3NP1133	00	120	3NP1133	00	120
3NE1022-2	125	690	gR	00	50	3NP1133	00	115	3NP1133	00	115
3NE1224-0	160	690	gS	1	70	3NP1143	1	160	3NP1143	1	160
						3NP1153	2	160	3NP1153	2	160
3NE1224-2/-3	160	690	gR	1	70	3NP1143	1	150	3NP1143	1	152
						3NP1153	2	200	3NP1153	2	200
3NE1224-2/-3	160	690	gR	1	70	3NP1143	1	150	3NP1143	1	152
						3NP1153	2	160	3NP1153	2	160
3NE1225-2/-3	200	690	gR	1	95	3NP1143	1	180	3NP1143	1	180
						3NP1153	2	190	3NP1153	2	190
3NE1227-0	250	690	gS	1	120	3NP1143	1	235	3NP1143	1	238
						3NP1153	2	250	3NP1153	2	250
3NE1227-2/-3	250	690	gR	1	120	3NP1143	1	220	3NP1143	1	213
						3NP1153	2	235	3NP1153	2	235
3NE1230-0	315	690	gS	1	2x 70	3NP1153	2	290	3NP1153	2	315
3NE1230-2/-3	315	690	gR	1	2x 70	3NP1153	2	278	3NP1153	2	315
						3NP1163	3	380	3NP1163	3	400
3NE1331-0	350	690	gS	2	2x 95	3NP1153	2	315	3NP1153	2	350
						3NP1163	3	340	3NP1163	3	350
3NE1331-2/-3	350	690	gR	2	2x 95	3NP1153	2	300	3NP1153	2	330
						3NP1163	3	330	3NP1163	3	350
3NE1332-0	400	690	gS	2	2x 95	3NP1153	2	340	3NP1153	2	380
3NE1332-2/-3	400	690	gR	2	2x 95	3NP1153	2	328	3NP1153	2	360
						3NP1163	3	370	3NP1163	3	400
3NE1333-0	450	690	gS	2	2x 120	3NP1163	3	450	3NP1163	3	430
3NE1333-2/-3	450	690	gR	2	2x 120	3NP1163	3	430	3NP1163	3	420

Switch Disconnectors

3NP1 Fuse Switch Disconnectors up to 630 A

Fuses

SITOR semiconductor fuse data						Permissible load currents of fuse when installed in					
Type ¹⁾	Rated current I_n A	Rated voltage ²⁾ V AC	Operational class	Size	Required conductor cross-section Cu mm ²	3NP1 for floor mounting			3NP1 for busbar mounting		
						Type	Size	Permissible load current ³⁾ A	Type	Size	Permissible load current ^{3) 4)} A
3NE1334-0	500	690	gS	2	2x 120	3NP1163	3	500	3NP1163	3	450
3NE1334-2/-3	500	690	gR	2	2x 120	3NP1163	3	475	3NP1163	3	450
3NE1435-0	560	690	gS	3	2x 150	3NP1163	3	560	3NP1163	3	520
3NE1435-2/-3	560	690	gR	3	2x 150	3NP1163	3	555	3NP1163	3	510
3NE1436-0	630	690	gS	3	2x 185	3NP1163	3	630	3NP1163	3	585
3NE1436-2/-3	630	690	gR	3	2x 185	3NP1163	3	620	3NP1163	3	570
3NE1437-0	710	690	gS	3	2x (40x5)	--	--	--	3NP1163	3	605
3NE1437-1	710	600	gR	3	2x (40x5)	--	--	--	3NP1163	3	590
3NE1437-2/-3	710	690	gR	3	2x (40x5)	--	--	--	3NP1163	3	580
3NE1438-0	800	690	gS	3	2x (50x5)	--	--	--	3NP1163	3	630
3NE1438-1	800	600	gR	3	2x (50x5)	--	--	--	3NP1163	3	610
3NE1438-2/-3	800	690	gR	3	2x (50x5)	--	--	--	3NP1163	3	600
3NE1447-2/-3	670	690	gR	3	2x (40x5)	--	--	--	3NP1163	3	575
3NE1448-2/-3	850	690	gR	3	2x (40x8)	--	--	--	3NP1163	3	630
3NE1802-0	40	690	gS	000	10	3NP1123	000	40	3NP1123	000	40
						3NP1133	00	40	3NP1133	00	40
3NE1803-0	35	690	gS	000	6	3NP1123	000	35	3NP1123	000	35
						3NP1133	00	35	3NP1133	00	35
3NE1813-0	16	690	gS	000	1.5	3NP1123	000	16	3NP1123	000	16
						3NP1133	00	16	3NP1133	00	16
3NE1814-0	20	690	gS	000	2.5	3NP1123	000	20	3NP1123	000	20
						3NP1133	00	20	3NP1133	00	20
3NE1815-0	25	690	gS	000	4	3NP1123	000	25	3NP1123	000	25
						3NP1133	00	25	3NP1133	00	25
3NE1817-0	50	690	gS	000	10	3NP1123	000	50	3NP1123	000	50
						3NP1133	00	50	3NP1133	00	50
3NE1818-0	63	690	gS	000	16	3NP1123	000	63	3NP1123	000	63
						3NP1133	00	63	3NP1133	00	63
3NE1820-0	80	690	gS	000	25	3NP1123	000	80	3NP1123	000	80
						3NP1133	00	80	3NP1133	00	80
3NE3221	100	1000	aR	1	35	3NP1143	1	88	3NP1143	1	95
						3NP1153	2	95	3NP1153	2	100
3NE3222	125	1000	aR	1	50	3NP1143	1	102	3NP1143	1	113
						3NP1153	2	110	3NP1153	2	125
3NE3224	160	1000	aR	1	70	3NP1143	1	130	3NP1143	1	140
						3NP1153	2	140	3NP1153	2	150
3NE3225	200	1000	aR	1	95	3NP1143	1	163	3NP1143	1	170
						3NP1153	2	175	3NP1153	2	180
3NE3227	250	1000	aR	1	120	3NP1143	1	195	3NP1143	1	200
						3NP1153	2	210	3NP1153	2	215
3NE3230-0B	315	1000	aR	1	185	3NP1153	2	270	3NP1153	2	265
3NE3231	350	1000	aR	1	240	3NP1153	2	290	3NP1153	2	280
3NE3232-0B	400	1000	aR	1	240	3NP1153	2	320	3NP1153	2	310
3NE3233	450	1000	aR	1	2x 150	3NP1153	2	360	3NP1153	2	330
3NE3332-0B	400	1000	aR	2	240	3NP1153	2	330	3NP1163	3	360
						3NP1163	3	360	--	--	--
3NE3333	450	1000	aR	2	2x 150	3NP1163	3	375	3NP1163	3	390
3NE3334-0B	500	1000	aR	2	2x 150	3NP1163	3	420	3NP1163	3	415
3NE3335	560	1000	aR	2	2x 185	3NP1163	3	475	3NP1163	3	460
3NE3336	630	1000	aR	2	2x 185	3NP1163	3	540	3NP1163	3	500
3NE3337-8	710	900	aR	2	2x (40x5)	3NP1163	3	580	3NP1163	3	500
3NE3338-8	800	800	aR	2	2x 240	3NP1163	3	605	3NP1163	3	500
3NE3340-8	900	690	aR	2	2x (40x8)	3NP1163	3	630	3NP1163	3	500
3NE4101	32	1000	gR	0	6	3NP1143	1	30	3NP1143	1	32
3NE4102	40	1000	gR	0	10	3NP1143	1	35	3NP1143	1	40
3NE4117	50	1000	gR	0	10	3NP1143	1	42	3NP1143	1	50
3NE4118	63	1000	aR	0	16	3NP1143	1	55	3NP1143	1	60
3NE4120	80	1000	aR	0	25	3NP1143	1	71	3NP1143	1	76
3NE4121	100	1000	aR	0	35	3NP1143	1	84	3NP1143	1	93
3NE4122	125	1000	aR	0	50	3NP1143	1	107	3NP1143	1	115
3NE4124	160	1000	aR	0	70	3NP1143	1	134	3NP1143	1	144

7

Switch Disconnectors

3NP1 Fuse Switch Disconnectors up to 630 A

Fuses

SITOR semiconductor fuse data						Permissible load currents of fuse when installed in					
Type ¹⁾	Rated current I_n A	Rated voltage ²⁾ V AC	Operational class	Size	Required conductor cross-section Cu mm ²	3NP1 for floor mounting			3NP1 for busbar mounting		
						Type	Size	Permissible load current ³⁾ A	Type	Size	Permissible load current ^{3) 4)} A
3NE4327-0B	250	800	aR	2	150	3NP1153	2	195	3NP1163	3	220
						3NP1163	3	215	3NP1163	3	220
3NE4330-0B	315	800	aR	2	240	3NP1153	2	240	3NP1163	3	255
						3NP1163	3	270	--	--	--
3NE4333-0B	450	800	aR	2	2x (30x5)	3NP1163	3	370	3NP1163	3	355
3NE4334-0B	500	800	aR	2	2x (30x5)	3NP1163	3	410	3NP1163	3	390
3NE4337	710	800	aR	2	2x (50x5)	3NP1163	3	540	3NP1163	3	500
3NE8015-1	25	690	gR	00	4	3NP1133	00	25	3NP1133	00	25
3NE8003-1	35	690	gR	00	6	3NP1133	00	32	3NP1133	00	35
3NE8017-1	50	690	gR	00	10	3NP1133	00	43	3NP1133	00	50
3NE8018-1	63	690	gR	00	16	3NP1133	00	52	3NP1133	00	60
3NE8020-1	80	690	aR	00	25	3NP1133	00	65	3NP1133	00	72
3NE8021-1	100	690	aR	00	35	3NP1133	00	85	3NP1133	00	85
3NE8022-1	125	690	aR	00	50	3NP1133	00	100	3NP1133	00	100
3NE8024-1	160	690	aR	00	70	3NP1133	00	120	3NP1133	00	115

¹⁾ Due to the mechanical stress on the relatively long fuse blades, SITOR 3NE41 semiconductor fuses should only be switched occasionally and only at zero current.

²⁾ 3NP1 fuse switch disconnectors may be operated at up to 1000 V AC/DC with the following restrictions:
- Degree of pollution 2 (instead of 3)
- AC20 or DC20 - i.e. switching only without load

³⁾ In the case of cyclic loads, the currents may have to be further reduced (precise values on request).

⁴⁾ Values apply if used with 30 x 10 mm rails; for size 00: 12 x 5 mm and top busbar connection - values for other configurations available on request

Switch Disconnectors

3NP5 Fuse Switch Disconnectors up to 630 A

Introduction

Overview

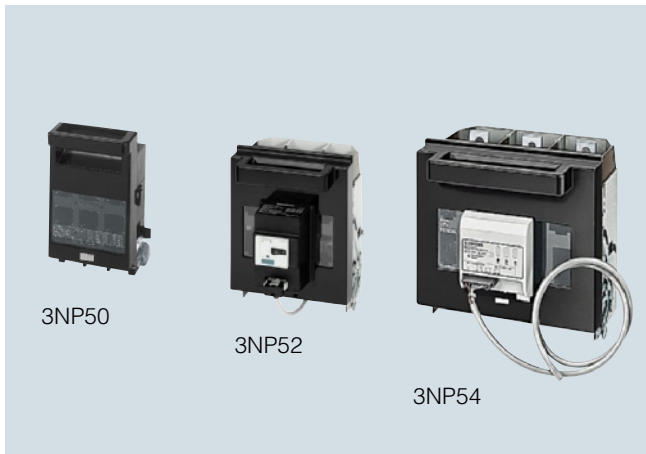

3NP5 fuse switch disconnector range

3NP5 fuse switch disconnectors are controls for the occasional manual switching/isolating of loads and distribution boards. They are able to switch on, control and switch off the specified rated current (including a specific overload).

With the 3NP5 fuse switch disconnectors, all poles of downstream electric loads can be safely disconnected from the system under load.

Application

The 3NP5 fuse switch disconnectors are ideally suited for surface mounting and installation in distribution boards (e.g. ALPHA, SIKUS), meter cabinets (e.g. ALPHA 400-ZS), and molded-plastic distribution systems such as 8HP.

The ability to mount them on a range of different busbar systems allows their very diverse implementation in switchgear cabinet and control engineering.

The 3NP5 fuse switch disconnectors are ideal for operation in combination with other switching devices, for example in capacitor modules for reactive-power compensation.

In conjunction with semiconductor protection fuses (e.g. SITOR), these are used for the effective protection of frequency converters and soft starters.

The 3NP5 fuse switch disconnectors are suitable for use in any climate and comply with standards IEC 60947-1, IEC 60947-3 and DIN VDE 0660 Part 107.

In addition, the 3NP5 series of fuse switch disconnectors complies with the requirements of BS 5419 and is also approved for operation in marine applications.

All 3NP5 fuse switch disconnectors can be sealed as standard (or can be sealed through accessories).

Switch Disconnectors

3NP5 Fuse Switch Disconnectors up to 630 A

Introduction

Technical specifications

Standards	IEC 60947-1, IEC 60947-3, VDE 0660 Part 107							
Type		3NP50	3NP52	3NP53	3NP54			
Rated uninterrupted current I_u	A	160	250	400	630			
For fuse links acc. to IEC 60269-2	Size	00	1 and 0	2 and 1	3 and 2			
Conventional free air thermal current I_{th}	A	160	250	400	630			
Rated operational voltage U_e	V	690						
• 50/60 Hz AC	V	440 (3 conducting paths series-connected), 220 (2 conducting paths series-connected, with fuse monitoring through 3RV)						
• DC	V							
Rated insulation voltage U_i	V	690 ¹⁾	690 ¹⁾	690 ¹⁾	690 ¹⁾			
Rated impulse withstand voltage U_{imp}	kV	6	6	6	6			
Rated conditional short-circuit current with fuses (by fast switch on)								
Rated current	Size/A	00/160	1/250	2/400	3/630			
• At 500 V AC (rms value)	kA	50	50	50	50			
Permissible let-through current of the fuses (peak value)	kA	15	25	40	50			
Short-circuit strength with fuses (with closed disconnector)								
• Rated current	Size/A	00/160	1/250	2/400	3/630			
• At 500 V AC (rms value)	kA	100	100	50	50			
• Maximum permissible let-through I^2t value	kA ² s	223	780	2150	5400			
• Permissible let-through current of the fuses (peak value)	kA	23	32	40	60			
Rated short-circuit making capacity with isolating blades²⁾	Size	00	1	2	3			
• At 500 V AC (peak value)	kA	6	17	17	17			
Rated making and breaking capacity²⁾ (infeed from top or bottom) ³⁾	Size	00	1	0	2	1	3	2
Breaking current I_c								
• At p.f. = 0.35, rms value	A	1300	2500	1600	4000	2500	5040	4000
• At p.f. = 0.35, rms value	A	800	1280	1000	2520	1600	3200	2520
• At p.f. = 0.35 and 400 V AC, with fuse links, rms value	A	1600	2500	1600	4000	2500	5040	4000
Rated operational current I_e								
• At AC-21B, AC-22B, AC-23B at 500 V AC, with fuse links	A	160	250	160	400	250	630	400
• At AC-21B, AC-22B, AC-23B at 690 V AC, with fuse links	A	160	250	160	400	250	630	400
• At AC-21B, AC-22B	A	160	250	160	400	250	630	400
• At AC-23B	A	100	160	125	315	200	400	315
At 220 (440) V DC, with 2 (3) conducting paths series-connected and fuse links:								
• Breaking current I_c ($L/R = 15$ ms)	A	640	1000	640	1600	1600	2520	1600
• Rated operational current I_e for DC-23B	A	160	250	160	250	250	630	400
Capacitor switching capacity								
• Capacitor rating at 400 V AC	kvar	80	90		150		250	
• Rated current I_n at 525 V AC	A	116	130		216		361	
• Capacitor rating	kvar	100	125		200		300	
• Rated current I_n	A	110	137		220		330	
Permissible ambient temperature	°C	-25 ... +55 for operation ⁴⁾ , -50 ... +80 during storage						
Mechanical endurance, operating cycles		1600						
Degree of protection		IP00, for 3NP52 with terminal clamp connection, degree of protection IP10						
• Without molded-plastic masking frame		IP30						
• With molded-plastic masking frame with closed fuse carrier on the operator side		IP10						
• With molded-plastic masking frame with open fuse carrier								
Power loss of the switch at I_{th} (without power loss of fuse links)								
Without busbar adapter	W	7.8 (16.3) ⁵⁾	7.5		15		39	
Maximum power loss of the usable fuses (per fuse)⁶⁾	W	12	23		37		50	
Main conductor connections								
Flat terminal for connection of								
• Crimped cable lugs acc. to DIN 46234 (conductor cross-section, stranded)	mm ²	2.5 ... 120	6 ... 150		6 ... 240		6 ... 2 × 240	
• Pressed cable lugs acc. to DIN 46235 (conductor cross-section, stranded)	mm ²	16 ... 70	16 ... 150		16 ... 240		16 ... 2 × 240	
• Busbars (usable busbar width)	mm	16 ... 22	22 ... 30		22 ... 30		22 ... 30	
Clamp terminals	mm ²	2.5 ... 50 ⁷⁾	35 ... 120		--		--	
Auxiliary switch 1 NO + 1 NC (accessories)		The same voltage potential must be applied to the NO and NC contacts						
• At 50 Hz/60 Hz to 400 V AC, rated operational current I_e at AC-12/AC-15 A	A	16/6						
• Flat plug-in terminals (DIN 46244)	A	A 6.3 ... 0.8						
Permissible mounting positions		Vertical or horizontal installation (switching capacity may be reduced with horizontal installation)						
Signaling contact for solid-state fuse monitoring		2 NO + 1 NC						
• Rated operational current I_e at 250 V, DC-13	A	0.27						
• Rated operational current I_e at 240 V, AC-15	A	1.5						
• Thermal free-air rated current I_{th}	A	5						

1) When observing degree of pollution 2 (instead of 3) operation is also possible up to $U_i = 1000$ V.

2) Rated making and breaking current according to IEC 60947-3:
Rated making current
 $I = 10 \times I_e$ (AC-23); $3 \times I_e$ (AC-22); $1.5 \times I_e$ (AC-21)
Rated breaking current
 $I_e = 8 \times I_e$ (AC-23); $3 \times I_e$ (AC-22); $1.5 \times I_e$ (AC-21).

3) When electronic fuse monitors are used, infeed must be from the top.

4) When using isolating blades. If using fuse links, please observe specifications of fuse manufacturer.

5) With busbar adapter.

6) Values are valid when using LV HRC fuse systems with characteristic gG. If using fuses for semiconductor protection, please refer to the assignment table, see page 7/145.

7) When connecting one conductor.
For 2 conductors max. 1×50 mm² and 1×35 mm².

Switch Disconnectors

3NP5 Fuse Switch Disconnectors up to 630 A

Floor mounting
Selection and ordering data

Rated uninterrupted current I_u A	Connection type	Size	Auxiliary switches at the switch disconnectors Version	DT	Degree of protection IP00, without fuse links, without isolating blades, with terminal screws	PU (UNIT, SET, M)	PS*/P. unit	PG	Weight per PU approx. kg
					Article No.				
Completely compartmentalized, with high speed closing feature									
 3NP5060-0CA00	Flat terminals ¹⁾	00	Without ³⁾ 1 NO + 1 NC	▶	3NP5060-0CA00	1	1 unit	103	1.610
					3NP5060-0CA10	1	1 unit	103	1.639
	Clamp terminals	00	Without ³⁾ 1 NO + 1 NC	▶	3NP5060-0CB00	1	1 unit	103	1.733
					3NP5060-0CB10	1	1 unit	103	1.761
 3NP5260-0CA00	Flat terminals	1	Without 1 NO + 1 NC	▶	3NP5260-0CA00	1	1 unit	103	5.360
					3NP5260-0CA10	1	1 unit	103	5.412
	Clamp terminals	1	Without 1 NO + 1 NC	▶	3NP5260-0CB00	1	1 unit	103	5.649
					3NP5260-0CB10	1	1 unit	103	5.601
 3NP5360-0CA00	Flat terminals	2	Without 1 NO + 1 NC	▶	3NP5360-0CA00	1	1 unit	103	6.510
					3NP5360-0CA10	1	1 unit	103	6.475
 3NP5460-0CA00	Flat terminals	3	Without 1 NO + 1 NC	▶	3NP5460-0CA00	1	1 unit	103	7.890
					3NP5460-0CA10	1	1 unit	103	7.906

¹⁾ For 3NP5060 with flat terminals, appropriate 3NY1106 cable lug covers must be used to provide a finger-safe cover, according to DIN VDE 0106 Part 100 (see [Accessories](#)).

²⁾ If auxiliary switch is retrofitted, additional drill holes are required on the switch.

Switch Disconnectors

3NP5 Fuse Switch Disconnectors up to 630 A

For 40 mm busbar system

Selection and ordering data

Rated uninter- rupted current I_u	Connection type	Size	Auxiliary switches at the switch disconnectors	DT	Degree of protection IP00, without fuse links, without isolating blades, with terminal screws	PU (UNIT, SET, M)	PS*/ P. unit	PG	Weight per PU approx.	
					Article No.	Price per PU				
A										kg
Completely compartmentalized, with high speed closing feature¹⁾										
Busbars with a width of 12 mm and thickness of 5 mm or 10 mm										
160	Flat terminals	00	Without 1 NO + 1 NC		3NP5065-1CF00	1	1 unit	103	2.306	
					3NP5065-1CF10	1	1 unit	103	2.290	
	Clamp terminals	00	Without 1 NO + 1 NC		3NP5065-1CG00	1	1 unit	103	2.351	
					3NP5065-1CG10	1	1 unit	103	2.396	

¹⁾ For accessories and more devices on busbar systems, see ["Accessories"](#)

7

Switch Disconnectors

3NP5 Fuse Switch Disconnectors up to 630 A

For 60 mm busbar system

Overview

Note:

For disconnector versions "for installation in any distribution board" and busbar adapters [see page 7/144](#).

Switch Disconnectors

3NP5 Fuse Switch Disconnectors up to 630 A

With fuse monitoring

Selection and ordering data

Fuse monitoring by circuit breakers

Floor mounting

Rated uninterrupted current I_u	Connection type	Size	Auxiliary switches		DT	Degree of protection IP00, without fuse links, without isolating blades, with terminal screws	PU (UNIT, SET, M)	PS*/P. unit	PG	Weight per PU approx.
			At switch disconnectors	At circuit breakers						
A			Version	Version		Article No.	Price per PU			kg

Completely compartmentalized, with high speed closing feature with fuse monitoring by SIRIUS circuit breakers

With plug-in connection of the auxiliary switch connecting cable (length approx. 1 m) to the circuit breakers

160	Flat terminals ¹⁾	00	1 NO + 1 NC	1 NO + 1 NC	▶	3NP5060-0EA86	1	1 unit	103	2.435
			1 NO + 1 NC	2 NO		3NP5060-0EA26	1	1 unit	103	2.459
	Clamp terminals	00	1 NO + 1 NC	1 NO + 1 NC		3NP5060-0EB86	1	1 unit	103	2.570
			1 NO + 1 NC	2 NO		3NP5060-0EB26	1	1 unit	103	2.562
250	Flat terminals	1	1 NO + 1 NC	1 NO + 1 NC	▶	3NP5260-0EA86	1	1 unit	103	5.962
			1 NO + 1 NC	2 NO		3NP5260-0EA26	1	1 unit	103	5.981
	Clamp terminals	1	1 NO + 1 NC	1 NO + 1 NC		3NP5260-0EB86	1	1 unit	103	6.202
			1 NO + 1 NC	2 NO		3NP5260-0EB26	1	1 unit	103	6.169
400	Flat terminals	2	1 NO + 1 NC	1 NO + 1 NC	▶	3NP5360-0EA86	1	1 unit	103	7.052
			1 NO + 1 NC	2 NO		3NP5360-0EA26	1	1 unit	103	7.042
630	Flat terminals	3	1 NO + 1 NC	1 NO + 1 NC	▶	3NP5460-0EA86	1	1 unit	103	8.437
			1 NO + 1 NC	2 NO		3NP5460-0EA26	1	1 unit	103	8.443



3NP5260-0EA86



3NP5360-0EA86



3NP5460-0EA86

¹⁾ For 3NP5060 with flat connectors, appropriate 3NY1106 cable lug covers must be used to provide finger-safe cover, according to DIN VDE 0106 Part 100 (see [Accessories](#)).

For 40 mm busbar system

Rated uninterrupted current I_u	Connection type	Size	Auxiliary switches		DT	Degree of protection IP00, without fuse links, without isolating blades, with terminal screws	PU (UNIT, SET, M)	PS*/P. unit	PG	Weight per PU approx.
			At switch disconnectors	At circuit breakers						
A			Version	Version		Article No.	Price per PU			kg

Completely compartmentalized, with high speed closing feature with fuse monitoring by SIRIUS circuit breakers¹⁾

Busbars with a width of 12 mm and thickness of 5 mm or 10 mm

160	Flat terminals	00	1 NO + 1 NC	1 NO + 1 NC		3NP5065-1EF86	1	1 unit	103	2.869
			1 NO + 1 NC	2 NO		3NP5065-1EF26	1	1 unit	103	2.807
	Clamp terminals	00	1 NO + 1 NC	1 NO + 1 NC		3NP5065-1EG86	1	1 unit	103	2.876
			1 NO + 1 NC	2 NO		3NP5065-1EG26	1	1 unit	103	2.974

¹⁾ For accessories and more devices on busbar systems, see [chapter 10 "Busbar systems"](#).

For 60 mm busbar system

Note:

For disconnector versions "for installation in any distribution board" and busbar adapters see [page 7/144](#).





Switch Disconnectors

3NP5 Fuse Switch Disconnectors up to 630 A

With fuse monitoring

Fuse monitoring by electronic fuse monitoring

Floor mounting

Rated uninterrupted current I_u	Connection type	Size	Auxiliary switches		DT	Degree of protection IP00, without fuse links, without isolating blades, with terminal screws	PU (UNIT, SET, M)	PS*/P. unit	PG	Weight per PU approx. kg
			At switch disconnectors	At fuse monitoring						
A			Version	Version		Article No.	Price per PU			
Completely compartmentalized, with high-speed closing feature with electronic fuse monitoring EFM (self-powered), open-circuit principle										
For rated operational voltages U_e from 400 V to 500 V AC, infeed must come from above! With plug-in connection for connecting cables from auxiliary switches (approx. 1 m long) to the fuse monitoring, status indicator: green LED illuminated, - fault indication: green LED flashing, - fuse failure: red LED (display per phase)										
160	Flat terminals ¹⁾	00	1 NO + 1 NC	2 NO + 1 NC		3NP5060-0HA13	1	1 unit	103	2.334
	Clamp terminals	00	1 NO + 1 NC	2 NO + 1 NC		3NP5060-0HB13	1	1 unit	103	2.366
3NP5060-0HA13										
250	Flat terminals	1	1 NO + 1 NC	2 NO + 1 NC		3NP5260-0HA13	1	1 unit	103	5.930
3NP5260-0HA13										
400	Flat terminals	2	1 NO + 1 NC	2 NO + 1 NC		3NP5360-0HA13	1	1 unit	103	6.937
3NP5360-0HA13										
630	Flat terminals	3	1 NO + 1 NC	2 NO + 1 NC		3NP5460-0HA13	1	1 unit	103	8.313
3NP5460-0HA13										

¹⁾ For 3NP5060 with flat terminals, appropriate 3NY1106 cable lug covers must be used to provide a finger-safe cover, according to DIN VDE 0106 Part 100 (see [Accessories](#)).

Switch Disconnectors

3NP5 Fuse Switch Disconnectors up to 630 A

With fuse monitoring

For 40 mm busbar system

Rated uninterrupted current I_u	Connection type	Size	Auxiliary switches		DT	Degree of protection IP00, without fuse links, without isolating blades, with terminal screws	PU (UNIT, SET, M)	PS*/P. unit	PG	Weight per PU approx. kg
			At switch disconnectors	At fuse monitoring						
A			Version	Version		Article No.	Price per PU			

Completely compartmentalized, with high-speed closing feature with electronic fuse monitoring EFM (self-powered), open-circuit principle

For rated operational voltages U_e from 400 V to 500 V AC, infeed must come from above!

Busbars with a width of 12 mm and thickness of 5 mm or 10 mm

160 Flat 00 1 NO + 1 NC 2 NO + 1 NC terminals



3NP5065-1HF13

3NP5065-1HF13

1 1 unit 103 2.697

For 60 mm busbar system

Note:

For disconnector versions "for installation in any distribution board" and busbar adapters [see page 7/144](#).

Switch Disconnectors

3NP5 Fuse Switch Disconnectors up to 630 A

Accessories

Selection and ordering data

Version	For fuse switch disconnectors	DT	Article No.	Price per PU	PU (UNIT, SET, M)	PS*/P. unit	PG	Weight per PU approx.
kg								
Fuse carriers								
	3NP506-.C..0		3NY1074		1	1 unit	103	0.575
	3NP5260-.C..0		3NY1371		1	1 unit	103	1.753
	3NP5360-.C..0		3NY1372		1	1 unit	103	1.912
	3NP5460-.C..0		3NY1373		1	1 unit	103	2.091
With fuse monitoring by 3RV1 MSPs (with auxiliary switch 1 NO + 1 NC), with plug-in connection, without connector and connecting cable	3NP506-.E..6		3NY1420		1	1 unit	103	1.289
	3NP5260-.E..6		3NY1421		1	1 unit	103	2.217
	3NP5360-.E..6		3NY1422		1	1 unit	103	2.272
	3NP5460-.E..6		3NY1423		1	1 unit	103	2.511
Connector and connecting cable								
1 m long	3NP5 with 3RV1		3NY1910		1	1 unit	103	0.102
3 m long			3NY1911		1	1 unit	103	0.270
With electronic fuse monitoring for 400 V ... 500 V (with auxiliary switch 2 NO + 1 NC), with plug-in connection, without connector and connecting cable	3NP50 6-.H.13		3NY1513-0		1	1 unit	103	1.026
	3NP5260-.H.13		3NY1513-2		1	1 unit	103	2.130
	3NP5360-.H.13		3NY1513-3		1	1 unit	103	2.180
	3NP5460-.H.13		3NY1513-4		1	1 unit	103	0.325
Connector and connecting cable (6-pole)								
3 m long	3NP5 with EFM		3NY1915		1	1 unit	103	0.306
Auxiliary switch 1 NO + 1 NC								
With actuating cams, screws and washers (mounting kit)	3NP50 ¹⁾		3NY3033		1	1 unit	103	0.018
With fixing bracket and screws (mounting kit)	3NP52 ... 3NP54		3NY3034		1	1 unit	103	0.008
Arc chutes								
(3 units each are required for 3NP52, 3NP53 and 3NP54)	3NP50		3NY4031		1	1 unit	103	0.221
	3NP52		3NY4011		1	1 unit	103	0.185
	3NP53, 3NP54		3NY4012		1	1 unit	103	0.242
Molded-plastic masking frames								
As replacement for masking frames from assembly kits for flush mounting (without fixing brackets and small components)	300 × 220 mm	3NY1210	3NY1102		1	1 unit	103	0.082
	300 × 245 mm	3NY1211	3NY1103		1	1 unit	103	0.083
	300 × 290 mm	3NY1212	3NY1104		1	1 unit	103	0.084

¹⁾ If retrofitted, drill holes are required.

Switch Disconnectors

3NP5 Fuse Switch Disconnectors up to 630 A

Accessories

Assembly kits for distribution systems

Version	For fuse switch disconnectors	Dimensions mm	DT	Article No.	Price per PU	PU (UNIT, SET, M)	PS*/P. unit	PG	Weight per PU approx. kg
For installation in any distribution board									
Molded-plastic masking frames									
For installation in cabinet	3NP50 with and without auxiliary switch	215 × 135		3NY1105		1	1/400 units	103	0.045
	With auxiliary switch	215 × 135		3NY1115		1	1/400 units	103	0.045
For installation in metal front panels	With and without auxiliary switch	220 × 160		3NY1125		1	1 unit	103	0.062
For covering connection terminals	3NP50 with and without auxiliary switch	265 × 135		3NY1107		1	1 unit	103	0.071
For covering cable lug connections	3NP50 with and without auxiliary switch	290 × 135		3NY1106		1	1/225 units	103	0.072
	With auxiliary switch	290 × 135		3NY1116		1	1/225 units	103	0.075
For separate covering of top and bottom cable lug connections	3NP50 with and without auxiliary switch	290 × 135		3NY1108		1	1/200 units	103	0.047
	With auxiliary switch	290 × 135		3NY1108		1	1/200 units	103	0.047
Assembly kits for flush mounting									
With molded-plastic masking frame, fixing brackets and small components. For disconnectors with and without auxiliary switches	3NP5060	250 × 149		3NY1208		1	1 unit	103	0.514
	3NP5260	300 × 220		3NY1210		1	1 unit	103	0.291
	3NP5360	300 × 245		3NY1211		1	1 unit	103	0.298
	3NP5460	300 × 290		3NY1212		1	1 unit	103	0.313
Covers for cable lug connections									
(1 set = 6 units) can be screwed onto free screw end to protect against accidental touch	3NP52	99		3NY1241		1	1 unit	103	0.208
	3NP53/3NP54	95		3TX6546-3B		1	1 unit	41B	0.256
		120		3NY1245		1	1 unit	103	0.337
Clamp terminals									
(1 set = 3 units)	3NP50	2.5 ... 50 mm ² 1)		3NY1903		1	1 unit	103	0.110
	3NP52	35 ... 120 mm ²		3NY1907		1	1 unit	103	0.223
Busbar adapters									
For 60 mm busbar system	3NP50	108		8US1291-4SB00		1	1 unit	143	0.522
	3NP52, 3NP53, 3NP54 ²⁾	250 (length 320 mm, M10 terminal screws, connecting cables must be manufactured)		8US1210-4AG00		1	1 unit	143	2.926

1) Also available in 2-wire version: 1 × 2.5 mm² ... 50 mm² and 1 × 2.5 ... 35 mm².

2) Disconnector is wider than adapter. The adapter can, however, be expanded to 276 mm with two 8US1998-2BM00 side modules

Switch Disconnectors

3NP5 Fuse Switch Disconnectors up to 630 A

Fuses

Overview

3NP5 fuse switch disconnectors are suitable for all fuses in LV HRC design, [see chapter 5](#).

SITOR semiconductor fuses in LV HRC design can also be used, although it must be noted that, compared to cable and line protection fuses, these get much hotter during operation. For this reason, the fuse must be operated below the rated current I_n of the device (derating) when installed in a closed switching device.

The following table shows the permissible load currents of the SITOR semiconductor fuses for installation in 3NP5. The values were determined using the conductor cross-sections specified in the table.

SITOR semiconductor fuses for 3NP5 fuse switch disconnectors: Assignment table

SITOR semiconductor fuse data						Permissible load currents of fuse when installed in 3NP5 for floor mounting					
Type ¹⁾	Rated current I_n A	Rated voltage ²⁾ V AC	Operational class	Size	Required conductor cross-section Cu mm ²	Type 3NP5			Alternative type 3NP5		
						Type	Size	Permissible load current ³⁾ A	Type	Size	Permissible load current ³⁾ A
3NC2423..	150	500	gR	3	70	3NP54	3	145	--	--	--
3NC2425..	200	500	gR	3	95	3NP54	3	180	--	--	--
3NC2427..	250	500	gR	3	120	3NP54	3	225	--	--	--
3NC2428..	300	500	gR	3	185	3NP54	3	255	--	--	--
3NC2431..	350	500	gR	3	240	3NP54	3	330	--	--	--
3NC2432..	400	500	aR	3	240	3NP54	3	400	--	--	--
3NC3336-1	630	1000	aR	3	2x (40x5)	3NP54	3	530	--	--	--
3NC3337-1	710	1000	aR	3	2x (50x5)	3NP54	3	570	--	--	--
3NC3338-1	800	1000	aR	3	2x (40x8)	3NP54	3	630	--	--	--
3NC3340-1	900	1000	aR	3	2x (40x8)	3NP54	3	700 ⁴⁾	--	--	--
3NC3341-1	1000	1000	aR	3	2x (50x8)	3NP54	3	770 ⁴⁾	--	--	--
3NC3342-1	1100	800	aR	3	2x (50x8)	3NP54	3	800 ⁴⁾	--	--	--
3NC3343-1	1250	800	aR	3	2x (50x8)	3NP54	3	850 ⁴⁾	--	--	--
3NC3430-1	315	1250	aR	3	2x95	3NP54	3	295	--	--	--
3NC3432-1	400	1250	aR	3	2x120	3NP54	3	355	--	--	--
3NC3434-1	500	1250	aR	3	2x150	3NP54	3	440	--	--	--
3NC3436-1	630	1250	aR	3	2x (40x5)	3NP54	3	520	--	--	--
3NC3438-1	800	1100	aR	3	2x (40x8)	3NP54	3	625	--	--	--
3NC8423..	150	660	gR	3	70	3NP54	3	135	--	--	--
3NC8425..	200	660	gR	3	95	3NP54	3	180	--	--	--
3NC8427..	250	660	gR	3	120	3NP54	3	225	--	--	--
3NC8431..	350	660	gR	3	240	3NP54	3	300	--	--	--
3NC8434..	500	660	gR	3	2x 150	3NP54	3	425	--	--	--
3NC8444-3C	1000	600	aR	3	2x (60x6)	3NP54	3	800 ⁴⁾	--	--	--
3NE1020-2	80	690	gR	00	25	3NP50	00	80	--	--	--
3NE1021-0	100	690	gS	00	35	3NP50	00	100	--	--	--
3NE1021-2	100	690	gR	00	35	3NP50	00	100	--	--	--
3NE1022-0	125	690	gS	00	50	3NP50	00	125	--	--	--
3NE1022-2	125	690	gR	00	50	3NP50	00	125	--	--	--
3NE1224-0	160	690	gS	1	70	3NP52	1	160	3NP53	2	160
3NE1224-2/-3	160	690	gR	1	70	3NP52	1	160	3NP53	2	160
3NE1225-0	200	690	gS	1	95	3NP52	1	200	3NP53	2	200
3NE1225-2	200	690	gR	1	95	3NP52	1	200	3NP53	2	200
3NE1225-3	200	690	gR	1	95	3NP52	1	190	3NP53	2	200
3NE1227-0	250	690	gS	1	120	3NP52	1	250	3NP53	2	250
3NE1227-2	250	690	gR	1	120	3NP52	1	250	3NP53	2	250
3NE1227-3	250	690	gR	1	120	3NP52	1	235	3NP53	2	250
3NE1230-0	315	690	gS	1	2x 70	3NP53	2	315	--	--	--
3NE1230-2/-3	315	690	gR	1	2x 70	3NP53	2	315	--	--	--
3NE1331-0	350	690	gS	2	2x 95	3NP53	2	350	3NP54	3	350
3NE1331-2/-3	350	690	gR	2	2x 95	3NP53	2	350	3NP54	3	350
3NE1332-0	400	690	gS	2	2x 95	3NP53	2	400	3NP54	3	400

Note

If using smaller cross-sections, a considerably higher derating is required due to the lower heat dissipation.

Switch Disconnectors

3NP5 Fuse Switch Disconnectors up to 630 A

Fuses

SITOR semiconductor fuse data						Permissible load currents of fuse when installed in 3NP5 for floor mounting					
Type ¹⁾	Rated current I_n A	Rated voltage ²⁾ V AC	Operational class	Size	Required conductor cross-section Cu mm ²	Type 3NP5			Alternative type 3NP5		
						Type	Size	Permissible load current ³⁾ A	Type	Size	Permissible load current ³⁾ A
3NE1332-2/-3	400	690	gR	2	2x 95	3NP53	2	400	3NP54	3	400
3NE1333-0	450	690	gS	2	2x 120	3NP54	3	450	--	--	--
3NE1333-2/-3	450	690	gR	2	2x 120	3NP54	3	450	--	--	--
3NE1334-0	500	690	gS	2	2x 120	3NP54	3	500	--	--	--
3NE1334-2/-3	500	690	gR	2	2x 120	3NP54	3	500	--	--	--
3NE1435-0	560	690	gS	3	2x 150	3NP54	3	560	--	--	--
3NE1435-2/-3	560	690	gR	3	2x 150	3NP54	3	560	--	--	--
3NE1436-0	630	690	gS	3	2x 185	3NP54	3	630	--	--	--
3NE1436-2/-3	630	690	gR	3	2x 185	3NP54	3	625	--	--	--
3NE1437-0	710	690	gS	3	2x (40x5)	3NP54	3	710 ⁴⁾	--	--	--
3NE1437-1	710	600	gR	3	2x (40x5)	3NP54	3	690 ⁴⁾	--	--	--
3NE1437-2/-3	710	690	gR	3	2x (40x5)	3NP54	3	685 ⁴⁾	--	--	--
3NE1438-0	800	690	gS	3	2x (50x5)	3NP54	3	800 ⁴⁾	--	--	--
3NE1438-1	800	600	gR	3	2x (50x5)	3NP54	3	750 ⁴⁾	--	--	--
3NE1438-2/-3	800	690	gR	3	2x (50x5)	3NP54	3	770 ⁴⁾	--	--	--
3NE1447-2/-3	670	690	gR	3	2x (40x5)	3NP54	3	655 ⁴⁾	--	--	--
3NE1448-2/-3	850	690	gR	3	2x (40x8)	3NP54	3	820 ⁴⁾	--	--	--
3NE1802-0	40	690	gS	000	10	3NP50	00	40	--	--	--
3NE1803-0	35	690	gS	000	6	3NP50	00	35	--	--	--
3NE1813-0	16	690	gS	000	1.5	3NP50	00	16	--	--	--
3NE1814-0	20	690	gS	000	2.5	3NP50	00	20	--	--	--
3NE1815-0	25	690	gS	000	4	3NP50	00	25	--	--	--
3NE1817-0	50	690	gS	000	10	3NP50	00	50	--	--	--
3NE1818-0	63	690	gS	000	16	3NP50	00	63	--	--	--
3NE1820-0	80	690	gS	000	25	3NP50	00	80	--	--	--
3NE3221	100	1000	aR	1	35	3NP52	1	95	3NP53	2	100
3NE3222	125	1000	aR	1	50	3NP52	1	110	3NP53	2	120
3NE3224	160	1000	aR	1	70	3NP52	1	140	3NP53	2	150
3NE3225	200	1000	aR	1	95	3NP52	1	175	3NP53	2	190
3NE3227	250	1000	aR	1	120	3NP52	1	210	3NP53	2	230
3NE3230-0B	315	1000	aR	1	185	3NP53	2	285	--	--	--
3NE3231	350	1000	aR	1	240	3NP53	2	310	--	--	--
3NE3232-0B	400	1000	aR	1	240	3NP53	2	330	--	--	--
3NE3233	450	1000	aR	1	2x 150	3NP53	2	360	--	--	--
3NE3332-0B	400	1000	aR	2	240	3NP54	3	360	--	--	--
3NE3333	450	1000	aR	2	2x 150	3NP54	3	400	--	--	--
3NE3334-0B	500	1000	aR	2	2x 150	3NP54	3	450	--	--	--
3NE3335	560	1000	aR	2	2x 185	3NP54	3	510	--	--	--
3NE3336	630	1000	aR	2	2x 185	3NP54	3	580	--	--	--
3NE3337-8	710	900	aR	2	2x (40x5)	3NP54	3	630	--	--	--
3NE3338-8	800	800	aR	2	2x 240	3NP54	3	630	--	--	--
3NE3340-8	900	690	aR	2	2x (40x8)	3NP54	3	630	--	--	--
3NE4101	32	1000	gR	0	6	3NP52	1	32	--	--	--
3NE4102	40	1000	gR	0	10	3NP52	1	40	--	--	--
3NE4117	50	1000	gR	0	10	3NP52	1	50	--	--	--
3NE4118	63	1000	aR	0	16	3NP52	1	63	--	--	--
3NE4120	80	1000	aR	0	25	3NP52	1	80	--	--	--
3NE4121	100	1000	aR	0	35	3NP52	1	95	--	--	--
3NE4122	125	1000	aR	0	50	3NP52	1	120	--	--	--
3NE4124	160	1000	aR	0	70	3NP52	1	150	--	--	--
3NE4327-0B	250	800	aR	2	150	3NP53	2	210	3NP54	3	220
3NE4330-0B	315	800	aR	2	240	3NP53	2	270	3NP54	3	285
3NE4333-0B	450	800	aR	2	2x (30x5)	3NP53	2	400	3NP54	3	420

Switch Disconnectors

3NP5 Fuse Switch Disconnectors up to 630 A

Fuses

SITOR semiconductor fuse data						Permissible load currents of fuse when installed in 3NP5 for floor mounting					
Type ¹⁾	Rated current I_n A	Rated voltage ²⁾ V AC	Operational class	Size	Required conductor cross-section Cu mm ²	Type 3NP5			Alternative type 3NP5		
						Type	Size	Permissible load current ³⁾ A	Type	Size	Permissible load current ³⁾ A
3NE4334-0B	500	800	aR	2	2x (30x5)	3NP54	3	450	--	--	--
3NE4337	710	800	aR	2	2x (50x5)	3NP54	3	600	--	--	--
3NE8015-1	25	690	gR	00	4	3NP50	00	25	--	--	--
3NE8003-1	35	690	gR	00	6	3NP50	00	33	--	--	--
3NE8017-1	50	690	gR	00	10	3NP50	00	45	--	--	--
3NE8018-1	63	690	gR	00	16	3NP50	00	54	--	--	--
3NE8020-1	80	690	aR	00	25	3NP50	00	68	--	--	--
3NE8021-1	100	690	aR	00	35	3NP50	00	89	--	--	--
3NE8022-1	125	690	aR	00	50	3NP50	00	106	--	--	--
3NE8024-1	160	690	aR	00	70	3NP50	00	130	--	--	--

- ¹⁾ Due to the mechanical stress on the relatively long fuse blades, SITOR 3NE41 semiconductor fuses should only be switched occasionally and only at zero current.
- ²⁾ 3NP1 fuse switch disconnectors may be operated at up to 1000 V AC/DC with the following restrictions:
- Degree of pollution 2 (instead of 3)
- AC20 or DC20 - i.e. switching only without load
- ³⁾ In the case of cyclic loads, the currents may have to be further reduced (precise values on request).
- ⁴⁾ The fuse can also be operated at a higher rated uninterrupted current than the 630 A current of the 3NP54. However, in this case, the 3NP54 must not be switched under load (utilization category AC-20).

7

Switch Disconnectors

3NJ4, 3NJ5 In-Line Fuse Switch Disconnectors up to 2000 A

Introduction

Overview



3NJ4/3NJ5 fuse switch disconnectors

All key product features at a glance

- Compliant with IEC/EN 60439-1, IEC/EN 60947-3
- Voltage levels up to 690 V AC
- Rated operational current from 160 A to 2000 A
- Fuse links according to IEC 60269 Part 1 can be used – nickel-plated fuse blades are not permissible due to the high transfer resistance
- In open position safe from touch by the back of the hand (exception 3NJ56: IP00)
- Parking position for maintenance
- 1-pole or 3-pole switchable
- Vertical and horizontal mounting position
- Climate-proof
- Degree of protection IP30 with closed fuse carriers, IP10 with open fuse carriers (exception 3NJ56: IP00)

Overview of all components and accessory parts: 3NJ4/3NJ5 in size 00

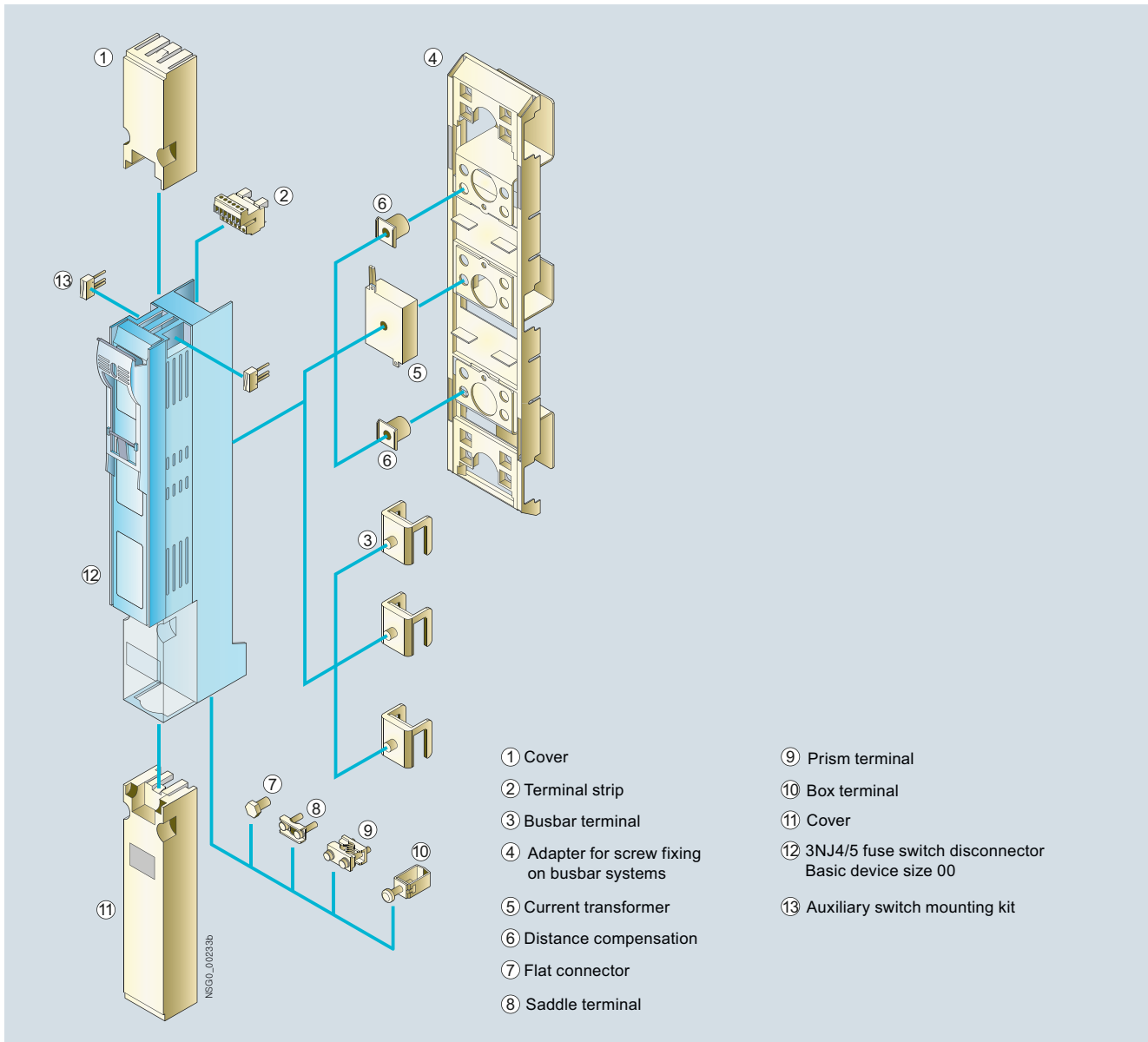

Switch Disconnectors

3NJ4, 3NJ5 In-Line Fuse Switch Disconnectors up to 2000 A

Introduction

Overview of all components and accessory parts: 3NJ4/3NJ5 in sizes 1 to 3

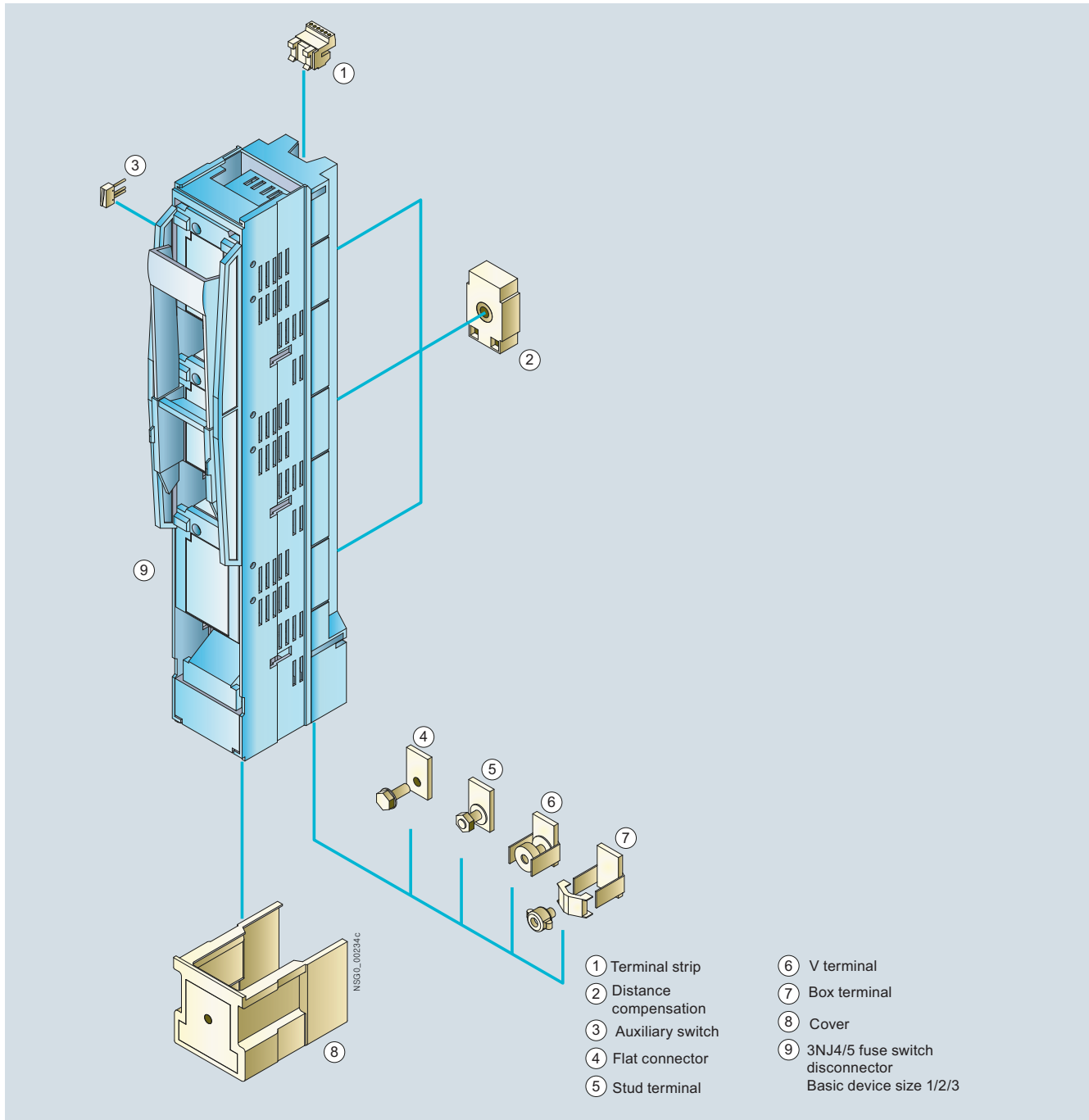

Benefits

Parking position

For maintenance e.g. the fuse carriers of the 1-pole switchable in-line fuse switch disconnectors of sizes 1 to 3 and the 3-pole switchable in-line fuse switch disconnectors of size 00 can be mounted after being turned by 180° (fuse facing outwards).

This results in the following advantages:

- Visible disconnection point
- Depot for fuse links (parking position)
- No opportunity for mistakes when replacing the fuse links
- Additional touch protection in the vicinity of the lyre-shaped contacts

Application

3NJ41 and 3NJ56 single-pole and 3-pole in-line fuse switch disconnectors can be installed in low-voltage distribution boards, substations and cable distribution cubicles.

Note:

For 1-pole switchable fuse switch disconnectors the following applies acc. to EC/EN 60947-3: *These devices are intended for power distribution systems that may require the switching and/or disconnection of individual outer conductors. They should not be used for switching the primary circuits of 3-phase equipment.*

Switch Disconnectors

3NJ4, 3NJ5 In-Line Fuse Switch Disconnectors up to 2000 A

Introduction

Technical specifications



Standards			IEC 60947-1, IEC 60947-3, VDE 0660 Part 107									
Type			3NJ410	3NJ412	3NJ413	3NJ414	3NJ56	3NJ415	3NJ418	3NJ416	3NJ417	
Conventional thermal current												
Free-air with gG fuses, I_{th}	A		160	250	400	630	1250	630	800	1260	1600	
Free-air with isolating blade, I_{th}	A		--	--	--	800	--	1000	1250	1600	2000	
Free-air with gTr fuses, I_{th}	A		--	--	--	--	1154	722	910	1154	1444	
Rated apparent power of the transformer, S_n	kVA		--	--	--	--	800	500	630	800	1000	
For fuse links and isolating blades			Size	00	1	2	3	4a	3	3	2 x 3	2 x 3
gG according to IEC 60269, I_n	A		160	250	400	630	1250	630	800	2 x 630	2 x 800	
Free-air with isolating link, I_n	A		--	--	--	--	--	1000	1250	2 x 800	2 x 1000	
gTr according to VDE 0636-2011, I_{rat}	A		--	--	--	--	1154	722	909	2 x 577	2 x 722	
gTr according to VDE 0636-2011, S_n	kVA		--	--	--	--	800	500	630	2 x 400	2 x 500	
Rated operational voltage U_e At 40 Hz ... 60 Hz AC	V		690	690	690	690	690	690	400	690	400	
Rated insulation voltage U_i	V		800	1000	1000	1000	1000	1000	690	1000	690	
Rated impulse withstand voltage U_{imp}	kV		8	12	12	12	12	12	8	12	8	
Rated conditional short-circuit current with fuses, at 500 V AC												
With gG fuse (rms value)	kA		80/120	120	120	120	80	120	50	80	50	
With gTr fuse (rms value)	kA		--	--	--	--	--	--	50	--	--	
Max. permissible power loss per fuse link	W		12	32	45	48	110	51	61	48	51	
Rated short-time withstand current I_{CW} rms value	kA		--	14.5	14.5	14.5	35	14.5	14.5	25	25	
Rated making and breaking capacity												
Rated operational current I_e for gG fuses												
At AC-21B	400 V AC	A	160	250	400	630	1250	630	800	2 x 630	2 x 800	
AC-22B	400 V AC	A	160	250	400	630	1250	630	800	2 x 630	2 x 800	
AC-23B	400 V AC	A	--	250	400	--	--	--	--	--	--	
AC-21B	500 V AC	A	160	250	400	630	1250	--	--	--	--	
AC-22B	500 V AC	A	160	250	400	630	1250	--	--	--	--	
AC-23B	500 V AC	A	--	--	--	--	--	--	--	--	--	
AC-21B	690 V AC	A	100	250	400	630	1250	--	--	--	--	
AC-22B	690 V AC	A	100	250	--	--	--	--	--	--	--	
AC-23B	690 V AC	A	--	--	--	--	--	--	--	--	--	
Rated operational current I_e for gTr fuses												
At AC-22B	400 V AC	A	--	--	--	--	--	722	910	2 x 577	2 x 722	
Rated operational current I_e for isolating blades												
At AC-22B	400 V AC	A	--	--	--	--	--	1000	1250	2 x 800	2 x 1000	
Capacitive switching capacity			kvar	--	105 ... 115	155 ... 185	250 ...300	--	--	--	--	
Permissible ambient temperature	°C		-25 ... +55, > 35 °C with derating factors									
Mechanical endurance , operating cycles			1400	1400	800	800	500	800	500	500	500	
Electrical endurance , operating cycles			200	200	200	200	100	100	100	100	100	
Degree of protection												
With closed fuse carrier, with terminal cover and peripheral cover			IP30	IP30	IP30	IP30	IP10	IP30	IP30	IP30	IP30	
With open fuse carrier			IP10	IP10	IP10	IP10	IP00	IP10	IP10	IP10	IP10	
Power loss of the main current paths at I_{th}	W		18	23	54	115	190	275	155	350	375	
Main conductor connections												
Terminal screws												
Flat bars	mm		M8	M10	M12	M12	M16	2 x M12	2 x M12	3 x M12	4 x M12	
Cable lug, max. conductor cross-section (stranded)	mm ²		20	30	30	30	80	80 x 10	80 x 10	--	--	
Tightening torque	Nm		95	240	240	240	2 x 300	2 x 300	2 x 300	3 x 300 4 x 185	4 x 300 4 x 185	
Clamp/V terminals	mm ²		12 ... 15	30 ... 35	35 ... 40	35 ... 40	50 ... 60	35 ... 40	35 ... 40	35 ... 40	35 ... 40	
Fixing screws			1.5 ... 70	25 ... 300	25 ... 300	25 ... 300	--	--	--	--	--	
Required tightening torque for mounting on busbars	Nm		M8	M12	M12	M12	M16	M12	M12	M12	M12	
			16 ... 18	35 ... 40	35 ... 40	35 ... 40	50 ... 60	35 ... 40	35 ... 40	35 ... 40	35 ... 40	

Switch Disconnectors

3NJ4, 3NJ5 In-Line Fuse Switch Disconnectors up to 2000 A

1-pole, switchable

Selection and ordering data

	Rated operating current I_e	For fuse links acc. to IEC 60269-1	Busbar center-to-center spacing	Connection type (terminal screws/ clamp-type terminals included in the scope of supply ¹⁾ , optionally top or bottom (rotatable!)	For conductor material	DT	Article No.	Price per PU	PU (UNIT, SET, M)	PS*/P. unit	PG	Weight per PU approx.
	A	Size	mm									kg
In-line fuse switch disconnectors, 1-pole switchable												
	160	00 and 000	185	M8 flat connector	Cu/Al ²⁾		3NJ4101-3BF01		1	1 unit	143	2.435
	250	1	185	M10 flat connector	Cu/Al ²⁾		3NJ4121-3BF01		1	1 unit	143	5.040
	400	2 and 1	185	M12 flat connector	Cu/Al ²⁾		3NJ4131-3BF01		1	1 unit	143	5.363
	630	3 and 2	185	M12 flat connector	Cu/Al ²⁾		3NJ4141-3BF01		1	1 unit	143	5.860
	1250	4a	185	M16 × 60 stud terminal	Cu/Al ²⁾		3NJ5643-0BB00		1	1 unit	143	21.260
In-line fuse switch disconnectors, 1-pole switchable, for integratable current transformers												
	250	1	185	M10 flat connector	Cu/Al ²⁾		3NJ4121-3BF11		1	1 unit	143	4.890
	400	2 and 1	185	M12 flat connector	Cu/Al ²⁾		3NJ4131-3BF11		1	1 unit	143	7.200
	630	3 and 2	185	M12 flat connector	Cu/Al ²⁾		3NJ4141-3BF11		1	1 unit	143	5.880

NEW

3NJ4101-3BF01

3NJ4121-3BF01

3NJ4121-3BF11



¹⁾ Fixing screws for mounting on busbars must be ordered separately.

²⁾ Cu/Al when using suitable cable lugs or terminals.

Switch Disconnectors

3NJ4, 3NJ5 In-Line Fuse Switch Disconnectors up to 2000 A

3-pole, switchable
Selection and ordering data

	Rated operating current I_e	For fuse links acc. to IEC 60269-1	Busbar center-to-center spacing	Connection type (terminal screws/ clamp-type terminals included in the scope of supply) ¹⁾ optionally top or bottom (rotatable!)	For conductor material	DT	Article No.	Price per PU	PU (UNIT, SET, M)	PS*/P. unit	PG	Weight per PU approx.
	A	Size	mm									kg
In-line fuse switch disconnectors, 3-pole switchable												
 NEW Left: 3NJ4103-3BF01 Right: 3NJ4123-3BF01	160	00 and 000	100	M8 flat connector	Cu/Al ²⁾	▶	3NJ4103-3BF02		1	1 unit	143	1.140
				F70 box terminal	Cu		3NJ4103-3BR02		1	1 unit	143	1.135
	160	00 and 000	185	M8 flat connector	Cu/Al ²⁾		3NJ4103-3BF01		1	1 unit	143	2.179
	250	1	185	M10 flat connector	Cu/Al ²⁾	▶	3NJ4123-3BF01		1	1 unit	143	5.481
				M12 stud terminal	Cu/Al ²⁾		3NJ4123-3BJ01		1	1 unit	143	5.512
				V terminal	Cu/Al ²⁾		3NJ4123-3BT01		1	1 unit	143	5.908
	400	2 and 1	185	M12 flat connector	Cu/Al ²⁾	▶	3NJ4133-3BF01		1	1 unit	143	5.540
				M12 stud terminal	Cu/Al ²⁾		3NJ4133-3BJ01		1	1 unit	143	5.406
				V terminal	Cu/Al ²⁾		3NJ4133-3BT01		1	1 unit	143	5.899
	630	3 and 2	185	M12 flat connector	Cu/Al ²⁾	▶	3NJ4143-3BF01		1	1 unit	143	6.165
			M12 stud terminal	Cu/Al ²⁾		3NJ4143-3BJ01		1	1 unit	143	6.321	
			V terminal	Cu/Al ²⁾		3NJ4143-3BT01		1	1 unit	143	6.675	
In-line fuse switch disconnectors, 3-pole switchable, with electronic fuse monitoring (EFM)												
 3NJ41.3-3CF..	160	00 and 000	100	M8 flat connector	Cu/Al ²⁾		3NJ4103-3CF02		1	1 unit	143	1.540
	250	1	185	M10 flat connector	Cu/Al ²⁾		3NJ4123-3CF01		1	1 unit	143	6.280
	400	2 and 1	185	M12 flat connector	Cu/Al ²⁾		3NJ4133-3CF01		1	1 unit	143	6.350
	630	3 and 2	185	M12 flat connector	Cu/Al ²⁾		3NJ4143-3CF01		1	1 unit	143	7.050
In-line fuse switch disconnectors, 3-pole switchable, for integratable current transformers												
	160	00 and 000	100	M8 flat connector	Cu/Al ²⁾	▶	3NJ4103-3BF12		1	1 unit	143	1.110
	250	1	185	M10 flat connector	Cu/Al ²⁾	▶	3NJ4123-3BF11		1	1 unit	143	5.192
	400	2 and 1	185	M12 flat connector	Cu/Al ²⁾	▶	3NJ4133-3BF11		1	1 unit	143	5.250
	630	3 and 2	185	M12 flat connector	Cu/Al ²⁾	▶	3NJ4143-3BF11		1	1 unit	143	6.090
In-line fuse switch disconnectors, 3-pole switchable, for integratable current transformers, with electronic fuse monitoring (EFM)												
	160	00 and 000	100	M8 flat connector	Cu/Al ²⁾		3NJ4103-3CF12		1	1 unit	143	1.500
	250	1	185	M10 flat connector	Cu/Al ²⁾		3NJ4123-3CF11		1	1 unit	143	8.500
	400	2 and 1	185	M12 flat connector	Cu/Al ²⁾		3NJ4133-3CF11		1	1 unit	143	11.500
	630	3 and 2	185	M12 flat connector	Cu/Al ²⁾		3NJ4143-3CF11		1	1 unit	143	7.090

	Transformer apparent power	Rated apparent power of the gTr fuses	Busbar center-to-center spacing	Rated current of gTr fuses	Rated operational current I_e with 3NJ4914-8BA00 isolating blade	DT	Article No.	Price per PU	PU (UNIT, SET, M)	PS*/P. unit	PG	Weight per PU approx.
	kVA	kVA	mm	A	A							kg
In-line fuse switch disconnectors, 3-pole switchable, for secondary-side fusing of transformers and incoming block												
 3NJ4163-3BF01	500	500	185	722	1000	Cu/Al ²⁾	3NJ4153-3BF01		1	1 unit	143	9.000
	630	630	185	909	1250	Cu/Al ²⁾	3NJ4183-3BF01		1	1 unit	143	12.943
	800	2 x 400	185	2 x 577	1600	Cu/Al ²⁾	3NJ4163-3BF01		1	1 unit	143	15.500
	1000	2 x 500	185	2 x 722	2000	Cu/Al ²⁾	3NJ4173-3BF01		1	1 unit	143	25.520

¹⁾ Fixing screws for mounting on busbars must be ordered separately.









²⁾ Cu/Al when using suitable cable lugs or terminals.

Switch Disconnectors

3NJ4, 3NJ5 In-Line Fuse Switch Disconnectors up to 2000 A

Accessories

Selection and ordering data

Version	For in-line fuse switch disconnectors or dimensions	DT	Article No.	Price per PU	PU (UNIT, SET, M)	PS*/P. unit	PG	Weight per PU approx. kg	
 3NJ4912-1FA01 NEW	Covers Size 00, additional touch protection when using cable lugs and as spacer • 100 mm for bottom		3NJ4101-3BF01, 3NJ4103-3BF01		3NJ4912-1FA01	1	1 unit	143	0.097
	• 132 mm for top		3NJ4101-3BF01, 3NJ4103-3BF01		3NJ4912-1FA00	1	1 unit	143	0.101
 3NJ4912-1FA00 NEW	Covers¹⁾ Size 1 to 3 Additional touch protection with use of cable lugs or connection from above		3NJ412 to 3NJ414, 3NJ415, 3NJ418		3NJ4912-1AA01	1	1 unit	143	0.160
 33NJ4912-1AA01	Covers size 3 For double in-line disconnectors		3NJ414		3NJ4912-1EA00	1	1 unit	143	0.786
 3NJ4912-1EA00	Covers Size 00 (can also be used as spacer) top and bottom to cover long cable lugs and compensate for combination of 3NJ4103 with terminals 3NJ412 to 3NJ414 (1 set = 2 units: short and long ²⁾)		3NJ4103-3BF02		3NJ4912-1DA02	1	1 unit	143	0.156
 3NJ4912-1DA02	Blanking covers For panel cutout 633 mm long		50 mm wide		3NJ4912-2AA00	1	1 unit	143	0.189
 3NJ4912-2AA00	For panel cutout 633 mm long		100 mm wide		3NJ4912-2BA00	1	1 unit	143	0.215
 3NJ4912-2BA00	For panel cutout 299 mm long		50 mm wide		3NJ4912-2CA00	1	1 unit	143	0.086
 3NJ4912-2CA00									







¹⁾ With cable lugs and connection from above, the terminal cover can be extended by connecting two units together.

²⁾ Can be shortened (in exchange for short cover, included in the scope of supply of the in-line disconnector).

Switch Disconnectors

3NJ4, 3NJ5 In-Line Fuse Switch Disconnectors up to 2000 A

Accessories

Version	For in-line fuse switch disconnectors or dimensions	DT	Article No.	Price per PU	PU (UNIT, SET, M)	PS*/P. unit	PG	Weight per PU approx. kg
 <p>Fixing clips 2 units per side, for fixing the cover of the control panel front (1 set = 4 units, including fixing accessories)</p>	3NJ41		3NJ4918-0AA00		1	1 unit	143	0.130
	3NJ4918-0AAA00							
 <p>Unequipped section covers for busbars To be fitted directly in the drilled holes of the busbars</p> <p>① Busbar center-to-center spacing 185 mm</p> <p>② Busbar center-to-center spacing 185 mm</p> <p>③ Busbar center-to-center spacing 100 mm</p> <p>Also for covering a blank space on 3NJ4918-0DA02 or 3NJ5930-3BB</p>	50 mm wide		3NJ4912-3AA00		1	1 unit	143	0.130
	100 mm wide		3NJ4912-3BA01		1	1 unit	143	0.372
	50 mm wide		3NJ4912-3CA00		1	1 unit	143	0.104
	3NJ4912-0AAA00							
 <p>Adapters for screw fixing on busbar systems</p> <ul style="list-style-type: none"> For fitting two 100 mm fuse switch disconnectors onto the busbar system with 185 mm center-to-center spacing, including adaption to sizes 1 to 3 For fitting two 185 mm fuse switch disconnectors onto the busbar system with 185 mm center-to-center spacing, including adaptation to sizes 1 to 3 For fitting two 185 mm fuse switch disconnectors onto the busbar system with 185 mm center-to-center spacing and busbar terminal, including adaptation to sizes 1 to 3 For fitting one fuse switch disconnector (= 3 separate brackets) onto a busbar system with 60 mm center-to-center spacing 	3NJ4103-3BF02, 3NJ4103-3BR02, 3NJ4103-3CF02, 3NJ4103-3BF12, 3NJ4103-3CF12		3NJ4918-0DA02		1	1 unit	143	0.745
	3NJ4103-3BF01, 3NJ4101-3BF01		3NJ5930-3BB		1	1 unit	143	0.762
	3NJ4103-3BF01, 3NJ4101-3BF01		3NJ4918-0DB02		1	1 unit	143	1.235
	3NJ4103-3BF02, 3NJ4103-3BR02, 3NJ4103-3CF02, 3NJ4103-3BF12, 3NJ4103-3CF12		3NJ4918-0EA00		1	1 unit	143	0.249
	3NJ4918-0DA02							
 <p>Fixing screws For fitting 3NJ4103 switch disconnectors with integratable current transformers onto adapters (1 set = 3 units)</p>	3NJ4103		3NJ4918-0DC02		1	1 unit	143	0.065
	3NJ4918-0EA00							
 <p>Busbar supports For 100 mm and 185 mm center-to-center spacing, for screwing on of busbars</p>	3NJ41 and 3NJ5	▶	3NJ5974-0AB		1	1 unit	143	0.463
	3NJ5974-0AB							
 <p>Grounding kit with connecting cable 25 mm²</p>	3NJ414 to 3NJ418		3NJ4910-1AA00		1	1 unit	143	2.376
	3NJ4910-1AA00							

Switch Disconnectors

3NJ4, 3NJ5 In-Line Fuse Switch Disconnectors up to 2000 A







Accessories

Version	For in-line fuse switch disconnectors or dimensions	DT	Article No.	Price per PU	PU (UNIT, SET, M)	PS*/P. unit	PG	Weight per PU approx. kg
 3NJ4911-3AA00	Busbar terminals For each fuse switch disconnector, 3 units are required Not for devices with transformer installation	3NJ4103 3NJ4101	▶ 3NJ4911-3AA00		1	1 unit	143	0.158
 3NJ4911-3BA01	For rapid mounting of the switch disconnectors onto the busbars (1 set = 3 units) Not for devices with transformer installation	3NJ412 to 3NJ414	▶ 3NJ4911-3BA01		1	1 unit	143	0.607
 3NJ4911-4AA00	Saddle terminals Connector Cu 1.5 ... 70 mm ² (1 set = 3 units)	3NJ4103	3NJ4911-4AA00		1	1 unit	143	0.042
 3NJ4911-1AA00	Prism terminal assembly kits Connector Cu 10 ... 70 mm ² (1 set = 3 units)	3NJ4103	3NJ4911-1AA00		1	1 unit	143	0.097
 3NJ4911-2BQ00	Box terminal assembly kits Al/Cu terminal 95 ... 240 mm ² (for connection to version with flat connector) (1 set = 3 units)	3NJ412 to 3NJ414	3NJ4911-2BQ00		1	1 unit	143	0.959
 3NJ4911-5AA00	Busbar connection assembly kits for NH 1, 2, 3 With flat connector 2 x 240 mm ² With M12 screws	3NJ412 to 3NJ414	3NJ4911-5AA00		1	1 unit	143	0.246
 3NJ4911-5BA00	2 x 300 mm ² / 3x 120 mm ² With M12 screws	3NJ412 to 3NJ414	3NJ4911-5BA00		1	1 unit	143	1.873
 3NJ4911-5CA00	1 x 400 mm ² With M16 screws	3NJ412 to 3NJ414	3NJ4911-5CA00		1	1 unit	143	1.906

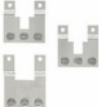
Switch Disconnectors

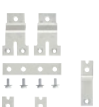
3NJ4, 3NJ5 In-Line Fuse Switch Disconnectors up to 2000 A



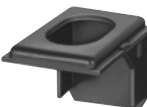
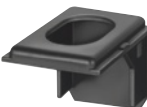



Accessories

Version	For in-line fuse switch disconnectors or dimensions	DT	Article No.	Price per PU	PU (UNIT, SET, M)	PS*/P. unit	PG	Weight per PU approx. kg
 <p>3NJ4911-6AA00</p>	<p>Busbar connection assembly kits for NH 3 as double in-line disconnectors 3 x 300 mm² / 4 x 185 mm²</p>	3NJ413, 3NJ414	3NJ4911-6AA00		1	1 unit	143	2.790
 <p>3NJ4911-6BA00</p>	<p>Mechanical coupling of operating handles, required in addition for coupling two switch disconnectors</p>	3NJ413, 3NJ414	3NJ4911-6CA00		1	1 unit	143	0.066
 <p>3NJ4911-6BA00</p>	<p>Busbar connection assembly kits for NH 3 as double in-line disconnectors 4 x 240 mm²</p>	3NJ413, 3NJ414	3NJ4911-6BA00		1	1 unit	143	4.103
 <p>3NJ4911-6BA00</p>	<p>Mechanical coupling of operating handles, required in addition for coupling two switch disconnectors</p>	3NJ413, 3NJ414	3NJ4911-6CA00		1	1 unit	143	0.066
 <p>3NJ4913-6AA02</p>	<p>Auxiliary switch mounting kit For sizes 00 to 3 with connecting cables, 1 CO contact, for 3-pole switchable switch disconnectors only</p>	3NJ41	3NJ4913-1AA01		1	1 unit	143	0.025
 <p>3NJ4914-8BA00</p>	<p>Fuse 630 kVA 909 A Size NH 3 Specially for the protection of transformers (minimum order quantity 3 units)</p>	3NJ418	3NJ4914-8AA00		1	1 unit	143	1.341
 <p>3NJ4918-1AA00</p>	<p>Isolating blades Size NH 3, 1250 A</p>		3NJ4914-8BA00		1	1 unit	143	0.903
 <p>3NJ4918-1AA00</p>	<p>Mounting hooks (one per in-line disconnector required)</p>		3NJ4918-1AA00		1	1 unit	143	0.122

Switch Disconnectors

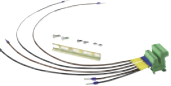
3NJ4, 3NJ5 In-Line Fuse Switch Disconnectors up to 2000 A



Accessories

Version	For in-line fuse switch disconnectors or dimensions	DT	Article No.	Price per PU	PU (UNIT, SET, M)	PS*/P. unit	PG	Weight per PU approx. kg
 3NJ4915-1BA00	Distance compensation For fuse switch disconnectors, with integratable current transformers if no current transformer is built in.	3NJ4103 ▶ 3NJ412 to 3NJ414 ▶	3NJ4915-1BA00		1	1 unit	143	0.022
			3NJ4915-2BA00		1	1 unit	143	0.095
 3NJ4915-2BA00	Terminal strips	3NJ4103 ▶ 3NJ412 to 3NJ414 ▶	3NJ4915-1CA00		1	1 unit	143	0.093
			3NJ4915-2CA00		1	1 unit	143	0.115
 3NJ4915-1CA00	Current transformers .../1 A	3NJ4103 ▶ 3NJ412 to 3NJ414 ▶	100/1 A, Cl. 0.5, 1.5 VA	3NJ4915-1EA10	1	1 unit	143	0.252
			100/1 A, Cl. 1, 2.0 VA	3NJ4915-1EA20	1	1 unit	143	0.249
 3NJ4915-1FB20	150/1 A, Cl. 0.5, 2.5 VA 150/1 A, Cl. 0.5 calibrated, 2.5 VA 150/1 A, Cl. 1, 3.0 VA	3NJ4103 ▶ 3NJ4103 3NJ4103	150/1 A, Cl. 0.5, 2.5 VA	3NJ4915-1FA10	1	1 unit	143	0.250
			150/1 A, Cl. 0.5 calibrated, 2.5 VA	3NJ4915-1FA11	1	1 unit	143	0.250
 3NJ4915-2CA00	150/1 A, Cl. 1, 3.0 VA 75/1 A, Cl. 1, 1.5 VA	3NJ4103 3NJ412 to 3NJ414 ▶	150/1 A, Cl. 1, 3.0 VA	3NJ4915-1FA20	1	1 unit	143	0.251
			75/1 A, Cl. 1, 1.5 VA	3NJ4915-2DA20	1	1 unit	143	0.216
 3NJ4915-1FB20	100/1 A, Cl. 0.5, 1.5 VA 100/1 A, Cl. 1, 2.0 VA	3NJ412 to 3NJ414 3NJ412 to 3NJ414	100/1 A, Cl. 0.5, 1.5 VA	3NJ4915-2EA10	1	1 unit	143	0.217
			100/1 A, Cl. 1, 2.0 VA	3NJ4915-2EA20	1	1 unit	143	0.204
 3NJ4915-2HA20	150/1 A, Cl. 0.5, 2.5 VA 150/1 A, Cl. 1, 2.5 VA	3NJ412 to 3NJ414 3NJ412 to 3NJ414	150/1 A, Cl. 0.5, 2.5 VA	3NJ4915-2FA10	1	1 unit	143	0.206
			150/1 A, Cl. 1, 2.5 VA	3NJ4915-2FA20	1	1 unit	143	0.223
 3NJ4915-2HA20	250/1 A, Cl. 0.5, 2.5 VA 250/1 A, Cl. 0.5 calibrated, 2.5 VA 250/1 A, Cl. 1, 5.0 VA	3NJ412 to 3NJ414 ▶ 3NJ412 to 3NJ414 3NJ412 to 3NJ414	250/1 A, Cl. 0.5, 2.5 VA	3NJ4915-2GA10	1	1 unit	143	0.220
			250/1 A, Cl. 0.5 calibrated, 2.5 VA	3NJ4915-2GA11	1	1 unit	143	0.207
 3NJ4915-2HA20	250/1 A, Cl. 1, 5.0 VA 400/1 A, Cl. 0.5, 2.5 VA 400/1 A, Cl. 0.5 calibrated, 2.5 VA	3NJ412 to 3NJ414 ▶ 3NJ412 to 3NJ414 3NJ412 to 3NJ414	250/1 A, Cl. 1, 5.0 VA	3NJ4915-2GA20	1	1 unit	143	0.223
			400/1 A, Cl. 0.5, 2.5 VA	3NJ4915-2HA10	1	1 unit	143	0.196
 3NJ4915-2HA20	400/1 A, Cl. 0.5 calibrated, 2.5 VA 400/1 A, Cl. 1, 5.0 VA	3NJ412 to 3NJ414 ▶ 3NJ412 to 3NJ414	400/1 A, Cl. 0.5 calibrated, 2.5 VA	3NJ4915-2HA11	1	1 unit	143	0.202
			400/1 A, Cl. 1, 5.0 VA	3NJ4915-2HA20	1	1 unit	143	0.209
 3NJ4915-2JA20	500/1 A, Cl. 0.5, 2.5 VA 500/1 A, Cl. 1, 5.0 VA	3NJ412 to 3NJ414 ▶ 3NJ412 to 3NJ414	500/1 A, Cl. 0.5, 2.5 VA	3NJ4915-2JA10	1	1 unit	143	0.190
			500/1 A, Cl. 1, 5.0 VA	3NJ4915-2JA20	1	1 unit	143	0.198
 3NJ4915-2KA20	600/1 A, Cl. 0.5, 2.5 VA 600/1 A, Cl. 0.5 calibrated, 2.5 VA 600/1 A, Cl. 1, 5.0 VA	3NJ412 to 3NJ414 ▶ 3NJ412 to 3NJ414 3NJ412 to 3NJ414	600/1 A, Cl. 0.5, 2.5 VA	3NJ4915-2KA10	1	1 unit	143	0.195
			600/1 A, Cl. 0.5 calibrated, 2.5 VA	3NJ4915-2KA11	1	1 unit	143	0.218
 3NJ4915-2KA20	600/1 A, Cl. 1, 5.0 VA	3NJ412 to 3NJ414 ▶	600/1 A, Cl. 1, 5.0 VA	3NJ4915-2KA20	1	1 unit	143	0.198

Switch Disconnectors

3NJ4, 3NJ5 In-Line Fuse Switch Disconnectors up to 2000 A

Accessories

Version	For in-line fuse switch disconnectors or dimensions	DT	Article No.	Price per PU	PU (UNIT, SET, M)	PS*/P. unit	PG	Weight per PU approx. kg
Current transformers .../5 A								
 3NJ4915-1FB20	100/5 A, Cl. 0.5, 1.0 VA		3NJ4103		1	1 unit	143	0.240
	100/5 A, Cl. 1, 1.5 VA		3NJ4103		1	1 unit	143	0.247
	150/5 A, Cl. 0.5, 1.5 VA		3NJ4103		1	1 unit	143	0.233
	150/5 A, Cl. 0.5 calibrated, 1.5 VA		3NJ4103		1	1 unit	143	0.248
	150/5 A, Cl. 1, 2.5 VA		3NJ4103	▶	1	1 unit	143	0.248
	75/5 A, Cl. 1, 1.5 VA		3NJ412 to 3NJ414		1	1 unit	143	0.209
	100/5 A, Cl. 0.5, 1.0 VA		3NJ412 to 3NJ414		1	1 unit	143	0.208
	100/5 A, Cl. 1, 2.0 VA		3NJ412 to 3NJ414		1	1 unit	143	0.208
	150/5 A, Cl. 0.5, 1.5 VA		3NJ412 to 3NJ414		1	1 unit	143	0.199
	150/5 A, Cl. 1, 2.5 VA		3NJ412 to 3NJ414		1	1 unit	143	0.187
 3NJ4915-2HB20	250/5 A, Cl. 0.5, 2.5 VA		3NJ412 to 3NJ414		1	1 unit	143	0.203
	250/5 A, Cl. 0.5 calibrated, 2.5 VA		3NJ412 to 3NJ414		1	1 unit	143	0.203
	250/5 A, Cl. 1, 3.75 VA		3NJ412 to 3NJ414	▶	1	1 unit	143	0.202
	400/5 A, Cl. 0.5, 2.5 VA		3NJ412 to 3NJ414		1	1 unit	143	0.197
	400/5 A, Cl. 0.5 calibrated, 2.5 VA		3NJ412 to 3NJ414		1	1 unit	143	0.193
	400/5 A, Cl. 1, 5.0 VA		3NJ412 to 3NJ414	▶	1	1 unit	143	0.195
	500/5 A, Cl. 0.5, 2.5 VA		3NJ412 to 3NJ414		1	1 unit	143	0.197
	500/5 A, Cl. 1, 5.0 VA		3NJ412 to 3NJ414		1	1 unit	143	0.197
	600/5 A, Cl. 0.5, 2.5 VA		3NJ412 to 3NJ414		1	1 unit	143	0.201
	600/5 A, Cl. 0.5 calibrated, 2.5 VA		3NJ412 to 3NJ414		1	1 unit	143	0.209
600/5 A, Cl. 1, 5.0 VA		3NJ412 to 3NJ413NJ424	▶	1	1 unit	143	0.198	