

# Busbar Systems



10/2	<b>Introduction</b>
10/3	<b>General data</b>
<b>8US 40 mm busbar systems</b>	
10/7	Introduction
10/8	Basic assemblies up to 400 A
<b>8US 60 mm busbar systems</b>	
10/9	Introduction
10/10	Basic assemblies up to 630 A
10/14	Basic assemblies up to 1 600 A
10/15	Infeed and connection methods from 630 A to 1 600 A
10/18	Busbar device adapters and device holders from 630 A to 1 600 A
10/25	Connection of 3NP1 fuse switch disconnectors
10/26	UL applications
10/29	Accessories
10/31	<b>Distribution board components</b>
10/33	<b>Built-in components</b>

## For further technical product information:

[Configuration Manual](#)

8US Busbar Systems 2014  
Article No.: 3ZW1012-8US10-0AC1

[Service & Support Portal](#)







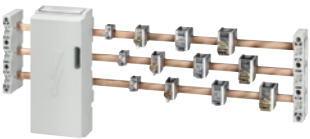
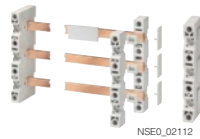

[www.siemens.com/lowvoltage/product-support](http://www.siemens.com/lowvoltage/product-support)

→ Product List:  
Technical specifications

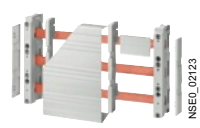
→ Entry List:  
Certificates / Characteristics /  
Download / FAQ / Manuals /  
Updates

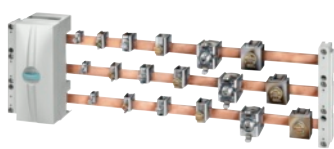
## Introduction

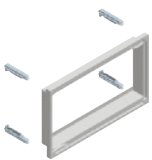
### Overview

Devices	Page	Application	Standards	Used in			
				Non-residential buildings	Residential buildings	Industry	
	<b>8US 40 mm busbar systems</b>	10/7	Basic assemblies up to 400 A, busbar supports, busbars, covers for the touch protection	EN 13601 IEC 60439-1, IEC 61439-2	✓	--	✓
	Basic assemblies up to 400 A	10/8	Basic assemblies up to 400 A, busbar supports, busbars, covers for the touch protection	EN 13601 IEC 60439-1, IEC 61439-2	✓	--	✓
	<b>8US 60 mm busbar systems</b>	10/9	Basic assemblies up to 630 A, overview with different devices	EN 13601 IEC 60439-1, IEC 61439-2 UL 508 A	✓	--	✓
	Basic assemblies up to 630 A	10/10	Basic assemblies up to 630 A, busbar supports, busbars, covers for the touch protection	EN 13601 IEC 60439-1, IEC 61439-2 UL 508 A	✓	--	✓
	Basic assemblies up to 1 600 A	10/14	Basic assemblies up to 1 600 A, busbar supports, busbars, covers for the touch protection	EN 13601 IEC 60439-1, IEC 61439-2 UL 508 A	✓	--	✓
	Infeed and connection methods from 630 A to 1 600 A	10/15	Infeed for busbar systems, terminals...	EN 13601 IEC 60439-1, IEC 61439-2 UL 508 A	✓	--	✓
	Busbar device adapters and device holders from 630 A to 1 600 A	10/18	Busbar device adapters and device holders for the assembly of load feeders 3RV2/3RT2	EN 13601 IEC 60439-1, IEC 61439-2 UL 508 A	✓	--	✓
	<b>Distribution board components</b>	10/31	Longitudinal stays, assembly kits, covers for the touch protection	IEC 60439-1, IEC 61439-3 VDE 0603-1	✓	--	✓
	<b>Built-in components</b>	10/33	3-pole NEOZED bus-mounting bases or DIAZED bus-mounting bases, NEOZED bus-mounting switch disconnectors, fuse switch disconnectors and busbar device adapters	IEC 60947-3, EN 60947-3 (VDE 0660) IEC 60269, EN 60269 (VDE 0636)	✓	--	✓

## Overview

The use of busbar systems with their versatile rail-adaptable connection, switching and installation devices is an ideal and cost-effective electrotechnical enhancement of modern distribu-

tion boards due to their small footprint, compact design and quick assembly contacts. Mounting is implemented on longitudinal stays. The busbar spacing is 60 mm.

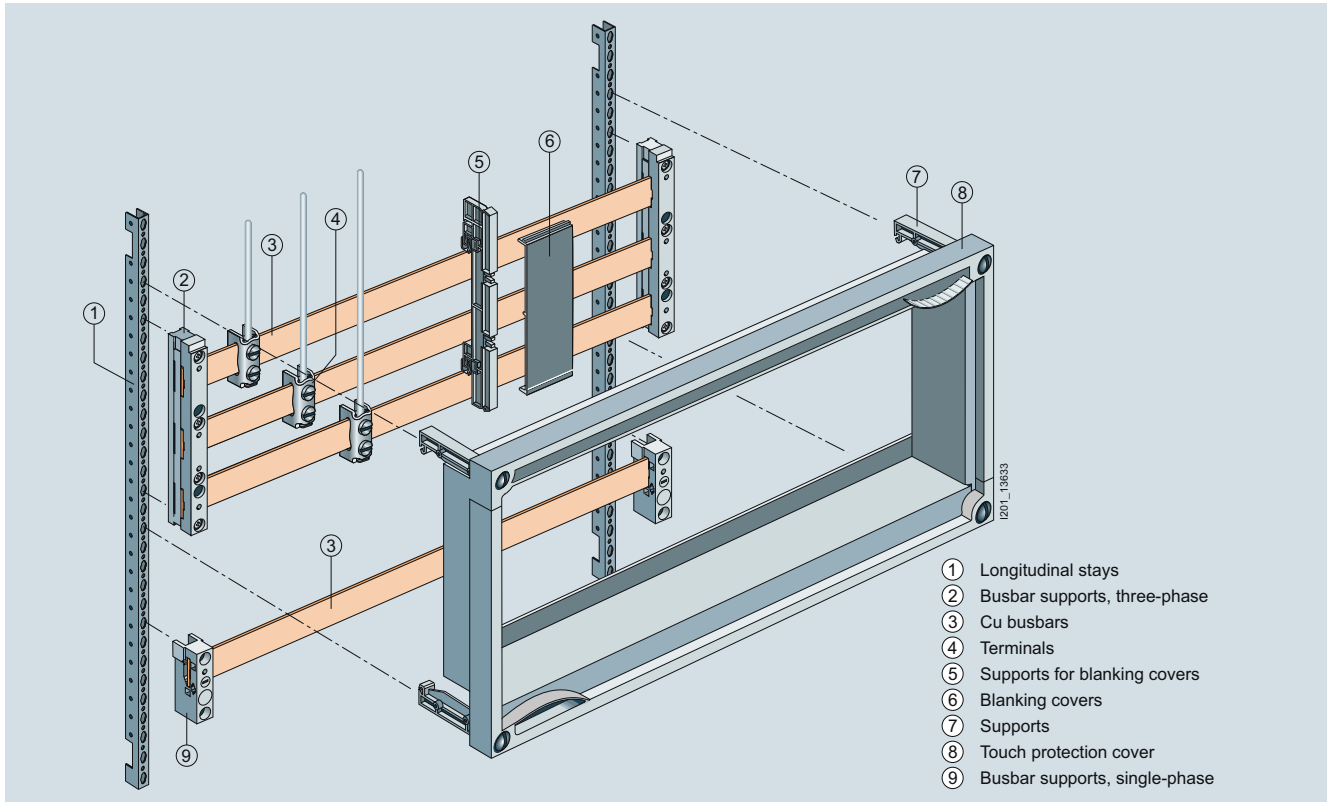

## Benefits

Notable cost reduction compared to conventional installation in switchgear and control cabinets due to the following reasons:

- Mechanical fixing and electrical contacting in a single step
- No access wiring and fewer busbar terminals used
- Double use of the busbar space
- Clear arrangement
- Straightforward replacement of individual devices or whole combinations
- High operational safety through finger-safe cover of the adapters and device holders

All the above advantages are felt especially in cases where many tap-off units of the same performance range are required.

## Application

8US busbar systems are used for the direct busbar-mounting of current-limiting devices (protective devices) such as fuse switch disconnectors and circuit breakers as well as complete load feeders.

8US busbar systems are designed for horizontal mounting of the busbars.

## Design

8US busbar systems with 60 mm busbar center-to-center spacing as well as flat copper profiles have become firmly established on the world market.

The permissible busbar temperature is decisive when dimensioning the busbars. The busbar temperature is dependent on the current and the current distribution, on the busbar cross-section and the busbar surface, on the position of the busbars, convection and the ambient temperature. The values stated in the following table can only be considered as guide values because the conditions vary with each location. The values are based on continuous current over the whole busbar length.

The busbar runs prove most advantageous when the infeed is centrally located and the load is distributed symmetrically on both sides.

## Function

### Short-circuit strength

The short-circuit strength of the busbar system is dependent on the distance of the busbar supports and on the busbar cross-section.

The short-circuit strength of the whole system is dependent on the short-circuit strength of the busbars and of the adapters with circuit breakers or switch disconnectors. If one of these values is lower than the prospective short-circuit current at the installation site, a current-limiting protective device has to be mounted upstream of the 8US busbar system. This may also be mounted as a feeder circuit breaker on the busbar system itself.

## General data

### Technical specifications

#### Continuous current for busbars, E-Cu bare, at 35 °C ambient temperature according to DIN 43671

Bar dimensions mm	System mm	Continuous current at a busbar temperature of		
		65 °C A	85 °C A	105 °C A
12 × 5	40 + 60	188	248	295
15 × 5	40 + 60	222	293	349
20 × 5	60	274	362	430
25 × 5	60	327	432	513
30 × 5	60	379	500	595
12 × 10	40 + 60	302	398	474
20 × 10	60	427	564	670
30 × 10	60	573	756	900
Special profile up to 1 600 A	60	1 020	1 020	1 600

#### General technical specifications

<b>Rated insulation voltage <math>U_i</math></b>	V AC	<b>1 000</b>
<b>Short-circuit strength</b> of 8US1 busbar device adapter		Current limitation due to associated motor starter protectors/circuit breakers/load feeders up to 50 kA
of the busbar systems		<a href="#">see Characteristic Curves</a>
<b>Material of the 8US1 busbar supports, busbar device adapters and device holders</b>		Glass-fiber reinforced polyamide
<b>Color</b>		RAL 7035, light gray
<b>Thermal stability (minimum values)</b>		
Busbar supports, busbar device adapters, device holders, infeed and caps	°C	120
AWG connecting cables	°C	105 / 150
Cover profiles	°C	110
Bases, partitions, edge profiles and blanking covers	°C	70
<b>Machining of plastic profiles</b>		Take care when machining that no cracks are formed. A cross-cut circular saw with the following characteristic values has proven successful in cutting cover profiles for busbars: <ul style="list-style-type: none"> <li>• D = 300 mm, B = 2.2 mm,</li> <li>• T = 120 R (5° negative replaceable tooth at a cutting rate of 50 ... 60 m/s)</li> <li>• Tooth feed 0.05 ... 0.1 mm</li> </ul> The plastic parts are secured so that vibration is ruled out.
<b>Approvals</b> Busbar supports, busbar device adapters, device holders and terminals		UR, CSA, c <sub>UL</sub> us- Listed

#### Technical specifications of the system components

Infeed, connection modules, three-phase		5SH3538	5SH3535	8US1921-1BA00	8US1921-1AA00
<b>Busbar center-to-center spacing</b>	mm	60	60	60	60
<b>Current carrying capacity of the terminal points</b> The specified current carrying capacities reflect the thermal load capability of the terminal points under favorable conditions (with the largest conductors it is possible to connect). This does not invalidate the assignment of conductor cross-sections and current carrying capacities as defined in national and international specifications.	A	80	560	300	440
<b>Tightening torque</b>	Nm	--	30	8 ... 10	12 ... 15
<b>Clamping space W × H</b>	mm	--	--	10 × 15	15 × 15
<b>Conductors that can be used</b>	mm <sup>2</sup>	1.5 ... 16 Cu, re, rm, f, f+AE (reduction of the maximum conductor cross-sections may be required)	150 ... 300 Cu, Al (connections with aluminum conductors are not maintenance free), rm, sm, f	6 ... 50 (70) Cu, rm, f, f+AE (reduction of the maximum conductor cross-sections may be required), la. Cu 6 × 9 × 0.8	35 ... 120 Cu, rm, f, f+AE (reduction of the maximum conductor cross-sections may be required), la. Cu 6/10 × 15.5 × 0.8

## Characteristic curves

### Characteristic curves as a function of rated peak withstand current

#### 40 mm busbar systems

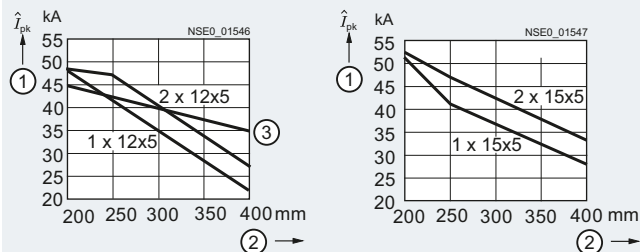

- ① Surge current  $I_{pk}$
- ② Spacing of busbar supports
- ③ 5-pole busbar supports

#### 60 mm busbar systems

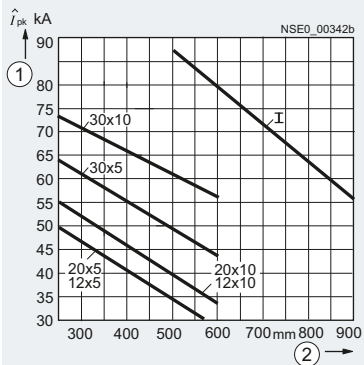

- ① Surge current  $I_{pk}$
- ② Spacing of busbar supports

#### 100 mm busbar systems

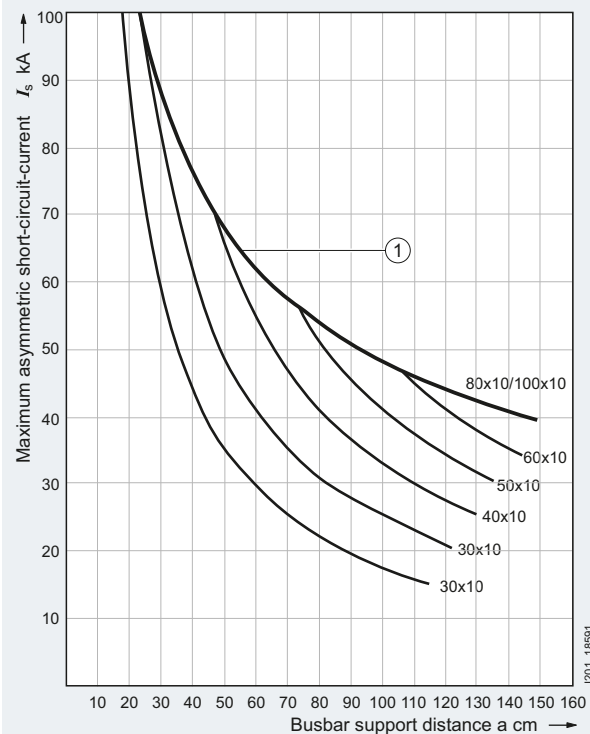

- ① Maximum lead on busbar system

#### 185 mm busbar systems

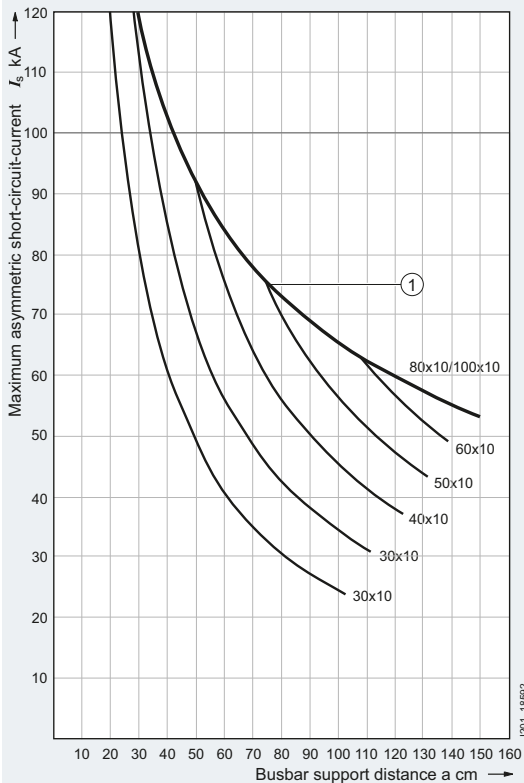

- ① Maximum lead on busbar system

# Busbar Systems

## General data

### Current-carrying capacity values for flat bars acc. to DIN 43671

According to DIN 43671, current-carrying capacity values for flat bars are defined as 35 °C ambient temperature and 65 °C busbar temperature.

If a higher bar temperature than 65 °C is possible, the busbars can be operated with higher current values according to the following formula:  $I = I_n \cdot k_2$

#### Example

Under normal operating conditions (35 °C ambient temperature and 65 °C bar temperature), a 30 x10 mm busbar can handle loads up to 630 A. However, you want the busbar to handle a higher current, at the expense of an increased busbar temperature of max. 85 °C.

The following applies:

- Bar type: Busbar
- Busbar size: 30 x 10
- Max. bar temperature: 85 °C
- Ambient temperature: 35 °C

The figure on the right shows the correction factor  $k_2 = 1.3$  for the current-carrying capacity.

This results in a higher value of  $630 \text{ A} \cdot 1.3 = 819 \text{ A}$ .

If the 30 x10 busbar is to be operated with a bar temperature of 85 °C, it may be loaded with maximum 819 A.

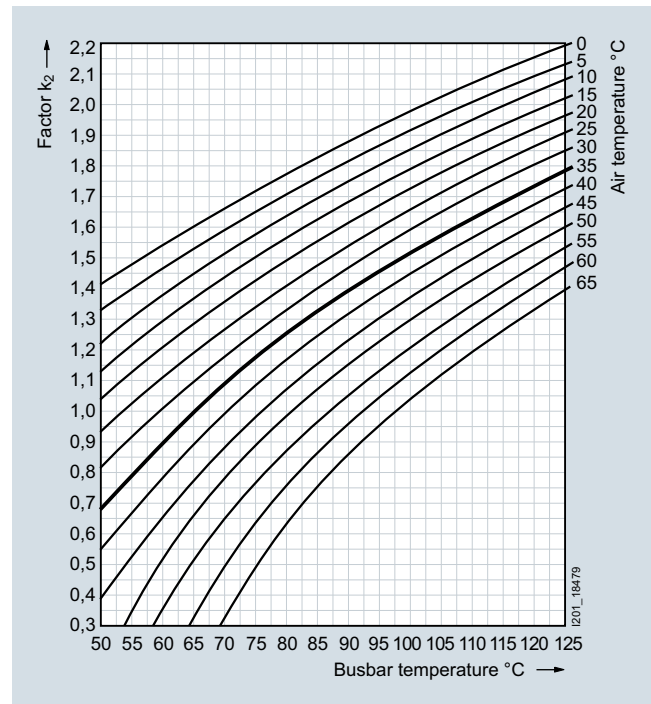

Current-carrying capacity values for 30 x 10 mm flat bars acc. to DIN 43671, depending on ambient and bar temperature

### Overview



The 40 mm busbar system for the lower performance range up to 400 A: Terminals and covers for infeed and connection methods

The 40 mm busbar system is used in machine engineering and distribution boards, in meter cabinets and in power distribution systems of the low performance range up to 400 A.

The busbar cross-sections are adapted to the rated currents and are available in the sizes 12 x 5 mm, 12 x 10 mm, 15 x 5 mm and 15 x 10 mm. The basic system is configured without covers. If touch protection is required, this is possible with busbar covers.

Terminals round off the product range of the 40 mm busbar system.

# Busbar Systems

## 8US 40 mm Busbar Systems



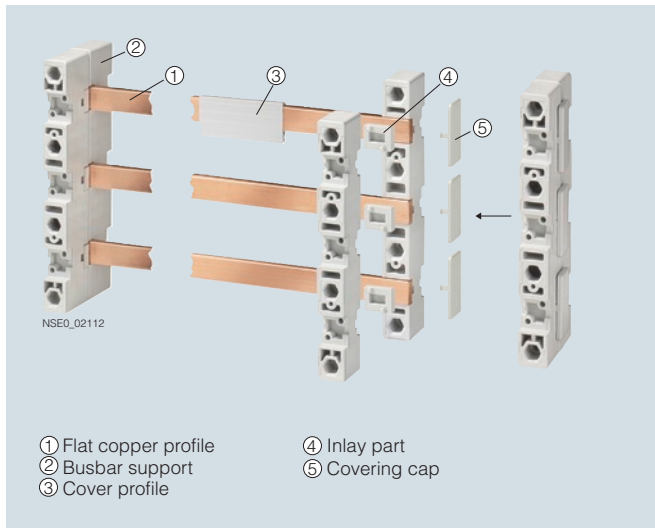

### Basic assemblies up to 400 A

#### Overview



40 mm busbar system: Basic assembly up to 400 A

#### Selection and ordering data

	Description	DT	Article No.	Price per PU	PU (UNIT, SET, M)	PS*/P. unit	PG	Weight per PU approx. kg
 8US1903-3AB00	<b>②④⑤ Busbar supports</b> <b>End and intermediate holders for flat copper profiles</b> 12 mm x 5 mm, 12 mm x 10 mm, 15 mm x 5 mm, 15 mm x 10 mm 3-pole, with inside fixing (PU = 2 busbar supports including inlay parts for bar thickness 5 mm and lateral finger-safe covers)		<b>8US1903-3AB00</b>		1	1 unit	143	0.186
	 8US1903-5AA00	5-pole, 12 mm x 5 mm and 12 mm x 10 mm with inside fixing	L1-L3 + N + PE/N	<b>8US1903-5AA00</b>		1	1 unit	143
 8WC5	<b>① Flat copper profiles</b> <b>(flat profile, approx. 2.4 m long, bare, according to EN 12167)</b> 12 mm x 5 mm 15 mm x 5 mm		<b>8WC5123</b> <b>8WC5121</b>		1 1	1 unit 1 unit	143 143	1.100 1.550
	 8US1922-2CA00	<b>③ Cover profiles for busbars</b> 12 mm x 5 mm      1000 mm long 15 mm x 5 mm      1000 mm long		<b>8US1922-2CA00</b> <b>8US1922-2AA00</b>		1 1	10 units 10 units	143 143

### Overview



The 60 mm busbar system for the medium and top performance range up to 1 600 A, here for example with the 3NP1 switch disconnector, size 3

The 60 mm busbar system is used preferably in control cabinet installation, in motor control centers and in power distribution systems of the medium power range (630 A) and top performance range (1 600 A, special profile).

The 60 mm busbar system can be configured as a basic system without covers. The busbar cross-sections are available in the sizes 12 x 5 mm to 30 x 10 mm and as a special profile.

Busbar adapters for SIRIUS, 3VL circuit breakers, 3KA and 3KL switch disconnectors, and 3NP1 and 3NP5 fuse switch disconnectors offer numerous options for configuring this busbar system. Infeed units, terminals and other accessories open up a large range of applications.

Busbars with a special profile are suitable for applications up to 1 600 A. All components of the 60 mm busbar system can be fitted.

### **SIRIUS motor starter combinations**

SIRIUS motor starter combinations can be configured with and without fuses.

The compact 3NW7...-1 cylindrical fuse holders for IEC fuses, size 10x38 mm, or 3NW7...-1HG UL for Class CC fuses are suitable for use with fused motor starter combinations.

With a width of 45 mm, SIRIUS motor starter combinations are the same width as the majority of contactors.

For further information and accessories, [see chapter 5, "Fuse Systems" → Cylindrical fuse systems](#)  
 → Fuse holders in size 10x38 mm and Class CC.



Installation configuration of a cylindrical fuse holder and a SIRIUS contactor on busbar device adapter for the 60 mm busbar system

# Busbar Systems

## 8US 60 mm Busbar Systems

### Basic assemblies up to 630 A

#### Overview

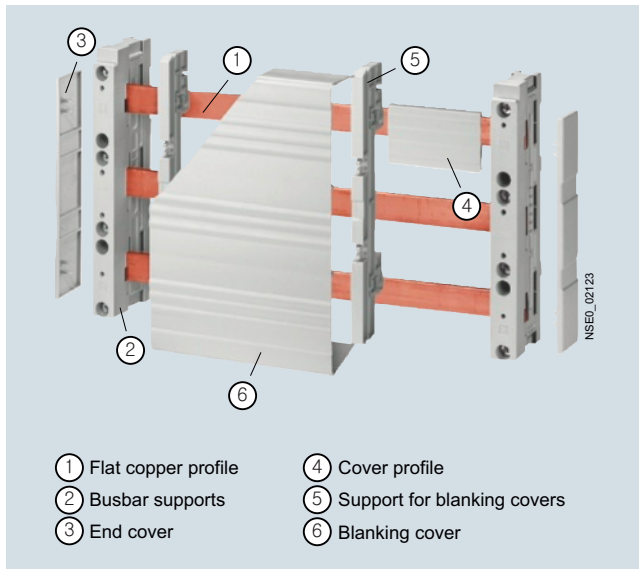

- |                       |                               |
|-----------------------|-------------------------------|
| ① Flat copper profile | ④ Cover profile               |
| ② Busbar supports     | ⑤ Support for blanking covers |
| ③ End cover           | ⑥ Blanking cover              |





60 mm busbar system: Basic assemblies up to 630 A

#### Selection and ordering data

##### Longitudinal stays and assembly kits for ALPHA distribution boards

Description	Dimensions	DT	Article No.	Price per PU	PU (UNIT, SET, M)	PS*/P. unit	PG	Weight per PU approx.
	mm							kg
<b>Longitudinal stays</b>								
For mounting the assembly kits in unequipped distribution boards, two longitudinal stays are required for each assembly kit width								
Height								
	600		<b>8GK4851-4KK00</b>		1	1 set	039	0.838
	750		<b>8GK4851-5KK00</b>		1	1 set	039	1.076
	900		<b>8GK4851-6KK00</b>		1	1 set	039	1.302
	1050		<b>8GK4851-7KK00</b>		1	1 set	039	1.528
	1200		<b>8GK4851-8KK00</b>		1	1 set	039	1.763
	1350		<b>8GK4852-8KK00</b>		1	1 set	039	2.000
<b>Assembly kits</b>								
Comprising touch protection cover and 4 supports								
Cutout width for three-phase busbar systems								
• 216 mm	300 × 250		<b>8GK4801-2KK13</b>		1	1 unit	039	0.500
• 466 mm	300 × 500		<b>8GK4801-2KK23</b>		1	1 unit	039	0.700
• 716 mm	300 × 750		<b>8GK4801-2KK33</b>		1	1 unit	039	0.900
• 216 mm	450 × 250		<b>8GK4801-3KK13</b>		1	1 unit	039	0.650
• 466 mm	450 × 500		<b>8GK4801-3KK23</b>		1	1 unit	039	0.900
• 716 mm	450 × 750		<b>8GK4801-3KK33</b>		1	1 unit	039	1.150
1 set = 2 stays								



### Busbar support and end cover

Description	Connections	Standard	DT	Article No.	Price per PU	PU (UNIT, SET, M)	PS*/P. unit	PG	Weight per PU approx.
									kg
<b>② Busbar supports</b>									
<b>End and intermediate holders for flat copper profiles 12, 15, 20, 25, 30 x 5, 10 mm</b>									
 8US1923-3AA01	3-pole, with outside fixing	L1-L3		<b>8US1923-2AA01</b>		1	10 units	143	0.161
	3-pole, with inner fixing	L1-L3		<b>8US1923-3AA01</b>		1	10 units	143	0.155
 8US1923-5AA00	4-pole, with inner fixing	L1-L3 + PE/N		<b>8US1923-4AA00</b>		1	10 units	143	0.244
	2-pole, with outside fixing			<b>8US1923-5AA00</b>		1	10 units	143	0.112
<b>N/PE busbar supports 12, 20, 30 x 5, 10 mm</b>									
 5SH3 540	1-pole, for flat copper profile for 5/10 mm busbars	PE/N		<b>5SH3540</b>		1	1 unit	031	0.059
<b>N/PE busbar supports 6 x 6 mm 12, 15, 20, 25, 30 x 5, 10 mm</b>									
 8US1923-1AA01	1-pole, for copper profiles for mounting on 8US1923-2AA01 3-pole busbar supports or free standing	PE/N	UL508	<b>8US1923-1AA01</b>		1	1 unit	143	0.039







# Busbar Systems

## 8US 60 mm Busbar Systems

### Basic assemblies up to 630 A

Description	Connections	Standard	DT	Article No.	Price per PU	PU (UNIT, SET, M)	PS*/P. unit	PG	Weight per PU approx. kg
<b>End and intermediate holders for flat copper profiles 5 mm x 20 mm, 10 mm x 20 mm, 10 mm x 30 mm</b>									
 <p>3-pole, with inner fixing</p>	L1-L3	UL 508 <sup>1)</sup>		<b>8US1923-3UA01</b>		1	10 units	143	0.126
 <p><b>③ End covers</b> For covering free busbar ends • For 8US1923-2AA01, 3AA01 and -3UA01</p>	L1-L3	UL 508		<b>8US1922-1AC00</b>		1	10 units	143	0.020

### Covers, supports for blanking covers, flat copper profiles and busbar connection parts





Description	Length	Width	Standard	DT	Article No.	Price per PU	PU (UNIT, SET, M)	PS*/P. unit	PG	Weight per PU approx. kg
	mm	mm								kg
<b>④ Cover profiles for busbars</b>										
 <p>12 mm x 5 mm</p>	1000				<b>8US1922-2CA00</b>		1	10 units	143	0.066
 <p>15 mm x 5 mm, 20 mm x 5 mm, 25 mm x 5 mm, 30 mm x 5 mm</p>	1000		UL 508		<b>8US1922-2AA00</b>		1	10 units	143	0.153
 <p>12 mm x 10 mm, 15 mm x 10 mm, 20 mm x 10 mm, 25 mm x 10 mm, 30 mm x 10 mm</p>	1000		UL 508		<b>8US1922-2BA00</b>		1	10 units	143	0.152
<b>⑤ Supports for blanking covers</b>										
 <p>Mounting on busbar, 32 mm depth (2 units per section of blanking cover)</p>			UL 508		<b>8US1922-2EA00</b>		1	4 units	143	0.035
 <p>Mounting on busbar, 107 mm depth (2 units per section of blanking cover)</p>			UL 508		<b>8US1922-2EA01</b>		1	8 units	143	0.081
<b>⑥ Blanking covers</b>										
 <p>Mounting on 8US1922-2EA.. support for blanking covers Height 195 mm, Depth 63 mm, Length 700 mm</p>			UL 508		<b>8US1922-2EB00</b>		1	2 units	143	0.700

<sup>1)</sup> Only with base plate 8US1922-2UA01

# Busbar Systems

## 8US 60 mm Busbar Systems

Basic assemblies up to 630 A

Description	Length	Cross-section	Standard	DT	Article No.	Price per PU	PU (UNIT, SET, M)	PS*/P. unit	PG	Weight per PU approx.
	mm	mm <sup>2</sup>								kg
 <p><b>Base plates</b> For 3-pole system, width 230 mm</p>	1100	--	UL 508		<b>8US1922-2UA01</b>		1	2 units	143	0.600
<p>8US1922-2UA01</p>  <p>① <b>Flat copper profiles (flat profile, bare)</b> Flat copper profiles for universal applications</p> <ul style="list-style-type: none"> <li>• 12 x 5 mm, current intensity 200 A 2400 60 EN 12167 <b>8WC5123</b> 1 1 unit 143 1.100</li> <li>• 15 x 5 mm, current intensity 250 A 2400 75 EN 12167 <b>8WC5121</b> 1 1 unit 143 1.550</li> <li>• 20 x 5 mm, current intensity 320 A 2400 100 EN 12167 <b>8WC5126</b> 1 1 unit 143 1.780</li> <li>• 20 x 5 mm, current intensity 400 A 1100 125 EN 12167 <b>8WC5031-1AA00</b> 1 1 unit 143 2.240</li> <li>• 25 x 5 mm, current intensity 400 A 2400 125 EN 12167 <b>8WC5131</b> 1 1 unit 143 2.240</li> <li>• 30 x 5 mm, current intensity 447 A 1100 150 EN 12167 <b>8WC5033-1AA00</b> 1 1 unit 143 2.680</li> <li>• 30 x 5 mm, current intensity 447 A 2400 150 EN 12167 <b>8WC5133</b> 1 1 unit 143 2.680</li> <li>• 20 x 10 mm, current intensity 520 A 2400 200 EN 12167 <b>8WC5128</b> 1 1 unit 143 3.200</li> <li>• 30 x 10 mm, current intensity 630 A 2400 300 EN 12167 <b>8WC5134</b> 1 1 unit 143 5.360</li> </ul> <p>Flat copper profile for ALPHA distribution boards</p> <ul style="list-style-type: none"> <li>• 12 x 5 mm, current intensity 250 A 250 60 EN 12167 <b>8GK9731-0KK10</b> 1 5 units 039 0.100</li> <li>500 60 EN 12167 <b>8GK9731-0KK20</b> 1 5 units 039 0.261</li> <li>750 60 EN 12167 <b>8GK9731-0KK30</b> 1 5 units 039 0.500</li> <li>1000 60 EN 12167 <b>8GK9731-0KK40</b> 1 5 units 039 0.531</li> <li>1250 60 EN 12167 <b>8GK9731-0KK50</b> 1 5 units 039 0.830</li> <li>• 20 x 5 mm, current intensity 320 A 250 100 EN 12167 <b>8GK9733-0KK10</b> 1 5 units 039 0.290</li> <li>500 60 EN 12167 <b>8GK9733-0KK20</b> 1 5 units 039 0.412</li> <li>750 60 EN 12167 <b>8GK9733-0KK30</b> 1 5 units 039 0.850</li> <li>1000 60 EN 12167 <b>8GK9733-0KK40</b> 1 5 units 039 1.120</li> <li>1250 60 EN 12167 <b>8GK9733-0KK50</b> 1 5 units 039 1.470</li> <li>• 30 x 5 mm, current intensity 447 A 250 150 EN 12167 <b>8GK9735-0KK10</b> 1 5 units 039 0.325</li> <li>500 150 EN 12167 <b>8GK9735-0KK20</b> 1 5 units 039 0.750</li> <li>750 150 EN 12167 <b>8GK9735-0KK30</b> 1 5 units 039 1.460</li> <li>1000 150 EN 12167 <b>8GK9735-0KK40</b> 1 5 units 039 2.170</li> <li>1250 150 EN 12167 <b>8GK9735-0KK50</b> 1 5 units 039 2.880</li> <li>• 30 x 10 mm, current intensity 630 A 250 300 EN 12167 <b>8GK9736-0KK10</b> 1 5 units 039 0.750</li> <li>500 300 EN 12167 <b>8GK9736-0KK20</b> 1 5 units 039 1.310</li> <li>750 300 EN 12167 <b>8GK9736-0KK30</b> 1 5 units 039 1.972</li> <li>1000 300 EN 12167 <b>8GK9736-0KK40</b> 1 5 units 039 3.400</li> <li>1250 300 EN 12167 <b>8GK9736-0KK50</b> 1 5 units 039 3.450</li> </ul>										
<p>① <b>Flat copper profiles, tinned</b></p> <ul style="list-style-type: none"> <li>• 12 x 5 mm, current intensity 200 A 2000 60 EN 12167 <b>8WC5051</b> 1 1 unit 143 1.100</li> <li>• 15 x 5 mm, current intensity 250 A 2000 75 EN 12167 <b>8WC5052</b> 1 1 unit 143 1.550</li> <li>• 20 x 5 mm, current intensity 320 A 2000 100 EN 12167 <b>8WC5053</b> 1 1 unit 143 1.780</li> <li>• 25 x 5 mm, current intensity 400 A 2000 125 EN 12167 <b>8WC5054</b> 1 1 unit 143 2.240</li> <li>• 30 x 5 mm, current intensity 447 A 2000 150 EN 12167 <b>8WC5055</b> 1 1 unit 143 2.680</li> <li>• 20 x 10 mm, current intensity 520 A 2000 200 EN 12167 <b>8WC5063</b> 1 1 unit 143 3.200</li> <li>• 30 x 10 mm, current intensity 630 A 2000 300 EN 12167 <b>8WC5065</b> 1 1 unit 143 5.360</li> </ul>										
 <p><b>Extension terminals</b> For busbars 12 x 5 mm, tightening torque 6.0 Nm (busbar not included, 1 set = 2 units)</p>	--	--	--		<b>8JK3201</b>		1	10 sets	046	0.020
<p>8JK3 20</p>										
<p><b>Busbar connection pieces for bars</b></p> <p>For flat profiles (max. 630 A) 20 mm x 5 mm, 20 mm x 10 mm, 25 mm x 5 mm, 25 mm x 10 mm, 30 mm x 5 mm, 30 mm x 10 mm</p>	40	--	--		<b>8US1921-2BE00</b>		1	6 units	143	0.275
 <p>8US1921-2BE00</p>										
<p>For flat profiles (max. 630 A) 12 mm x 5 mm, 12 mm x 10 mm, 15 mm x 5 mm, 15 mm x 10 mm, 20 mm x 5 mm, 20 mm x 10 mm</p>	55	--	--		<b>8US1921-2BF00</b>		1	12 units	143	0.216
 <p>8US1921-2BF00</p>										

# Busbar Systems

## 8US 60 mm Busbar Systems





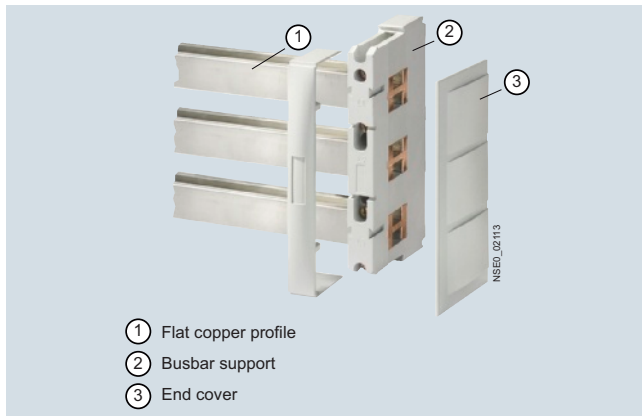

### Basic assemblies up to 1 600 A

#### Overview

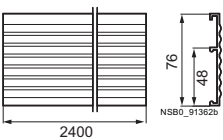

60 mm busbar system: Basic assembly up to 1 600 A

#### Selection and ordering data

Description	Standard	DT	Article No.	Price per PU	PU (UNIT, SET, M)	PS*/P. unit	PG	Weight per PU approx. kg
 <p><b>Busbar supports</b> 3-pole, for TT special profiles End and intermediate holder with finger-safe busbar cover (1 pack = 2 busbar supports + finger-safe end covers)</p>	L1-L3	UL 508	<b>8US1943-3AA00</b>		1	1 unit	143	1.140
 <p><b>Flat copper profiles (approx. 2.4 m long, tinned)</b> TT special profile up to 1 600 A, cross-section 720 mm<sup>2</sup></p>			<b>8US1948-2AA00</b>		1	1 unit	143	15.600
 <p><b>Cover profiles</b> For flat copper profiles, length 1 000 mm</p>			<b>8US1922-2DA00</b>		1	5 units	143	0.400
 <p><b>Busbar connection pieces</b> For special profiles/TT profiles up to 1 600 A</p>			<b>8US1941-2BF00</b>		1	3 units	143	1.116
 <p><b>Partitions, closed</b> 76 mm wide, 2 400 mm long For additional lateral touch protection at the top/bottom</p>			<b>8US1922-1JA00</b>		1	1 unit	143	0.500
 <p><b>Supports for blanking covers</b> Mounting on busbar, 32 mm depth (2 units per section of blanking cover) Mounting on busbar, 107 mm depth (2 units per section of blanking cover)</p>		UL 508	<b>8US1922-2EA00</b>		1	4 units	143	0.035
		UL 508	<b>8US1922-2EA01</b>		1	8 units	143	0.081
 <p><b>Blanking covers</b> Mounting on 8US1922-2EA.. support for blanking covers Height 195 mm, Depth 63 mm, Length 700 mm</p>		UL 508	<b>8US1922-2EB00</b>		1	2 units	143	0.700

# Busbar Systems

## 8US 60 mm Busbar Systems

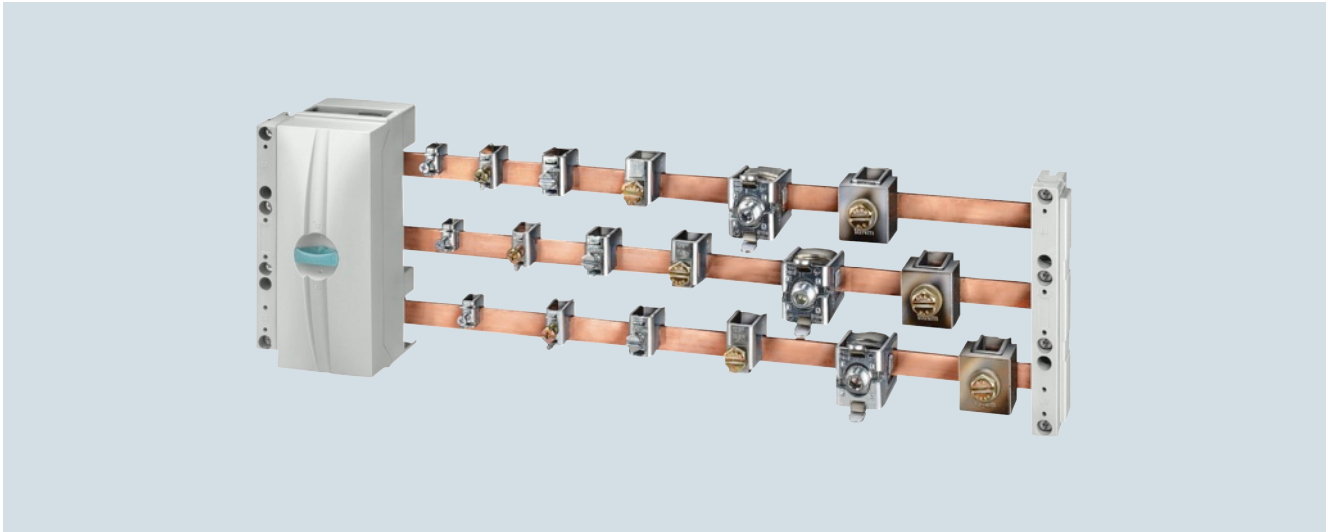

Infeed and connection methods  
from 630 A to 1 600 A

### Overview



60 mm busbar system: Terminals and covers for infeed and connection methods





### Selection and ordering data

	Description	Length	Width	Max. current	Conductor cross-section	Standard	DT	Article No.	Price per PU	PU (UNIT, SET, M)	PS*/P. unit	PG	Weight per PU approx. kg
		mm	mm	A	mm <sup>2</sup>								
 8US1921-1AA00	<b>Infeeds</b>												
	Connecting terminal plate with cover												
	• 3-pole	200	20	80	1.5 ... 16	UL 508		<b>5SH3538</b>		1	5 units	031	0.181
	• 3-pole	200	54	300	6 ... 50	UL 508		<b>8US1921-1BA00</b>		1	1 unit	143	0.446
	• 3-pole	200	81	400	35 ... 120	UL 508		<b>8US1921-1AA00</b>		1	1 unit	143	0.493
 5SH3 535	<b>Outgoing modules for PE/N</b>												
	Connection module for 4th pole (PE/N) up to 16 mm, must be attached to an adapter/device holder	242	18	--				<b>8US1200-0AA00</b>		1	1 unit	143	0.116
 8US1941-2AA03	<b>SR60 connecting terminal plates</b>												
	3-pole with cover, suitable for aluminum conductors (shown without cover)			560	150 ... 300			<b>5SH3535</b>		1	1 unit	031	1.608
	<b>Terminal sets</b>												
3-pole without cover for round cables, suitable for aluminum conductors			560	120 ... 300			<b>8US1941-2AA03</b>		1	1 unit	143	1.577	

# Busbar Systems

## 8US 60 mm Busbar Systems

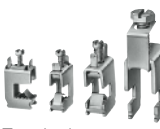
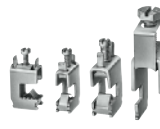



Infeed and connection methods  
from 630 A to 1 600 A

	Description	Max. current	Conductor cross-section mm <sup>2</sup>	Standard	DT	Article No.	Price per PU	PU (UNIT, SET, M)	PS*/P. unit	PG	Weight per PU approx. kg
	<b>Terminal sets</b> 3-pole without cover for flat bars up to 32 x 20 mm	800		UL 508		<b>8US1941-2AA04</b>		1	1 unit	143	1.377
8US1941-2AA04											
	Covers for 8US1941-2AA03/04 terminal set					<b>8US1922-1GC00</b>		1	1 unit	143	0.361
8US1922-1GC00											
	<b>Terminals for circular conductors</b> <b>5 mm busbar thickness<sup>1)</sup></b>										
	12 mm x 5 mm,	180	1.5 ... 16		▶	<b>8US1921-2AA00</b>		100	100 units	143	2.100
	15 mm x 5 mm,	270	4 ... 35		▶	<b>8US1921-2AB00</b>		100	50 units	143	4.700
	20 mm x 5 mm,	400	16 ... 70		▶	<b>8US1921-2AD00</b>		1	50 units	143	0.071
	25 mm x 5 mm,	440	16 ... 120		▶	<b>8US1921-2AC00</b>		1	50 units	143	0.104
	30 mm x 5 mm				▶	<b>8US1921-2AA01</b>		1	15 units	143	0.021
		180	1.5 ... 16		▶	<b>8US1921-2AB01</b>		1	15 units	143	0.045
		270	4 ... 35		▶	<b>8US1921-2AD01</b>		1	15 units	143	0.072
		400	16 ... 70		▶	<b>8US1921-2AC01</b>		1	15 units	143	0.105
		440	16 ... 120		▶						
	<b>10 mm bar thickness</b>										
	12 mm x 10 mm, <sup>1)</sup>	180	1.5 ... 16		▶	<b>8US1921-2BA00</b>		1	100 units	143	0.023
	15 mm x 10 mm, <sup>1)</sup>	270	4 ... 35		▶	<b>8US1921-2BB00</b>		1	50 units	143	0.033
	20 mm x 10 mm,	400	16 ... 70		▶	<b>8US1921-2BD00</b>		1	50 units	143	0.073
	25 mm x 10 mm,	440	16 ... 120		▶	<b>8US1921-2BC00</b>		1	50 units	143	0.102
	30 mm x 10 mm				▶	<b>8US1921-2BA01</b>		1	15 units	143	0.022
		180	1.5 ... 16		▶	<b>8US1921-2BB01</b>		1	15 units	143	0.070
		270	4 ... 35		▶	<b>8US1921-2BD01</b>		1	15 units	143	0.072
		400	16 ... 70		▶	<b>8US1921-2BC01</b>		1	15 units	143	0.107
		440	16 ... 120		▶						
	20 mm x 5 mm, 25 mm x 5 mm, 30 mm x 5 mm	500	95 ... 185		▶	<b>8US1941-2AA01</b>		1	6 units	143	0.304
8US1941-2AA01											
		600	150 ... 300		▶	<b>8US1941-2AA02</b>		1	3 units	143	0.411
8US1941-2AA02											

# Busbar Systems

## 8US 60 mm Busbar Systems

Infeed and connection methods  
from 630 A to 1 600 A

	Description	Max. current	Conductor cross-section mm <sup>2</sup>	Standard	DT	Article No.	Price per PU	PU (UNIT, SET, M)	PS*/P. unit	PG	Weight per PU approx. kg
 8US1922-1GA00	<b>Terminal covers for circular conductors (fixing to busbar)</b>										
	For terminals up to 120 mm <sup>2</sup> 200 mm long, 84 mm wide				▶	<b>8US1922-1GA00</b>		1	10 units	143	0.162
	For terminals up to 300 mm <sup>2</sup> 2) 200 mm long, 270 mm wide				▶	<b>8US1922-1GA02</b>		1	1 unit	143	0.696
 8US1941-2AC00	<b>Terminals</b>										
	For cable lugs up to 240 mm <sup>2</sup> , 630 10 mm bar thickness (threaded bolts M10)					<b>8US1941-2AC00</b>		1	6 units	143	0.356
 8US1941-2BB00	For copper bars or laminated conductors 20 mm x 5 mm, 20 mm x 10 mm, 25 mm x 5 mm, 25 mm x 10 mm, 30 mm x 5 mm, 30 mm x 10 mm	750				<b>8US1941-2BB00</b>		1	6 units	143	0.329
	For 2 x 40 mm x 10 mm, for TT flat copper profile 30 x 10 profile for flat bars up to 40 x 25	1250				<b>8US1941-2BA00</b>		1	3 units	143	0.815
 8US1941-2BA00											

1) Cannot be used on a special profile up to 1 600 A.

2) Only for 20 mm x 5 mm, 20 mm x 10 mm, 25 mm x 5 mm, 25 mm x 10 mm, 30 mm x 5 mm and 30 mm x 10 mm.

# Busbar Systems

## 8US 60 mm Busbar Systems

Busbar device adapters and device holders  
from 630 A to 1 600 A

### Overview

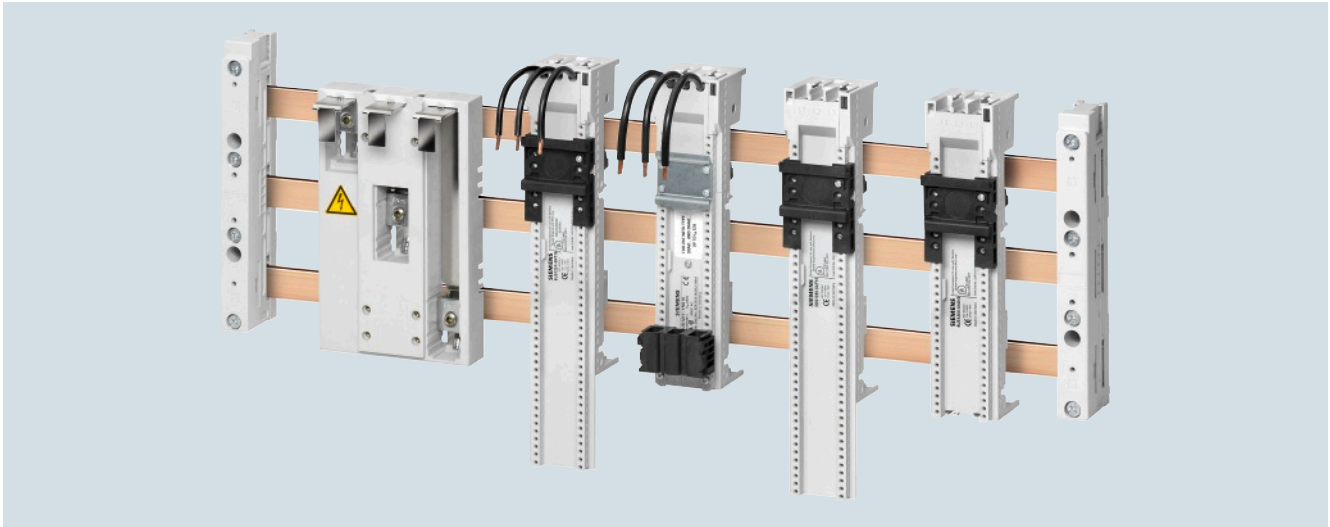



60 mm busbar system: Busbar device adapters and device holders

All busbar device adapters and device holders are designed for copper busbars according to DIN 46433, width 12 to 30 mm, thickness 5 mm and 10 mm, and special profiles up to 1 600 A.

### Selection and ordering data

#### For SIRIUS 3RV2/3RT2 load feeders



Welded connecting cable resistant up to 150 °C

	Busbar device adapters for	Number of support rails (35 mm)	Adapter		Connecting cable			Standard	DT	Article No.	Price per PU	PU (UNIT, SET, M)	PS*/P. unit	PG	Weight per PU approx.
			Length	Width	Cross-section	Temperature max.	Rated current								
			mm	mm	AWG	°C	A	V						kg	
<b>Size S00 devices with screw connection</b>															
	Circuit breakers	1	200	45	12	150	25	690	UL 508 ▶	<b>8US1251-5DS10</b>		1	1 unit	143	0.290
	Direct-on-line starters	1	200	45	12	150	25	690	UL 508 ▶	<b>8US1251-5DS10</b>		1	1 unit	143	0.290
	Reversing starters	1	260	45	12	150	25	690	UL 508 ▶	<b>8US1251-5DT10</b>		1	1 unit	143	0.324
		+	1	200	45	12	150	25	690	UL 508 ▶	<b>8US1251-5DS10</b>		1	1 unit	143
Device holders with 3RA2120	Device holders	1	200	45	--	--	--	--	UL 508 ▶	<b>8US1250-5AS10</b>		1	1 unit	143	0.234
<b>Size S00 devices with screw connection</b>															
	Circuit breakers	1	200	45	12	150	25	690	UL 508 ▶	<b>8US1251-5DS11</b>		1	1 unit	143	0.314
	Circuit breakers	1	260	45	12	150	25	690	UL 508 ▶	<b>8US1251-5DT11</b>		1	1 unit	143	0.324
	Direct-on-line starters	1	260	45	12	150	25	690	UL 508 ▶	<b>8US1251-5DT11</b>		1	1 unit	143	0.324
	Reversing starters	1	260	45	12	150	25	690	UL 508 ▶	<b>8US1251-5DT11</b>		1	1 unit	143	0.324
	Device holders with 3RA2120	+	1	260	45	--	--	--	--	UL 508 ▶	<b>8US1250-5AT10</b>		1	1 unit	143

# Busbar Systems

## 8US 60 mm Busbar Systems

### Busbar device adapters and device holders from 630 A to 1 600 A

Busbar device adapters for	Number of support rails (35 mm)	Adapter		Connecting cable				Standard	DT	Article No.	Price per PU	PU (UNIT, SET, M)	PS*/P. unit	PG	Weight per PU approx.	
		Length	Width	Cross-section	Temperature max.	Rated current	Rated voltage									
		mm	mm	AWG	°C	A	V									kg
<b>Size S0 devices with screw connection</b>																
 Device holders with 3RA2220	Circuit breakers	1	260	45	10	150	32	690	UL 508 ▶	<b>8US1251-5NT10</b>		1	1 unit	143	0.287	
	Direct-on-line starters	1	260	45	10	150	32	690	UL 508 ▶	<b>8US1251-5NT10</b>		1	1 unit	143	0.287	
	Reversing starters	1	260	45	10	150	32	690	UL 508 ▶	<b>8US1251-5NT10</b>		1	1 unit	143	0.287	
	+ Device holders	1	260	45	--	--	--	--	UL 508 ▶	<b>8US1250-5AT10</b>		1	1 unit	143	0.264	
<b>Size S0 devices with spring-type terminals</b>																
 Device holders with 3RA2220	Circuit breakers	1	260	45	10	150	32	690	UL 508 ▶	<b>8US1251-5NT11</b>		1	1 unit	143	0.345	
	Direct-on-line starters	1	260	45	10	150	32	690	UL 508 ▶	<b>8US1251-5NT11</b>		1	1 unit	143	0.345	
	Reversing starters	1	260	45	10	150	32	690	UL 508 ▶	<b>8US1251-5NT11</b>		1	1 unit	143	0.345	
	+ Device holders	1	260	45	--	--	--	--	UL 508 ▶	<b>8US1250-5AT10</b>		1	1 unit	143	0.264	

#### Lateral modules for busbar device adapters



Description	Length	Width	DT	Article No.	Price per PU	PU (UNIT, SET, M)	PS*/P. unit	PG	Weight per PU approx.	
		mm	mm							kg
 <b>Lateral modules</b> For extending busbar device adapters and device holders of the same length	200	9		<b>8US1998-2BJ10</b>		1	10 units	143	0.021	

# Busbar Systems

## 8US 60 mm Busbar Systems

### Busbar device adapters and device holders from 630 A to 1 600 A

#### For SIRIUS 3RV1/3RT1 load feeders

	Busbar device adapters for	Number of support rails (35 mm)	Adapter		Connecting cable			Standard	DT	Article No.	Price per PU	PU (UNIT, SET, M)	PS*/P. unit	PG	Weight per PU approx.
			Length	Width	Cross-section	Temperature max.	Rated current								
		mm		mm	AWG	°C	A	V							
<b>Size S2 devices</b>															
	Circuit breakers	1	182	55	8	105	56	690	▶	<b>8US1261-5FM08</b>		1	1 unit	143	0.234
	Contactors + overload relay	1	182	55	8	105	56	690	▶	<b>8US1261-5FM08</b>		1	1 unit	143	0.234
	Direct-on-line starters	1	242	55	8	105	56	690	▶	<b>8US1261-5FP08</b>		1	1 unit	143	0.293
	Reversing starter adapter	1	242	55	8	105	56	690	▶	<b>8US1261-5FP08</b>		1	1 unit	143	0.293
	Device holders <sup>1)</sup>	--	242	54	--	--	--	--	▶	<b>8US1260-5AP00</b>		1	1 unit	143	0.182
	Connecting wedges (2 units needed for attachment)	--	--	--	--	--	--	--	▶	<b>8US1998-1AA00</b>		100	100 units	143	0.052
<b>Size S3 devices with screw connection</b>															
	Circuit breakers	--	215	72	4	105	80	600	UR, CSA	<b>8US1211-4TR00</b>		1	1 unit	143	0.623



<sup>1)</sup> Spacer and fixing screw for reversing contactor are included in the scope of delivery.

# Busbar Systems

## 8US 60 mm Busbar Systems

Busbar device adapters and device holders  
from 630 A to 1 600 A

**For motor starter protectors/circuit breakers and switch disconnectors which require busbar device adapters for mounting on busbars**

	Busbar device adapters for	Adapter		Connecting cable		Standard	DT	Article No.	Price per PU	PU (UNIT, SET, M)	PS*/P. unit	PG	Weight per PU approx.
		Length	Width	Type	Rated current								
		mm	mm		A	V							kg
	<b>3VL molded case circuit breakers<sup>1)</sup></b>												
 8US10 11-4SL01	3VL1 <sup>2)</sup>	175	108	Busbars	160	690		<b>8US1211-4SL01</b>		1	1 unit	143	0.579
	3VL2 <sup>2)</sup>	175	108	Busbars	160	690		<b>8US1211-4SL01</b>		1	1 unit	143	0.579
	3VL3 <sup>3)</sup>	175	108	Busbars	250	690		<b>8US1211-4SL00</b>		1	1 unit	143	0.641
	3VL1 to 3VL4 and also with RCD module <sup>2)</sup> see chapter 2	320	184	M10 pin connector	400	690		<b>8US1210-4AF00 +</b>		1	1 unit	143	2.688
	3VL5	325	184	Tubular contacts	580	690		<b>8US1213-4AF00</b>		1	1 unit	143	3.239
	<b>3VL UL circuit breakers</b>												
 8US12 13-4AQ01	VL150X UL CG frame	190	105	Tubular contacts	150	600	UL 508	<b>8US1213-4AQ01</b>		1	1 unit	143	1.116
	VL150 UL DG frame	190	105	Tubular contacts	150	600	UL 508	<b>8US1213-4AQ03</b>		1	1 unit	143	1.114
	VL250 UL FG frame	190	105	Tubular contacts	250	600	UL 508	<b>8US1213-4AQ03</b>		1	1 unit	143	1.114
 8US12 13-4AH00	VL400 UL JG-Frame	296	140	Tubular contacts	400	600	UL 508	<b>8US1213-4AH00</b>		1	1 unit	143	2.539
	VL400X UL LG-Frame	296	140	Tubular contacts	540	600	UL 508	<b>8US1213-4AH00</b>		1	1 unit	143	2.539
	<b>3KA and 3KL switch disconnectors</b>												
	3KA52 <sup>4)</sup> 3KA53 <sup>4)</sup> 3KL52 <sup>4)</sup> 3KL53 <sup>4)</sup>	320	184	M10 pin connector	630	690		<b>8US1210-4AF00</b>		1	1 unit	143	2.688
	3KA55 <sup>4)</sup> 3KA57 <sup>4)</sup> 3KA58 <sup>4)</sup> 3KL55 <sup>4)</sup> 3KL57 <sup>4)</sup>	320	250	M10 pin connector	630	690		<b>8US1210-4AG00</b>		1	1 unit	143	2.926
	<b>3NP5 fuse switch disconnectors</b>												
	3NP50 60 (NH00)	175	108	Busbars	160	690		<b>8US1291-4SB00</b>		1	1 unit	143	0.522
	3NP52 3NP53 3NP54 <sup>5)</sup>	320	250	M10 pin connector	630	690	UL 508	<b>8US1210-4AG00</b>		1	1 unit	143	2.926

<sup>1)</sup> Observe the short-circuit strength of the busbar system. Short-circuit strength > 50 kA on request.

<sup>2)</sup> Usable only for 3VL circuit breakers with line-side box terminals.

<sup>3)</sup> Only for 3VL 250 A circuit breakers, for screw fixing with metric thread, for flat terminals.

<sup>4)</sup> Without connecting cables. The connecting cable between adapter and device should be manufactured in accordance with the rated current as a round cable, e.g. H07V-R with cable lug, or as a flat conductor for an M10 stud terminal.

<sup>5)</sup> Without connecting cables. The connecting cable between adapter and device should be manufactured in accordance with the rated current as a round cable, e.g. H07V-R, bared at both ends for tunnel terminals.



# Busbar Systems

## 8US 60 mm Busbar Systems

### Busbar device adapters and device holders from 630 A to 1 600 A

For SIRIUS 3RA6 compact starters according to IEC and UL

Welded connecting cable resistant up to 105 °C









Busbar device adapter for	Number of support rails (35 mm)	Adapter		Connecting cable				Standard	DT	Article No.	Price per PU	PU (UNIT, SET, M)	PS*/P. unit	PG	Weight per PU approx.
		Length	Width	Cross-section	Temperature max.	Rated current	Rated voltage								
		mm	mm	AWG	°C	A	V								
<b>Size equivalent to 3RA61</b>															
	Direct-on-line starters	1	200	45	10	105	32	690	UR, CSA ▶	<b>8US1211-1NS10</b>		1	1 unit	143	0.300
<b>Size equivalent to 3RA62</b>															
	Reversing starters	1	200	45	10	105	32	690	UR, CSA ▶	<b>8US1211-1NS10</b>		1	1 unit	143	0.300
	+ Device holders	1	200	45	--	--	--	--	UL 508 ▶	<b>8US1250-1AA10</b>		1	1 unit	143	0.278
<b>Device holders</b>															

# Busbar Systems

## 8US 60 mm Busbar Systems

Busbar device adapters and device holders  
from 630 A to 1 600 A

### For universal device design

	Number of support rails (35 mm)	Adapter		Connecting cable				Standard	DT	Article No.	Price per PU	PU (UNIT, SET, M)	PS*/P. unit	PG	Weight per PU approx.
		Length	Width	Cross-section	Temperature max.	Length	Rated current								
		mm	mm	AWG	°C	mm	A	V							kg
<b>Devices 45 mm wide</b>															
Device holder for side mounting onto busbar device adapter, no electrical contact															
	1	200	45	--	--	--	--	--	UL 508 ▶	<b>8US1250-1AA10</b>		1	1 unit	143	0.278
8US1250-1AA10	1	200	45	--	--	--	--	--	UL 508 ▶	<b>8US1250-5AS10</b>		1	1 unit	143	0.234
	1	260	45	--	--	--	--	--	UL 508 ▶	<b>8US1250-5AT10</b>		1	1 unit	143	0.264
8US1250-5AS10	1	260	45	--	--	--	--	--	UL 508 ▶	<b>8US1250-5AT10</b>		1	1 unit	143	0.264
	1	260	45	--	--	--	--	--	UL 508 ▶	<b>8US1250-5AT10</b>		1	1 unit	143	0.264
8US1250-5AT10	1	260	45	--	--	--	--	--	UL 508 ▶	<b>8US1251-5DS11</b>		1	1 unit	143	0.314
<b>Devices 45 mm and 72 mm wide</b>															
Busbar device adapter with connecting cables for contact with busbars, welded connecting cable resistant up to 150 °C															
	1	200	45	12	150	165	25	690	UL 508 ▶	<b>8US1251-5DS11</b>		1	1 unit	143	0.314
8US1251-5DS10	1	200	45	12	150	99	25	690	UL 508 ▶	<b>8US1251-5DS10</b>		1	1 unit	143	0.290
	1	260	45	12	150	99	25	690	▶	<b>8US1251-5DT10</b>		1	1 unit	143	0.324
8US1251-5DT10	1	260	45	12	150	165	25	690	UL 508 ▶	<b>8US1251-5DT11</b>		1	1 unit	143	0.324
	1	260	45	10	150	99	32	690	UL 508 ▶	<b>8US1251-5NT10</b>		1	1 unit	143	0.287
8US1251-5NT10	1	260	45	10	150	165	32	690	UL 508 ▶	<b>8US1251-5NT11</b>		1	1 unit	143	0.345
	1	200	45	10	105	118	32	690	UL 508 ▶	<b>8US1211-1NS10</b>		1	1 unit	143	0.300
8US1211-4TR00	--	215	72	4	105	210	100	690	UR, CSA	<b>8US1211-4TR00</b>		1	1 unit	143	0.623
	--	200	9	--	--	--	--	--		<b>8US1998-2BJ10</b>		1	10 units	143	0.021
8US1998-2BJ10	--	200	9	--	--	--	--	--		<b>8US1998-2BJ10</b>		1	10 units	143	0.021

\* You can order this quantity or a multiple thereof.

# Busbar Systems

## 8US 60 mm Busbar Systems

### Accessories for SIRIUS 3RV2/3RT2 load feeders

#### Selection and ordering data

Accessories for SIRIUS 3RV2/3RT2 load feeders are designed for:





- 8US 60 mm busbar system for Cu busbars according to DIN 46433

- Width 12 mm up to 30 mm, thickness 5 mm and 10 mm
- And special profiles up to 1 600 A

	Description	Length	Width	DT	Article No.	Price per PU	PU (UNIT, SET, M)	PS*/P. unit	PG	Weight per PU approx. kg
		mm	mm							
	<b>Busbar connection pieces for bars</b> 20 mm × 5 mm, 20 mm × 10 mm, 25 mm × 5 mm, 25 mm × 10 mm, 30 mm × 5 mm, 30 mm × 10 mm	40			<b>8US1921-2BE00</b>		1	6 units	143	0.275
	12 mm × 5 mm, 12 mm × 10 mm, 15 mm × 5 mm, 15 mm × 10 mm, 20 mm × 5 mm, 20 mm × 10 mm	55			<b>8US1921-2BF00</b>		1	12 units	143	0.216
	<b>Support rails (35 mm)</b> Support rails made of plastic with fixing screws		45		<b>8US1998-7CB45</b>		1	10 units	143	0.014
	Support rails made of plastic with fixing screws		54		<b>8US1998-7CB54</b>		1	10 units	143	0.016
	Support rails made of plastic with fixing screws		72		<b>8US1998-7CB72</b>		1	10 units	143	0.030
	<b>Connecting elements</b> For connecting busbar adapters and device holders			▶	<b>8US1998-1AA10</b>		1	50 units	143	0.001
	<b>Spacers</b> Fix the feeder to the busbar adapter			▶	<b>8US1998-1BA10</b>		1	10 units	143	0.005
	<b>Vibration &amp; shock kit</b>			▶	<b>8US1998-1CA10</b>		1	2 units	143	0.008
	<b>Lateral modules</b> For extending busbar device adapters and device holders of the same length	200	9		<b>8US1998-2BJ10</b>		1	10 units	143	0.021

#### Selection and ordering data

##### For snap connections to 60 mm busbar systems

	Rated current $I_U$	LV HRC fuse links according to IEC 60269-1	DT	Article No.	Price per PU	PU (UNIT, SET, M)	PS*/P. unit	PG	Weight per PU approx. kg
	A	Size							
<b>For cover level 32 / 70 mm, with reach-around protection for 8US busbar system</b>									
<b>Basic units</b>									
<b>Flat terminals</b>									
	160	00 / 000		<b>3NP1133-1BC10</b>		1	1 unit	143	1.155
	250	1 and 0		<b>3NP1143-1BC10</b>		1	1 unit	143	3.245
	400	2 and 1		<b>3NP1153-1BC10</b>		1	1 unit	143	4.314
	630	3 and 2		<b>3NP1163-1BC10</b>		1	1 unit	143	5.260
<b>Box terminals</b>									
3NP1133-1BC20	160	000		<b>3NP1123-1BC20</b>		1	1 unit	143	0.971
	160	00 / 000		<b>3NP1133-1BC20</b>		1	1 unit	143	1.146
	250	1 and 0		<b>3NP1143-1BC20</b>		1	1 unit	143	3.306
	400	2 and 1		<b>3NP1153-1BC20</b>		1	1 unit	143	4.672
630	3 and 2		<b>3NP1163-1BC20</b>		1	1 unit	143	5.538	
<b>With MFM electromechanical fuse monitoring</b>									
<b>Flat terminals</b>									
	160	00 / 000		<b>3NP1133-1BC11</b>		1	1 unit	143	1.698
	250	1 and 0		<b>3NP1143-1BC11</b>		1	1 unit	143	3.914
	400	2 and 1		<b>3NP1153-1BC11</b>		1	1 unit	143	5.016
	630	3 and 2		<b>3NP1163-1BC11</b>		1	1 unit	143	5.910
<b>Box terminals</b>									
3NP1133-1BC21	160	00 / 000		<b>3NP1133-1BC21</b>		1	1 unit	143	1.702
	250	1 and 0		<b>3NP1143-1BC21</b>		1	1 unit	143	3.993
	400	2 and 1		<b>3NP1153-1BC21</b>		1	1 unit	143	5.500
	630	3 and 2		<b>3NP1163-1BC21</b>		1	1 unit	143	6.223
<b>With EFM 10 electronic fuse monitoring</b>									
<b>Flat terminals</b>									
	160	00 / 000		<b>3NP1133-1BC12</b>		1	1 unit	143	1.394
	250	1 and 0		<b>3NP1143-1BC12</b>		1	1 unit	143	3.564
	400	2 and 1		<b>3NP1153-1BC12</b>		1	1 unit	143	4.666
	630	3 and 2		<b>3NP1163-1BC12</b>		1	1 unit	143	5.555
<b>Box terminals</b>									
3NP1133-1BC22	160	000		<b>3NP1123-1BC22</b>		1	1 unit	143	1.109
	160	00 / 000		<b>3NP1133-1BC22</b>		1	1 unit	143	1.406
	250	1 and 0		<b>3NP1143-1BC22</b>		1	1 unit	143	3.650
	400	2 and 1		<b>3NP1153-1BC22</b>		1	1 unit	143	5.014
630	3 and 2		<b>3NP1163-1BC22</b>		1	1 unit	143	5.826	
<b>With EFM 20 electronic fuse monitoring and line monitoring</b>									
<b>Flat terminals</b>									
	160	00 / 000		<b>3NP1133-1BC13</b>		1	1 unit	143	1.411
	250	1 and 0		<b>3NP1143-1BC13</b>		1	1 unit	143	3.641
	400	2 and 1		<b>3NP1153-1BC13</b>		1	1 unit	143	4.750
	630	3 and 2		<b>3NP1163-1BC13</b>		1	1 unit	143	5.611
<b>Box terminals</b>									
3NP1133-1BC23	160	000		<b>3NP1123-1BC23</b>		1	1 unit	143	1.121
	160	00 / 000		<b>3NP1133-1BC23</b>		1	1 unit	143	1.470
	250	1 and 0		<b>3NP1143-1BC23</b>		1	1 unit	143	3.685
	400	2 and 1		<b>3NP1153-1BC23</b>		1	1 unit	143	5.090
630	3 and 2		<b>3NP1163-1BC23</b>		1	1 unit	143	5.920	
<b>Accessories</b>									
<b>Connection modules</b>									
	For 32-mm cover level with box terminal 6 mm ... 70 mm <sup>2</sup>			<b>3NP1933-1BC00</b>		1	1 unit	143	0.193

# Busbar Systems

## 8US 60 mm Busbar Systems

### UL applications

#### Overview

##### Short-circuit strength

The short-circuit strength of the busbar system is dependent on the distance of the busbar supports and on the busbar cross-section.

The short-circuit strength of the whole system is dependent on the short-circuit strength of the busbars and of the adapters with circuit breakers or switch disconnectors. If one of these values is lower than the prospective short-circuit current at the installation site, a current-limiting protective device has to be mounted upstream of the 8US busbar system. This may also be mounted as a feeder circuit breaker on the busbar system itself. The table below provides a selection aid for this purpose.

##### Selection aid for UL applications

Components used		Short-circuit current rating (SCCR) Total kA	Ambient conditions					Fuse type used	Max. spacing of busbar supports mm
Article No.	Description		Max. rated current $I_e$ A	Rated voltage $U_e$ V	Busbar dimensions	Rated current of the fuse used $I_e$ A			
8US1921-1AA00	Connection terminal plate with cover, conductor cross-section 35 ... 120 mm <sup>2</sup>	10	--	600	--	--	--	533	
8US1921-1AA00		65	400	480	--	400	3VL-UL; 3RV.7; 3RV.8	800	
8US1921-1AA00		50	600	480	--	600	3VL-UL; 3RV.7; 3RV.8	800	
8US1921-1AA00		35	400	600	--	400	3VL-UL; 3RV.7; 3RV.8	800	
8US1921-1AA00		35	600	600	--	600	3VL-UL; 3RV.7; 3RV.8	800	
8US1921-1AA00		100	600	480	--	600	J or T	800	
8US1921-1AA00		100	500	600	--	500	J or T	800	
8US1921-1AA00		100	400	480	--	400	RK1	800	
8US1921-1AA00		100	400	600	--	400	RK1	800	
8US1922-2AA00	Cover profiles for busbars	--	--	--	--	--	--	--	
8US1922-2BA00	Cover profiles for busbars	--	--	--	--	--	--	--	
8US1922-2DA00	Cover profiles for flat copper profile	--	--	--	--	--	--	--	
8US1923-3UA01	End and intermediate holders for flat copper profiles	18	150	600	12x5	--	--	250	
8US1923-3UA01		18	150	600	12x5	--	--	400	
8US1923-3UA01		65	150	480	12x5	250	3VL-UL; 3RV.7; 3RV.8	800	
8US1923-3UA01		25	150	600	12x5	250	3VL-UL; 3RV.7; 3RV.8	800	
8US1923-3UA01		100	150	480	12x5	400	RK1, J or T	800	
8US1923-3UA01		100	150	600	12x5	175	J or T	800	
8US1923-3UA01		100	150	600	12x5	100	RK1	800	
8US1923-3UA01		18	150	600	12x10	--	-	250	
8US1923-3UA01		18	150	600	12x10	--	-	400	
8US1923-3UA01		65	150	480	12x10	250	3VL-UL; 3RV.7; 3RV.8	800	
8US1923-3UA01		25	150	600	12x10	250	3VL-UL; 3RV.7; 3RV.8	800	
8US1923-3UA01		100	150	480	12x10	400	RK1, J or T	800	
8US1923-3UA01		100	150	600	12x10	175	J or T	800	
8US1923-3UA01		100	150	600	12x10	100	RK1	800	
8US1923-3UA01		18	362	600	20x5	--	-	250	
8US1923-3UA01		18	362	600	20x5	--	-	400	
8US1923-3UA01		65	362	480	20x5	400	3VL-UL; 3RV.7; 3RV.8	800	
8US1923-3UA01		35	362	600	20x5	400	3VL-UL; 3RV.7; 3RV.8	800	
8US1923-3UA01		100	362	480	20x5	500	J or T	800	
8US1923-3UA01		100	362	600	20x5	400	J or T	800	
8US1923-3UA01		100	362	480	20x5	400	RK1	800	
8US1923-3UA01		100	362	600	20x5	200	RK1	800	
8US1923-3UA01		18	564	600	20x10	--	-	250	
8US1923-3UA01		18	564	600	20x10	--	-	400	
8US1923-3UA01		65	564	480	20x10	400	3VL-UL; 3RV.7; 3RV.8	800	
8US1923-3UA01		35	564	600	20x10	400	3VL-UL; 3RV.7; 3RV.8	800	
8US1923-3UA01		100	564	480	20x10	500	J or T	800	
8US1923-3UA01		100	564	600	20x10	400	J or T	800	
8US1923-3UA01		100	564	480	20x10	400	RK1	800	
8US1923-3UA01		100	564	600	20x10	200	RK1	800	
8US1923-3UA01		25	500	600	30x5	--	-	250	
8US1923-3UA01		22	500	600	30x5	--	-	400	
8US1923-3UA01		65	500	480	30x5	400	3VL-UL; 3RV.7; 3RV.8	800	
8US1923-3UA01		35	500	600	30x5	600	3VL-UL; 3RV.7; 3RV.8	800	

# Busbar Systems

## 8US 60 mm Busbar Systems

UL applications

Components used		Short-circuit current rating (SCCR) Total	Ambient conditions					Fuse type used	Max. spacing of busbar supports
Article No.	Description		Max. rated current $I_e$	Rated voltage $U_e$	Busbar dimensions	Rated current of the fuse used $I_e$			
			kA	A		V	A		
8US1923-3UA01	End and intermediate holders for flat copper profiles	100	500	480	30x5	500	J or T	800	
8US1923-3UA01		100	500	600	30x5	500	J or T	800	
8US1923-3UA01		100	500	480	30x5	400	RK1	800	
8US1923-3UA01		100	500	600	30x5	400	RK1	800	
8US1923-3UA01		25	756	600	30x10	--	--	250	
8US1923-3UA01		22	756	600	30x10	--	--	400	
8US1923-3UA01		65	756	480	30x10	400	3VL-UL; 3RV.7; 3RV.8	800	
8US1923-3UA01		35	756	600	30x10	400	3VL-UL; 3RV.7; 3RV.8	800	
8US1923-3UA01		50	756	480	30x10	600	3VL-UL; 3RV.7; 3RV.8	800	
8US1923-3UA01		25	756	600	30x10	600	3VL-UL; 3RV.7; 3RV.8	800	
8US1923-3UA01		100	756	480	30x10	600	J or T	800	
8US1923-3UA01		100	756	600	30x10	450	J or T	800	
8US1923-3UA01		100	756	480	30x10	400	RK1	800	
8US1923-3UA01		100	756	600	30x10	400	RK1	800	
8US1923-3UA01		65	--	480	--	400	3VL-UL; 3RV.7; 3RV.8	800	
8US1923-3UA01		50	--	480	--	600	3VL-UL; 3RV.7; 3RV.8	800	
8US1923-3UA01		35	--	600	--	600	3VL-UL; 3RV.7; 3RV.8	800	
8US1923-3UA01		100	--	480	--	600	J or T	800	
8US1923-3UA01		100	--	600	--	500	J or T	800	
8US1923-3UA01		100	--	480	--	400	RK1	800	
8US1923-3UA01	100	--	600	--	400	RK1	800		
8US1213-4AH00	Device adapters for 3VL UL molded-case circuit breakers	65	630	480	--	600	--	400	
8US1213-4AH00		50	630	600	--	600	--	400	
8US1213-4AH00		65	630	480	--	400	3VL-UL; 3RV.7; 3RV.8	800	
8US1213-4AH00		35	630	600	--	400	3VL-UL; 3RV.7; 3RV.8	800	
8US1213-4AH00		50	630	480	--	600	3VL-UL; 3RV.7; 3RV.8	800	
8US1213-4AH00		25	630	600	--	600	3VL-UL; 3RV.7; 3RV.8	800	
8US1211-4TR00	Busbar adapter 45 mm/ 72 mm	10	80	600	--	--	--	400	
8US1213-4AQ01	Busbar adapters for 3VL UL molded-case circuit breakers	65	250	480	--	250	--	400	
8US1213-4AQ01		50	250	600	--	250	--	400	
8US1213-4AQ01		65	250	480	--	250	3VL-UL; 3RV.7; 3RV.8	800	
8US1213-4AQ01		25	250	600	--	250	3VL-UL; 3RV.7; 3RV.8	800	
8US1948-2AA00	Flat copper profiles	103	1400	600	--	1600	Class L	N/A	
8US1943-3AA00	Busbar supports, 3-pole, double-T profile	30	1200	600	--	--	--	400	
8US1943-3AA00		25	1200	600	--	--	--	700	
8US1943-3AA00		65	1200	480	--	800	3VL-UL; 3RV.7; 3RV.8	800	
8US1943-3AA00		30	1200	600	--	800	3VL-UL; 3RV.7; 3RV.8	800	
8US1943-3AA00		100	1200	480	--	800	Class T	800	
8US1943-3AA00		100	1200	600	--	600	J or T	800	
8US1943-3AA00		100	1200	480	--	600	Class RK1	800	
8US1943-3AA00		100	1200	600	--	400	Class RK1	800	
8US1943-3AA00		30	1400	600	--	--	--	400	
8US1943-3AA00		25	1400	600	--	--	--	700	
8US1943-3AA00		65	1400	480	--	800	3VL-UL; 3RV.7; 3RV.8	800	
8US1943-3AA00		30	1400	600	--	800	3VL-UL; 3RV.7; 3RV.8	800	
8US1943-3AA00		100	1400	480	--	800	T	800	
8US1943-3AA00		100	1400	600	--	600	J or T	800	
8US1943-3AA00		100	1400	480	--	600	RK1	800	
8US1943-3AA00		100	1400	600	--	400	RK1	800	
8US1943-3AA00		65	--	480	--	800	3VL-UL; 3RV.7; 3RV.8	800	
8US1943-3AA00		30	--	600	--	800	3VL-UL; 3RV.7; 3RV.8	800	
8US1943-3AA00		100	--	480	--	800	T	800	
8US1943-3AA00		100	--	600	--	600	J or T	800	
8US1943-3AA00		100	--	480	--	600	RK1	800	
8US1943-3AA00		100	--	600	--	400	RK1	800	
8US1922-1GC00		Covers for connection terminal set	--	--	--	--	--	--	--

10

# Busbar Systems

## 8US 60 mm Busbar Systems

### UL applications





Components used		Short-circuit current rating (SCCR) Total kA	Ambient conditions					Fuse type used	Max. spacing of busbar supports mm
Article No.	Description		Max. rated current $I_e$	Rated voltage $U_e$	Busbar dimensions	Rated current of the fuse used $I_e$			
			A	V		A			
8US1941-2AA03	Connection terminals, 3-pole	65	400	480	--	400	3VL-UL; 3RV.7; 3RV.8	800	
8US1941-2AA03		35	400	600	--	400	3VL-UL; 3RV.7; 3RV.8	800	
8US1941-2AA03		100	500	480	--	500	J or T	800	
8US1941-2AA03		100	300	600	--	300	J or T	800	
8US1941-2AA03		100	400	480	--	400	RK1	800	
8US1941-2AA03		100	200	600	--	200	RK1	800	
8US1211-1NS10 / 8US1251-5DS10 / 8US1251-5DT11 / 8US1251-5DT10	Busbar device adapters and device holders	5	32	600	--	12.5	3RV20 + 3RV2928-1K	400	
8US1211-1NS10 / 8US1251-5DS10 / 8US1251-5DT11 / 8US1251-5DT10	Busbar device adapters and device holders	5	32	480	--	32	3RV20 + 3RV2928-1K	400	
8US1211-1NS10 / 8US1251-5DS10 / 8US1251-5DT11 / 8US1251-5DT10	Busbar device adapters and device holders	30	32	600	--	12.5	3RV20 + 3RV2928-1K	400	
8US1211-1NS10 / 8US1251-5DS10 / 8US1251-5DT11 / 8US1251-5DT10	Busbar device adapters and device holders	65	32	480	--	16	3RV20	400	
8US1211-1NS10 / 8US1251-5DS10 / 8US1251-5DT11 / 8US1251-5DT10	Busbar device adapters and device holders	65	32	600	--	25	3RV20 + 3RV2928-1K	400	
8US1211-1NS10 / 8US1251-5DS10 / 8US1251-5DT11 / 8US1251-5DT10	Busbar device adapters and device holders	50	32	480	--	32	3RV20 + 3RV2928-1K	400	
8US1211-1NS10 / 8US1251-5DS10 / 8US1251-5DT11 / 8US1251-5DT10	Busbar device adapters and device holders	5	25	600	--	--	--	400	
8US1211-1NS10 / 8US1251-5DS10 / 8US1251-5DT11 / 8US1251-5DT10	Busbar device adapters and device holders	5	32	600	--	--	--	400	
8US1211-1NS10 / 8US1251-5DS10 / 8US1251-5DT11 / 8US1251-5DT10	Busbar device adapters and device holders	5	25	600	--	--	--	400	
8US1211-1NS10 / 8US1251-5DS10 / 8US1251-5DT11 / 8US1251-5DT10	Busbar device adapters and device holders	5	32	600	--	--	--	400	
8US1211-1NS10 / 8US1251-5DS10 / 8US1251-5DT11 / 8US1251-5DT10	Busbar device adapters and device holders	5	25	600	--	--	--	400	
8US1211-1NS10 / 8US1251-5DS10 / 8US1251-5DT11 / 8US1251-5DT10	Busbar device adapters and device holders	5	32	600	--	--	--	400	
8US1251-5NT10	Busbar adapters for devices of size S0	5	30	600	--	--	--	400	
8US1250-1AA10	Device holders for SIRUS 3RA6	--	--	--	--	--	--	--	
8US1250-5AT10	Device holders for devices of width 45 mm	--	--	--	--	--	--	--	
8US1250-5AS10		--	--	--	--	--	--	--	

### Selection and ordering data

Accessories are designed for:

- 8US 60 mm busbar system for Cu busbars according to DIN 46433
- Width 12 mm up to 30 mm, thickness 5 mm and 10 mm
- And special profiles up to 1 600 A

### Adapters and device holders for SIRIUS 3RV1/3RT1 load feeders (discontinued types)







	Busbar device adapters	Number of support rails (35 mm)	Adapter		Connecting cable			DT	Article No.	Price per PU	PU (UNIT, SET, M)	PS*/P. unit	PG	Weight per PU approx.
			Length	Width	Cross-section	Rated current	Rated voltage							
			mm	mm	mm <sup>2</sup>	A	V						kg	
	<b>Busbar device adapters with terminals (at top) for any arrangement of components</b>													
	--	1	182	45	1.5 ... 4	25	690		<b>8US1250-5RM07</b>		1	1 unit	143	0.157
8US12 50-5RM07														
	<b>Device holders for lateral mounting to busbar device adapters of the same length</b>													
	Device holders	1	182	45	--	--	--	▶	<b>8US1250-5AM00</b>		1	1 unit	143	0.138
	Device holders	1	182	55	--	--	--	▶	<b>8US1260-5AM00</b>		1	1 unit	143	0.180
	Device holders	--	242	54	--	--	--	▶	<b>8US1260-5AP00</b>		1	1 unit	143	0.182
	Connecting wedges (2 units needed for attachment)	--	--	--	--	--	--	▶	<b>8US1998-1AA00</b>		100	100 units	143	0.052
8US1950-1AM00														
	Connecting wedges													
	<b>Lateral modules for extending busbar device adapters and device holders of the same length</b>													
	Lateral modules	--	182	13.5	--	--	--		<b>8US1998-2BM00</b>		1	4 units	143	0.032
8US1998-2BM00														

# Busbar Systems

## 8US 60 mm Busbar Systems

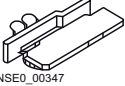
### Accessories

#### Other accessories for SIRIUS 3RV1/3RT1 load feeders (discontinued types)

	Description	Length	Width	DT	Article No.	Price per PU	PU (UNIT, SET, M)	PS*/P. unit	PG	Weight per PU approx. kg
		mm	mm							
  Support rails	<b>Support rails (35 mm) - plastic with fixing screws</b>									
			45		<b>8US1998-7CA15</b>		1	10 units	143	0.010
			55		<b>8US1998-7CA16</b>		1	10 units	143	0.001
			72		<b>8US1998-4AA00</b>		1	10 units	143	0.014
			90		<b>8US1998-7CA08</b>		1	10 units	143	0.020
		110		<b>8US1998-7CA10</b>		1	10 units	143	0.019	
 <small>NSE0_00347</small> 8US1998-1DA00	<b>Connection holders</b> For fixing the circuit breaker to the support rail (for SIRIUS size S00/S0)				<b>8US1998-1DA00</b>		100	20 units	143	0.100
 8US1998-1CA00	<b>Screw holders</b> For supplementary screw mounting of the branch (for SIRIUS size S00/S0)				<b>8US1998-1CA00</b>		100	20 units	143	0.200
 8US1998-1BA00	<b>Spacers</b> Fix the feeder to the busbar adapter (for SIRIUS size S00/S0)			▶	<b>8US1998-1BA00</b>		100	100 units	143	0.100
 Connecting wedges	<b>Connecting wedges</b> For mechanical linking of busbar device adapters and device holder (2 units per combination)			▶	<b>8US1998-1AA00</b>		100	100 units	143	0.052

## Overview

### Material properties

Busbar supports and busbar-mounting fuse bases (see "Built-in components" from page 10/33) are manufactured from glass-fiber reinforced, thermoplastic polyester (color RAL 7035, light gray). The material ensures excellent mechanical, chemical and electrical properties. Furthermore, the material has an extremely low flammability and meets the requirements of UL 94 V0. This satisfies the load requirements of the busbar supports at rated operational voltage 500 V and rated currents at 200 A to 630 A, as well as the rated short-circuit strength 50 kA.

### Continuous currents depending on the Cu power rail dimensions and Cu busbar temperatures at 35 °C ambient temperature

Cu busbar dimensions H × D mm × mm	Continuous current for open busbar run - ambient temperature 35 °C	Continuous current of fuse link Operational class gL/gG
	A	A
12 × 5	200	200
12 × 10	360	315
15 × 5	250	250
15 × 10	447	400
20 × 5	320	315
20 × 10	520	500
25 × 5	400	400
25 × 10	580	500
30 × 5	447	400
30 × 10	630	630

As far as other types of upstream protective devices are concerned, please observe the permissible continuous current of the busbar.

### Dynamic rated short-circuit strength

The electrodynamic load of the busbars depends on the level of short-circuit current, the length of the busbar section through which the current flows, the support spacing of the busbar supports and, of course, on the distance between the busbars themselves. This is because, for example, if an LV HRC fuse is connected upstream to the busbars in the protective device, the let-through current  $i_D$  is the maximum current to flow through this protective device. The value  $i_D$  depends on the maximum system short-circuit current and the current-limiting action of the protective device used. The permissible let-through values of the protective devices are specified by the manufacturers in the form of a current limitation diagram as a function of the so-called prospective short-circuit current (r.m.s. value of the possible rated short-circuit current for the system).

The current-limiting characteristics for the fuse links can be found in the Technical Information, see note on Technical Information at the beginning of the chapter.

For busbar supports with busbars of 12 mm x 5 mm to 20 mm x 5 mm, the distance between the holders of the support spacing should be adapted to suit the bars in the distribution board and, if possible, should not exceed 250 mm. When using busbars of 25 mm x 5 mm, 30 mm x 5 mm, 12 mm x 10 mm to 30 mm x 10 mm the distance can also be up to 500 mm. In the case of larger distances, subcarriers must be fitted, as increased support spacing reduces the dynamic stability.

It is essential to ensure that the permissible current carrying capacity of the individual busbars is not exceeded. A center infeed is required in the limit range. However, the infeed can also be carried out at both ends of the busbar.

### Ambient temperatures

When dimensioning the busbars based on rated currents, the ambient temperature and the Cu busbar temperature must also be taken into account.

The location of the busbar system and its ability to dissipate heat through convection also play a key role in this calculation. Because conditions can vary for each distribution board, the values in the following table serve as a guideline only. However, they must be applied to the entire busbar length.

### Diagram of the dynamic short-circuit strength of the busbars

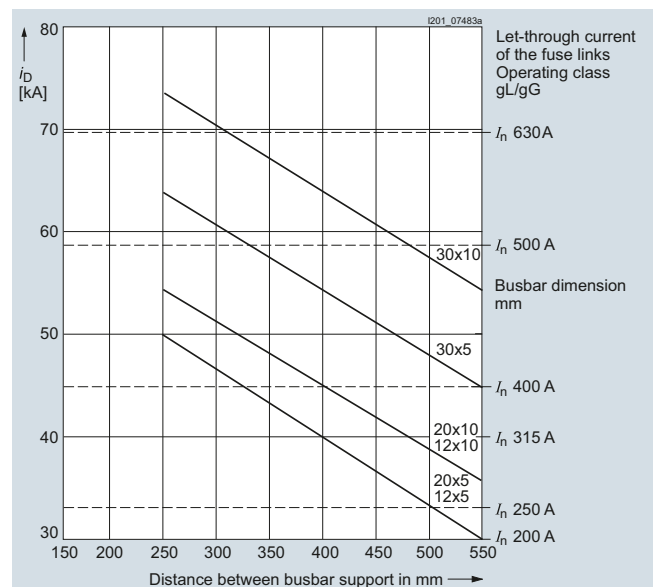

$i_D$ : Let-through values (kA) of the LV HRC fuse links, operational class gL/gG with rated current 200 A to 630 A for a prospective short-circuit current  $I_p = 120$  kA.

## Distribution board components

### Planning dimensions

	Width mm	MW
NEOZED bus-mounting bases D02		
Covers	27	1.5
Covers, extra wide	36	2.0
Covers, double width	54	3.0
DIAZED bus-mounting bases DII		
Covers	42	2.3
Covers, double width	84	4.7
DIAZED bus-mounting bases DIII		
Covers	57	3.2
Covers, double width	114	6.3
NEOZED bus-mounting switch disconnectors	27	1.5
LV HRC fuse switch disconnectors size 00	108	6

### Number of built-in components that can be mounted

Height	Width	Cutout width	D02/63 A 5SH5241	D02/63 A 5SH5242	D02/63 A 5SH5243	DII/25 A 5SH2042	DIII/63 A 5SH2242	5SG7230 bus- mounting switch disconnectors D02
mm	mm	mm	(27 mm width)	(36 mm width)	(54 mm width)	(42 mm width)	(57 mm width)	(26.8 mm width)
300	250	216	8	6	4	5	3	8
	500	466	17	12	8	11	8	17
	750	716	26	19	13	17	12	26
450	250	216	8	6	4	5	3	8
	500	466	17	12	8	11	8	17
	750	715	26	19	13	17	12	26

10

### Dimensional drawings

8GK9 busbar support

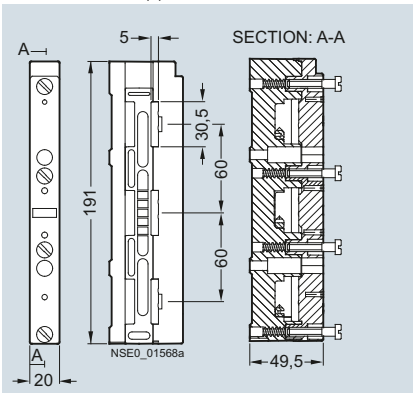

8GK9711-0KK03

N/PE busbar support

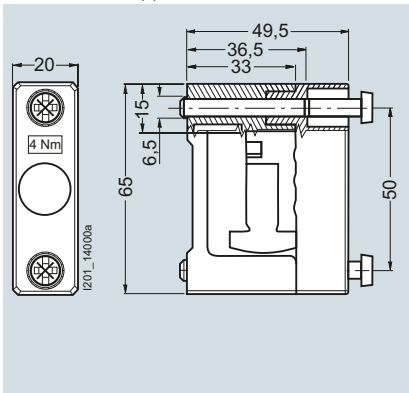

5SH3540

Connection modules

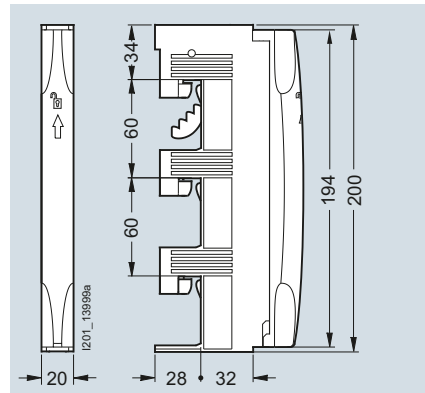

5SH5538

Connection modules

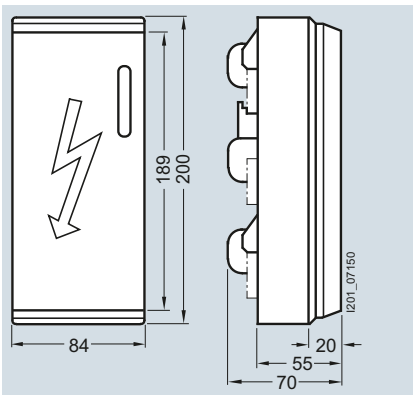
8US1921-1AA00  
shown closed

Connection modules

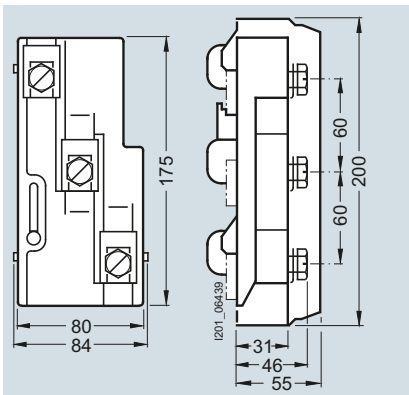
8US1921-1AA00  
shown open

Connection modules

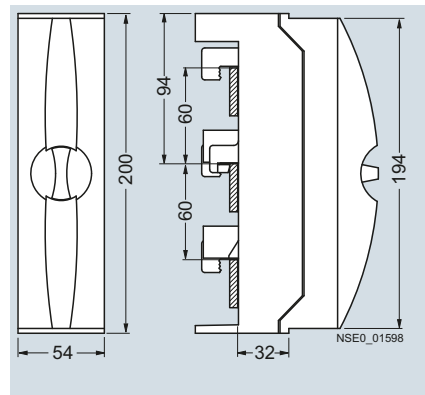

8US1921-1BA00

## Overview

Rail-adaptable built-in components, such as NEOZED and DIAZED bus-mounting bases, adapters for modular installation devices, fuse switch disconnectors and NEOZED bus-mounting fuse switch disconnectors are made of glass-fiber reinforced, thermoplastic polyester. The material ensures the required mechanical, chemical and electrical properties.

Efficient power distribution up to 630 A. Users have several options for mounting the SR60 busbar system:

### 1. Mounting in distribution boards

The busbar supports are mounted on the longitudinal stays. Once the built-in components are mounted and connected, the touch protection cover (section cover) protects against accidental contact with live parts.

### 2. Installation in industrial control cabinets

The demand for comprehensive touch protection has generated new solutions: built-in components, such as busbar fuse bases

have integrated reach-through guards, enable the implementation of cost-effective overall solutions.

Previously two optional solutions were provided, which can now be replaced using new technology: touch protection over base and edges or touch protection over partitions.

Higher overall efficiency and cost savings in the plant engineering industry.

The fuse holders for cylindrical fuses, size 10 x 38 and for American fuses, Class CC, can be used in the international plant engineering industry. In addition, Siemens offers a broad range of UL-approved components for the design of switchgear assembly according to UL 508 A.

For further information, see chapter "BETA Devices according to UL Standards" in Catalog LV 16 · 2009.

Fuse holders are available with a connection module 16 mm<sup>2</sup> and screwless terminals; this offers users maximum safety and comfort.

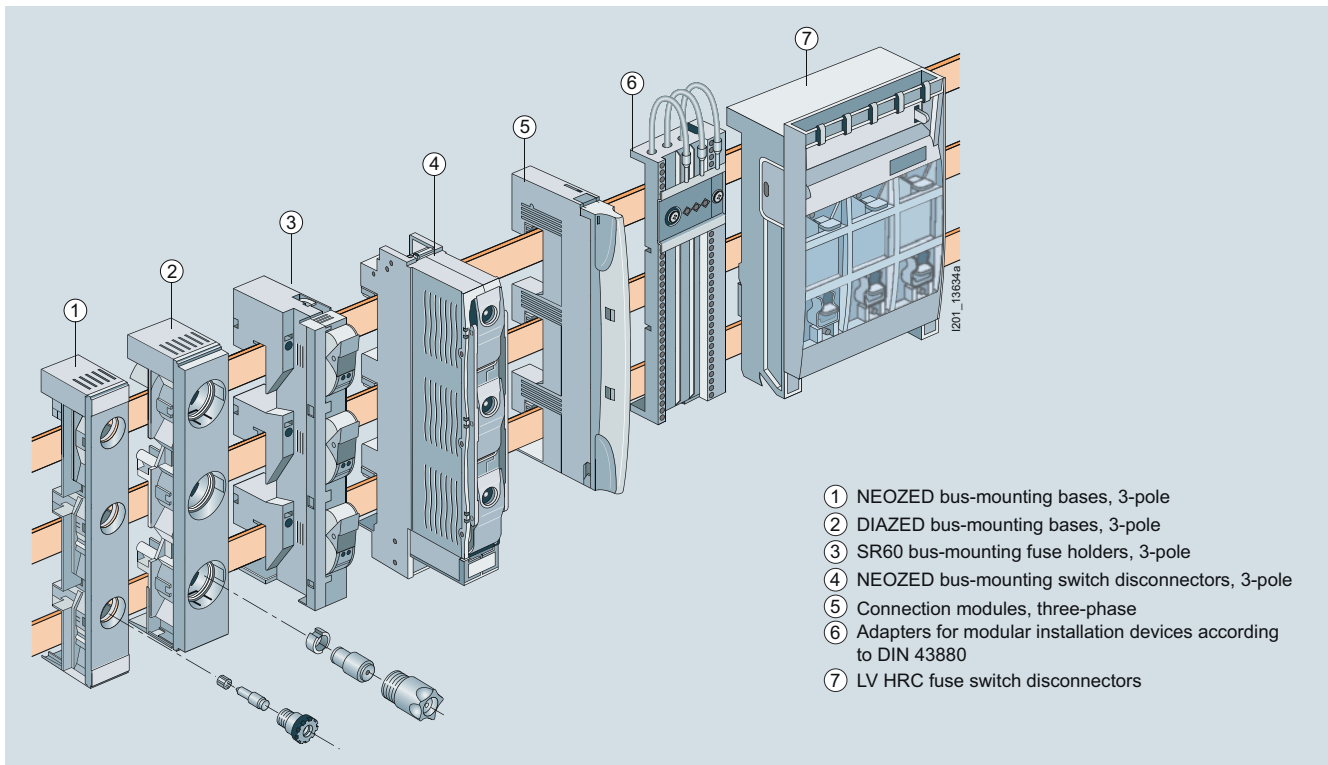

- ① NEOZED bus-mounting bases, 3-pole
- ② DIAZED bus-mounting bases, 3-pole
- ③ SR60 bus-mounting fuse holders, 3-pole
- ④ NEOZED bus-mounting switch disconnectors, 3-pole
- ⑤ Connection modules, three-phase
- ⑥ Adapters for modular installation devices according to DIN 43880
- ⑦ LV HRC fuse switch disconnectors

## Benefits

- The direct contact of the rail-adaptable switching and installation devices on the Cu busbars reduces distribution panels and mounting times
- Compared to conventional installation, the transfer resistance of the connections is drastically reduced. This prevents unnecessary temperature rise.
- New built-in components with touch protection ensure comprehensive touch protection without the previously required partitions.
- International application due to UL-approved components.
- Enhanced effectiveness and increased safety due to screwless terminals.

## Built-in components

### Technical specifications













	NEOZED SR60 bus-mounting bases		DIAZED SR60 bus-mounting bases	
	5SG6202 5SG6206 5SG6207 D01	D02	5SF6014 5SF6015 5SF6020 DII	5SF6214 5SF6215 5SF6220 DIII
<b>Standards</b>	IEC 60269-3, DIN VDE 0636-3			
<b>Rated voltage</b>	V AC/DC	400/250		500 690/600
<b>Rated frequency</b>	Hz	50		
<b>Rated current</b>	A	16 (with NEOZED retain- ing springs)	63	25 63
<b>Rated conditional short-circuit current</b>	kA AC kA DC	50 8		50 8
<b>For fuse links with power losses per phase</b>	W	2.5	5.5	4 7
<b>Busbar center-to-center spacing</b>	mm	60		60

		3NW7431	3NW7431-OHG
<b>Standards</b>		IEC 60269-2, UL 512, CSA C22.2	UL 512, CSA C22.2
<b>Approvals</b>		UL, CSA	UL, CSA
<b>Size</b>		10 x 38	Class CC
<b>Rated frequency</b>	Hz	50/60	
<b>Max. rated voltage <math>U_e</math></b>			
• IEC/EN	V AC	690	--
• UL/CSA	V AC	600	600
<b>Max. rated operational current <math>I_e</math></b>			
(When several devices are used next to each other, it is essential to comply with the rated load factor according to EN 60439-1 (VDE 0660-500), Table 1)			
• IEC/EN	A	32	--
• UL/CSA	A	30	30
<b>Utilization categories</b>			
• IEC/EN		AC-22B (500 V) AC-21B (690 V, 30 A) Can only be used as fuse holder	
• UL/CSA			
<b>Rated conditional short-circuit current</b>			
(type-tested with fuse links, operational class gL/gG)			
• IEC/EN	kA	100 (400 V, 500 V, 690 V)	--
• UL/CSA	kA	50 (600 V)	200
<b>For fuse links with power losses per phase</b>	W	3 --	
<b>Screwless wire connections</b>			
• IEC/EN	mm <sup>2</sup>	Cu 1.5 ... 6 (f)	
• UL/CSA	AWG	16 ... 10 (str)	

		5SG7230	3NW7430
<b>Standards</b>		IEC 60269-3, IEC 60269-2	IEC 60269-3, IEC 60269-2
<b>Approvals</b>		EN 60947-3 (VDE 0660-107), IEC 60947-3	EN 60947-3 (VDE 0660-107), IEC 60947-3
<b>Size</b>		D01 D02	10 mm x 38 mm
<b>Rated frequency</b>	Hz	50/60	
<b>Rated voltage <math>U_e</math></b>	V AC V DC	400 110	690 --
<b>Rated insulation voltage <math>U_i</math></b>	V	800	
<b>Rated impulse withstand voltage <math>U_{imp}</math></b>	kV	6	
<b>Rated operational current <math>I_e</math></b>	A	63 <sup>1)</sup>	Up to 32
<b>Utilization categories</b>			
(type-tested with 3-pole, switchable version)		AC-23 A (400 V) DC-21 B (48 V) – 1 Pole DC-21 B (110 V) – 2 Pole	AC-20 DC-20
<b>Box terminals for wire connection</b>	mm <sup>2</sup> mm <sup>2</sup> mm <sup>2</sup>	Cu 1.5 ... 6 (re) Cu 1.5 ... 16 (f) Cu 1,5 ... 16 (f+AE)	Cu 1.5 ... 6 (re) Cu 1.5 ... 16 (f) Cu 1.5 ... 16 (f+AE)
<b>Signaling switches for the display of switching positions</b>		1 CO	
<b>Cable terminals</b>		Bottom	
<b>Busbar thickness</b>	mm	Through combination foot for 5, 10 mm	
<b>Rated conditional short-circuit current</b>	kA AC kA DC	50 8	50 --
(type-tested with fuse links, operational class gL/gG)			
<b>Permissible power loss of fuse links per phase</b>	W	5.5 3	
For stand-alone operation without lateral modules or for group operation with lateral modules			

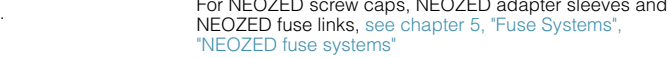





<sup>1)</sup> In the case of permanent load over 35 A, we recommend the use of 5SH5526 lateral modules. Please observe EN 60439-1, Table 1.

## Selection and ordering data



	Size	Rated current	Rated voltage	Mounting width	DT	Article No.	Price per PU	PU (UNIT, SET, M)	PS*/P. unit	PG	Weight per PU approx.
	A	V	MW								kg
	<b>NEOZED SR60 bus-mounting bases with touch protection, 3P</b> For 5/10 mm busbars 27 mm wide										
	D02	63	400	1.5		<b>5SG6206</b>		1	4 units	031	0.175
	36 mm wide										
	D02	63	400	2		<b>5SG6207</b>		1	4 units	031	0.188
	<b>NEOZED SR60 bus-mounting bases, 3P standard version</b> For 5/10 mm busbars										
	D02	63	400	1.5		<b>5SG6202</b>		1	4/104 units	031	0.141
	<b>NEOZED SR60 covers for standard version</b>										
	D02	Extra wide, with clearance for wiring		1.5		<b>5SH5241</b>		1	4/200 units	031	0.023
	D02										
				2		<b>5SH5242</b>		1	4/140 units	031	0.027
	With double width For more clearance for wiring										
	D02			3		<b>5SH5243</b>		1	4/120 units	031	0.039
	For use with DIAZED screw adapters										
	DII	25	500	2.3		<b>5SF6020</b>		1	4 units	031	0.291
	DIII										
		63	500 V AC/DC (according to DIN VDE 0636-3 also 690 V AC/600 V DC)	3.2		<b>5SF6220</b>		1	4 units	031	0.392
	For NEOZED screw caps, NEOZED adapter sleeves and NEOZED fuse links, <a href="#">see chapter 5, "Fuse Systems"</a> , <a href="#">"NEOZED fuse systems"</a>										
	<b>DIAZED SR60 bus-mounting bases, 3P standard version</b> For use with DIAZED screw adapters										
	DII	25	500	2.3		<b>5SF6015</b>		1	2/52 units	031	0.210
	DIII										
		63	500 V AC/DC (according to DIN VDE 0636-3 also 690 V AC/600 V DC)	3.2		<b>5SF6215</b>		1	2/52 units	031	0.288
	<b>DIAZED SR60 covers for standard version</b>										
	DII			2.3		<b>5SH2042</b>		1	2/120 units	031	0.051
	DIII										
				3.2		<b>5SH2242</b>		1	2/120 units	031	0.056

# Busbar Systems

## Built-in components

Size	Rated current	Rated voltage	Mounting width	DT	Article No.	Price per PU	PU (UNIT, SET, M)	PS*/P. unit	PG	Weight per PU approx.
A	V	MW								kg
<b>DIAZED screw adapters with E27 thread</b>										
Also for 5SF2 30 to 750 V										
	DII	2			▶ <b>5SH310</b>		1	25/1500 units	017	0.014
		4			▶ <b>5SH311</b>		1	25/1500 units	017	0.009
		6			▶ <b>5SH312</b>		1	25/1500 units	017	0.015
		10			▶ <b>5SH313</b>		1	25/1500 units	017	0.021
		16			▶ <b>5SH314</b>		1	25/1500 units	017	0.008
		20			▶ <b>5SH315</b>		1	25/1500 units	017	0.013
	25			▶ <b>5SH316</b>		1	25/1500 units	017	0.012	
<b>SR60 bus-mounting fuse holders, 3P</b>										
For 5/10 mm busbars with screwless terminals										
	For cylindrical fuses, 10 x 38 mm  									
	--	30	690	1.5	<b>3NW7431</b>		1	1 unit	031	0.185
For UL fuses, class CC  										
--	30	600	1.5	<b>3NW7431-0HG</b>		1	1 unit	031	0.186	
<b>NEOZED SR60 bus-mounting switch disconnectors, 3P</b>										
For 5/10 mm busbars										
	D02	63*	400	1.5	<b>5SG7230</b>		1	1/30 units	031	0.747
	*from 35 A load use 5SH5526 lateral module									
DIAZED screw caps, DIAZED screw adapters and DIAZED fuse links, see chapter 5, "Fuse Systems", "DIAZED fuse system"										

## Other accessories

Version	Mounting width	DT	Article No.	Price per PU	PU (UNIT, SET, M)	PS*/P. unit	PG	Weight per PU approx.
	MW							kg
<b>Auxiliary switches for signaling the switching state for NEOZED SR60 bus-mounting switch disconnectors (5SG7230)</b>								
	0.5		<b>5SH5525</b>		1	1/50 units	031	0.007
5SH5 525								
<b>Lateral modules</b>								
For greater heat dissipation for loads from 35 A with NEOZED bus-mounting switch disconnectors								
	0.5		<b>5SH5526</b>		1	5/50 units	031	0.051
5SH5 526								
<b>Reducers</b>								
For NEOZED fuse links D01 in SR60 bus-mounting switch disconnectors								
			<b>5SH5527</b>		1	10/100 units	031	0.001
5SH5 527								

### Dimensional drawings

#### NEOZED SR60 bus-mounting bases

D02/63 A  
(a = 27 mm t = busbar thickness)

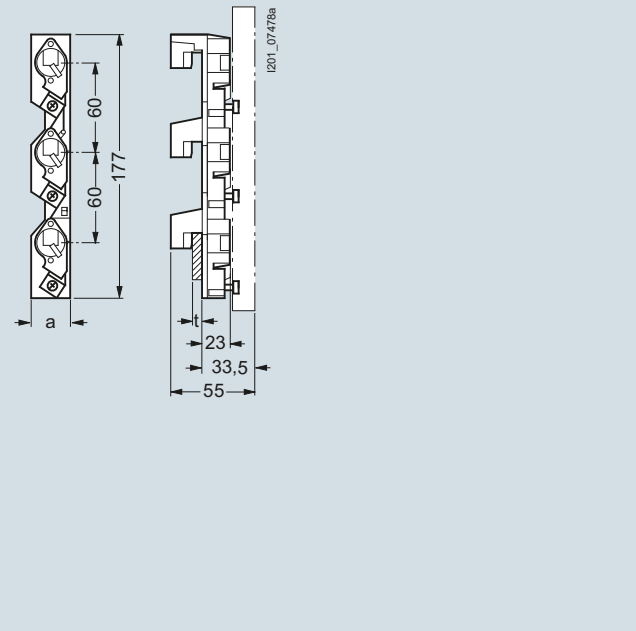

5SG6202 (t = 5 mm)

D02/63 A (a = 27 mm, b = 50 mm)      D02/63 A (a = 36 mm, b = 50 mm)

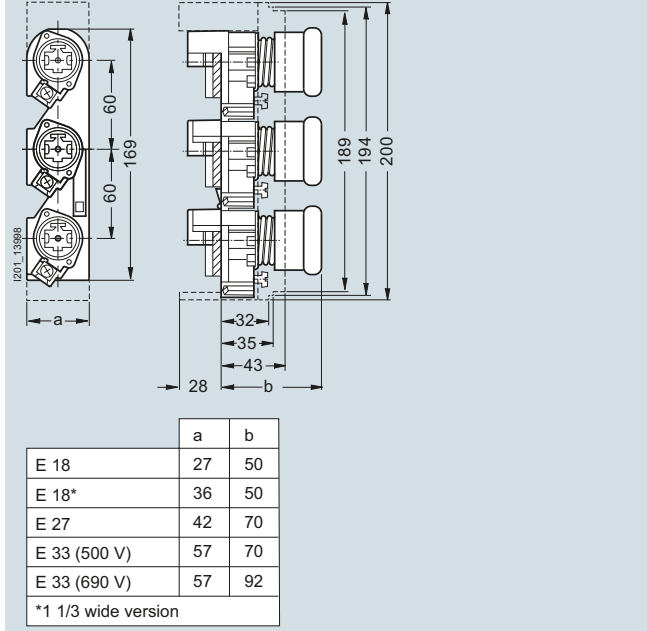

5SG6206

5SG6207

#### DIAZED SR60 bus-mounting bases

DII/25 A  
(a = 42 mm)

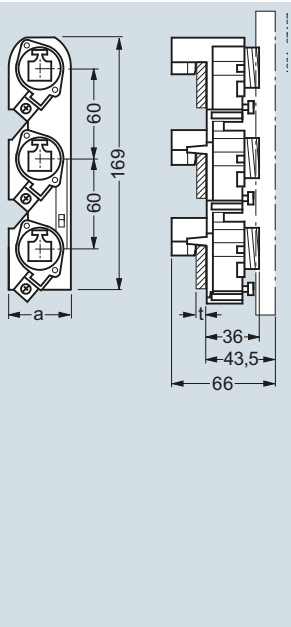

5SF6014, 5SF6015  
(t = 5 mm)

DIII/63 A  
(a = 57 mm)

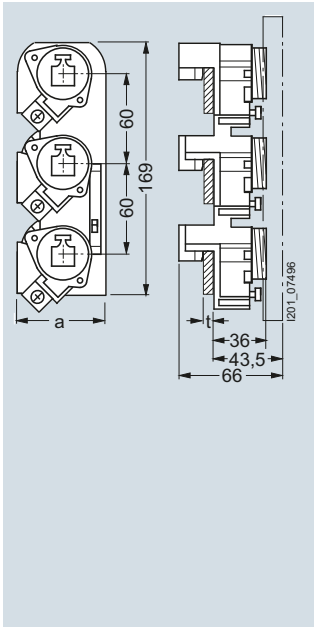

5SF6214, 5SF6215  
(t = 5 mm)

DII/25 A  
(a = 42 mm)

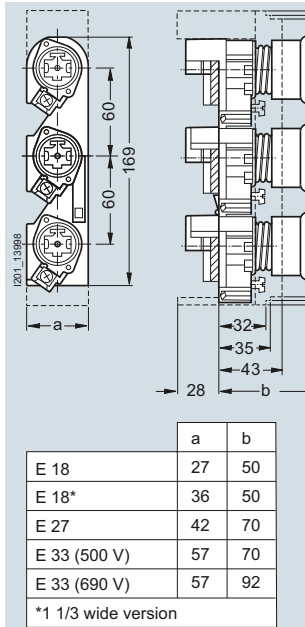

5SF6018, 5SF6020  
(b = 70 mm)

DIII/63 A  
(a = 57 mm)

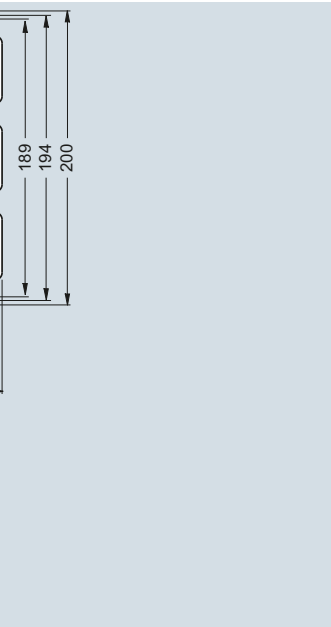

5SF6218, 5SF6220  
(b = 70 mm)

# Busbar Systems

## Built-in components

### NEOZED SR60 covers

D02/63 A

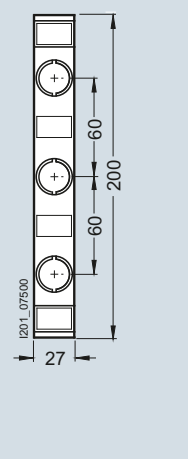

5SH5241  
1-fold

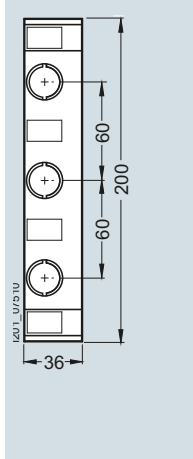

5SH5242  
1.33-fold

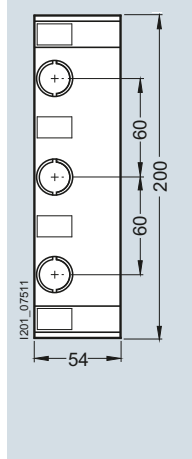

5SH5243  
2-fold

### DIAZED SR60 covers

DII/25 A

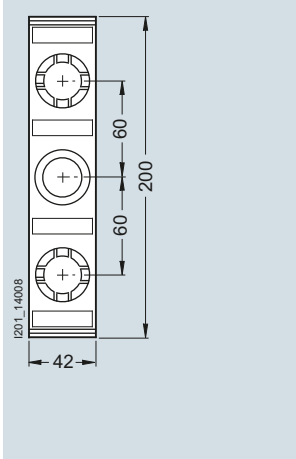

5SH2042 (1-fold: a = 42 mm)

DIII/63 A

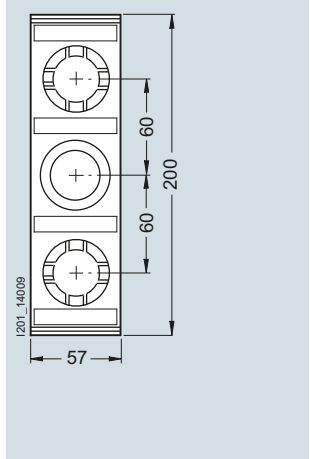

5SH2242 (1-fold: a = 57 mm)

### NEOZED SR60 bus-mounting switch disconnectors/ SR60 bus-mounting disconnectors

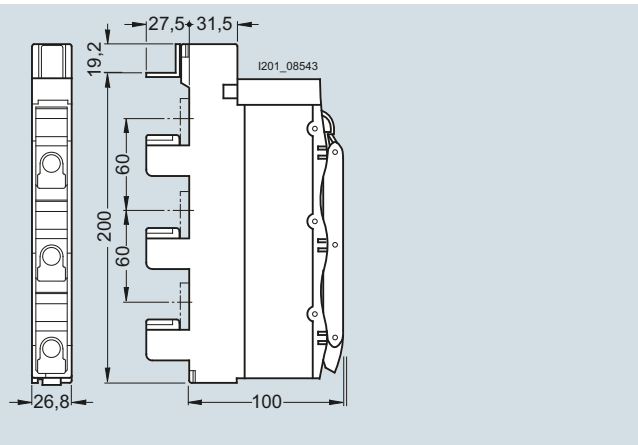

5SG7230  
3NW7430

### SR60 bus-mounting fuse holders for cylindrical fuses

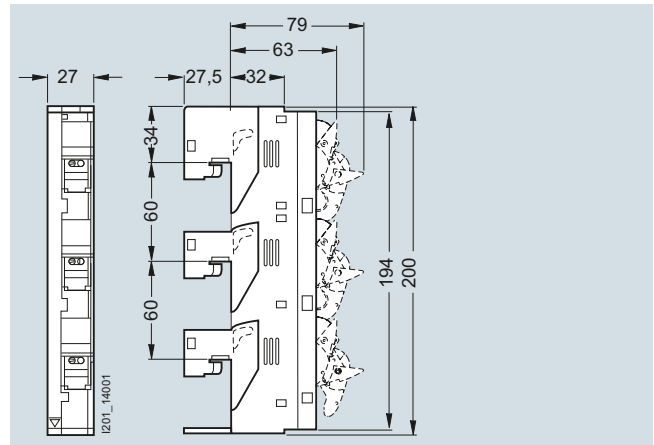

3NW7431,  
3NW7431-0HG,

10