









	29 V _~	
	6,4 mA	
	4 x (ø 0.6 mm < $\frac{8}{mm}$ < $\frac{10}{mm}$ < ø 0.8 mm)	
	- 10 °C / + 35 °C	
	 PIR	
	Max.	
	20 min.	
	Auto ON / OFF	
 m	 ø 8	 ø 40





• Hauteur • Height • Altezza	• Diamètre • Range Diameter • Diametro
15 m	40 m
10 m	26 m
6 m	16 m
3 m	8 m

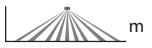

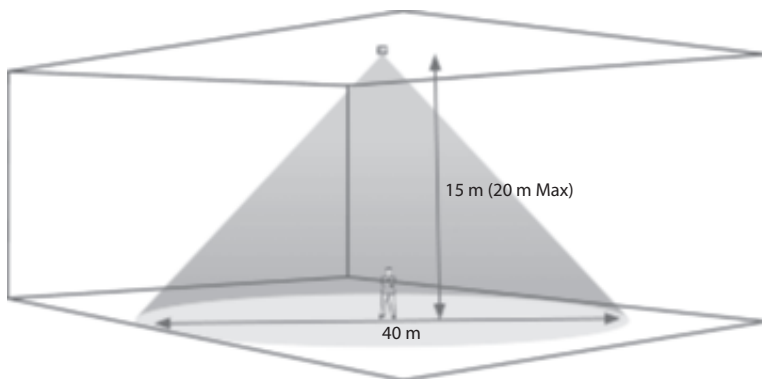
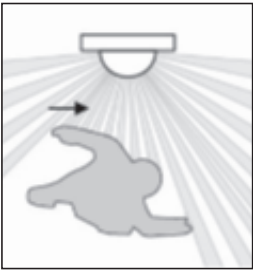
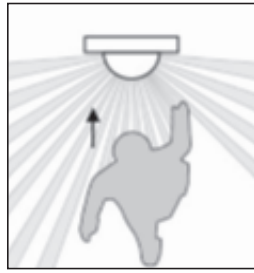
• Hauteur • Height • Altezza	• Diamètre • Range Diameter • Diametro
15 m	40 m
10 m	26 m
6 m	16 m
3 m	9 m

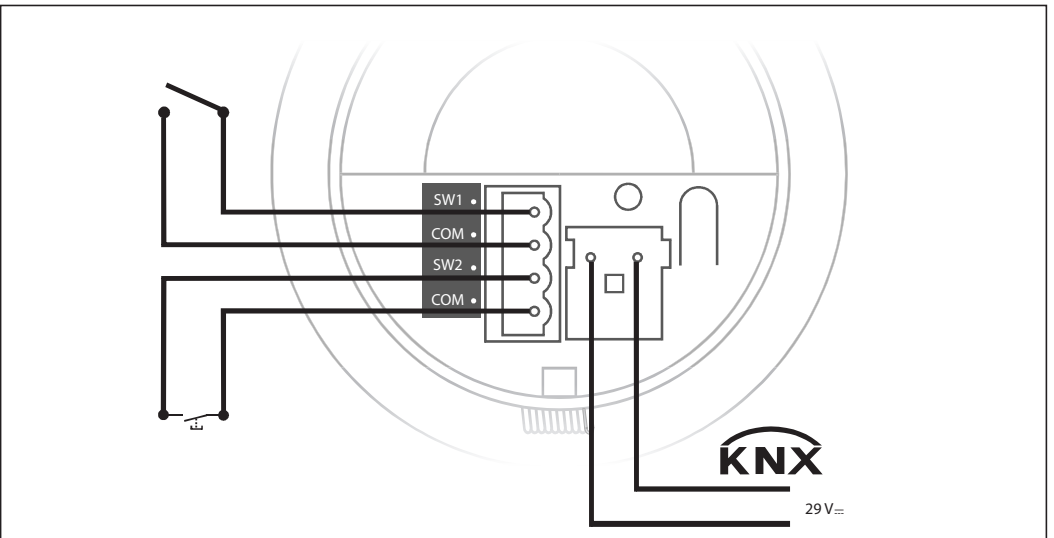
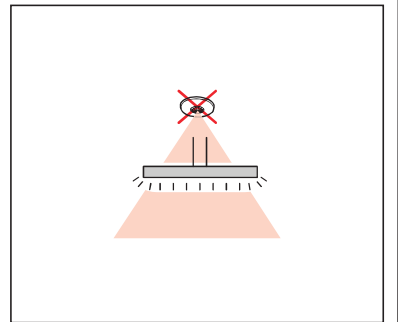
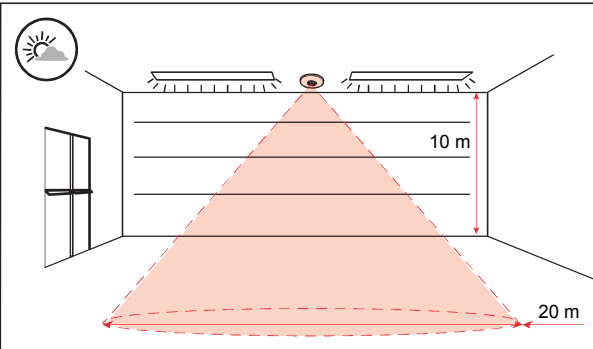
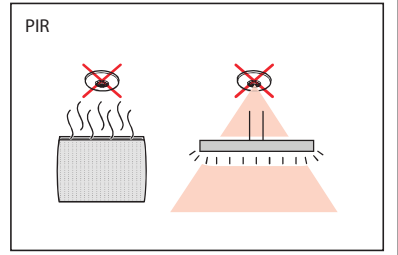
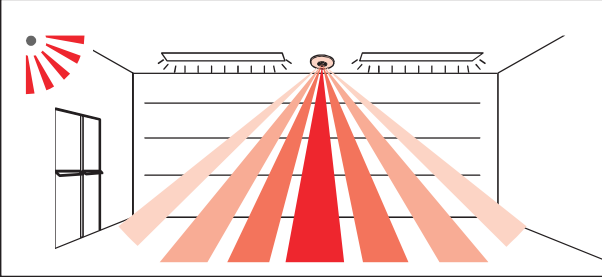

- Fixation encastrée
- Flush fixing
- Montaggio a filo

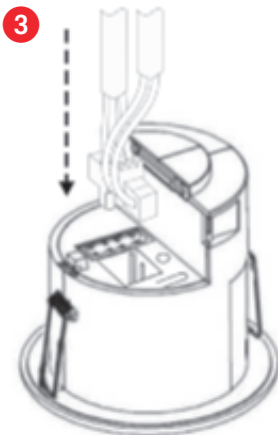
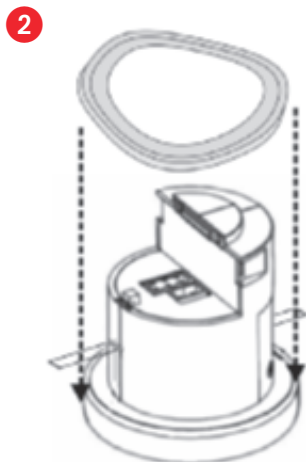
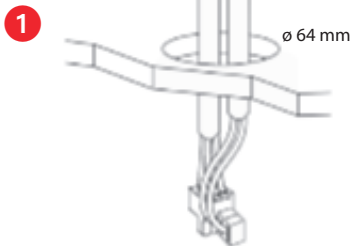

- Fixation en saillie
- Surface fixing
- Montaggio in superficie

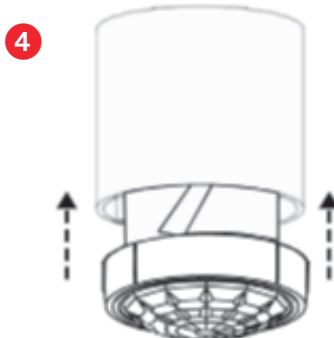
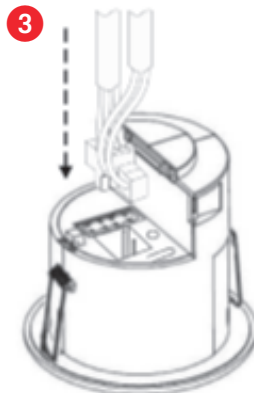
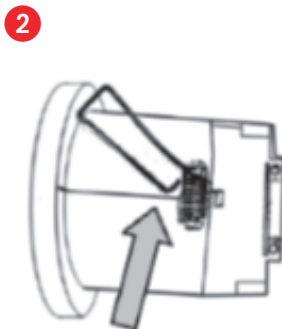
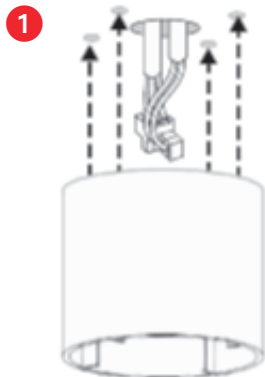



Auto ON / OFF



Manual ON / Auto OFF

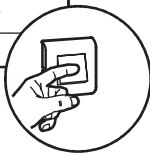

www.legrandoc.com

	0-2000 lux
	0-99 min.
	1-9
Mode	Auto - Manual

- Facette de montage
- Mounting bezel
- Lunetta di montaggio

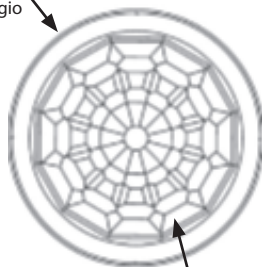

- Lentille PIR / récepteur IR / capteur de luminosité / LED d'état
- PIR lens / IR receiver / light level sensor / status LED
- Lente PIR / ricevitore IR / sensore luminosità / stato LED

