

# Connected Contactor

Cat. number : 4 121 71 / 4 121 91



Requires prior installation of a "with Netatmo" connected starter pack or a Gateway module.

CONTENTS	Pages
1. Description - Use .....	1
2. Range.....	1
3. Overall dimensions.....	1
4. Preparation - Connection .....	1
5. General characteristics .....	6
6. Compliance and approvals .....	7
7. Auxiliaries and accessories .....	7

## 1. DESCRIPTION - USE

### Use:

Enables to remotely control (ON / OFF) loads (like water heater swimming pool pump, heaters, charging plug for electric cars...) by smartphone with Home + Control app and / or by voice via a voice assistant. This connected version also offers functions such as:

- Energy consumption: automatically energy consumption information is available for the circuit to whom the connected contactor is wired to.
- Scheduling: automatic opening and reclosing action scenarios based on a timeline. (daily/weekly/specific event such as "holidays")

### Technology:

. Connected contactor with control by single contact, via smartphone, voice assistants and / or by its own push button on the front.

### Symbol :

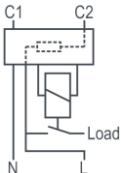

## 2. RANGE

### Noise level:

. Noiseless switch: <10dB.



### Width:

. 1 module. 17.8 mm wide.

### Types of contact:

. Normally open contact type

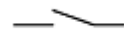

### Rated current:

. 20 A

### Rated voltage:

. 100 to 240V AC

### Rated frequency:

. 50 / 60 Hz

### Poles:

. 1 pole « NO »

## 2. RANGE (continued)

### Configuration and use:

. Can be used as a " standard " contactor not connected  
And /Or

Can be used with:

- Legrand smartphone app  
" HOME + CONTROL "



. Available for free on Google Play or App Store

- Voice assistants (compatible with the main assistants of the market).



voice

## 3. OVERALL DIMENSIONS

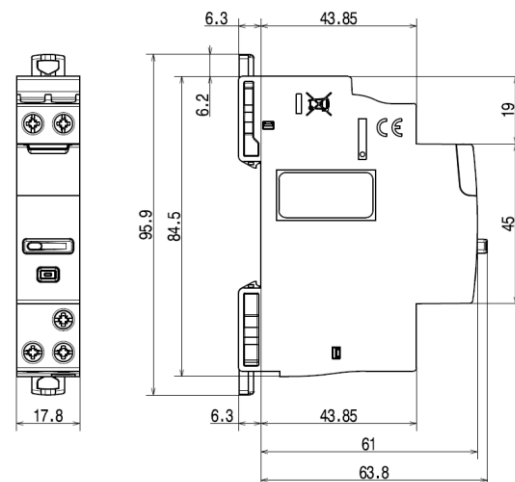

## 4. PREPARATION - CONNECTION

### Mounting:

. On symmetrical rail EN / IEC 60715 or DIN 35.

### Operating position:

. Vertical, Horizontal, Flat.



## 4. PREPARATION - CONNECTION *(continued)*

### Row positioning:

. The product shape and the positioning of the terminals allow the passage of single-line, three-lines and plug-in supply busbars in the upper part of the product. Then, it is possible to freely choose the position of the connected contactor in the row and to connect by supply busbar the other devices put on the same DIN rail.

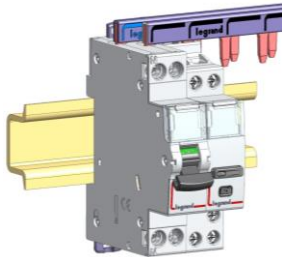

### Module maintenance:

. It is possible to switch a connected contactor in the middle of a row supplied with an upstream busbar without disconnecting the other devices on the same DIN rail.

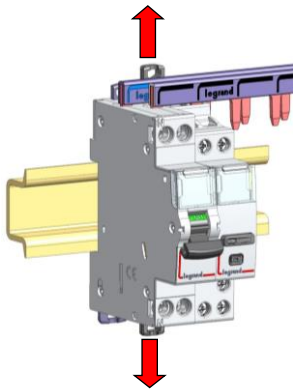

1. Unclip the clamp to put it in open position

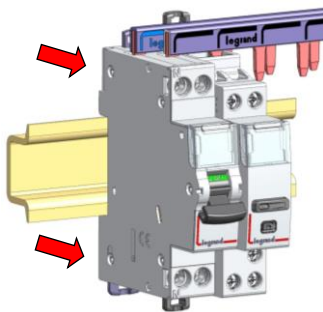

2. Unscrew the terminals and pull the device forward in order to release it from the DIN rail

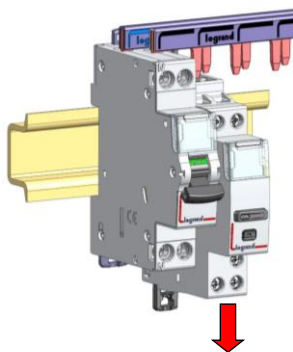

3. Pull the device downward in order to completely release it from the prongs of the busbar

## 4. PREPARATION - CONNECTION *(continued)*

### Wiring of the upstream terminals:

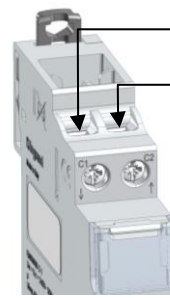

**C1** : IN terminal for control command (IN) ↓  
Free dry-contact. No power allowed.

**C2** : Out terminal self-protected  
Line for remote (OUT) ↑  
Free dry-contact. No power allowed.

**Advantage:** « auto protected terminals » technology. It is not necessary to put a 2A protection

In case of a remote control done via a wired push button, the control is done either via C1 and C2 terminals.

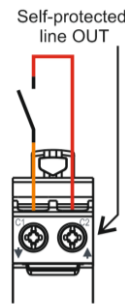

Or via a push button through the phase line protected by a circuit breaker on terminal C1

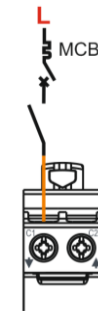

**Warning:** Do not wire from Neutral to C1 or C2

### Wiring of the power supply and the load (downstream terminals):

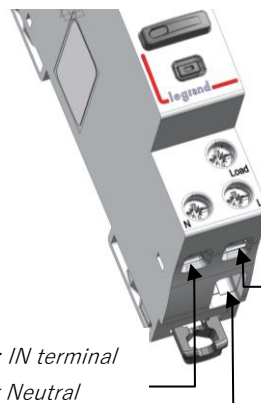

**L** : IN terminal for the Line

**N** : IN terminal for Neutral

**Load** : OUT terminal for the line after contact (towards Load)

## 4. PREPARATION - CONNECTION *(continued)*

### Electrical performance:

- . Maximum resistive loads: 4800W
- . Maximum motor loads: 2400VA

### Wireless network:

- . Maximum number of connected devices in the network: 100

### Wiring diagrams:

« Auto protected terminals » technology. It is not necessary to put a 2A protection.

- N (neutral) = bleu
- L (Line) = Everything but blue and green/yellow
- Line after contact = usually purple, orange...

- . Installation controlled by the energy supplier electric meter:

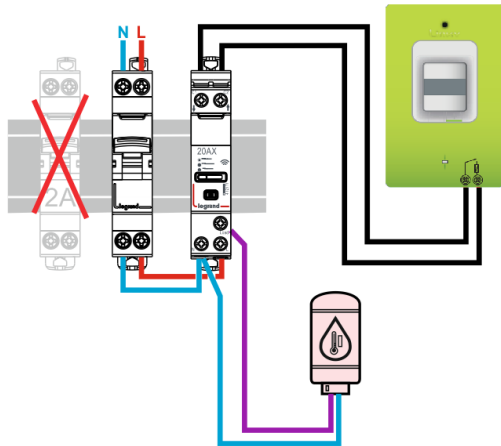

- . Installation for electrical motor:

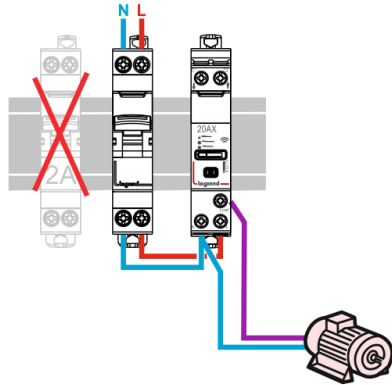

- . Installation for charging electric cars:

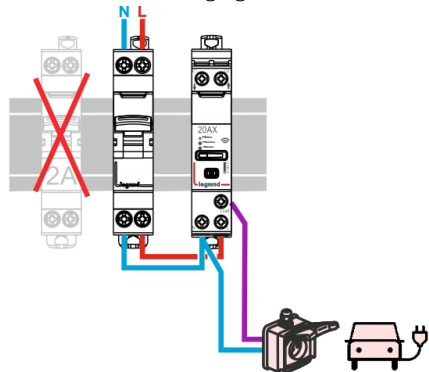

## 4. PREPARATION - CONNECTION *(continued)*

### Wiring diagrams *(continued)*:

- . Control of heaters through an already installed central remote:

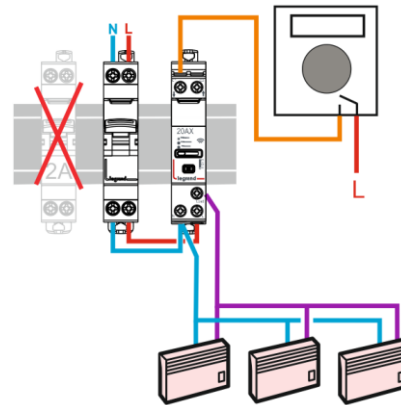

- . Cabling in a swimming pool control cabinet:

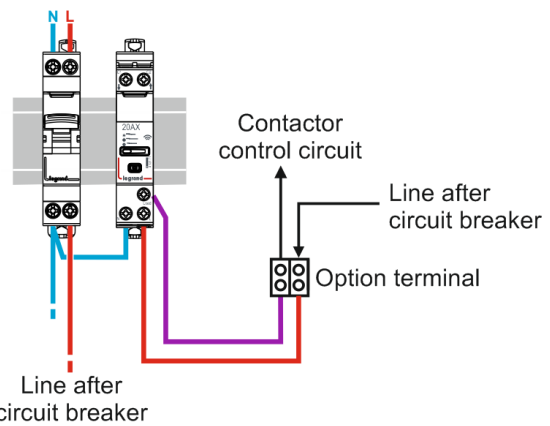

- . Control of a single line standard contactor (>20A):

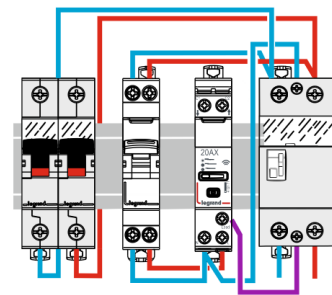

- . Control of a three lines standard contactor (>20A):

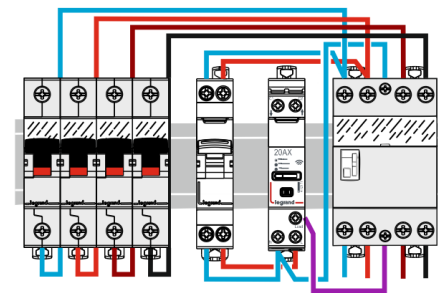

## 4. PREPARATION - CONNECTION *(continued)*

### Recommended tools:

- . For the terminals: screwdriver Pozidriv n° 1 or flat-blade 4 mm.
- . For clamping: screwdriver flat-blade (5,5mm or less) or Pozidriv n° 1

### Connection:

- . Control and power screw terminals:
  - Terminal type: cage
  - Depth: 9 mm
  - Stripping length recommended: 9 mm
  - Screw head: Posidriv n° 1 or slotted
  - Type of screw: M3,5
  - Minimum tightening torque: mini 0.8 Nm / maxi: 1.4 Nm advised: 1 Nm

### Conductor type for remote control terminals (C1, C2):

- . Copper cables

	Without ferrule	With ferrule
Rigid cable	1x (0.75 to 2.5mm <sup>2</sup> ) 2 x (0.75 to 1.5mm <sup>2</sup> )	-
Flexible cable	1x (0.75 to 2.5mm <sup>2</sup> ) 2 x (0.75 to 1.5mm <sup>2</sup> )	1 x (0.75 to 2.5mm <sup>2</sup> ) 2 x (0.75 to 1.5mm <sup>2</sup> )

### Conductor type for power terminals (N, L, LOAD):

- . Copper cables

	Without ferrule	With ferrule
Rigid cable	1x (0.75 to 6mm <sup>2</sup> ) 2 x (0.75 to 2.5mm <sup>2</sup> )	-
Flexible cable	1x (0.75 to 6mm <sup>2</sup> ) 2 x (0.75 to 2.5mm <sup>2</sup> )	1 x (0.75 to 2.5mm <sup>2</sup> ) 2 x (0.75 to 1.5mm <sup>2</sup> )

### Remote control commands:

- . Operation on-site, directly with the front face push-button of the device.

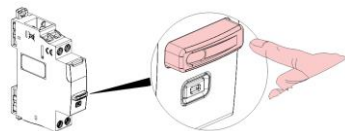

- . Via the Home / Away wireless master switch

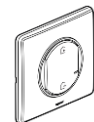

- . Via smartphone with the Home + Control smartphone app



- . By voice through a vocal assistant.



## 4. PREPARATION - CONNECTION *(continued)*

### Visualization of the operating mode of the device and contacts:

- . Via the LED, on the push button command

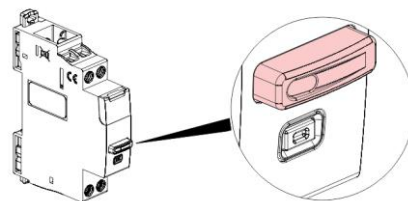

Color	Status	Meaning
	OFF	Manual mode and opened Contact (OFF)
	Slow blinking	Automatic mode and opened Contact (OFF)
	Slow blinking	Automatic mode and closed Contact (ON)
	Fixed	Manual mode and closed Contact (ON)

### Visualization of the setup:

- . Via the LED on the settings button

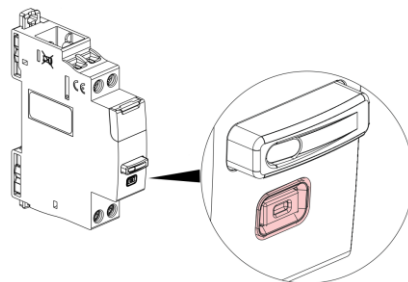

Color	Status	Meaning
	Fixed	Temporary status. Device not connected to the radio network
	Fixed	Temporary status. Device correctly paired to the radio network (when the radio network is still open)
	OFF	Normal status. Device paired to the radio network (when the radio network is closed)

## 4. PREPARATION - CONNECTION *(continued)*

### Add a connected contactor in a connected installation *(several steps) (continued):*

. 1/ Beforehand, to create a connected installation you must install:

Either a gateway module

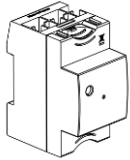

Or a connected starter pack (drawing of principle, works with anykind of "with Netatmo" connected starter pack).

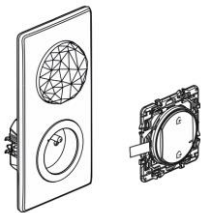

. 2/ Beforehand, the general circuit breaker must be turned OFF, and only after wiring step done, can be powered back ON to simultaneously power devices and allow them to be connected to the network.

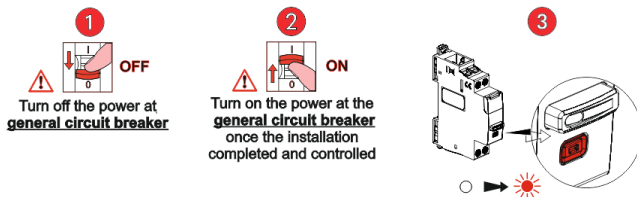

. 3/ Press and hold the gateway module settings button for more than 3 seconds, OR in the center of the Home / Away wireless master switch until the LED turns green, then release the button.

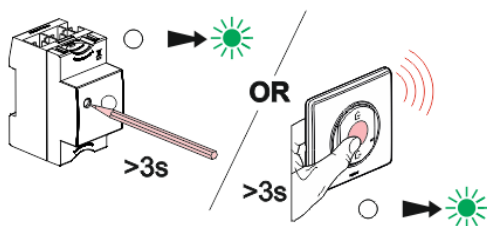

. The configuration LEDs of " ... with Netatmo " devices in the installation must all light up in fixed green.

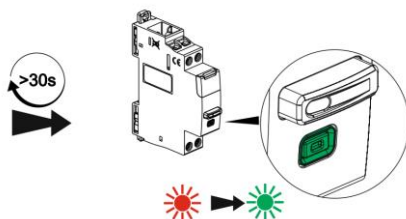

## 4. PREPARATION - CONNECTION *(continued)*

### Add a connected contactor in a connected installation *(several steps) (continued):*

. 4/ To complete the installation, briefly press the setting button on the gateway module (or in the center of the Home / Away wireless master switch) to finalize the installation.

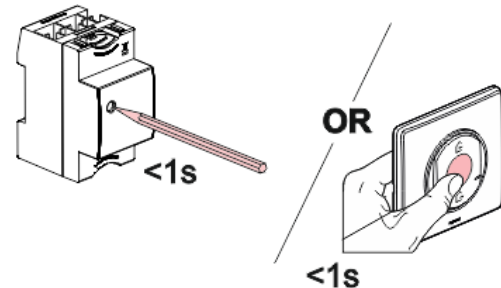

All " ... with Netatmo " devices LED go OFF

### Connected contactor resetting to remove it from a connected installation

. Press and hold over 5 seconds on the setting button until the LED on the setting button be fixed red. It is no longer paired with the gateway module or the Home / Away wireless master switch

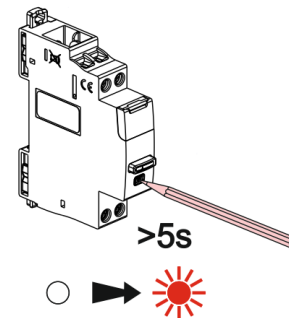

### Other configurations & actions

. All other features and settings such as ; scenarios etc... are directly explained step by step in the smartphone app.

### Labelling:

. Circuit identification by way of a label inserted in the label holder situated on the front of the product.

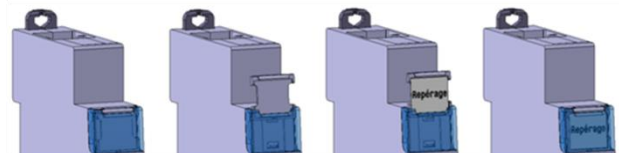

## 5. GENERAL CHARACTERISTICS

### Marking of the connected contactor:

Markings of the front side :

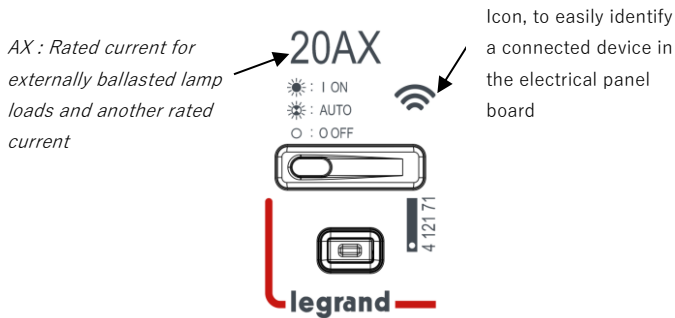

Terminal markings :

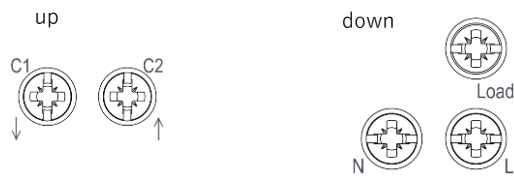

Markings on the upper side

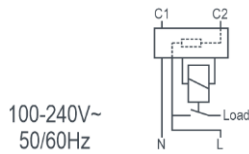

Lateral markings

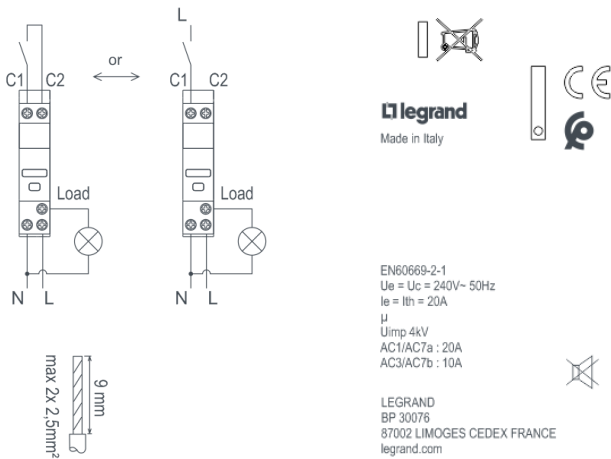

## 5. GENERAL CHARACTERISTICS (continued)

### Sectioning distance:

. micro-gap construction contact according to the standard EN 60669-2-1

### Rated insulation voltage (Ui):

. Ui = 250 V~

### Degree of pollution:

. 2

### Rated impulse withstand voltage (Uimp):

. 4 kV

### Influence of altitude :

. No influence up to 2 000 m

### Assigned frequency :

. 50 / 60 Hz

### Rated operational current (Ie) depending on utilization category:

. AC-7a or AC1 (heaters) : Ie = 20 A

. AC-7b or AC3 (electric motors) : Ie = 10 A

### Rated voltage of use (Ue):

. Ue = 100 to 240 V ~

### Resistance to short-circuits:

. Presumed short circuit current 1500 A according to EN 60669-2-1

. Thermal stress : 15 000 A<sup>2</sup>s to EN 60669-2-1

### Recommendations:

. For the device protection against short circuits according to the conditional current, it is recommended to use a circuit breaker or fuse gG rated current ≤ 20 A.

### Endurance:

. 20 000 000 operations without load

. 100 000 operations cycles AC-7a according to EN 61095

. 100 000 operations cycles AC-7b according to EN 61095.

. 10 000 operations under load SBL650W according to EN 60669-2-1

. 200 000 operations under " resistive " load according to EN 60669-2-5

### Characteristics of the radio interface:

. Standard IEEE 802.15.4

. Frequencies 2,4 à 2,4835Ghz

. Transmitter output power <100mW

. Distance max between 2 radio devices: 50m in open field

### Dielectric resistance :

. 2000V between front face and rail.

. 750V between upstream and downstream

### Protection degree:

. Protection index of terminals against direct contacts: IP2X (IEC/EN 60529)

. Protection index of the front face against direct contacts: IP3XD (IEC/EN 60529)

. Class II, front panel with faceplate.

. Class of protection against mechanical impacts IK04 (IEC/EN 62262)

## 5. GENERAL CHARACTERISTICS *(continued)*

### Vibrations and shaking resistance:

- . vibrations : 10 to 55 to 10Hz single amplitude 0.75mm
- . Shaking : 1000m / s<sup>2</sup> (6 ± 1ms)

### Plastic material:

- . Self-extinguishing polycarbonate.
- . Heat and fire resistant according to IEC/EN 60669-2-1, glow-wire test at 960° C
- . Classification UL 94 V0 (≥1.5mm)

### Ambient operating temperature:

- . Min. = - 5 ° C Max. = + 45 ° C.

### Ambient storage temperature:

- . Min. = - 40 ° C Max. = + 70 ° C.

### Average weight:

- . 78g

### Volume when packed:

- . 0,62 dm<sup>3</sup>.

### Environmental profile:

- . PEP document available

### Installation software:

- . XL PRO3

## 6. COMPLIANCE AND APPROVALS

### Compliance to standards:

- . NF EN 60669-2-1 / IEC 60669-2-1

### Environment respect – Compliance with European Union Directives:

- . Compliance with Directive 2002/95/EC of 27/01/03 known as "RoHS" which provides for a restriction on the use of dangerous substances such as lead, mercury, cadmium, hexavalent chromium and polybrominated biphenyl (PBB) and polybrominated diphenyl ether (PBDE) brominated flame retardants from 1<sup>st</sup> July 2006
- . Compliance with the Directive 91/338/EEC of 18/06/91 and decree 94-647 of 27/07/04
- . Compliant with regulation REACH

### Conformity with electromagnetic interference (EMC):

- . Compliant EN 301 489-1 , IEC 60669-2-5 , NF EN 60669-2-1
- Immunity to shock waves
- Radio transmission
- Immunity to electrical transients in bursts.
- Immunity to conducted disturbances induced by radio fields
- Immunity to radiated fields
- Electrostatic discharge immunity
- Immunity to voltage dips and short break
- . Compliance mission radiated according to NF EN55032.

### Plastic materials:

- . Halogen-free plastics.
- . Marking of parts according to ISO 11469 and ISO 1043.
- . ISO 7000: 2004, Graphical symbols to be used on equipment - Index and synopsis

### Packaging:

- . Design and manufacture of packaging in accordance with Decree 98-638 of 20/07/98 and Directive 94/62 / EC.

## 7. AUXILIARIES AND ACCESSORIES

Beforehand, requires the installation of a " connected starter pack " or " a "gateway module".